

ARISTA

User Manual

Arista Networks

www.arista.com

*Arista EOS version 4.26.1F
DOC-03495-16*

Headquarters	Support	Sales
5453 Great America Parkway Santa Clara, CA 95054 USA		
+1-408-547-5500	+1-408-547-5502 +1-866-476-0000	+1-408-547-5501 +1-866-497-0000
www.arista.com	support@arista.com	sales@arista.com

© Copyright 2021 Arista Networks, Inc. The information contained herein is subject to change without notice. Arista Networks and the Arista logo are trademarks of Arista Networks, Inc., in the United States and other countries. Other product or service names may be trademarks or service marks of others.

Contents

Chapter 1: Overview.....	1
1.1 Command-Line Interface (CLI).....	1
1.1.1 Accessing the EOS CLI.....	2
1.1.2 Processing Commands.....	2
1.1.3 Kernel-based Virtual Machine Commands and Configuration.....	10
1.1.4 Switch Platforms.....	14
1.1.5 Command Modes.....	23
1.1.6 Managing Switch Configuration Settings.....	25
1.1.7 Other Command-Line Interfaces.....	28
1.1.8 Directory Structure.....	28
1.1.9 Command-Line Interface Commands.....	30
Chapter 2: Booting the Switch.....	77
2.1 Boot Loader About.....	77
2.2 Configuration Files.....	77
2.2.1 boot-config.....	77
2.2.2 running-config.....	81
2.2.3 startup-config.....	82
2.3 Supervisor Redundancy.....	82
2.3.1 Redundancy Supervisor Protocols.....	82
2.3.2 Configuring Supervisor Redundancy.....	83
2.4 System Reset.....	84
2.4.1 Typical Reset Sequence.....	84
2.4.2 Switch Recovery.....	85
2.4.3 Display Reload Cause.....	85
2.4.4 Configuring Zero Touch Provisioning.....	86
2.4.5 Configuring the Networks.....	88
2.5 About Shell.....	88
2.5.1 About Shell Operation.....	89
2.5.2 Accessing the About Shell.....	89
2.5.3 About File Structure.....	91
2.5.4 Booting From the About Shell.....	91
2.5.5 About Commands.....	91
2.6 About Configuration Commands.....	93
2.6.1 CONSOLE SPEED.....	94
2.6.2 NET Commands.....	95
2.6.3 PASSWORD (ABOOT).....	96
2.6.4 SWI.....	97
2.7 Switch Booting Commands.....	98
2.7.1 boot console.....	99
2.7.2 boot secret.....	100
2.7.3 boot system.....	102
2.7.4 delete startup-config.....	103
2.7.5 protocol.....	104
2.7.6 redundancy.....	105
2.7.7 redundancy manual switchover.....	106
2.7.8 reload.....	107
2.7.9 reload (scheduled).....	109

2.7.10 show redundancy file-replication.....	111
2.7.11 show redundancy status.....	112
2.7.12 show redundancy switchover sso.....	112
2.7.13 show reload.....	114
2.7.14 show reload cause.....	115
2.7.15 show reload fast-boot.....	116

Chapter 3: Initial Configuration and Recovery..... 117

3.1 Initial Switch Access.....	117
3.1.1 Zero Touch Provisioning.....	117
3.1.2 Manual Provisioning.....	118
3.2 Connection Management.....	122
3.3 Configure Session.....	123
3.3.1 Configuration Session.....	124
3.3.2 Configure Replace.....	124
3.3.3 Configuration CLI.....	124
3.4 Recovery Procedures.....	125
3.4.1 Removing the Enable Password from the Startup Configuration.....	125
3.4.2 Reverting the Switch to the Factory Default Startup Configuration.....	126
3.4.3 Restoring the Factory Default EOS Image and Startup Configuration.....	127
3.4.4 Restoring the Configuration and Image from a USB Flash Drive.....	128
3.5 Session Management Commands.....	129
3.5.1 configure replace.....	130
3.5.2 configure session.....	131
3.5.3 domain (XMPP Management).....	132
3.5.4 idle-timeout (Console Management).....	133
3.5.5 idle-timeout (SSH Management).....	134
3.5.6 idle-timeout (Telnet Management).....	135
3.5.7 management api http-commands.....	136
3.5.8 management console.....	137
3.5.9 management ssh.....	138
3.5.10 management telnet.....	139
3.5.11 management xmpp.....	140
3.5.12 protocol http (API Management).....	141
3.5.13 protocol https (API Management).....	142
3.5.14 protocol https certificate (API Management).....	143
3.5.15 server (XMPP Management).....	144
3.5.16 session privilege (XMPP Management).....	145
3.5.17 show inventory.....	146
3.5.18 show xmpp neighbors.....	147
3.5.19 show xmpp status.....	148
3.5.20 show xmpp switch-group.....	149
3.5.21 shutdown (API Management).....	150
3.5.22 shutdown (Telnet Management).....	151
3.5.23 shutdown (XMPP Management).....	152
3.5.24 switch-group (XMPP Management).....	153
3.5.25 username (XMPP Management).....	155
3.5.26 vrf (API Management).....	156
3.5.27 vrf (XMPP Management).....	157
3.5.28 xmpp send.....	158
3.5.29 xmpp session.....	159

Chapter 4: Administering the Switch..... 161

4.1 Managing the Switch Name.....	161
-----------------------------------	-----

4.1.1	Assigning a Name to the Switch.....	161
4.1.2	Specifying DNS Addresses.....	162
4.2	System Clock and Time Protocols.....	163
4.2.1	Configuring the Time Zone.....	163
4.2.2	Setting the System Clock Manually.....	164
4.2.3	Displaying the Time.....	164
4.2.4	Network Time Protocol (NTP).....	164
4.3	Managing Display Attributes.....	167
4.3.1	Banners.....	167
4.3.2	Configuring prompt.....	168
4.4	Logging of Event Notifications.....	169
4.4.1	Managing TCAM Capacity Warnings.....	169
4.5	Event Monitor.....	169
4.5.1	Description.....	170
4.5.2	Configuring the Event Monitor.....	170
4.5.3	Querying the Event Monitor.....	172
4.5.4	Accessing Event Monitor Database Records.....	173
4.6	Managing EOS Extensions.....	173
4.6.1	Installing EOS Extensions.....	173
4.6.2	Installing EOS Extensions on a Dual-Supervisor Switch.....	174
4.6.3	Verifying EOS Extensions Installation.....	174
4.6.4	Uninstalling an EOS Extension.....	175
4.7	7130 Layer 1 Configuration.....	175
4.8	Switch Administration Commands.....	177
4.8.1	banner login.....	179
4.8.2	banner motd.....	180
4.8.3	clear ptp interface counters.....	181
4.8.4	clock set.....	182
4.8.5	clock timezone.....	183
4.8.6	dns domain.....	184
4.8.7	email.....	185
4.8.8	event-monitor backup max-size.....	186
4.8.9	event-monitor backup path.....	187
4.8.10	event-monitor buffer max-size.....	188
4.8.11	event-monitor clear.....	189
4.8.12	event-monitor interact.....	190
4.8.13	event-monitor sync.....	191
4.8.14	event-monitor.....	192
4.8.15	hostname.....	194
4.8.16	ip domain lookup.....	195
4.8.17	ip domain-list.....	196
4.8.18	ip host.....	197
4.8.19	ip name-server.....	198
4.8.20	ipv6 host.....	199
4.8.21	l1 source.....	200
4.8.22	logging format sequence-numbers.....	201
4.8.23	logging repeat-messages.....	202
4.8.24	no event-monitor.....	203
4.8.25	ntp authenticate.....	204
4.8.26	ntp authentication-key.....	205
4.8.27	ntp local-interface.....	206
4.8.28	ntp serve all.....	207
4.8.29	ntp serve.....	208
4.8.30	ntp server.....	209
4.8.31	ntp trusted-key.....	211
4.8.32	prompt.....	212

4.8.33 show banner.....	214
4.8.34 show clock.....	215
4.8.35 show event-monitor arp.....	216
4.8.36 show event-monitor igmpsnooping.....	218
4.8.37 show event-monitor mac.....	219
4.8.38 show event-monitor mroute.....	221
4.8.39 show event-monitor neighbor.....	223
4.8.40 show event-monitor route6.....	225
4.8.41 show event-monitor route.....	227
4.8.42 show event-monitor sqlite.....	229
4.8.43 show event-monitor stpunstable.....	230
4.8.44 show hostname.....	231
4.8.45 show hosts.....	232
4.8.46 show ip domain-name.....	233
4.8.47 show ip name-server.....	234
4.8.48 show l1 destination.....	235
4.8.49 show l1 matrix.....	236
4.8.50 show l1 path.....	239
4.8.51 show l1 source.....	240
4.8.52 show l1 source capabilities.....	241
4.8.53 show local-clock time-properties.....	242
4.8.54 show ntp associations.....	243
4.8.55 show ntp status.....	244

Chapter 5: Timing Protocols..... 245

5.1 Setting the PTP Mode.....	245
5.2 Enabling PTP on an Interface.....	246
5.3 Configuring the PTP Domain.....	246
5.4 Configuring the Offset Hold Time.....	246
5.5 Setting the PTP Priority.....	247
5.6 Configuring the Source IP.....	247
5.7 Configuring the TTL for PTP Packets.....	247
5.8 Configuring PTP Monitoring.....	247
5.9 Setting the PTP Announce Interval.....	248
5.10 Setting the PTP Timeout Interval.....	249
5.11 Configuring the PTP Delay Mechanism.....	249
5.12 Setting the Delay Request Interval.....	249
5.13 Setting the Peer Delay Request Interval.....	249
5.14 Setting the Peer Link Propagation Threshold.....	250
5.15 Setting the Interval for Sending Synchronization Messages.....	250
5.16 Setting the PTP Transport Type.....	250
5.17 Viewing PTP Settings and Status.....	250
5.17.1 Displaying General PTP Information.....	250
5.17.2 Displaying PTP Clock Properties.....	251
5.17.3 Displaying PTP Foreign Master.....	251
5.17.4 Displaying PTP Information for all Interfaces.....	251
5.17.5 Displaying PTP Interface Counters.....	252
5.17.6 Displaying PTP Local Clock and Offset.....	252
5.17.7 Displaying PTP Masters Information.....	253
5.17.8 Displaying PTP Monitoring Information.....	253
5.17.9 Displaying PTP Source IP.....	253
5.18 Precision Time Protocol (PTP) Commands.....	255
5.18.1 ptp announce interval.....	256
5.18.2 ptp announce timeout.....	257
5.18.3 ptp delay-mechanism.....	258

5.18.4	ptp delay-req interval.....	259
5.18.5	ptp domain.....	260
5.18.6	ptp enable.....	261
5.18.7	ptp forward-v1.....	262
5.18.8	ptp hold-ptp-time.....	263
5.18.9	ptp mode.....	264
5.18.10	ptp monitor threshold mean-path-delay.....	265
5.18.11	ptp monitor threshold offset-from-master.....	266
5.18.12	ptp monitor threshold skew.....	267
5.18.13	ptp monitor.....	268
5.18.14	ptp pdelay-neighbor-threshold.....	269
5.18.15	ptp pdelay-req interval.....	270
5.18.16	ptp priority1.....	271
5.18.17	ptp priority2.....	272
5.18.18	ptp role.....	273
5.18.19	ptp source ip.....	274
5.18.20	ptp sync timeout.....	275
5.18.21	ptp sync-message interval.....	276
5.18.22	ptp transport.....	277
5.18.23	ptp ttl.....	278
5.18.24	show ptp foreign-master-record.....	279
5.18.25	show ptp interface counters.....	280
5.18.26	show ptp interface.....	281
5.18.27	show ptp local-clock.....	282
5.18.28	show ptp masters.....	283
5.18.29	show ptp monitor.....	284
5.18.30	show ptp source ip.....	285
5.18.31	show ptp.....	286
Chapter 6: Switch Environment Control.....		287
6.1	Environment Control Introduction.....	287
6.2	Environment Control Overview.....	287
6.2.1	Temperature.....	287
6.2.2	Fans.....	287
6.2.3	Power.....	288
6.3	Configuring and Viewing Environment Settings.....	288
6.3.1	Overriding Automatic Shutdown.....	288
6.3.2	Viewing Environment Status.....	290
6.3.3	Locating Components on the Switch.....	291
6.4	Environment Commands.....	293
6.4.1	environment fan-speed.....	294
6.4.2	environment insufficient-fans action.....	296
6.4.3	environment overheat action.....	298
6.4.4	locator-led.....	300
6.4.5	show environment power.....	301
6.4.6	show environment temperature.....	302
6.4.7	show locator-led.....	304
6.4.8	show system environment all.....	305
6.4.9	show system environment cooling.....	306
6.4.10	show system environment power budget.....	308
Chapter 7: Upgrades and Downgrades.....		309
7.1	Upgrade/Downgrade Overview.....	309
7.2	Accelerated Software Upgrade (ASU).....	309

7.2.1 Upgrading the EOS image with Accelerated Software Upgrade.....	310
7.3 Leaf Smart System Upgrade (Leaf SSU).....	313
7.3.1 Upgrading the EOS image with Smart System Upgrade.....	314
7.4 Standard Upgrades and Downgrades.....	320
7.4.1 Upgrading or Downgrading the EOS on a Single-Supervisor Switch.....	320
7.4.2 Upgrading or Downgrading the EOS on a Dual-Supervisor Switch.....	323
7.5 Upgrade/Downgrade Commands.....	327
7.5.1 install.....	328
7.5.2 reload fast-boot.....	329
7.5.3 reload hitless.....	330
Chapter 8: Security.....	331
8.1 User Security.....	331
8.1.1 AAA Configuration.....	331
8.2 Control Plane Security.....	420
8.2.1 Transport Layer Security.....	420
8.2.2 802.1X Port Security.....	455
8.3 Data Plane Security.....	491
8.3.1 IP NAT.....	491
8.3.2 Media Access Control Security.....	524
8.3.3 Internet Protocol Security (IPsec).....	564
8.3.4 Macro-Segmentation Service (CVX).....	581
Chapter 9: Quality of Service and Traffic Management.....	617
9.1 Quality of Service.....	617
9.1.1 Quality of Service Conceptual Overview.....	617
9.1.2 QoS Configuration: Platform-Independent Features.....	625
9.1.3 QoS Configuration: Arad Platform Switches.....	627
9.1.4 QoS Configuration: Jericho Platform Switches.....	636
9.1.5 QoS Configuration: FM6000 Platform Switches.....	645
9.1.6 QoS Configuration: Petra Platform Switches.....	652
9.1.7 QoS Configuration: Trident and Tomahawk Platform Switches.....	660
9.1.8 QoS Configuration: Trident II and Helix Platform Switches.....	669
9.1.9 Support for Configuring Color Extended Communities.....	677
9.1.10 ACL based QoS Configuration.....	679
9.1.11 Quality of Service Configuration Commands.....	682
9.2 Traffic Management.....	780
9.2.1 Traffic Management Conceptual Overview.....	781
9.2.2 Traffic Management Configuration Arad Platform Switches.....	795
9.2.3 Traffic Management Configuration FM6000 Platform Switches.....	805
9.2.4 Traffic Management Configuration Petra Platform Switches.....	814
9.2.5 Traffic Management Configuration Trident Platform Switches.....	817
9.2.6 Traffic Management Configuration Trident II Platform Switches.....	827
9.2.7 Traffic Management Configuration Commands.....	831
Chapter 10: Interface Configuration.....	917
10.1 Ethernet Ports.....	917
10.1.1 Ethernet Ports Introduction.....	917
10.1.2 Ethernet Standards.....	917
10.1.3 Ethernet Physical Layer.....	919
10.1.4 Interfaces.....	930
10.1.5 Ethernet Configuration Procedures.....	933
10.1.6 Ethernet Configuration Commands.....	972

10.2 Port Channels and LACP.....	1049
10.2.1 Port Channel Introduction.....	1049
10.2.2 Port Channel Conceptual Overview.....	1049
10.2.3 Port Channel Configuration Procedures.....	1051
10.2.4 Load Balancing Hash Algorithms.....	1057
10.2.5 Port Channel and LACP Configuration Commands.....	1064
10.3 Multi-Chassis Link Aggregation.....	1122
10.3.1 MLAG Introduction.....	1122
10.3.2 MLAG Conceptual Overview.....	1123
10.3.3 MLAG Maintenance.....	1124
10.3.4 MLAG Dual Primary Detection and Release.....	1127
10.3.5 Configuring MLAG.....	1131
10.3.6 EVPN - MLAG Single-homed Hosts.....	1138
10.3.7 MLAG Implementation Example.....	1139
10.3.8 MLAG Commands.....	1146
10.4 Data Transfer.....	1166
10.4.1 Data Transfer Introduction.....	1166
10.4.2 Data Transfer Methods.....	1166
10.4.3 MAC Address Table.....	1170
10.4.4 Configuring Ports.....	1174
10.4.5 Monitoring Links.....	1188
10.4.6 PHY test pattern CLI.....	1201
10.4.7 Data Transfer Commands.....	1207

Chapter 11: Layer 2 Configuration..... 1301

11.1 Spanning Tree Protocol.....	1301
11.1.1 Introduction to Spanning Tree Protocols.....	1301
11.1.2 Spanning Tree Overview.....	1301
11.1.3 Configuring a Spanning Tree.....	1307
11.1.4 STP Commands.....	1323
11.2 Link Layer Discovery Protocol.....	1394
11.2.1 LLDP Introduction.....	1394
11.2.2 LLDP Overview.....	1394
11.2.3 LLDP Configuration Procedures.....	1395
11.2.4 LLDP Configuration Commands.....	1401
11.3 Virtual LANs (VLANs).....	1421
11.3.1 VLAN Introduction.....	1421
11.3.2 VLAN Conceptual Overview.....	1421
11.3.3 VLAN Configuration Procedures.....	1423
11.3.4 VLAN Configuration Commands.....	1433
11.4 DCBX and Flow Control.....	1470
11.4.1 Introduction.....	1470
11.4.2 Overview.....	1470
11.4.3 DCBX Configuration and Verification.....	1471
11.4.4 Configuring Priority-Flow-Control (PFC).....	1472
11.4.5 Configuring PFC Watchdog.....	1473
11.4.6 DCBX and Flow Control Commands.....	1477
11.5 IP Locking.....	1497
11.5.1 IP Locking.....	1498
11.6 Layer 2 Subinterfaces.....	1511
11.6.1 Platform Compatibility.....	1511
11.6.2 Configurations.....	1511
11.6.3 Show Commands.....	1515
11.6.4 Limitations.....	1516

Chapter 12: Layer 3 Configuration.....	1519
12.1 IPv4.....	1519
12.1.1 IPv4 Addressing.....	1519
12.1.2 IPv4 Routing.....	1529
12.1.3 IPv4 Multicast Counters.....	1533
12.1.4 Route Management.....	1536
12.1.5 IPv4 Route Scale.....	1543
12.1.6 IP Source Guard.....	1548
12.1.7 DHCP Server.....	1550
12.1.8 DHCP Relay Global Configuration Mode.....	1561
12.1.9 DHCP Relay Across VRF.....	1564
12.1.10 DHCP Relay in VXLAN EVPN.....	1566
12.1.11 DHCP Snooping with Bridging.....	1568
12.1.12 TCP MSS Clamping.....	1570
12.1.13 IPv4 GRE Tunneling.....	1572
12.1.14 IPv4 Commands.....	1577
12.2 IPv6.....	1685
12.2.1 Introduction.....	1685
12.2.2 IPv6 Description.....	1686
12.2.3 Configuring IPv6.....	1688
12.2.4 IPv6 Commands.....	1699
12.3 Ingress and Egress Per-Port for IPv4 and IPv6 Counters.....	1752
12.3.1 Platform Compatability.....	1752
12.3.2 Configuration.....	1752
12.3.3 Show Commands.....	1753
12.3.4 Dedicated ARP Entry for TX IPv4 and IPv6 Counters.....	1753
12.3.5 Limitations.....	1754
12.4 ACLs and Route Maps.....	1754
12.4.1 ACL, Service ACL, Route Map, Prefix List, and RAACL Divergence Introduction.....	1754
12.4.2 Access Control Lists.....	1755
12.4.3 Service ACLs.....	1774
12.4.4 RAACL Sharing on SVIs.....	1779
12.4.5 Route Maps.....	1782
12.4.6 Prefix Lists.....	1786
12.4.7 Port ACLs with User-Defined Fields.....	1790
12.4.8 ACL, Route Map, and Prefix List Commands.....	1794
12.5 VARP.....	1872
12.5.1 VRRP and VARP Conceptual Overview.....	1873
12.5.2 VRRP and VARP Implementation Procedures.....	1873
12.5.3 VRRP and VARP Implementation Examples.....	1880
12.5.4 VRRP and VARP Configuration Commands.....	1885
12.6 OpenFlow.....	1911
12.6.1 OpenFlow Introduction.....	1912
12.6.2 OpenFlow Description.....	1912
12.6.3 OpenFlow Configuration.....	1917
12.6.4 OpenFlow Commands.....	1921
12.7 DirectFlow.....	1942
12.7.1 Introduction.....	1942
12.7.2 DirectFlow Configuration.....	1944
12.7.3 DirectFlow Feature Interactions.....	1946
12.7.4 DirectFlow Commands.....	1950
12.8 Decap Groups.....	1967
12.8.1 Decap Groups Description.....	1967

12.9	Nexthop Groups.....	1975
12.9.1	Nexthop Group Description.....	1975
12.9.2	Nexthop Group Configuration.....	1976
12.9.3	Nexthop Group Commands.....	1981
12.10	Global Knob to Set MTU for all Layer 3 Interfaces.....	1991
12.10.1	Platform Compatibility.....	1991
12.10.2	Global Knob to Set MTU for all Layer 3 Interfaces Configuration.....	1991
12.10.3	Show Commands.....	1991
12.10.4	Troubleshooting.....	1992
12.10.5	Limitations.....	1992
12.11	Support for L3 MTU on 7280R3/7500R3/7800R3.....	1992
12.11.1	Layer 3 MTU Platform Compatibility.....	1992
12.11.2	Layer 3 MTU Configuration.....	1993
12.11.3	Layer 3 MTU Show Commands.....	1993
12.11.4	L3 MTU Syslog Messages.....	1993
12.11.5	L3 MTU Troubleshooting.....	1993
12.11.6	L3 MTU Limitations.....	1994
Chapter 13: IP Services.....		1995
13.1	CloudVision eXchange (CVX).....	1995
13.1.1	Upgrading CVX.....	1995
13.1.2	CVX Overview.....	1996
13.1.3	CVX Services.....	1997
13.1.4	Deploying CVX.....	1998
13.1.5	CVX Configuration.....	2005
13.1.6	CVX Secure out-of-band Connection.....	2011
13.1.7	CVX High Availability.....	2014
13.1.8	CVX VIP.....	2021
13.1.9	CVX Command Descriptions.....	2023
Chapter 14: Routing Protocols.....		2051
14.1	Routing Information Protocol (RIP).....	2051
14.1.1	RIP Conceptual Overview.....	2051
14.1.2	Running RIP on the Switch.....	2052
14.1.3	Configuring RIP on Multiple VRFs.....	2055
14.1.4	RIP Commands.....	2056
14.2	Open Shortest Path First – Version 2.....	2069
14.2.1	OSPFv2 Introduction.....	2069
14.3	Open Shortest Path First – Version 3.....	2196
14.3.1	OSPFv3 Introduction.....	2196
14.3.2	OSPFv3 Conceptual Overview.....	2197
14.3.3	Configuring OSPFv3.....	2200
14.3.4	OSPFv3 Configuration Examples.....	2213
14.3.5	OSPFv3 Commands.....	2221
14.4	IS-IS.....	2286
14.4.1	IS-IS Introduction.....	2287
14.4.2	IS-IS Segment Routing.....	2287
14.4.3	IS-IS Graceful Restart.....	2289
14.4.4	IS-IS Dynamic Flooding.....	2290
14.4.5	IS-IS Configuration.....	2291
14.4.6	IS-IS Commands.....	2322
14.5	Border Gateway Protocol (BGP).....	2396
14.5.1	BGP Conceptual Overview.....	2397
14.5.2	Configuring BGP.....	2412

14.5.3 BGP Examples.....	2460
14.5.4 BGP Commands.....	2464
14.6 Maintenance Mode.....	2620
14.6.1 Overview.....	2620
14.6.2 Maintenance Mode Elements.....	2621
14.6.3 Maintenance Mode Features.....	2625
14.6.4 Maintenance Mode Configuration.....	2625
14.6.5 Show Commands.....	2633
14.6.6 Syslog Messages.....	2640
14.6.7 Maintenance Mode Commands.....	2641
14.7 Bidirectional Forwarding Detection.....	2689
14.7.1 Introduction.....	2689
14.7.2 BFD Configuration.....	2691
14.7.3 Hardware Accelerated BFD Transmit.....	2696
14.7.4 BFD Commands.....	2702

Chapter 15: Multicast..... 2725

15.1 Multicast Architecture.....	2725
15.1.1 Overview.....	2725
15.1.2 Multicast Architecture Description.....	2726
15.1.3 Multicast Listener Discovery (MLD).....	2727
15.1.4 Multicast Route Counters.....	2733
15.1.5 Multicast (S,G) Counters.....	2736
15.1.6 Static IP Mroute.....	2739
15.1.7 Static Multicast.....	2742
15.1.8 Configuring Multicast.....	2743
15.1.9 Multicast Commands.....	2753
15.2 IGMP and IGMP Snooping.....	2801
15.2.1 IGMP Snooping.....	2801
15.2.2 IGMP Host Proxy Description.....	2802
15.2.3 Supported Features.....	2803
15.2.4 IGMP Protocols.....	2803
15.2.5 Configuring IGMP.....	2804
15.2.6 Configuring IGMP Snooping.....	2806
15.2.7 IGMP Host Proxy.....	2816
15.2.8 IGMP and IGMP Snooping Commands.....	2820
15.3 Protocol Independent Multicast.....	2905
15.3.1 Introduction.....	2906
15.3.2 Overview.....	2906
15.3.3 Configuring PIM.....	2908
15.3.4 Multicast Example.....	2915
15.3.5 PIM Commands.....	2919
15.4 Multicast Source Discovery Protocol (MSDP).....	2966
15.4.1 MSDP Introduction.....	2967
15.4.2 MSDP Description.....	2967
15.4.3 MSDP Configuration.....	2969
15.4.4 MSDP Commands.....	2978
15.5 Audio Video Bridging (AVB).....	3001
15.5.1 AVB Overview.....	3001
15.5.2 AVB Protocols.....	3002
15.5.3 AVB Configuration.....	3003
15.5.4 AVB Command Descriptions.....	3008

Chapter 16: Virtual Extensible LANs (VXLANs)..... 3019

16.1 VXLAN Introduction.....	3019
16.2 VXLAN Description.....	3019
16.2.1 VXLAN Architecture.....	3019
16.2.2 VXLAN Gateway.....	3020
16.2.3 VXLAN Processes.....	3021
16.2.4 Multicast and Broadcast over VXLAN.....	3021
16.2.5 VXLAN and MLAG.....	3022
16.2.6 VXLAN Bridging and Routing Support.....	3025
16.2.7 Data Structures.....	3025
16.3 VXLAN Configuration.....	3026
16.3.1 Configuring the VTI.....	3026
16.3.2 Head End Replication Configuration.....	3028
16.3.3 VXLAN Routing Configuration.....	3029
16.3.4 Configuring VXLAN Routing with Overlay VRFs.....	3034
16.3.5 Configuring VXLAN over MLAG.....	3034
16.3.6 Configuring VXLAN Control Service.....	3035
16.3.7 Configuring VXLAN Multicast Decapsulation.....	3036
16.3.8 VXLAN Rules Support for Mirror ACLs Configuration.....	3036
16.3.9 Configuring EVPN VXLAN.....	3037
16.3.10 Displaying VXLAN Configuration.....	3040
16.3.11 Displaying VXLAN Bridging and Routing Support.....	3042
16.4 VXLAN Command Descriptions.....	3045
16.4.1 clear vxlan counters.....	3046
16.4.2 designated-forwarder election hold-time.....	3047
16.4.3 interface vxlan.....	3048
16.4.4 ip address virtual.....	3049
16.4.5 ip multicast source route export.....	3050
16.4.6 redistribute attached-host.....	3051
16.4.7 show arp.....	3052
16.4.8 show interfaces vxlan.....	3054
16.4.9 show service vxlan.....	3055
16.4.10 show vxlan address-table.....	3056
16.4.11 show vxlan counters.....	3057
16.4.12 show vxlan flood vtep.....	3059
16.4.13 show vxlan vtep.....	3060
16.4.14 vxlan flood vtep.....	3061
16.4.15 vxlan multicast-group decap.....	3063
16.4.16 vxlan source-interface.....	3064
16.4.17 vxlan udp-port.....	3065
16.4.18 vxlan vlan vni.....	3066
16.4.19 vxlan vni notation dotted.....	3067
Chapter 17: Ethernet VPN (EVPN).....	3069
17.1 EVPN Overview.....	3069
17.1.1 EVPN Terminology.....	3070
17.1.2 EVPN Service Models.....	3073
17.1.3 VCS and EVPN in DCI.....	3075
17.1.4 EVPN MPLS LAYER 3 VPN (Type-5 Route).....	3076
17.1.5 EVPN VxLAN IPV6 Overlay.....	3077
17.2 EVPN Layer 3 Core Operations.....	3078
17.2.1 MAC Address Learning.....	3078
17.2.2 ARP Suppression.....	3079
17.2.3 MAC Mobility.....	3079
17.2.4 MAC Address Damping.....	3080
17.2.5 Broadcast and Multicast Traffic.....	3080

17.3 Integrated Routing and Bridging.....	3081
17.3.1 IP VPN.....	3086
17.4 VPN MPLS Transport Options.....	3088
17.4.1 LDP.....	3091
17.4.2 ISIS-SR.....	3093
17.4.3 BGP-LU (BGP-SR).....	3094
17.5 EVPN Type-5 Routes: IP Prefix Advertisement.....	3096
17.6 BGP PIC Edge for EVPN VXLAN Routes for Remote VTEP Failures.....	3099
17.6.1 Configuring BGP PIC Edge for EVPN VXLAN Routes for Remote VTEP Failures.....	3100
17.6.2 Show Commands.....	3100
17.6.3 Troubleshooting.....	3103
17.6.4 Limitations.....	3103
17.7 Inter-VRF Local Route Leaking.....	3103
17.7.1 Inter-VRF Local Route Leaking using BGP VPN.....	3103
17.7.2 Inter-VRF Local Route Leaking using VRF-leak Agent.....	3107
17.8 Static Inter-VRF Route.....	3107
17.8.1 Platform Compatibility.....	3108
17.8.2 Configuration.....	3108
17.8.3 Show Commands.....	3108
17.8.4 Limitations.....	3109
17.9 VCS to EVPN Hitless Migration.....	3109
17.9.1 Platform Compatability.....	3109
17.9.2 Configuration.....	3109
17.9.3 Show Commands.....	3111
17.9.4 Limitations.....	3111
17.10 Configuring EVPN.....	3112
17.10.1 Configuring BGP-EVPN and VCS on CVX.....	3112
17.11 Sharing Equivalence Class entry across multiple VRF.....	3113
17.12 Sample Configurations.....	3115
17.12.1 EVPN VXLAN IRB Sample Configuration.....	3115
17.12.2 Multi-Tenant EVPN VXLAN IRB Sample Configuration.....	3119
17.12.3 EVPN MPLS Sample Configuration.....	3142
17.12.4 EVPN VxLAN IPv6 Overlay.....	3156
17.12.5 IP VPNs Sample Configuration.....	3162
17.13 EVPN and VCS Commands.....	3181
17.13.1 bfd vtep evpn.....	3182
17.13.2 next-hop resolution disabled.....	3183
17.13.3 redistribute bgp evpn vxlan.....	3184
17.13.4 redistribute service vxlan.....	3185
17.13.5 router general.....	3186
17.13.6 route-target export.....	3187
17.13.7 route-target import.....	3188
17.13.8 route-target route-map.....	3189
17.13.9 route-target.....	3191
17.13.10 show bgp evpn.....	3192
17.13.11 show ip bgp vrf.....	3194
17.13.12 show ip route vrf.....	3195
17.13.13 show ipv6 bgp vrf.....	3196
17.13.14 show ipv6 route vrf.....	3197
17.13.15 show l2rib input all.....	3198
17.13.16 show l2Rib input vxlan-control-service.....	3199
17.13.17 show l2rib output.....	3200
17.13.18 show service vxlan address-table.....	3201
17.13.19 show vrf leak flapping.....	3202
17.13.20 show vxlan control-plane.....	3203

17.13.21 vlan (VLAN-AWARE-Bundle configuration mode).....	3203
17.13.22 vni-aware-bundle.....	3205

Chapter 18: Multiprotocol Label Switching (MPLS)..... 3207

18.1 MPLS.....	3207
18.1.1 MPLS Description.....	3207
18.1.2 MPLS Configuration.....	3209
18.2 BGP/MPLS L3 VPN.....	3219
18.2.1 Platform Compatibility.....	3219
18.2.2 Operation.....	3220
18.2.3 Configuration.....	3221
18.2.4 Show Commands.....	3227
18.2.5 Limitations.....	3231
18.3 EVPN MPLS Shared ESI Label.....	3232
18.3.1 Configuring EVPN MPLS Shared ESI Label.....	3232
18.3.2 EVPN MPLS Shared ESI Label Show Commands.....	3233
18.3.3 Troubleshooting.....	3234
18.3.4 Limitations.....	3234
18.4 RSVP-TE LSR.....	3234
18.4.1 Platform Compatibility.....	3234
18.4.2 RSVP-TE LSR Configuration.....	3234
18.5 LDP Pseudowire.....	3246
18.5.1 Platform Compatibility.....	3246
18.5.2 Configurations.....	3247
18.5.3 Show Commands.....	3248
18.5.4 Limitations.....	3250
18.6 LDP Entropy Label.....	3250
18.6.1 Configuring LDP Entropy Label.....	3251
18.6.2 Show Commands.....	3251
18.6.3 Troubleshooting.....	3252
18.6.4 Limitations.....	3253
18.7 MPLS Commands.....	3254
18.7.1 authentication.....	3255
18.7.2 cspf delay.....	3256
18.7.3 entropy-label.....	3257
18.7.4 fast-reroute.....	3258
18.7.5 fast-reroute reversion.....	3259
18.7.6 hello interval.....	3260
18.7.7 mpls ip.....	3261
18.7.8 mpls shared index.....	3263
18.7.9 mpls static.....	3264
18.7.10 mpls static vrf-label.....	3267
18.7.11 mpls tunnel termination.....	3268
18.7.12 ping mpls rsvp session.....	3269
18.7.13 preemption method.....	3271
18.7.14 refresh method.....	3272
18.7.15 show mpls route summary.....	3273
18.7.16 show mpls route.....	3274
18.7.17 show mpls rsvp.....	3275
18.7.18 show mpls rsvp counters.....	3276
18.7.19 show mpls rsvp neighbor.....	3277
18.7.20 show mpls rsvp session detail.....	3278
18.7.21 show mpls rsvp session summary.....	3278
18.7.22 show mpls rsvp session.....	3279
18.7.23 show traffic-engineering cspf path.....	3280

18.7.24 show traffic-engineering database.....	3282
18.7.25 shutdown.....	3284
18.7.26 srlg.....	3285

Chapter 19: Visibility and Monitoring Services.....3287

19.1 Test Access Point (TAP) Aggregation.....	3287
19.1.1 TAP Aggregation Introduction.....	3287
19.1.2 TAP Aggregation Description.....	3287
19.1.3 TAP Aggregation Extra MPLS Pop (4 to 6 Labels).....	3290
19.1.4 TAP Aggregation Configuration.....	3291
19.1.5 TAP Aggregation Extra MPLS Pop Configuration.....	3305
19.1.6 TAP Aggregation Traffic Steering.....	3306
19.1.7 TAP Aggregation GUI.....	3315
19.1.8 TAP Aggregation Keyframe and Timestamp Configuration.....	3317
19.1.9 TapAgg GRE Tunnel Termination.....	3319
19.1.10 TAP Aggregation Commands.....	3326
19.2 Latency Analyzer (LANZ).....	3366
19.2.1 Introduction to LANZ.....	3367
19.2.2 LANZ Overview.....	3367
19.2.3 Configuring LANZ.....	3368
19.2.4 LANZ Commands.....	3379
19.3 Sampled Flow Tracking.....	3414
19.3.1 Sampled Flow Tracking Overview.....	3415
19.3.2 Configuring Sampled Flow Tracking.....	3415
19.3.3 Hardware Flow Tracking with IPFIX Export.....	3417
19.3.4 Sampled Flow Tracking Configuration Examples.....	3422
19.3.5 Sampled Flow Tracking Commands.....	3424
19.4 sFlow.....	3443
19.4.1 sFlow Conceptual Overview.....	3443
19.4.2 sFlow Configuration Procedures.....	3445
19.4.3 sFlow Subinterfaces.....	3448
19.4.4 sFlow Configuration Commands.....	3450
19.5 SNMP.....	3466
19.5.1 SNMP Introduction.....	3466
19.5.2 SNMP Conceptual Overview.....	3467
19.5.3 Configuring SNMP.....	3468
19.5.4 SNMP Commands.....	3479
19.6 VM Tracer.....	3513
19.6.1 VM Tracer Introduction.....	3513
19.6.2 VM Tracer Description.....	3514
19.6.3 VM Tracer Configuration Procedures.....	3515
19.6.4 VM Tracer Commands.....	3520
19.7 MapReduce Tracer.....	3545
19.7.1 MapReduce Tracer Introduction.....	3545
19.7.2 MapReduce Tracer Configuration.....	3547
19.7.3 Displaying MapReduce Tracer Results.....	3551
19.7.4 MapReduce Tracer Command Descriptions.....	3560

Overview

Arista Networks features switches with high-density, non-blocking Ethernet ports that are controlled through an extensible, Linux-based, modular network operating system. The intended audience for this manual is network administrators who configure Arista switches. A working knowledge of network administration is assumed.

New Features

This guide may not describe the features added in the most recent EOS version. For information on undocumented features, consult the TOI documents here: <https://eos.arista.com/toi/>.

Switch Platforms

A list of Arista switches and detailed information about each is available online here: <https://www.arista.com/en/products>.

Recently released switches may not appear in the list, but can be found in the most recent Release Notes (found under Active Releases here: <https://www.arista.com/support/software-download>).

CloudVision

The configuration tasks required for deployment of CloudVision, CVX, and CVP are described in the CloudVision Configuration Guide. The latest version can be found here: <https://www.arista.com/en/cg-cv/>.

Supported Features

For the complete supported-features list in the latest EOS release, see <https://www.arista.com/en/support/product-documentation/supported-features>.

For details on a specific release, see the Release Notes (found under Active Releases here: <https://www.arista.com/en/support/software-download>).

This section contains the following topic:

- [Command-Line Interface \(CLI\)](#)

1.1 Command-Line Interface (CLI)

The command-line interface (CLI) is one tool for controlling the switch and displaying information about its status and configuration. This chapter describes the use of the CLI.

This chapter includes these sections:

- [Accessing the EOS CLI](#)
- [Processing Commands](#)
- [Kernel-based Virtual Machine Commands and Configuration](#)
- [Switch Platforms](#)
- [Command Modes](#)
- [Managing Switch Configuration Settings](#)
- [Other Command-Line Interfaces](#)

- [Directory Structure](#)
- [Command-Line Interface Commands](#)

1.1.1 Accessing the EOS CLI

You can open an EOS CLI session through these connections:

- Ethernet management ports
- console port
- Telnet connections
- Secure Shell (SSH)

The following figure displays the EOS CLI in a Secure Shell connection.

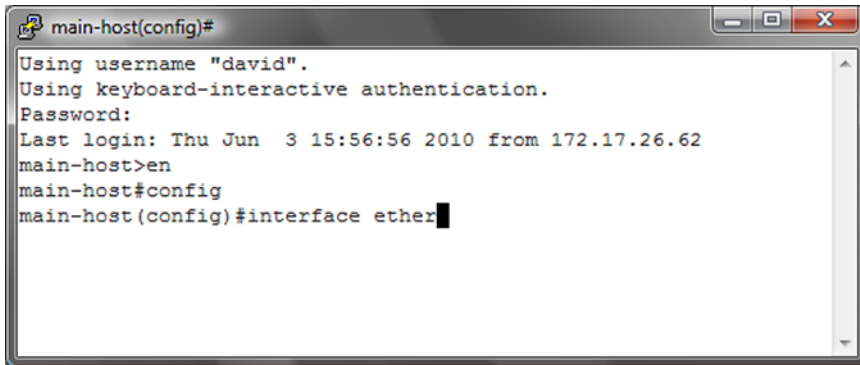

Figure 1: EOS Command-Line Interface

1.1.2 Processing Commands

1.1.2.1 Command Execution

Command keywords are not case-sensitive. The CLI also accepts truncated keywords that uniquely correspond to one command.

- The command abbreviation **con** does not execute a command in Privileged EXEC mode because the names of two commands begin with these letters: **configure** and **connect**.

```
switch# con
% Ambiguous command
```

- The command abbreviation **conf** executes **configure** in Privileged EXEC mode because no other command name begins with **conf**.

```
switch# conf
switch(config)#
```

1.1.2.2 Creating an Alias

The alias command creates an alias for a CLI command. Entering the alias in the CLI executes the corresponding command.

Example

- This command makes **srie** an alias for the command **show running-config interface ethernet 1-5**.

```
switch(config)#alias srie show running-config interface ethernet 1-5
```

```
switch(config)#srie
interface Ethernet1
    switchport access vlan 33
    storm-control broadcast level 1
    spanning-tree portfast
    spanning-tree bpduguard enable
interface Ethernet2
    switchport access vlan 33
    spanning-tree portfast
interface Ethernet3
    switchport access vlan 33
    spanning-tree portfast
    spanning-tree bpduguard enable
interface Ethernet4
interface Ethernet5
    shutdown
```

1.1.2.3 Cursor Movement Keystrokes

EOS supports these cursor movement keystrokes:

- **Ctrl-B** or the **Left Arrow** key: moves cursor to the left.
- **Ctrl-F** or the **Right Arrow** key: moves cursor to the right.
- **Ctrl-A**: moves cursor to beginning of line.
- **Ctrl-E**: moves cursor to end of line.
- **Esc-B**: moves cursor left one word.
- **Esc-F**: moves cursor right one word.

1.1.2.4 History Substitution Keystrokes

The history buffer retains the last 20 commands entered. History substitution keystrokes that access previously entered commands include:

- **Ctrl-P** or the **Up Arrow** key: Recalls the most recent buffered commands. Repeat to recall older commands.
- **Ctrl-N** or the **Down Arrow** key: Recalls more recent commands after using the **Ctrl-P** or the **Up Arrow**. Repeat to recall newer commands.

The **show history** command in Privileged EXEC mode displays the history buffer contents.

```
switch#show history
en
config
exit
show history
```

1.1.2.5 Command Lists and Syntax Assistance

EOS CLI uses widely followed conventions for providing command lists and syntax assistance. These conventions are available in all command modes.

- To display all commands available at this level, type a question mark (?):

```
switchName>?
clear          Reset functions
connect       Open a terminal connection
default       Set a command to its defaults
disable       Turn off privileged commands
enable        Turn on privileged commands
exit          Exit from the EXEC
```

logout	Exit from the EXEC
no	Negate a command or set its defaults
ping	Send echo messages
show	Show running system information
ssh	Open ssh connection
tcpdump	Monitor packets with tcpdump
telnet	Open a telnet connection
terminal	Configure the terminal
tracert	Trace route to destination
watch	Execute a command repeatedly
who	Display information about terminal lines
zerotouch	ZeroTouch configuration

- To display a list of commands beginning with a specific character sequence, type the sequence followed by a question mark.

```
switch# di?
diff dir disable
```

- To display a command's keywords or arguments, type a question mark as an argument.

```
switch> ping ?
WORD Ping destination address or hostname
ip IPv4 echo
ipv6 IPv6 echo
mpls Send echo messages for LSP
vrf Ping in a VRF
```

- The switch accepts an address-mask or CIDR notation (address-prefix) in commands that require an IP address and mask. For example, these commands are processed identically:

```
switch(config)# ip route 0.0.0.0 255.255.255.255 10.1.1.254
switch(config)# ip route 0.0.0.0/32 10.1.1.254
```

- The switch accepts an address-wildcard or CIDR notation in commands requiring an IP address and wildcard. Wildcards use zeros to mask portions of the IP address and are found in some protocol configuration statements, including OSPF. The switch processes these commands identically:

```
switch(config-router-ospf)# network 10.255.255.1 0.0.0.255 area 15
switch(config-router-ospf)# network 10.255.255.1/24 area 15
```

1.1.2.6 Regular Expressions

A regular expression is a search pattern composed of symbols, letters and numbers. Some CLI parameters are defined as regular expressions for specifying more expressive search criteria. The switch uses regular expression pattern matching in several BGP commands.

The functionality of a regular expression for an AS-Path varies based on BGP regex asn and string mode configurations in the `ip as-path regex-mode` command.

The following tables describe the behavior of special characters in asn and string modes respectively.

Special Characters	Characters Names	Description	Examples
.	Period	Matches any AS number.	'.' matches '200'. '10.20' matches '10 30 20', but does not match '10 20'.
^	Caret	Matches the specified expression at the beginning of an input string. Also used to exclude expressions in brackets while matching.	'^123' matches '123', '123 456', '123 456 789', and so on; but does not match '1234'. '[!^12]' matches '1', '2', '3', and so on; but does not match '12'.
*	Asterisk	Matches an entire AS number that appears either zero or more times.	'200_100*_300' matches '200 300', '200 100 300', '200 100 100 300', and so on. '^100*\$' matches empty AS path, '100', '100 100', '100 100 100', and so on.
+	Plus sign	Matches an entire AS number appearing either one or more times.	'10_20+_30' matches '10 20 30', '10 20 20 30' and so on; but does not match '10 200 30'.
\$	Dollar sign	Matches the specified expression at the end of an input string.	'1_2_3\$' matches '1 2 3', but does not match '1 2 3 4'.
[]	Brackets	Matches either an AS number, or a range of AS numbers separated by a hyphen.	'[10_20_30-39]' matches '10', '20', '30', '31',... '39'.
?	Question mark	Matches either zero or one occurrence of the pattern but the previous operand or entire AS number may appear zero or one time.	'100_200?' matches '100' and '100 200'. '100_200?\$', does not match with '100 20'.
	Pipe	Matches the specified AS number on either side of the vertical bar.	'6400 6500' matches either '6400' or '6500'.
()	Parenthesis	Nests specified AS numbers for matching.	'^(100(200 300))\$' matches either '100 200' or '100 300'. '^100_200 300_400\$' matches AS path either "100 200" or "300 400".
_	Underscore	Matches specified AS numbers that are converted into AS number delimiters.	'_123_456_' matches '123 456'. '_333_444_' matches '111 222 {333 444}'.



Note: Precede the question mark (?) with **Ctrl+V** sequence to prevent it from being interpreted as a help command.

Special Characters	Characters Names	Description	Examples
.	Period	Matches any single character.	'1.2' matches '102'.
^	Caret	Matches the specified expression at the beginning of an input string.	'^123' matches '123', '1234', '12345', and so on. It also matches '123 456', '123 456 789', and so on.
*	Asterisk	Matches either zero or more sequences of the expression preceding the asterisk.	'^5*\$' matches an empty AS path, '5', '55', '555', and so on.
+	Plus sign	Matches either one or more sequences of the expression preceding the plus sign.	'5+' matches to '5', '55', '555', and so on.
\$	Dollar sign	Matches the expression at the end of an input string.	'123\$' matches '123', but does not match '1234'.
[]	Brackets	Matches either characters or a range of characters separated by a hyphen, within left and right brackets.	'[025-7]' matches '0', '2', and digits from '5' to '7'; but does not match digits from '1', '3', '4', '8', and '9'.
?	Question mark	Matches either zero or one occurrence of the pattern.	'12?3' matches '13' and '123'.
	Pipe	Matches either one of the expressions or expression patterns on either side of the vertical bar.	'14(36 75)12' matches either '143612' or '147512'; but does not match '1412', '14367512', '14363612' or '14757512'.
()	Parenthesis	Nests specified expressions for matching.	'(17)*' matches any number of the two-character string '17'.
_	Underscore	For AS-Path regex, '_' matches curly brackets '{}', the beginning of input string, the end of input string, or space.	'_1300_' matches '100 {1300 1400}', '100 1300 200', and so on.
{}	Braces	Matches repetitions of the previous expression with the number of repetitions provided in braces.	'10{2,3}' matches '100' and '1000'.
\	Backslash	Matches the character following the backslash and special characters.	'\42' matches '(42'.

Precede the question mark (?) with **Ctrl+V** sequence to prevent it from being interpreted as a help command.

1.1.2.7 Scheduling CLI Commands

The [schedule](#) command facilitates the periodic execution of the specified CLI command. Command parameters configure the time to start script execution, the interval between consecutive execution instances, the maximum time to execute the script, and the maximum number of files log that needs to be created.

The `schedule config` command sets configuration parameters to the CLI scheduler.

The `show schedule` command lists the commands currently scheduled for periodic execution and displays the summary of the specified scheduled command.

Examples

- This command schedules the execution of a script once every 12 hours and the script execution is terminated if it exceeds 40 minutes. When `max-log-files` is set to zero, the script output is not logged.

```
switch# schedule ms_1 interval 720 timeout 40 max-log-files 0 command
bash /mnt/flash/myscript.sh
```

- This command saves the running configuration contents to a log file every hour, terminates the script execution if it exceeds 30 minutes and creates up to 24 log files.

```
switch#schedule backup-test interval 60 max-log-files 24 command show
running-config
```

- This command allows the switch to concurrently execute up to 2 scheduled commands.

```
switch(config)#schedule config max-concurrent-jobs 2
switch(config)#
```

- This command lists the commands that are scheduled for periodic execution.

```
switch(config)#schedule config max-concurrent-jobs 3
switch(config)#show schedule summary
Maximum concurrent jobs 3
Prepend host name to logfile: No
Name          At time      Last      Interval  Timeout    Max      Logfile Location
Status
              time      (mins)    (mins)    log
              files
-----
tech-support  now         00:29     60        30        100     flash:schedule/tech-support/
Success
thelp        12:02:00   00:02     60        40        100     flash:schedule/thelp/      Fail
06/05/2018
switch(config)#
```

1.1.2.8 Running Bash Shell Commands Automatically with Event Handlers

Event handlers execute a Linux Bash shell command in response to a specific system event. An event handler consists of a Bash command, a trigger and a delay; when the trigger event occurs, the action is scheduled to run after **delay** seconds.

To create an event handler, use the `event-handler` command. This creates a new event handler and places the CLI in event handler configuration mode for that handler. Use the `action bash` command to configure a Bash command to run when the handler is triggered, and the `trigger` command to specify the trigger. Event handlers can be triggered by various events, including:

- system booting
- a change in a specified interface's operational status or IP address
- a change in the `startup-config` file
- a state change in a virtual machine monitored by VM Tracer

To change the delay period between the trigger and the action, use the `delay` command.

When an action is run, certain information is passed to it through environment variables. For the boot trigger, no variables are set. For the **interface** triggers, the following variables are set and passed to the action:

- **\$INTF** interface name
 - **\$OPERSTATE** current operational status of the specified interface
 - **\$IP-PRIMARY** current primary IP address of the specified interface

To execute more than one Bash command in response to a trigger, create a script containing the desired commands and enter the file path to the script as the argument of the [action bash](#) command.

To display information about all event handlers or about a specific event handler, use the [show event-handler](#) command.

The `no event-handler` command deletes an event handler.

Examples

- These commands create an event handler named “eth_4” which will send email to a specified address when there is a change in the operational status of Ethernet interface 4:

```
switch(config)#event-handler eth_4
switch(config-event-eth_4)#action bash email x@yz.com -s "Et4
$OPERSTATE"
switch(config-event-eth_4)#trigger on-intf ethernet 4 operstatus
switch(config-event-eth_4)#delay 60
switch(config-event-eth_4)#exit
switch(config)#
```

The above handler uses the **\$OPERSTATE** variable to include the current operational state (“linkup” or “linkdown”) in the subject of the email. Note that the action will only function if email has been configured on the switch.

- These commands create an event handler named “onStartup” which will execute a user-defined script 60 seconds after the system boots.

```
switch(config)#event-handler onStartup
switch(config-event-onStartup)#action bash /mnt/flash/startupScript1
switch(config-event-onStartup)#trigger onboot
switch(config-event-onStartup)#delay 60
switch(config-event-onStartup)#exit
switch(config)#
```

The above handler will also be executed on exiting from event-handler configuration mode.

- This command displays information about all event handlers configured on the system.

```
switch#show event-handler
Event-handler onStartup
Trigger: onBoot delay 60 seconds
Action: /mnt/flash/startupScript1
Last Trigger Activation Time: 1 minutes 51 seconds ago
Total Trigger Activations: 1
Last Action Time: 51 seconds ago
Total Actions: 1

switch#
```

- This command deletes the event handler named “onStartup”.

```
switch(config)#no event-handler onStartup
switch(config)#
```

1.1.2.9 Running Adverse Drop Counters Monitor with Event Handlers

A monitoring capability for adverse drop counters can be used as a warning that the system is encountering an abnormal condition. The adverse drop counter monitor runs periodically (with a default of 60 seconds) and performs the following actions:

- Reads the values of adverse drop counters.
- Compares each value to the value read in the previous run.
- If counter values increase more than a certain threshold (with a default of 100), it is considered as a threshold violation.
- If any counter has more than a certain number of threshold violations within a specific time window (with a default of 3 violations within 15 minutes) a syslog message is logged.

No configuration is required to enable adverse drop counters monitor with event handlers. It is enabled by default and can be disabled, and can be customized for duration of time window and threshold levels. To customize the delay, polling interval, and condition for width, violation count, and threshold of this event handler, use the `event-handler DropCountersHandler` command. To display details of this event handler, use the `show event-handler DropCountersHandler` command.

Examples

- These commands customize the delay, polling interval, and condition for width, violation count, and threshold of this event handler. Each parameter may be customized separately, with all other parameters remaining unchanged.

```
switch(config)#event-handler DropCountersHandler
switch(config-DropCountersHandler)#action bash DropCounterLog.py -l
switch(config-DropCountersHandler)#delay 0
switch(config-DropCountersHandler)#trigger on-counters
switch(config-DropCountersHandler-counters)#poll interval 60
switch(config-DropCountersHandler-counters)#condition
bashCmd."DropCounterMonitor.py" -w 800" > 0
switch(config-DropCountersHandler-counters)#condition
bashCmd."DropCounterMonitor.py" -c 5" > 0
switch(config-DropCountersHandler-counters)#condition
bashCmd."DropCounterMonitor.py" -t 200" > 0
switch(config-DropCountersHandler-counters)#
```

- This command disables this event handler.

```
switch(config)#no event-handler DropCountersHandler
switch(config)#
```

- This command displays details of this event-handler.

```
switch(config)#show event-handler DropCountersHandler
Event-handler DropCountersHandler (BUILT-IN)
Trigger: on-counters delay 0 seconds
  Polling Interval: 60 seconds
  Condition: bashCmd."DropCounterMonitor.py" > 0
Threshold Time Window: 0 Seconds, Event Count: 1 times
Action: DropCounterLog.py -l
Action expected to finish in less than 20 seconds
Total Polls: 39
Last Trigger Detection Time: 38 minutes 22 seconds ago
Total Trigger Detections: 1
Last Trigger Activation Time: 38 minutes 22 seconds ago
Total Trigger Activations: 1
Last Action Time: Never
Total Actions: 1
```

```
switch(config)#
```

1.1.3 Kernel-based Virtual Machine Commands and Configuration

Arista's EOS has leveraged its unmodified Linux kernel, and embraced open source standards-based technology that has brought operating system virtualization to Ethernet switching, utilizing the kernel-based virtual machine (KVM) as follows:

- The hypervisor is the Linux kernel.
- The core virtualization infrastructure is provided by the kernel module.
- The CPU-specific implementation is provided by the processor-specific module (Intel or AMD).
- The generic machine emulator and virtualizer KVM is provided by a Modified Quick Emulator (QEMU), which transforms the Linux kernel into the hypervisor.

The standard Linux kernel is the hypervisor, resulting in changes to the standard kernel (such as memory support and scheduler). Optimizations to these Linux components (such as a new scheduler in the 2.6 kernel) benefit both the hypervisor (host operating system) and Linux guest operating systems. With the kernel acting as the hypervisor, the switch can run other operating systems, such as Windows or Linux.

All components required are pre-installed with the Arista EOS software image, requiring only the download of the image. A few additional configuration steps get the KVM fully operational.

This chapter contains the following sections:

- [KVM Commands](#)
- [KVM Configuration](#)

1.1.3.1 KVM Commands

The following table covers KVM commands used throughout the configuration.

Table 1: KVM Commands

Command	Description
comment	Up to 240 character comment for this mode.
default	Set a command to its defaults.
disk-image	Add Virtual Machine disk image.
enable	Enable VM.
exit	Exit from Virtual Machine configuration mode.
memory-size	Set memory size.
no	Negate a command or set its defaults.
show	Show running system information.
virtual-nic	Add virtual NIC.
vnc-port	Set VNC server port.
!!	Append to comment.

1.1.3.1.1 CLI Commands

The following KVM CLI commands are used throughout the configuration.

vm

In `config` mode, the `vm` CLI command creates or deletes a KVM configuration, or enters `config-vm` mode. A newly created KVM will have an empty config file path and is disabled.

The CLI command syntax is as follows:

```
[no] vm NAME
```

config-file

In `config-vm` mode, the `config-file` CLI command sets the path of the `libvirt` config file, using standard file syntax (e.g. `flash:vm/NetscalerVPX.xml` or `sata1:vm/NetscalerVPX.xml` or `/mnt/sata1/vm/NetscalerVPX.xml`). Changing this value does not affect the state of a currently enabled KVM. To use the new file, the user must disable and then re-enable the KVM.

The CLI command syntax is as follows:

```
config-file [PATH]
```

enabled

In `config-vm` mode, the `enabled` CLI command allows enabling a currently disabled VM, causing it to start up immediately. If a VM is enabled in the `startup-config`, it starts up automatically when EOS boots (or when `VirtAgent` starts).

The CLI command syntax is as follows:

```
[no] enabled
```

Disabling a currently enabled VM initiates a shutdown process in the following sequence:

- Attempt to shut down the VM politely if the guest OS supports ACPI.
- If the VM is still running after 30 seconds, terminate it.

show vm

In `enable` mode, the `show vm` CLI command prints information about the configuration and status of a KVM, or of all KVMs if `NAME` is omitted, as follows:

- Configuration: Name, config file path, and enabled.
- Status: PID, log file path, and serial console pty path.
- Current resource usage: RES, CPU%
- (Detailed only) contents of the config file.
- (Detailed only) contents of the log file.

The CLI command syntax is as follows:

```
show vm [detailed] [NAME]
```

attach vm

In `enable` mode, the `attach vm` CLI command connects to a KVM's serial console pty (using `virsh console`).

 **Note:** Press `Ctrl-]` to exit to the CLI.

The CLI command syntax is as follows:

```
attach vm [NAME]
```

show tech-support

The CLI command syntax is as follows:

```
show tech-support [detailed] [NAME]
```

reload

In **enable** mode, the **reload** CLI command is executed before restarting the system, and will shut down currently enabled KVMs using the same process as the **no enabled** command in **config-vm** mode.

The CLI command syntax is as follows:

```
reload
```

1.1.3.2 KVM Configuration

Arista EOS enables kernel-based virtual machine (KVM) instances by running KVM on the control-plane CPU of the switch. KVM instances can be defined from the CLI.

To configure a KVM, you must download the virtual machine image and configure the EOS.

This section contains the following topics:

- [Configuring a KVM](#)
- [Configuring a Guest KVM](#)

1.1.3.2.1 Configuring a KVM

To configure a KVM, perform the following steps:

1. Download the Virtual Machine Image to **/mnt/flash**
2. Name the virtual machine: `switch(config)#virtual-machine [kvm_name]`

Example:

```
switch(config)#virtual-machine foo
```

3. Provide a pointer to the image: `switch(config-vm-foo)#disk-image [file:[path]] image-format [format]`

Example:

```
disk-image file:/mnt/flash/fedora.img image-format qcow2
```

4. Define the amount of memory allocated: `switch(config-vm-foo)#memory-size [size in bytes]`
5. Bind the virtual NIC to an SVI (or management interface): `switch(config-vm-foo)#virtual-nic 1 vlan [1-4] switch(config-vm-foo)#virtual-nic 1 management [1-4]`
6. Create the VNC server's tcp port (display): `switch(config-vm-foo)#vnc-port [vnc-port number]`
7. Enable the virtual machine: `switch(config-vm-foo)#enable`

Optionally attach to the virtual machine via VNC client pointed to the switch's IP address. However, if Kernel **hair-pinning** is currently not enabled, preventing communication directly with the local switch, all traffic must have a destination on another networked device (such as a router, switch, or server).

For specifics about KVM visit <http://www.linux-kvm.org/>.



Note: In the Real VNC Viewer for **Options**, **Expert**, and **ColorLevel1**, if the default value is **pal8**, establishing a session may fail. If this occurs, set this value to **full** and **reconnect**.

Example

```
switch#copy http://berrange.fedorapeople.org/images/2012-02-
```



```
29/f16-x86_64-openstack-sda.qcow2
(http://berrange.fedorapeople.org/images/2012-02-29/f16-x86_64-
openstack-sda.qcow2) flash:
...
switch(config)#virtual-machine foo
switch(config-vm-foo)#disk-image file:/mnt/flash/fedora.img image-
format qcow2
switch(config-vm-foo)#memory-size 512
switch(config-vm-foo)#virtual-nic 1 vlan 1
switch(config-vm-foo)#virtual-nic 2 management 1
switch(config-vm-foo)#vnc-port 5900
switch(config-vm-foo)#enable
```

1.1.3.2.2 Configuring a Guest KVM

To configure a guest KVM, perform the following steps:

1. Download the Virtual Machine Image to **/mnt/flash**
2. Name the virtual machine: `switch(config)#virtual-machine [guest_name]`

Example:

```
switch(config)#virtual-machine guest123
```

3. Provide a pointer to the image: `switch(config-vm-guest123)#disk-image [file:[path] image-format [format]`

Example:

```
switch(config-vm-guest123)#disk-image flash:f16-x86_64-openstack-
sda.qcow2 image-format ?
iso iso image format qcow qcow image format qcow2 qcow2 image format
raw raw image format
vmdk vmdk image format switch(config-vm-guest123)#disk-image
flash:f16-x86_64-openstack-sda.qcow2 image-format qcow2
```

4. Define the amount of memory allocated: `switch(config-vm-guest123)#memory-size [size in bytes]`
5. Bind the virtual NIC to an SVI (or management interface): `switch(config-vm-guest123)#virtual-nic 1 vlan [1-4] switch(config-vm-guest123)#virtual-nic 2 management [1-4]`
6. Create the VNC server's tcp port (display): `switch(config-vm-guest123)#vnc-port [vnc-port number]`
7. Enable the virtual machine: `switch(config-vm-guest123)#enable`

Example

```
switch#copy http://berrange.fedorapeople.org/images/2012-02-
29/f16-x86_64-openstack-sda.qcow2
(http://berrange.fedorapeople.org/images/2012-02-29/f16-x86_64-
openstack-sda.qcow2) flash:
...
switch#config terminal
switch(config)#virtual-machine ?
WORD Virtual Machine name
switch(config)#virtual-machine foo
switch(config-vm-foo)#disk-image flash:f16-x86_64-openstack-sda.qcow2
image-format ?
iso iso image format
qcow qcow image format
qcow2 qcow2 image format
```

```

raw          raw image format
vmdk         vmdk image format
switch(config-vm-foo) #disk-image flash:f16-x86_64-openstack-sda.qcow2
image-format qcow2
switch(config-vm-foo) #memory-size 1024
switch(config-vm-foo) #virtual-nic ?
    <1-4>          Virtual NIC Id
switch(config-vm-foo) #virtual-nic 1 ?
    Management     Management interface
    Vlan           Vlan interface
switch(config-vm-foo) #virtual-nic 1 vlan 1
switch(config-vm-foo) #virtual-nic 2 management 1
switch(config-vm-foo) #enable
switch(config-vm-foo) #
switch(config-vm-foo) #^Z
switch#write mem
switch#
switch#show virtual-machine detail
Virtual Machine: foo
    Enabled:          Yes
    State:            Running
    Disk Image:       /mnt/flash/f16-x86_64-openstack-sda.qcow2
    Disk Image Format: qcow2
    Memory Size:     1024MB
    VNC port:        5900
    Virtual Nic:     vnic1
        Mac Address:  52:54:00:ee:11:c9
        Device:       Vlan1
        Model Type:   e1000
    Virtual Nic:     vnic2
        Mac Address:  52:54:00:df:2a:e1
        Device:       Management1
        Model Type:   e1000
switch#

```

1.1.4 Switch Platforms

Features and CLI commands vary by switch platform. CLI options may also vary by switch platform for commands that are available on all platforms. Command descriptions in this manual describe feature availability and command parameters on the basis of switch platform, noting exceptions that exist among models that use a common platform.

- <https://www.arista.com/en/products/switches> lists the Arista switches and platforms upon which they operate.
- <https://www.arista.com/en/support/product-documentation/supported-features> lists Arista switch feature availability by switch platform. For the latest features, also consult the Release Notes, available at <https://www.arista.com/en/support/software-download>.

These sections describe the following topics:

- [Viewing the Model Number](#)
- [Determining a Switch's Operating Platform](#)
- [Modular System Platforms – 7500 and 7500E Series Switches](#)
- [Multi-Chip Devices](#)

1.1.4.1 Viewing the Model Number

To view the switch's model number through the CLI, enter the `show version` command.

Example

- This command displays the model number, serial number, system MAC address, and manufacturing information of a DCS-7150S-64 switch.

```
switch> show version
Arista DCS-7150S-64-CL-F
Hardware version:    01.01
Serial number:      JPE13120819
System MAC address: 001c.7326.fd0c

Software image version: 4.13.2F
Architecture:        i386
Internal build version: 4.13.2F-1649184.4132F.2
Internal build ID:    eeb3c212-b4bd-4c19-ba34-1b0aa36e43f1

Uptime:              16 hours and 39 minutes
Total memory:        4017088 kB
Free memory:         1348228 kB

switch>
```

1.1.4.2 Modular System Platforms – 7500 and 7500E Series Switches

Modular switch platforms depend on their installed modules along with the fabric and forwarding software modes. The `show module` command displays the fabric modules in the switch. System performance in switches containing both module types is based on first-generation fabric capabilities. Best practice is to avoid switch configurations with mixed fabric modules.

These sections describe modular switch components and software modes that program their capacities.

1.1.4.2.1 Fabric Modules and Fabric Mode – 7500 and 7500E Series Switches

Each modular switch fabric module is categorized as first-generation or E-Series:

- First-generation fabric modules support all basic switch functions.
- E-Series fabric modules support faster fabric link speeds, greater internal table capacities, and advanced encoding formatting.

Fabric mode determines the switch's fabric performance capabilities. This mode must match the fabric modules in the switch. Fabric mode settings include:

- **fe600**: Supports first-generation fabric modules.
- **fe1600**: Supports E-Series fabric modules.

E-series fabric modules can operate in **fe600** mode, but are limited to first-generation fabric performance. First-generation modules cannot operate in **fe1600** mode. Switches containing both types of modules must be set to **fe600** mode. Best practice is to avoid switch configurations with mixed fabric modules.

When a switch reloads, fabric mode is determined by the following (in order of precedence):

1. Switches reloading in **petraA** forwarding compatibility mode ([Linecard Modules and Forwarding Compatibility Mode – 7500 and 7500E Series](#)) also reload in **fe600** fabric mode.
2. As specified by the `platform sand fabric mode (7500 and 7500E Series)` statement in `running-config`.
3. The first fabric module that becomes operational as the switch reloads.

In switches with a homogeneous module set, the fabric mode matches its fabric modules. Switches with a mixed set of modules are typically reloaded in **fe600** mode because first generation modules are

usually operational before E-Series modules. However, the fabric mode in mixed module switches that are reloading cannot be guaranteed in the absence of the first two conditions.

Example

- This command configures the switch to reload in fe1600 fabric mode to support E-series fabric modules. After issuing this command, the switch should be reset only after exchanging all switch fabric modules to E-series modules.

```
switch(config)#platform sand fabric mode fe1600
switch(config)#exit
switch#show platform sand compatibility
Configuration      Status
Forwarding mode    None              Arad
Fabric mode        Fe1600           Fe600
switch#
```

1.1.4.2.2 Determining a Switch's Operating Platform

FM6000 Platforms

To determine the operating platform on switch, display **platform** command options from Global Configuration command mode.

- This command displays the operating platform of a switch operating on the FM6000 platform (7150 Series switches).

```
switch(config)# platform ?
fm6000  FM6000 chip

switch(config)#platform
```

Arad and Petra Platforms

The **platform ?** command displays the same options on Arad and Petra platform switches. Refer to [Viewing the Model Number](#) to determine the switch's model number.

- Fixed system switches (DCS-7048 Series) operate on the Petra platform.
- Modular switches (DCS-7500 Series) operate on Arad and Petra platforms. [Modular System Platforms – 7500 and 7500E Series Switches](#) describe platform usage on these switches.

Arad and Petra platform switch typically utilize multiple chips. [Multi-Chip Devices](#) describe methods of determining the port distribution on multi-chip platforms.

Example

- These commands display platform options of a switch operating on either Petra or Arad platforms.

```
switch(config)# platform ?
arad      Arad switch chip
fe1600    Fe1600 chip
fe600     Fe600 fabric chip
petraA    PetraA switch chip
ptp       Precision Time Protocol
sand      Sand platform

switch(config)#platform
```

Trident and Trident II Platforms

The `platform ?` command returns **trident** on switches that operate on Trident or Trident II platforms. Trident II platform switches include options that configure the forwarding and routing tables. To determine the Trident platform that a switch uses, display **platform trident** options.

- These commands indicate that the switch is operating on the Trident II platform:

```
switch(config)# platform ?
  ptp          Precision Time Protocol
  trident      Trident chip

switch(config)# platform trident ?
  fabric              Fabric configuration
  forwarding-table    Forwarding table configuration
  mmu                 Trident MMU configuration
  routing-table       Routing table configuration

switch(config)#platform trident
```

Fixed and Modular switches are available that operate on the Trident II platform. Refer to [Viewing the Model Number](#) to determine the switch's model number. [Viewing Modules on 7300 Series Modular Switches](#) displays the modules on a Trident II platform modular switch.

Trident II platform switches typically utilize multiple chips. [Multi-Chip Devices](#) describes methods of determining port distribution on multi-chip platforms.

1.1.4.2.3 Linecard Modules and Forwarding Compatibility Mode – 7500 and 7500E Series

Each modular switch linecard module is categorized as first-generation or E-Series:

- First-generation linecard modules support all basic switch functions.
- E-Series linecard modules support provide faster data processing, greater internal table capacities, and advanced encoding formatting.

The forwarding compatibility mode determines the switch's performance capabilities when forwarding data between linecard interfaces. Forwarding compatibility mode settings include:

- **PetraA:** Supports first-generation linecard modules.
- **Arad:** Supports E-Series linecard modules.

Forwarding compatibility mode determines the operational capacity of installed linecards. The following table lists the affect of the forwarding compatibility mode on linecard module types.

Table 2: Linecard Module and Forwarding Mode Performance

Linecard Module Type	Forwarding Compatibility Mode	Linecard Operating Capacity
First-generation	petraA	First-generation performance capacity.
First-generation	arad	Linecard is powered-down.
E-Series	petraA	First-generation performance capacity.
E-Series	arad	E-series performance capacity.



Note: Switches must contain E-Series fabric modules to operate at E-Series performance capacities.

The forwarding compatibility mode is configured by the `platform sand forwarding mode (7500 and 7500E Series)` command. This command may be required after exchanging a linecard for a different module type or in switches containing first-generation and E-series linecards.

Without a `platform sand forwarding mode (7500 and 7500E Series)` command, forwarding compatibility mode is determined by the first linecard that is operational after reloading the switch. In a switch that is reloaded with a homogeneous module set, forwarding compatibility mode matches its linecards. Switches with a mixed set of modules are typically reloaded in **petraA** mode because first generation modules are usually operational before E-Series modules. However, forwarding compatibility mode in mixed module switches that are reloading is not guaranteed without a `platform sand forwarding mode` command.

Example

This command changes the forwarding software mode to support E-series linecard modules. This command should be run only after exchanging all linecards to E-series modules.

```
switch(config)# platform sand forwarding mode arad
switch(config)#
```

1.1.4.2.4 Viewing Modules – 7500 and 7500E Series

The `show module` command displays the model number of all installed modules.

- This command displays the modules of a 7504 switch that contains first-generation modules.

```
switch>show module
Module Ports Card Type Model Serial No.
-----
1 2 DCS-7500 Series Supervisor Module 7500-SUP JSH11440327
2 1 Standby supervisor Unknown Unknown
3 48 48-port SFP+ 10GigE Linecard 7548S-LC JSH10449938
4 48 48-port SFP+ 10GigE Linecard 7548S-LC JSH11091247
5 48 48-port SFP+ 10GigE Linecard 7548S-LC JSH11211614
6 48 48-port SFP+ 10GigE Linecard 7548S-LC JSH11520288
Fabric1 0 DCS-7504 Fabric Module 7504-FM JSH11451230
Fabric2 0 DCS-7504 Fabric Module 7504-FM JSH11451210
Fabric3 0 DCS-7504 Fabric Module 7504-FM JSH11410115
Fabric4 0 DCS-7504 Fabric Module 7504-FM JSH11380318
Fabric5 0 DCS-7504 Fabric Module 7504-FM JSH11340955
Fabric6 0 DCS-7504 Fabric Module 7504-FM JSH11410128

Module MAC addresses Hw Sw Status
-----
1 00:1c:73:03:06:ac - 00:1c:73:03:06:ac 07.06 4.12.1 Active
2 00:1c:73:03:06:ac - 00:1c:73:03:06:ac 07.10 4.12.1 Standby
3 00:1c:73:03:80:44 - 00:1c:73:03:80:73 06.00 07.10 Ok
4 00:1c:73:03:e4:34 - 00:1c:73:03:e4:63 07.10 07.30 Ok
5 00:1c:73:12:0b:3f - 00:1c:73:12:0b:6e 07.30 08.00 Ok
6 00:1c:73:12:b6:3f - 00:1c:73:12:b6:6e 08.00 05.03 Ok
Fabric1 05.03 Ok
Fabric2 05.03 Ok
Fabric3 05.02 Ok
Fabric4 05.02 Ok
Fabric5 05.02 Ok
Fabric6 05.02 Ok
switch>
```

- This command displays modules of a 7504 switch that contains E-Series modules.

```
switch>show module
Module Ports Card Type Model Serial No.
-----
1 3 DCS-7500E-SUP Supervisor Module 7500E-SUP JAS13060306
3 72 48 port 10GbE SFP+ & 2x100G Linecard 7500E-72S-LC JAS12410019
4 72 48 port 10GbE SFP+ & 2x100G Linecard 7500E-72S-LC JPE13041458
5 72 48 port 10GbE SFP+ & 2x100G Linecard 7500S-72S-LC JAS12380089
Fabric1 0 DCS-7504-E Fabric Module 7504E-FM JAS12370008
Fabric2 0 DCS-7504-E Fabric Module 7504E-FM JAS12380012
Fabric3 0 DCS-7504-E Fabric Module 7504E-FM JAS12370014
Fabric4 0 DCS-7504-E Fabric Module 7504E-FM JAS12380008
Fabric5 0 DCS-7504-E Fabric Module 7504E-FM JAS12380017
Fabric6 0 DCS-7504-E Fabric Module 7504E-FM JAS12370009

Module MAC addresses Hw Sw Status
-----
```

```

1      00:1c:73:00:f4:cd - 00:1c:73:00:f4:ce 00.00 4.12.3 Active
3      00:1c:73:00:9c:7b - 00:1c:73:00:9c:c2 00.00      Ok
4      00:1c:73:28:a0:57 - 00:1c:73:28:a0:9e 00.00      Ok
5      00:1c:73:00:9a:cb - 00:1c:73:00:9b:12 02.07      Ok
Fabric1      00.00      Ok
Fabric2      00.00      Ok
Fabric3      00.00      Ok
Fabric4      00.00      Ok
Fabric5      00.00      Ok
Fabric6      00.00      Ok
switch>

```

1.1.4.3 Viewing Modules on 7300 Series Modular Switches

7300 Series Modular switches operate on Trident II platform. The **show module** command displays the model number of all installed modules.

```

switch>show module
-----
Module      Ports Card Type                               Model                               Serial No.
-----
1           3      Supervisor 7300X SSD                       DCS-7300-SUP-D                      JAS13340024
3          128     32 port 40GbE QSFP+ LC                     7300X-32Q-LC                        JPE13440416
4           64      48 port 10GbE SFP+ & 4 port QSFP+ LC      7300X-64S-LC                        JAS13310113
5           64      48 port 10GbE SFP+ & 4 port QSFP+ LC      7300X-64S-LC                        JAS13340033
6           64      48 port 10GbE SFP+ & 4 port QSFP+ LC      7300X-64S-LC                        JAS13310103
Fabric1     0       7304X Fabric Module                       7304X-FM                            JAS13320077
Fabric2     0       7304X Fabric Module                       7304X-FM                            JAS13350043
Fabric3     0       7304X Fabric Module                       7304X-FM                            JAS13350050
Fabric4     0       7304X Fabric Module                       7304X-FM                            JAS13350056
-----
Module      MAC addresses                               Hw      Sw      Status
-----
1           00:1c:73:36:4b:71 - 00:1c:73:36:4b:72 01.01   4.13.3F Active
3           00:1c:73:58:d4:68 - 00:1c:73:58:d4:87 03.04      Ok
4           00:1c:73:36:05:61 - 00:1c:73:36:05:94 02.02      Ok
5           00:1c:73:36:0a:e1 - 00:1c:73:36:0b:14 02.03      Ok
6           00:1c:73:36:02:e1 - 00:1c:73:36:03:14 02.02      Ok
Fabric1     00.00      Ok
Fabric2     00.00      Ok
Fabric3     00.00      Ok
Fabric4     00.00      Ok
switch>

```

1.1.4.4 Multi-Chip Devices

Trident II, Petra, and Arad platform switches and linecards utilize multiple chips, with Ethernet ports evenly distributed among the chips. Creating multi-port data structures (including port channels) that include ports from multiple chips protects against the failure of an individual chip on a device.

The following sections describe methods of determining port distribution on various switch platforms

Petra Fixed Switches

7048-Series switches are Petra platform devices that distribute ports among two PetraA chips. The **show platform petraA port-info routing** command displays the ports that are controlled by each chip.

Example

- This command displays the following Ethernet port distribution on a DCS-7048-T switch:
 - Petra0 chip controls Ethernet 1 through Ethernet 32
 - Petra1 chip controls Ethernet 33 through Ethernet 52

```

switch#show platform petraA port-info routing
Petra0 Port Routing Information:
=====
=====
                                     sys      fap
intfName      port-id port-id intfType  portType  routing
                                     v4 v6

```

```

=====
=====
CpuTm                2          0      Cpu      Tm          1  1
Ethernet1            29          2      Nif      Ethernet    1  1
Ethernet2            30          3      Nif      Ethernet    1  1

Ethernet31           59         32      Nif      Ethernet    1  1
Ethernet32           60         33      Nif      Ethernet    1  1

RawPetra0/70         2118        70      Recycling Raw          1  1
Petra1 Port Routing Information:
=====
=====
          sys      fap
intfName  port-id port-id intfType  portType  routing
          v4 v6
=====
=====
CpuTm                2          0      Cpu      Tm          1  1
Ethernet33           66          2      Nif      Ethernet    1  1
Ethernet52           85          21     Nif      Ethernet    1  1
L3SecondHop1Petra1  86          22     Recycling Ethernet    1  1

RawPetra1/70         2118        70      Recycling Raw          1  1
switch#

```

Petra Modular Switches

Linecards on 7500-Series modular switches distribute Ethernet ports among multiple petraA chips. The **show platform petraA port-info routing** command displays the ports that are controlled by each chip on all PetraA linecards or on a single linecard.

Example

- This command displays the following Ethernet port distribution on linecard 4 of a DCS-7504 switch:
 - Petra4/0 chip controls Ethernet 4/1 through Ethernet 4/8
 - Petra4/1 chip controls Ethernet 4/9 through Ethernet 4/16
 - Petra4/2 chip controls Ethernet 4/17 through Ethernet 4/24
 - Petra4/3 chip controls Ethernet 4/25 through Ethernet 4/32
 - Petra4/4 chip controls Ethernet 4/33 through Ethernet 4/40
 - Petra4/5 chip controls Ethernet 4/41 through Ethernet 4/48

```

switch(s1)#show platform petra module 4 port-info routing
Petra4/0 Port Routing Information:
=====
=====
          sys      fap
intfName  port-id port-id intfType  portType  routing
          v4 v6
=====
=====
CpuTm                2          0      Cpu      Tm          1  0

Ethernet4/1          221          2      Nif      Ethernet    1  0
Ethernet4/2          222          3      Nif      Ethernet    1  0
Ethernet4/3          223          4      Nif      Ethernet    1  0
Ethernet4/4          224          5      Nif      Ethernet    1  0
Ethernet4/5          225          6      Nif      Ethernet    1  0
Ethernet4/6          226          7      Nif      Ethernet    1  0

```



```

Ethernet4/7          227      8    Nif      Ethernet    1 0
Ethernet4/8          228      9    Nif      Ethernet    1 0

RawPetra4/0/70      2118     70    Recycling Raw    1 0
Petra4/1 Port Routing Information:
=====
=====
      intfName          sys      fap
      port-id port-id intfType  portType  routing
      v4 v6
=====
CpuTm                2        0    Cpu      Tm        1 0
Ethernet4/9          253      2    Nif      Ethernet    1 0

Petra4/5 Port Routing Information:
=====
=====
      intfName          sys      fap
      port-id port-id intfType  portType  routing
      v4 v6
=====
Ethernet4/41         381      2    Nif      Ethernet    1 0
Ethernet4/42         382      3    Nif      Ethernet    1 0
Ethernet4/43         383      4    Nif      Ethernet    1 0
Ethernet4/44         384      5    Nif      Ethernet    1 0
Ethernet4/45         385      6    Nif      Ethernet    1 0
Ethernet4/46         386      7    Nif      Ethernet    1 0
Ethernet4/47         387      8    Nif      Ethernet    1 0
Ethernet4/48         388      9    Nif      Ethernet    1 0

switch(s1)#

```

Arad Modular Switches

7500-E Series linecards distribute Ethernet ports among multiple Arad chips. The **show platform arad port-info routing** command displays the ports that are controlled by each chip on all Arad linecards.

Example

- This command displays the following Ethernet port distribution on the 7500E-72S-LC linecard that is inserted as module 3 in a DCS-7508E switch:
 - Arad3/0 chip: Ethernet 3/1– Ethernet 3/20
 - Arad3/1 chip: Ethernet 3/21 – Ethernet 3/34 and Ethernet 3/49/1 – Ethernet 3/49/12
 - Arad3/2 chip: Ethernet 3/35 – Ethernet 3/48 and Ethernet 3/50/1 – Ethernet 3/50/12

```

switch#show platform arad mapping

Arad3/0          Port          SysPhyPort Voq  (Fap,FapPort)
Xlge Serdes
-----
CpuTm                2      32    (0 , 0)    n/a  n/a
Ethernet3/1          28    240    (0 , 2)    n/a  (16)
Ethernet3/2          29    248    (0 , 3)    n/a  (17)
Ethernet3/3          30    256    (0 , 4)    n/a  (18)
Ethernet3/4          31    264    (0 , 5)    n/a  (19)
Ethernet3/5          32    272    (0 , 6)    n/a  (20)
Ethernet3/6          33    280    (0 , 7)    n/a  (21)
Ethernet3/7          34    288    (0 , 8)    n/a  (22)
Ethernet3/8          35    296    (0 , 9)    n/a  (23)
Ethernet3/9          36    304    (0 , 10)   n/a  (24)
Ethernet3/10         37    312    (0 , 11)   n/a  (25)
Ethernet3/11         38    320    (0 , 12)   n/a  (26)
Ethernet3/12         39    328    (0 , 13)   n/a  (27)

```

```

Ethernet3/13          40  336  (0 , 14)  n/a  (4)
Ethernet3/14          41  344  (0 , 15)  n/a  (5)
Ethernet3/15          42  352  (0 , 16)  n/a  (6)
Ethernet3/16          43  360  (0 , 17)  n/a  (7)
Ethernet3/17          44  368  (0 , 18)  n/a  (0)
Ethernet3/18          45  376  (0 , 19)  n/a  (1)
Ethernet3/19          46  384  (0 , 20)  n/a  (2)
Ethernet3/20          47  392  (0 , 21)  n/a  (3)

RawArad3/0/56                2104 16848  (0 , 56)  n/a  n/a

Arad3/1
Xlge Serdes      Port          SysPhyPort Voq  (Fap,FapPort)
-----
Ethernet3/21                60  496  (1 , 2)   n/a  (16)
Ethernet3/34                73  600  (1 , 15)  n/a  (13)
Ethernet3/49/1              74  608  (1 , 16)  n/a  (0)

Ethernet3/49/12            85  696  (1 , 27)  n/a  (11)

Arad3/2
Xlge Serdes      Port          SysPhyPort Voq  (Fap,FapPort)
-----
Ethernet3/35                92  752  (2 , 2)   n/a  (16)
Ethernet3/48               105  856  (2 , 15)  n/a  (13)
Ethernet3/50/1             106  864  (2 , 16)  n/a  (0)

Ethernet3/50/12           117  952  (2 , 27)  n/a  (11)

switch#

```

Trident II Fixed Switches

Trident II platform devices distribute their ports among multiple Trident II chips. The **show platform trident system port** command displays the ports that are controlled by each chip.

Example

- This command displays the following Ethernet port distribution on a DCS-7250QX-64-F switch:
 - Trident 0 chip controls Ethernet 1/1 through Ethernet 16/4
 - Trident 1 chip controls Ethernet 17/1 through Ethernet 32/4
 - Trident 2 chip controls Ethernet 33/1 through Ethernet 48/4
 - Trident 3 chip controls Ethernet 49/1 through Ethernet 64/4

```

switch#show platform trident system port

-----
          Intf          Chip          ModId          Logical          Port
          Physical          MMU
-----
Ethernet1/1      Linecard0/0          1              1              17              9
Ethernet1/2      Linecard0/0          1              2              18              10

Ethernet16/3     Linecard0/0          1              60             107             98
Ethernet16/4     Linecard0/0          1              61             108             99

Ethernet64/2     Linecard0/3          4              62             106             97
Ethernet64/3     Linecard0/3          4              63             107             98
Ethernet64/4     Linecard0/3          4              64             108             99

-----
switch#

```

Trident II Modular Switches

Linecards on 7300-Series modular switches distribute Ethernet ports among multiple Trident II chips. The **show platform trident system port** command can display the ports that are controlled by each chip on all linecards or on a single chip.

- This command displays the following Ethernet port distribution on DCS-7304-F switch that contains a 7300X-32Q-LC linecard as module 3:
 - Trident 0 chip controls Ethernet 1/1 through Ethernet 16/4 (on module 3)
 - Trident 1 chip controls Ethernet 17/1 through Ethernet 32/4 (on module 3)

```
switch#show platform trident system port
-----
                Intf           Chip           ModId           Logical           Port
                -----           -----           -----           -----           -----
                Ethernet3/1/1     Linecard3/0     5                1                17      4
                Ethernet3/2/1     Linecard3/0     5                2                21      5
                Ethernet3/16/3    Linecard3/0     5                51               111     102
                Ethernet3/16/4    Linecard3/0     5                52               112     103
                Ethernet3/32/3    Linecard3/1     6                63               111     102
                Ethernet3/32/4    Linecard3/1     6                64               112     103
-----
switch#
```

1.1.5 Command Modes

Command modes define the user interface state. Each mode is associated with commands that perform a specific set of network configuration and monitoring tasks.

- [Mode Types](#) lists the available modes.
- [Navigating Through Command Modes](#) lists mode entry and exit commands.
- [Command Mode Hierarchy](#) describes the mode structure.
- [Group-Change Configuration Modes](#) describes editing aspects of these modes.

1.1.5.1 Mode Types

The switch includes these command modes:

- **EXEC:** EXEC mode commands display system information, perform basic tests, connect to remote devices, and change terminal settings. When logging into EOS, you enter EXEC mode.

EXEC mode prompt: `switch>`

- **Privileged EXEC:** Privileged EXEC mode commands configure operating and global parameters. The list of Privileged EXEC commands is a superset of the EXEC command set. You can configure EOS to require password access to enter Privileged EXEC from EXEC mode.

Privileged EXEC mode prompt: `switch#`

- **Global Configuration:** Global Configuration mode commands configure features that affect the entire system, such as system time or the switch name.

Global Configuration mode prompt: `switch(config)#`

- **Interface Configuration:** Interface configuration mode commands configure or enable Ethernet, VLAN, and Port-Channel interface features.

Interface Configuration mode prompt: `switch(config-if-Et24)#`

- **Protocol specific mode:** Protocol specific mode commands modify global protocol settings. Protocol specific mode examples include **ACL Configuration** and **Router BGP Configuration**.

The prompt indicates the active command mode. For example, the Router BGP command prompt is `switch(config-router-bgp)#`

1.1.5.2 Navigating Through Command Modes

To change the active command mode, perform one of these actions:

- To enter EXEC mode, log into the switch.
- To enter Privileged EXEC mode from EXEC, type **enable** (or **en**) followed, if prompted, by the **enable** password:

```
switch>en
Password:
switch#
```

- To enter Global Configuration mode from Privileged EXEC, type **configure** (or **config**):

```
switch#config
switch(config)#
```

- To enter Interface Configuration mode from Global Configuration, type **interface** and the name of the interface to be modified:

```
switch(config)#interface Et24
switch(config-if-Et24)#
```

- To enter a protocol specific configuration mode from Global Configuration, type the required command for the desired mode.

```
switch(config)#router bgp 100
switch(config-router-bgp)#
```

- To return one level from any configuration mode, type **exit**.

```
switch(config)#exit
switch#
```

- To return to Privileged EXEC mode from any configuration mode, type **end** or **Ctrl-Z**.

```
switch(config-if-Et24)#<Ctrl-z>
switch#
```

- To return to EXEC mode from Privileged EXEC mode, type **disable** (or **dis**).

```
switch#dis
switch>
```

- To exit EOS and log out of the CLI, type **exit** from EXEC mode or Privileged EXEC mode.

```
switch#exit

login:
```

1.1.5.3 Command Mode Hierarchy

Command modes are hierarchical. The parent mode of a specified command mode is the mode that contains the command that enters the specified mode.

Example

- EXEC mode contains the **enable** command, which enters Privileged EXEC mode. Therefore, EXEC is the parent mode of Privileged EXEC.

Commands that are executable in a specified command mode include all commands available in the specified mode plus all commands executable from its parent mode.

Example

- EXEC mode includes the `ping` command. EXEC mode is the parent mode of Privileged EXEC mode. Therefore, Privileged EXEC mode includes `ping`.

Additionally, Privileged EXEC is the parent mode of Global Configuration mode. Therefore, Global Configuration mode also includes `ping`.

Executing a configuration mode command from a child mode may change the active command mode.

Example

- Global Configuration mode contains `interface ethernet` and `ip access-list` commands, which enter Interface Configuration and Access Control List (ACL) Configuration modes, respectively. When the switch is in Interface Configuration mode, the `ip access-list` command is available and changes the active mode to ACL Configuration.

```
switch(config)#interface ethernet 1
switch(config-if-Et1)#ip access-list master-list
switch(config-acl-master-list)#
```

The `exit` command changes the active command mode to its parent mode. When executed from Privileged EXEC or EXEC modes, the `exit` command terminates the session.

Example

- This command exits Global Configuration mode to Privileged EXEC mode.

```
switch(config)#exit
switch#
```

- This command terminates the user session.

```
switch#exit
```

1.1.5.4 Group-Change Configuration Modes

Group-change modes apply all changes made during an edit session only after exiting the mode. Changes are stored when the user exits the mode, either through an `exit` or `end` command or through a command that enters a different configuration mode.

The `abort` command discards all changes not previously applied.

Access Control List (ACL) and Multiple Spanning Tree (MST) configuration modes are examples of group-change modes.

1.1.6 Managing Switch Configuration Settings**1.1.6.1 Verifying Settings for the Current Mode**

To display only the lines of *running-config* that affect the current mode, use the `active` option of the `show (various configuration modes)` command. This command option is available in all configuration modes except global configuration.

Example

Type **show active** to display the content of *running-config* that affects the current mode. To include default settings in the display, type **show active all**.

```
switch(config-router-ospf3)#show active all
ipv6 router ospf 9
  router-id 0.0.0.0
  default-metric 10
  distance ospf intra-area 10
  area 0.0.0.200 default-cost 10
  area 0.0.0.200
  no log-adjacency-changes
  timers spf 5
switch(config-router-ospf3)#
```

To display any comments associated with the current mode, use the **comment** option of the **show (various configuration modes)** command.

Example

Type **show comment** to display any comments attached to the current mode.

```
switch(config-router-ospf3)#show comment
Comment for router-ospf3:
  Consult Thomas Morton before making changes to the OSPF configuration
.
switch(config-router-ospf3)#
```

1.1.6.2 Verifying the Running Configuration Settings

The **running-config** command is the virtual file that stores the operating configuration. The **show running-config** command displays the **running-config**. The command is supported in Privileged EXEC mode.

Example

- Type **show running-config** in Privileged EXEC mode. The response in the example is truncated to display only the ip route configured.

```
switch#show running-config
! Command: show running-config

!
ip route 0.0.0.0/0 192.0.2.1
!

end
switch#
```

1.1.6.3 Adding a Comment to a Configuration Mode

To add a comment to most switch configuration modes, use the **comment (various configuration modes)** command. Comments cannot be modified, but can be replaced by entering the **comment** command again and entering new text. Comments cannot be added to global configuration mode

To append to an existing comment, enter `!!` followed by additional comment text. To display comments for the active mode, use the `show comment` command. The `no comment` and `default comment` commands remove the comment from `running-config` .

Examples

- These commands enter a comment in Router OSPF3 Mode.

```
switch(config-router-ospf3)#comment
Enter TEXT message. Type 'EOF' on its own line to end.
Consult Thomas Morton before making changes to the OSPF configuration.
EOF
switch(config-router-ospf3)#
```

- These commands append additional information to the comment entered above.

```
switch(config-router-ospf3)#!! x2735
switch(config-router-ospf3)#show comment
Comment for router-ospf3:
    Consult Thomas Morton before making changes to the OSPF
    configuration.
    x2735
switch(config-router-ospf3)#
```

1.1.6.4 Saving the Running Configuration Settings

`startup-config` is the file, stored in internal flash memory, that the switch loads when it boots. Configuration changes that are not saved to `startup-config` are lost the next time the switch is booted.

The `write` and `copy running-config startup-config` commands store the operating configuration to `startup-config`. Both commands are supported in Privileged EXEC mode.

Example

These equivalent commands save the current operating configure to the startup-config file.

```
switch#write

switch#copy running-config startup-config
```

The `show startup-config` command displays the startup configuration file. The command is supported in Privileged EXEC mode.

Example

Type `show startup-config` to display the startup configuration file. The response in the example is truncated to display only the ip route configured in Admin Username.

```
switch#show startup-config
! Command: show startup-config
! Startup-config last modified at Wed Feb 19 08:34:31 2014 by admin
!

!
ip route 0.0.0.0/0 192.0.2.1
!

end
switch#
```

1.1.7 Other Command-Line Interfaces

EOS can access other CLIs that provide switch commands, files, and services. .

- [About Command-Line Interface](#) describes the boot-loader CLI
- [Bash Shell](#) describes the Bash shell CLI.

1.1.7.1 About Command-Line Interface

About is the switch boot loader. It reads a configuration file from the internal flash or a USB flash drive and attempts to boot a software image.

The switch opens an About shell if the switch does not find a software image, the configuration is corrupted, or the user terminates the boot process. The About shell provides a CLI for manually booting a software image, recovering the internal flash to its default factory state, running hardware diagnostics, and managing files.

1.1.7.2 Bash Shell

The switch provides a Linux Bash shell for accessing the underlying Linux operating system and extensions. The Bash shell is accessible in all command modes except EXEC. [Mode Types](#) describes EOC command modes.

- To enter the Bash, type **bash** at the prompt.

```
switch#bash
Arista Networks EOS shell
[admin@Switch ~]$
```

- To exit the Bash, type **logout**, **exit**, or **Ctrl-D** at the Bash prompt.

```
[admin@Switch ~]$ logout
switch#
```

1.1.8 Directory Structure

EOS operates from a flash drive root mounted as the **/mnt/flash** directory on the switch. The EOS CLI supports these file and directory commands:

- **delete**: Delete a file or directory tree.
- **copy**: Copy a file.
- **more**: Display the file contents.
- **diff**: Compares the contents of files located at specified URLs.
- **rename**: Rename a file
- **cd**: Change the current working directory.
- **dir**: Lists directory contents, including files and subdirectories.
- **mkdir**: Create a directory.
- **rmdir**: Remove a directory.
- **pwd**: Display the current working directory.

Verify flash memory space before copying a file. When a file is copied to flash, it is first written to a temporary file and then renamed to the destination rather than directly overwriting the destination file. This protects the integrity of the existing file if the **copy** command is interrupted, but requires more free space to complete the process.

Switch directory files are accessible through the Bash shell and About. When entering the Bash shell from the switch, the working directory is located in **/home** and has the name of the user name from which Bash was entered.

Example

- These commands were entered from the user name john:

```
switch#bash
[john@switch ~]$ pwd
/home/john
[john@switch ~]$
```

In this instance, the working directory is **/home/john**

When a flash drive is inserted in the USB flash port, flash drive contents are accessible through **/mnt/usb1**.

When entering About, the working directory is the root directory of the boot.

1.1.9 Command-Line Interface Commands

Mode Navigation Commands

- [alias](#)
- [bash](#)
- [configure \(configure terminal\)](#)
- [copy running-config](#)
- [daemon](#)
- [disable](#)
- [enable](#)
- [end](#)
- [exit](#)

File Transfer Commands

- [ip ftp client source-interface](#)
- [ip http client local-interface](#)
- [ip ssh client source-interface](#)
- [ip tftp client source-interface](#)

File Management Commands

- [configure checkpoint](#)
- [configure network](#)
- [copy running-config](#)
- [dir](#)
- [pwd](#)

Modular Switch Platform Commands

- [platform arad lag mode](#)
- [platform sand fabric mode \(7500 and 7500E Series\)](#)
- [platform sand forwarding mode \(7500 and 7500E Series\)](#)
- [platform sand lag hardware-only](#)
- [show platform sand compatibility](#)
- [show platform sand lag hardware-only](#)

CLI Scheduling Commands

- [schedule](#)
- [schedule config](#)
- [show schedule](#)

Event Handler Commands

- [action bash](#)
- [delay](#)
- [event-handler](#)
- [event-handler DropCountersHandler](#)
- [show event-handler](#)
- [show event-handler DropCountersHandler](#)
- [trigger](#)

Terminal Parameter Commands

- [terminal length](#)
- [terminal monitor](#)

Display and Comment Commands

- [comment \(various configuration modes\)](#)
- [show \(various configuration modes\)](#)
- [show module](#)
- [show version](#)

1.1.9.1 action bash

The **action bash** command specifies a Bash shell command to be run when an event handler is triggered. When an event handler is triggered, execution of the associated shell command is delayed by a configurable period set by the **delay** command. Only a single Bash command may be configured for an event handler, but the command may have multiple arguments. If more than one Bash command must be executed in response to a trigger, create a script containing the desired commands and enter the file path to the script as the argument of the **action bash** command.

To specify the event that will trigger the action, use the **trigger** command.

If the event handler uses an **on-intf** trigger, the following environment variables are passed to the action and can be used as arguments to the Bash command:

- **\$INTF** interface name.
 - **\$OPERSTATE** current operational status of the specified interface.
 - **\$IP-PRIMARY** current primary IP address of the specified interface.

Event-Handler Configuration

Command Syntax

`action bash command`

Parameters

- *command* Bash shell command to be executed when the event handler is triggered.

Examples

- This command configures the event handler “onStartup” to run a script on the flash drive.

```
switch(config-handler-onStartup) #action bash /mnt/flash/myScript1
switch(config-handler-onStartup) #
```

- This command configures the event handler “eth_4” to send email to the specified address when there is a change in the operational status of *Ethernet interface 4*.

```
switch(config-event-eth_4) #action bash email x@yz.com -s "Et4
$OPERSTATE"
switch(config-event-eth_4) #
```

The above action uses the **\$OPERSTATE** variable to include the current operational state (“linkup” or “linkdown”) in the subject of the email. Note that the action will only function if email has been configured on the switch.

1.1.9.2 alias

The **alias** command creates an alias for a CLI command. Entering the alias in the CLI executes the corresponding command. Once created, an alias is accessible in all modes and all user sessions, but is subject to all the restrictions of the original command.

When using a command alias, no tokens may precede the alias except the **no** and default keywords. However, an alias can incorporate positional parameters.

In online help, aliases are preceded by an asterisk (*) in this format:

```
*alias_name=command_name
```

The **no alias** and **default alias** commands remove the specified alias.

Command Mode

Global Configuration

Command Syntax

```
alias alias_name command_name
```

```
no alias alias_name
```

```
default alias alias_name
```

Parameters

- *alias_name* the string which is to be substituted for the original command. The string can include letters, numbers, and punctuation, but no spaces. If the *alias_name* string is identical to an existing command, the alias will supercede the original command.
- *command_name* the command which is to be executed when the alias is entered in the CLI. If the original command requires additional parameters, they must be included in the *command_name* string in the following manner:

Positional parameters are of the form "%n" and must be whitespace-delimited. The first parameter is represented by "%1" and any additional parameters must be numbered sequentially. When executing the alias a value must be entered for each parameter or the CLI will display the error "% incomplete command".

Examples

- This command makes **e** an alias for the command **enable**.

```
switch(config)#alias e enable
```

- This command makes **srie** an alias for the command **show running-config interface ethernet 1-6**.

```
switch(config)#alias srie show running-config interface ethernet 1-6
```

- These commands make **ss** an alias for the command **show interfaces ethernet <range> status** with a positional parameter for the port range, then use the alias to display the status of ports 4/1-4/5.

```
switch(config)#alias ss show interfaces ethernet %1 status
switch(config)#ss 4/1-4/5
Port      Name      Status      Vlan      Duplex  Speed  Type
Et4/1     Name      connected   in Po1    full    10000  10GBASE-SRL
Et4/2     Name      notconnect  in Po1    full    10000  10GBASE-SRL
Et4/3     Name      notconnect  1         full    10000  10GBASE-SRL
Et4/4     Name      notconnect  1         full    10000  10GBASE-SRL
Et4/5     Name      notconnect  1         full    10000  10GBASE-SRL
```

1.1.9.3 bash

The **bash** command starts the Linux Bash shell. The Bash shell gives you access to the underlying Linux operating system and system extensions.

To exit the Bash, type **logout**, **exit**, or **Ctrl-D** at the Bash prompt.

Command Mode

Privileged EXEC

Command Syntax

bash

Examples

- This command starts the Bash shell.

```
switch#bash
Arista Networks EOS shell
[admin@switch ~]$
```

- This command, executed within Bash, exits the Bash shell.

```
[admin@switch ~]$ logout
switch#
```

1.1.9.4 comment (various configuration modes)

The **comment** command adds a comment for the active configuration mode to **running-config**. Comments cannot be modified, but can be replaced by entering the **comment** command again and entering new text. To append to an existing comment, enter **!!** followed by additional comment text. To display comments, use the **comment** option of the [show \(various configuration modes\)](#) command.

The **no comment** and **default comment** commands remove the comment from **running-config**.

Comments cannot be added to the global configuration mode through the EOS.

Command Mode

All configuration modes except Global Configuration

Command Syntax

```
comment comment_text EOF
```

```
no comment
```

```
default comment !! comment_text
```

Parameters

- *comment_text* To create a comment, enter a message when prompted. The message may span multiple lines.
- EOF To end a comment, type EOF on its own line (case sensitive) and press **enter**.

Example

- This command adds a comment to the active configuration mode.

```
switch(config-sg-radius-RAD-SV1)#comment
Enter TEXT message. Type 'EOF' on its own line to end.
Consult Thomas Morton before making changes to the RADIUS configuration
.
EOF
switch(config-sg-radius-RAD-SV1)#
```

- This command appends a line to the comment for the active configuration mode.

```
switch(config-sg-radius-RAD-SV1)#!! x3452
switch(config-sg-radius-RAD-SV1)#
```

1.1.9.5 **configure (configure terminal)**

The **configure** command places the switch in the Global Configuration mode to configure features at the system level. You can move to Interface Configuration mode and protocol-specific mode from the Global Configuration mode. The command may also be entered as `configure terminal`.

Command Mode

Privileged EXEC

Command Syntax

```
configure [terminal]
```

Example

- This command places the switch in the Global Configuration mode.

```
switch>enable  
switch#configure  
switch(config)#
```

1.1.9.6 configure checkpoint

The **configure checkpoint** command saves the running configuration to a checkpoint file. This checkpoint file can be used for restoring the current running configuration in future, if required.

Command Mode

Privileged EXEC

Command Syntax

```
configure checkpoint {restore checkpoint_name | save [checkpoint_name]}
```

Parameters

- *restore checkpoint_name* restores the running configuration from the specified checkpoint file.
- *save checkpoint_name* saves running configuration to the specified checkpoint file.

Guidelines

If the filename already exists, EOS overwrites the filename. If the command is entered without a checkpoint name, the switch automatically saves the checkpoint under the name ckp-date-number where date is the date in YYYYMMDD format and number increments by one for each automatically named checkpoint file.

Examples

- This command saves **running-config** to the *ca_test* checkpoint file.

```
switch#configure checkpoint save ca_test
```

- This command restores the **running-config** from the *ca_test* checkpoint file.

```
switch#configure checkpoint restore ca_test
! Preserving static routes. Use 'no ip routing delete-static-routes' to
clear
them.
```

- This command saves **running-config** to the *13Aug2018* checkpoint file. The *dir* command shows the contents of the checkpoint directory.

```
switch#configure checkpoint save
switch#dir checkpoint:
Directory of checkpoint:/
-rw-          7426          Aug 13 12:00  ckp-20180813-17
-rw-          7588          Aug 13 12:10  ckp-20180813-18
-rw-          8499          Aug 13 12:13  ckp-20180813-19
-rw-          8499          Aug 13 12:13  ckp-20180813-20
```

1.1.9.7 **configure convert**

The **configure convert** command converts the current configuration syntax to the specified syntax.

Command Mode

Privileged EXEC

Command Syntax

```
configure convert new-syntax
```

Parameter

new-syntax converts **running-config** to the current version of EOS.

Example:

This command converts running-config to the current version of EOS.

```
switch#configure convert new-syntax

WARNING!
Converting existing configuration to new syntax will lose backward
compatibility.
Make sure you won't downgrade to releases that only support the old
syntaxes.

Proceed [ y/n ]
```

1.1.9.8 **configure network**

The **configure network** command is deprecated. Use the **copy <url> running-config** command to configure the switch from a local file or network location.

1.1.9.9 copy running-config

The current operating configuration of the switch is stored in a virtual file called running-config. The copy running-config command saves the contents of the running-config virtual file to a new location.

Command Mode

Privileged EXEC

Command Syntax

copy running-config DESTINATION

Parameters

- **DESTINATION** destination for the contents of the running-config file. Values include:
 - **startup-config** the configuration file that the switch loads when it boots.

The **copy running-config**, **startup-config**, and **write** commands are equivalent.

- **file:** a file in the switch file directory.
- **flash:** a file in flash memory.
- **url** any valid URL.

The **copy running-config url** and **write network url** commands are equivalent.

Examples

- This command copies running-config to the startup-config file.

```
switch#copy running-config startup-config
switch#
```

- This command copies running-config to a file called *rc20110617* in the dev subdirectory of the switch directory.

```
switch#copy running-config file:dev/rc20110617
switch#
```

1.1.9.10 daemon

The **daemon** command accesses daemon configuration mode for adding or removing external daemons and scripts, which are then managed by ProcMgr.

The **no daemon** and **default daemon** commands delete the daemon by removing the corresponding **daemon** command from *running-config*.

Command Mode

Global Configuration

Command Syntax

```
daemon daemon_name
```

```
no daemon daemon_name
```

```
default daemon daemon_name
```

Parameters

- *daemon_name* label that references the daemon configuration mode.

Example

These commands enters daemon configuration mode and initiates the daemon script.

```
switch(config)#daemon process1
switch(config-daemon-process1)#command process-script -i -m
switch(config-daemon-process1)#
```

1.1.9.11 **delay**

The **delay** command specifies the time in seconds the system will delay between a triggering event and the execution of an event handler action. The default delay is 20 seconds.

Command Mode

Event-Handler Configuration

Command Syntax

`delay seconds`

Parameters

seconds number of seconds to delay before executing the action. The default is 20.

Example

This command configures the event handler Eth5 to delay 10 seconds before executing.

```
switch(config-handler-Eth5)#delay 10  
switch(config-handler-Eth5)#
```

1.1.9.12 dir

The `dir` command displays a list of files on a file system.

Command Mode

Privileged EXEC

Command Syntax

```
dir [SCOPE][FILE TYPE]
```

Parameters

- SCOPE the files to display. Options include
 - `<no parameter>` lists normal files in current directory.
 - `/all` list all files, including hidden files.
 - `/recursive` list files recursively.
- FILE TYPE The options include:
 - `<no parameter>` lists undeleted files.
 - `all_filesystems` list files on all filesystems including deleted files, undeleted files, and files with errors.
 - `extensions` directory or file name.
 - `file` directory or file name.
 - `flash` directory or file name.
 - `supervisor-peer` directory or file name.
 - `system` directory or file name.
 - `usb1` directory or file name.

Example

This command displays the flash directory.

```
switch# dir flash:
Directory of flash:/

-rwx  293409892      Oct 23 08:55  EOS-4.11.0.swi
-rwx  221274543      Sep  6 13:37  EOS-4.7.5.swi
-rwx  271453650      Sep  4 19:13  EOS_4.10.1-SSO.swi
-rwx   135168        Dec 31  1979  FSCK0000.REC
-rwx         26      Oct 23 13:51  boot-config
-rwx   8570          Sep 10 12:22  cfg_sso_mst
-rwx   5642          Sep 20 10:35  config.reset
drwx  4096          Oct 23 13:59  debug
-rwx    12          Oct 23 13:56  kernel-params
drwx  4096          Oct 23 14:59  persist
drwx  4096          Sep  6 14:50  schedule
-rwx   5970          Oct 23 13:53  startup-config

switch#
```

1.1.9.13 **disable**

The **disable** command exchanges the session's current command mode with the specified privilege level.

Command Mode

Privileged EXEC

Command Syntax

```
disable [PRIVILEGE_LEVEL]
```

Parameters

PRIVILEGE_LEVEL Session's new privilege level. Value ranges from 0 to 15. Levels 2 through 15 place the switch in Privileged EXEC mode. Values of 0 or 1 leave the switch in EXEC mode.

- *<no parameter>* Session is assigned default level of 1.
- **<0 to 15>** Specifies session level.

Restrictions

New privilege level must be less than the session's current level.

Example

This command exits Privileged EXEC mode level of 15 to enter EXEC mode level 1.

```
switch# disable  
switch>
```

1.1.9.14 enable

The **enable** command places the switch in Privileged EXEC mode. If an **enable** password is set, the CLI displays a password prompt when a user enters the **enable** command. If the user enters an incorrect password three times, the CLI displays the EXEC mode prompt.

To set a local **enable** password, use the **enable** password command.

Command Mode

EXEC

Command Syntax

```
enable [PRIVILEGE_LEVEL]
```

Parameters

- **PRIVILEGE_LEVEL** Session's privilege level. Values range from 0 to 15. Values of 0 or 1 places the switch in EXEC mode. Any level above 1 leaves the switch in Privileged EXEC mode.
 - *<no parameter>* Session is assigned default level of 15.
 - **<0 to 15>** Specifies session level.

Example

This command places the switch in Privileged EXEC mode with the default privilege level of 15.

```
switch>enable  
switch#
```

1.1.9.15 end

The **end** command exits to Privileged Exec mode from any Configuration mode. If the switch is in a group-change mode (such as ACL-Configuration mode or MST-Configuration mode), the **end** command also saves all pending changes made in that mode to **running-config**.

Command Mode

All configuration modes

Command Syntax

```
end
```

Example

This command exits to Privileged Exec mode.

```
switch(config-if-Et25) #end  
switch#
```

1.1.9.16 event-handler DropCountersHandler

The **event-handler DropCountersHandler** command enables the adverse drop counters monitor with event handlers. The DropCountersHandler event handler is enabled by default, and can be customized for duration of time window and threshold levels.

The **no event-handler DropCountersHandler** command disables the adverse drop counters monitor with event handlers. The **default event-handler DropCountersHandler** command resets the DropCountersHandler event handler to the system default.

Command Mode

Global Configuration

Command Syntax

```
event-handler DropCountersHandler
no event-handler DropCountersHandler
default event-handler DropCountersHandler
```

Examples

- These commands customize the delay, polling interval, and condition for width (-w), violation count (-c), and threshold (-t) of this event handler. Each parameter may be customized separately, with all other parameters remaining unchanged.

```
switch(config)#event-handler DropCountersHandler
switch(config-DropCountersHandler)#action bash DropCounterLog.py -l
switch(config-DropCountersHandler)#delay 0
switch(config-DropCountersHandler)#trigger on-counters
switch(config-DropCountersHandler-counters)#poll interval 60
switch(config-DropCountersHandler-counters)#condition
bashCmd."DropCounterMonitor.py" -w 800" > 0
switch(config-DropCountersHandler-counters)#condition
bashCmd."DropCounterMonitor.py" -c 5" > 0
switch(config-DropCountersHandler-counters)#condition
bashCmd."DropCounterMonitor.py" -t 200" > 0
switch(config-DropCountersHandler-counters)#
```

- This command disables this event handler.

```
switch(config)#no event-handler DropCountersHandler
switch(config)#
```

1.1.9.17 event-handler

An event handler executes a Linux Bash shell command in response to a specific system event. An event handler consists of a Bash command, a trigger and a delay; when the trigger event occurs, the action is scheduled to run after *delay* seconds.

The **event-handler** command places the switch in event-handler configuration mode for the specified event handler. If the named event handler does not already exist, this command creates it. Event-handler configuration mode is a group change mode that configures event handlers.

Changes made in a group change mode are saved by leaving the mode through the **exit** command or by entering another configuration mode.

These commands are available in event-handler configuration mode:

- [action bash](#)
- [delay](#)
- [trigger](#)

The **no event-handler** and **default event-handler** commands delete the specified event handler by removing it from *running config*.

Command Mode

Global Configuration

Command Syntax

```
event-handler name
```

```
no event-handler name
```

```
default event-handler name
```

Parameters

name name of the event handler to be configured. If the named event handler does not already exist, this command will create it.

Example

This command places the switch in event-handler configuration mode for an event handler called "Eth_5".

```
switch(config)#event-handler Eth_5
switch(config-handler-Eth_5)#
```

1.1.9.18 exit

The exit command places the switch in the parent of the command mode from which the exit command was entered.

- When used in Global configuration, the switch enters Privileged EXEC mode.
- When used in EXEC or Privileged EXEC mode, the `exit` command terminates the user session.
- When the command is used in a group-change mode (such as ACL-Configuration mode or MST-Configuration mode), the `exit` command also applies all pending changes made in that mode.

Command Mode

All modes

Command Syntax

```
exit
```

Examples

- This command exits Global Configuration mode to Privileged EXEC mode.

```
switch(config)#exit  
switch#
```

- This command terminates the user session.

```
switch#exit
```

1.1.9.19 ip ftp client source-interface

By default, the FTP (File Transfer Protocol) source IP address is selected by the switch (the IP address of the source interface if one is assigned). The `ip ftp client source-interface` command allows the user to override the default FTP source address.

The `ip ftp client source-interface` and `ip ftp source-interface` commands are functionally equivalent. In each case, `ip ftp client source-interface` is stored in *running-config*.

The `no ip ftp client source-interface` and `default ip ftp client source-interface` commands restore default behavior by removing the `ip ftp client source-interface` statement from *running-config*.

Command Mode

Global Configuration

Command Syntax

```
ip ftp [client] source-interface INTERFACE [vrf vrf_name]
```

```
no ip ftp [client] source-interface
```

```
default ip ftp [client] source-interface
```

Parameters

- *client* Parameter has no functional effect.
- INTERFACE Interface providing the IP address. Options include:
 - ethernet *e_num* Ethernet interface specified by *e_num*.
 - loopback *l_num* Loopback interface specified by *l_num*.
 - management *m_num* Management interface specified by *m_num*.
 - port-channel *p_num* Port-channel interface specified by *p_num*.
 - tunnel *t_num* Tunnel interface specified by *t_num*.
 - vlan *v_num* VLAN interface specified by *v_num*.
- *vrf vrf_name* Uses the specified user-defined VRF.

Examples

- These commands configure the `10.10.121.15` as the source IP address the switch uses when communicating with FTP servers.

```
switch(config)#interface ethernet 17
switch(config-if-Et17)#ip address 10.10.121.15/24
switch(config-if-Et17)#ip ftp client source-interface ethernet 17
switch(config)#
```

- This command configures the switch to use `interface tunnel 45` and `vrf vrf01` when communicating with FTP servers.

```
switch(config)#ip ftp client source-interface tunnel 45 vrf vrf01
switch(config)#
```

1.1.9.20 ip http client local-interface

The **ip http client local-interface** command specifies the source IP address for hypertext transfer protocol (HTTP) connections. By default, the source IP address is selected by the switch when this command is not configured or when the specified interface is not assigned an IP address.

The **no ip http client local-interface** and **default ip http client local-interface** commands restore default behavior by removing the **ip http client local-interface** statement from *running-config*.

Command Mode

Global Configuration

Command Syntax

```
ip http client local-interface INTERFACE [vrf vrf_name]
```

```
no ip http client local-interface
```

```
default ip http client local-interface
```

Parameters

- **INTERFACE** Interface providing the IP address. Options include:
 - ethernet *e_num* Ethernet interface specified by *e_num*.
 - loopback *l_num* Loopback interface specified by *l_num*.
 - management *m_num* Management interface specified by *m_num*.
 - port-channel *p_num* Port-channel interface specified by *p_num*.
 - vlan *v_num* VLAN interface specified by *v_num*.
- vrf *vrf_name* Uses the specified user-defined VRF.

Examples

- These commands configure the *10.15.17.9* as the source IP address the switch uses when communicating with HTTP servers.

```
switch(config)#interface vlan 10
switch(config-if-Vl10)#ip address 10.15.17.9/24
switch(config-if-Vl10)#ip http client local-interface vlan 10
switch(config)#
```

- This command configures the switch to use *interface tunnel 45* and *vrf vrf01* when communicating with HTTP servers.

```
switch(config)#ip http client local-interface tunnel 45 vrf vrf01
switch(config)#
```

1.1.9.21 ip ssh client source-interface

The **ip ssh client source-interface** command specifies the source IP address for secure shell (SSH) connections. By default, the source IP address is selected by the switch when this command is not configured or when the specified interface is not assigned an IP address.

The **ip ssh client source-interface** and **ip ssh source-interface** commands are functionally equivalent. In each case, **ip ssh client source-interface** is stored in **running-config**.

The **no ip ssh client source-interface** and **default ip ssh client source-interface** commands restore default behavior by removing the **ip ssh client source-interface** statement from **running-config**.

Command Mode

Global Configuration

Command Syntax

```
ip ssh [client] source-interface INTERFACE [vrf vrf_name]
```

```
no ip ssh [client] source-interface
```

```
default ip ssh [client] source-interface
```

Parameters

- **client** Parameter has no functional effect.
- **INTERFACE** Interface providing the IP address. Options include:
 - **ethernet e_num** Ethernet interface specified by *e_num*.
 - **loopback l_num** Loopback interface specified by *l_num*.
 - **management m_num** Management interface specified by *m_num*.
 - **port-channel p_num** Port-channel interface specified by *p_num*.
 - **vlan v_num** VLAN interface specified by *v_num*.
- **vrf vrf_name** Uses the specified user-defined VRF.

Examples

- These commands configure the *10.17.17.9* as the source IP address the switch uses when communicating with SSH servers.

```
switch(config)#interface vlan 10  
switch(config-if-Vl10)#ip address 10.17.17.9/24  
switch(config-if-Vl10)#ip ssh client source-interface vlan 10  
switch(config)#
```

- This command configures the switch to use *interface tunnel 45* and *vrf vrf01* when communicating with SSH servers.

```
switch(config)#ip ssh client source-interface tunnel 45 vrf vrf01  
switch(config)#
```

1.1.9.22 ip tftp client source-interface

The `ip tftp client source-interface` command specifies the source IP address for Trivial File Transfer Protocol (TFTP) connections. By default, the source IP address is selected by the switch when this command is not configured or when the specified interface is not assigned an IP address.

The `ip tftp client source-interface` and `ip tftp source-interface` commands are functionally equivalent. In each case, `ip tftp client source-interface` is stored in *running-config*.

The `no ip tftp client source-interface` and `default ip tftp client source-interface` commands restore default behavior by removing the `ip tftp client source-interface` statement from *running-config*.

Command Mode

Global Configuration

Command Syntax

```
ip tftp [client] source-interface INTERFACE [vrf vrf_name]
no ip tftp [client] source-interface
default ip tftp [client] source-interface
```

Parameters

- `client` Parameter has no functional effect.
- `INTERFACE` Interface providing the IP address. Options include:
 - `ethernet e_num` Ethernet interface specified by `e_num`.
 - `loopback l_num` Loopback interface specified by `l_num`.
 - `management m_num` Management interface specified by `m_num`.
 - `port-channel p_num` Port-channel interface specified by `p_num`.
 - `vlan v_num` VLAN interface specified by `v_num`.
- `vrf vrf_name` Uses the specified user-defined VRF.

Examples

- These commands configure the `10.15.17.9` as the source IP address the switch uses when communicating with TFTP servers.

```
switch(config)#interface vlan 10
switch(config-if-Vl10)#ip address 10.15.17.9/24
switch(config-if-Vl10)#ip tftp client source-interface vlan 10
switch(config)#
```

- This command configures the switch to use `interface tunnel 45` and `vrf vrf01` when communicating with TFTP servers.

```
switch(config)#ip tftp client source-interface tunnel 45 vrf vrf01
switch(config)#
```

1.1.9.23 platform arad lag mode

The **platform arad lag mode** command allows configuration of LAGs with more than 16 members.

Command Mode

Global Configuration

Command Syntax

```
platform arad lag mode [1024x16 | 256x64 | 512x32]
```

Examples

- This command configures 1024 LAGs with 16 members each.

```
switch(config)#platform arad lag mode 1024x16  
! Change will take effect only after switch reboot.  
switch(config)#
```

- This command configures 256 LAGs with 64 members each.

```
switch(config)#platform arad lag mode 256x64  
! Change will take effect only after switch reboot.  
switch(config)#
```

- This command configures 512 LAGs with 32 members each.

```
switch(config)#platform arad lag mode 512x32  
! Change will take effect only after switch reboot.  
switch(config)#
```

1.1.9.24 platform sand fabric mode (7500 and 7500E Series)

The `platform sand fabric mode` command specifies the fabric mode under which the switch operates after the next system reload. The command has no operational effect until the switch reloads.

The fabric mode determines the modular switch's fabric performance capabilities and must be compatible with the installed fabric modules. Fabric mode settings include:

- fe600: Supports first-generation fabric modules.
- fe1600: Supports E-Series fabric modules.

 **Note:** Switches that reload in **petraA** forwarding compatibility mode ([platform sand forwarding mode \(7500 and 7500E Series\)](#)) also reload in fe600 fabric mode regardless of the presence of a `platform sand fabric mode` statement in *running-config*.

The switch's fabric mode setting must match the capabilities of its installed fabric modules. Reloading the switch in a different mode may be required after exchanging fabric modules for a different module type. The `show module` command displays the fabric modules in the switch.

Each fabric module is categorized as first-generation or E-Series:

- First-generation fabric modules support all basic switch functions.
- E-Series fabric modules support faster fabric link speeds, greater internal table capacities, and advanced encoding formatting.

E-series fabric modules can operate in **fe600** mode, but are limited to first-generation fabric performance. First-generation modules cannot operate in **fe600** mode. Switches containing both types of modules must be set to **fe600** mode. Best practice is to avoid switch configurations with mixed fabric modules.

When a switch reloads, fabric mode is determined by the following (in order of precedence):

1. Switches reloading in **petraA** forwarding compability mode also reload in **fe600** fabric mode .
2. As specified by the `platform sand fabric mode` statement in *running-config*.
3. The first fabric module that becomes operational as the switch reloads.

In switches with a homogeneous module set, the fabric mode matches its fabric modules. Switches with a mixed set of modules are typically reloaded in **fe600** mode because first generation modules are usually operational before E-Series modules. However, the fabric mode in mixed module switches that are reloading cannot be guaranteed in the absence of the first two conditions.

The `no platform sand fabric mode` and `default platform sand fabric mode` commands remove the `platform sand fabric mode` command from *running-config*.

Command Mode

Global Configuration

Command Syntax

```
platform sand fabric mode [MODE_SETTING]
```

```
no platform sand fabric mode
```

```
default platform sand fabric mode
```

Parameters

- **MODE_SETTING** Specifies the switch's fabric mode. Options include:
 - **fe16000** E-Series fabric mode.
 - **fe600** First-generation fabric mode.

Example

This command configures the switch to reload in fe1600 fabric mode to support E-series fabric modules. After issuing this command, the switch should be reset only after exchanging all switch fabric modules to E-series modules.

```
switch(config)#platform sand fabric mode fe1600
switch(config)#exit
switch#show platform sand compatibility
Configuration      Status
Forwarding mode    None              Arad
Fabric mode        Fe1600           Fe600
switch#
```

1.1.9.25 platform sand forwarding mode (7500 and 7500E Series)

The **platform sand forwarding mode** command specifies the forwarding compatibility mode under which the switch operates after the next system reload. The command has no operational effect until the switch reloads.

Forwarding compatibility mode specifies switch forwarding capabilities and configures performance capacity of installed linecards. Forwarding compatibility modes settings include:

- **petraA**: Supports first-generation fabric modules.
- **arad**: Supports E-Series fabric modules.

 **Note:** Switches that reload in **petraA** forwarding compatibility mode also reload in **fe600** fabric mode regardless of the presence of a [platform sand fabric mode \(7500 and 7500E Series\)](#) statement in *running-config*.

This command may be required after exchanging a linecard for a different module type or in switches containing first-generation and E-series linecards. The [show module](#) command displays the linecard modules in the switch.

Each modular switch linecard module is categorized as first-generation or E-Series:

- First-generation linecards support all basic switch functions.
- E-Series linecards support provide faster data processing, greater internal table capacities, and advanced encoding formatting.

The forwarding compatibility mode determines the operational capacity of installed linecards. The following table lists the affect of the forwarding compatibility mode on all linecard module types.

Table 3: Linecard Module and Forwarding Mode Performance

Linecard Module Type	Forwarding Software Mode	Linecard Operating Capacity
First-generation	petraA	Linecard performs at first-generation performance capacity.
First-generation	arad	Linecard is powered-down.
E-Series	petraA	Linecard performs at first-generation performance capacity.
E-Series	arad	Linecard performs at E-series performance capacity.

 **Note:** Linecards operate at E-Series performance capacities only on switches that contain E-Series fabric modules and have a fabric mode setting of **fe1600** fabric mode (platform sand fabric mode (7500 and 7500E Series)).

Without a [platform sand fabric mode \(7500 and 7500E Series\)](#) command, forward compatibility mode is determined by the first linecard that becomes operational after reloading the switch. In a switch that is reloaded with a homogeneous module set, forwarding compatibility mode matches its linecards. Switches with a mixed set of modules are typically reloaded in **petraA** mode because first generation modules are usually operational before E-Series modules. However, forwarding compatibility mode in mixed module switches that are reloading is not guaranteed without a **platform sand forwarding mode** command.

The **no platform sand forwarding mode** and **default platform sand forwarding mode** commands restore the **platform sand forwarding mode** command from *running-config*.

Command Mode

Global Configuration

Command Syntax

```
platform sand forwarding mode [MODE_SETTING]
no platform sand forwarding mode
default platform sand forwarding mode
```

Parameters

- **MODE_SETTING** Specifies the switch's software forwarding mode. Options include:
 - **arad** the switch supports E-Series linecard capabilities.
 - **petraA** the switch supports first-generation linecard capabilities.

Example

This command changes the forwarding software mode to support E-series linecard modules. This command should be run only after exchanging all linecards to E-series modules.

```
switch(config)#platform sand forwarding mode arad
switch(config)#
```

1.1.9.26 platform sand lag hardware-only

The **platform sand lag hardware-only** command specifies that all LAGs will use hardware resources including single member LAGs. Hardware resource allocation and deallocation traffic disruption occurs on the first member addition or deletion, rather than the second member addition or deletion.

The **no platform sand lag hardware-only** and **default platform sand lag hardware-only** commands specify that LAGs are not required to be implemented in hardware, and therefore some LAGs may be implemented in software. Permitting both hardware and software LAGs may increase the total number of port-channels because we have no resource limit on the number of software LAGs.

Command Mode

Global Configuration

Command Syntax

```
platform sand lag hardware-only
no platform sand lag hardware-only
default platform sand lag hardware-only
```

Examples

- This command configures all LAGs to use hardware resources. All existing one member LAGs will be allocated hardware resources, when available.

```
switch(config)#platform sand lag hardware-only
switch(config)#
```

- This command allows certain LAGs (single member LAGs) to not consume hardware resources. All existing one member LAGs will release their hardware resources.

```
switch(config)#no platform sand lag hardware-only
switch(config)#
```

1.1.9.27 **pwd**

The **pwd** command displays the working directory.

Command Mode

Privileged EXEC

Command Syntax

pwd

Example

This command shows that the working is Flash.

```
switch# pwd  
flash:/  
switch#
```

1.1.9.28 schedule config

The `schedule config` command sets configuration parameters to the CLI scheduler.

The `no schedule config max-concurrent-jobs` and `default schedule config max-concurrent-jobs` commands reset the limit of maximum concurrent jobs to the default value of 1 by removing the corresponding `schedule config max-concurrent-jobs` statement from `running-config`.

The `no schedule config prepend-hostname-logfile` and `default schedule config prepend-hostname-logfile` commands reset the log filenames to the default state.

Command Mode

Global Configuration

Command Syntax

```
schedule config{max-concurrent-jobs limit | prepend-hostname-logfile}
```

```
no schedule config {max-concurrent-jobs limit | prepend-hostname-logfile}
```

```
default schedule config {max-concurrent-jobs limit | prepend-hostname-logfile}
```

Parameters

- `max-concurrent-jobs limit` specifies the maximum number of concurrent commands that can run on the switch. The maximum concurrent jobs ranges from 1 to 4. The default value is 1.
- `prepend-hostname-logfile` enables prepending hostnames to log filenames. By default, this option is enabled.

Examples

- This command configures to concurrently run a maximum of three commands on the switch.

```
switch(config)#schedule config max-concurrent-jobs 3
switch(config)#show schedule summary
Maximum concurrent jobs 3
Prepend host name to logfile: No
Name          At time      Last      Interval  Timeout  Max      Logfile Location
Status
              time      (mins)    (mins)    log
              files
-----
-----
tech-support  now         00:29     60        30       100     flash:schedule/tech-support/
Success
thelp        12:02:00   00:02     60        40       100     flash:schedule/thelp/
Fail
              06/05/2018
switch(config)#
```

- This command enables prepending the hostname to log filenames.

```
switch(config)#schedule config prepend-hostname-logfile
switch(config)#show schedule summary
Maximum concurrent jobs 3
Prepend host name to logfile: Yes
Name          At time      Last      Interval  Timeout  Max      Logfile Location
Status
              time      (mins)    (mins)    log
              files
-----
-----
tech-support  now         00:29     60        30       100     flash:schedule/tech-support/
Success
thelp        12:02:00   00:02     60        40       100     flash:schedule/thelp/
Fail
              06/05/2018
switch(config)#
```

1.1.9.29 schedule

The `schedule` command facilitates the periodic execution of a specified CLI command. Command parameters configure the start time of periodic execution, the interval between consecutive execution instances, the maximum time allotted for command execution, and the maximum number of log files that can be created.

The `no schedule` and `default schedule` commands disable execution of the specified command.

Command Mode

Global Configuration

Command Syntax

```
schedule schedule_name PERIOD {max-log-files count | timeout timeout_interval}{command cmd | logging verbose | loglocation flash;}  
no schedule schedule_name
```

```
no schedule schedule_name
```

```
default schedule schedule_name
```

Parameters

- *schedule_name* Label associated with the scheduled command.
- PERIOD Start time for execution and interval between consecutive execution instances. The interval ranges from 2 to 1440 minutes. The default interval while scheduling the `show tech-support` command is 60 minutes. Options include:
 - at Start time for execution. Options include:
 - *hh:mm:ss interval interval* The command execution starts at the specified time and repeats at the specified interval.
 - *hh:mm:ss mm/dd/yyyy interval interval* The command execution starts at the specified time on the specified day and repeats at the specified interval.
 - *hh:mm:ss once* The command execution starts at the specified time and does not repeat.
 - *hh:mm:ss mm/dd/yyyy once* The command execution starts at the specified time on the specified day and does not repeat.
 - *hh:mm:ss yyyy-mm-dd interval interval* The command execution starts at the specified time on the specified day and repeats at the specified interval.
 - *hh:mm:ss yyyy-mm-dd once* The command execution starts at the specified time on the specified day and does not repeat.
 - interval *interval* The command execution starts immediately and repeats at the specified interval.
 - now interval *interval* The command execution starts immediately and repeats at the specified interval.
- max-log-files *count* Maximum number of log files command generates for command output. The count of maximum log files ranges from 1 to 10000. The default count of maximum log files while scheduling the `show tech-support` command is 100.
- timeout *timeout_interval* Maximum time allotted for the script execution. The timeout interval ranges from 1 to 480 minutes. The default timeout is 30 minutes.
 - 📌 **Note:** The command execution is terminated if it exceeds the specified timeout interval. The timeout allotted for the scheduled command must not be greater than the corresponding interval.
- command *cmd* The command that needs to be executed.
- logging verbose Sets the logging level to “verbose.” A syslog entry is added after the execution of the scheduled command, regardless of whether the scheduled command has succeeded or failed. In the absence of **logging verbose**, the syslog entry is added only if the execution of the scheduled command fails with an error.
- loglocation *destination* The flash destination for scheduled command output files.

Guidelines

Log files created by the command are stored in the **flash:/schedule/ *scheduled_name* /** directory. Empty log files are created for commands that do not generate any output.

Examples

- This command saves the running configuration contents to the log file every hour with immediate effect and creates a maximum of 24 log files.

```
switch(config)#schedule backup-test interval 60 max-log-files 24
command show running-config
```

- This command starts the script execution at 12:00:00 and repeats every 720 minutes. The script execution is terminated if it exceeds 20 minutes. It generates a maximum of one log file because the specified bash command does not have an output.

```
switch(config)#schedule ms1 at 12:00:00 interval 720 timeout 20 max-
log-files 1 command bash /mnt/flash/myscript.sh
```

- The [show schedule](#) command lists the commands currently scheduled for periodic execution and displays the summary of the specified scheduled command.

```
switch#show schedule summary
Maximum concurrent jobs 1
Prepend host name to logfile: Yes

Name At time Last Interval Timeout Max Logfile Location Status
-----
ms1 now 23:03 720 20 1 flash:/schedule/ms1 Success

switch#
```

1.1.9.30 show (various configuration modes)

The **show** command, when executed within a configuration mode, can display data in *running-config* for the active configuration mode.

Command Mode

All configuration modes except Global Configuration

Command Syntax

```
show [DATA_TYPE]
```

Parameters

- **DATA_TYPE** Specifies display contents. Values include:
 - **active** Displays running-config settings for the configuration mode.
 - **active all** Displays running-config plus defaults for the configuration mode.
 - **active all detail** Displays running-config plus defaults for the configuration mode.
 - **comment** Displays comment entered for the configuration mode.

Related Commands

The **show** commands in ACL-configuration mode and MST-configuration mode include the **active** and **comment** options along with additional mode-specific options.

Example

This command shows the server-group-TACACS+ configuration commands in *running-config*.

```
switch(config-sg-tacacs+-TAC-GR) #show active
  server TAC-1
  server 10.1.4.14
switch(config-sg-tacacs+-TAC-GR) #
```

1.1.9.31 show event-handler DropCountersHandler

The show event-handler command displays details of the DropCountersHandler event handler.

Command Mode

Privileged EXEC

Command Syntax

```
show event-handler DropCountersHandler
```

Example

This command displays details of this event handler.

```
switch(config)#show event-handler DropCountersHandler
Event-handler DropCountersHandler (BUILT-IN)
Trigger: on-counters delay 0 seconds
  Polling Interval: 60 seconds
  Condition: bashCmd."DropCounterMonitor.py" > 0
Threshold Time Window: 0 Seconds, Event Count: 1 times
Action: DropCounterLog.py -l
Action expected to finish in less than 20 seconds
Total Polls: 39
Last Trigger Detection Time: 38 minutes 22 seconds ago
Total Trigger Detections: 1
Last Trigger Activation Time: 38 minutes 22 seconds ago
Total Trigger Activations: 1
Last Action Time: Never
Total Actions: 1

switch(config)#
```

1.1.9.32 show event-handler

The show event-handler command displays the contents and activation history of a specified event handler or all event handlers.

Command Mode

Privileged EXEC

Command Syntax

```
show event-handler [handler_name]
```

Parameters

- *handler_name* optional name of an event handler to display. If no parameter is entered, the command displays information for all event handlers configured on the system.

Example

This command displays information about an event handler called “eth_5”.

```
switch#show event-handler Eth_5
Event-handler Eth_5
Trigger: on-intf Ethernet5 on ip delay 20 seconds
Threshold Time Window: 0 Seconds, Event Count: 1 times
Action: :
Device-health Action: None
Action expected to finish in less than 10 seconds
Last Trigger Detection Time: 15 days 2 hours 19 minutes ago
Total Trigger Detections: 1
Last Trigger Activation Time: 15 days 2 hours 19 minutes ago
Total Trigger Activations: 1
Last Action Time: 15 days 2 hours 19 minutes ago
Total Actions: 1
switch#
```

1.1.9.33 show module

The **show module** command displays information that identifies the supervisor, fabric, and linecard modules in a modular switch, including model number, serial number, hardware version number, software version (supervisors only), MAC address (supervisors and linecards), and operational status.

Command Mode

EXEC

Command Syntax

```
show module [MODULE_NAME]
```

Parameters

- **MODULE_NAME** Specifies modules for which data is displayed. Options include:
 - *<no parameter>* All modules (identical to **all** option).
 - *fabric fab_num* Specified fabric module. Number range varies with switch model.
 - *linecard line_num* Linecard module. Number range varies with switch model.
 - *supervisor super_num* Supervisor module. Number range varies with switch model.
 - *mod_num* Supervisor (1 to 2) or linecard (3 to 18) module.
 - *all* All modules.

Related Commands

- [show version](#) displays model and serial numbers of modular system components.

Example

- This command displays information about all installed modules on a DCS-7504 switch.

```
switch#show module
Module   Ports Card Type                               Model                               Serial No.
-----
1        2      DCS-7500 Series Supervisor Module    7500-SUP                           JSH11440327
2        1      Standby supervisor                    Unknown                             Unknown
3        48     48-port SFP+ 10GigE Linecard        7548S-LC                           JSH10315938
4        48     48-port SFP+ 10GigE Linecard        7548S-LC                           JSH11665247
5        48     48-port SFP+ 10GigE Linecard        7548S-LC                           JSH11834614
6        48     48-port SFP+ 10GigE Linecard        7548S-LC                           JSH11060688
Fabric1  0      DCS-7504 Fabric Module              7504-FM                             JSH11244430
Fabric2  0      DCS-7504 Fabric Module              7504-FM                             JSH11892120
Fabric3  0      DCS-7504 Fabric Module              7504-FM                             JSH11941115
Fabric4  0      DCS-7504 Fabric Module              7504-FM                             JSH11661618
Fabric5  0      DCS-7504 Fabric Module              7504-FM                             JSH11757555
Fabric6  0      DCS-7504 Fabric Module              7504-FM                             JSH11847728

Module   MAC addresses                               Hw   Sw   Status
-----
1        00:1c:23:03:06:ac - 00:1c:23:03:06:ac    07.06  4.12.1  Active
2        00:1c:23:03:80:44 - 00:1c:23:03:80:73    06.00  4.12.1  Standby
3        00:1c:23:03:e4:34 - 00:1c:23:03:e4:63    07.10  05.03  Ok
4        00:1c:23:12:0b:3f - 00:1c:23:12:0b:6e    07.30  05.02  Ok
5        00:1c:23:12:b6:3f - 00:1c:23:12:b6:6e    08.00  05.02  Ok
Fabric1  05.03  05.03  Ok
Fabric2  05.02  05.02  Ok
Fabric3  05.02  05.02  Ok
Fabric4  05.02  05.02  Ok
Fabric5  05.02  05.02  Ok
Fabric6  05.02  05.02  Ok
switch#
```

- This command displays information about all installed modules on a DCS-7304 switch.

```
switch#show module
Module   Ports Card Type                               Model                               Serial No.
-----
1        3      Supervisor 7300X SSD                 DCS-7300-SUP-D                     JAS13340024
3        128   32 port 40GbE QSFP+ LC               7300X-32Q-LC                       JPE13440416
4        64    48 port 10GbE SFP+ & 4 port QSFP+ LC 7300X-64S-LC                       JAS13310113
```

5	64	48 port 10GbE SFP+ & 4 port QSFP+ LC	7300X-64S-LC	JAS13340033
6	64	48 port 10GbE SFP+ & 4 port QSFP+ LC	7300X-64S-LC	JAS13310103
Fabric1	0	7304X Fabric Module	7304X-FM	JAS13320077
Fabric2	0	7304X Fabric Module	7304X-FM	JAS13350043
Fabric3	0	7304X Fabric Module	7304X-FM	JAS13350050
Fabric4	0	7304X Fabric Module	7304X-FM	JAS13350056

Module	MAC addresses	Hw	Sw	Status
1	00:1c:73:36:4b:71 - 00:1c:73:36:4b:72	01.01	4.13.3F	Active
3	00:1c:73:58:d4:68 - 00:1c:73:58:d4:87	03.04		Ok
4	00:1c:73:36:05:61 - 00:1c:73:36:05:94	02.02		Ok
5	00:1c:73:36:0a:e1 - 00:1c:73:36:0b:14	02.03		Ok
6	00:1c:73:36:02:e1 - 00:1c:73:36:03:14	02.02		Ok
Fabric1		00.00		Ok
Fabric2		00.00		Ok
Fabric3		00.00		Ok
Fabric4		00.00		Ok
switch#				

1.1.9.34 show platform sand compatibility

The **show sand platform compatibility** command displays the fabric and forwarding modes. These modes determine switch forwarding capabilities and programs performance capacity of installed linecards

Information that identifies the supervisor, fabric, and linecard modules in the modular switch, including model number, serial number, hardware version number, software version (supervisors only), MAC address (supervisors and linecards), and operational status.

Command Mode

Privileged EXEC

Command Syntax

```
show platform sand compatibility
```

Related Commands

- [platform sand fabric mode \(7500 and 7500E Series\)](#) specifies the fabric software mode.
- [platform sand forwarding mode \(7500 and 7500E Series\)](#) specifies the forwarding software mode.

Example

This command indicates that the switch is in Fe600 fabric mode and PetraA forwarding mode.

```
switch#show platform sand compatibility
Configuration      Status
Forwarding mode   None              PetraA
Fabric mode       None              Fe600
switch#
```

1.1.9.35 show platform sand lag hardware-only

The **show platform sand lag hardware-only** command displays whether or not LAGs are hardware-only.

Command Mode

Privileged EXEC

Command Syntax

```
show platform sand lag hardware-only
```

Examples

- This command indicates that LAGs are hardware-only.

```
switch(config)#platform sand lag hardware-only
switch(config)#exit
switch#show platform sand lag hardware-only
Hardware resources are used for all LAGs: True
switch#
```

- This command indicates that LAGs are not hardware-only.

```
switch(config)#no platform sand lag hardware-only
switch(config)#exit
switch#show platform sand lag hardware-only
Hardware resources are used for all LAGs: False
switch#
```

1.1.9.36 show schedule

The **show schedule** command displays logging output on the terminal during the current terminal session. This command affects only the local monitor. The **no terminal monitor** command disables direct monitor display of logging output for the current terminal session.

The **show schedule** command displays the list of active scheduled commands and the summary of specified scheduled command.

Command Mode

Global Configuration

Command Syntax

```
show schedule {schedule_name | summary}
```

Parameters

- *schedule_name* displays the summary of the specified scheduled command
- **summary** displays the list of active scheduled commands

Examples

- This command displays the summary of the “thelp” schedule.

```
switch(config)#show schedule thelp
The last CLI command failed with exit status 1
CLI command "show THelp" is scheduled next at "02:02:35 06/19/2018", interval is
60 minutes
Timeout is 40 minutes
Maximum of 100 log files will be stored
Verbose logging is off
100 log files currently stored in flash:/schedule/thelp

Start time           Size           Filename
-----
Jun 19 2018 01:02    60.0 bytes    ro301_thelp_2018-06-19.0102.log.gz
Jun 19 2018 00:02    60.0 bytes    ro301_thelp_2018-06-19.0002.log.gz
Jun 18 2018 23:02    60.0 bytes    ro301_thelp_2018-06-18.2302.log.gz
Jun 18 2018 22:02    60.0 bytes    ro301_thelp_2018-06-18.2202.log.gz
Jun 18 2018 21:02    60.0 bytes    ro301_thelp_2018-06-18.2102.log.gz

switch(config)#
```

- This command displays the summary of scheduled commands.

```
switch(config)#show schedule summary
Maximum concurrent jobs 1
Prepend host name to logfile: Yes
Name           At time      Last      Interval  Timeout  Max      Logfile Location
Status
                time        (mins)    (mins)    log
                files
-----
tech-support   now         00:29     60         30       100     flash:schedule/tech-support/
Success
thelp          12:02:00   00:02     60         40       100     flash:schedule/thelp/
Fail
06/05/2018
switch(config)#
```

1.1.9.37 show version

The **show version** command displays information that identifies the switch, including its model number, serial number, and system MAC address. The command also provides hardware and software manufacturing information, along with the available memory and elapsed time from the most recent reload procedure.

Command Mode

EXEC

Command Syntax

```
show version [INFO_LEVEL]
```

Parameters

- **INFO_LEVEL** Specifies information the command displays. Options include
 - *<no parameter>* Model and serial numbers, manufacturing data, uptime, and memory.
 - **detail** Data listed *<no parameter>* option plus version numbers of internal components.

Related Command

[show module](#) displays model and serial numbers of modular system components.

Example

This command displays the switch's model number, serial number, hardware and software manufacturing information, uptime, and memory capacity.

```
switch>show version
Arista DCS-7150S-64-CL-F
Hardware version:    01.01
Serial number:      JPE13120819
System MAC address: 001c.7326.fd0c

Software image version: 4.13.2F
Architecture:         i386
Internal build version: 4.13.2F-1649184.4132F.2
Internal build ID:    eeb3c212-b4bd-4c19-ba34-1b0aa36e43f1

Uptime:              1 hour and 36 minutes
Total memory:        4017088 kB
Free memory:         1473280 kB

switch>
```

1.1.9.38 terminal length

The terminal length command overrides automatic pagination and sets pagination length for all show commands on a terminal. If the output of a show command is longer than the configured terminal length, the output will be paused after each screenful of output, prompting the user to continue.

To disable pagination for an SSH session, set terminal length to 0. By default, all console sessions have pagination disabled.

The no terminal length and **default terminal length** commands restore automatic pagination by removing the terminal length command from *running-config*.

The pagination setting is persistent if configured from Global Configuration mode. If configured from EXEC mode, the setting applies only to the current CLI session. Pagination settings may also be overridden when you adjust the size of the SSH terminal window, but can be reconfigured by running the terminal length command again.

Command Mode

EXEC

Command Syntax

```
terminal length lines
```

```
no terminal length
```

```
default terminal length
```

Parameters

lines number of lines to be displayed at a time. Values range from 0 through 32767. A value of 0 disables pagination.

Examples

- This command sets the pagination length for the current terminal session to 10 lines.

```
switch#terminal length 10  
Pagination set to 10 lines.
```

- This command configures the switch to paginate terminal output automatically based on screen size for the current terminal session.

```
switch#no terminal length
```

- These commands disable pagination globally.

```
switch#configure  
switch(config)#terminal length 0  
Pagination disabled.
```

1.1.9.39 terminal monitor

The terminal monitor command enables the display of logging output on the terminal during the current terminal session. This command affects only the local monitor. The no terminal monitor command disables direct monitor display of logging output for the current terminal session.

Command Mode

Privileged EXEC

Command Syntax

```
terminal monitor
```

```
no terminal monitor
```

```
default terminal monitor
```

Example

This command enables the display of logging to the local monitor during the current terminal session.

```
switch#terminal monitor  
switch#
```

1.1.9.40 trigger

The **trigger** command specifies what event will trigger the event handler. Handlers can be triggered either by the system booting or by a change in a specified interface's IP address or operational status.

To specify the action to be taken when the handler is triggered, use the [action bash](#) command.

Command Mode

Event-Handler Configuration

Command Syntax

```
trigger EVENT
```

Parameters

- **EVENT** event which will trigger the configuration mode event handler. Values include:
 - **onboot** triggers when the system reboots, or when you exit event-handler configuration mode. This option takes no further arguments, and passes no environment variables to the action triggered.
 - **on-intf INTERFACE CHANGE** triggers when a change is made to the specified interface.
 - **on-startup-config** triggers when a change is made to the **startup-config** file.
 - **vm-tracer vm** triggers when a virtual machine monitored by VM Tracer changes state.
- **INTERFACE** the triggering interface. Values include:
 - **ethernet number** Ethernet interface specified by *number*.
 - **loopback number** loopback interface specified by *number*.
 - **management number** management interface specified by *number*.
 - **port-channel number** channel group interface specified by *number*.
 - **vlan number** VLAN interface specified by *number*.
- **CHANGE** the change being watched for in the triggering interface. Values include:
 - **ip** triggers when the IPv4 address of the specified interface is changed.
 - **ip6** triggers when the IPv6 address of the specified interface is changed.
 - **operstatus** triggers when the operational status of the specified interface changes.

Examples

- This command configures the event handler “*Eth5*” to be triggered when there is a change in the operational status or IP address of *Ethernet interface 5*.

```
switch(config-handler-Eth5)#trigger on-intf Ethernet 5 operstatus ip
switch(config-handler-Eth5)#
```

- This command configures the event handler “onStartup” to be triggered when the system boots, or on exiting event-handler configuration mode.

```
switch(config-handler-onStartup)#trigger onboot
switch(config-handler-onStartup)#
```

Booting the Switch

This chapter describes the switch boot process, describes configuration options, and lists the components it requires, including the boot loader, the boot loader shell, and other configuration files.

This chapter includes the following sections:

- [Boot Loader Aboot](#)
- [Configuration Files](#)
- [Supervisor Redundancy](#)
- [System Reset](#)
- [Aboot Shell](#)
- [Aboot Configuration Commands](#)
- [Switch Booting Commands](#)

2.1 Boot Loader Aboot

Aboot is the boot loader for Arista switches. In addition to booting the switch EOS, Aboot provides a shell for changing boot parameters, restoring default switch settings, diagnosing hardware problems, and managing switch files. [Aboot Shell](#) describes the Aboot shell.

The boot process loads an EOS image file, initiates switch processes, performs self tests, restores interface settings, and configures other network parameters. The replacement image file can be in the switch's flash or on a device in the flash drive port. Configuration files stored in flash memory specify boot parameters.

Aboot supports most available USB flash drive models. The flash drive must be formatted with the FAT or VFAT file system. Windows NT File System (NTFS) is not supported.

Aboot initiates a system reboot upon a `reLoad` command or by restoring power to the switch. Before loading the EOS image file, Aboot provides an option to enter the Aboot shell. The user can either enter the shell to modify boot parameters or allow the switch to boot.

The boot process can be monitored through a terminal connected to the console port. The console port is configured to interact with the terminal by configuration file settings.

2.2 Configuration Files

Three files define boot and running configuration parameters.

- ***boot-config***: contains the location and name of the image to be loaded.
- ***running-config***: contains the current switch configuration.
- ***startup-config***: contains the switch configuration that is loaded when the switch boots.

The ***running-config*** and ***startup-config*** are different from one another when configuration changes have not been saved since the last boot.

2.2.1 boot-config

The ***boot-config*** file is an ASCII file that Aboot uses to configure console communication settings, locate the EOS flash image, and specify initial network configuration settings.

About attempts to boot the EOS flash software image (with the extension `.swi`) referenced by **`boot-config`** if the user does not interrupt the boot process. See [About Shell](#) describes how About uses **`boot-config`**.

You can view and edit the **`boot-config`** file contents. Viewing and editing options include:

- View **`boot-config`** file contents with the `more boot-config` command:

```
switch(config)#more boot-config
SWI=flash:/EOS.swi
CONSOLESPPEED=2400
About password (encrypted): $1$A8dZ3GLZ$knKrBpTyg5dhmtGdCdwNM.
switch(config)#
```

- View **`boot-config`** settings with the `show boot-config` command:

```
switch(config)#show boot-config
Software image: flash:/EOS.swi
Console speed: 2400
About password (encrypted): $1$A8dZ3GLZ$knKrBpTyg5dhmtGdCdwNM.
Memory test iterations: (not set)
switch(config)#
```

- Modify file settings from the command line with EOS `boot` commands.

See [Programming boot-config from the CLI](#) for a list of `boot` commands.

- Edit the file directly by using `vi` from the Bash shell.

See [boot-config Command Line Content](#) for a list of **`boot-config`** parameters.

2.2.1.1 **boot-config** File Structure

Each line in the **`boot-config`** file specifies a configuration setting and has this format:

NAME=VALUE

- NAME is the parameter label.
- VALUE indicates the parameter's bootup setting.

The NAME and VALUE fields cannot contain spaces.

About ignores blank lines and lines that begin with a `#` character.

2.2.1.2 **boot-config** Command Line Content

About configuration commands that **`boot-config`** files can contain include:

- **SWI** specifies the location and file name of the EOS image file that About loads when booting, using the same format as the boot command to designate a local or network path.

Example

```
SWI=flash:EOS.swi           <---flash drive location
SWI=usb1:/EOS1.swi         <---USB drive location
SWI=file:/tmp/EOSexp.swi   <---switch directory location
SWI=/mnt/flash/EOS.swi
SWI=http://foo.com/images/EOS.swi
SWI=ftp://foo.com/images/EOS.swi
SWI=tftp://foo.com/EOS.swi
SWI=nfs://foo.com/images/EOS.swi
```

- **CONSOLE SPEED** specifies the console baud rate. To communicate with the switch, the connected terminal must match the specified rate. Baud rates options include 1200, 2400, 4800, 9600, 19200, 38400, 57600, and 115200. The default baud rate is 9600.

Example

```
CONSOLE SPEED=19200
```

- **PASSWORD (ABOOT)** specifies the Aboot password, as described in [Accessing the Aboot Shell](#). If **boot-config** does not contain a **PASSWORD** command, the Aboot shell does not require a password.

Example

```
PASSWORD=$1$CdWp5wfe$pzNtE3ujBoFEL8vjCq7jo/
```

- **NET commands** are used by Aboot during switch booting to configure the network interface that will be used for switch configuration. These commands can also be entered manually in Aboot.

NETDEV indicates which network interface is being configured. If **boot-config** does not contain a **NETDEV** command, the booting process does not attempt to configure a network interface. Other **NET** commands specify settings that Aboot uses to configure the interface.

Examples

This **NETDEV** command specifies management port 1 as the network interface to be configured by **boot-config**:

```
NETDEV=ma1
```

This **NETAUTO** command instructs the switch to configure the network interface through a DHCP server, ignoring other **NET** settings:

```
NETAUTO=dhcp
```

These **NET** commands configure the network interface:

```
NETIP=10.12.15.10
NETMASK=255.255.255.0
NETGW=10.12.15.24
NETDOMAIN=mycompany.com
NETDNS=10.12.15.13
```

2.2.1.3 Programming boot-config from the CLI

The switch CLI provides **boot** commands for editing **boot-config** contents. The **boot** commands are not accessible from a console port CLI. Parameters not configurable from a **boot** command can be modified by directly editing the **boot-config** file.

Commands that configure boot parameters include **boot system**, **boot secret**, and **boot console**.

boot system

The **boot system** command provides the EOS image file location to Aboot.

Examples

- This command specifies EOS1.swi on USB flash memory as the software image load file.

```
switch(config)#boot system usb1:EOS1.swi
```

```
switch(config)#
```

The **boot system** command above adds this line to **boot-config**.

```
SWI=usb1:/EOS1.swi
```

- This command designates EOS.swi, on the switch flash, as the EOS software image load file.

```
switch(config)#boot system flash:EOS.swi
switch(config)#
```

The **boot system** command above adds this line to **boot-config**:

```
SWI=flash:/EOS.swi
```

boot secret

The **boot secret** command sets the Aboot password.

Examples

- These equivalent commands set the Aboot password to xr19v.

```
switch(config)#boot secret xr19v
switch(config)#
```

```
switch(config)#boot secret 0 xr19v
switch(config)#
```

- This command shows the password that has been set.

```
switch(config)#show boot-config
Software image: flash:/EOS.swi
Console speed: (not set)
Aboot password (encrypted): $1$k9YHFW8D$cgM8DSN.e/yY0p3k3RUvk.
switch(config)#
```

The **boot secret** commands above add this line to **boot-config**:

```
PASSWORD=$1$k9YHFW8D$cgM8DSN.e/yY0p3k3RUvk.
```

The user must enter xr19v at the login prompt to access the Aboot shell.

- This command sets the Aboot password to xr123. The encrypted string was previously generated with xr123 as the clear-text seed.

```
switch(config)#boot secret 5 $1$QfbYkVWb$PIXG0udEquW0wOSiZBN3D/
switch(config)#
```

- This command shows the password that has been set.

```
switch(config)#show boot-config
Software image: flash:/EOS.swi
Console speed: (not set)
Aboot password (encrypted): $1$QfbYkVWb$PIXG0udEquW0wOSiZBN3D/
```

```
switch(config)#
```

The **boot secret** command above adds this line to **boot-config**:

```
PASSWORD=$1$QfbYkVWb$PIXG0udEquW0wOSiZBN3D/
```

The user must enter xr123 at the login prompt to access the Aboot shell.

- This command removes the Aboot password; subsequent Aboot access is not authenticated.

```
switch(config)#no boot secret
switch(config)#
```

This command shows that there is now no Aboot password.

```
switch(config)#show boot-config
Software image: flash:/EOS.swi
Console speed: (not set)
Aboot password (encrypted): (not set)
switch(config)#
```

boot console

The **boot console** command sets console settings for attaching devices.

Examples

- This command sets the console speed to 4800 baud:

```
switch(config)#boot console speed 4800
switch(config)#
```

This command shows the console speed.

```
switch(config)#show boot-config
Software image: flash:/EOS.swi
Console speed: 4800
Aboot password (encrypted): (not set)
switch(config)#
```

The **boot console** command above adds this line to **boot-config**:

```
CONSOLESPPEED=4800
```

2.2.2 running-config

The **running-config** is a virtual file that contains the system's operating configuration, formatted as a command sequence. Commands entered from the CLI modify **running-config**, and copying a file to **running-config** updates the operating configuration by executing the commands in the copied file.

Commands for viewing and copying **running-config** include:

- **show running-config** displays the contents of **running-config**.
- **copy running-config startup-config** copies **running-config** contents to **startup-config**.
- **write** copies **running-config** contents to **startup-config**.

2.2.3 startup-config

The **startup-config** file is stored in flash memory and contains the configuration that the switch loads when booting. During a switch boot, **running-config** is replaced by **startup-config**. Changes to **running-config** that are not copied to **startup-config** are lost when the system reboots.

Commands affecting **startup-config** include:

- `show startup-config` displays the contents of **startup-config**.
- `copy file_name startup-config` copies contents of the specified file to **startup-config**.
- `delete startup-config` deletes the **startup-config** file.

2.3 Supervisor Redundancy

On modular switches with redundant supervisor modules, control of the switch can be transferred to the standby supervisor to minimize downtime and data loss in the case of a reset, reload, or failure of the active supervisor. How the switchover takes place is determined by the redundancy protocol configured on the active supervisor.

To display the state and the current redundancy protocol of both supervisors, use the `show redundancy status` command. To display the state of configuration file synchronization between the supervisors, use the `show redundancy file-replication` command.

2.3.1 Redundancy Supervisor Protocols

There are three available supervisor redundancy protocols.

Route Processor Redundancy (RPR)

The default redundancy protocol is Route Processor Redundancy (RPR), which synchronizes **startup-config** files between the supervisor modules and partially boots the standby supervisor to a standby warm state, but does not synchronize **running-config**. If the active supervisor fails, or a manual switchover is initiated with the `redundancy manual switchover` command, the standby supervisor will become active. Running state, including spanning tree, is lost, and all links are temporarily brought down.

Under RPR, the CLI of the standby supervisor can be accessed by SSH or through the console port, but the available command set is limited. Any configuration changes made to the standby supervisor will be lost when the supervisor reboots.

Stateful Switchover (SSO)

In Stateful Switchover (SSO) protocol, the switch synchronizes both **startup-config** and **running-config** files between the supervisor modules and fully boots the standby module to a standby hot state to speed the switchover process and minimize packet loss. If the active supervisor fails, or a manual switchover is initiated, the standby supervisor immediately becomes active, and L2 running state is maintained. An SSO switchover is largely transparent from the outside, but because L3 state is not synchronized the switchover can result in traffic loss for traffic forwarded on routes learned by a dynamic routing protocol. Enabling nonstop forwarding can eliminate most packet loss for BGP and OSPF.

Under SSO, the CLI of the standby supervisor can be accessed only through the console port, and the command set is limited. Any configuration changes made on the standby supervisor will be lost when the supervisor reboots.



Note: When upgrading the EOS on a dual-supervisor switch to an SSO-capable version (4.11.0 or higher) from a version that does not support SSO, both supervisors will reset simultaneously, causing several seconds of system downtime.

Simplex

When the switch is set to simplex protocol, the standby supervisor is disabled and switchover will not occur even if the active supervisor fails. Reloading the active supervisor results in system downtime while the supervisor reboots, and the standby supervisor remains disabled. To transfer control of the switch to the standby supervisor, the redundancy protocol must be changed to RPR or SSO.

Under simplex protocol, the CLI of the disabled supervisor can be accessed only through the console port, and the command set is limited. Any configuration changes made on the standby supervisor will be lost when the supervisor reboots.

2.3.2 Configuring Supervisor Redundancy

The supervisor redundancy protocol is configured using the `protocol` command in redundancy configuration mode (accessed with the `redundancy` command).

Changing the redundancy protocol on the active supervisor resets the standby supervisor regardless of redundancy protocol, and executing the `write` command on the active supervisor synchronizes the *startup-config* files between supervisors in RPR and SSO modes.

Examples

- These commands display the current redundancy state of the switch and the most recent file synchronization information.

```
switch#show redundancy state
  my state = ACTIVE
  peer state = STANDBY WARM
    Unit = Primary
    Unit ID = 1

Redundancy Protocol (Operational) = Route Processor Redundancy
Redundancy Protocol (Configured) = Route Processor Redundancy
Communications = Up
Ready for switchover

  Last switchover time = 7:23:56 ago
Last switchover reason = Supervisor has control of the active
supervisor lock
switch#show redundancy file-replication
0 files unsynchronized, 2 files synchronized, 0 files failed, 2 files
total.
```

File	Status	Last Synchronized
file:persist/sys	Synchronized	0:10:04 ago
flash:startup-config	Synchronized	0:10:04 ago

```
switch#
```

- These commands set the redundancy protocol for the active supervisor to stateful switchover (SSO).

```
switch#config
switch(config)#redundancy
switch(config-redundancy)#protocol sso
Peer supervisor will be restarted.
switch(config-redundancy)#
```

2.4 System Reset

When a reset condition exists, Aboot can either reset the switch without user intervention or facilitate a manual reset through the Aboot shell. A reset operation clears the switch, including memory states and other hardware logic

- **Fixed systems:** the power supply remains powered up through the reset. Power is removed from all other switch components for two to five seconds.
- **Modular systems:** the power supply on the active supervisor remains powered up through the reset. Power is removed from all other supervisor components for at least one second. In Stateful Switchover (SSO) and Route Processor Redundancy (RPR) modes, resetting the standby supervisor has no effect on the active supervisor, but resetting the active supervisor causes the standby supervisor to immediately become active. After the supervisor becomes functional, it manages the power-cycling of all line cards.

The `reload` command initiates an immediate reset, terminating all CLI instances not running through the console port. The console port CLI displays messages that the switch generates during a reset. On modular switches with redundant supervisors, CLI sessions on the standby supervisor are not terminated.

The `reload (scheduled)` command schedules a reset operation to initiate at a specific time or after a specified period.

2.4.1 Typical Reset Sequence

The `reload` command power cycles the switch, then resets it under Aboot control. The hard reset clears the switch, including memory states and other hardware logic.

By default, the `reload` command triggers a request to store unsaved **running-config** commands and an option to open the Aboot shell before starting the reboot when accessing the CLI through the console port. The switch then begins the reboot process controlled by Aboot.

The following procedure is an example of a typical restart.

1. Begin the reboot process by typing the `reload` command:

```
switch#reload
```

The switch sends a message to confirm the reload request:

```
Proceed with reload? [confirm]
```

2. Press **enter** or type **y** to confirm the requested reload. Pressing any other key terminates the reload operation.

The switch sends a series of messages, including a notification that a message was broadcast to all open CLI instances, informing them that the system is being rebooted. The reload pauses when the CLI displays the Aboot shell notification line.

```
Broadcast message from root@mainStopping sshd: [ OK ]  
SysRq : Remount R/O  
Restarting system
```

```
Aboot 1.9.0-52504.EOS2.0
```

```
Press Control-C now to enter Aboot shell
```

3. To continue the reload process, do nothing. Typing **Ctrl-C** opens the About shell; see [About Commands](#) for About editing instructions.

The switch continues the reset process, displaying messages to indicate the completion of individual tasks. The reboot is complete when the CLI displays a login prompt.

```
Booting flash:/EOS.swi
Unpacking new kernel
Starting new kernel
Switching to rooWelcome to Arista Networks EOS 4.4.0
Mounting filesystems: [ OK ]
Entering non-interactive startup
Starting EOS initialization stage 1: [ OK ]
ip6tables: Applying firewall rules: [ OK ]
iptables: Applying firewall rules: [ OK ]
iptables: Loading additional modules: nf_contrack_tftp [ OK ]
Starting system logger: [ OK ]
Starting system message bus: [ OK ]
Starting NorCal initialization: [ OK ]
Starting EOS initialization stage 2: [ OK ]
Starting ProcMgr: [ OK ]
Completing EOS initialization: [ OK ]
Starting Power On Self Test (POST): [ OK ]
Generating SSH2 RSA host key: [ OK ]
Starting isshd: [ OK ]
Starting sshd: [ OK ]
Starting xinetd: [ OK ]
[ OK ] crond: [ OK ]

switch login:
```

4. Log in to the switch to resume configuration tasks.

2.4.2 Switch Recovery

About can automatically erase the internal flash and copy the contents of a USB drive that has been inserted before powering up or rebooting the switch. This recovery method does not require access to the switch console or About password entry, even if the **boot-config** file lists one.

About invokes the recovery mechanism only if each of these two conditions is met:

- The USB drive must contain a file called “fullrecover.”
The file’s contents are ignored; an empty text file is sufficient.
- If the USB drive contains a **boot-config** file, its timestamp must differ from the timestamp of the **boot-config** file on the internal flash.

This prevents About from invoking the recovery mechanism again on every boot if you leave the flash key inserted.

To use this recovery mechanism, set up a USB drive with the files to be installed on the internal flash for example, a current EOS software image, and a customized or empty **boot-config** plus an empty file named “fullrecover.”

Check that the timestamp of **boot-config** is current to ensure that the above conditions are met.

2.4.3 Display Reload Cause

The `show reload cause` command displays the cause of the most recent system reset and lists recommended actions, if any exist, to avoid future spontaneous resets or resolve other issues that may have caused the reset.

Example

To display the reset cause, type `show reload cause` at the prompt.

```
switch#show reload cause
Reload Cause 1:
-----
Reload requested by the user.

Recommended Action:
-----
No action necessary.

Debugging Information:
-----
None available.
switch#
```

2.4.4 Configuring Zero Touch Provisioning

Zero Touch Provisioning (ZTP) is a switch configuration method that uses files referenced by a DHCP server to initially provision the switch without user intervention. A switch enters ZTP mode when it is reloaded if flash memory does not contain a **startup-config**.

Canceling ZTP boots the switch without using a **startup-config** file. When ZTP mode is canceled, a **startup-config** file is not stored to flash memory. Until a **startup-config** file is stored to flash, the switch returns to ZTP mode on subsequent reboots. This section describes steps required to implement, monitor, and cancel ZTP.

2.4.4.1 Configuring the Network for ZTP

A switch performs the following after booting in ZTP mode:

- Configures each physical interface to no switchport mode.
- Sends a DHCP query packet on all Ethernet and management interfaces.

After the switch receives a DHCP offer, it responds with a DHCP request for Option 66 (TFTP server name), Option 67 (bootfile name), and dynamic network configuration settings. When the switch receives a valid DHCP response, it configures the network settings, then fetches the file from the location listed in Option 67. If Option 67 returns a network URL (`http://` or `ftp://`), the switch obtains the file from the network. If Option 67 returns a file name, the switch retrieves the file from the TFTP server listed in Option 66.

The Option 67 file can be a **startup-config** file or a boot script. The switch distinguishes between a **startup-config** file and a boot script by examining the first line in the file:

- The first line of a boot file must consist of the `#!` characters followed by the interpreter path. The switch executes the code in the script, then reboots. The boot script may fetch an EOS software image or perform required customization tasks.

The following boot file fetches an EOS software image and stores a startup configuration file to flash.

```
#!/usr/bin/ClI -p2
copy http://company.com/startup-config flash:startup-config
copy http://company.com/EOS-2.swi flash:EOS-2.swi
config
boot system flash:EOS-2.swi
```

- The switch identifies any other file as a **startup-config** file. The switch copies the **startup-config** file into flash as mnt/flash/startup-config, then reboots.

The switch uses its system MAC address as the DHCP client identifier and Arista as the Vendor Class Identifier (Option 60). When the switch receives an http URL through Option 67, it sends the following HTTP headers in the GET request:

```
X-Arista-SystemMAC:
X-Arista-HardwareVersion:
X-Arista-SKU:
X-Arista-Serial:
X-Arista-Architecture:
```

2.4.4.2 Monitoring ZTP Progress

A switch displays the following message after rebooting when it does not contain a **startup-config** file:

```
No startup-config was found.
```

```
The device is in Zero Touch Provisioning mode and is attempting to
download the startup-config from a remote system. The device will not
be fully functional until either a valid startup-config is downloaded
from a remote system or Zero Touch Provisioning is cancelled. To cancel
Zero Touch Provisioning, login as admin and type 'zerotouch cancel'
at the CLI.
```

```
switch login:
```

The switch displays a CONFIG_DOWNLOAD_SUCCESS message after it successfully downloads a **startup-config** file, then continues the reload process as described in [Typical Reset Sequence](#).

```
=====
=====

Successful download
-----

Apr 15 21:36:46 switch ZeroTouch: %ZTP-5-DHCP_QUERY: Sending DHCP request
on [
Ethernet10, Ethernet13, Ethernet14, Ethernet17, Ethernet18, Ethernet21,
Ethernet22, Ethernet23, Ethernet24, Ethernet7, Ethernet8, Ethernet9,
Management1, Management2 ]
Apr 15 21:36:56 switch ZeroTouch: %ZTP-5-DHCP_SUCCESS: DHCP response
received on
Ethernet24 [ Mtu: 1500; Ip Address: 10.10.0.4/16; Nameserver: 10.10.0.1;
Domain:
aristanetworks.com; Gateway: 10.10.0.1; Boot File:
http://10.10.0.2:8080/tmp/172.17.11.196-startup-config.1 ]
Apr 15 21:37:01 switch ZeroTouch: %ZTP-5-CONFIG_DOWNLOAD: Attempting to
download
the startup-config from http://10.10.0.2:8080/tmp/172.17.11.196-startup-
config.1
Apr 15 21:37:02 switch ZeroTouch: %ZTP-5-CONFIG_DOWNLOAD_SUCCESS:
Successfully
downloaded startup-config from
http://10.10.0.2:8080/tmp/172.17.11.196-startup-config.1
Apr 15 21:37:02 switch ZeroTouch: %ZTP-5-RELOAD: Rebooting the system
Broadcast messagStopping sshd: [ OK ]
watchdog is not running
SysRq : Remount R/O
```

```
Restarting system

About 1.9.0-52504.EOS2.0

Press Control-C now to enter About shell
```

2.4.4.3 ZTP Failure Notification

The switch displays a DHCP_QUERY_FAIL message when it does not receive a valid DHCP response within 30 seconds of sending the query. The switch then sends a new DHCP query and waits for a response. The switch continues sending queries until it receives a valid response or until ZTP mode is canceled.

```
switch login:admin
admin
switch>Apr 15 21:28:21 localhost ZeroTouch: %ZTP-5-DHCP_QUERY: Sending
DHCP
request on [ Ethernet10, Ethernet13, Ethernet14, Ethernet17,
Ethernet18,
Ethernet21, Ethernet22, Ethernet23, Ethernet24, Ethernet7, Ethernet8,
Ethernet9, Management1, Management2 ]
Apr 15 21:28:51 localhost ZeroTouch: %ZTP-5-DHCP_QUERY_FAIL: Failed to
get a
valid DHCP response
Apr 15 21:28:51 localhost ZeroTouch: %ZTP-5-RETRY: Retrying Zero Touch
Provisioning from the beginning (attempt 1)
Apr 15 21:29:22 localhost ZeroTouch: %ZTP-5-DHCP_QUERY: Sending DHCP
request on
[ Ethernet10, Ethernet13, Ethernet14, Ethernet17, Ethernet18,
Ethernet21,
Ethernet22, Ethernet23, Ethernet24, Ethernet7, Ethernet8, Ethernet9,
Management1, Management2 ]
```

2.4.4.4 Canceling ZTP Mode

To boot the switch without a *startup-config* file, log into the console, then cancel ZTP mode. After the switch boots, it uses all factory default settings. A *startup-config* file must be saved to flash memory to prevent the switch from entering ZTP mode on subsequent boots.

2.4.5 Configuring the Networks

If the *boot-config* file contains a NETDEV statement, About attempts to configure the network interface, as specified by Network configuration commands. See [boot-config Command Line Content](#) for a list of commands that define the network configuration.

2.5 About Shell

The About shell is an interactive command-line interface used to manually boot a switch, restore the internal flash to its factory-default state, run hardware diagnostics, and manage files. The About shell is similar to the Linux Bourne Again Shell (Bash).

The About shell provides commands for restoring the state of the internal flash to factory defaults or a customized default state. You can use these recovery methods to:

- restore the factory-default flash contents before transferring the switch to another owner.
- restore About shell access if the About password is lost or forgotten.

- restore console access if baud rate or other settings are incompatible with the terminal.
- replace the internal flash contents with configuration or image files stored on a USB flash drive.

2.5.1 About Shell Operation

When the switch is powered on or rebooted, Aboot reads its configuration from **boot-config** on the internal flash and attempts to boot an EOS software image (with the extension .swi) automatically if one is configured.

You can monitor the automatic boot process or enter the Aboot shell only from the console port. You can connect a PC or terminal directly to the port and run a terminal emulator to interact with the serial port or access it through a serial concentrator device.

Console settings are stored in **boot-config**; the factory-default settings for Arista switches are 9600 baud, no parity, 8 character bits, and 1 stop bit. If you do not know the current settings, perform a full flash recovery to restore the factory-default settings. When the console port is connected and the terminal settings are configured properly, the terminal displays a message similar to the following a few seconds after powering up the switch:

```
About 1.0.0

Press Control-C now to enter the Aboot shell
```

To abort the automatic boot process and enter the Aboot shell, press **Ctrl-C** (ASCII 3 in the terminal emulator) after the *Press Control-C now to enter Aboot shell* message appears. Pressing **Ctrl-C** can interrupt the boot process up through the starting of the new kernel.

If the **boot-config** file does not contain a password command, the Aboot shell starts immediately. Otherwise, you must enter the correct password at the password prompt to start the shell. If you enter the wrong password three times, Aboot displays this message:

```
Type "fullrecover" and press Enter to revert /mnt/flash to factory
default

state, or just press Enter to reboot:
```

- Pressing **Enter** continues a normal soft reset without entering the Aboot shell.
- Typing **fullrecover** and pressing **Enter** performs a full flash recovery to restore the factory-default settings, removing all previous contents of the flash drive.

The Aboot shell starts by printing:

```
Welcome to Aboot.
```

Aboot then displays the Aboot# prompt.

Aboot reads its configuration from **boot-config** on the internal flash.

2.5.2 Accessing the Aboot Shell

This procedure accesses the Aboot Shell.

1. Reload the switch and press **enter** or type **y** when prompted, as described in [Typical Reset Sequence](#).

The command line displays this Aboot entry prompt.

```
Press Control-C now to enter Aboot shell
```

2. Type **Ctrl-C**.

If the **boot-config** file does not contain a **PASSWORD** command, the CLI displays an About welcome banner and prompt.

```
^CWelcome to About.  
About#
```

If the **boot-config** file contains a **PASSWORD** command, the CLI displays a password prompt. In this case, proceed to step 3. Otherwise, the CLI displays the About prompt.

3. If prompted, enter the About password.

```
Press Control-C now to enter About shell  
^CAboot password:  
Welcome to About.  
About#
```

About allows three attempts to enter the correct password. After the third attempt, the CLI prompts the user to either continue the reboot process without entering the About shell or to restore the flash drive to the factory default state.

```
Press Control-C now to enter About shell  
^CAboot password:  
incorrect password  
About password:  
incorrect password  
About password:  
incorrect password  
Type "fullrecover" and press Enter to revert /mnt/flash to factory  
default  
state, or just press Enter to reboot: fullrecover  
All data on /mnt/flash will be erased; type "yes" and press Enter to  
proceed,  
or just press Enter to cancel:
```

The `fullrecover` operation replaces the flash contents with a factory default configuration. The CLI displays text similar to the following when performing a `fullrecover`, finishing with another entry option into the About shell.

 **Note:** For hardware that is purchased after June 2017, the factory default partition will not have the backup EOS software image. This is done to increase the flash size on smaller flash size disks, and other options are available in the `fullrecover` command functionality to restore factory default EOS image. This is applicable to both fixed system and modular system hardware.

```
Erasing /mnt/flash  
Writing recovery data to /mnt/flash  
boot-config  
startup-config  
EOS.swi  
210770 blocks  
Restarting system.  
  
About 1.9.0-52504.EOS2.0  
  
Press Control-C now to enter About shell
```

2.5.3 About File Structure

When you enter the About CLI, the current working directory is the root directory on the switch. Switch image and configuration files are at **/mnt/flash**. When exiting the About shell, only the contents of **/mnt/flash** are preserved. The **/mnt** directory contains the file systems of storage devices. About mounts the internal flash device at **/mnt/flash**.

When a USB flash drive is inserted in one of the flash ports, About mounts its file system on **/mnt/usb1**. The file system is unmounted when the USB flash drive is removed from the port. Most USB drives contain an LED that flashes when the system is accessing it; do not remove the drive from the flash port until the LED stops flashing.

2.5.4 Booting From the About Shell

About attempts to boot the EOS software image (with the extension **.swi**) configured in **boot-config** automatically if you take no action during the boot process. If the boot process fails for any reason, such as an incorrectly configured software image, About enters the shell, allowing you to correct the configuration or boot a software image manually. The **boot** command loads and boots an EOS software image file.

The **boot** command syntax is

boot SWI

where **SWI** lists the location of the EOS image that the command loads. **SWI** options include:

- **device:path** loads the image file from the specified storage device. The default **device** value is **flash**; other values include **file** and **usb1**.
- **/PATH** loads the image file from the specified path in the switch directory.
- **http://server/path** loads the image file from the HTTP server on the host server.
- **ftp://server/path** loads the image file from the FTP server on the host server.
- **tftp://server/path** loads the image file from the TFTP server on the host server.
- **nfs://server/path** mounts the path's parent directory from the host server and loads the image file from the loaded directory.

The accepts the same commands as the **SWI** variable in the **boot-config** file. See [boot-config Command Line Content](#) for a list of boot command formats.

If an image file is not specified in **boot-config**, or if booting the image results in an error condition (for example, an incorrect path or unavailable HTTP server), About halts the boot process and drops into the shell.

Example

To boot EOS.swi from internal flash, enter one of these commands on the About command line:

```
boot flash:EOS.swi
```

```
boot /mnt/flash/EOS.swi
```

2.5.5 About Commands

To list the contents of the internal flash, enter **ls /mnt/flash** at the About# prompt.

Example

```
About#ls /mnt/flash
EOS.swi boot-config startup-config
```

Commonly used commands include:

- **ls** prints a list of the files in the current working directory.
- **cd** changes the current working directory.
- **cp** copies a file.
- **more** prints the contents of a file one page at a time.
- **vi** edits a text file.
- **boot** boots a software image file.
- **swiinfo** prints information about a software image.
- **recover** recovers the factory-default configuration.
- **reboot** reboots the switch.
- **udhcpc** configures a network interface automatically via DHCP.
- **ifconfig** prints or alters network interface settings.
- **wget** downloads a file from an HTTP or FTP server.

Many About shell commands are provided by Busybox, an open-source implementation of UNIX utilities. Busybox command help is found at <http://www.busybox.net/downloads/BusyBox.html>. About provides access to only a subset of the documented commands.

About can access networks through the Ethernet management ports. About provides network interfaces `mgmt1` and `mgmt2`. These ports are unconfigured by default; you can configure management port settings using About shell commands like `ifconfig` and `udhcpc`. When a management interface is configured, use `wget` to transfer files from an HTTP or FTP server, `tftp` to transfer files from a TFTP server, or `mount` to mount an NFS filesystem.

2.6 About Configuration Commands

This section describes the About configuration commands that a *boot-config* file can contain.

- [CONSOLE SPEED](#)
- [NET commands](#)
- [PASSWORD \(ABOOT\)](#)
- [SWI](#)

2.6.1 CONSOLE SPEED

The `CONSOLE SPEED` command in the *boot-config* file specifies the console baud rate when the switch is booted. To communicate with the switch, the connected terminal must match the specified rate. Baud rate options include 1200, 2400, 4800, 9600, 19200, 38400, 57600, and 115200.

The default baud rate is 9600.

Command Syntax

```
CONSOLE SPEED= baud_rate
```

Parameters

- *baud_rate* specifies the console speed. Values include **1200**, **2400**, **4800**, **9600**, **19200**, **38400**, **57600**, and **115200**.

Examples

- This command in a *boot-config* file sets the baud rate to 2400 when the switch boots.

```
CONSOLE SPEED=2400
```

2.6.2 NET Commands

NET commands in the *boot-config* file are used by Aboot during switch booting to configure the network interface that will be used for switch configuration. These commands can also be entered manually in Aboot.

NETDEV indicates which network interface is being configured. If *boot-config* does not contain a NETDEV command, the booting process does not attempt to configure a network interface. Other NET commands specify settings that Aboot uses to configure the interface.

Command Syntax

NETDEV=*device_interface*

NETAUTO=*auto_setting*

NETIP=*interface_address*

NETMASK=*interface_mask*

NETGW=*gateway_address*

NETDOMAIN=*domain_name*

NETDNS=*dns_address*

Parameters

- *device_interface* the network interface. Options include:
 - ma1 management port 1.
 - ma2 management port 2.
- *auto_setting* the configuration method. Options include:
 - dhcp interface is configured through a DHCP server; other NET commands are ignored.
 - if the NETAUTO command is omitted, the interface is configured with other NET commands.
- *interface_address* interface IP address, in dotted-decimal notation.
- *interface_mask* interface subnet mask, in dotted-decimal notation.
- *gateway_address* default gateway IP address, in dotted decimal notation.
- *domain_name* interface domain name.
- *dns_address* IP address of the Domain Name Server, in dotted decimal notation.

Example

- This command specifies management port 1 as the network interface to be configured for management traffic.

```
NETDEV=ma1
```

- This command instructs the switch to configure the network interface through a DHCP server, ignoring any other NET commands.

```
NETAUTO=dhcp
```

- These NET commands configure the network interface.

```
NETIP=10.12.15.10
NETMASK=255.255.255.0
NETGW=10.12.15.24
NETDOMAIN=mycompany.com
NETDNS=10.12.15.13
```

2.6.3 PASSWORD (ABOOT)

PASSWORD specifies the Aboot password, as described in [Accessing the Aboot Shell](#). If *boot-config* does not contain a `PASSWORD` command, the Aboot shell does not require a password.

The *boot-config* file stores the password as an MD5-encrypted string as generated from a clear-text seed by the UNIX `passwd` program or the `crypt` library function. When entering the Aboot password, the user types the clear-text seed.

There is no method of recovering the password from the encrypted string. If the clear-text password is lost, delete the corresponding `PASSWORD` command line from the *boot-config* file.



Note: The EOS `boot secret` command is the recommended method for adding or modifying the `PASSWORD` configuration line.

Command Syntax

`PASSWORD = encrypted_string`

Parameters

- *encrypted_string* the encrypted string that corresponds to the clear-text Aboot password.

Example

- This line is a `PASSWORD` command example in which the encrypted string corresponds to the clear-text password “abcde.”

```
PASSWORD=$1$CdWp5wfe$pzNtE3ujBoFEL8vjcq7jo/
```

2.6.4 SWI

SWI specifies the location and file name of the EOS image file that Aboot loads when booting, using the same format as **boot-config** to designate a local or network path.

Command Syntax

SWI = **SWI_PATH**

Parameters

- **SWI_PATH** specifies the location of the EOS image file. Options include:
 - *file_path* specifies a file location on the internal flash drive.
 - *file:file_path* specifies a file location in the switch directory.
 - *usb1:file_path* specifies a file location on the USB drive.
 - *http:file_path* specifies an HTTP path to the image file.
 - *ftp:file_path* specifies an FTP path to the image file.
 - *tftp:file_path* specifies a TFTP path to the image file.
 - *nfs:file_path* specifies an NFS path to the image file.

Examples

- This SWI command in **boot-config** causes Aboot to boot the switch from the file “EOS.swi” on the switch’s internal flash drive.

```
SWI=flash:EOS.swi
```

- This SWI command in **boot-config** causes Aboot to boot the switch from the file “EOS.swi” at the specified location on foo.com.

```
SWI=http://foo.com/images/EOS.swi
```

2.7 Switch Booting Commands

- `boot console`
- `boot secret`
- `boot system`
- `delete startup-config`
- `protocol`
- `redundancy`
- `redundancy manual switchover`
- `reload`
- `reload (scheduled)`
- `show redundancy file-replication`
- `show redundancy status`
- `show redundancy switchover sso`
- `show reload`
- `show reload cause`
- `show reload fast-boot`

2.7.1 boot console

The `boot console` command configures terminal settings for serial devices connecting to the console port. At this time, the only console setting that can be specified from *boot-config* is speed.

Factory-default console settings are 9600 baud, no parity, 8 character bits, and 1 stop bit. If you do not know the current settings, restore the factory-default settings as described in [Restoring the Factory Default EOS Image and Startup Configuration](#).

The `no boot console` and `default boot console` commands restore the factory default settings on the switch and remove the corresponding `CONSOLESPPEED` command from the *boot-config* file.

Command Mode

Global Configuration

Command Syntax

```
boot console speed baud_rate
```

Parameters

- *baud_rate* console baud rate. Options include 1200, 2400, 4800, 9600, 19200, 38400, 57600, and 115200.

Example

- This command sets the console speed to 57600 baud.

```
switch(config)#boot console speed 57600
switch(config)#
```

This command displays the result of the console-speed change.

```
switch(config)#show boot-config
Software image: flash:/EOS.swi
Console speed: 57600
Aboot password (encrypted): (not set)
switch(config)#
```

The above `boot console` command adds the following line to boot-config.

```
CONSOLESPPEED=57600
```

2.7.2 boot secret

The `boot secret` command creates or edits the Aboot shell password and stores the encrypted string in the `PASSWORD` command line of the `boot-config` file.

The `no boot secret` and `default boot secret` commands remove the Aboot password from the `boot-config` file. When the Aboot password does not exist, no password is required to enter the Aboot shell.

Command Mode

Global Configuration

Command Syntax

```
boot secret [ENCRYPT_TYPE] password
```

```
no boot secret
```

```
default boot secret
```

Parameters

- **ENCRYPT_TYPE** indicates the encryption level of the password parameter. Settings include:
 - <no parameter> the *password* is clear text.
 - 0 the *password* is clear text. Equivalent to the <no parameter> case.
 - 5 the *password* is an MD5-encrypted string.
 - sha512 the password is entered as an sha512 encrypted string.
- *password* specifies the boot password.
 - *password* must be in clear text if **ENCRYPT_TYPE** specifies clear text.
 - *password* must be an appropriately encrypted string if **ENCRYPT_TYPE** specifies encryption.

Restrictions

The sha512 encryption option is not available on Trident platform switches.

Examples

- These equivalent commands set the Aboot password to xr19v.

```
switch(config)#boot secret xr19v
switch(config)#
```

```
switch(config)#boot secret 0 xr19v
switch(config)#
```

This command displays the result:

```
switch(config)#show boot-config
Software image: flash:/EOS.swi
Console speed: (not set)
Aboot password (encrypted): $1$k9YHFW8D$cgM8DSN.e/yY0p3k3RUvk.
switch(config)#
```

The `boot secret` commands above add this line to `boot-config`:

```
PASSWORD=$1$k9YHFW8D$cgM8DSN.e/yY0p3k3RUvk.
```

The user must enter xr19v at the login prompt to access the Aboot shell.

- These commands set the Aboot password to xr123, then display the resulting **boot-config** code. The encrypted string was previously generated with xr123 as the clear-text seed.

```
switch(config)#boot secret 5 $1$QfbYkVWb$PIXG0udEquW0wOSiZBN3D/
switch(config)#show boot-config
Software image: flash:/EOS.swi
Console speed: (not set)
Aboot password (encrypted): $1$QfbYkVWb$PIXG0udEquW0wOSiZBN3D/
switch(config)#
```

The **boot secret** command above adds this line to **boot-config**:

```
PASSWORD=$1$QfbYkVWb$PIXG0udEquW0wOSiZBN3D/
```

The user must enter xr123 at the login prompt to access the Aboot shell.

- This command removes the Aboot password, allowing access to the Aboot shell without a password.

```
switch(config)#no boot secret
switch(config)#
```

2.7.3 boot system

The **boot system** command specifies the location of the EOS software image that Aboot loads when the switch boots. The command can refer to files on flash or on a module in the USB flash port.

Command Mode

Global Configuration

Command Syntax

```
boot system DEVICE file_path
```

Parameters

- **DEVICE** location of the image file. Options include
 - file: file is located in the switch file directory.
 - flash: file is located in flash memory.
 - usb1: file is located on a drive inserted in the USB flash port. Available if a drive is in the port.
- *file_path* path and name of the file.

Examples

- This command designates EOS1.swi, on USB flash memory, as the EOS software image load file.

```
switch(config)#boot system usb1:EOS1.swi
switch(config)#
```

The **boot system** command above adds this line to **boot-config**.

```
SWI=usb1:/EOS1.swi
```

- This command designates EOS.swi, on the switch flash, as the EOS software image load file.

```
switch(config)#boot system flash:EOS.swi
switch(config)#
```

The **boot system** command above adds this line to **boot-config**.

```
s
```

2.7.4 delete startup-config

The `delete startup-config` command erases or deletes the **startup-config** file.

Command Mode

Privileged EXEC

Command Syntax

```
delete startup-config [CONFIRMATION]
```

Parameters

- **CONFIRMATION** confirmation for immediate erasure. Options include:
 - `<no parameter>` the switch requires a confirmation before starting the erasure.
 - `now` the erasure begins immediately without prompting the user to confirm the request.

Examples

- This command deletes the startup configuration from the switch. When the `delete startup-config` command is entered, the switch sends a message prompting the user to confirm the request.

```
switch#delete startup-config  
Proceed with erasing startup configuration? [confirm]y  
switch#
```

- This command deletes the startup configuration from the switch immediately without prompting.

```
switch#delete startup-config now  
switch#
```

2.7.5 protocol

The `protocol` command configures how the supervisors on a modular switch will handle switchover events. By default, the switch is set to **route processor redundancy (RPR)**, which synchronizes *startup-config* files between the supervisor modules and partially boots the standby supervisor. The mode can also be set to **simplex** (manual switchover only) or to **stateful switchover (SSO)** which synchronizes both *startup-config* and *running-config* files between the supervisor modules and fully boots the standby module to speed the switchover process and minimize packet loss. Note that SSO synchronizes L2 state between the supervisors, but that L3 state is not synchronized. This can result in traffic loss for traffic forwarded on routes learned by a dynamic routing protocol. Enabling nonstop forwarding can eliminate most packet loss for BGP and OSPF.

The `no protocol` and `default protocol` commands set the redundancy protocol to the default value (`rpr`) by removing the `protocol` command from *running-config*.

Command Mode

Redundancy Configuration

Command Syntax

```
protocol {rpr | simplex | sso}
no protocol
default protocol
```

Parameters

- `rpr` route processor redundancy protocol (RPR, the default).
- `simplex` no redundancy. Switchover must be initiated manually.
- `sso` stateful switchover (SSO).

Related Commands

- [redundancy](#) places switch in redundancy configuration mode.

Example

- These commands enter redundancy configuration mode and set the redundancy protocol to SSO.

```
switch(config)#redundancy
switch(config-redundancy)#protocol sso
switch(config-redundancy)#
```

2.7.6 redundancy

The **redundancy** command places the switch in redundancy configuration mode.

Command Mode

Global Configuration

Command Syntax

```
redundancy
```

Commands Available in Redundancy Configuration Mode

- `protocol`

Related Commands

- `redundancy manual switchover` manually initiates a switchover.

Example

- These commands enter redundancy configuration mode and set the redundancy protocol to stateful switchover.

```
switch(config)#redundancy  
switch(config-redundancy)#protocol sso  
switch(config-redundancy)#
```

2.7.7 redundancy manual switchover

The **redundancy manual switchover** command immediately switches control of the switch to the standby supervisor. If the redundancy mode is set to simplex or the standby supervisor is unavailable for any other reason, this command will not function.

Command Mode

Privileged EXEC

Command Syntax

```
redundancy manual switchover
```

Related Commands

- [redundancy](#) places the switch in redundancy configuration mode.

Example

- This command forces a switchover to the standby supervisor. The switchover is executed immediately without further confirmation from the user.

```
switch#redundancy manual switchover  
This supervisor will be restarted.  
switch#
```

2.7.8 reload

The `reload` command power cycles the switch, then resets it under Abort control. The hard reset clears the switch, including memory states and other hardware logic.



Note: The `reload` commands are used to initiate Accelerated Switch Update (ASU) and Smart Switch Update (SSU); for descriptions of these features and the appropriate command syntax, refer to the [Accelerated Software Upgrade \(ASU\)](#) and [Leaf Smart System Upgrade \(Leaf SSU\)](#) sections.

The command behaves differently in fixed and modular systems.

- **Fixed 1-RU systems:** the power supply remains powered up through the reset. Power is removed from all other switch components for two to five seconds.
- **Modular systems:** the power supply on the active supervisor remains powered up through the reset. Power is removed from all other supervisor components for at least one second. After the supervisor becomes functional, it manages the power-cycling of all line cards.

Command Mode

Privileged EXEC

Command Syntax

```
reload [TARGET] [CONFIRMATION]
```

Parameters

- **TARGET** specifies which supervisor(s) will be reset. Some options are available only on dual-supervisor switches. Options include:
 - `<no parameter>` the active supervisor is reset.
 - `all` both supervisors are reset.
 - `peer` the peer supervisor is reset.
 - `power` the active supervisor is reset.
- **CONFIRMATION** confirmation for immediate reset. Options include:
 - `<no parameter>` the switch requires a confirmation before starting the reset.
 - `now` the reset begins immediately without prompting the user to confirm the request.

Related Commands

- `reload (scheduled)` schedules a pending reload operation.
- `show reload cause` displays cause of most recent reload.

Example

- Begin the reboot process by typing the `reload` command:

```
switch#reload
switch#
```

When the `reload` command is entered, the switch sends a message prompting the user to save the configuration if it contains unsaved modifications, then asks the user to confirm the reload request. In this example, the user does not save modifications to the system before reloading.

```
System configuration has been modified. Save? [yes/no/cancel/diff]:n
Proceed with reload? [confirm]y
```

The switch responds by broadcasting a series of messages, including a notification that the system is being rebooted, to all open CLI instances. The reload pauses to provide an option for the user to

enter About shell; the About shell supports commands that restore the state of the internal flash to factory defaults or create a customized default state.

```
Broadcast message from root@mainStopping sshd: [ OK ]
SysRq : Remount R/O
Restarting system

About 1.9.0-52504.EOS2.0

Press Control-C now to enter About shell
```

No action is required to continue the reset process. The switch displays messages to indicate the completion of individual tasks. The reboot is complete when the CLI displays a login prompt.

```
Booting flash:/EOS.swi
Unpacking new kernel
Starting new kernel
Switching to rootWelcome to Arista Networks EOS 4.4.0
Mounting filesystems: [ OK ]
Entering non-interactive startup
Starting EOS initialization stage 1: [ OK ]
ip6tables: Applying firewall rules: [ OK ]
iptables: Applying firewall rules: [ OK ]
iptables: Loading additional modules: nf_conntrack_tftp [ OK ]
Starting system logger: [ OK ]
Starting system message bus: [ OK ]
Starting NorCal initialization: [ OK ]
Starting EOS initialization stage 2: [ OK ]
Starting ProcMgr: [ OK ]
Completing EOS initialization: [ OK ]
Starting Power On Self Test (POST): [ OK ]
Generating SSH2 RSA host key: [ OK ]
Starting isshd: [ OK ]
Starting sshd: [ OK ]
Starting xinetd: [ OK ]
[ OK ] crond: [ OK ]

switch login:
```

2.7.9 reload (scheduled)

The **reload (scheduled)** command configures the switch to reset at a specified time or after a specified interval. Refer to [reload](#) for the functional details of the reset operation.

The switch prompts to save the configuration and confirm the reload request. Once the request is confirmed, the switch resumes normal operation until the reload initiates.

The **reload cancel**, **no reload**, and **default reload** commands cancel the pending reload operation.

Command Mode

Privileged EXEC

Command Syntax

```
reload [all | power | peer] {at hh:mm [month | day] | in hh:mm} [force | reason]
```

```
reload cancel
```

```
no reload
```

```
default reload
```

Parameters

- all reloads all supervisors.
- power resets the active supervisor.
- peer resets the peer supervisor.
- at performs reload at specified times.
 - *hh:mm* specifies reload time in hours (0 to 23) and minutes (0 to 59). If no month and day are specified, reload occurs at the specified time on the day the command is issued.
 - *month* optionally specifies month of the year (Jan, Feb, etc.)
 - *day* day of the month. Values range from 1 to 31.
- in performs the reload after a specified delay.
 - *hh:mm* specifies delay before reload in hours (0 to 23) and minutes (0 to 59).
- force performs action immediately without prompting.
- reason enter text to display explaining the purpose of the reload.
- cancel cancels any existing reload request.

Related Commands

- [reload](#) initiates an immediate reload operation.
- [show reload](#) displays time and reason of any pending reload operation.

Examples

- This command schedules a switch reset to begin in 12 hours.

```
switch#reload in 12:00
System configuration has been modified. Save? [yes/no/cancel/diff]:y
Proceed with reload? [confirm]
Reload scheduled for Tue Mar 27 05:57:25 2012 (in 11 hours 59 minutes)
switch#
```

- This command cancels a scheduled reset.

```
switch#no reload
Scheduled reload has been cancelled
switch#
```

-
- This command schedules a reload of the active supervisor to begin in 12 hours.

```
switch#reload power in 12:00  
Reload scheduled for Thu Feb 13 18:56:01 2020 (in 11 hours 59 minutes)  
switch#
```

2.7.10 show redundancy file-replication

The `show redundancy file-replication` command displays the status and last synchronization date of file replication between the supervisors on the switch.

Command Mode

EXEC

Command Syntax

```
show redundancy file-replication
```

Related Commands

- `show redundancy status` displays status and redundancy protocol of supervisors.
- `show redundancy switchover sso` displays stateful switchover information since last reload.

Example

- This command displays the current file replication status of the supervisors.

```
switch#show redundancy file-replication
0 files unsynchronized, 2 files synchronized, 0 files failed, 2 files
total.

File                               Status                               Last Synchronized
-----
file:persist/sys                   Synchronized                         25 days, 19:48:26 ago
flash:startup-config               Synchronized                         25 days, 19:48:26 ago
switch#
```

2.7.11 show redundancy status

The **show redundancy status** command displays the current status (active or standby) and the configured redundancy protocol of both supervisors, as well as summary information about the latest switchover event.

Command Mode

EXEC

Command Syntax

```
show redundancy status
```

Related Commands

- [show redundancy file-replication](#) displays status of file replication between supervisors.
- [show redundancy switchover sso](#) displays stateful switchover information since last reload.

Example

- This command displays redundancy information for both supervisors and a summary of the latest switchover.

```
switch#show redundancy status
  my state = ACTIVE
  peer state = STANDBY HOT
             Unit = Primary
             Unit ID = 1

Redundancy Protocol (Operational) = Stateful Switchover
Redundancy Protocol (Configured) = Stateful Switchover
Communications = Up
switchover completion timeout = 720.0 seconds (default)
Ready for switchover

  Last switchover time = 0:32:15 ago
  Last switchover reason = Supervisor has control of the active
  supervisor lock
switch#
```

2.7.12 show redundancy switchover sso

The **show redundancy switchover sso** command displays the number of stateful switchovers since the last reload and a log of the events in the latest stateful switchover.

Command Mode

EXEC

Command Syntax

```
show redundancy switchover sso
```

Related Commands

- [show redundancy file-replication](#) displays status of file replication between supervisors.
- [show redundancy status](#) displays status and redundancy protocol of supervisors.

Example

- This command displays stateful switchover information.

```
switch#show redundancy switchover sso
Total number of Stateful Switchover completed since reload: 4
```

```
Latest Stateful Switchover occurred 29 days, 12:48:22 ago @ 2012-06-09
19:47:50
(completed)
0.000000: switchover started
0.000235: stage PCIEAcquired started
0.000349:  event PCIEAcquired:__dummyInternall__ completed
0.000394:  event PCIEAcquired:PlxPcie-system started
0.027738:  event PCIEAcquired:PlxPcie-system completed
0.027829: stage PCIEAcquired is complete
0.027935: stage DmaReady started
0.028042:  event DmaReady:ForwardingAgent started
0.079620:  event DmaReady:ForwardingAgent completed
0.079699: stage DmaReady is complete
0.079781: stage TimeCriticalServices started
0.079887:  event TimeCriticalServices:__dummyInternall__ completed
0.079928:  event TimeCriticalServices:Stp started
0.208035:  event TimeCriticalServices:Stp completed
0.208120: stage TimeCriticalServices is complete
      <-----OUTPUT OMITTED FROM EXAMPLE----->
39.675076: stage NonCriticalServices started
39.675145:  event NonCriticalServices:__dummyInternall__ completed
39.675183: stage NonCriticalServices is complete
39.675399: switchover is complete
switch#
```

2.7.13 show reload

The `show reload` command displays the time and reason of any pending reload operation. The `reload (scheduled)` command schedules a reload operation and can be used to cancel a pending reload.

Command Mode

EXEC

Command Syntax

```
show reload
```

Related Commands

- `reload (scheduled)` schedules a pending reload operation.
- `show reload cause` displays cause of most recent reload.

Example

- These commands schedule a reload for 2:45 pm, display the time of the pending reload, then cancel the scheduled reload.

```
switch#reload at 14:45
Proceed with reload? [confirm]
Reload scheduled for Tue Mar 27 14:45:00 2012 ( in 4 hours 11 minutes )
switch#show reload
Reload scheduled for Tue Mar 27 14:45:00 2012 ( in 4 hours 11 minutes )
switch#reload cancel
Scheduled reload has been cancelled
switch#
```

2.7.14 show reload cause

The `show reload cause` command displays the reason of the most recent reload operation. The command displays recommended actions and debug information related to the executed reload.

Command Mode

EXEC

Command Syntax

```
show reload cause
```

Related Commands

- `reload` initiates an immediate reload operation.
- `show reload` displays time and reason of all pending reload operations.

Example

- This command displays the cause of the most recent reload operation.

```
switch#show reload cause
Reload Cause 1:
-----
Reload requested by the user.

Recommended Action:
-----
No action necessary.

Debugging Information:
-----
None available.
switch#
```

2.7.15 show reload fast-boot

The `show reload fast-boot` command displays the compatibility for accelerated software upgrade.

Command Mode

EXEC

Command Syntax

```
show reload fast-boot
```

Related Commands

- `reload` initiates an immediate reload operation.
- `show reload` displays time and reason of all pending reload operations.

Example

- This command displays the support for ASU and to ensure that other affected features are configured appropriately.

```
switch#show reload fast-boot  
No warnings or unsupported configuration found
```

Initial Configuration and Recovery

This chapter describes initial configuration and recovery tasks. Subsequent chapters provide details about features introduced in this chapter.

This chapter contains these sections:

- [Initial Switch Access](#)
- [Connection Management](#)
- [Configure Session](#)
- [Recovery Procedures](#)
- [Session Management Commands](#)

3.1 Initial Switch Access

Arista network switches provide two initial configuration methods:

- Zero Touch Provisioning (ZTP) configures the switch without user interaction ([Zero Touch Provisioning](#)).
- Manual provisioning configures the switch through commands entered by a user through the CLI ([Manual Provisioning](#)).

3.1.1 Zero Touch Provisioning

Zero Touch Provisioning (ZTP) configures a switch without user intervention by downloading a startup configuration file (**startup-config**) or a boot script from a location specified by a DHCP server. [Configuring the Network for ZTP](#) describes network tasks required to set up ZTP.

The switch enters ZTP mode when it boots if flash memory does not contain **startup-config**. It remains in ZTP mode until a user cancels ZTP mode, or until the switch retrieves a **startup-config** or a boot script. After downloading a file through ZTP, the switch reboots again, using the retrieved file.

Security Considerations

The ZTP process cannot distinguish an approved DHCP server from a rogue DHCP server. For secure provisioning, you must ensure that only approved DHCP servers are able to communicate with the switch until after the ZTP process is complete. Arista also recommends validating the EOS image on your ZTP server by confirming that its MD5 checksum matches the MD5 checksum that can be found on the EOS download page of the Arista website.

On a UNIX server, the **md5sum** command calculates this checksum:

```
% md5sum EOS.swi
3bac45b96bc820eb1d10c9ee33108a25  EOS.swi
```

This command is also available on Arista switches from the CLI or from within the Bash shell.

```
switch#bash md5sum /mnt/flash/EOS-4.18.0F.swi
73435f0db3af785011f88743f4c01abd /mnt/flash/EOS-4.18.0F.swi

switch#[admin@switch ~]$ md5sum /mnt/flash/EOS-4.18.0F.swi
73435f0db3af785011f88743f4c01abd /mnt/flash/EOS-4.18.0F.swi
```

```
[admin@switch ~]$
```

To provision the switch through Zero Touch Provisioning:

1. Mount the switch in its permanent location.
2. Connect at least one management or Ethernet port to a network that can access the DHCP server and the configuration file.
3. Provide power to the switch.

ZTP provisioning progress can be monitored through the console port. [Console Port](#) provides information for setting up the console port. [Canceling Zero Touch Provisioning](#) provides information for monitoring ZTP progress and canceling ZTP mode.

3.1.2 Manual Provisioning

Initial manual switch provisioning requires the cancellation of ZTP mode, the assignment of an IP address to a network port, and the establishment of an IP route to a gateway. Initial provisioning is performed through the serial console and Ethernet management ports.

- The console port is used for serial access to the switch. These conditions may require serial access:
 - management ports are not assigned IP addresses
 - the network is inoperable
 - the password for the users log on is not available
 - the password to access the enable mode is not available
- The Ethernet management ports are used for out-of-band network management tasks. Before using a management port for the first time, an IP address must be assigned to that port.

3.1.2.1 Console Port

The console port is a serial port located on the front of the switch. [Figure 2: Switch Ports](#) shows the console port on the DCS-7050T-64 switch. Use a serial or RS-232 cable to connect to the console port. The accessory kit also includes an RJ-45 to DB-9 adapter cable for connecting to the switch.

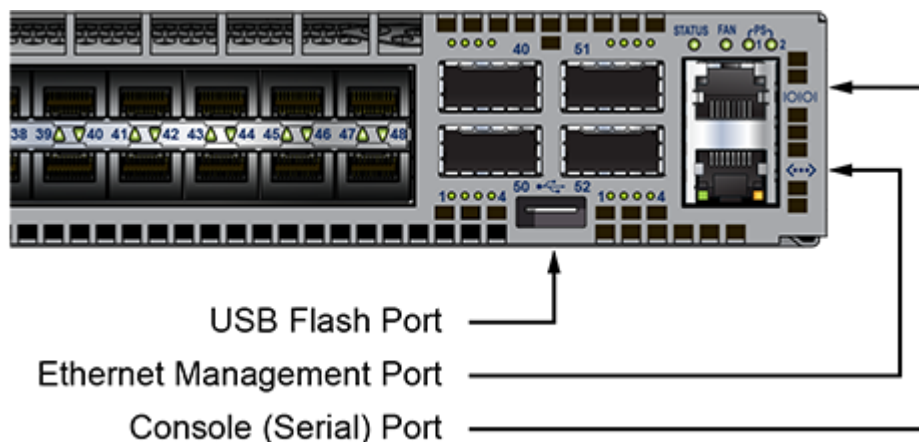

Figure 2: Switch Ports

Port Settings

Use these settings when connecting the console port:

- 9600 baud
- no flow control
- 1 stop bit

- no parity bits
- 8 data bits

Admin Username

The initial configuration provides one username, **admin**, that is not assigned a password. When using the **admin** username without a password, you can only log into the switch through the console port. After a password is assigned to the **admin** username, it can log into the switch through any port.

The `username` command modifies a specified username, and can be used to create or delete usernames, including **admin**.

Example

- This command assigns the password **pxq123** to the **admin** username:

```
switch(config)#username admin secret pxq123
switch(config)#
```

New and altered passwords must be saved to the startup configuration file or they will be lost when the switch is rebooted.



Note: if the configuration is saved with all usernames deleted, it will be necessary to access the Aboot shell through the console port in order to log in to the switch.

3.1.2.2 Canceling Zero Touch Provisioning

Zero Touch Provisioning (ZTP) installs a **startup-config** file from a network location if flash memory does not contain a **startup-config** when the switch reboots. Canceling ZTP is required if the switch cannot download a **startup-config** or boot script file.

When the switch boots without a **startup-config** file, it displays the following message through the console port:

```
No startup-config was found.
```

```
The device is in Zero Touch Provisioning mode and is attempting to
download the startup-config from a remote system. The device will not
be fully functional until either a valid startup-config is downloaded
from a remote system or Zero Touch Provisioning is cancelled. To cancel
Zero Touch Provisioning, login as admin and type 'zerotouch cancel'
at the CLI.
```

```
localhost login:
```

To cancel ZTP mode, log into the switch with the **admin** password, then enter the **zerotouch cancel** command. The switch immediately boots without installing a **startup-config** file.

```
localhost login: admin
admin
localhost>Apr 15 21:28:21 localhost ZeroTouch: %ZTP-5-DHCP_QUERY: Sending
DHCP
request on [ Ethernet10, Ethernet13, Ethernet14, Ethernet17,
Ethernet18,
Ethernet21, E-thernet22, Ethernet23, Ethernet24, Ethernet7, Ethernet8,
Ethernet9, Management1, Management2 ]
Apr 15 21:28:51 localhost ZeroTouch: %ZTP-5-DHCP_QUERY_FAIL: Failed to
get a
valid DHCP response
Apr 15 21:28:51 localhost ZeroTouch: %ZTP-5-RETRY: Retrying Zero Touch
Provisioning from the beginning (attempt 1)
```

```

Apr 15 21:29:22 localhost ZeroTouch: %ZTP-5-DHCP_QUERY: Sending DHCP
request on
[ Ethernet10, Ethernet13, Ethernet14, Ethernet17, Ethernet18,
Ethernet21,
Ethernet22, Ethernet23, Ethernet24, Ethernet7, Ethernet8, Ethernet9,
Management1, Management2 ]

localhost>zerotouch cancel
zerotouch cancel
localhost>Apr 15 21:29:39 localhost ZeroTouch: %ZTP-5-CANCEL: Canceling
Zero
Touch Provisioning
Apr 15 21:29:39 localhost ZeroTouch: %ZTP-5-RELOAD: Rebooting the system
Broadcast messagStopping sshd: [ OK ]
watchdog is not running
SysRq : Remount R/O
Restarting system

About 1.9.0-52504.EOS2.0
Press Control-C now to enter About shell

```

To avoid entering ZTP mode on subsequent reboots, create a **startup-config** file as described in Step 8 of [Ethernet Management Port](#).

3.1.2.3 Ethernet Management Port

Arista switches provide one or more Ethernet management ports for configuring the switch and managing the network out of band. [Figure 2: Switch Ports](#) shows the location of the Ethernet management ports on a DCS-7050T-64 switch. Only one port is required to manage the switch.

You can access the Ethernet management port(s) remotely over a common network or locally through a directly connected PC. Before you can access the switch through a remote connection, an IP address and a static route to the default gateway are required. On a modular switch with dual supervisors, a virtual IP address can also be configured to access the management port on whichever supervisor is active.

Assigning a Virtual IP Address to Access the Active Ethernet Management Port

On modular switches with dual supervisors, this procedure assigns a virtual IP address which will connect to the Ethernet management port of the active supervisor. (To assign a physical IP address to an individual Ethernet management port, see the following section.)

1. Connect a PC or terminal server to the console port. Use the settings listed in [Console Port](#) under [Port Settings](#).
2. Type **admin** at the login prompt to log into the switch. Initial login through the console port does not require a password.

```

Arista EOS
switch login:admin
Last login: Fri Apr 9 14:22:18 on Console
switch>

```

3. Type **enable** at the command prompt to enter Privileged EXEC mode.

```

switch>enable
switch#

```

4. Type **configure terminal** (or **config**) to enter global configuration mode.

```

switch#configure terminal
switch(config)#

```

5. Type **interface management 0** to enter interface configuration mode for the virtual interface which accesses management port 1 on the currently active supervisor.

```
switch(config)#interface management 0
switch(config-if-Ma0)#
```

6. Type **ip address**, followed by the desired address, to assign a virtual IP address for access to the active management port. This command assigns IP address 10.0.2.5 to management port 0

```
switch(config-if-Ma0)#ip address 10.0.2.5/24
```

7. Type **exit** at both the interface configuration and global configuration prompts to return to Privileged EXEC mode.

```
switch(config-if-Ma0)#exit
switch(config)#exit
switch#
```

8. Type **write** (or **copy running-config startup-config**) to save the new configuration to the **startup-config** file.

```
switch# write
switch#
```

Assigning an IP Address to a Specific Ethernet Management Port

This procedure assigns an IP address to a specific Ethernet management port:

1. Connect a PC or terminal server to the console port. Use the settings listed in [Console Port](#) under [Port Settings](#).
2. Type **admin** at the login prompt to log into the switch. The initial login does not require a password.

```
Arista EOS
switch login:admin
Last login: Fri Apr 9 14:22:18 on Console
switch>
```

3. Type **enable** at the command prompt to enter Privileged EXEC mode.

```
switch>enable
switch#
```

4. Type **configure terminal** (or **config**) to enter global configuration mode.

```
switch#configure terminal
```

5. Type **interface management 1** to enter interface configuration mode. (Any available management port can be used in place of management port 1.)

```
switch(config)#interface management 1
switch(config-if-Ma1)#
```

6. Type **ip address**, followed by the desired address, to assign an IP address to the port. This command assigns the IP address 10.0.2.8 to management port 1.

```
switch(config-if-Ma1)#ip address 10.0.2.8/24
```

7. Type **exit** at both the interface configuration and global configuration prompts to return to Privileged EXEC mode.

```
switch(config-if-Ma1)#exit
```

```
switch(config)#exit
switch#
```

8. Type **write** (or **copy running-config startup-config**) to save the new configuration to the **startup-config** file.

```
switch# write
switch#
```

Configuring a Default Route to the Gateway

This procedure configures a default route to a gateway located at 10.0.2.1.

1. Enter global configuration mode.

```
switch>enable
switch#configure terminal
```

2. Create a static route to the gateway with the IP route command.

```
switch(config)#ip route 0.0.0.0/0 10.0.2.1
```

3. Save the new configuration.

```
switch#write
switch#
```

3.2 Connection Management

The switch supports three connection methods:

- console
- SSH
- Telnet

The switch always enables console and SSH. Telnet is disabled by default.

Management commands place the switch in a configuration mode for changing session connection parameters.

Examples

- The **management console** command places the switch in console management mode:

```
switch(config)#management console
switch(config-mgmt-console)#
```

- The **management ssh** command places the switch in SSH management mode:

```
switch(config)#management ssh
switch(config-mgmt-ssh)#
```

- The **management telnet** command places the switch in Telnet management mode:

```
switch(config)#management telnet
switch(config-mgmt-telnet)#
```

- The **exit** command returns the switch to global configuration mode:

```
switch(config-mgmt-ssh)#exit
```

```
switch(config)#
```

The **idle-timeout** commands shown below configure the idle-timeout period for the connection type being configured. The idle timeout is the interval that the connection waits after a users most recent command before shutting down the connection. Automatic connection timeout is disabled by setting the idle-timeout to zero, which is the default setting.

Examples

- This **idle-timeout (SSH Management)** command configures an SSH idle-timeout period of three hours.

```
switch(config)#management ssh
switch(config-mgmt-ssh)#idle-timeout 180
```

- This **idle-timeout (Telnet Management)** command disables automatic connection timeout for telnet connections.

```
switch(config)#management telnet
switch(config-mgmt-telnet)#idle-timeout 0
```

The **shutdown (Telnet Management)** command enables and disables Telnet on the switch.

Examples

- These commands enable Telnet.

```
switch(config)#management telnet
switch(config-mgmt-telnet)#no shutdown
```

- These commands disable Telnet.

```
switch(config)#management telnet
switch(config-mgmt-telnet)#shutdown
```

3.3 Configure Session

The command **configure session** creates a configuration session in which CLI commands can be issued that do not take effect until the session is committed . Each **configure session** is saved with a unique name. A session can be entered, modified and exited at any time without impacting the currently running system configuration.

When a session is committed, the configuration that was modified during the session is copied into **running-config**, overwriting any other configuration changes made since the session was created. A session can be aborted or removed, thereby removing the session completely and freeing up memory used by the session. The user must explicitly request that the changes in a deferred session be applied to the configuration of the router by entering a **commit** command and exiting the mode. Alternately, the user may abandon the changes by entering an **abort** command. An uncommitted configuration session will be discarded if the switch reboots and will time out after 24 hours.

Configuration sessions are used to make sets of changes, after verifying that there are no CLI errors. Configuration sessions allow the administrator to pre-provision a group of CLI commands in a named session, then execute each configuration session at specified times.

3.3.1 Configuration Session

The `configure session` command allows users to make a series of configuration changes in a temporary location and commit them to **running-config** at once by issuing the `commit` command.

- `configure session <name of session>` and **running-config**: The user enters a session (versus **configure terminal** in the case where configuration sessions are not used). If a session name is not specified, a system named session is created. A snapshot of the current **running-config** is copied into the session's data structure as the basis of further configuration changes.
- CLI configuration commands: User can run any configuration commands inside the session.
- `rollback clean-config`: User can run `rollback` command to revert the sessions configuration to the factory-default configuration (or clean configuration).
- `show session-config`: User can run `show session-config` to show the sessions configuration, which will be the future **running-config** once committed.
- `commit`: User issues `commit` to commit the changes, which will replace the current **running-config**.
- `abort`: To abort the session and throw away all changes.
- `exit`: User can `exit` from the session, and later return to the same session by running `configure session <name>` again.
- For named session: More than one CLI instance can enter the same session and make changes to the session configuration. Once the session is committed in any of the CLIs, no other CLI can commit or make any other changes in that session.

 **Note:** committing a configuration session replaces **running-config** with the session configuration, which consists of the running configuration at the time the session was initiated plus the commands that were entered as part of the session. Any changes that were made to **running-config** since the session was initiated will be overwritten when the session is committed.

3.3.2 Configure Replace

The command `configure replace <URL>` replaces the current **running-config** with the configuration saved in `<URL>`. By default, `configure replace <URL>` will replace **running-config** only if the configuration in `<URL>` loads without errors. The command `configure replace <URL> ignore-errors` forces the operation even if there are errors.

 **Note:** The command `copy <URL> running-config` was typically used to apply a saved configuration file to the system, and append that configuration to the current **running-config** (in lieu of replacing it). However, Arista recommends using the CLI command `configure replace <URL>` to streamline the process of deterministically restoring the system back to a known good configuration.

The normal workflow internally uses a configuration session to perform the replace.

3.3.3 Configuration CLI

In the CLI, execute the following configuration steps to create a configuration session.

1. `configure session [name of session]`

Create or enter a session. If a name is not specified, it is automatically generated. The user is put in the session configuration mode and the prompt will change to show the first six characters of the session name. Designating the name of a session is optional. When *name of session* is not specified, a unique name is assigned.

```
no configure session name of session
```

Delete the specified configuration session. Designating the name of a session is required.

2. commit

Commit the changes made in the session. This command must be issued from within the session configuration mode.

```
abort
```

Abort the session, which is the same as deleting it. This command must be issued from within the session configuration mode.

3. rollback clean-config

Revert configuration in the session to the clean, factory-default configuration. This command must be issued from within the session configuration mode.

4. service configuration session max completed *number*

Set a limit on the maximum number of committed sessions that are saved.

5. service configuration session max pending *number*

Set a limit on the maximum number of uncommitted sessions that can be outstanding.

3.4 Recovery Procedures

These sections describe switch recovery procedures:

- [Removing the Enable Password from the Startup Configuration](#)
- [Reverting the Switch to the Factory Default Startup Configuration](#)
- [Restoring the Factory Default EOS Image and Startup Configuration](#)
- [Restoring the Configuration and Image from a USB Flash Drive](#)

The first three procedures require About Shell access through the console port. If the console port is not accessible, use the last procedure in the list to replace the configuration file through the USB Flash Drive.

1 describes the switch booting process and includes descriptions of the About shell, About boot loader, and required configuration files.

3.4.1 Removing the Enable Password from the Startup Configuration

The **enable password** controls access to Privileged EXEC mode. To prevent unauthorized disclosure, the switch stores the **enable password** as an encrypted string that it generates from the clear-text password. When the switch authentication mode is local and an **enable password** is configured, the CLI prompts the user to enter the clear-text password after the user types enable at the EXEC prompt.

The **startup-config** file stores the encrypted **enable password** to ensure that the switch loads it when rebooting. If the text version of the **enable password** is lost or forgotten, access to enable mode is restored by removing the encrypted **enable password** from the startup configuration file.



Note: During the recovery process, in a system containing more than one supervisor, the secondary supervisor must be physically removed from the system. This ensures the previous configuration is not recovered from the secondary supervisor upon reboot during the recovery process.

This procedure restores access to enable mode without changing any other configuration settings.

1. Access the About shell:
 - a. Power cycle the switch by successively removing and restoring access to its power source.
 - b. Type **Ctrl-C** when prompted, early in the boot process.
 - c. Enter the About password, if prompted. If the About password is unknown, refer to [Restoring the Factory Default EOS Image and Startup Configuration](#) for instructions on reverting all flash directory contents to the factory default, including the startup configuration and EOS image.
2. Change the active directory to /mnt/flash directory.

```
About#cd /mnt/flash
```

3. Open the startup-config file in vi.

```
About#vi startup-config
```

4. Remove the enable password line.
This is an example of an enable password line:

```
enable password 5 $1$dBXo2KpF$Pd4XYLpI0ap1ZaU7g1G1w/
```

5. Save the changes and exit vi.
6. Exit About. This boots the switch.

```
About#exit
```

3.4.2 Reverting the Switch to the Factory Default Startup Configuration

The **startup-config** file contains configuration parameters that the switch uses during a boot. Parameters that do not appear in **startup-config** are set to their factory defaults when the switch reloads. The process requires the About password if About is password protected.

This procedure reverts EOS configuration settings to the default state through bypassing the **startup-config** file during a switch boot.

1. Access the About shell through the console port:
 - a. Type **reload** at the Privileged EXEC prompt.
 - b. Type **Ctrl-C** when prompted, early in the boot process.
 - c. Enter the About password, if prompted. If the About password is unknown, refer to [Restoring the Factory Default EOS Image and Startup Configuration](#) for instructions on reverting all flash directory contents to the factory default, including **startup-config** and EOS image.
2. Change the active directory to /mnt/flash directory.

```
About#cd /mnt/flash
```

3. Rename the startup configuration file.

```
About#mv startup-config startup-config.old
```

4. Exit About. This boots the switch

```
About#exit
```

5. Cancel Zero Touch Provisioning (ZTP). Refer to [Canceling Zero Touch Provisioning](#) for instructions. If ZTP is not canceled, the switch either:
 - boots, using the **startup-config** file or boot script that it obtains from the network, or
 - remains in ZTP mode if the switch is unable to download a **startup-config** file or boot script.

6. Configure the **admin** and **enable** passwords.

```
switch>enable
switch#configure terminal
switch(config)#enable password xyz1
switch(config)#username admin secret abc41
```

7. Save the new **running-config** to the startup configuration file.

```
switch#write
```

8. (Optional) Delete the old startup configuration file.

```
switch#delete startup-config.old
```

After ZTP is canceled, the switch reboots, using the factory default settings. To avoid entering ZTP mode on subsequent reboots, create a **startup-config** file before the next switch reboot.

3.4.3 Restoring the Factory Default EOS Image and Startup Configuration

A **fullrecover** command removes all internal flash contents (including configuration files, EOS image files, and user files), then restores the factory default EOS image and **startup-config**. A subsequent installation of the current EOS image may be required if the default image is outdated. This process requires Aboot shell access through the console port.



Note: For hardware that is purchased after June 2017, the factory default partition will not have the backup EOS software image. This is done to increase the flash size on smaller flash size disks and also since other options are available in the **fullrecover** command functionality to restore factory default EOS image. This is applicable to both fixed system and modular system hardware.

This procedure restores the factory default EOS image and startup configuration.

1. Access the Aboot shell through the console port:
 - a. Type **reload** at the Privileged EXEC prompt.
 - b. Type **Ctrl-C** when prompted, early in the boot process.
 - c. Enter the Aboot password, if prompted. If the Aboot password is not known, enter an empty password three times, after which the CLI displays:

```
Type "fullrecover" and press Enter to revert /mnt/flash to factory
default state, or just press Enter to reboot:
```

- d. Type **fullrecover** and go to 4 .
2. Type **fullrecover** at the Aboot prompt.

```
Aboot#fullrecover
```

Aboot displays this warning:

```
All data on /mnt/flash will be erased; type "yes" and press Enter to
proceed, or just press Enter to cancel:
```

3. Type **yes** and press **Enter**.

The switch performs these actions:

- erases the contents of /mnt/flash
- writes new boot-config, startup-config, and EOS.swi files to /mnt/flash
- returns to the Aboot prompt

4. Exit About. This boots the switch.

```
About#exit
```

The serial console settings are restored to their default values (9600/N/8/1/N).

5. Reconfigure the console port if non-default settings are required.
6. Cancel Zero Touch Provisioning (ZTP). Refer to [Canceling Zero Touch Provisioning](#) for instructions. If ZTP is not canceled, the switch either:
 - boots, using the **startup-config** file or boot script that it obtains from the network, or
 - remains in ZTP mode if the switch is unable to download a **startup-config** file or boot script.

After ZTP is canceled, the switch reboots, using the factory default settings. To avoid entering ZTP mode on subsequent reboots, create a **startup-config** file before the next switch reboot.

3.4.4 Restoring the Configuration and Image from a USB Flash Drive

The USB flash drive port can be used to restore an original configuration when you cannot establish a connection to the console port. This process removes the contents of the internal flash drive, restores the factory default configuration, and installs a new EOS image from the USB flash drive.

This procedure restores the factory default configuration and installs an EOS image stored on a USB flash drive.

1. Prepare the USB flash drive:
 - a. Verify the drive is formatted with MS-DOS or FAT file system. Most USB drives are pre-formatted with a compatible file system.
 - b. Create a text file named **fullrecover** on the USB flash drive. The filename does not have an extension. The file may be empty.
 - c. Create a text file named **boot-config**. The last modified timestamp of the **boot-config** file on the USB flash must differ from the timestamp of the **boot-config** file on the switch.
 - d. Enter this line in the new **boot-config** file on the USB flash:

```
SWI=flash:EOS.swi
```

- e. Copy an EOS image file to the flash drive. Rename it **EOS.swi** if it has a different file name. For best results, the flash drive should contain only these three files, because the procedure copies all files and directories on the USB flash drive to the switch.
 - fullrecover
 - boot-config
 - EOS.swi
2. Insert the USB flash drive into the USB flash port on the switch, as shown in [Figure 2: Switch Ports](#).
 3. Connect a terminal to the console port and configure it with the default terminal settings (9600/N/8/1) to monitor progress messages on the console.
 4. Power up or **reload** the switch.

The switch erases internal flash contents and copies the files from the USB flash drive to internal flash. The switch then boots automatically.

5. Cancel Zero Touch Provisioning (ZTP). Refer to [Canceling Zero Touch Provisioning](#) for instructions. If ZTP is not canceled, the switch either:
 - boots, using the startup-config file or boot script that it obtains from the network, or
 - remains in ZTP mode if the switch is unable to download a **startup-config** file or boot script.

After ZTP is canceled, the switch reboots using the factory default settings. To avoid entering ZTP mode on subsequent reboots, create a **startup-config** file before the next switch reboot.

3.5 Session Management Commands

Global Configuration Commands

- `configure replace`
- `configure session`
- `management api http-commands`
- `management console`
- `management ssh`
- `management telnet`
- `management xmpp`

Management Configuration Commands

- `domain` (XMPP Management)
- `idle-timeout` (Console Management)
- `idle-timeout` (SSH Management)
- `idle-timeout` (Telnet Management)
- `protocol http` (API Management)
- `protocol https` (API Management)
- `protocol https certificate` (API Management)
- `server` (XMPP Management)
- `session privilege` (XMPP Management)
- `shutdown` (API Management)
- `shutdown` (Telnet Management)
- `shutdown` (XMPP Management)
- `switch-group` (XMPP Management)
- `username` (XMPP Management)
- `vrf` (API Management)
- `vrf` (XMPP Management)
- `xmpp send`
- `xmpp session`

Display Commands

- `show inventory`
- `show xmpp neighbors`
- `show xmpp status`
- `show xmpp switch-group`

3.5.1 configure replace

The **configure replace** command replaces the current configuration with the new configuration from the specified source.

Command Mode

Privileged EXEC

Command Syntax

```
configure replace {source_file_path:source_file_name | boot-extensions | clean-config |  
installed-extensions | running-config | startup-config}[ignore-errors] [md5 md5sum] [skip-checkpoint]
```

Parameter

- ***source_file_path:source_file_name*** replaces current configuration with the configuration from the specified source file.
- **boot-extensions** replaces current configuration with the boot extensions configuration.
- **clean-config** replaces current configuration with clean and default configurations.
- **installed-extensions** replaces current configuration with the installed extensions configuration.
- **running-config** obsolete.
- **starup-config** replaces current configuration with the startup configuration.
- **ignore-errors** ignores errors while loading the new configuration.
- **md5** *md5sum* performs a checksum to validate data integrity with the specified MD5 hashing algorithm.
- **skip-checkpoint** skips creating the checkpoint file of ***running-config***.

Example

- This command replaces the current configuration state with the startup configuration.

```
switch(config)#configure replace start-config  
! Preserving static routes. Use 'no ip routing delete-static-  
routes' to clear  
them.  
switch#
```

3.5.2 configure session

The `configure session` command allows a series of configuration changes to be made in a temporary location, then committed to *running-config* later by issuing the `commit` command. An uncommitted configuration session will be discarded if the switch reboots and will time out after 24 hours.



Note: committing a configuration session replaces *running-config* with the session configuration, which consists of the running configuration at the time the session was initiated plus the commands that were entered as part of the session. Any changes that were made to *running-config* since the session was initiated will be overwritten when the session is committed.

The `no configure session session_name` and `default configure session session_name` commands delete the specified configuration session.

Command Mode

Privileged EXEC

Command Syntax

```
configure session [session_name]
no configure session session_name
default configure session session_name
```

Parameter

- **session_name** session name

Guidelines

- If a session name is not specified, a session is created with a name generated by the systems.
- The switch permits up to five uncommitted sessions.
- Any uncommitted sessions are discarded when the switch reboots.
- Uncommitted sessions time out after 24 hours.

Example

- This command creates a session (automatically named "sess-1") and adds commands to it. Issuing the `commit` command would cause all of the commands to be executed and would overwrite any configuration performed since the session was created.

```
switch(config)#configure session
switch(config-s-sess-1)#no username kevin
switch(config-s-sess-1)#aaa authentication dot1x default group
radius
switch(config-s-sess-1)#dot1x system-auth-control
switch(config-s-sess-1)#copy running-config startup-config
switch(config-s-sess-1)#reload all now
switch(config-s-sess-1)#
```

3.5.3 domain (XMPP Management)

The `domain` command configures the switch's XMPP domain name. Only messages using a domain matching the locally configured one are accepted by the XMPP client. The switch's domain name is used if none is specified.

Management over XMPP is disabled by default. To enable it, you must provide the location of the server along with the domain, username and password for the switch.

Arista recommends configuring the XMPP domain before the username, because it will provide shortcuts for the `switch-group` and `username` so they can be configured without the domain attached to it (e.g., `USERNAME` instead of `USERNAME@DOMAIN`).

The `no domain` and `default domain` commands delete the domain name by removing the `domain` command from *running-config*.

Command Mode

Mgmt-xmpp Configuration

Command Syntax

`domain` *string*

`no domain`

`default domain`

Parameters

- *string* domain name (text string)

Examples:

- This command configures `test.aristanetworks.com` as the switch's domain name.

```
switch(config)#management xmpp
test1(config-mgmt-xmpp)#server arista-xmpp
test1(config-mgmt-xmpp)#domain test.aristanetworks.com
test1(config-mgmt-xmpp)#username test1@test.aristanetworks.com
password 0 arista
test1(config-mgmt-xmpp)#no shutdown
```

- This command removes the domain name from the XMPP configuration.

```
switch(config-mgmt-xmpp)#no domain
switch(config-mgmt-xmpp)#
```

3.5.4 idle-timeout (Console Management)

The `idle-timeout (Console Management)` command configures the idle-timeout period for console connection sessions. The idle timeout is the interval that the connection waits after a users most recent command before shutting down the connection. Automatic connection timeout is disabled by setting the idle-timeout to zero, which is the default setting.

The `no idle-timeout` and `default idle-timeout` commands disables the automatic connection timeout by removing the `idle-timeout` statement from *running-config*.

Command Mode

Mgmt-console

Command Syntax

```
idle-timeout idle_period
```

```
no idle-timeout
```

```
default idle-timeout
```

Parameters

- ***idle_period*** session idle-timeout length. Options include:
 - **0** Automatic connection timeout is disabled
 - **<1 to 86400>** Automatic timeout period (minutes).

Example

- These commands configure a console idle-timeout period of three hours, then return the switch to global configuration mode.

```
switch(config)#management console
switch(config-mgmt-console)#idle-timeout 180
switch(config-mgmt-console)#exit
switch(config)#
```

- These commands disable automatic connection timeout.

```
switch(config)#management console
switch(config-mgmt-console)#idle-timeout 0
switch(config-mgmt-console)#
```

3.5.5 idle-timeout (SSH Management)

The `idle-timeout (SSH Management)` command configures the idle-timeout period for SSH connection sessions. The idle timeout is the interval that the connection waits after a users most recent command before shutting down the connection. Automatic connection timeout is disabled by setting the idle-timeout to zero, which is the default setting.

The `no idle-timeout` and `default idle-timeout` commands disables the automatic connection timeout by removing the `idle-timeout` statement from *running-config*.

Command Mode

Mgmt-ssh Configuration

Command Syntax

```
idle-timeout idle_period
```

```
no idle-timeout
```

```
default idle-timeout
```

Parameters

- ***idle_period*** session idle-timeout length. Options include:
 - **0** Automatic connection timeout is disabled
 - **<1 to 86400>** Automatic timeout period (minutes).

Example

- These commands configure an ssh idle-timeout period of three hours, then return the switch to global configuration mode.

```
switch(config)#management ssh
switch(config-mgmt-ssh)#idle-timeout 180
switch(config-mgmt-ssh)#exit
switch(config)#
```

- These commands disable automatic connection timeout.

```
switch(config)#management ssh
switch(config-mgmt-ssh)#idle-timeout 0
switch(config-mgmt-ssh)#
```

3.5.6 idle-timeout (Telnet Management)

The `idle-timeout (Telnet Management)` command configures the idle-timeout period for Telnet connection sessions. The idle timeout is the interval that the connection waits after a users most recent command before shutting down the connection. Automatic connection timeout is disabled by setting the idle-timeout to zero, which is the default setting.

The `no idle-timeout` and `default idle-timeout` commands disables the automatic connection timeout by removing the `idle-timeout` statement from *running-config*.

Command Mode

Mgmt-telnet

Command Syntax

```
idle-timeout idle_period
```

```
no idle-timeout
```

```
default idle-timeout
```

Parameters

- ***idle_period*** session idle-timeout length. Options include:
 - **0** Automatic connection timeout is disabled
 - **<1 to 86400>** Automatic timeout period (minutes).

Example

- These commands configure a telnet idle-timeout period of three hours, then return the switch to global configuration mode.

```
switch(config)#management telnet
switch(config-mgmt-telnet)#idle-timeout 180
switch(config-mgmt-telnet)#exit
switch(config)#
```

- These commands disable automatic connection timeout.

```
switch(config)#management telnet
switch(config-mgmt-telnet)#idle-timeout 0
switch(config-mgmt-telnet)#
```

3.5.7 management api http-commands

The `management api http-commands` command places the switch in mgmt-API configuration mode.

The `no management api http-commands` and `default management api http-commands` commands delete mgmt-api-http-command configuration mode statements from *running-config*.

Mgmt-api-http-cmds configuration mode is not a group change mode; *running-config* is changed immediately upon entering commands. Exiting mgmt-api-http-cmds configuration mode does not affect *running-config*. The `exit` command returns the switch to global configuration mode.

Command Mode

Global Configuration

Command Syntax

```
management api http-commands
```

```
no management api http-commands
```

```
default management api http-commands
```

Commands Available in Mgmt-API Configuration Mode

- [protocol http \(API Management\)](#)
- [protocol https \(API Management\)](#)
- [protocol https certificate \(API Management\)](#)
- [shutdown \(API Management\)](#)
- [vrf \(API Management\)](#)

Example

- This command places the switch in mgmt-api-http-cmds configuration mode.

```
switch(config)#management api http-commands  
switch(config-mgmt-api-http-cmds)#
```

- This command returns the switch to global management mode.

```
switch(config-mgmt-api-http-cmds)#exit  
switch(config)#
```

3.5.8 management console

The **management console** command places the switch in mgmt-console configuration mode to adjust the idle-timeout period for console connection sessions. The idle-timeout period determines the inactivity interval that terminates a connection session.

The **no management console** and **default management console** commands delete mgmt-console configuration mode statements from *running-config*.

Mgmt-console configuration mode is not a group change mode; *running-config* is changed immediately upon entering commands. Exiting mgmt-console configuration mode does not affect *running-config*. The **exit** command returns the switch to global configuration mode.

Command Mode

Global Configuration

Command Syntax

```
management console
```

```
no management console
```

```
default management console
```

Commands Available in mgmt-console Configuration Mode

- [idle-timeout \(Console Management\)](#)

Example

- This command places the switch in mgmt-console configuration mode:

```
switch(config)#management console  
switch(config-mgmt-console)#
```

- This command returns the switch to global management mode:

```
switch(config-mgmt-console)#exit  
switch(config)#
```

3.5.9 management ssh

The **management ssh** command places the switch in mgmt-ssh configuration mode to adjust SSH session connection parameters.

The **no management ssh** and **default management ssh** commands delete the mgmt-ssh configuration mode statements from *running-config*.

Mgmt-ssh configuration mode is not a group change mode; *running-config* is changed immediately upon entering commands. Exiting mgmt-ssh configuration mode does not affect *running-config*. The **exit** command returns the switch to global configuration mode.

Command Mode

Global Configuration

Command Syntax

```
management ssh
```

```
no management ssh
```

```
default management ssh
```

Commands Available in Mgmt-ssh Configuration Mode

- authentication mode (Management-SSH)
- cipher (Management-SSH)
- fips restrictions (Management-SSH)
- hostkey (Management-SSH)
- idle-timeout (Management-SSH)
- ip access group (Management-SSH)
- ipv6 access group (Management-SSH)
- key-exchange (Management-SSH)
- login timeout (Management-SSH)
- mac hmac (Management-SSH)
- server-port (Management-SSH)
- shutdown (Management-SSH)
- vrf (Management-SSH)

Example

- This command places the switch in mgmt-ssh configuration mode:

```
switch(config)#management ssh  
switch(config-mgmt-ssh)#
```

- This command returns the switch to global management mode:

```
switch(config-mgmt-ssh)#exit  
switch(config)#
```

3.5.10 management telnet

The **management telnet** command places the switch in mgmt-telnet configuration mode to adjust telnet session connection parameters.

The **no management telnet** and **default management telnet** commands delete the mgmt-telnet configuration mode statements from **running-config**.

Mgmt-telnet configuration mode is not a group change mode; **running-config** is changed immediately upon entering commands. Exiting mgmt-telnet configuration mode does not affect **running-config**. The **exit** command returns the switch to global configuration mode.

Command Mode

Global Configuration

Command Syntax

```
management telnet
```

```
no management telnet
```

```
default management telnet
```

Commands Available in mgmt-telnet Configuration Mode

- idle-timeout (Management-Telnet)
- ip access group (Management-Telnet)
- ipv6 access group (Management-Telnet)
- shutdown (Management-Telnet)
- vrf (Management-Telnet)

Example

- This command places the switch in mgmt-telnet configuration mode:

```
switch(config)#management telnet  
switch(config-mgmt-telnet)#
```

- This command returns the switch to global management mode:

```
switch(config-mgmt-telnet)#exit  
switch(config)#
```

3.5.11 management xmpp

The **management xmpp** command places the switch in mgmt-xmpp configuration mode. Management over XMPP is disabled by default. To enable XMPP, you must provide the location of the XMPP server along with the username and password for the switch.

The **no management xmpp** and **default management xmpp** commands delete the mgmt-xmpp configuration mode statements from *running-config*.

Mgmt-xmpp configuration mode is not a group change mode; *running-config* is changed immediately upon entering commands. Exiting mgmt-xmpp configuration mode does not affect *running-config*. The **exit** command returns the switch to global configuration mode.

Command Mode

Global Configuration

Command Syntax

```
management xmpp
```

```
no management xmpp
```

```
default management xmpp
```

Commands Available in Mgmt-xmpp Configuration Mode

- domain (Management-xmpp)
- server (Management-xmpp)
- session (Management-xmpp)
- shutdown (Management-xmpp)
- switch-group (Management-xmpp)
- username (Management-xmpp)
- vrf (Management-xmpp)

Example

- This command places the switch in mgmt-xmpp configuration mode:

```
switch(config)#management xmpp  
switch(config-mgmt-xmpp)#
```

- This command returns the switch to global management mode:

```
switch(config-mgmt-xmpp)#exit  
switch(config-mgmt-xmpp)#
```

3.5.12 protocol http (API Management)

The `protocol http` command enables the hypertext transfer protocol (HTTP) server.

The `no protocol http` and `default protocol http` commands disable the HTTP server by removing the `protocol http` statement from *running-config*.

Command Mode

Mgmt-API Configuration

Command Syntax

```
protocol http [TCP_PORT ]
```

```
no protocol http
```

```
default protocol http
```

Parameters

- **TCP_PORT** Port number to be used for the HTTP server. Options include:
 - **<no parameter>** Specifies default port number 80.
 - **port <1 to 65535>** Specifies HTTP server port number. Value ranges from **1** to **65535**.
- **localhost** The name of the server bound on the localhost.
- **port** The number of the TCP port to serve on.

Related Commands

- [management api http-commands](#) places the switch in mgmt-api configuration mode.

Examples

- These commands enable the management API for the HTTP server.

```
switch(config)#management api http-commands  
switch(config-mgmt-api-http-cmds)#
```

3.5.13 protocol https (API Management)

The `protocol https` command enables the HTTP secure server. The HTTP secure server is active by default.

The `default protocol https` command restores the default setting by removing the `no protocol https` statement from *running-config*. The `no protocol https` command disables the HTTP secure server.

Command Mode

Mgmt-API Configuration

Command Syntax

```
protocol https [TCP_PORT ]
```

```
no protocol https
```

```
default protocol https
```

Parameters

- **TCP_PORT** Port number to be used for the HTTPS server. Options include:
 - **<no parameter>** Specifies default port number 443.
 - **port <1 to 65535>** Specifies HTTP server port number. Value ranges from 1 to 65535.
- **certificate** The HTTPS key and certificate to use.
- **cipher** Exclusive list of cryptographic ciphers.
- **key-exchange** Exclusive list of key-exchange algorithms.
- **mac** Exclusive list of MAC algorithms.
- **port** The number of the TCP port to serve on.
- **ssl** Configure SSL options.

Related Commands

- [management api http-commands](#) places the switch in mgmt-api configuration mode.

Examples

- These commands enables service to the HTTP server. The `no shutdown` command allows access to the service.

```
switch(config)#management api http-commands
switch(config-mgmt-api-http-cmds)#protocol https
switch(config-mgmt-api-http-cmds)# no shutdown
```

- These commands specifies the port number that should be used for the HTTPS server. The `no shutdown` command allows access to the service.

```
switch(config)#management api http-commands
switch(config-mgmt-api-http-cmds)#protocol https port 52
switch(config-mgmt-api-http-cmds)#no shutdown
```

3.5.14 protocol https certificate (API Management)

The `protocol https certificate` command configures the HTTP secure server to request an X.509 certificate from the client. The client then authenticates the certificate with a public key.

The `no protocol https certificate` and `default protocol https certificate` commands restore default behavior by removing the `protocol https certificate` statement from *running-config*.

Command Mode

Mgmt-API Configuration

Command Syntax

```
protocol https certificate
no protocol https certificate
default protocol https certificate
```

Related Commands

- [management api http-commands](#) places the switch in mgmt-api configuration mode.

Examples

- These commands configure the HTTP secure server to request an X.509 certificate from the client for authentication.

```
switch(config)#management api http-commands
switch(config-mgmt-api-http-cmds)#protocol https certificate
switch(config-mgmt-api-http-cmds)#
```

3.5.15 server (XMPP Management)

The **server** command adds a XMPP server to *running-config*. Multiple XMPP servers can be set up for redundancy. For redundant configurations, the XMPP server location should be a DNS name and not a raw IP address. The DNS server is responsible for returning the list of available XMPP servers, which the client can go through until an accessible server is found.

User authentication is provided by the XMPP server. Command authorization can be provided by EOS local configuration or TACACS+. The XMPP server should use the same authentication source as the switches. RADIUS is not supported as an XMPP authorization mechanism.

The **no server** and **default server** commands remove the specified XMPP server from *running-config*.

Command Mode

Mgmt-xmpp Configuration

Command Syntax

```
server SERVER_NAME [SERVER_PORT]
```

```
no server
```

```
default server
```

Parameters

- **SERVER_NAME** XMPP server location. Options include:
 - **IP address** in dotted decimal notation.
 - a host name for the XMPP server.
- **SERVER_PORT** Server port. Options include:
 - **port <1 to 65535 >** where *number* ranges from 1 to 65535. If no port is specified, the default port 5222 is used.

Examples

- This command configures the server hostname **arista-xmpp** to **server port 1**.

```
switch(config)#management xmpp
switch(config-mgmt-xmpp)#server arista-xmpp port 1
```

- This command removes the XMPP server.

```
switch(config-mgmt-xmpp)# no server
```

3.5.16 session privilege (XMPP Management)

The `session privilege` command will place the user in EXEC mode. The initial privilege level is meaningless by default. However, with the configuration of roles, users can add meaning to the different privilege levels. By default, XMPP does not limit access to any command.

Level 1-15: Commands accessible from EXEC Mode.

If AAA is not configured and the switch is configured to connect to the XMPP client, any message received is executed with privilege level 1 by default.

The `no session privilege` and `default session privilege` commands revert the list contents to **none** for the specified privilege levels.

Command Mode

Mgmt-xmpp Configuration

Command Syntax

```
session privilege PRIV_LEVEL
```

```
no session privilege
```

```
default session privilege
```

Parameters

- **PRIV_LEVEL** Privilege levels of the commands. Value ranges from **0** and **15**.

Examples

- These commands authorizes configuration commands (privilege level config 5) for XMPP.

```
switch(config)#(config)#management xmpp  
switch(config-mgmt-xmpp)#session privilege 5  
switch(config-mgmt-xmpp)#
```

- This command removes the privilege levels set for the XMPP session.

```
switch(config)#management xmpp  
switch(config-mgmt-xmpp)#no session privilege
```

3.5.17 show inventory

The `show inventory` command displays the hardware components installed in the switch. Serial numbers and a description is also provided for each component.

Command Mode

EXEC

Command Syntax

```
show inventory
```

Examples

- This command displays the hardware installed in a DCS-7150S-52 switch.

```
switch>show inventory
System information
  Model                               Description
  -----
DCS-7150S-52-CL                       52-port SFP+ 10GigE 1RU + Clock

HW Version  Serial Number  Mfg Date
-----
02.00       JPE13120702    2013-03-27

System has 2 power supply slots
Slot Model                               Serial Number
-----
1   PWR-460AC-F                          K192KU00241CZ
2   PWR-460AC-F                          K192L200751CZ

System has 4 fan modules
Module Number of Fans  Model                               Serial Number
-----
1     1                FAN-7000-F                          N/A
2     1                FAN-7000-F                          N/A
3     1                FAN-7000-F                          N/A
4     1                FAN-7000-F                          N/A

System has 53 ports
Type                               Count
-----
Management                          1
Switched                             52

System has 52 transceiver slots
Port Manufacturer  Model                               Serial Number  Rev
-----
1   Arista Networks  SFP-10G-SR                       XCW1225FD753  0002
2   Arista Networks  SFP-10G-SR                       XCW1225FD753  0002

51  Arista Networks  SFP-10G-SR                       XCW1225FD753  0002
52  Arista Networks  SFP-10G-SR                       XCW1225FD753  0002

switch>
```

3.5.18 show xmpp neighbors

The `show xmpp neighbors` command displays all neighbors and their connection status. The XMPP server keeps track of all relationships between its users.

Command Mode

EXEC

Command Syntax

```
show xmpp neighbors
```

Example

- This command displays all the XMPP neighbors and their connection status.

```
switch#show xmpp neighbors
Neighbor                               State           Last Seen Login Time
-----                               -
admin@test.aristanetworks.com         present         0:01:40 ago
test1@test.aristanetworks.com         present         20:29:39 ago

Neighbor                               Status Message
-----                               -
admin@test.aristanetworks.com
test1@test.aristanetworks.com         Arista Networks DCS-7048T-4S
switch#
```

3.5.19 show xmpp status

The `show xmpp status` command displays the current XMPP connection status to the server.

The XMPP server keeps track of all relationships between its users. In order for two users to directly communicate, this relationship must first be established and confirmed by the other party.

Switches automatically confirm requests from outside parties as long as they are a user from the same domain name, for example when you chat with your switch from your own XMPP chat client.

Command Mode

EXEC

Command Syntax

```
show xmpp status
```

Example

- This command displays the current XMPP connection status to the server.

```
switch#show xmpp status
XMPP Server:  port 5222
Client username: test@test.aristanetworks.com
Default domain: test.aristanetworks.com
Connection status: connected
switch#
```

3.5.20 show xmpp switch-group

The `show xmpp switch-group` command displays the configured and active switch groups for the switch.

Command Mode

EXEC

Command Syntax

```
show xmpp switch-group
```

Example

- This command displays the configured and active switch groups.

```
switch#show xmpp switch-group
testroom@conference.test.aristanetworks.com
switch#
```

3.5.21 shutdown (API Management)

The **shutdown** command, in mgmt-api configuration mode, disables management over API on the switch. API is disabled by default.

The **no shutdown** command, in mgmt-api configuration mode, enables the management API access.

The **default shutdown** command, in mgmt-api configuration mode, disables the management API access.

Command Mode

Mgmt-API Configuration

Command Syntax

```
shutdown
```

```
no shutdown
```

```
default shutdown
```

Related Commands

- [management api http-commands](#) places the switch in mgmt-api configuration mode.

Example

- These commands disables API access to the HTTP server.

```
switch(config)#management api http-commands
switch(config-mgmt-api-http-cmds)# shutdown
switch(config-mgmt-api-http-cmds)#
```

- These commands enables API access to the HTTP server.

```
switch(config)#management api http-commands
switch(config-mgmt-api-http-cmds)# no shutdown
switch(config-mgmt-api-http-cmds)#
```

3.5.22 shutdown (Telnet Management)

The **shutdown** command, in management-telnet mode, disables or enables Telnet on the switch. Telnet is disabled by default. The [management telnet](#) command places the switch in management-telnet mode.

- To enable Telnet, enter **no shutdown** at the management-telnet prompt.
- To disable Telnet, enter **shutdown** at the management-telnet prompt.

Command Mode

Management-Telnet Configuration

Command Syntax

```
shutdown
```

```
no shutdown
```

Example

- These commands enable Telnet, then return the switch to global configuration mode.

```
switch(config)#management telnet  
switch(config-mgmt-telnet)#no shutdown  
switch(config-mgmt-telnet)#exit  
switch(config)#
```

- This command disables Telnet.

```
switch(config-mgmt-telnet)#shutdown
```

3.5.23 shutdown (XMPP Management)

The **shutdown** command, in `mgmt-xmpp` mode, disables or enables management over XMPP on the switch. XMPP is disabled by default.

The **no shutdown** and **default shutdown** commands re-enable XMPP by removing the **shutdown** command from *running-config*.

Command Mode

Mgmt-xmpp Configuration

Command Syntax

```
shutdown
```

```
no shutdown
```

```
default shutdown
```

Example

- These commands enable management over XMPP, then return the switch to global configuration mode.

```
switch(config-mgmt-xmpp) #no shutdown
switch(config-mgmt-xmpp) #exit
switch(config) #
```

- This command disables management over XMPP.

```
switch(config-mgmt-xmpp) #shutdown
switch(config-mgmt-xmpp) #
```

3.5.24 switch-group (XMPP Management)

The `switch-group` command allows you to configure each switch to join specified chat rooms on startup. In order for the switch to participate in a chat group, the switch has to be configured to belong to the specified chat room.

The `no switch-group` and `default switch-group` commands delete the specified switch-group configuration (or all switch-group configurations if no name is specified) by removing the corresponding `switch-group` statement from *running-config*.

Command Mode

Mgmt-xmpp Configuration

Command Syntax

```
switch-group name SECURITY
```

```
no switch-group
```

```
default switch-group
```

Parameters

- ***name*** Group name text that the user enters at the login prompt to access the CLI. To enter multiple names in a single command, separate them with spaces.

Valid usernames begin with A-Z, a-z, or 0-9 and may also contain any of these characters:

```
@ # $ % ^ & * - _ = + ; < > , . ~ |
```

- **SECURITY** password assignment.
 - **password *pwd_txt*** *name* is protected by specified password. *pwd_txt* is a clear-text string.
 - **password 0** *pwd_txt* *name* is protected by specified password. *pwd_txt* is a clear-text string.
 - **password 7** *pwd_txt* *name* is protected by specified password. *pwd_txt* is encrypted string.

Guidelines

- A switch group is an arbitrary grouping of switches within the network which belong to one chat group.
- In order to belong to one or more switch groups, the switch has to be manually assigned to it.
- Switch groups are defined dynamically based on the configuration of all of the switches in the network.
- As per the multi-user chat XMPP standard (XEP-0045), switch groups have a full name of GROUPNAME@conference.DOMAIN
- All CLI commands allow either the full group name or the short name, which are appended the @conference.DOMAIN
- If the switch belongs to multiple chat rooms, you must configure each group with a separate command.

Examples

- These commands configure the switch-group to be part of the chat room.

```
switch(config)#management xmpp
switch(config-mgmt-xmpp)# switch-group
testroom@conference.test.aristanetworks.com password 0 arista
```

- Use the `show xmpp switch-group` to verify the active switch-group for the switch.

```
switch# show xmpp switch-group
```

testroom@conference.test.aristanetworks.com

3.5.25 username (XMPP Management)

The **username** command configures the switch's username and password on the XMPP server.

The **no username** and **default username** commands delete the specified username by removing the corresponding **username** statement from *running-config*.

Command Mode

Mgmt-xmpp Configuration

Command Syntax

```
username name SECURITY
```

```
no username
```

```
default username
```

Parameters

- **name** username text that defines the XMPP username and password.

Valid usernames begin with A-Z, a-z, or 0-9 and may also contain any of these characters:

```
@ # $ % ^ & * ( ) - _ = + { } [ ] ; < > , . ~ |
```

- **SECURITY** password assignment.
 - **password** *pwd_txt name* specifies and unencrypted shared key. *pwd_txt* is a clear-text string.
 - **password 0** *pwd_txt name* specifies and unencrypted key. *pwd_txt* is a clear-text string.
 - **password 7** *pwd_txt name* specifies a hidden key. *pwd_txt* is encrypted string.

Guidelines

Encrypted strings entered through this parameter are generated elsewhere. The **password 7** option (**SECURITY**) is typically used to enter a list of username-passwords from a script.

Examples

- These commands create the username and assigns it a password. The password is entered in clear text because the parameter is set to 0.

```
switch(config)#management xmpp
switch(config-mgmt-xmpp)#server arista-xmpp
switch(config-mgmt-xmpp)#domain test.aristanetworks.com
switch(config-mgmt-xmpp)#username test1@test.aristanetworks.
com password 0
arista
switch(config-mgmt-xmpp)#no shutdown
```

- This command removes all usernames from the XMPP server.

```
switch(config-mgmt-xmpp)#no username
switch(config-mgmt-xmpp)#
```

3.5.26 vrf (API Management)

The `vrf` command places the switch in VRF configuration mode for the server. If the named VRF does not already exist, this command creates it.

Command Mode

Mgmt-API Configuration

Command Syntax

```
vrf VRF_INSTANCE
```

Parameters

- **VRF_INSTANCE** specifies the VRF instance.
 - **default** Instance is created in the default VRF.
 - **vrf_name** Instance is created in the specified user-defined VRF.

Related Commands

- [management api http-commands](#) places the switch in mgmt-api configuration mode.

Example

- This command creates a VRF named management-vrf and places the switch in VRF configuration mode for the new VRF.

```
switch(config)#management api http-commands  
switch(config-mgmt-api-http-cmds)#vrf management-vrf  
switch(config-mgmt-api-http-cmds-vrf-management-vrf)#
```

3.5.27 vrf (XMPP Management)

The `vrf` command places the switch in VRF configuration mode for the XMPP server. If the named VRF does not already exist, this command creates it.

The VRF configuration for the client is for the entire XMPP service, rather than per server. All servers resolving on a particular hostname must be reachable in the same VRF.

Command Mode

Mgmt-xmpp Configuration

Command Syntax

```
vrf [VRF_INSTANCE]
```

Parameters

- **VRF_INSTANCE** specifies the VRF instance.
 - **default** Instance is created in the default VRF.
 - **vrf_name** Instance is created in the specified user-defined VRF.

Example

- This command creates a VRF named `management-vrf` and places the switch in VRF configuration mode for the server.

```
switch(config)#management xmpp
switch(config-mgmt-xmpp)#vrf management-vrf
switch(config-mgmt-xmpp)
```

3.5.28 xmpp send

The `xmpp send` command can be used to connect to the XMPP server and send messages to switches or switch groups within the network.

Before switches can send messages to each other, they must friend each other. An easy way to have them auto friend each other is to have them join the same chat room. The friendship between switches can be verified by using the `show xmpp neighbor` command.

Command Mode

Privileged EXEC

Command Syntax

```
xmpp send to neighbor XMIT_TYPE content
```

Parameters

- **neighbor** Options include switches or switch groups within the network that are connected as friends in a chat room.
- **XMIT_TYPE** Transmission type. Valid options include:
 - **command** Sends an XMPP command.
 - **message** Sends an XMPP message.
- **content** The command you want the friends within the chat room to display or execute.

Configuration Restrictions

- Only enable-mode commands are allowed within the multi-switch CLI.
- Changing into a different CLI mode and running several commands in that mode is not supported (e.g., into configuration mode)
- An external XMPP client (for example Adium) can be used to send multiple lines within a single message. By sending multiple lines, it is possible to change into another CLI mode. After the message is processed, the switch automatically return to the enable mode.
- Commands that prompt for a response (like reload) are not supported.
- Long commands, such as image file copies, may cause the switch XMPP client to momentarily stop responding and disconnect. The switch should reconnect and the long command should complete.
- Many command outputs display in a specific table format. To achieve the same visual feel as through a terminal, use a monospaced font, such as Courier, for the incoming messages.

Example

- This command sends the switch in the chat room the request to execute the show version command.

```
switch# xmpp send test2 command show version
message from user: test2@test.aristanetworks.com
-----
Hardware version:      04.40
Serial number:        JFL08432083
System MAC address:   001c.7301.7d69
Software image version: 4.12.3
Architecture:         i386
Internal build version: 4.12.3
Internal build ID:    f5ab5f57-9c26-4fe4-aaa-fb60fa55d01d
Uptime:               2 hours and 38 minutes
Total memory:         1197548 kB
Free memory:          182452 kB
```

3.5.29 xmpp session

The `xmpp session` command is similar to running SSH from the switch. The user is required to input their username (default is to `USER@DEFAULTDOMAIN`) and password in order to connect to the XMPP server. This command allows you to interact in the enable mode with a switch or switch group over XMPP using the standard CLI, with access to help and tab completion. All commands are then executed remotely and only the non-empty results are displayed on the screen.

Command Mode

Privileged EXEC

Command Syntax

```
xmpp session switchgroup
```

Parameters

- ***switchgroup*** The option includes the switch group within the network that is connected as friends in a chat room.

Configuration Restrictions

- Only enable-mode commands are allowed within the multi-switch CLI.
- Changing into a different CLI mode and running several commands in that mode is not supported (e.g., into configuration mode)
- An external XMPP client (for example Adium) can be used to send multiple lines within a single message. By sending multiple lines, it is possible to change into another CLI mode. After the message is processed, the switch automatically return to the enable mode.
- Commands that prompt for a response (like reload) are not supported.
- Long commands, such as image file copies, may cause the switch XMPP client to momentarily stop responding and disconnect. The switch should reconnect and the long command should complete.
- Many command outputs display in a specific table format. To achieve the same visual feel as through a terminal, use a monospaced font, such as Courier, for the incoming messages.

Example

- This command displays the status of Ethernet 3 from test1, which is a member of the switch group chat room.

```
switch# xmpp session all@test.aristanetworks.com
xmpp-all# show int Eth3 status

response from: test1@test.aristanetworks.com

-----

Port  Name  Status      Vlan    Duplex  Speed  Type
Et3   bs3   connected  in Po3  a-full  a-1000 10GBASE-SR
switch#
```

Administering the Switch

This chapter describes administrative tasks that are typically performed only after initially configuring the switch or after recovery procedures.

This chapter includes these sections:

- [Managing the Switch Name](#)
- [System Clock and Time Protocols](#)
- [Managing Display Attributes](#)
- [Logging of Event Notifications](#)
- [Event Monitor](#)
- [Managing EOS Extensions](#)
- [7130 Layer 1 Configuration](#)
- [Switch Administration Commands](#)

4.1 Managing the Switch Name

These sections describe how to configure the switch's domain and host name.

- [Assigning a Name to the Switch](#) describes the assigning of an FQDN to the switch.
- [Specifying DNS Addresses](#) describes the adding of name servers to the configuration.

4.1.1 Assigning a Name to the Switch

A fully qualified domain name (FQDN) labels the switch and defines its organization ID in the Domain Name System hierarchy. The switch's FQDN consists of a host name and domain name.

The host name is uniquely associated with one device within an IP-domain. The default host name is `localhost`. You can configure the prompt to display the host name, as described in [prompt](#).

- To assign a host name to the switch, use the `hostname` command. To return the switch's host name to the default value of `localhost`, use the `no hostname` command.
- To specify the domain location of the switch, use the `dns domain` command.

Example

- This command assigns the string `main-host` as the switch's host name.

```
switch(config)#hostname main-host
main-host(config)#
```

- This command configures `aristanetworks.com` as the switch's domain name.

```
switch(config)#dns domain aristanetworks.com
switch(config)#
```

- This procedure configures `sales1.samplecorp.org` as the switch's FQDN.

```
switch(config)#dns domain samplecorp.org
switch(config)#
```

- This *running-config* extract contains the switchs host name and IP-domain name.

```
switch#show running-config
! Command: show running-config
! device: switch (DCS-7150S-64-CL, EOS-4.13.2F)
!
vlan 3-4
!
username john secret 5 $1$a7Hjept9$TIKRX6ytkg8o.ENja.na50
!
hostname sales1
ip name-server vrf default 172.17.0.22
dns domain samplecorp.org
!
end
switch#
```

4.1.2 Specifying DNS Addresses

The Domain Name Server (DNS) maps FQDN labels to IP addresses and provides addresses for network devices. Each network requires at least one server to resolve addresses. The configuration file can list a maximum of three server addresses.

To add name servers to the configuration, use the `ip name-server` command. Each command can add multiple servers. All server addresses support multiple VRFs and a priority may be specified for each name server. If all name servers have the default priority (0) the default DNSmasq behavior is followed for the configuration. It queries all name servers simultaneously and forwards the requests to the first name server for 50 queries or 20 seconds, whichever expires sooner for answering. If any priorities are non-zero, queries are issued in-order with a 5 second timeout between unresponsive name servers.

Example

- This code displays the configuration file.

```
switch(config)#show ip name-server
IP Address VRF      Priority
-----
10.0.0.1   default          0
10.0.0.2   default          1
10.0.0.1   vrf1             2
10.0.0.2   vrf1             3
fc00::1    default          4
```

The switch assigns source IP addresses to outgoing DNS requests. To force the switch to use a single, user-defined source interface for all requests, use the `ip domain lookup` command.

Example

- This command forces the switch to use VLAN 5 as the source interface for DNS requests originating from the default VRF.

```
switch(config)#ip domain lookup source-interface Vlan5
switch(config)#
```

- This command forces the switch to use VLAN 10 as the source interface for DNS requests originating from VRF purple.

```
switch(config)#ip domain lookup vrf purple source-interface Vlan10
switch(config)#
```

- This command configures up to 4 name servers on VRF purple.

```
switch(config)#ip name-server vrf purple 10.1.1.24 priority 4
switch(config)#
```

- This command removes the name servers.

```
switch(config)#ip name-server vrf purple 10.1.1.24
switch(config)#
```

- This command removes all configured name in all VRFs.

```
switch(config)#no ip name-server
switch(config)#
```

Limitations

- DNSmasq does not fulfill in-flight requests to unresponsive name servers.
- For set priorities, the EOS-generated file `/etc/resolv.conf` retries queries for all name servers.
- Few DNS utilities attempt a fixed number of retries unless otherwise specified. For example, `nslookup`.



Note:

`NXDOMAIN` is considered a valid reply for the query.

4.2 System Clock and Time Protocols

The switch uses the system clock for displaying the time and for time-stamping messages. The system clock is set to Coordinated Universal Time (UTC); the switch calculates local time based on the time zone setting. Time-stamps and time displays are in local time. The system clock can be set either manually or via Network Time Protocol (NTP); any NTP servers properly configured on the switch override time that is manually entered.

The following sections deal with the configuration of the system clock and the use of NTP and PTP.

- [Configuring the Time Zone](#)
- [Setting the System Clock Manually](#)
- [Displaying the Time](#)
- [Network Time Protocol \(NTP\)](#)

4.2.1 Configuring the Time Zone

The time zone setting is used by the switch to convert the system time (UTC) to local time. To specify the time zone, use the `clock timezone` command.

Examples

- These commands configure the switch for the United States Central Time Zone.

```
switch(config)#clock timezone US/Central
```

```
switch(config)#show clock
Mon Jan 14 18:42:49 2013
timezone is US/Central
switch(config)#
```

- To view the predefined time zone labels, enter **clock timezone** with a question mark.

```
switch(config)#clock timezone ?
Africa/Abidjan          Africa/Accra
WET                     WET timezone
Zulu                    Zulu timezone

switch(config)#clock timezone
```

- This command displays all time zone labels that start with **America**.

```
switch(config)#clock timezone AMERICA?
America/Adak            America/Anchorage

America/Yellowknife
switch(config)#clock timezone AMERICA
```

4.2.2 Setting the System Clock Manually

The **clock set** command manually configures the system clock time and date, in local time. Any NTP servers properly configured on the switch override time that is manually entered.

Example

This command manually sets the switch time.

```
switch#clock set 08:15:24 14 Jan 2013
Mon Jan 14 08:15:25 2013
timezone is US/Central
```

4.2.3 Displaying the Time

To display the local time and configured time zone, enter the **show clock** command.

Example

- This command displays the switch time.

```
switch(config)#show clock
Mon Jan 14 16:32:46 2013
timezone is America/Los_Angeles
```

4.2.4 Network Time Protocol (NTP)

Network Time Protocol (NTP) is enabled on the switch by default, and time settings from any properly configured NTP server will override manual setting of the system clock.

NTP servers synchronize time settings of systems running an NTP client. The switch supports NTP versions 1 through 4. The default is version 4. After configuring the switch to synchronize with an NTP server, it may take up to ten minutes for the switch to set its clock. The **running-config** lists NTP servers that the switch is configured to use.

The following NTP sections deal with NTP on the switch:

- [Configuring the NTP Server](#)

- [Configuring the NTP Source](#)
- [Configuring the Switch as an NTP Server](#)
- [Configuring NTP Authentication](#)
- [Viewing NTP Settings and Status](#)

4.2.4.1 Configuring the NTP Server

The `ntp server` command adds a server to the list or modifies the parameters of a previously listed address. When the system contains multiple NTP servers, the `prefer` keyword can be used to specify a preferred NTP server, which will be used as the NTP server if not discarded by NTP.

Note that all NTP servers must be in the same VRF, and that they are added in the default VRF if no VRF is specified.

The system clock will be set via NTP if NTP is enabled and there is at least one NTP server properly configured on the switch, and NTP overrides manual setting of the system clock. NTP is enabled by default. To disable NTP, use the `no ntp` command.

Example

- These commands add three NTP servers, designating the second server as preferred.

```
switch(config)#ntp server local-NTP
switch(config)#ntp server 172.16.0.23 Prefer
switch(config)#ntp server 172.16.0.25
```

4.2.4.2 Configuring the NTP Source

The `ntp local-interface` command configures an interface as the source of NTP packets. That interface's IP address is then used as the source address for all NTP packets unless a server-specific source is configured using the `source` option of the `ntp server` command. For an `ntp local-interface` command to take effect, the specified interface and the NTP server must both belong to the same VRF.

Example

- This command configures VLAN interface 25 as the source of NTP update packets.

```
switch(config)#ntp local-interface vlan 25
switch(config)#
```

4.2.4.3 Configuring the Switch as an NTP Server

To configure the switch to accept NTP requests on all interfaces, use the `ntp serve all` command to enable NTP server mode globally on the switch. To configure an individual interface to accept or deny NTP requests, use the `ntp serve` command. Interface level settings override the global settings, and changing the settings at either the global or interface level also causes the switch to re-synchronize with its upstream NTP server. NTP server mode is disabled by default.

Example

- This command configures the switch to act as an NTP server, accepting NTP requests.

```
switch(config)#ntp serve all
switch(config)#
```

- These commands configure Ethernet interface 5 to accept NTP requests regardless of global settings.

```
switch(config)#interface ethernet 5
switch(config-if-Et5)#ntp serve
switch(config-if-Et5)#
```

4.2.4.4 Configuring NTP Authentication

The switch can be configured to accept NTP packets only from an authenticated server or client. NTP authentication is disabled by default.

To configure the switch to authenticate NTP packets, create one or more authentication keys using the `ntp authentication-key` command, specify which keys are trusted by using the `ntp trusted-key` command, use the `ntp authenticate` command to enable NTP authentication, and specify to use the trusted-key for a specific server. The NTP server must be configured to use the same authentication key and key ID number.

- 📌 **Note:** When NTP authentication is enabled on a switch, all NTP servers upstream of the switch, as well as all NTP clients of the switch, should have matching keys configured, and clients must have NTP authentication enabled.

Example:

These commands configure the switch to authenticate NTP packets using key 328 with the plaintext password timeSync.

```
switch(config)#ntp authentication-key 328 md5 timeSync
switch(config)#ntp trusted key 328
switch(config)#ntp authenticate
switch(config)#
```

4.2.4.5 Viewing NTP Settings and Status

To display the status of Network Time Protocol (NTP) on the switch, use the `show ntp status` command. To display the status of connections to NTP servers, use the `show ntp associations` command.

- 📌 **Note:** In the output for `show ntp associations`, the reference ID (which identifies the time source of the NTP server) is either the IPv4 address of the time source or, if that source has an IPv6 address, the first four octets of the MD5 hash of that IPv6 address. In EOS releases prior to 4.23.2, `show ntp status` identified the system peer by its reference ID as described above, but in later releases it shows the IP address (whether IPv4 or IPv6).

Example

- This command displays the status of the switch's NTP connection.

```
switch#show ntp status
synchronised to NTP server (192.168.78.62) at stratum 3
  time correct to within 66 ms
  polling server every 1024 s
switch #
```

- This command displays data about the NTP servers in the configuration.

```
switch#show ntp associations
```

```

remote      refid      st t when  poll reach  delay  offset
jitter
=====
=====
+1.ntp.arista.co 125.157.10.11  2 u  539  1024  377  121.748  -0.345
  0.893
-3.ntp.arista.co 127.31.152.34  2 u  868  1024  377  101.671   2.434
  1.529
+2.ntp.arista.co 176.131.12.185 2 u  676  1024  377  116.505   0.03
  0.768
*4.ntp.arista.co 120.181.192.192 2 u  696  1024  377   48.431  -0.416
  0.15
switch#

```

4.3 Managing Display Attributes

Display commands control the content of the banner and the command line prompt.

4.3.1 Banners

The switch can display two banners:

- **Login banner:** The login banner precedes the login prompt. One common use for a login banner is to warn against unauthorized network access attempts.
- **motd banner:** The message of the day (motd) banner is displayed after a user logs into the switch.

This output displays both banners in bold:

```

This is a login banner
switch login: john
Password:
Last login: Mon Jan 14 09:24:36 2013 from adobe-wrks.aristanetworks.com
This is an motd banner
switch>

```

These commands create the login and motd banner shown earlier in this section.

```

switch(config)#banner login
Enter TEXT message. Type 'EOF' on its own line to end.
This is a login banner
EOF
switch(config)#banner motd
Enter TEXT message. Type 'EOF' on its own line to end.
This is an motd banner
EOF
switch(config)#

```

To create a banner:

1. Enter global configuration mode.

```

switch#config
switch(config)#

```

2. Enter banner edit mode by typing the desired command:

- To create a login banner, type `banner login`.
- To create a motd banner, type `banner motd`.

The switch responds with instructions on entering the banner text.

```
switch(config)#banner login
Enter TEXT message. Type 'EOF' on its own line to end.
```

3. Enter the banner text.

This is the first line of banner text.

This is the second line of banner text.

4. Press **Enter** to place the cursor on a blank line after completing the banner text.
5. Exit banner edit mode by typing EOF.

```
EOF
switch(config)#
```

4.3.2 Configuring prompt

The prompt provides an entry point for EOS commands. The `prompt` command configures the contents of the prompt. The `no prompt` command returns the prompt to the default of %H%P.

Characters allowed in the prompt include A-Z, a-z, 0-9, and these punctuation marks:

! @ # \$ % ^ & * () - = + f g [] ; : < > , . ? / ~ n

The prompt supports these control sequences:

- %s “ space character
- %t “ tab character
- %% “ percent character
- %H “ host name
- %D “ time and date
- %D{*f_char*} “ time and date, format specified by the BSD `strftime` (*f_char*) time conversion function.
- %h “ host name up to the first.”
- %P “ extended command mode
- %p “ command mode
- %r “ redundancy status on modular systems (has no effect on a fixed system)
- %R “ extended redundancy status on modular systems “ includes status and slot number (has no effect on a fixed system)

Example

- This command creates a prompt that displays **system 1** and the command mode.

```
host-name.dut103(config)#prompt system%sl%P
system 1(config) #
```

- This command creates a prompt that displays the command mode.

```
host-name.dut103(config)#prompt %p
(config) #
```

- These equivalent commands create the default prompt.

```
% prompt %H%P
host-name.dut103(config) #
```

```
% no prompt
host-name.dut103(config)#
```

4.4 Logging of Event Notifications

Arista switches log event notifications using the Syslog protocol. By default, event notifications are logged internally to `/var/log/messages`, but they can also be displayed on the console or logged to an external server. Severity levels and log message destinations can be configured via the CLI, and individual processes and protocols can also be configured to adjust or limit the messages that they log. Details of the current logging configuration may be viewed using the `show logging` command.

For a full list of Syslog messages, visit the Arista website.

4.4.1 Managing TCAM Capacity Warnings

Strata chipsets (Helix, Trident, Trident2, and Tomahawk) provide event logging for the hardware capacity of TCAM tables on a per-slice basis, triggering a capacity warning by default whenever any slice exceeds 90% capacity. As a result, default TCAM logging can generate high levels of syslog messages on Strata platforms. If this presents a problem, the `hardware capacity alert table` command can be used to adjust the capacity levels at which warnings occur to above the 90% default; this adjustment can be made per TCAM resource and per slice. The command can also be used to disable TCAM hardware capacity messages of level Warning and below entirely for a given slice by setting the threshold to 0 or using the `no` version of the command.

To determine the chipset of your device, enter `show platform ?` in the CLI.

Examples

- This command reduces hardware capacity Syslog warnings by increasing the capacity threshold to 99% for EFP table monitoring in slice 2.

```
switch(config)#hardware capacity alert table EFP feature Slice-2
threshold 99
```

- This command reduces messages by disabling hardware capacity Syslog warnings entirely for the IFP table in slice 5.

```
switch(config)#hardware capacity alert table IFP feature Slice-5
threshold 0
```

- This command reduces messages by disabling hardware capacity Syslog warnings entirely for the VFP table in all slices.

```
switch(config)#no hardware capacity alert table VFP
```

4.5 Event Monitor

The event monitor writes system event records to local files for access by SQLite database commands.

Note:

Beginning with release EOS-4.20.5F, `event-monitor` is not enabled by default. Use the `config#event-monitor` command to explicitly enable event-monitor.

4.5.1 Description

The event monitor receives notifications for important events or changes to the enabled event monitor tables. These changes are logged to a fixed-size circular buffer. The size of this buffer is configurable, but it does not grow dynamically. Buffer contents can be stored to permanent files to increase the event monitor effective capacity. The permanent file size and the number of permanent files is configurable. The buffer is stored at a fixed location on the switch.

Specific event monitor queries are available through CLI commands. For queries not available through specific commands, manual queries are supported through other CLI commands. When the user issues a query command, the relevant events from the circular buffer and permanent files are written to and accessed from a temporary SQLite database file. The database keeps a separate table for each logging type (such as MAC, ARP, route, and others). When the monitor receives notification of a new event, the database file is deleted, then recreated.

4.5.2 Configuring the Event Monitor

Enabling the Event Monitor

The `event-monitor` command enables the event monitor and specifies the types of events that are logged. The event monitor is an event logging service that records system events to a local database. The event monitor records these events:

- all changes to all events.
- ARP changes to the ARP table (IPv4 address to MAC address mappings).
- Neighbor changes to the neighbor table (IPv6 address to MAC address mappings)
- backup backed up log files.
- buffer changes to the local buffer settings.
- IGMP snooping changes to the IGMP snooping table.
- LACP changes to the LACP table events.
- MAC changes to the MAC address table (MAC address to port mappings).
- mroute changes to the IP multicast routing table.
- neighbor changes to the neighbor routing table.
- route changes to the IPv4 routing table.
- route6 changes to the IPv6 routing table.
- stpunstable events that cause STP instability.

Beginning with release EOS-4.20.5F, `event-monitor` is not enabled by default. Use the `event-monitor` command to explicitly enable event-monitor. The `no event-monitor all` disables the event monitor. The `no event-monitor` command, followed by a log type parameter, disables event recording for the specified type.

Example

- This command disables the event monitor for all types of events.

```
switch(config)#no event-monitor all
```

- This command enables the event monitor for routing table changes.

```
switch(config)#event-monitor route
```

The `event-monitor clear` command removes the contents of the event monitor buffer. If event monitor backup is enabled, this command removes the contents from all event monitor backup files.

Example

- This command clears the contents of the event monitor buffer.

```
switch#event-monitor clear
switch(config)#
```

Configuring the Buffer

The `event-monitor buffer max-size` command specifies the size of the event monitor buffer. The event monitor buffer is a fixed-size circular data structure that receives event records from the event monitor. When event monitor backup is enabled, the buffer is copied to a backup file before each rollover. Buffer size ranges from 6 Kb to 50 Kb. The default size is 32 Kb.

Example

- This command configures a buffer size of 48 Kb.

```
switch(config)#event-monitor buffer max-size 48
switch(config)#
```

Configuring Permanent Files

The `event-monitor backup path` command enables storage of the event monitor buffer to permanent switch files and specifies the path/name of these files. The command references file location either from the flash drive root directory where the CLI operates (`/mnt/flash`) or from the switch root directory (`/`).

The event monitor buffer is circular after the buffer is filled, new data replaces older data at the beginning of the buffer. The buffer is copied into a new backup file after each buffer writing cycle before the switch starts re-writing the buffer.

Example

- These commands configure the switch to store the event monitor buffer in `sw-event.log`, then display the new file in the flash directory.

```
switch(config)#event-monitor backup path eventmon_backup_dir/event.log
switch(config)#
bash-4.3# ls /mnt/flash/eventmon_backup_dir/

arpevent.log.1 lacpevent.log.1 neighborevent.log.1 routeevent.log.1
igmpsnoopingevent.log.1 macevent.log.1 route6event.log.1
stpunstaleevent.log.1
```

The `event-monitor backup max-size` command specifies the quantity of event monitor backup files the switch maintains. The switch appends an extension number to the file name when it creates a new file. After every 500 events, the switch deletes the oldest backup file if the file limit is exceeded.

Example

- These commands configure the switch to back up the event buffer to a series of files named `sw-event.log`. The switch can store a maximum of four files.

```
switch(config)#event-monitor backup path sw-event.log
switch(config)#event-monitor backup max-size 4
switch(config)#
```

The first five files that the switch creates to store event monitor buffer contents are:

sw-event.log.0
sw-event.log.1
sw-event.log.2
sw-event.log.3
sw-event.log.4

The switch deletes **sw-event.log.0** the first time it verifies the number of existing backup files after the creation of **sw-event.log.4**.

4.5.3 Querying the Event Monitor

These CLI commands perform SQL-style queries on the event monitor database:

- The **show event-monitor arp** command displays ARP table events.
- The **show event-monitor mac** command displays MAC address table events.
- The **show event-monitor route** command displays routing table events.

Example

- This command displays all events triggered by MAC address table events.

```
switch#show event-monitor mac
% Writing 0 Arp, 0 Route, 1 Mac events to the database
2012-01-19 13:57:55|1|0808.0808.0808|Ethernet1|configuredStaticMac|
added|0
```

For other database queries, the **show event-monitor sqlite** command performs an SQL-style query on the database, using the statement specified in the command.

Example

- This command displays all entries from the route table.

```
switch#show event-monitor sqlite select * from route;
2019-09-30 14:01:21.659428|16.16.16.255/32|default|receiveBcast|0|0|
updated|20
2019-09-30 14:01:21.659464|192.168.201.12/30|default|connected|1|0|
updated|21
2019-09-30 14:01:21.659497|192.168.1.255/32|default|receiveBcast|0|0|
updated|22
2019-09-30 14:01:21.659503|192.168.201.8/32|default|receiveBcast|0|0|
updated|23
2019-09-30 14:01:21.659512|16.16.16.0/32|default|receiveBcast|0|0|
updated|24
2019-09-30
14:01:21.659517|192.168.201.12/32|default|receiveBcast|0|0|updated|25
2019-09-30
14:01:21.659524|192.168.201.15/32|default|receiveBcast|0|0|updated|26
2019-09-30 14:01:21.659541|192.168.201.8/30|default|connected|1|0|
updated|27
2019-09-30 14:01:21.659564|16.16.16.0/24|default|connected|1|0|updated|
28
2019-09-30 14:01:21.659578|192.168.201.9/32|default|receive|0|0|
updated|29
```

4.5.4 Accessing Event Monitor Database Records

The `event-monitor interact` command replaces the CLI prompt with an SQLite prompt. The event monitor buffer and all backup logs are synchronized into a single SQLite file and loaded for access from the prompt.

- To access help from the SQLite prompt, enter `.help`
- To exit SQLite and return to the CLI prompt, enter `.quit` or `.exit`

The `event-monitor sync` command combines the event monitor buffer and all backup logs and synchronizes them into a single SQLite file. The data can be accessed through SQLite or by using the `show event-monitor` commands described above.

Examples

- This command replaces the EOS CLI prompt with an SQLite prompt.

```
switch#event-monitor interact
sqlite>
```

- This command exits SQLite and returns to the EOS CLI prompt.

```
sqlite> .quit
switch#
```

- This command synchronizes the buffer and backup logs into a single SQLite file.

```
switch(config)#event-monitor sync
switch(config)#
```

4.6 Managing EOS Extensions

The most simple and efficient way to make the most of the extensibility on which EOS is built is through the use of extensions. An extension is a pre-packaged optional feature or a set of scripts in an RPM Package Manager (RPM) or Software image extension (SWIX) format. A variety of extensions are available from the EOS Central page at <https://www.arista.com/en/>.

These sections describe basic EOS extension tasks:

- [Installing EOS Extensions](#)
- [Installing EOS Extensions on a Dual-Supervisor Switch](#)
- [Verifying EOS Extensions Installation](#)
- [Uninstalling an EOS Extension](#)

4.6.1 Installing EOS Extensions

Complete the following steps to install an EOS extension.

1. Download the desired extension and copy it onto the devices flash storage.

```
switch#dir
Directory of flash:/
-rwx 479183792 Jun 23 09:46 EOS-4.13.3F.swi
-rwx 21280296 Feb 6 16:48 arista-splunk-extension.swix
-rwx 27 Jun 23 10:08 boot-config drwx 4096 Sep 26 2012 schedule
-rwx 1481 Jun 27 05:54 startup-config
```

2. Copy the file from the flash storage to the extensions partition.

```
switch#copy flash:arista-splunk-extension.swix extension:
Copy completed successfully.
```

3. Install the EOS extension.

```
switch#extension arista-splunk-extension.swix
If this extension modifies the behavior of the Cli, any running Cli
sessions will
need to be reset in order for the Cli modifications to take effect.
```

4. If extension persistence across reboots is required, the extension should also be copied into the boot-extensions partition.

```
switch#copy installed-extensions boot-extensions
```

5. Run the extension. As the CloudVision extension adds additional CLI commands to EOS, the CLI session must be restarted so that the additional commands are available. To achieve this, close the SSH or the telnet session and open a new session.

4.6.2 Installing EOS Extensions on a Dual-Supervisor Switch

Complete the following steps to install an EOS extension on a dual-supervisor switch.

1. Copy the extension from the primary supervisor to the standby supervisors flash directory.

```
switch(s1)#copy flash:<filename>.swixsupervisor-peer://mnt/flash/
```

2. Establish a session to the standby supervisor from the primary.

```
switch(s1)#session peer-supervisor
Warning: Permanently added '[127.1.0.2]:3601' (RSA) to the list of
known hosts.
Last login: Mon Aug 27 17:32:00 2018 from supervisor1
```

```
WARNING - you are currently logged in to the standby supervisor.
Not all cli commands are available or supported. Any configuration
done from this cli will not be reflected in the active supervisor's
running config and will be lost when the active supervisor writes
its startup config.
switch(s2)#
```

3. Repeat the steps listed in the [Installing EOS Extensions](#) to install the EOS extension.
4. Repeat the steps listed in the [Verifying EOS Extensions Installation](#) to verify the extension installation.
5. Exit standby supervisor.

```
switch(s2)#exit
Connection to 127.1.0.1 closed.
switch(s1)#
```

4.6.3 Verifying EOS Extensions Installation

Complete the steps to verify that the EOS extensions are installed correctly.

1. Run the `show extensions` command to verify that the EOS extensions are available and installed correctly.

```
switch#show extensions
```

```
Name Version/Release Status Extension
-----
EosSdk-1.2.1-fl.boca-1943435.i686.rpm 1.2.1/1943435.flbocaeossd A, NI 1
arista-splunk-extension.swix 0.95/1498976.2013ltdsplun A, I 2
fping-2.4b2-10.fc12.i686.rpm 2.4b2/10.fc12 A, I 1
gnuplot.swix 1.10.0/1.fc14 A, I 16
splunkforwarder-5.0.9-213964.i386.rpm 5.0.9/213964 A, NI 1
```

```
A: available | NA: not available | I: installed | NI: not installed |
F: forced
```

2. Run the **show boot-extensions** command to verify that the EOS extensions are enabled for boot persistence.

```
switch#show boot-extensions
arista-splunk-extension.swix
fping-2.4b2-10.fc12.i686.rpm
gnuplot.swix
```

4.6.4 Uninstalling an EOS Extension

Complete the following steps to uninstall an EOS extension.

1. Uninstall the existing EOS extension using the **no extension** command.

```
switch#no extension fping-2.4b2-10.fc12.i686.rpm
switch#show extensions
Name Version/Release Status extension
-----
EosSdk-1.2.1-fl.boca-1943435.i686.rpm 1.2.1/1943435.flbocaeossd A, NI 1
arista-splunk-extension.swix 0.95/1498976.2013ltdsplun A, I 2
fping-2.4b2-10.fc12.i686.rpm 2.4b2/10.fc12 A, NI 1
gnuplot.swix 1.10.0/1.fc14 A, I 16
splunkforwarder-5.0.9-213964.i386.rpm 5.0.9/213964 A, NI 1
```

```
A: available | NA: not available | I: installed | NI: not installed |
F: forced
```

2. Remove the extension from the boot-extension using the **copy installed-extensions boot-extensions** command.

```
switch#copy installed-extensions boot-extensions
```



Note: If your system is a Dual-Supervisor Switch, connect to the secondary supervisor using the `session peer-supervisor` command, repeat steps 1 and 2, and finally exit from the secondary supervisor.

4.7 7130 Layer 1 Configuration

The source for patching Layer 1 traffic between front panel ports, application FPGA ports, and Switch interfaces is configured using the **l1 source** command. Switch interfaces can be used instead of the Application interfaces for making connections between SwitchApp interfaces and front panel ports.

For more information refer to <https://mako.arista.com/dyn/softwareportal/artefact/2815/7130-eos-ett6-release-notes-and-userguide.pdf>

7130 Layer 1 Show Commands

- `show l1 source`
- `show l1 source capabilities`
- `show l1 destination`
- `show l1 matrix`
- `show l1 path`

4.8 Switch Administration Commands

Switch Name Configuration Commands

- `clear ptp interface counters`
- `dns domain`
- `hostname`
- `ip domain-list`
- `ip domain lookup`
- `ip host`
- `ip name-server`
- `ipv6 host`
- `show hostname`
- `show hosts`
- `show ip domain-name`
- `show ip name-server`
- `show local-clock time-properties`

Banner Configuration Commands

- `banner login`
- `banner motd`
- `show banner`

Prompt Configuration Command

- `prompt`

Event Manager Commands

- `event-monitor`
- `event-monitor backup max-size`
- `event-monitor backup path`
- `event-monitor buffer max-size`
- `event-monitor clear`
- `event-monitor interact`
- `event-monitor sync`
- `no event-monitor`
- `show event-monitor arp`
- `show event-monitor igmpsnooping`
- `show event-monitor mac`
- `show event-monitor mroute`
- `show event-monitor neighbor`
- `show event-monitor route6`
- `show event-monitor route`
- `show event-monitor sqlite`
- `show event-monitor stpunstable`

Email Configuration Command

- `email`

System Clock Commands

- [clock set](#)
- [clock timezone](#)
- [show clock](#)

NTP Commands

- [ntp authenticate](#)
- [ntp authentication-key](#)
- [ntp local-interface](#)
- [ntp serve](#)
- [ntp serve all](#)
- [ntp server](#)
- [ntp trusted-key](#)
- [show ntp associations](#)
- [show ntp status](#)

Syslog Configuration Commands

- [logging format sequence-numbers](#)
- [logging repeat-messages](#)

7130 Layer 1 Commands

- [l1 source](#)
- [show l1 source](#)
- [show l1 source capabilities](#)
- [show l1 destination](#)
- [show l1 matrix](#)
- [show l1 path](#)

4.8.1 banner login

The `banner login` command configures a message that the switch displays before login and password prompts. The login banner is available on console, telnet, and ssh connections.

The `no banner login` and `default banner login` commands delete the login banner.

Command Mode

Global Configuration

Command Syntax

```
banner login
```

```
no banner login
```

```
default banner login
```

Parameters

- *banner_text* To configure the banner, enter a message when prompted. The message may span multiple lines. Banner text supports the following keywords:
 - `$(hostname)` displays the switch's host name.
 - `EOF` To end the banner editing session, type EOF on its own line and press **enter**.

Examples

- These commands create a two-line login banner.

```
switch(config)#banner login
Enter TEXT message. Type 'EOF' on its own line to end.
This is a login banner for $(hostname).
Enter your login name at the prompt.
EOF
switch(config)#
```

This output displays the login banner.

```
This is a login banner for switch.
Enter your login name at the prompt.
switch login:john
Password:
Last login: Mon Jan 14 09:05:23 2013 from adobe-wrks.aristanetworks.com
switch>
```

4.8.2 banner motd

The `banner motd` command configures a message of the day (motd) that the switch displays after a user logs in. The motd banner is available on console, telnet, and ssh connections.

The `no banner motd` and `default banner motd` commands delete the motd banner.

Command Mode

Global Configuration

Command Syntax

`banner motd`

`no banner motd`

`default banner motd`

Parameters

- *banner_text* To configure the banner, enter a message when prompted. The message may span multiple lines. Banner text supports this keyword:
 - **\$(hostname)** displays the switch's host name.
- **EOF** To end the banner editing session, type EOF on its own line and press **enter**.

Examples

- These commands create an motd banner.

```
switch(config)#banner motd
Enter TEXT message. Type 'EOF' on its own line to end.
This is an motd banner for $(hostname)
EOF
switch(config)#
```

This output displays the motd banner.

```
switch login:john
Password:
Last login: Mon Jan 14 09:17:09 2013 from adobe-wrks.aristanetworks.com
This is an motd banner for Switch
switch>
```

4.8.3 clear ptp interface counters

The `clear ptp interface counters` command resets the Precision Time Protocol (PTP) packet counters.

Command Mode

Privileged EXEC

Command Syntax

```
clear ptp interface [INTERFACE_NAME] counters
```

Parameters

- **INTERFACE_NAME** Interface type and numbers. Options include:
 - `<no parameter>` Display information for all interfaces.
 - **ethernet** *e_range* Ethernet interface range specified by *e_range*.
 - **loopback** *l_range* Loopback interface specified by *l_range*.
 - **management** *m_range* Management interface range specified by *m_range*.
 - **port-channel** *p_range* Port-Channel Interface range specified by *p_range*.
 - **vlan** *v_range* VLAN interface range specified by *v_range*.
 - **vxlan** *vx_range* VXLAN interface range specified by *vx_range*.

Valid parameter formats include number, number range, or comma-delimited list of numbers and ranges.

Example

- This command clears all PTP counters.

```
switch#clear ptp counters
switch#
```

4.8.4 clock set

The `clock set` command sets the system clock time and date. If the switch is configured with an NTP server, NTP time synchronizations override manually entered time settings.

Time entered by this command is local, as configured by the `clock timezone` command.

Command Mode

Privileged EXEC

Command Syntax

`clock set hh:mm:ss date`

Parameters

- *hh:mm:ss* is the current time (24-hour notation).
- *date* is the current date. Date formats include:

mm/dd/yy example: 05/15/2012

Monthdayyear example: May 15 2012

daymonthyear example: 15 May 2012

Example

- This command manually sets the switch time.

```
switch#clock set 08:15:24 14 Jan 2013
Mon Jan 14 08:15:25 2013
timezone is US/Central
```

4.8.5 clock timezone

The `clock timezone` command specifies the UTC offset that converts system time to local time. The switch uses local time for time displays and to time-stamp system logs and messages.

The `no clock timezone` and `default clock timezone` commands delete the `timezone` statement from *running-config*, setting local time to UTC.

Command Mode

Global Configuration

Command Syntax

```
clock timezone zone_name
```

```
no clock timezone
```

```
default clock timezone
```

Parameters

- `zone_name` the time zone. Settings include a list of predefined time zone labels.

Examples

- This command configures the switch for the United States Central Time Zone.

```
switch(config)#clock timezone US/Central
switch(config)#show clock
Fri Jan 11 18:42:49 2013
timezone is US/Central
switch(config)#
```

- To view the predefined time zone labels, enter `clock timezone` with a question mark.

```
switch(config)#clock timezone ?
Africa/Abidjan          Africa/Accra
Africa/Addis_Ababa     Africa/Algiers
Africa/Asmara          Africa/Asmera
Africa/Bamako          Africa/Bangui

W-SU                   W-SU timezone
WET                    WET timezone
Zulu                   Zulu timezone

switch(config)#clock timezone
```

- This command displays all time zone labels that start with **America**.

```
switch(config)#clock timezone AMERICA?
America/Adak           America/Anchorage
America/Anguilla       America/Antigua
America/Araguaina      America/Argentina/Buenos_Aires

America/Virgin         America/Whitehorse
America/Winnipeg       America/Yakutat
America/Yellowknife

switch(config)#clock timezone AMERICA
```

4.8.6 dns domain

The `dns domain` command configures the switch's domain name. The switch uses this name to complete unqualified host names.

The `no dns domain` and `default dns domain` commands delete the domain name by removing the `dns domain` command from *running-config*.

Command Mode

Global Configuration

Command Syntax

`dns domain string`

`no dns domain`

`default dns domain`

Parameters

- *string* domain name (text string)

Example

- This command configures *aristanetworks.com* as the switch's domain name.

```
switch(config)#dns domain aristanetworks.com
switch(config)#
```

4.8.7 email

The `email` command places the switch in email client configuration mode. If you configure a from-user and an outgoing SMTP server on the switch, you can then use an email address as an output modifier to a `show` command and receive the output as email.

Command Mode

Global Configuration

Command Syntax

```
email
```

Example

- This command places the switch in email client configuration mode.

```
switch(config)#email
switch(config)#
```

4.8.8 event-monitor backup max-size

The `event-monitor backup max-size` command specifies the quantity of event monitor backup files the switch maintains. Values range from 1 to 200 files with a default of ten files.

The `event-monitor backup path` command specifies the path/name of these files. The switch appends an extension to the file name that tracks the creation order of backup files. When the quantity of files exceeds the configured limit, the switch deletes the oldest file.

The `no event-monitor backup max-size` and `default event-monitor backup max-size` command restores the default maximum number of backup files the switch can store to ten by removing the corresponding `event-monitor backup max-size` command from *running-config*.

Command Mode

Global Configuration

Command Syntax

```
event-monitor backup max-size file_quantity
```

```
no event-monitor backup max-size
```

```
default event-monitor backup max-size
```

Parameters

- `file_quantity` maximum number of backup files. Value ranges from 1 to 200. Default is 10.

Examples

- These commands configure the switch to back up the event buffer to a series of files named `sw-event.log`. The switch can store a maximum of four files.

```
switch(config)#event-monitor backup path sw-event.log
switch(config)#event-monitor backup max-size 4
switch(config)#
```

The first five files that the switch creates to store event monitor buffer contents are:

`sw-event.log.0`

`sw-event.log.1`

`sw-event.log.2`

`sw-event.log.3`

`sw-event.log.4`

The switch deletes `sw-event.log.0` the first time it verifies the number of existing backup files after the creation of `sw-event.log.4`.

4.8.9 event-monitor backup path

The `event-monitor backup path` command enables the storage of the event monitor buffer to switch files and specifies the path/name of these files. The command references the file location either from the flash drive root directory (`/mnt/flash`) where the CLI operates or from the switch root directory (`/`).

The event monitor buffer is circular after the buffer is filled, new data is written to the beginning of the buffer, replacing old data. At the conclusion of each buffer writing cycle, it is copied into a new backup file before the switch starts re-writing the buffer. The switch appends a extension number to the file name when it creates a new file. After every 500 events, the switch deletes the oldest backup file if the file limit specified by the `event-monitor backup max-size` command is exceeded.

`running-config` can contain a maximum of one `event-monitor backup path` statement. Subsequent `event-monitor backup path` commands replace the existing statement in `running-config`, changing the name of the file where event monitor backup files are stored.

The `no event-monitor backup path` and `default event-monitor backup path` commands disable the storage of the event monitor buffer to switch files by deleting the `event-monitor backup path` command from `running-config`.

Command Mode

Global Configuration

Command Syntax

```
event-monitor backup path URL_FILE
no event-monitor backup path
default event-monitor backup path
```

Parameters

- **URL_FILE** path and file name of the backup file
 - **path_string** specified path is appended to `/mnt/flash/`
 - **file:** **path_string** specified path is appended to `/`
 - **flash:** **path_string** specified path is appended to `/mnt/flash/`

Example

These commands configure the switch to store the event monitor buffer in `sw-event.log`, then display the new file in the flash directory.

```
switch(config)#event-monitor backup path eventmon_backup_dir/event.log
switch(config)#
bash-4.3# ls /mnt/flash/eventmon_backup_dir/

arpevent.log.1  lacpevent.log.1  neighborevent.log.1  routeevent.log.1
igmpsnoopingevent.log.1  macevent.log.1  route6event.log.1
stpunstabilevent.log.1
```

4.8.10 event-monitor buffer max-size

The `event-monitor buffer max-size` command specifies the size of the event monitor buffer. The event monitor buffer is a fixed-size circular data structure that receives event records from the event monitor. When event monitor backup is enabled (`event-monitor backup path`), the buffer is copied to a backup file before each rollover.

Buffer size ranges from 6 Kb to 50 Kb. The default size is 32 Kb.

The `no event-monitor buffer max-size` and `default event-monitor buffer max-size` commands restore the default buffer size of 32 Kb by removing the `event-monitor buffer max-size` command from *running-config*.

Command Mode

Global Configuration

Command Syntax

```
event-monitor buffer max-size buffer_size
```

```
no event-monitor buffer max-size
```

```
default event-monitor buffer max-size
```

Parameters

- *buffer_size* buffer capacity (Kb). Values range from 6 to 50. Default value is 32.

Example

- This command configures a buffer size of 48 Kb.

```
switch(config)#event-monitor buffer max-size 48
switch(config)#
```

4.8.11 event-monitor clear

The `event-monitor clear` command removes the contents of the event monitor buffer. If event monitor backup is enabled, this command removes the contents from all event monitor backup files.

Command Mode

Privileged EXEC

Command Syntax

```
event-monitor clear
```

Example

- This command clears the contents of the event monitor buffer.

```
switch#event-monitor clear  
switch#
```

4.8.12 event-monitor interact

The `event-monitor interact` command replaces the CLI prompt with an SQLite prompt. The event monitor buffer and all backup logs are synchronized into a single SQLite file and loaded for access from the prompt.

- To access help from the SQLite prompt, enter `.help`
- To exit SQLite and return to the CLI prompt, enter `.quit` or `.exit`

Command Mode

Privileged EXEC

Command Syntax

```
event-monitor interact
```

Examples

- This command replaces the EOS CLI prompt with an SQLite prompt.

```
switch#event-monitor interact
sqlite>
```

- This command exits SQLite and returns to the EOS CLI prompt.

```
sqlite> .quit
switch#
```

4.8.13 event-monitor sync

The `event-monitor buffer sync` command combines the event monitor buffer and all backup logs and synchronizes them into a single SQLite file, which is stored at `/var/log/eventMon.db`

Command Mode

Privileged EXEC

Command Syntax

```
event-monitor sync
```

Example

- This command synchronizes the buffer and backup logs into a single SQLite file.

```
switch(config)#event-monitor sync  
switch(config)#
```

4.8.14 event-monitor

The `event-monitor` command enables the event monitor and specifies the types of events that are logged. The event monitor is an event logging service that records system events to a local database.

The database maintains a separate table for each event type.

Beginning with release EOS-4.20.5F, `event-monitor` is not enabled by default. Use the `event-monitor` command to explicitly enable event-monitor.

- The `no event-monitor all` command disables the event monitor.
- The `no event-monitor` command, followed by a log type parameter, disables event recording for the specified type.
- The `event-monitor` and `default event-monitor` commands enable the specified event logging type by removing the corresponding `no event-monitor` command from *running-config*.

The `no event-monitor` and `default event-monitor` commands, without a LOG_TYPE parameter, restore the default event monitor settings by deleting all event monitor related commands from *running-config*.

Command Mode

Global Configuration

Command Syntax

```
event-monitor LOG_TYPE
```

```
no event-monitor LOG_TYPE
```

```
default event-monitor LOG_TYPE
```

Parameters

- LOG_TYPE specifies the event logging type. Options include:
 - **all** all event logging types.
 - **arp** changes to ARP table.
 - **backup** backed up log files.
 - **buffer** changes to the local buffer settings.
 - **igmpsnooping** changes to IGMP snooping table.
 - **lACP** changes to the LACP table events.
 - **mac** changes to MAC address table.
 - **mroute** changes to multicast routing table.
 - **neighbor** changes to the neighbor routing table.
 - **route** changes to IP routing table.
 - **route6** changes to IP route6 table.
 - **stpunable** events that cause STP instability.

Related Commands

- `no event-monitor`

Examples

- This command disables the event monitor for all types of events.

```
switch(config)#no event-monitor all
switch(config)#
```

- This command enables the event monitor for routing table changes.

```
switch(config)#event-monitor route
```

```
switch(config)#
```

4.8.15 hostname

The `hostname` command assigns a text string as the switch's host name. The default host name is *localhost*.

The prompt displays the host name when appropriately configured through the `prompt` command.

The `no hostname` and `default hostname` commands return the switch's host name to the default value of *localhost*.

Command Mode

Global Configuration

Command Syntax

```
hostname string
```

```
no hostname
```

```
default hostname
```

Parameters

- *string* host name assigned to the switch.

Example

- This command assigns the string *main-host* as the switch's host name.

```
switch(config)#hostname main-host  
main-host(config)#
```

The prompt was previously configured to display the host name.

4.8.16 ip domain lookup

The `ip domain lookup` command specifies the source interface for all DNS requests sent from the specified VRF.

The `no ip domain lookup` and `default ip domain lookup` commands return the switch to its default state, in which the switch selects source IP addresses for each DNS request from the specified VRF.

Command Mode

Global Configuration

Command Syntax

```
ip domain lookup [VRF_INSTANCE] source-interface INTF_NAME
```

```
no ip domain lookup [VRF_INSTANCE] source-interface
```

```
default ip domain lookup [VRF_INSTANCE] source-interface
```

Parameters

- VRF_INSTANCE specifies the VRF instance being modified.
 - <no parameter> changes are made to the default VRF.
 - **vrf** *vrf_name* changes are made to the specified VRF.
- INTF_NAME name of source interface to be used for DNS requests. Options include:
 - **ethernet** *e_num* Ethernet interface specified by *e_num*.
 - **loopback** *l_num* Loopback interface specified by *l_num*.
 - **management** *m_num* Management interface specified by *m_num*.
 - **port-channel** *p_num* Port-channel interface specified by *p_num*.
 - **vlan** *v_num* VLAN interface specified by *v_num*.

Examples

- This command specifies VLAN 5 as the source interface for DNS requests originating from the default VRF.

```
switch(config)#ip domain lookup source-interface Vlan5
switch(config)#
```

- This command specifies VLAN 10 as the source interface for DNS requests originating from VRF purple.

```
switch(config)#ip domain lookup vrf purple source-interface Vlan10
switch(config)#
```

4.8.17 ip domain-list

The `ip domain-list` command specifies a domain name to add to the IP domain list.

The `no ip domain-list` and `default ip domain-list` commands return the IP domain list to its default state, in which the switch selects source IP addresses for each DNS request from the specified VRF.

Command Mode

Global Configuration

Command Syntax

```
ip domain-list [IP_DOMAIN_NAME]
```

```
no ip domain-list [IP_DOMAIN_NAME]
```

```
default ip domain-list [IP_DOMAIN_NAME]
```

Parameters

- IP_DOMAIN_NAME specifies the IP domain name.

Examples

- This command specifies `foo.com` as the IP domain name to add to the IP domain list.

```
switch(config)#ip domain-list foo.com
switch(config)#
```

- This command removes `foo.com` and returns the IP domain list to its default state.

```
switch(config)#no ip domain-list foo.com
switch(config)#
```

4.8.18 ip host

The `ip host` command associates a hostname to an IPv4 address. This command supports local hostname resolution based on local hostname-IP address maps. Multiple hostnames can be mapped to an IP address. IPv4 and IPv6 addresses can be mapped to the same hostname (to map an IPv6 address to a hostname, use the `ipv6 host` command). The `show hosts` command displays the local hostname-IP address mappings.

The `no ip host` and `default ip host` commands removes hostname-IP address maps by deleting the corresponding `ip host` command from *running-config*, as specified by command parameters:

- no parameters: command removes all hostname-IP address maps.
- hostname parameter: command removes all IP address maps for the specified hostname.
- hostname and IP address parameters: command removes specified hostname-IP address maps.

Command Mode

Global Configuration

Command Syntax

```
ip host hostname hostadd_1 [hostadd_2] ...[hostadd_X]
```

```
no ip host [hostname] [hostadd_1 [hostadd_2] [hostadd_X]
```

```
default ip host [hostname] [hostadd_1 [hostadd_2] [hostadd_X]
```

Parameters

- *hostname* hostname (text).
- *hostadd_N* IPv4 address associated with hostname (dotted decimal notation).

Related Commands

- `ipv6 host`
- `show hosts`

Examples

- This command associates the hostname `test_lab` with the IP addresses `10.24.18.5` and `10.24.16.3`.

```
switch(config)#ip host test_lab 10.24.18.5 10.24.16.3
```

- This command removes all IP address maps for the hostname `production_lab`.

```
switch(config)#no ip host production_lab
switch(config)#
```

4.8.19 ip name-server

The `ip name-server` command adds name server addresses to *running-config*. The switch uses name servers for name and address resolution. The switch can be configured with up to three name servers. Although a command can specify multiple name server addresses, *running-config* stores each address in a separate statement. Name server addresses can be IPv4 and IPv6; each command can specify both address types.

Attempts to add a fourth server generate an error message. All name server addresses must be configured in the same VRF. When name servers were previously configured in a VRF, they must all be removed before adding new name server entries.

The `no ip name-server` and `default ip name-server` commands remove specified name servers from *running-config*. Commands that do not list an address remove all name servers.

Command Mode

Global Configuration

Command Syntax

```
ip name-server [VRF_INSTANCE] [SERVER_1] [SERVER_2] [SERVER_3]
```

```
no ip name-server [VRF_INSTANCE] [SERVER_1] [SERVER_2] [SERVER_3]
```

```
default ip name-server [VRF_INSTANCE] [SERVER_1] [SERVER_2] [SERVER_3]
```

Parameters

- VRF_INSTANCE specifies the VRF instance containing the addresses.
 - <no parameter> default VRF.
 - `vrf vrf_name` a user-defined VRF.
- SERVER_X IP address of the name server (dotted decimal notation). Options include:
 - `ipv4_addr` (A.B.C.D)
 - `ipv6_addr` (A:B:C:D:E:F:G:H)

A command can contain both (IPv4 and IPv6) address types.

Guidelines

All configured name server addresses must come from the same VRF. To use a user defined VRF for connection to a name server, first remove any name servers configured in the default VRF.

Examples

- This command adds two name servers to the configuration.

```
switch(config)#ip name-server 172.0.14.21 3:4F21:1902::  
switch(config)#
```

- This command attempts to add a name server when the configuration already lists three servers.

```
switch(config)#ip name-server 172.1.10.22  
% Maximum number of nameservers reached. '172.1.10.22' not added  
switch(config)#
```

4.8.20 ipv6 host

The `ipv6 host` command associates a hostname to an IPv6 address. This command supports local hostname resolution based on local hostname-IP address maps. Multiple hostnames can be mapped to an IPv6 address. IPv4 and IPv6 addresses can be mapped to the same hostname (to map IPv4 addresses to a hostname, use the `ip host` command). The `show hosts` command displays the local hostname-IP address mappings.

The `no ipv6 host` and `default ipv6 host` commands remove hostname-IP address maps by deleting the corresponding `ipv6 host` command from *running-config*, as specified by command parameters:

- **<no parameters>**: command removes all hostname-IPv6 address maps.
- **hostname** parameter: command removes all IPv6 address maps for the specified hostname.
- **hostname** and **IP address** parameters: command removes specified hostname-IP address maps.

Command Mode

Global Configuration

Command Syntax

```
ipv6 host hostname hostadd_1 [hostadd_2] ...[hostadd_X]
no ipv6 host [hostname] [hostadd_1] [hostadd_2] [hostadd_X]
default ipv6 host [hostname] [hostadd_1] [hostadd_2] [hostadd_X]
```

Parameters

- *hostname* hostname (text).
- *hostadd_N* IPv6 addresses associated with hostname (dotted decimal notation).

Related Commands

- `ip host`
- `show hosts`

Example

This command associates the hostname *support_lab* with the IPv6 address 2001:0DB8:73:ff:ff:26:fd:90.

```
switch(config)#ipv6 host support_lab 2001:0DB8:73:ff:ff:26:fd:90
switch(config)#
```

4.8.21 I1 source

The **l1 source** command configures the source for patching Layer 1 traffic between various front panel and Switch Application (SwitchApp) ports in the Ethernet Interface configuration mode.

The **no l1 source** and **default l1 source** commands remove the source configurations and return to the default platform configurations.

Command Mode

Interface-Ethernet Configuration

Command Syntax

```
l1 source {interface | mac | none}
```

Parameters

- **interface** patches the Layer 1 traffic from the specified interface.
 - **Application** Application FPGA connector interface
 - **Cpu** CPU interface
 - **Ethernet** Ethernet interface
 - **Switch** Switch interface
- **mac** patches the Layer 1 traffic from the specified MAC address.
- **none** unpatches the Layer 1 traffic source.

Example

- This command patches the Layer 1 traffic from the Ethernet interface *et2*.

```
switch(config)#interface ethernet1  
switch(config-if-Et1)# l1 source interface et2  
switch(config-if-Et1)#
```

- This command unpatches the Layer 1 traffic source.

```
switch(config)#interface ethernet1  
switch(config-if-Et1)# l1 source none
```

4.8.22 logging format sequence-numbers

The `logging format sequence-numbers` command causes the sequence numbers of syslog messages to be visible when the messages are displayed.

The `no logging format sequence-numbers` and `default logging format sequence-numbers` commands remove the `logging format sequence-numbers` command from *running-config*.

Command Mode

Global Configuration

Command Syntax

```
logging format sequence-numbers
```

```
no logging format sequence-numbers
```

```
default logging format sequence-numbers
```

Examples

- This command enables sequence numbering that can be seen when syslog messages are displayed.

```
switch(config)#logging format sequence-numbers
switch(config)#
```

- To display the sequence numbers, issue the show logging command.

```
switch#show logging
Syslog logging: enabled
  Buffer logging: level debugging
  Console logging: level informational
  Synchronous logging: disabled
  Trap logging: level informational
  Sequence numbers: enabled
  Syslog facility: local4
  Hostname format: Hostname only
  Repeat logging interval: disabled

Log Buffer:

Nov 12 14:03:34 switch1 SuperServer: 1: %SYS-7-CLI_SCHEDULER_LOG_STORED: Logfile for
scheduled CLI execution job 'tech-support' is stored in
flash:/schedule/tech-support/tech-support_2012-11-12.1402.log.gz
Nov 12 14:06:52 switch1 Cli: 2: %SYS-5-CONFIG_I: Configured from console by admin on con0
(0.0.0.0)
Nov 12 14:07:26 switch1 Cli: 3: %SYS-5-CONFIG_E: Enter configuration mode from console by
admin on con0 (0.0.0.0)
Nov 12 14:14:29 switch1 Cli: 4: %SYS-5-CONFIG_I: Configured from console by admin on con0
(0.0.0.0)
Nov 12 14:15:55 switch1 Cli: 5: %SYS-5-CONFIG_E: Enter configuration mode from console by
admin on con0 (0.0.0.0)
Nov 12 14:33:05 switch1 Cli: 6: %SYS-5-CONFIG_I: Configured from console by admin on con0
(0.0.0.0)
Nov 12 14:45:13 switch1 Cli: 7: %SYS-5-CONFIG_E: Enter configuration mode from console by
admin on con0 (0.0.0.0)
switch#
```

4.8.23 logging repeat-messages

The `logging repeat-messages` command configures repetition of syslog messages instead of summarizing the count of repeats.

The `no logging repeat-messages` and `default logging repeat-messages` commands disable the functionality to repeat logging messages in *running-config*.

Command Mode

Global Configuration

Command Syntax

`logging repeat-messages`

`no logging repeat-messages`

`default logging repeat-messages`

Examples

- This command repeats syslog messages instead of summarizing the count of repeats.

```
switch(config)#logging repeat-messages
switch(config)#
```

- This command displays the status of logging repeat messages command.

```
switch(config)#show logging
Syslog logging: enabled
  Buffer logging: level debugging
  Console logging: level debugging
  Monitor logging: level debugging
  Synchronous logging: disabled
  Trap logging: level informational
  Sequence numbers: disabled
  Syslog facility: local4
  Hostname format: Hostname only
  Repeat logging interval: disabled
  Repeat messages: enabled
```

Facility	Severity	Effective Severity
-----	-----	-----
aaa	debugging	debugging
accounting	debugging	debugging

```
switch(config)#
```

4.8.24 no event-monitor

The `no event-monitor` and `default event-monitor` commands remove the specified **event-monitor** configuration statements from *running-config*, returning the switch to the specified default state.

- **no event-monitor** <with no parameters> restores all default setting states:
 - event monitor is enabled.
 - buffer backup is disabled.
- **no event-monitor backup** disables the backup.

To disable the event monitor, enter the `no event-monitor all` command ([event-monitor](#)).

Command Mode

Global Configuration

Command Syntax

```
no event-monitor [PARAMETER]
```

```
default event-monitor [PARAMETER]
```

Parameters

- **PARAMETER** the event monitor property that is returned to the default state.
 - <no parameter> all event monitor properties.
 - **backup** event monitor buffer backup is disabled.

Example

- This command removes all event monitor configuration statements from *running-config*.

```
switch(config)#no event-monitor
switch(config)#
```

4.8.25 ntp authenticate

The `ntp authenticate` command enables the authentication of incoming NTP packets. When authentication is enabled, NTP packets will be used to synchronize time on the switch only if they include a trusted authentication key. Authentication keys are created on the switch using the `ntp authentication-key` command, and the `ntp trusted-key` command is used to specify which keys are trusted. NTP authentication is disabled by default.

The `no ntp authenticate` and `default ntp authenticate` commands disable NTP authentication on the switch by removing the corresponding `ntp authenticate` command from *running-config*.

Command Mode

Global Configuration

Command Syntax

```
ntp authenticate
```

```
no ntp authenticate
```

```
default ntp authenticate
```

Examples

- This command enables NTP authentication on the switch.

```
switch(config)#ntp authenticate
switch(config)#
```

- This command disables NTP authentication on the switch.

```
switch(config)#no ntp authenticate
switch(config)#
```

4.8.26 ntp authentication-key

The `ntp authentication-key` command creates an authentication key for use in authenticating incoming NTP packets. For the key to be used in authentication:

- It must be configured as a trusted key using the `ntp trusted-key` command.
- NTP authentication must be enabled on the switch using the `ntp authenticate` command.
- The same key must be configured on the NTP server.

The `no ntp authentication-key` and `default ntp authentication-key` commands remove the specified authentication key by removing the corresponding `ntp authentication-key` command from *running-config*.

Command Mode

Global Configuration

Command Syntax

```
ntp authentication-key key_id ENCRYPT_TYPE password_text
```

```
no ntp authentication-key key_id
```

```
default ntp authentication-key key_id
```

Parameters

- *key_id* key ID number. Value ranges from 1 to 65534.
- ENCRYPT_TYPE encryption method. Values include:
 - **md5** *key_text* is MD5 encrypted.
 - **sha1** *key_text* is SHA-1 encrypted.
- *password_text* the authentication-key password.

Example

- This command creates an NTP authentication key with ID 234 and password timeSync using MD5 encryption.

```
switch(config)#ntp authentication-key 234 md5 timeSync
```

Running-config stores the password as plain text.

- This command removes NTP authentication key 234.

```
switch(config)#no ntp authentication-key 234
```

4.8.27 ntp local-interface

The `ntp local-interface` command configures an interface as the source of NTP updates. That interface's IP address is then used as the source address for all NTP packets sent to all destinations unless a server-specific source interface has been specified using the `source` option of the `ntp server` command.

The `no ntp local-interface` and `default ntp local-interface` commands remove the `ntp local-interface` command from *running-config*.

Command Mode

Global Configuration

Command Syntax

```
ntp local-interface [VRF_INSTANCE] INT_PORT
```

```
no ntp local-interface
```

```
default ntp local-interface
```

Parameters

- VRF_INSTANCE the VRF instance to be used for connection to the specified server.
 - <no parameter> connects using the default VRF.
 - `vrf vrf_name` connects using the specified user-defined VRF.
- INT_PORT the interface port that specifies the NTP local interface. Settings include:
 - `ethernet e_range` Ethernet interface list.
 - `loopback l_range` loopback interface list.
 - `management m_range` management interface list.
 - `port-channel c_range` port channel interface list.
 - `vlan v_range` VLAN interface list.

Examples

- This command configures VLAN interface 25 as the source of NTP update packets.

```
switch(config)#ntp local-interface vlan 25
switch(config)#
```

- This command removes the `ntp local-interface` command from the configuration.

```
switch(config)#no ntp local-interface
switch(config)#
```

4.8.28 ntp serve all

The `ntp serve all` command configures the switch to act as an NTP server by accepting incoming NTP requests.

Using this command also causes the switch to re-synchronize with its upstream NTP server.

Individual interfaces can be configured separately to accept or deny NTP requests by using the `ntp serve` command, and these settings override the global setting.

Command Mode

Global Configuration

Command Syntax

```
ntp serve all
```

```
no ntp serve all
```

```
default ntp serve all
```

Example

- This command configures the switch to accept incoming NTP requests.

```
switch(config)#ntp serve all
switch(config)#
```

- This command configures the switch to deny incoming NTP requests.

```
switch(config)#no ntp serve all
switch(config)#
```

4.8.29 ntp serve

The **ntp serve** command configures the command mode interface to accept incoming NTP requests regardless of the global setting.

The **no ntp serve** command configures the command mode interface to refuse incoming NTP requests regardless of the global setting. The **default ntp serve** command configures the command mode interface to follow the global setting.

Using this command also causes the switch to re-synchronize with its upstream NTP server.

Command Modes

Interface-Ethernet Configuration

Interface-Loopback Configuration

Interface-Management Configuration

Interface-Port-channel Configuration

Interface-VLAN Configuration

Interface-VXLAN Configuration

Command Syntax

ntp serve

no ntp serve

default ntp serve

Example

- These commands configure Ethernet interface 5 to accept incoming NTP requests regardless of global settings.

```
switch(config)#interface ethernet 5
switch(config-if-Et5)#ntp serve
switch(config-if-Et5)#
```

- These commands configure Ethernet interface 5 to deny incoming NTP requests regardless of global settings.

```
switch(config)#interface ethernet 5
switch(config-if-Et5)#no ntp serve
switch(config-if-Et5)#
```

- These commands configure Ethernet interface 5 to use global settings in responding to incoming NTP requests.

```
switch(config)#interface ethernet 5
switch(config-if-Et5)#default ntp serve
switch(config-if-Et5)#
```

4.8.30 ntp server

The `ntp server` command adds a Network Time Protocol (NTP) server to *running-config*. If the command specifies a server that already exists in *running-config*, it will modify the server settings. The switch synchronizes the system clock with an NTP server when *running-config* contains at least one valid NTP server.

The switch supports NTP versions 1 through 4. The default is version 4.

The `prefer` option specifies a preferred NTP server, which will be used as the NTP server if not discarded by NTP.

The `no ntp server` and `default ntp server` commands remove the specified NTP server from *running-config*. To remove an NTP server configured in a user-defined VRF, include the VRF name in the `no ntp server` command.

Command Mode

Global Configuration

Command Syntax

```
ntp server [VRF_INSTANCE] SERVER_NAME [PREFERENCE] [NTP_VERSION] [IP_SOURCE]
[burst] [iburst] [AUTH_KEY][MAX_POLL_INT][MIN_POLL_INT]
```

```
no ntp server [VRF_INSTANCE] SERVER_NAME
```

```
default ntp server [VRF_INSTANCE] SERVER_NAME
```

All parameters except **VRF_INSTANCE** and **SERVER_NAME** can be placed in any order.

Parameters

- **VRF_INSTANCE** the VRF instance to be used for connection to the specified server.
 - <no parameter> connects using the default VRF.
 - `vrf vrf_name` connects using the specified user-defined VRF.
- **SERVER_NAME** NTP server location. Options include:
 - *IP address* in dotted decimal notation
 - an FQDN host name
- **PREFERENCE** indicates priority of this server when the switch selects a synchronizing server.
 - <no parameter> server has no special priority.
 - `prefer` server has priority when the switch selects a synchronizing server.
- **NTP_VERSION** specifies the NTP version. Settings include:
 - <no parameter> sets NTP version to 4 (default).
 - `version number`, where *number* ranges from 1 to 4.
- **IP_SOURCE** specifies the source interface for NTP updates for the specified NTP server. This option overrides global settings created by the `ntp local-interface` command. Options include:
 - <no parameter> sets the source interface to the global default.
 - `source ethernet e_num` Ethernet interface specified by *e_num*.
 - `source loopback l_num` loopback interface specified by *l_num*.
 - `source management m_num` management interface specified by *m_num*.
 - `source port-channel p_num` port-channel interface specified by *p_num*.
 - `source vlan v_num` VLAN interface specified by *v_num*.
- **burst** indicates that when the NTP server is reached, the switch sends packets to the server in bursts of eight instead of the usual one. Recommended only for local servers. Off by default.

- **iburst** indicates that the switch sends packets to the server in bursts of eight instead of the usual one until the server is reached. Recommended for general use to speed synchronization. Off by default.
- **AUTH_KEY** the authentication key to use in authenticating NTP packets from the server.
 - `<no parameter>` no authentication key is specified.
 - **key <1 to 65534>** switch will use the specified key to authenticate NTP packets from the server.
- **MAX_POLL_INT** specifies the maximum polling interval for the server (as the base-2 logarithm of the interval in seconds). Settings include:
 - `<no parameter>` sets the maximum polling interval to 10 (1,024 seconds, the default).
 - **maxpoll number**, where *number* is the base-2 logarithm of the interval in seconds. Values range from 3 (8 seconds) to 17 (131,072 seconds, approximately 36 hours).
- **MIN_POLL_INT** specifies the minimum polling interval for the server (as the base-2 logarithm of the interval in seconds). Settings include:
 - `<no parameter>` sets the minimum polling interval to 6 (64 seconds, the default).
 - **minpoll number**, where *number* is the base-2 logarithm of the interval in seconds. Values range from 3 (8 seconds) to 17 (131,072 seconds, approximately 36 hours).

Guidelines

To configure multiple parameters for a single server, include them all in a single **ntp server** command. Using the command again for the same server overwrites parameters previously configured in **running-config**.

All NTP servers must use the same VRF. If no VRF is specified, the server is configured in the default VRF. To use a user-defined VRF for connection to an NTP server, first use the **no ntp server** command to remove any NTP servers configured in the default VRF.

When specifying a source interface, choose an interface in the same VRF as the server. If the source interface is not in the same VRF, the source data will be included in **running-config** but will not be added to NTP packets.

An NTP server may be configured using an invalid or inactive VRF, but the status of the NTP server will remain inactive until the VRF is active.

Examples

- This command configures the switch to update its time with the NTP server at address 172.16.0.23 and designates it as a preferred NTP server.

```
switch(config)#ntp server 172.16.0.23 prefer
```

- This command configures the switch to update its time through an NTP server named *local-nettime*.

```
switch(config)#ntp server local-nettime
```

- This command configures the switch to update its time through a version 3 NTP server.

```
switch(config)#ntp server 171.18.1.22 version 3
```

- These commands reconfigure the switch to access the above NTP servers through VRF magenta.

```
switch(config)#no ntp server 172.16.0.23
switch(config)#no ntp server local-nettime
switch(config)#no ntp server 171.18.1.22
switch(config)#ntp server vrf magenta 172.16.0.23 prefer
switch(config)#ntp server vrf magenta local-nettime
switch(config)#ntp server vrf magenta 171.18.1.22 version 3
switch(config)#
```

4.8.31 ntp trusted-key

The `ntp trusted-key` command specifies which authentication keys will be trusted for authentication of NTP packets. A packet with a trusted key will be used to update the local time if authenticated.

The `no ntp trusted-key` and `default ntp trusted-key` commands remove the specified authentication keys from the trusted key list by removing the corresponding `ntp trusted-key` command from *running-config*.

Command Mode

Global Configuration

Command Syntax

```
ntp trusted-key key_list
```

```
no ntp trusted-key
```

```
default ntp trusted-key
```

Parameters

- **key_list** specified one or more keys. Formats include a number (1 to 65534), number range, or comma-delimited list of numbers and ranges.

Example

- This command configures the switch to trust authentication keys 234 and 237 for authentication of NTP packets.

```
switch(config)#ntp trusted-key 234,237
switch(config)#
```

4.8.32 prompt

The **prompt** command specifies the contents of the CLI prompt. Characters allowed in the prompt include A-Z, a-z, 0-9, and these punctuation marks:

! @ # \$ % # & * () - = + f g [] ; : < > , . ? / # n

The prompt supports these control sequences:

- %s – space character
- %t – tab character
- %% – percent character
- %D – time and date
- %D{*f_char*} – time and date, format specified by the BSD **strftime** (*f_char*) time conversion function.
- %H – host name
- %h – host name up to the first ‘.’
- %P – extended command mode
- %p – command mode
- %r¹ – redundancy status on modular systems
- %R² – extended redundancy status on modular systems – includes status and slot number

[Table 4: Command Mode Prompt Examples](#) displays Command Mode and Extended Command Mode prompts for various modes.

Table 4: Command Mode Prompt Examples

Command Mode	Command Mode Prompt	Extended Command Mode Prompt
Exec	>	>
Privileged Exec	#	#
Global Configuration	(config)#	(config)#
Ethernet Interface Configuration	(config-if)#	(config-if-ET15)#
VLAN Interface Configuration	(config-if)#	(config-if-VI24)#
Port Channel Interface Configuration	(config-if)#	(config-if-Po4)#
Management Interface Configuration	(config-if)#	(config-if-Ma1)
Access List Configuration	(config-acl)#	(config-acl-listname)#
OSPF Configuration	(config-router)#	(config-router-ospf)#
BGP Configuration	(config-router)#	(config-router-bgp)#

The **no prompt** and **default prompt** commands return the prompt to the default of %H%R%P.

¹ When logged into a fixed system or a supervisor on a modular system, this option has no effect.

² When logged into a fixed system, this option has no effect.

Command Mode

Global Configuration

Command Syntax

```
prompt p_string
```

```
no prompt
```

```
default prompt
```

Parameters

- *p_string* prompt text (character string). Elements include letters, numbers, and control sequences.

Examples

- This command creates a prompt that displays **system 1** and the command mode.

```
host-name.dut103(config)#prompt system%s1%P
system 1(config) #
```

- This command creates a prompt that displays the command mode.

```
host-name.dut103(config)#prompt %p
(config) #
```

- These equivalent commands create the default prompt.

```
% prompt %H%P
host-name.dut103(config) #
```

```
% no prompt
host-name.dut103(config) #
```

4.8.33 show banner

The `show banner` command displays the specified banner.

Command Mode

Privileged EXEC

Command Syntax

```
show banner BANNER_TYPE
```

Parameters

- BANNER_TYPE banner that the command displays. Options include
 - **login** command displays login banner.
 - **motd** command displays message of the day banner.

Example

- These commands configure and display the message of the day banner.

```
switch(config)#banner motd  
Enter TEXT message. Type 'EOF' on its own line to end.  
This is an motd banner for $(hostname)  
EOF  
switch(config)#show banner motd  
This is an motd banner for $(hostname)  
switch(config)#
```

4.8.34 show clock

The `show clock` command displays the current system clock time and configured time zone. The switch uses the system clock for system log messages and debugging traces.

Command Mode

EXEC

Command Syntax

```
show clock
```

Example

- This command displays the current system clock time and configured time zone.

```
switch>show clock
Wed Nov  2 10:29:32 2011
timezone is America/Los_Angeles
switch>
```

4.8.35 show event-monitor arp

The `show event-monitor arp` command performs an SQL-style query on the event monitor database and displays ARP table events as specified by command parameters. The event monitor buffer and all backup logs are synchronized into a single SQLite file.

Command Mode

Privileged EXEC

Command Syntax

```
show event-monitor arp [GROUP] [MESSAGES] [INTERFACE] [IP] [MAC] [TIME] [VRF]
```

Optional parameters can be placed in any order.

Parameters

- GROUP used with aggregate functions to group results. Analogous to SQL group by command.
 - <no parameter> results are not grouped.
 - **group-by** *interface* results are grouped by interface.
 - **group-by** *ip* results are grouped by IP address.
 - **group-by** *mac* results are grouped by MAC address.
 - **group-by** *vrf* results are grouped by VRF.
- MESSAGES number of messages returned from query. Analogous to SQL limit command.
 - <no parameter> result-set size is not limited.
 - **limit** *msg_quantity* number of results that are displayed. Values range from 1 to 15,000.
- INTERFACE restricts result-set to events that include specified interface (SQL Like command).
 - <no parameter> result-set not restricted by interface.
 - **match-interface ethernet** *e_range* Ethernet interface list.
 - **match-interface loopback** *l_range* loopback interface list.
 - **match-interface management** *m_range* management interface list.
 - **match-interface port-channel** *c_range* port channel interface list.
 - **match-interface tunnel** *t_range* tunnel interface list.
 - **match-interface vxlan** *vx_range* VXLAN interface list.
 - **match-interface port-channel** *c_range* port channel interface list.
- IP restricts result-set to events that include specified IP address (SQL Like command).
 - <no parameter> result-set not restricted to specific IP addresses.
 - **match-ip** *ip_address_rex* IP address, as represented by regular expression.
- MAC restricts result-set to events that include specified MAC address (SQL Like command).
 - <no parameter> result-set not restricted to specific MAC addresses.
 - **match-mac** *mac_address_rex* MAC address, as represented by regular expression.
- TIME restricts result-set to events generated during specified period.
 - <no parameter> result-set not restricted by time of event.
 - **match-time last-minute** includes events generated during last minute.
 - **match-time last-day** includes events generated during last day.
 - **match-time last-hour** includes events generated during last hour.
 - **match-time last-week** includes events generated during last week.
- VRF restricts result-set to events that include a specific VRF.
 - <no parameter> result-set not restricted by time of event.
 - **match-vrf** *vrf_name* the VRF name.

Example

- This command displays ARP table events listed in the event monitor database.

```
switch#show event-monitor arp
% Writing 220017 Arp, 234204 Route, 1732559 Mac events to the database
2012-11-06 12:36:10|10.33.6.159|Vlan1417|0000.00dc.cc0d|0|added|2186271
2012-11-06 12:38:20|10.33.7.150|Vlan1417|0000.00f7.e25f|0|added|2186292
2012-11-06 12:38:34|10.33.6.62|Vlan1417|0000:00:01:c2:ac|0|added|
2186295
2012-11-06 12:39:13|10.33.7.162|Vlan1417|00:00:00:45:c2:79|0|added|
2186299
2012-11-06 12:39:50|10.33.12.54|Vlan1417|||removed|2186303
2012-11-06 12:39:51|10.33.6.218|Vlan1417|00:00:00:e9:36:46|0|added|
2186305
2012-11-06 12:40:00|10.33.6.140|Vlan1417|00:00:00:4a:36:c3|0|added|
2186308
2012-11-06 12:40:02|10.33.6.239|Vlan1417|00:00:00:5b:a7:21|0|added|
2186312
2012-11-06 12:41:16|10.33.7.11|Vlan1417|00:00:00:3f:94:59|0|added|
2186320
2012-11-06 12:41:50|10.33.7.60|Vlan1417|00:00:00:1f:3c:8e|0|added|
2186346
2012-11-06 12:43:34|10.33.7.81|Vlan1417|00:00:00:e3:0d:9c|0|added|
2186762
2012-11-06 12:43:42|10.33.6.214|Vlan1417|00:00:00:7b:09:7d|0|added|
2186765
2012-11-06 12:43:59|10.33.7.149|Vlan1417|00:00:00:8d:a6:d8|0|added|
2186768
switch#
```

4.8.36 show event-monitor igmpsnooping

The `show event-monitor igmpsnooping` command performs an SQL-style query on the event-monitor database, using the statement specified in the command.

Command Mode

Privileged EXEC

Command Syntax

```
show event-monitor igmpsnooping [GROUP] [MESSAGES] [MAC] [INTERFACE] [VLAN] [TIME]
```

Parameters

- **GROUP** used with aggregate functions to group results. Analogous to SQL group by command.
 - <no parameter> results are not grouped.
 - **group-by interface** results are grouped by interface.
 - **group-by mac** results are grouped by MAC address.
 - **group-by vlan** results are grouped by VLAN.
- **MESSAGES** number of messages returned from query. Analogous to SQL limit command.
 - <no parameter> result-set size is not limited.
 - **limit msg_quantity** number of results that are displayed. Values range from 1 to 15,000.
- **MAC** restricts result-set to events that include specified MAC address (SQL Like command).
 - <no parameter> result-set not restricted to specific MAC addresses.
 - **match-mac mac_address_rex** MAC address, as represented by regular expression.
- **INTERFACE** restricts result-set to events that include specified interface (SQL Like command).
 - <no parameter> result-set not restricted by interface.
 - **match-interface ethernet e_range** Ethernet interface list.
 - **match-interface loopback l_range** loopback interface list.
 - **match-interface management m_range** management interface list.
 - **match-interface port-channel c_range** port channel interface list.
 - **match-interface vlan v_range** VLAN interface list.
 - **match-interface tunnel t_range** tunnel interface list.
 - **match-interface vxlan vx_range** VXLAN interface list.
- **TIME** restricts result-set to events with specified period.
 - <no parameter> result-set not restricted by time of event.
 - **match-time last-minute** includes events generated during last minute.
 - **match-time last-day** includes events generated during last day.
 - **match-time last-hour** includes events generated during last hour.
 - **match-time last-week** includes events generated during last week.
- **VLAN** restricts result-set to events that include a specific VLAN (SQL Like command).
 - <no parameter> result-set not restricted by time of event.
 - **match-vlan vlan** VLAN interface number.

Examples

```
switch#show event-monitor igmpsnooping
switch#
```

4.8.37 show event-monitor mac

The `show event-monitor mac` command performs an SQL-style query on the event monitor database and displays MAC address table events as specified by command parameters. The event monitor buffer and all backup logs are synchronized into a single SQLite file.

Command Mode

Privileged EXEC

Command Syntax

```
show event-monitor mac [GROUP] [MESSAGES] [INTERFACE] [MAC] [TIME]
```

Optional parameters can be placed in any order.

Parameters

- GROUP used with aggregate functions to group results. Analogous to SQL group by command.
 - <no parameter> results are not grouped.
 - **group-by interface** results are grouped by interface.
 - **group-by mac** results are grouped by MAC address.
- MESSAGES number of messages returned from query. Analogous to SQL limit command.
 - <no parameter> result-set size is not limited.
 - **limit msg_quantity** number of results that are displayed. Values range from 1 to 15,000.
- INTERFACE restricts result-set to events that include specified interface (SQL Like command).
 - <no parameter> result-set not restricted by interface.
 - **match-interface ethernet e_range** Ethernet interface list.
 - **match-interface loopback l_range** loopback interface list.
 - **match-interface management m_range** management interface list.
 - **match-interface port-channel c_range** port channel interface list.
 - **match-interface vlan v_range** VLAN interface list.
 - **match-interface tunnel t_range** tunnel interface list.
 - **match-interface vxlan vx_range** VXLAN interface list.
- MAC restricts result-set to events that include specified MAC address (SQL Like command).
 - <no parameter> result-set not restricted to specific MAC addresses.
 - **match-mac mac_address_rex** MAC address, as represented by regular expression.
- TIME restricts result-set to events with specified period.
 - <no parameter> result-set not restricted by time of event.
 - **match-time last-minute** includes events generated during last minute.
 - **match-time last-day** includes events generated during last day.
 - **match-time last-hour** includes events generated during last hour.
 - **match-time last-week** includes events generated during last week.

Examples

- This command displays all events triggered by MAC address table events.

```
switch#show event-monitor mac
% Writing 0 Arp, 0 Route, 1 Mac events to the database
2012-01-19 13:57:55|1|0808.0808.0808|Ethernet1|configuredStaticMac|
added|0
```

- This command displays events triggered by MAC address table changes.

```
switch#show event-monitor mac match-mac 08:08:08:%
```

```
2012-01-19 13:57:55|1|0808.0808.0808|Ethernet1|configuredStaticMac|
added|0
```

4.8.38 show event-monitor mroute

The `show event-monitor mroute` command performs an SQL-style query on the event-monitor database, using the statement specified in the command.

Command Mode

Privileged EXEC

Command Syntax

```
show event-monitor mroute [GROUP] [MESSAGES] [IP] [INTERFACE] [SRC_IP] [TIME]
```

Optional parameters can be placed in any order.

Parameters

- GROUP used with aggregate functions to group results. Analogous to SQL group by command.
 - <no parameter> results are not grouped.
 - **group-by** *interface* results are grouped by interface.
 - **group-by** *ip6* results are grouped by IPv6 address.
 - **group-by** *mac* results are grouped by MAC address.
 - **group-by** *vrf* results are grouped by VRF.
- MESSAGES number of messages returned from query. Analogous to SQL limit command.
 - <no parameter> result-set size is not limited.
 - **limit** *msg_quantity* number of results that are displayed. Values range from 1 to 15,000.
- IP restricts result-set to events that include specified IP address (SQL Like command).
 - <no parameter> result-set not restricted to specific IP addresses.
 - **match-ipv6** *ip_address_rex* IP address, as represented by regular expression.
- INTERFACE restricts result-set to events that include specified interface (SQL Like command).
 - <no parameter> result-set not restricted by interface.
 - **match-interface ethernet** *e_range* Ethernet interface list.
 - **match-interface loopback** *l_range* loopback interface list.
 - **match-interface management** *m_range* management interface list.
 - **match-interface port-channel** *c_range* port channel interface list.
 - **match-interface vlan** *v_range* VLAN interface list.
 - **match-interface tunnel** *t_range* tunnel interface list.
 - **match-interface vxlan** *vx_range* VXLAN interface list.
- SRC_IP restricts result-set to events that include specified Source IP address (SQL Like command).
 - <no parameter> result-set not restricted to specific IP addresses.
 - **match-ip** *ip_address_rex* IP address, as represented by regular expression.
- TIME restricts result-set to events with specified period.
 - <no parameter> result-set not restricted by time of event.
 - **match-time last-minute** includes events generated during last minute.
 - **match-time last-day** includes events generated during last day.
 - **match-time last-hour** includes events generated during last hour.
 - **match-time last-week** includes events generated during last week.

Examples

- This command displays neighbor table events listed in the event monitor database.

```
switch#show event-monitor mroute
2011-07-28 12:33:28|default|16.17.18.19/32|225.0.0.1/32|||added|30
```

```
2011-07-28 12:33:28|default|16.17.18.19/32|225.0.0.1/32|Vlan2|iif|join|
31
2011-07-28 12:33:28|default|16.17.18.19/32|225.0.0.1/32|Vlan3|oif|join|
32
2011-07-28 12:33:28|default|16.17.18.19/32|225.0.0.1/32|Vlan4|oif|join|
33
2011-07-28 12:33:28|default|10.11.12.13/32|225.0.0.2/32|||added|34
2011-07-28 12:33:28|default|10.11.12.13/32|225.0.0.2/32|Vlan3|iif|join|
35
2011-07-28 12:33:28|default|10.11.12.13/32|225.0.0.2/32|Vlan2|oif|join|
36
2011-07-28 12:33:28|default|16.17.18.19/32|225.0.0.1/32|Vlan4||leave|37
2011-07-28 12:33:28|default|16.17.18.19/32|225.0.0.1/32|||deleted|38
2011-07-28 12:33:28|default|10.11.12.13/32|225.0.0.2/32|||deleted|39
```

4.8.39 show event-monitor neighbor

The `show event-monitor neighbor` command performs an SQL-style query on the event monitor database and displays neighbor table events as specified by command parameters. The event monitor buffer and all backup logs are synchronized into a single SQLite file.

Command Mode

Privileged EXEC

Command Syntax

```
show event-monitor neighbor [GROUP] [MESSAGES] [INTERFACE] [IP6] [MAC] [TIME] [VRF]
```

Optional parameters can be placed in any order.

Parameters

- GROUP used with aggregate functions to group results. Analogous to SQL group by command.
 - <no parameter> results are not grouped.
 - **group-by** *interface* results are grouped by interface.
 - **group-by** *ip6* results are grouped by IPv6 address.
 - **group-by** *mac* results are grouped by MAC address.
 - **group-by** *vrf* results are grouped by VRF.
- MESSAGES number of messages returned from query. Analogous to SQL limit command.
 - <no parameter> result-set size is not limited.
 - **limit** *msg_quantity* number of results that are displayed. Values range from 1 to 15,000.
- INTERFACE restricts result-set to events that include specified interface (SQL Like command).
 - <no parameter> result-set not restricted by interface.
 - **match-interface ethernet** *e_range* Ethernet interface list.
 - **match-interface loopback** *l_range* loopback interface list.
 - **match-interface management** *m_range* management interface list.
 - **match-interface port-channel** *c_range* port channel interface list.
 - **match-interface vlan** *v_range* VLAN interface list.
 - **match-interface tunnel** *t_range* tunnel interface list.
 - **match-interface vxlan** *vx_range* VXLAN interface list.
- IP6 restricts result-set to events that include specified IP address (SQL Like command).
 - <no parameter> result-set not restricted to specific IP addresses.
 - **match-ipv6** *ip6_address_rex* IPv6 address, as represented by regular expression.
- MAC restricts result-set to events that include specified MAC address (SQL Like command).
 - <no parameter> result-set not restricted to specific MAC addresses.
 - **match-mac** *mac_address_rex* MAC address, as represented by regular expression.
- TIME restricts result-set to events with specified period.
 - <no parameter> result-set not restricted by time of event.
 - **match-time last-minute** includes events generated during last minute.
 - **match-time last-day** includes events generated during last day.
 - **match-time last-hour** includes events generated during last hour.
 - **match-time last-week** includes events generated during last week.
- VRF restricts result-set to events that include a specific VRF (SQL Like command).
 - <no parameter> result-set not restricted by time of event.
 - **match-vrf** *vrf_name* VRF name, as represented by a regular expression.

Examples

-
- This command displays neighbor table events listed in the event monitor database.

```
switch#show event-monitor neighbor
2019-09-30 14:37:32.894147|def0::1|Vlan1|default|0005.0005.0005|1|
added|1
2019-09-30 14:37:32.894395|def0::2|Vlan1|default|0005.0005.0005|1|
added|2
2019-09-30 14:37:32.894607|def0::3|Vlan1|default|0005.0005.0005|1|
added|3
2019-09-30 14:37:32.894815|def0::4|Vlan1|default|0005.0005.0005|1|
added|4
2019-09-30 14:37:32.895071|def0::5|Vlan1|default|0005.0005.0005|1|
added|5
2019-09-30 14:37:32.895303|def0::6|Vlan1|default|0005.0005.0005|1|
added|6
2019-09-30 14:37:32.895527|def0::7|Vlan1|default|0005.0005.0005|1|
added|7
2019-09-30 14:37:32.895732|def0::8|Vlan1|default|0005.0005.0005|1|
added|8
2019-09-30 14:37:32.895968|def0::9|Vlan1|default|0005.0005.0005|1|
added|9
2019-09-30 14:37:32.896194|def0::a|Vlan1|default|0005.0005.0005|1|
added|10
```

4.8.40 show event-monitor route6

The `show event-monitor route6` command performs an SQL-style query on the event monitor database and displays routing6 table events as specified by command parameters. The event monitor buffer and all backup logs are synchronized into a single SQLite file.

Command Mode

Privileged EXEC

Command Syntax

```
show event-monitor route6 [GROUP] [MESSAGES] [IP6] [TIME]
```

Optional parameters can be placed in any order.

Parameters

- GROUP used with aggregate functions to group results. Analogous to SQL group by command.
 - <no parameter> results are not grouped.
 - **group-by** *interface* results are grouped by interface.
 - **group-by** *ip6* results are grouped by IPv6 address.
 - **group-by** *mac* results are grouped by MAC address.
 - **group-by** *vrf* results are grouped by VRF.
- MESSAGES number of messages returned from query. Analogous to SQL limit command.
 - <no parameter> result-set size is not limited.
 - **limit** *msg_quantity* number of results that are displayed. Values range from 1 to 15,000.
- IP6 restricts result-set to events that include specified IP address (SQL Like command).
 - <no parameter> result-set not restricted to specific IP addresses.
 - **match-ipv6** *ip6_address_rex* IPv6 address, as represented by regular expression.
- TIME restricts result-set to events with specified period.
 - <no parameter> result-set not restricted by time of event.
 - **match-time last-minute** includes events generated during last minute.
 - **match-time last-day** includes events generated during last day.
 - **match-time last-hour** includes events generated during last hour.
 - **match-time last-week** includes events generated during last week.

Examples

- This command displays neighbor table events listed in the event monitor database.

```
switch#show event-monitor route6
2019-09-30 14:59:30.660447|def1::1:0/128|default|receive|0|1|updated|41
2019-09-30 14:59:30.660720|def1::2:0/128|default|attached|0|1|updated|
42
2019-09-30 14:59:30.660983|def1::3:0/128|default|staticConfig|0|1|
updated|43
2019-09-30 14:59:30.661226|def1::4:0/128|default|kernel|0|1|updated|44
2019-09-30 14:59:30.661469|def1::5:0/128|default|rip|0|1|updated|45
2019-09-30 14:59:30.661706|def1::6:0/128|default|connected|0|1|updated|
46
2019-09-30 14:59:30.661968|def1::7:0/128|default|redirect|0|1|updated|
47
2019-09-30 14:59:30.662207|def1::8:0/128|default|bgpAggregate|0|1|
updated|48
2019-09-30 14:59:30.662451|def1::9:0/128|default|ospfAggregate|0|1|
updated|49
2019-09-30 14:59:30.662694|def1::a:0/128|default|ospf|0|1|updated|50
2019-09-30 14:59:30.662935|def1::b:0/128|default|bgp|0|1|updated|51
```

```
2019-09-30 14:59:30.663174|def1::c:0/128|default|unknown|0|1|updated|52  
switch#
```

4.8.41 show event-monitor route

The `show event-monitor route` command performs an SQL-style query on the event monitor database and displays routing table events as specified by command parameters. The event monitor buffer and all backup logs are synchronized into a single SQLite file.

Command Mode

Privileged EXEC

Command Syntax

```
show event-monitor route [GROUP] [MESSAGES] [IP] [TIME]
```

Optional parameters can be placed in any order.

Parameters

- GROUP used with aggregate functions to group results. Analogous to SQL group by command.
 - <no parameter> results are not grouped.
 - **group-by** *ip* results are grouped by IPv4 address.
- MESSAGES number of messages returned from query. Analogous to SQL limit command.
 - <no parameter> result-set size is not limited.
 - **limit** *msg_quantity* number of results that are displayed. Values range from 1 to 15,000.
- IP restricts result-set to events that include specified IP address (SQL Like command).
 - <no parameter> result-set not restricted to specific IP addresses.
 - **match-ip** *ip_address_rex* IP address, as represented by regular expression.
- TIME restricts result-set to events with specified period.
 - <no parameter> result-set not restricted by time of event.
 - **match-time last-minute** includes events generated during last minute.
 - **match-time last-day** includes events generated during last day.
 - **match-time last-hour** includes events generated during last hour.
 - **match-time last-week** includes events generated during last week.

Example

- This command displays 10 routing table events listed in the event monitor database.

```
switch#show event-monitor route limit 10
2019-09-30 14:01:21.659428|16.16.16.255/32|default|receiveBcast|0|0|
updated|20
2019-09-30 14:01:21.659464|192.168.201.12/30|default|connected|1|0|
updated|21
2019-09-30 14:01:21.659497|192.168.1.255/32|default|receiveBcast|0|0|
updated|22
2019-09-30 14:01:21.659503|192.168.201.8/32|default|receiveBcast|0|0|
updated|23
2019-09-30 14:01:21.659512|16.16.16.0/32|default|receiveBcast|0|0|
updated|24
2019-09-30
14:01:21.659517|192.168.201.12/32|default|receiveBcast|0|0|updated|25
2019-09-30
14:01:21.659524|192.168.201.15/32|default|receiveBcast|0|0|updated|26
2019-09-30 14:01:21.659541|192.168.201.8/30|default|connected|1|0|
updated|27
2019-09-30 14:01:21.659564|16.16.16.0/24|default|connected|1|0|updated|
28
2019-09-30 14:01:21.659578|192.168.201.9/32|default|receive|0|0|
updated|29
```

```
switch#
```

4.8.42 show event-monitor sqlite

The `show event-monitor sqlite` command performs an SQL-style query on the event monitor database, using the statement specified in the command.

Command Mode

Privileged EXEC

Command Syntax

```
show event-monitor sqlite statement
```

Parameters

- *statement* SQLite statement.

Example

- This command displays all entries from the route table.

```
switch#show event-monitor sqlite select * from route;
2019-09-30 14:01:21.659428|16.16.16.255/32|default|receiveBcast|0|0|
updated|20
2019-09-30 14:01:21.659464|192.168.201.12/30|default|connected|1|0|
updated|21
2019-09-30 14:01:21.659497|192.168.1.255/32|default|receiveBcast|0|0|
updated|22
2019-09-30 14:01:21.659503|192.168.201.8/32|default|receiveBcast|0|0|
updated|23
2019-09-30 14:01:21.659512|16.16.16.0/32|default|receiveBcast|0|0|
updated|24
2019-09-30
14:01:21.659517|192.168.201.12/32|default|receiveBcast|0|0|updated|25
2019-09-30
14:01:21.659524|192.168.201.15/32|default|receiveBcast|0|0|updated|26
2019-09-30 14:01:21.659541|192.168.201.8/30|default|connected|1|0|
updated|27
2019-09-30 14:01:21.659564|16.16.16.0/24|default|connected|1|0|updated|
28
2019-09-30 14:01:21.659578|192.168.201.9/32|default|receive|0|0|
updated|29
switch#
```

4.8.43 show event-monitor stpunstable

The `show event-monitor stpunstable` command performs an SQL-style query on the event-monitor database, using the statement specified in the command.

Command Mode

Privileged EXEC

Command Syntax

```
show event-monitor stpunstable [MESSAGES] [TIME]
```

Optional parameters can be placed in any order.

Parameters

- MESSAGES number of messages returned from query. Analogous to SQL limit command.
 - <no parameter> result-set size is not limited.
 - **limit** *msg_quantity* number of results that are displayed. Values range from 1 to 15,000.
- TIME restricts result-set to events with specified period.
 - <no parameter> result-set not restricted by time of event.
 - **match-time last-minute** includes events generated during last minute.
 - **match-time last-day** includes events generated during last day.
 - **match-time last-hour** includes events generated during last hour.
 - **match-time last-week** includes events generated during last week.

Example

```
switch#show event-monitor stpunstable limit 5
2019-02-07 07:22:10.286164|Cist|Ethernet5|forward-delay-while|1
2019-02-07 07:22:10.286651|Cist|Ethernet6|forward-delay-while|2
2019-02-07 07:22:10.286844|Cist|Ethernet8|forward-delay-while|3
2019-02-07 07:22:10.287030|Cist|Ethernet14|forward-delay-while|4
2019-02-07 07:22:10.287215|Cist|Ethernet21|forward-delay-while|5
switch#
```

4.8.44 show hostname

The `show hostname` command displays the hostname and the fully qualified domain name (FQDN) of the switch.

Command Mode

EXEC

Command Syntax

```
show hostname
```

Example

- This command displays the hostname and FQDN of the switch.

```
switch>show hostname
Hostname: switch_1
FQDN:    switch_1.aristanetworks.com

switch>
```

4.8.45 show hosts

The `show hosts` command displays the default domain name, name lookup service style, a list of name server hosts, and the static hostname-IP address maps.

Command Mode

EXEC

Command Syntax

`show hosts`

Example

- This command displays the switches IP domain name:

```
switch>show hosts

Default domain is: aristanetworks.com
Name/address lookup uses domain service
Name servers are: 172.22.22.40, 172.22.22.10
Static Mappings:

Hostname                IP      Addresses
TEST_LAB                IPV410.24.18.6
PRODUCTION_LAB          IPV410.24.18.7
SUPPORT_LAB             IPV62001:0DB8:73:ff:ff:26:fd:90
switch>
```

4.8.46 show ip domain-name

The `show ip domain-name` command displays the switch's IP domain name that is configured with the `ip domain-name` command.

Command Mode

EXEC

Command Syntax

```
show ip domain-name
```

Example

- This command displays the switch's IP domain name:

```
switch>show ip domain-name
aristanetworks.com
switch>
```

4.8.47 show ip name-server

The `show ip name-server` command displays the ip addresses of name-servers in *running-config*. The name servers are configured by the `ip name-server` command.

Command Mode

EXEC

Command Syntax

```
show ip name-server
```

Example

- This command displays the IP address of name servers that the switch is configured to access.

```
switch>show ip name-server
172.22.22.10
172.22.22.40
switch>
```

4.8.48 show l1 destination

The `show l1 destination` command displays the list of all destinations for all interfaces.

Command Mode

Privileged EXEC

Command Syntax

```
show l1 destination [interface]
```

Parameters

- **interface** lists the destination interfaces to connect for the specified interface.
 - **Application** Application FPGA connector interface
 - **Cpu** CPU interface
 - **Ethernet** Ethernet interface
 - **Switch** Switch interface

Example

- This command displays the the list of all interfaces to connect in the crosspoint and their specific destination ports.

```
switch>show l1 destination
  Interface          Destination Interface(s)  Type
-----
 Ethernet1          App1/1, Sw1              dynamic
 Ethernet2          Ethernet3, Ethernet4     dynamic
 Ethernet3
 Ethernet4
 Ethernet5
 App1/1              Ethernet1                 dynamic
 App1/2              Sw17                      static
 Sw1
 Sw2
 Sw3
 Sw4
 Sw5
 Sw17                App1/2                    static
 Cpu1
 Cpu2
```

 **Note:** Interfaces that do not have a destination port are listed too but the Destination Interface and Type columns appear as blanks.

- This command displays the list of destination interfaces to connect for the Ethernet interface *et1*.

```
switch#show l1 destination interface et1
  Interface          Destination Interfaces  Type
-----
 Ethernet1          App1/1, Sw1            dynamic
```

4.8.49 show l1 matrix

The `show l1 matrix` command displays the matrix representation of Layer 1 paths for available interfaces in the privileged EXEC mode.

Command Mode

Privileged EXEC

Command Syntax

```
show l1 matrix [all | interface | detail | physical]
```

Parameters

- **all** displays the matrix of Layer 1 paths for possible interface types even if they do not have a connection.
- **interface** displays the matrix of Layer 1 paths for the specified interface.
 - **Application** Application FPGA connector interface
 - **Cpu** CPU interface
 - **Ethernet** Ethernet interface
 - **Switch** Switch interface
- **detail** displays the detailed matrix of Layer 1 paths.
- **physical** displays the Layer 1 matrix for physical interfaces only.

Example

- This command displays the matrix of Layer 1 paths for all available interface types.

```
switch>show l1 matrix
          Ethernet      Switch      App
          1 3 4        1 17        1/1 1/2
          | | |        | |        | |
Et1 -> -|-|-|-----+|-----+ |
Et2 -> -|-+++        |           |
Sw17 -> -|-----|-----+
App1/1 -> -+          |
App1/2 -> -----+
```

- This command displays the matrix of Layer 1 paths for all available interface types even if the interfaces do not have a connection.

```
switch>show l1 matrix all
          Ethernet
          1 2 3 4 5 6 7 8 9 10 11 12 13 14 15 16
          | | | | | | | | | | | | | | | |
          9 10
          | | | | | | | | | | | | | | | |
Et1 -> -|-|-|-|-----+-----+
Et2 -> -|-|-|-+
Et3 -> |
Et4 -> |
Et5 -> |
Et6 -> |
Et7 -> |
Et8 -> |
Et9 -> |
Et10 -> |
Et11 -> |
Et12 -> |
Et13 -> |
Et14 -> |
Et15 -> |
```

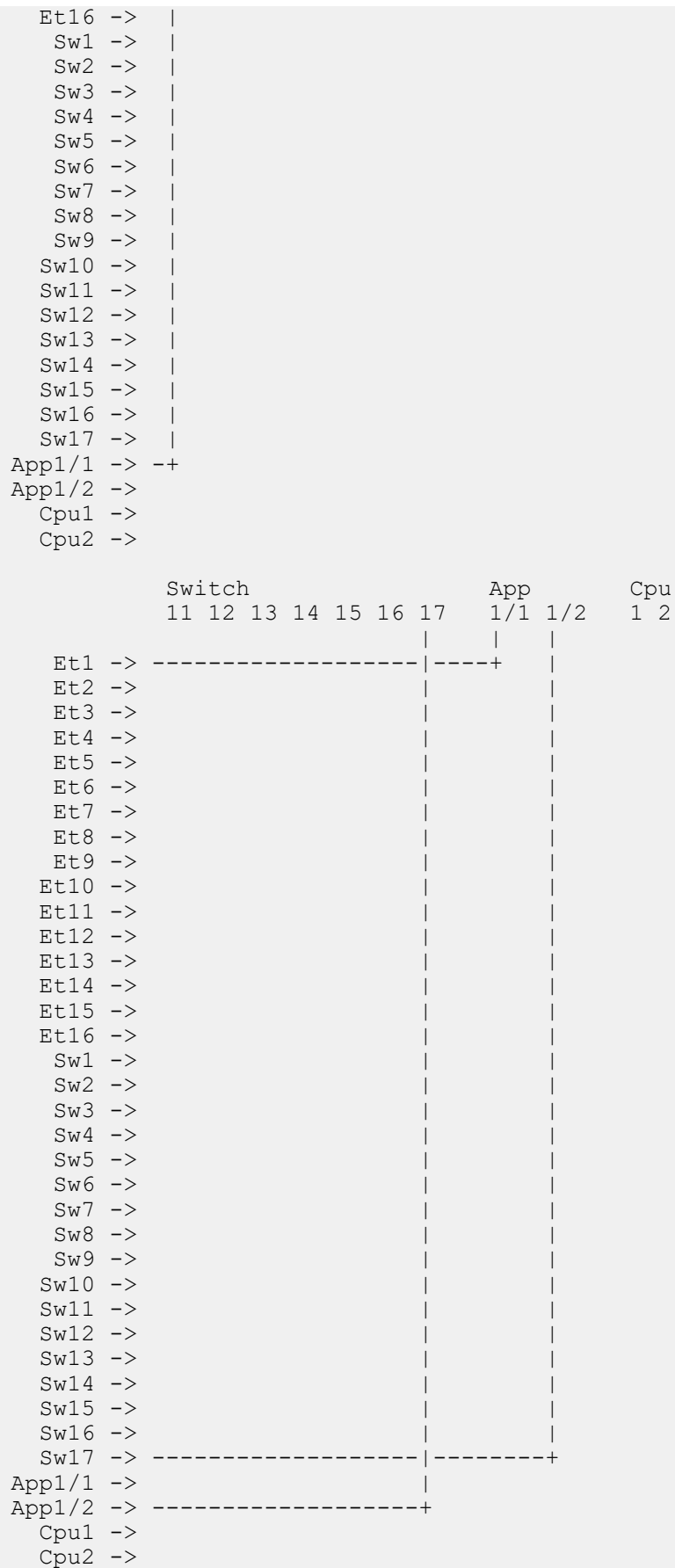
- This command displays the matrix of Layer 1 paths for the specific Ethernet interfaces *et1* and *et4*.

```
switch>show l1 matrix interface et1, et4
      Ethernet      Switch      App
      1 4           1           1/1
      | |           |           |
Et1 -> -|-|-----+-----+
Et2 -> -|-+
App1/1 -> -+
```

4.8.50 show l1 path

The `show l1 path` command displays the source and destination paths for all interfaces in the system.

Command Mode

Privileged EXEC

Command Syntax

```
show l1 path [interface]
```

Parameters

- **interface** lists the connections available for the specified interface.
 - **Application** Application FPGA connector interface
 - **Cpu** CPU interface
 - **Ethernet** Ethernet interface
 - **Switch** Switch interface

Example

- This command displays the source and destination paths for all interfaces in the system.

```
switch>show l1 path
Source          Destination      Type
-----
Ethernet1      App1/1          dynamic
Ethernet1      Sw1             dynamic
Ethernet2      Ethernet3       dynamic
Ethernet2      Ethernet4       dynamic
App1/1         Ethernet1       dynamic
App1/2         Sw17            static
Sw17          App1/2          static
```

- This command displays the list of all connections that include the Ethernet interfaces *et1* and *et4*.

```
switch#show l1 path interface et1, et4
Source          Destination      Type
-----
Ethernet1      App1/1          dynamic
Ethernet1      Sw1             dynamic
Ethernet2      Ethernet4       dynamic
App1/1         Ethernet1       dynamic
```

4.8.51 show l1 source

The `show l1 source` command displays the list of all source interfaces to connect for specific interfaces such as Ethernet ports, switch, FPGA ports, or CPU ports.

Command Mode

Privileged EXEC

Command Syntax

```
show l1 source [interface | capabilities]
```

Parameters

- **interface** lists the source interfaces available to connect for the specified interface.
 - **Application** Application FPGA connector interface
 - **Cpu** CPU interface
 - **Ethernet** Ethernet interface
 - **Switch** Switch interface
- **capabilities** lists the Layer 1 source capabilities for the specified switch.

Example

- This command displays the list of all source interfaces to connect in the crosspoint and the specific interfaces.

```
switch#show l1 source
Interface          Source Interface  Type
-----
Ethernet1          App1/1            dynamic
Ethernet2
Ethernet3          Ethernet2        dynamic
Ethernet4          Ethernet2        dynamic
Ethernet5          MAC              dynamic
App1/1             Ethernet1        dynamic
App1/2             Sw17             static
Sw1                Ethernet1        dynamic
Sw2
Sw3
Sw4
Sw5
Sw17               App1/2           static
Cpu1
Cpu2
```

 **Note:** Interfaces that do not have a source port are listed too but the Source Interface and Type columns appear as blanks.

- This command displays the list of source interfaces to connect for the Ethernet interface `et1`.

```
switch#show l1 source interface et1
Interface          Source Interface  Type
-----
Ethernet1          App1/1            dynamic
```

4.8.52 show l1 source capabilities

The `show l1 source capabilities` command displays the list of all interfaces available to connect in the crosspoint and their possible source ports.

Command Mode

Privileged EXEC

Command Syntax

```
show l1 source capabilities
```

Example

- This command displays the list of all possible source interfaces available to connect in the crosspoint and the specific interfaces.

```
switch#show l1 source capabilities
Interface                Possible Source Interface(s)
-----
Ethernet1                Ap1/1,Cpu1-2,Et1-16,Sw1-16
Ethernet2                Ap1/1,Cpu1-2,Et1-16,Sw1-16
Ethernet3                Ap1/1,Cpu1-2,Et1-16,Sw1-16
Ethernet4                Ap1/1,Cpu1-2,Et1-16,Sw1-16
Ethernet5                Ap1/1,Cpu1-2,Et1-16,Sw1-16
Application1/1           Ap1/1,Cpu1-2,Et1-16,Sw1-16
Application1/2           Sw17
Switch1                  Ap1/1,Cpu1-2,Et1-16,Sw1-16
Switch2                  Ap1/1,Cpu1-2,Et1-16,Sw1-16
Switch3                  Ap1/1,Cpu1-2,Et1-16,Sw1-16
Switch4                  Ap1/1,Cpu1-2,Et1-16,Sw1-16
Switch5                  Ap1/1,Cpu1-2,Et1-16,Sw1-16
Switch17                 Ap1/2
Cpu1                     Ap1/1,Cpu1-2,Et1-16,Sw1-16
Cpu2                     Ap1/1,Cpu1-2,Et1-16,Sw1-16
```

- This command displays the list of possible source interfaces available to connect for the Ethernet interface `et1`.

```
switch#show l1 source interface et1 capabilities
Interface                Possible Source Interface(s)
-----
Ethernet1                Ap1/1,Cpu1-2,Et1-16,Sw1-16
```

- This command displays the list of possible source interfaces available to connect for the FPGA port `fpga`.

```
switch#show l1 source fpga capabilities
Interface                Possible Source Interface(s)
-----
Application1/1           Ap1/1,Cpu1-2,Et1-16,Sw1-16
Application1/2           Sw17
```

4.8.53 show local-clock time-properties

The `show local-clock time-properties` command displays the Precision Time Protocol (PTP) clock properties.

Command Mode

Privileged EXEC

Command Syntax

```
show local-clock time-properties
```

Examples

- This command shows the PTP clock properties.

```
switch#show local-clock time-properties
Current UTC offset valid: False
Current UTC offset: 0
Leap 59: False
Leap 61: False
Time Traceable: False
Frequency Traceable: False
PTP Timescale: False
Time Source: 0x0
switch#
```

4.8.54 show ntp associations

The `show ntp associations` command displays the status of connections to NTP servers.

Command Mode

EXEC

Command Syntax

```
show ntp associations
```

Display Values

- **refid (reference ID)**: the reference ID of the configured NTP server's time source. The reference ID is either the IPv4 address of the source or (if the source has an IPv6 address) the first four octets of the MD5 hash of the IPv6 address.
- **st (stratum)**: number of steps between the switch and the reference clock.
- **t (transmission type)**: u unicast; b broadcast; l local.
- **when**: interval since reception of last packet (seconds unless unit is provided).
- **poll**: interval between NTP poll packets. Maximum (1024) reached as server and client syncs.
- **reach**: octal number that displays status of last eight NTP messages (377 - all messages received).
- **delay**: round-trip delay of packets to the NTP server.
- **offset**: difference between local clock and the server's clock.
- **jitter**: nominal offset estimation error.

Example

- This command displays the status of the switch's NTP associations.

```
switch>show ntp associations
      remote          refid      st t when  poll reach  delay  offset
 jitter
=====
=====
+1.ntp.arista.co 125.157.10.11  2 u  539  1024  377  121.748  -0.345
 0.893
-3.ntp.arista.co 127.31.152.34  2 u  868  1024  377  101.671   2.434
 1.529
+2.ntp.arista.co 176.131.12.185 2 u  676  1024  377  116.505   0.03
 0.768
*4.ntp.arista.co 120.181.192.192 2 u  696  1024  377   48.431  -0.416
 0.15
switch#
```

4.8.55 show ntp status

The `show ntp status` command displays the status of NTP on the switch. If the switch clock is not synchronized to an NTP server, the status reads “unsynchronised” and shows the server polling interval. If the clock is synchronized to an NTP server, the status shows the IP address and stratum of the server, the precision of the synchronization, and the polling interval.



Note:

In EOS releases prior to 4.23.2, this command identified system peers with IPv6 addresses by their reference IDs (the first four octets of the MD5 hash of the IPv6 address). In later releases, this command always shows the IP address of the system peer (whether IPv4 or IPv6).

Command Mode

EXEC

Command Syntax

```
show ntp status
```

Example

- This command displays the switch’s NTP status.

```
switch>show ntp status
synchronised to NTP server (192.168.78.62) at stratum 3
  time correct to within 66 ms
  polling server every 1024 s
switch>
```

Timing Protocols

The Precision Time Protocol (PTP) provides a greater degree of clock accuracy for networked devices, allowing clocks to be synchronized locally in increments of less than a microsecond. PTP uses a master-slave hierarchy similar to that used by NTP. The most precise clock available is referred to as the master clock, and slave devices use the signal from the master to synchronize their own clocks.

The master clock sends out a **sync** message (referred to as an **announce** message in IEEE 1588-2008) at a regular interval. The slave clock responds with a time-stamped delay request message in order to measure and compensate for packet delays between the devices. The slave then receives a message from the master specifying when the delay message was received, which allows the slave to calculate final values for clock synchronization. Synchronization is maintained by the regular exchange of PTP packets between master and slave.

 **Note:** Arista switches do not support setting of the system clock using PTP. System clock synchronization is best supported by the NTP service on the PTP grandmaster.

PTP is disabled globally by default. The following steps are required to enable PTP on an interface:

- [Setting the PTP Mode](#)
- [Enabling PTP on an Interface](#)

The following PTP global configurations are optional:

- [Configuring the PTP Domain](#)
- [Configuring the Offset Hold Time](#)
- [Setting the PTP Priority](#)
- [Configuring the Source IP](#)
- [Configuring the TTL for PTP Packets](#)
- [Configuring PTP Monitoring](#)

The following PTP interface-level configurations are optional:

- [Setting the PTP Announce Interval](#)
- [Setting the PTP Timeout Interval](#)
- [Configuring the PTP Delay Mechanism](#)
- [Setting the Delay Request Interval](#)
- [Setting the Peer Delay Request Interval](#)
- [Setting the Peer Link Propagation Threshold](#)
- [Setting the Interval for Sending Synchronization Messages](#)
- [Setting the PTP Transport Type](#)
- [Viewing PTP Settings and Status](#)
- [Precision Time Protocol \(PTP\) Commands](#)

5.1 Setting the PTP Mode

To allow PTP to be used on switch interfaces, first set the PTP mode using the `ptp mode` command. PTP mode options include:

- **boundary** The device acts as a boundary clock, and both runs and participates in the best master clock algorithm.
- **disabled** PTP is disabled, and the device forwards all PTP packets as normal traffic.

-
- **end-to-end transparent** The device acts as an end-to-end transparent clock, synchronizing all ports to a connected master clock and updating the time interval field of forwarded PTP packets using switch residence time.
 - **peer-to-peer transparent** The device acts as a peer-to-peer transparent clock, synchronizing all ports to a connected master clock and updating the time interval field of forwarded PTP packets using switch residence time and inbound path delays.
 - **generalized Precision Time Protocol (gPTP)** The device runs generalized Precision Time Protocol (gPTP), participating in the best master clock algorithm but also updating the interval field of forwarded PTP packets using switch residence time and inbound path delays.

To disable PTP globally on the switch, use the **no** or **default** forms of the `ptp mode` command.

Example:

This command configures the device as a PTP boundary clock.

```
switch(config)#ptp mode boundary
switch(config)#
```

5.2 Enabling PTP on an Interface

To enable PTP on a specific interface on the device, use the `ptp enable` command.

Example

- This command enables PTP on Ethernet interface 5.

```
switch(config)#interface ethernet 5
switch(config-if-Et5)#ptp enable
```

5.3 Configuring the PTP Domain

To set the domain number to use for the clock, use the `ptp domain` command.

- This command configures the domain 1 to use with a clock.

```
switch(config)#ptp domain 1
switch(config)#
```

5.4 Configuring the Offset Hold Time

To set the PTP offset hold time, use the `ptp hold-ptp-time` command.

- This command configures the PTP offset hold time to 600 seconds.

```
switch(config)#ptp hold-ptp-time 600
switch(config)#
```

5.5 Setting the PTP Priority

To set the priority 1 value, use the `ptp priority1` command. Lower values take precedence.

This command configures the priority 1 value of 120 to use when advertising the clock.

```
switch(config)#ptp priority1 120
switch(config)#
```

To set the priority 2 value for the clock, use the `ptp priority2` command.

This command configures the priority 2 value of 128.

```
switch(config)#ptp priority2 128
switch(config)#
```

5.6 Configuring the Source IP

To set the source IP address for all PTP packets, use the `ptp source ip` command.

- This command configures the source IP address of 10.0.2.1 for all PTP packets.

```
switch(config)#ptp source ip 10.0.2.1
switch(config)#
```

5.7 Configuring the TTL for PTP Packets

To set the time to live (TTL) of PTP packets, use the `ptp ttl` command. TTL is the maximum number of hops that a PTP packet may make.

- This command configures a TTL of 64 hops for PTP packets.

```
switch(config)#ptp ttl 64
switch(config)#
```

5.8 Configuring PTP Monitoring

PTP monitoring records PTP information including offset from master, mean path delay, and skew values, which can then be viewed using a `show` command. When this feature is enabled, PTP Syslog messages will also be generated for those metrics for which threshold values have been configured on the switch. PTP monitoring is enabled by default.

Enabling and Disabling PTP Monitoring

Use the `ptp monitor` command to enable PTP monitoring on the device (it is enabled by default). The `no` form of the command disables PTP monitoring and clears all the recorded PTP data.

Example

- This command disables PTP monitoring and clears all recorded PTP data from the switch.

```
switch(config)#no ptp monitor
```

Configuring the Offset-from-master Threshold

The offset is the difference in nanoseconds between master and slave time. Use the `ptp monitor threshold offset-from-master` command to specify the offset-from-master threshold in nanoseconds. A Syslog message is generated if the most recently calculated time offset from the PTP master is outside of the range ($-\langle\text{threshold}\rangle$, $\langle\text{threshold}\rangle$). The maximum offset threshold is one second. The no form of the command clears the threshold value and prevents further Syslog messages from being generated for this parameter.

Example

- This command sets an offset-from-master threshold value of 500 nanoseconds.

```
switch(config)#ptp monitor threshold offset-from-master 500
```

Configuring the Mean-path-delay Threshold

Mean path delay is the mean time in nanoseconds that PTP packets take to travel between master and slave. Use the `ptp monitor threshold mean-path-delay` command to specify the mean-path-delay threshold in nanoseconds. A Syslog message is generated if the value of the most recently calculated mean path delay is greater than or equal to this threshold. The maximum mean-path-delay threshold is one second. The no form of the command clears the threshold value and prevents further Syslog messages from being generated for this parameter.



Note:

Mean path delay is always non-negative.

Example

- This command sets a mean-path-delay threshold value of 2000 nanoseconds.

```
switch(config)#ptp monitor threshold mean-path-delay 2000
```

Configuring the Skew Threshold

PTP skew is the clock frequency difference between master and slave. Use the `ptp monitor threshold skew` command to configure the value of the skew-threshold percentage. A Syslog message is generated if the value of the most recently calculated skew is not in the range ($1/(1+\langle\text{threshold}\rangle)$, $1/(1-\langle\text{threshold}\rangle)$). Skew threshold percentage is represented a double precision (16 digit) real number ranging from 0 (0%) to 10 (1000%). The no form of the command clears the threshold value and prevents further Syslog messages from being generated for this parameter.

Example

- This command sets a skew threshold value of 5 (500%).

```
switch(config)#ptp monitor threshold skew 5
```

5.9 Setting the PTP Announce Interval

To set the interval at which an interface sends PTP **announce** messages, use the `ptp announce interval` command. The interval is measured in log seconds. This value also affects the timeout interval.

This command configures the interval between PTP announcement messages on Ethernet interface 5 to 4 seconds.

```
switch(config)#interface ethernet 5
switch(config-if-Et5)#ptp announce interval 2
switch(config-if-Et5)#
```

5.10 Setting the PTP Timeout Interval

To set the timeout multiplier for an interface, use the `ptp announce timeout` command. The timeout multiplier is the number of announcement intervals that the interface will wait without receiving a PTP announcement before a timeout occurs; values range from 2 to 255. The default multiplier is 3, which results in a 6-second timeout interval when the announcement interval is set to the default of 2 seconds.

This command sets timeout multiplier for the interface to 5; since the announcement interval has just been set to 2 (4 seconds), this means the interface will time out if it doesn't receive a PTP announcement for 20 seconds.

```
switch(config-if-Et5)#ptp announce timeout 5
switch(config-if-Et5)#
```

5.11 Configuring the PTP Delay Mechanism

To set the delay mechanism used in boundary-mode, use the `ptp delay-mechanism` command.

- This command sets the delay mechanism in boundary clock mode for the interface to peer-to-peer.

```
switch(config-if-Et5)#ptp delay-mechanism p2p
switch(config-if-Et5)#
```

5.12 Setting the Delay Request Interval

To set the time for the slave devices to send delay request messages, use the `ptp delay-request interval` command.

- This command sets the time the slave devices to send delay request messages to the master state to 3 for the interface.

```
switch(config-if-Et5)#ptp delay-request interval 3
switch(config-if-Et5)#
```

5.13 Setting the Peer Delay Request Interval

To set the minimum interval between the PTP peer delay-request messages, use the `ptp pdelay-request interval` command.

This command sets the interval between PTP peer delay-request messages on the interface to 3.

```
switch(config-if-Et5)#ptp pdelay-request interval 3
switch(config-if-Et5)#
```

5.14 Setting the Peer Link Propagation Threshold

To set the delay threshold for which the peer will be considered unable to run generalized Precision Time Protocol (gPTP), use the `ptp pdelay-neighbor-threshold` command.

- This command sets the link propagation delay threshold on the interface to 200000 nanoseconds..

```
switch(config-if-Et5)#ptp pdelay-neighbor-threshold 200000
switch(config-if-Et5)#
```

5.15 Setting the Interval for Sending Synchronization Messages

To set the interval (in log seconds) for sending synchronization messages, use the `ptp sync-message interval` command. Value ranges and defaults vary based on the PTP mode of the switch.

- This command configures the interval for sending synchronization messages on the interface to 3 (8 seconds).

```
switch(config-if-Et5)#ptp sync-message interval 3
switch(config-if-Et5)#
```

5.16 Setting the PTP Transport Type

To set the PTP transport type, use the `ptp transport` command.

- This command configures the PTP transport type for the interface to IPv4.

```
switch(config-if-Et5)#ptp transport ipv4
switch(config-if-Et5)#
```

5.17 Viewing PTP Settings and Status

The following commands display the status of the switch PTP server connections:

- [Displaying General PTP Information](#)
- [Displaying PTP Local Clock and Offset](#)
- [Displaying PTP Masters Information](#)
- [Displaying PTP Clock Properties](#)
- [Displaying PTP Information for all Interfaces](#)
- [Displaying PTP Interface Counters](#)
- [Displaying PTP Foreign Master](#)
- [Displaying PTP Source IP](#)
- [Displaying PTP Monitoring Information](#)

5.17.1 Displaying General PTP Information

To display general Precision Time Protocol (PTP) information, use the `show ptp` command.

```
switch#show ptp
PTP Mode: gptp - Generalized PTP Clock
Clock Identity: 2001:0DB8:73:ff:ff:26:fd:90
```

```

Grandmaster Clock Identity: 2001:0DB8:96:ff:fe:6c:ed:02
Number of slave ports: 1
Number of master ports: 6
Slave port: Ethernet33
Mean Path Delay (nanoseconds): 718
Steps Removed: 1
Neighbor Rate Ratio: 1.00000007883
Rate Ratio: 1.00000007883
Interface StateASTime Since LastNeighborMean PathResidence
Capable ChangedRate RatioDelay (ns)Time (ms)
-----
-----
Et1Disabled NoNever1.000
Et2Disabled NoNever1.000
Et3Disabled NoNever1.000
Et4Disabled NoNever1.000
Et5Disabled NoNever1.000
Et6Disabled NoNever1.000
Et7MasterYes0:21:081.000000094200

```

5.17.2 Displaying PTP Clock Properties

To display PTP clock properties, use the [Displaying PTP Clock Properties](#) command.

```

switch#show local-clock time-properties
Current UTC offset valid: False
Current UTC offset: 0
Leap 59: False
Leap 61: False
Time Traceable: False
Frequency Traceable: False
PTP Timescale: False
Time Source: 0x0
switch#

```

5.17.3 Displaying PTP Foreign Master

To display information about foreign masters (PTP sources not designated as the switch's master from which the switch has received sync packets), use the [show ptp foreign-master-record](#) command.

```

switch#show ptp foreign-master-record
No Foreign Master Records
switch#

```

5.17.4 Displaying PTP Information for all Interfaces

To display PTP information for specified interfaces, use the [show ptp interface](#) command.

```

switch#show ptp interface
Interface Ethernet1
PTP: Disabled
Port state: Disabled
Sync interval: 1.0 seconds
Announce interval: 2.0 seconds
Announce interval timeout multiplier: 3
Delay mechanism: end to end
Delay request message interval: 32.0 seconds
Transport mode: ipv4

```

```
Interface Ethernet5
PTP: Disabled
Port state: Disabled
Sync interval: 8.0 seconds
Announce interval: 2.0 seconds
Announce interval timeout multiplier: 5
Delay mechanism: peer to peer
Peer delay request message interval: 8.0 seconds
Peer Mean Path Delay: 0
Transport mode: ipv4

switch#
```

5.17.5 Displaying PTP Interface Counters

To display PTP interface counters for specified interfaces, use the `show ptp interface counters` command.

```
switch#show ptp interface ethernet 5 counters
Interface Ethernet5
Announce messages sent: 0
Announce messages received: 0
Sync messages sent: 0
Sync messages received: 0
Follow up messages sent: 0
Follow up messages received: 0
Delay request messages sent: 0
Delay request messages received: 0
Delay response messages sent: 0
Delay response messages received: 0
Peer delay request messages sent: 0
Peer delay request messages received: 0
Peer delay response messages sent: 0
Peer delay response messages received: 0
Peer delay response follow up messages sent: 0
Peer delay response follow up messages received: 0
switch#
```

5.17.6 Displaying PTP Local Clock and Offset

To display the local PTP clock and offset, use the `show ptp local-clock` command.

```
switch#show ptp local-clock
PTP Mode: Boundary Clock
Clock Identity: 0x00:1c:73:ff:ff:1e:83:24
Clock Domain: 1
Number of PTP ports: 24
Priority1: 128
Priority2: 128
Clock Quality:
  Class: 248
  Accuracy: 0x30
  OffsetScaledLogVariance: 0xffff
Offset From Master: 0
Mean Path Delay: 0
Steps Removed: 0
switch#
```

5.17.7 Displaying PTP Masters Information

To display the PTP clocks master and grandmaster identity and configuration, use the `show ptp masters` command.

```
switch#show ptp masters
Parent Clock:
Parent Clock Identity: 0x00:1c:73:ff:ff:00:72:40
Parent Port Number: 0
Parent IP Address: N/A
Observed Parent Offset (log variance): N/A
Observed Parent Clock Phase Change Rate: N/A

Grandmaster Clock:
Grandmaster Clock Identity: 0x00:1c:73:ff:ff:00:72:40
Grandmaster Clock Quality:
  Class: 248
  Accuracy: 0x30
  OffsetScaledLogVariance: 0xffff
  Priority1: 128
  Priority2: 128
switch#
```

5.17.8 Displaying PTP Monitoring Information

To display the list of up to 100 recorded entries of offset from master, mean path delay and skew values, the current PTP mode, whether or not the feature is enabled, the number of entries displayed, and the configured thresholds for each metric, use the `show ptp monitor` command. Entries are sorted by the system time at which the value was calculated, starting with the most recent data at the top.

```
Switch#show ptp monitor
PTP Mode: Boundary Clock
Ptp monitoring: enabled
Number of entries: 5
Offset from master threshold: 1500
Mean path delay threshold: not configured
Skew threshold: 0.5
Interface Time                               Offset from Master (ns)  Mean Path Delay (ns)  Skew
-----
Et8      21:23:12.901 UTC Feb 22 2018  71                    5849
 1.003159918
Et1      21:23:12.901 UTC Feb 22 2018  113                   3672
 1.004990621
Et2      21:23:12.901 UTC Feb 22 2018  706                   7799
 1.002744199
Et1      21:23:12.901 UTC Feb 22 2018  803                   5861
 1.003432049
Et1      21:23:12.901 UTC Feb 22 2018  610                   3415
 0.998974658
```

5.17.9 Displaying PTP Source IP

To display PTP IP source information, use the `show ptp source ip` command.

```
switch#show ptp source ip
PTP source IP: 10.0.2.1
```

```
switch#
```

5.18 Precision Time Protocol (PTP) Commands

PTP Commands

- `ptp announce interval`
- `ptp announce timeout`
- `ptp delay-mechanism`
- `ptp delay-req interval`
- `ptp domain`
- `ptp enable`
- `ptp forward-v1`
- `ptp hold-ptp-time`
- `ptp mode`
- `ptp monitor`
- `ptp monitor threshold mean-path-delay`
- `ptp monitor threshold offset-from-master`
- `ptp monitor threshold skew`
- `ptp pdelay-neighbor-threshold`
- `ptp pdelay-req interval`
- `ptp priority1`
- `ptp priority2`
- `ptp role`
- `ptp source ip`
- `ptp sync timeout`
- `ptp sync-message interval`
- `ptp transport`
- `ptp ttl`

PTP Show Commands

- `show ptp foreign-master-record`
- `show ptp interface`
- `show ptp interface counters`
- `show ptp local-clock`
- `show ptp masters`
- `show ptp monitor`
- `show ptp source ip`
- `show ptp`

5.18.1 ptp announce interval

The `ptp announce interval` command configures the interval at which the configuration mode interface sends PTP **announce** messages. The `no ptp announce interval` command resets the announce interval to its default of 1 (2 seconds).

Command Mode

Interface-Ethernet Configuration

Interface-Port Channel Configuration

Command Syntax

```
ptp announce interval log_interval
```

```
no ptp announce interval
```

```
default ptp announce interval
```

Parameters

- *log_interval* The number of log seconds between PTP **announce** messages (base 2 log (seconds)). Value ranges from -3 (1/8 second) to 4 (16 seconds); default value is 1 (2 seconds).

Examples

- These commands set the interval between PTP **announce** messages sent by Ethernet interface 5 to 4 seconds.

```
switch(config)#interface ethernet 5  
switch(config-if-Et5)#ptp announce interval 2  
switch(config-if-Et5)#
```

- These commands reset the PTP **announce** interval on Ethernet interface 5 to the default value of 1 (2 seconds).

```
switch(config)#interface ethernet 5  
switch(config-if-Et5)#no ptp announce interval  
switch(config-if-Et5)#
```

5.18.2 ptp announce timeout

The `ptp announce timeout` sets the timeout multiplier for the configuration-mode interface. The timeout multiplier is the number of announcement intervals that the interface will wait without receiving a PTP **announce** message before a timeout occurs; the range is from 2 to 255. The default multiplier is 3, which results in a 6-second timeout interval when the announce interval is set to the default of 2 seconds. To configure the announce interval, use the `ptp announce interval` command.

Command Mode

Interface-Ethernet Configuration

Interface-Port Channel Configuration

Command Syntax

```
ptp announce timeout multiplier
```

```
no ptp announce timeout
```

```
default ptp announce timeout
```

Parameters

- *multiplier* Number of announce intervals after which the interface will time out if it does not receive a PTP **announce** message. The range is from 2 to 255; default value is 3.

Examples

- This command sets the timeout multiplier for Ethernet interface 5 to 5. This means that the interface will time out if it doesn't receive a PTP **announce** message within five announce intervals.

```
switch(config)#interface ethernet 5  
switch(config-if-Et5)#ptp announce timeout 5  
switch(config-if-Et5)#
```

- These commands reset the PTP timeout interval on interface Ethernet 5 to the default value of 3.

```
switch(config)#interface ethernet 5  
switch(config-if-Et5)#no ptp announce timeout  
switch(config-if-Et5)#
```

5.18.3 ptp delay-mechanism

The `ptp delay-mechanism` command configures the delay mechanism in boundary clock mode. The `no ptp delay-mechanism` command disables the feature.

Command Mode

Interface-Ethernet Configuration

Interface-Port Channel Configuration

Command Syntax

```
ptp delay-mechanism mech_type
```

```
no ptp delay-mechanism
```

```
default ptp delay-mechanism
```

Parameters

- *mech_type* The delay mechanism. Options include:
 - **e2e** end-to-end delay mechanism
 - **p2p** peer-to-peer mechanism

Examples

- This command sets the delay mechanism to peer-to-peer in the boundary clock mode.

```
switch(config)#interface ethernet 5  
switch(config-if-Et5)#ptp delay-mechanism p2p  
switch(config-if-Et5)#
```

- This command sets the delay mechanism to end-to-end in the boundary clock mode.

```
switch(config)#interface ethernet 5  
switch(config-if-Et5)#ptp delay-mechanism e2e  
switch(config-if-Et5)#
```

- This command removes the delay mechanism configuration from Ethernet 5.

```
switch(config)#interface ethernet 5  
switch(config-if-Et5)#no ptp delay-mechanism e2e  
switch(config-if-Et5)#
```

5.18.4 ptp delay-req interval

The **ptp delay-req interval** command specifies the time in log seconds recommended to the slave devices to send delay request messages. You must enable PTP on the switch first and configure the source IP address for PTP communication. The **no ptp delay-req interval** command resets the interval to its default of 5 (32 seconds).

Command Mode

Interface-Ethernet Configuration

Interface-Port Channel Configuration

Command Syntax

```
ptp delay-req interval log_interval
```

```
no ptp delay-req interval
```

```
default ptp delay-req interval
```

Parameters

- *log_interval* The range is -1 to 8 log seconds (base 2 log (seconds)). The default is 5 (32 seconds).

Examples

- These commands set the minimum interval allowed between PTP delay request messages on Ethernet interface 5 to 3 (8 seconds).

```
switch(config)#interface ethernet 5  
switch(config-if-Et5)# ptp delay-request interval 3  
switch(config-if-Et5)#
```

- These commands reset the minimum interval allowed between PTP delay-request messages to the default of 5 (32 seconds).

```
switch(config)#interface ethernet 5  
switch(config-if-Et5)#no ptp delay-request interval  
switch(config-if-Et5)#
```

5.18.5 ptp domain

The `ptp domain` command sets the domain number to use for the clock. The `no ptp domain` command disables the feature.

Command Mode

Global Configuration

Command Syntax

```
ptp domain domain_number
```

```
no ptp domain
```

```
default ptp domain
```

Parameters

- *domain_number* Value ranges from 0 to 255.

Examples

- This command shows how to configure domain 1 for use with a clock.

```
switch(config)#ptp domain 1  
switch(config)#
```

- This command removes the configured domain 1 for use with a clock.

```
switch(config)#no ptp domain 1  
switch(config)#
```

5.18.6 ptp enable

The `ptp enable` command enables PTP on the interface. The `no ptp enable` command disables PTP on the interface.

Command Mode

Interface-Ethernet Configuration

Interface-Port Channel Configuration

Command Syntax

`ptp enable`

`no ptp enable`

`default ptp enable`

Examples:

- This command enables PTP on Ethernet interface 5.

```
switch(config)#interface ethernet 5
switch(config-if-Et5)#ptp enable
```

- This command disables PTP on Ethernet interface 5.

```
switch(config)#interface ethernet 5
switch(config-if-Et5)#no ptp enable
```

5.18.7 ptp forward-v1

The `ptp forward-v1` command configures the switch to forward Precision Time Protocol version packets as regular multicast traffic. By default, PTP v1 packets are trapped by the CPU, logged and discarded.

The `no ptp forward-v1` and `default ptp forward-v1` commands restore the default forwarding behavior by removing the corresponding `ptp forward-v1` command from *running-config*.

Command Mode

Global Configuration

Command Syntax

```
ptp forward-v1
```

```
no ptp forward-v1
```

```
default ptp forward-v1
```

Examples

- This command configures the switch to forward PTP v1 packets as regular multicast traffic.

```
switch(config)#ptp forward-v1
switch(config)#
```

- This command configures the switch to log and discard PTP v1 packets.

```
switch(config)#no ptp forward-v1
switch(config)#
```

5.18.8 ptp hold-ptp-time

The `ptp hold-ptp-time` command configures the PTP offset hold time in seconds. The `no ptp hold-ptp-time` command disables the feature.

Command Mode

Global Configuration

Command Syntax

```
ptp hold-ptp-time offset
```

```
no ptp hold-ptp-time
```

```
default ptp hold-ptp-time
```

Parameters

- *offset* Value ranges from 0 to 86400.

Examples

- This command shows how to configure the PTP offset hold time.

```
switch(config)#ptp hold-ptp-time 600  
switch(config)#
```

- This command removes the configured PTP offset hold time.

```
switch(config)#no ptp hold-ptp-time  
switch(config)#
```

5.18.9 ptp mode

The `ptp mode` command configures the Precision Time Protocol (PTP) packet forwarding mode for the switch. By default, PTP is disabled globally; the mode must be changed to use PTP on switch interfaces.

The `no ptp mode` and `default ptp mode` commands return the forwarding mode to **disabled** by removing the `ptp mode` command from *running-config*.

Command Mode

Global Configuration

Command Syntax

```
ptp mode mode_name
```

```
no ptp mode
```

```
default ptp mode
```

Parameters

- *mode_name* Default mode is **disabled**. Options include:
 - **boundary** The device acts as a boundary clock, and both runs and participates in the best master clock algorithm.
 - **disabled** The default mode. PTP is disabled, and the device forwards all PTP packets as normal traffic.
 - **e2transparent** The device acts as an end-to-end transparent clock, synchronizing all ports to a connected master clock and updating the time interval field of forwarded PTP packets using switch residence time.
 - **p2transparent** The device acts as a peer-to-peer transparent clock, synchronizing all ports to a connected master clock and updating the time interval field of forwarded PTP packets using switch residence time and inbound path delays.
 - **gptp** The device runs generalized Precision Time Protocol (gPTP), participating in the best master clock algorithm but also updating the interval field of forwarded PTP packets using switch residence time and inbound path delays.

Examples

- This command configures the switch to act as a PTP boundary clock.

```
switch(config)#ptp mode boundary
switch(config)#
```

- This command restores PTP to disabled mode.

```
switch(config)#no ptp mode
switch(config)#
```

5.18.10 ptp monitor threshold mean-path-delay

Mean path delay is the mean time in nanoseconds that PTP packets take to travel between PTP master and slave. The `ptp monitor threshold mean-path-delay` command configures the mean-path-delay threshold in nanoseconds. When this threshold is configured, a Syslog message is generated if the value of the most recently calculated mean path delay is greater than or equal to this value.

The `no ptp monitor threshold mean-path-delay` and `default ptp monitor threshold mean-path-delay` commands clear the threshold value and prevent further Syslog messages from being generated for this parameter.

Command Mode

Global Configuration

Command Syntax

```
ptp monitor threshold mean-path-delay threshold  
no ptp monitor threshold mean-path-delay  
default ptp monitor threshold mean-path-delay
```

Parameter

- *threshold* threshold in nanoseconds. Values range from 0 to 1000000000 (1 second).

Example

- This command sets a mean-path-delay threshold value of 2000 nanoseconds.

```
switch(config)#ptp monitor threshold mean-path-delay 2000
```

5.18.11 ptp monitor threshold offset-from-master

PTP offset is the difference in nanoseconds between master and slave time. The `ptp monitor threshold offset-from-master` command configures the offset-from-master threshold in nanoseconds. A Syslog message is generated if the most recently calculated time offset from the PTP master is outside of the range (-<threshold>, <threshold>). The maximum offset threshold is one second.

The `no ptp monitor threshold offset-from-master` and `no ptp monitor threshold offset-from-master` commands clear the threshold value and prevents further Syslog messages from being generated for this parameter.

Command Mode

Global Configuration

Command Syntax

```
ptp monitor threshold offset-from-master threshold  
no ptp monitor threshold offset-from-master  
default ptp monitor threshold offset-from-master
```

Parameter

- *threshold* Offset threshold value in nanoseconds. Values range from 0 to 1000000000.

Example

- This command sets an offset-from-master threshold value of 500 nanoseconds.

```
switch(config) #ptp monitor threshold offset-from-master 500  
switch(config) #
```

5.18.12 ptp monitor threshold skew

PTP skew is the clock frequency difference between master and slave. The `ptp monitor threshold skew` command configures the value of the skew-threshold percentage. A Syslog message is generated if the value of the most recently calculated skew is not in the range $(1/(1+threshold), 1*(1+threshold))$.

The `no ptp monitor threshold skew` and `default ptp monitor threshold skew` commands clear the threshold value and prevent further Syslog messages from being generated for this parameter.

Command Mode

Global Configuration

Command Syntax

```
ptp monitor threshold skew threshold
```

```
no ptp monitor threshold skew
```

```
default ptp monitor threshold skew
```

Parameters

- *threshold* skew percentage threshold represented as a double precision (16 digit) real number ranging from 0 (0%) to 10 (1000%).

Example

- This command sets a skew threshold value of 5 (500%).

```
switch(config)#ptp monitor threshold skew 5
switch(config)#
```

5.18.13 ptp monitor

The `ptp monitor` command enables and disables PTP monitoring on the switch. When PTP monitoring is enabled, the switch records PTP status and configuration information (which can be viewed using the `show ptp monitor` command) and generates Syslog messages for metrics whose threshold values have been configured. PTP monitoring is enabled by default.

The `no ptp monitor` command disables the PTP monitoring and clears all the recorded data from *running-config*.

Command Mode

Global Configuration

Command Syntax

```
ptp monitor
```

```
no ptp monitor
```

Related Commands

- `ptp monitor threshold mean-path-delay`
- `ptp monitor threshold offset-from-master`
- `ptp monitor threshold skew`
- `show ptp monitor`

Example

- This command disables ptp monitor PTP monitoring on the switch and clears all the recorded data.

```
switch(config)#ptp monitor
switch(config)#
```

5.18.14 ptp pdelay-neighbor-threshold

The `ptp pdelay-neighbor-threshold` command configures the propagation delay threshold above which the switch will consider the neighbor connected to this port to be incapable of participating in generalized Precision Time Protocol (gPTP).

The `no ptp pdelay-neighbor-threshold` and `default ptp pdelay-neighbor-threshold` commands restore the threshold to 100000 nanoseconds by removing the corresponding `ptp pdelay-neighbor-threshold` command from *running-config*.

Command Mode

Interface-Ethernet Configuration

Interface-Port Channel Configuration

Command Syntax

```
ptp pdelay-neighbor-threshold link_prop
```

```
no ptp pdelay-neighbor-threshold
```

```
default ptp pdelay-neighbor-threshold
```

Parameters

- *link_prop* Threshold in nanoseconds. Value ranges from 0 to 10000000000 (ten billion). Default is 100000.

Examples

- These commands set the link propagation delay threshold on Ethernet interface 5 to 200000 nanoseconds.

```
switch(config)#interface ethernet 5
switch(config-if-Et5)#ptp pdelay-neighbor-threshold 200000
switch(config-if-Et5)#
```

- These commands restore the link propagation delay threshold on Ethernet interface 5 to its default value of 100000 nanoseconds.

```
switch(config)#interface ethernet 5
switch(config-if-Et5)# no ptp pdelay-neighbor-threshold
switch(config-if-Et5)#
```

5.18.15 ptp pdelay-req interval

The `ptp pdelay-req interval` command configures the interval between Precision Time Protocol peer delay-request messages. The `no ptp pdelay-req interval` command removes the configuration.

Command Mode

Interface-Ethernet Configuration

Interface-Port Channel Configuration

Command Syntax

```
ptp pdelay-req interval log_interval
```

```
no ptp pdelay-req interval
```

```
default ptp pdelay-req interval
```

Parameters

- *log_interval* The log interval in seconds (base 2 log (seconds)). Value ranges from 0 to 5.

Examples

- This command shows how to configure the interval allowed between PTP peer delay request messages on interface Ethernet 5.

```
switch(config)#interface ethernet 5  
switch(config-if-Et5)# ptp pdelay-request interval 3  
switch(config-if-Et5)#
```

- This command removes the configure the interval allowed between PTP peer delay request messages on interface Ethernet 5.

```
switch(config)#interface ethernet 5  
switch(config-if-Et5)#no ptp pdelay-request interval  
switch(config-if-Et5)#
```

5.18.16 ptp priority1

The `ptp priority1` command configures the priority 1 value for advertising the switches PTP clock. Priority 1 is the most significant of the six factors used by devices in the selection of a master clock. Lower values indicate higher priority.

The `no ptp priority1` and `default ptp priority1` commands restore the priority 1 default setting of 128.

Command Mode

Global Configuration

Command Syntax

```
ptp priority1 priority_rate
```

```
no ptp priority1
```

```
default ptp priority1
```

Parameters

- *priority_rate* Value ranges from 0 to 255. Default is 128.

Examples

- This command sets the priority 1 level for the switches PTP clock to 120.

```
switch(config)#ptp priority1 120
switch(config)#
```

- This command restores the default priority 1 level of 128.

```
switch(config)#no ptp priority1
switch(config)#
```

5.18.17 ptp priority2

The `ptp priority2` command sets the priority 2 value for the clock. The range is from 0 to 255. Priority 2 is the fifth most significant of the six factors used by devices in the selection of a master clock. Lower values indicate higher priority.

The `no ptp priority2` and `default ptp priority2` commands restore the priority 2 default setting of 128.

Command Mode

Global Configuration

Command Syntax

```
ptp priority2 priority_rate
```

```
no ptp priority2
```

```
default ptp priority2
```

Parameters

- *priority_rate* Specifies the priority 2 level for the PTP clock. Value ranges from 0 to 255; default value is 128.

Examples

- This command sets the priority 2 level for the switches PTP clock to 120.

```
switch(config)#ptp priority2 120
switch(config)#
```

- This command restores the default priority 2 level of 128.

```
switch(config)#no ptp priority2
switch(config)#
```

5.18.18 ptp role

The `ptp role` command configures a port to operate either in the master mode or the dynamic mode when it is executed in the interface configuration mode.

The `no ptp role` command removes the master or dynamic mode if it was previously configured on an interface.

Command Mode

Interface-Ethernet Configuration

Command Syntax

```
ptp role [dynamic | master]
```

```
no ptp role
```

```
default ptp role
```

Related Commands

- [ptp enable](#)
- [ptp enable](#)
- [show ptp interface](#)

Parameters

- `dynamic` the dynamic mode.
- `master` the master clock mode that has the most precise time.

Examples

- This command configures a port to operate in the master mode for Ethernet interface 1.

```
switch(config)#interface ethernet 1  
switch(config-if-Et1)#ptp role master
```

- This command configures a port to operate in the dynamic mode for Ethernet interface 1.

```
switch(config)#interface ethernet 1  
switch(config-if-Et1)#ptp role dynamic
```

5.18.19 ptp source ip

The `ptp source ip` command configures the source IP address for all PTP packets. The IP address can be in IPv4 format. The `no ptp source ip` command removes this configuration.

Command Mode

Global Configuration

Command Syntax

```
ptp source ip ipv4_addr
```

```
no ptp source ip
```

```
default ptp source ip
```

Parameters

- *ipv4_addr* IPv4 address

Examples

- This command configures the source IP address **10.0.2.1** for all PTP packets.

```
switch(config)#ptp source ip 10.0.2.1  
switch(config)#
```

- This command removes the source IP address **10.0.2.1** for all PTP packets.

```
switch(config)#no ptp source ip  
switch(config)#
```

5.18.20 ptp sync timeout

A PTP synchronization timeout occurs if a sync message is not received for a specified period of time, calculated as a multiple of the PTP sync-message interval. The `ptp sync timeout` command configures the sync timeout multiplier. The range is 2 to 255, with a default of 20 (20 times the sync interval). To configure the sync interval, use the `ptp sync-message interval` command.

The `no ptp sync timeout` and `default ptp sync timeout` commands restore the PTP sync timeout multiplier to its default value of 20.

Command Mode

Interface-Ethernet Configuration

Command Syntax

```
ptp sync timeout interval_multiplier
```

```
no ptp sync timeout
```

```
default ptp sync timeout
```

Parameters

- *interval_multiplier* The number of sync intervals that must pass without the configuration mode interface receiving a PTP sync message before a timeout occurs. Value ranges from 2 to 255. Default value is 20.

Example

- These commands configure the sync timeout on Ethernet interface 5 to ten times the configured sync interval.

```
switch(config)#interface ethernet 5
switch(config-if-Et5)#ptp sync timeout 10
switch(config-if-Et5)#
```

5.18.21 ptp sync-message interval

The `ptp sync-message interval` command configures the time for sending synchronization messages by specifying its log2 value. Default values and ranges depend on the PTP mode, which is set using the `ptp mode` command.

The `no ptp sync-message interval` and `default ptp sync-message interval` commands restore the sync interval to its default (1 second in **boundary** mode, 1/8 second in **gptp** mode) by removing the corresponding `ptp sync-message interval` command from *running-config*.

Command Mode

Interface-Ethernet Configuration

Interface-Port Channel Configuration

Command Syntax

```
ptp sync-message interval log_interval
```

```
no ptp sync-message interval
```

```
default ptp sync-message interval
```

Parameters

- *log_interval* The interval between PTP synchronization messages sent from the master to the slave (base 2 log(seconds)). Values vary according to PTP mode: in **boundary** mode, the range is from -7 (1/128 second) to 3 (8 seconds) and the default value is 0 (1 second). In **gptp** mode, the range is from -3 (1/8 second) to 17 (131072 seconds, approximately 36 hours) with a default of -3.

Examples

- These commands set the interval for PTP synchronization messages on Ethernet interface 5 to 3 (8 seconds).

```
switch(config)#interface ethernet 5
switch(config-if-Et5)#ptp sync-message interval 3
switch(config-if-Et5)#
```

- In **boundary** mode, these commands restore the interval for PTP synchronization messages on Ethernet interface 5 to its default of 0 (1 second).

```
switch(config)#interface ethernet 5
switch(config-if-Et5)#no ptp sync-message interval
switch(config-if-Et5)#
```

5.18.22 ptp transport

The **ptp transport** command configures the PTP transport type for a specific interface. Any values set in interface PTP configuration mode override the settings in the PTP configuration profile associated with the interface. The **no ptp transport** command removes the setting from the *running-config*.

Command Mode

Interface-Ethernet Configuration

Interface-Port Channel Configuration

Command Syntax

```
ptp transport TRANSPORT_TYPE
```

```
no ptp transport
```

```
default ptp transport
```

Parameters

- **TRANSPORT_TYPE** The transport mode in boundary clock mode. Options include:
 - **ipv4** The IPv4 address used as the transport type on the interface.
 - **layer2** The Layer 2 protocol used as the transport type on the interface.

Examples

- This command overrides the transport type in the profile and sets it to be IPv4 for the interface.

```
switch(config)#interface ethernet 5  
switch(config-if-Et5)#ptp transport ipv4  
switch(config-if-Et5)#
```

- This command removes the interval for PTP synchronization messages on interface Ethernet 5.

```
switch(config)#interface ethernet 5  
switch(config-if-Et5)#no ptp transport  
switch(config-if-Et5)#
```

5.18.23 ptp ttl

The `ptp ttl` command configures the Time To Live (TTL) value of the PTP packets. The `no ptp ttl` resets the TTL value to the default value of 1 hop by removing the `ptp ttl` command from the *running-config*.

Command Mode

Global Configuration

Command Syntax

```
ptp ttl hop_count
```

```
no ptp ttl
```

```
default ptp ttl
```

Parameters

- *hop_count* The TTL value measured in hops. Value ranges from 1 to 255, default is 1.

Example

- This command sets the time to live of the PTP packets to 60 hops.

```
switch(config)#ptp ttl 60  
switch(config)#
```

- This command resets the time to live of the PTP packets to the default value of 1 hop.

```
switch(config)#no ptp ttl  
switch(config)#
```

5.18.24 show ptp foreign-master-record

The `show ptp foreign-master-record` command displays information about foreign masters (PTP sources not designated as the switch's master from which the switch has received sync packets).

Command Mode

EXEC

Command Syntax

```
show ptp foreign-master-record
```

Examples

- This command displays information about PTP foreign masters.

```
switch#show ptp foreign-master-record
No Foreign Master Records
switch#
```

5.18.25 show ptp interface counters

The `show ptp interface counters` command displays PTP interface counters for all interfaces.

Command Mode

EXEC

Command Syntax

```
show ptp [INTERFACE_NAME] counters
```

Parameters

- `INTERFACE_NAME` Interface type and numbers. Options include:
 - `<no parameter>` Display information for all interfaces.
 - **ethernet** `e_range` Ethernet interface range specified by `e_range`.
 - **loopback** `l_range` Loopback interface specified by `l_range`.
 - **management** `m_range` Management interface range specified by `m_range`.
 - **port-channel** `p_range` Port-Channel Interface range specified by `p_range`.
 - **vlan** `v_range` VLAN interface range specified by `v_range`.
 - **vxlan** `vx_range` VXLAN interface range specified by `vx_range`.

Valid range formats include number, number range, or comma-delimited list of numbers and ranges.

Examples

- This command displays the PTP interface counters.

```
switch#show ptp interface ethernet 5 counters
Interface Ethernet5
Announce messages sent: 0
Announce messages received: 0
Sync messages sent: 0
Sync messages received: 0
Follow up messages sent: 0
Follow up messages received: 0
Delay request messages sent: 0
Delay request messages received: 0
Delay response messages sent: 0
Delay response messages received: 0
Peer delay request messages sent: 0
Peer delay request messages received: 0
Peer delay response messages sent: 0
Peer delay response messages received: 0
Peer delay response follow up messages sent: 0
Peer delay response follow up messages received: 0
switch#
```

5.18.26 show ptp interface

The `show ptp interface` command displays PTP information for all the interfaces on the device.

Command Mode

EXEC

Command Syntax

```
show ptp [INTERFACE_NAME][STATUS_FILTER]
```

Parameters

- **INTERFACE_NAME** Interface type and numbers. Options include:
 - `<no parameter>` Display information for all interfaces.
 - **ethernet** *e_range* Ethernet interface range specified by *e_range*.
 - **loopback** *l_range* Loopback interface specified by *l_range*.
 - **management** *m_range* Management interface range specified by *m_range*.
 - **port-channel** *p_range* Port-Channel Interface range specified by *p_range*.
 - **vlan** *v_range* VLAN interface range specified by *v_range*.

Valid range formats include number, number range, or comma-delimited list of numbers and ranges.

- **STATUS_FILTER** Filters interfaces by their configuration status. Options include:
 - `<no parameter>` all interfaces.
 - **enabled** PTP configured interfaces.

Examples

This command displays PTP information for all the interfaces on the device.

```
switch#show ptp interface
Interface Ethernet1
PTP: Disabled
Port state: Disabled
Sync interval: 1.0 seconds
Announce interval: 2.0 seconds
Announce interval timeout multiplier: 3
Delay mechanism: end to end
Delay request message interval: 32.0 seconds
Transport mode: ipv4

Interface Ethernet5
PTP: Disabled
Port state: Disabled
Sync interval: 8.0 seconds
Announce interval: 2.0 seconds
Announce interval timeout multiplier: 5
Delay mechanism: peer to peer
Peer delay request message interval: 8.0 seconds
Peer Mean Path Delay: 0
Transport mode: ipv4

switch#
```

5.18.27 show ptp local-clock

The `show ptp local-clock` command displays the Precision Time Protocol (PTP) clock information.

Command Mode

EXEC

Command Syntax

`show ptp local-clock`

Example

- This command shows how to display the PTP local clock and offset.

```
switch#show ptp local-clock
PTP Mode: Boundary Clock
Clock Identity: 0x00:1c:73:ff:ff:1e:83:24
Clock Domain: 1
Number of PTP ports: 24
Priority1: 128
Priority2: 128
Clock Quality:
  Class: 248
  Accuracy: 0x30
  OffsetScaledLogVariance: 0xffff
Offset From Master: 0
Mean Path Delay: 0
Steps Removed: 0
switch#
```

5.18.28 show ptp masters

The `show ptp masters` command displays information about the switchs PTP master and grand master clocks.

Command Mode

Privileged EXEC

Command Syntax

```
show ptp masters
```

Examples

- This command displays information about the switchs PTP master and grand master clocks.

```
switch#show ptp masters
Parent Clock:
Parent Clock Identity: 0x00:1c:73:ff:ff:00:72:40
Parent Port Number: 0
Parent IP Address: N/A
Observed Parent Offset (log variance): N/A
Observed Parent Clock Phase Change Rate: N/A

Grandmaster Clock:
Grandmaster Clock Identity: 0x00:1c:73:ff:ff:00:72:40
Grandmaster Clock Quality:
  Class: 248
  Accuracy: 0x30
  OffsetScaledLogVariance: 0xffff
  Priority1: 128
  Priority2: 128
switch#
```

5.18.29 show ptp monitor

The `show ptp monitor` command displays the list of up to 100 recorded entries of offset from master, mean path delay and skew values, along with current PTP mode, whether or not the feature is enabled, number of entries displayed and the configured thresholds for each metric. Entries are sorted by the system time at which the value was calculated, starting with the most recent data at the top.

Command Mode

EXEC

Command Syntax

`show ptp monitor`

Example

- This command displays the information recorded by PTP monitoring.

```
Switch#show ptp monitor
PTP Mode: Boundary Clock
Ptp monitoring: enabled
Number of entries: 5
Offset from master threshold: 1500
Mean path delay threshold: not configured
Skew threshold: 0.5
InterfaceTimeOffset fromMean PathSkew
Master (ns)Delay (ns)
-----
Et821:23:12.901 UTC Feb 22 20187158491.003159918
Et121:23:12.901 UTC Feb 22 201811336721.004990621
Et221:23:12.901 UTC Feb 22 201870677991.002744199
Et121:23:12.901 UTC Feb 22 201880358611.003432049
Et121:23:12.901 UTC Feb 22 201861034150.998974658
```

5.18.30 show ptp source ip

The `show ptp source ip` command displays the PTP source IP for the device.

Command Mode

Privileged EXEC

Command Syntax

```
show ptp source ip
```

Examples

- This command shows the PTP source IP to be 10.0.2.1.

```
switch#show ptp source ip
PTP source IP: 10.0.2.1
switch#
```

5.18.31 show ptp

The `show ptp` command displays summary Precision Time Protocol (PTP) information and PTP status of switch ports.

Command Mode

EXEC

Command Syntax

```
show ptp
```

Example

- This command displays summary PTP information.

```
switch#show ptp
PTP Mode: gptp - Generalized PTP Clock
Clock Identity: 2001:0DB8:73:ff:ff:26:fd:90
Grandmaster Clock Identity: 2001:0DB8:96:ff:fe:6c:ed:02
Number of slave ports: 1
Number of master ports: 6
Slave port: Ethernet33
Mean Path Delay (nanoseconds): 718
Steps Removed: 1
Neighbor Rate Ratio: 1.00000007883
Rate Ratio: 1.00000007883
Interface StateASTime Since LastNeighborMean PathResidence
Capable Changed Rate Ratio Delay (ns) Time (ms)
-----
Et1 Disabled No Never 1.0 00
Et2 Disabled No Never 1.0 00
Et3 Disabled No Never 1.0 00
Et4 Disabled No Never 1.0 00
Et5 Disabled No Never 1.0 00
Et6 Disabled No Never 1.0 00
Et7 Master Yes 0:21:08 1.000000094200
```

Switch Environment Control

The following sections describe the commands that display temperature, fan, and power supply status:

- [Environment Control Introduction](#)
- [Environment Control Overview](#)
- [Configuring and Viewing Environment Settings](#)
- [Environment Commands](#)

The switch chassis, fans, power supplies, line cards, and supervisors also provide LEDs that signal status and conditions that require attention. The Quick Start Guide for the individual switches provides information about their LEDs.

6.1 Environment Control Introduction

Arista Networks switching platforms are designed to work reliably in common data center environments.

To ensure their reliable operation and to monitor or diagnose the switch's health, Arista provides a set of monitoring capabilities available through the CLI or SNMP entity MIBs to monitor and diagnose potential problems with the switching platform.

6.2 Environment Control Overview

This section contains the following topics:

- [Temperature](#)
- [Fans](#)
- [Power](#)

6.2.1 Temperature

Arista switches include internal temperature sensors. The number and location of the sensors vary with each switch model. Each sensor is assigned temperature thresholds that denote alert and critical conditions. Temperatures that exceed the threshold trigger the following:

- **Alert Threshold:** All fans run at maximum speed and a warning message is logged.
- **Critical Threshold:** The component is shut down immediately and its Status LED flashes orange.

In modular systems, cards are shut down when their temperatures exceed the critical threshold. The switch is shut down if the temperature remains above the critical threshold for three minutes.

6.2.2 Fans

Arista switches include fan modules that maintain internal components at proper operating temperatures. The number and type of fans vary with switch chassis type:

- **Fixed configuration switches** contain hot-swappable independent fans. Fan models with different airflow directions are available. All fans within a switch must have the same airflow direction.
- **Modular switches** contain independent fans that circulate air from front-to-rear panel. Power supplies for modular switches also include fans that cool the power supply and supervisors.

The switch operates normally when one fan is not operating. Non-functioning modules should not be removed from the switch unless they are immediately replaced; adequate switch cooling requires the installation of all components, including a non-functional fan.

Two non-operational fans trigger an **insufficient fan shutdown** condition. Under normal operations, this condition initiates a switch power down procedure.

Fans are accessible from the rear panel.

6.2.3 Power

Arista switches contain power supplies which provide power to internal components.

- **Fixed configuration switches** contain two power supplies, providing 1+1 redundancy.
- **Modular switches** contain four power supplies, providing a minimum of 2+2 redundancy.

Power supply LED indicators are visible from the rear panel.

6.3 Configuring and Viewing Environment Settings

This section contain the following topics:

- [Overriding Automatic Shutdown](#)
- [Viewing Environment Status](#)
- [Locating Components on the Switch](#)

6.3.1 Overriding Automatic Shutdown

This section contains the following topics:

- [Overheating](#)
- [Insufficient Fans](#)
- [Fan Speed](#)

6.3.1.1 Overheating

The switch can be configured to continue operating during temperature shutdown conditions. Ignoring a temperature shutdown condition is strongly discouraged because operating at high temperatures can damage the switch and void the warranty.

Temperature shutdown condition actions are specified by the [environment overheat action](#) command. The switch displays this warning when configured to ignore shutdown temperature conditions.

```
Switch(config)#environment overheat action ignore
=====
WARNING: Overriding the system shutdown behavior when the system
is overheating is unsupported and should only be done under
the direction of an Arista Networks engineer. You risk damaging
hardware by not shutting down the system in this situation, and doing
so without direction from Arista Networks can be grounds for voiding
your warranty. To re-enable the shutdown-on-overheat behavior, use
the 'environment overheat action shutdown' command.
=====
Switch(config)#
```

The **running-config** contains the **environment overheat action** command when it is set to **ignore**. When the command is not in **running-config**, the switch shuts down when an overheating condition exists.

The following *running-config* file lists the `environment overhear action` command.

```
switch#show running-config
! Command: show running-config
! device: switch (DCS-7150S-64-CL, EOS-4.13.2F)

ip route 0.0.0.0/0 10.255.255.1
!
environment overhear action ignore
!
!
end
switch#
```

6.3.1.2 Insufficient Fans

The switch can be configured to ignore the *insufficient fan shutdown* condition. This is strongly discouraged because continued operation without sufficient cooling may lead to a critical temperature condition that can damage the switch and void the warranty.

Insufficient-fans shutdown override is configured by the `environment insufficient-fans action` command. The switch displays this warning when configured to ignore insufficient-fan conditions.

```
switch(config)#environment insufficient-fans action ignore
=====
WARNING: Overriding the system shutdown behavior when the system
has insufficient fans inserted is unsupported and should only be done
under
the direction of an Arista Networks engineer. You risk damaging
hardware by not shutting down the system in this situation, and doing
so without direction from Arista Networks can be grounds for voiding
your warranty. To re-enable the shutdown-on-overheat behavior, use
the 'environment insufficient-fans action shutdown' command.
=====
switch(config)#
```

The *running-config* contains the `environment insufficient-fans action` command when it is set to *ignore*. When *running-config* does not contain this command, the switch shuts down when it detects an insufficient-fans condition.

6.3.1.3 Fan Speed

The switch can be configured to override the automatic fan speed. The switch normally controls the fan speed to maintain optimal operating temperatures. The fans can be configured to operate at a constant speed regardless of the switch temperature conditions.

Fan speed override is configured by the `environment fan-speed` command. The switch displays this warning when its control of fan speed is overridden.

```
switch(config)#environment fan-speed override 50
=====
WARNING: Overriding the system fan speed is unsupported and should only
be done under the direction of an Arista Networks engineer.
You can risk damaging hardware by setting the fan speed too low
and doing so without direction from Arista Networks can be grounds
for voiding your warranty.
To set the fan speed back to automatic mode, use the
'environment fan-speed auto' command
=====
switch(config)#
```

The *running-config* contains the `environment fan-speed override` command if it is set to override. When *running-config* does not contain this command, the switch controls the fan speed.

6.3.2 Viewing Environment Status

This section contains the following topics:

- [Power Status](#)
- [Temperature Status](#)
- [Fan Status](#)
- [System Status](#)

6.3.2.1 Power Status

The `show environment power` command displays the status of the power supplies.

Example

This command displays the status of the power supplies.

```
switch>show environment power
Power Input Output Output
Supply Model Capacity Current Current Power Status
-----
1 PWR-650AC 650W 0.44A 10.50A 124.0W Ok
Switch>
```

6.3.2.2 Temperature Status

To display internal temperature sensor status, enter `show environment temperature`.

```
switch>show environment temperature
System temperature status is: Ok

Sensor Description Temperature Alert Critical
-----
1 Front-panel temp sensor 22.000C 65C 75C
2 Fan controller 1 sensor 23.000C 75C 85C
3 Fan controller 2 sensor 28.000C 75C 85C
4 Switch chip 1 sensor 40.000C 105C 115C
5 VRM 1 temp sensor 48.000C 105C 110C
switch>
```

System temperature status is the first line that the command displays. **System temperature status** values indicate the following:

- **Ok:** All sensors report temperatures below the alert threshold.
- **Overheating:** At least one sensor reports a temperature above its alert threshold.
- **Critical:** At least one sensor reports a temperature above its critical threshold.
- **Unknown:** The switch is initializing.
- **Sensor Failed:** At least one sensor is not functioning.

6.3.2.3 Fan Status

The `show system environment cooling` command displays the cooling and fan status.

Example

This command displays the fan and cooling status:

```
switch>show system environment cooling
System cooling status is: Ok
Ambient temperature: 22C
Airflow: port-side-intake
Fan Tray  Status          Speed
-----
1 Ok 35%
2 Ok 35%
3 Ok 35%
4 Ok 35%
5 Ok 35%
switch>
```

6.3.2.4 System Status

The `show system environment all` command lists the temperature, cooling, fan, and power supply information that the individual show environment commands display, as described in [Temperature Status](#), [Fans](#), and [Power](#).

Example:

This command displays the temperature, cooling, fan, and power supply status:

```
switch>show system environment all
System temperature status is: Ok

Sensor  Description          Temperature  Alert   Critical
Threshold                                     Threshold
-----
1      Front-panel temp sensor  22.750C    65C    75C
2      Fan controller 1 sensor  24.000C    75C    85C
3      Fan controller 2 sensor  29.000C    75C    85C
4      Switch chip 1 sensor    41.000C    105C   115C
5      VRM 1 temp sensor       49.000C    105C   110C

System cooling status is: Ok
Ambient temperature: 22C
Airflow: port-side-intake
Fan Tray  Status          Speed
-----
1      Ok 35%
2      Ok 35%
3      Ok 35%
4      Ok 35%
5      Ok 35%

Power
Supply  Model          Capacity  Input   Output  Output
                                     Current Current Power   Status
-----
1      PWR-650AC     650W     0.44A  10.50A  124.0W  Ok
```

6.3.3 Locating Components on the Switch

When a component requires service, the switch administrator may use the `locator-led` command to assist a technician in finding the component. The command causes the status LED on the specified

component to flash, and also displays a “service requested” message on the LCD panel of modular switches or lights the blue locator light on the front of fixed switches. Use the [show locator-led](#) command to display all locator LEDs currently enabled on the switch.

- This command enables the locator LED on fan tray 3:

```
switch#locator-led fantray 3  
Enabling locator led for FanTray3  
switch#
```

- This command displays all locator LEDs enabled on the switch:

```
switch#show locator-led  
There are no locator LED enabled  
switch#
```

6.4 Environment Commands

Environment Control Configuration Commands

- `environment fan-speed`
- `environment insufficient-fans action`
- `environment overheat action`
- `locator-led`

Environment Display Commands

- `show environment power`
- `show environment temperature`
- `show locator-led`
- `show system environment all`
- `show system environment cooling`
- `show system environment power budget`

6.4.1 environment fan-speed

The **environment fan-speed** command determines the method of controlling the speed of the switch fans. The switch automatically controls the fan speed by default.

The switch normally controls the fan speed to maintain optimal operating temperatures. The fans can be configured to operate at a constant speed regardless of the switch temperature conditions.

The **no environment fan-speed** and **default environment fan-speed** commands restore the default action of automatic fan-speed control by removing the **environment fan-speed override** statement from *running-config*.



Note:

Overriding the system fan speed is unsupported and should only be done under the direction of an Arista Networks engineer. You can risk damaging hardware by setting the fan speed too low. Doing so without direction from Arista Networks can be grounds for voiding your warranty.

Command Mode

Global Configuration

Command Syntax

```
environment fan-speed ACTION
```

```
no environment fan-speed
```

```
default environment fan-speed
```

Parameters

- ACTION Fan speed control method. Valid settings include:
 - **auto** Fan speed is controlled by the switch.

This option restores the default setting by removing the **environment fan-speed override** command from *running-config*.

- **override percent** Fan speed is set to the specified percentage of the maximum. Valid *percent* settings range from 30 to 100.

Examples:

- This command overrides the automatic fan speed control and configures the fans to operate at 50% of maximum speed.

```
switch(config)#environment fan-speed override 50
=====
WARNING: Overriding the system fan speed is unsupported and
should only
be done under the direction of an Arista Networks engineer.
You can risk damaging hardware by setting the fan speed too
low
and doing so without direction from Arista Networks can be
grounds
for voiding your warranty.
To set the fan speed back to automatic mode, use the
'environment fan-speed auto' command
=====
switch(config)#
```

- This command restores control of the fan speed to the switch.

```
switch(config)#environment fan-speed auto  
switch(config)#
```

6.4.2 environment insufficient-fans action

The `environment insufficient-fans` command controls the switch response to the insufficient fan condition. By default, the switch initiates a shutdown procedure when it senses insufficient fans.

The switch operates normally when one fan is not operating. Non-functioning modules should not be removed from the switch unless they are immediately replaced; adequate switch cooling requires the installation of all components, including a non-functional fan.

Two non-operational fans trigger an *insufficient fan shutdown* condition. This condition normally initiates a power down procedure.

The `no environment insufficient-fans` and `default environment insufficient-fans` commands restore the default shutdown response to the insufficient-fans condition by removing the `environment insufficient-fans action ignore` statement from *running-config*.



Note:

Overriding the system shutdown behavior when the system has insufficient fans inserted is unsupported and should only be done under the direction of an Arista Networks engineer. You risk damaging hardware by not shutting down the system in this situation, and doing so without direction from Arista Networks can be grounds for voiding your warranty.

Command Mode

Global Configuration

Command Syntax

```
environment insufficient-fans action REMEDY
```

```
no environment insufficient-fans action
```

```
default environment insufficient-fans action
```

Parameters

- REMEDY Configures action when switch senses an insufficient fan condition. Settings include:
 - **ignore** Switch continues operating when insufficient fans are operating.
 - **shutdown** Switch shuts power down when insufficient fans are operating.
 - The **shutdown** parameter restores default behavior by removing the `environment insufficient-fans` command from *running-config*.

Examples:

- This command configures the switch to continue operating after it senses insufficient fan condition.

```
switch(config)#environment insufficient-fans action ignore
=====
=====
WARNING: Overriding the system shutdown behavior when the
system
has insufficient fans inserted is unsupported and should only
be done under
the direction of an Arista Networks engineer. You risk
damaging
hardware by not shutting down the system in this situation,
and doing
so without direction from Arista Networks can be grounds for
voiding
your warranty. To re-enable the shutdown-on-overheat behavior,
use
```

```
the 'environment insufficient-fans action shutdown' command.  
=====
```

- This command configures the switch to shut down when it senses an insufficient fan condition.

```
switch(config)#environment insufficient-fans action shutdown  
switch(config)#
```

6.4.3 environment overheat action

The `environment overheat` command controls the switch response to an overheat condition. By default, the switch shuts down when it senses an overheat condition.



Note:

Overriding the system shutdown behavior when the system is overheating is unsupported and should only be done under the direction of an Arista Networks engineer. You risk damaging hardware by not shutting down the system in this situation, and doing so without direction from Arista Networks can be grounds for voiding your warranty.

Arista switches include internal temperature sensors. The number and location of the sensors vary with each switch model. Each sensor is assigned temperature thresholds that denote alert and critical conditions. Temperatures that exceed the threshold trigger the following:

- **Alert Threshold:** All fans run at maximum speed and a warning message is logged.
- **Critical Threshold:** The component is shut down immediately and its Status LED flashes orange.

In modular systems, cards are shut down when their temperatures exceed the critical threshold. The switch normally shuts down if the temperature remains above the critical threshold for three minutes.

The `no environment overheat action` and `default environment overheat action` commands restore the default shutdown response to the environment overheat condition by removing the `environment overheat action ignore` statement from *running-config*.

Command Mode

Global Configuration

Command Syntax

```
environment overheat action REMEDY
```

```
no environment overheat action
```

```
default environment overheat action
```

Parameters

- REMEDY Reaction to an overheat condition. Default value is **shutdown**.
 - **shutdown** Switch shuts power down by an overheat condition.
 - **ignore** Switch continues operating during an overheat condition.

Examples:

- This command configures the switch to continue operating after it senses an overheat condition.

```
switch(config)#environment overheat action ignore
=====
WARNING: Overriding the system shutdown behavior when the
system
is overheating is unsupported and should only be done under
the direction of an Arista Networks engineer. You risk
damaging
hardware by not shutting down the system in this situation,
and doing
so without direction from Arista Networks can be grounds for
voiding
your warranty. To re-enable the shutdown-on-overheat behavior,
use
```

```
the 'environment overheat action shutdown' command.
```

```
=====
switch(config)#
```

- This command configures the switch to shut down when it senses an overheating condition.

```
switch(config)#environment overheat action shutdown
switch(config)#
```

6.4.4 locator-led

When a component requires service, the `locator-led` command activates a locator to assist a technician in finding the component. The command causes the status LED on the specified component to flash, and also displays a “service requested” message on the LCD panel of modular switches or lights the blue locator light on the front of fixed switches. The available locators vary by platform; to see a list of the locator LEDs available on the switch, use the `locator-led ?` command. To disable the locator LED, use the `no locator-led` command.

Command Mode

Privileged EXEC

Command Syntax

```
locator-led {fantray tray_num | interface interface | module module_num | powersupply  
supply_num}
```

```
no locator-led {fantray tray_num | interface interface | module module_num | powersupply  
supply_num}
```

Parameters

- **fantray *tray_num*** Activates locator on specified fan tray.
- **interface *interface*** Activates locator on specified interface.
- **module *module_num*** Activates locator on specified module.
- **powersupply *supply_num*** Activates locator on specified power supply.

Examples:

- This command enables the locator LED on fan tray 3.

```
switch#locator-led fantray 3  
Enabling locator led for FanTray3  
switch#
```

- This command disables the locator LED on fan tray 3.

```
switch#no locator-led fantray 3  
Disabling locator led for FanTray3  
switch#
```

- This command displays the locator LEDs available on the switch.

```
switch#locator-led ?  
fantray      Fan tray LED  
interface    Interface LED  
module       Module LED  
powersupply  Power supply LED  
switch#
```

6.4.5 show environment power

The `show environment power` command displays the status of all power supplies in the switch.

Command Mode

EXEC

Command Syntax

```
show environment power [ INFO_LEVEL ]
```

Parameters

- **INFO_LEVEL** Specifies level of detail that the command displays. Options include:
 - `<no parameter>` Displays current and power levels for each supply.
 - **detail** Also includes status codes that can report error conditions.

Example:

This command displays the status of power supplies on the switch.

```
switch>show environment power
Power
Supply  Model          Capacity  Input   Output   Output   Status
-----  -
1       PWR-760AC      760W     0.81A   11.00A   132.8W   Ok
2       PWR-760AC      760W     0.00A   0.00A    0.0W AC  Loss
switch>
```

6.4.6 show environment temperature

The `show environment temperature` command displays the operating temperature of all sensors on the switch.

Command Mode

EXEC

Command Syntax

```
show environment temperature [MODULE_NAME] [INFO_LEVEL]
```

Parameters

- **MODULE_NAME** Specifies modules for which data is displayed. This parameter is only available on modular switches. Options include:
 - **<no parameter>** All modules (identical to **all** option).
 - **fabric fab_num** Specified fabric module. Number range varies with switch model.
 - **linecard line_num** Line card module. Number range varies with switch model.
 - **supervisor super_num** Supervisor module. Number range varies with switch model.
 - **mod_num** Supervisor (1 to 2) or line card (3 to 18) module.
 - **all** All modules.
- **INFO_LEVEL** Specifies level of detail that the command displays. Options include:
 - **<no parameter>** Displays table that lists the temperature and thresholds of each sensor.
 - **detail** Displays data block for each sensor listing the current temperature and historic data.

Display Values

- **System temperature status** is the first line that the command displays. Values report the following:
 - **Ok** All sensors report temperatures below the alert threshold.
 - **Overheating** At least one sensor reports a temperature above its alert threshold.
 - **Critical** At least one sensor reports a temperature above its critical threshold.
 - **Unknown** The switch is initializing.
 - **Sensor Failed** At least one sensor is not functioning.

Examples:

- This command displays a table that lists the temperature measured by each sensor.

```
switch>show environment temperature
System temperature status is: Ok

Critical
Sensor Description          Temperature  Threshold
Threshold
-----
1      Front-panel temp sensor  30.750C    65C      75C
2      Fan controller 1 sensor   32.000C    75C      85C
3      Fan controller 2 sensor   38.000C    75C      85C
4      Switch chip 1 sensor      50.000C    105C
115C
5      VRM 1 temp sensor        60.000C    105C
110C
switch>
```

- This command lists the temperature detected by each sensor, and includes the number of previous alerts, the time of the last alert, and the time of the last temperature change.

```

switch>show environment temperature detail
TempSensor1 - Front-panel temp sensor
  Temperature          Current State  Count  Last Change
  Max Temperature      30.750C
  23:35:24 ago         35.000C
  Alert                False        0      never

TempSensor2 - Fan controller 1 sensor
  Temperature          Current State  Count  Last Change
  Max Temperature      32.000C
  23:32:46 ago         36.000C
  Alert                False        0      never

TempSensor3 - Fan controller 2 sensor
  Temperature          Current State  Count  Last Change
  Max Temperature      38.000C
  23:37:56 ago         41.000C
  Alert                False        0      never

TempSensor4 - Switch chip 1 sensor
  Temperature          Current State  Count  Last Change
  Max Temperature      51.000C
  23:35:16 ago         53.000C
  Alert                False        0      never

TempSensor5 - VRM 1 temp sensor
  Change              Current State  Count  Last
  Temperature          60.000C
  Max Temperature      62.000C
  22:54:51 ago
  Alert                False        0      never

switch>

```

6.4.7 show locator-led

The `show locator-led` command displays the status of locator LEDs enabled on the switch.

Command Mode

Privileged EXEC

Command Syntax

```
show locator-led
```

Example:

This command displays all locator LEDs enabled on the switch.

```
switch#show locator-led
There are no locator LED enabled
switch#
```

6.4.8 show system environment all

The `show system environment all` command displays temperature, cooling, and power supply status.

Command Mode

EXEC

Command Syntax

```
show system environment all
```

Example:

This command displays the switch's temperature, cooling, and power supply status

```
switch>show system environment all
System temperature status is: Ok
```

Sensor	Description	Temperature	Alert Threshold	Critical
1	Front-panel temp sensor	31.000C	65C	75C
2	Fan controller 1 sensor	32.000C	75C	85C
3	Fan controller 2 sensor	38.000C	75C	85C
4	Switch chip 1 sensor	50.000C	105C	115C
5	VRM 1 temp sensor	60.000C	105C	110C

```
System cooling status is: Ok
Ambient temperature: 31C
Airflow: port-side-intake
Fan Tray Status      Speed
-----
1          Ok          52%
2          Ok          52%
3          Ok          52%
4          Ok          52%
5          Ok          52%
```

Power Supply	Model	Capacity	Input Current	Output Current	Output Power	Status
1	PWR-760AC	760W	0.81A	11.00A	132.6W	Ok
2	PWR-760AC	760W	0.00A	0.00A	0.0W	AC Loss

```
switch>
```

6.4.9 show system environment cooling

The `show system environment cooling` command displays fan status, air flow direction, and ambient temperature on the switch.

Command Mode

EXEC

Command Syntax

```
show system environment cooling [ INFO_LEVEL ]
```

Parameters

- **INFO_LEVEL** Specifies level of detail that the command displays. Options include:
 - *<no parameter>* Displays the fan status, air flow direction, and ambient switch temperature.
 - **detail** Also displays actual and configured fan speed of each fan.

Display Values

- **System cooling status:**
 - **Ok** No more than one fan has failed or is not inserted.
 - **Insufficient fans** More than one fan has failed or is not inserted. This status is also displayed if fans with different airflow directions are installed. The switch shuts down if the error is not resolved.
 - **Ambient temperature** Temperature of the surrounding area.
 - **Airflow** Indicates the direction of the installed fans:
 - **port-side-intake** All fans flow air from the front (port side) to the rear of the chassis.
 - **port-side-exhaust** All fans flow air from the rear to the front (port side) of the chassis.
 - **incompatible fans** Fans with different airflow directions are inserted.
 - **Unknown** The switch is initializing.
- **Fan Tray Status table** Displays the status and operating speed of each fan. Status values indicate the following conditions:
 - **OK** The fan is operating normally.
 - **Failed** The fan is not operating normally.
 - **Unknown** The system is initializing.
 - **Not Inserted** The system is unable to detect the specified fan.
 - **Unsupported** The system detects a fan that the current software version does not support.

Example:

This command displays the fan status, air flow direction, and ambient switch temperature.

```
switch>show system environment cooling
System cooling status is: Ok
Ambient temperature: 30C
Airflow: port-side-intake
Fan Tray  Status              Speed
-----  -
1         Ok                       51%
2         Ok                       51%
3         Ok                       51%
4         Ok                       51%
5         Ok                       51%
```

```
switch>
```

6.4.10 show system environment power budget

The `show system environment power budget` command displays the configured power budget for PoE switches and a table to show the current consumption.

Command Mode

EXEC

Command Syntax

```
show system environment power budget
```

This command displays the configured power budget for a PoE switch and a table to show the current consumption

```
switch>show system environment power budget
Budget is 300.0W out of 1425.2W of total power
Active devices using up to 60.0W

Device          Consumed
Name            Power
-----
Ethernet37      30.0W
Ethernet38      30.0W
Total           60.0W

switch>
```

Upgrades and Downgrades

This chapter describes the procedures for upgrading or downgrading the switch software.

This chapter contains these sections:

- [Upgrade/Downgrade Overview](#)
- [Accelerated Software Upgrade \(ASU\)](#)
- [Leaf Smart System Upgrade \(Leaf SSU\)](#)
- [Standard Upgrades and Downgrades](#)
- [Upgrade/Downgrade Commands](#)

7.1 Upgrade/Downgrade Overview

Upgrading or downgrading Arista switch software is accomplished by replacing the EOS image and reloading the switch. Depending on the switch model and the software change being made, there are different options for minimizing (or potentially eliminating) downtime and packet loss during the upgrade/downgrade.

[Accelerated Software Upgrade \(ASU\)](#) : ASU is available on the 7050SX-64, 7050SX-128, 7050Q-32, and 7050Q-32S and can be used on both leaf and spine switches. It significantly reduces reload time by streamlining and optimizing the reload procedure for upgrades, and continues sending LACP PDUs while the CPU is rebooting, keeping port channels operational during the reload. Downtime during the upgrade is reduced to 30 seconds. Note: ASU does not support software downgrades.

[Leaf Smart System Upgrade \(Leaf SSU\)](#) : SSU is available only on 7050X platforms (excluding 7050SX-72 and 7050SX-96), and can only be used on leaf switches. It includes the core functionality of ASU, plus additional elements that permit a hitless restart of several features. SSU does not support software downgrades, and is incompatible with VRRP.

[Standard Upgrades and Downgrades](#) : In those cases where an accelerated upgrade is not an option (such as software downgrades and unsupported platforms), performing a standard upgrade or downgrade using the steps described here will minimize downtime and packet loss.



Note: To upgrade the software on switches participating in an MLAG, see [Upgrading MLAG Peers](#).

7.2 Accelerated Software Upgrade (ASU)

The Accelerated Software Upgrade (ASU) process significantly decreases downtime and packet loss during a software upgrade in three ways:

- performing time-intensive tasks (including copying the EOS image) before rebooting the control plane
- forwarding packets in hardware (based on the last known state) while the control-plane is offline
- optimizing the boot process by performing only tasks essential for software upgrade

After the control plane has fully loaded, the data plane is restarted, causing approximately 30 seconds of downtime.

7.2.1 Upgrading the EOS image with Accelerated Software Upgrade

Using ASU to upgrade the active EOS image is a five-step process:

1. Check the ASU process compatibility ([Check ASU Process Compatibility](#))
2. Prepare switch for upgrade ([Prepare the Switch](#)).
3. Transfer image file to the switch ([Transfer the Image File for ASU](#)). (Not required if desired file is on the switch).
4. Modify *boot-config* file to point to the desired image file ([Modify boot-config](#)).
5. Start the ASU process ([Start the ASU Process](#)).
6. Verify that switch is running the new image ([Verify](#)).

7.2.1.1 Check ASU Process Compatibility

The ASU process is applicable only to upgrades and only on certain systems running a compatible version of EOS. Before running the `reload fast-boot` command, use the following commands to check for support of the feature and to ensure that other affected features are configured appropriately.

```
switch#show reload fast-boot
No warnings or unsupported configuration found
```



Note: The checks are for conditions that are necessary but do not cover all features. The following commands check for other features that may be affected.

BGP Graceful Restart Configuration

BGP and MP-BGP must have graceful restart enabled with a restart time of at least 600 seconds for a hitless restart. Use the `graceful-restart` command to update the configuration as needed.

The following commands configure the BGP graceful restart time to 600 seconds.

```
switch(config-router-bgp)#graceful-restart
switch(config-router-bgp)#graceful-restart restart-time 600
```

OSPF Graceful Restart Configuration

OSPF must have graceful restart enabled with a grace period of at least 600 seconds for a hitless restart. Use the `graceful-restart` command to update the configuration as needed.

The following commands configure the OSPF grace period to 600 seconds.

```
switch(config-router-ospf)#graceful-restart
switch(config-router-ospf)#graceful-restart grace-period 600
```

Spanning-tree Configuration

Spanning-tree is not supported with ASU and should be disabled.

7.2.1.2 Prepare the Switch

Before upgrading the EOS image, ensure that backup copies of the currently running EOS version and the *running-config* file are available in case of corruption during the upgrade process. To copy the

running-config file, use the `copy running-config` command. In this example, **running-config** is copied to a file in the flash drive on the switch.

```
switch#copy running-config flash:/cfg_06162014
Copy completed successfully.
switch#
```

Determine the size of the new EOS image. Then verify that there is enough space available on the flash drive for two copies of this image (use the `dir` command to check the bytes free figure).

```
switch#dir flash:
Directory of flash:/
-rwx   293168526   Nov  4   22:17   EOS4.11.0.swi
-rwx         36   Nov  8   10:24   boot-config
-rwx    37339   Jun 16   14:18   cfg_06162014
<-----OUTPUT OMITTED FROM EXAMPLE----->
606638080 bytes total (602841088 bytes free)
```

Ensure that the switch has a management interface configured with an IP addresses and default gateway. Refer the sections, [Assigning a Virtual IP Address to Access the Active Ethernet Management Port](#) and [Configuring a Default Route to the Gateway](#) (see [Assigning a Virtual IP Address to Access the Active Ethernet Management Port](#) and [Configuring a Default Route to the Gateway](#)), and confirm that it can be reached through the network by using the `show interfaces status` command and pinging the default gateway.

```
switch#show interfaces status
Port   Name      Status      Vlan      Duplex  Speed  Type
Et3/1  Name      notconnect  1         auto    auto   1000BASE-T

<-----OUTPUT OMITTED FROM EXAMPLE----->
Ma1/1  Name      connected   routed    unconf  unconf Unknown

switch#ping 1.1.1.10
PING 172.22.26.1 (172.22.26.1) 72(100) bytes of data.
 80 bytes from 1.1.1.10: icmp_seq=1 ttl=64 time=0.180 ms
 80 bytes from 1.1.1.10: icmp_seq=2 ttl=64 time=0.076 ms
 80 bytes from 1.1.1.10: icmp_seq=3 ttl=64 time=0.084 ms
 80 bytes from 1.1.1.10: icmp_seq=4 ttl=64 time=0.073 ms
 80 bytes from 1.1.1.10: icmp_seq=5 ttl=64 time=0.071 ms
```

7.2.1.3 Transfer the Image File for ASU

The target image must be copied to the file system on the switch, typically onto the flash drive. After verifying that there is space for two copies of the image, use the CLI `copy` command to copy the image to the flash drive, then confirm that the new image file has been correctly transferred.

These command examples transfer an image file to the flash drive from various locations.

USB Memory

Command

```
copy usb1:/sourcefile flash:/destfile
```

Example

```
Sch#copy usb1:/EOS-4.14.4.swi flash:/EOS-4.14.4.swi
```

FTP Server

Command

```
copy ftp://ftp-source/sourcefile flash:/destfile
```

Example

```
sch#copy ftp://user:password@10.0.0.3/EOS-4.14.4.swi flash:/EOS-4.14.4.swi
```

SCP

Command

```
copy scp://scp-source/sourcefile flash:/destfile
```

Example

```
sch#copy scp://user:password@10.1.1.8/user/EOS-4.14.4.swi flash:/EOS-4.14.4.swi
```

HTTP

Command

```
copy http://http-source/sourcefile flash:/destfile
```

Example

```
sch#copy http://10.0.0.10/EOS-4.14.4.swi flash:/EOS-4.14.4.swi
```

Once the file has been transferred, verify that it is present in the directory, then confirm the MD5 checksum using the **verify** command. The MD5 checksum is available from the EOS download page of the Arista website.

```
switch#dir flash:
Directory of flash:/
-rwx      293168526   Nov  4   22:17   EOS4.14.2.swi
-rwx           36    Nov  8   10:24   boot-config
-rwx      37339     Jun 16   14:18   cfg_06162014
-rwx      394559902   May 30   02:57   EOS4.13.1.swi

606638080 bytes total (208281186 bytes free)
switch#53#verify /md5 flash:EOS-4.14.4.swi
verify /md5 (flash:EOS-4.14.4.swi) =c277a965d0ed48534de6647b12a86991
```

7.2.1.4 Modify boot-config

After transferring and confirming the desired image file, use the **boot system** command to update the **boot-config** file to point to the new EOS image.

This command changes the **boot-config** file to point to the image file located in flash memory at EOS-4.14.4.swi.

```
switch#configure terminal
switch(config)#boot system flash:/EOS-4.14.4.swi
```

Use the `show boot-config` command to verify that the *boot-config* file is correct:

```
switch(config)#show boot-config
Software image: flash:/EOS-4.14.4.swi
Console speed: (not set)
Aboot password (encrypted): $1$ap1QMbmz$DTqsFYeauuMSa7/Qxbi211
```

Save the configuration to the *startup-config* file with the `write` command.

```
switch#write
```

7.2.1.5 Start the ASU Process

After updating the *boot-config* file, start the ASU process using the `reload fast-boot` command to reload the switch and activate the new image. If *running-config* has not been saved, the CLI will prompt to save any modifications to the system configuration; failure to save modifications will abort the reload.

 **Note:** Once the system configuration is saved, there is a significant delay before the user is prompted to confirm the reload.

```
switch#reload fast-boot
System configuration has been modified. Save? [yes/no/cancel/diff]:y
Proceed with reload? [confirm]y
Proceeding with reload
```

7.2.1.6 Verify

After the switch finishes reloading, log into the switch and use the `show version` command to confirm the correct image is loaded. The *Software image version* line displays the version of the active image file.

```
switch#show version
Arista DCS-7150S-64-CL-F
Hardware version:    01.01
Serial number:      JPE13120819
System MAC address: 001c.7326.fd0c

Software image version: 4.14.4F
Architecture:         i386
Internal build version: 4.14.4F-1649184.4144F.2
Internal build ID:    eeb3c212-b4bd-4c19-ba34-1b0aa36e43f1

Uptime:              14 hours and 48 minutes
Total memory:        4017088 kB
Free memory:         1569760 kB

switch>
```

7.3 Leaf Smart System Upgrade (Leaf SSU)

The Smart System Upgrade (SSU) process includes the core functionality of Accelerated Software Upgrade, plus additional optimizations that permit a hitless restart of several features. SSU leverages protocols capable of graceful restart to minimize traffic loss during upgrade. For protocols not capable of graceful restart, SSU generates control plane messages and buffers them in hardware to be slowly released when the control plane is offline. Additionally, under SSU, the forwarding ASIC does not get reset and ports do not flap.

Features capable of hitless restart under SSU include:

- QinQ
- 802.3ad Link Aggregation/LACP
- 802.3x flow control
- BGP (BGP graceful restart must be enabled: see [Configuring BGP](#))
- MP-BGP (BGP graceful restart must be enabled: see [Configuring BGP](#))
- 128-way Equal Cost Multipath Routing (ECMP)
- VRF
- route maps
- L2 MTU
- QoS



Note: SSU is not compatible with VRRP. If VRRP is configured on the switch, another upgrade method must be used.

7.3.1 Upgrading the EOS image with Smart System Upgrade

Using SSU to upgrade the active EOS image is a five-step process:

1. Prepare switch for upgrade ([Prepare the Switch for SSU](#)).
2. Transfer image file to the switch ([Transfer the Image File for SSU](#)). (Not required if desired file is on the switch).
3. Modify **boot-config** file to point to the desired image file ([Modify boot-config](#)).
4. Start the SSU process ([Start the SSU Process](#)).
5. Verify that the upgrade was successful ([Verify Success of the Upgrade](#)).

7.3.1.1 Prepare the Switch for SSU

To prepare the switch for SSU, take the following steps:

- [Backing Up Critical Software](#)
- [Making Room on the Flash Drive](#)
- [Verifying Connectivity](#)
- [Verifying Configuration](#)
- [Configuring BGP](#)

Backing Up Critical Software

Before upgrading the EOS image, ensure that copies of the currently running EOS version and the **running-config** file are available in case of corruption during the upgrade process. To copy the **running-config** file, use the `copy running-config` command. In this example, **running-config** is copied to a file in the flash drive on the switch.

```
switch#copy running-config flash:/cfg_06162014
Copy completed successfully.
switch#
```

Making Room on the Flash Drive

Determine the size of the new EOS image. Then verify that there is enough space available on the flash drive for two copies of this image, plus a recommended 240MB (if available) for diagnostic information in case of a fatal error. Use the `dir` command to check the “bytes free” figure.

```
switch#dir flash:
Directory of flash:/
-rwx 293168526 Nov 4 22:17 EOS4.11.0.swi
```

```
-rwx          36      Nov 8   10:24   boot-config
-rwx        37339     Jun 16   14:18   cfg_06162014
606638080 bytes total (602841088 bytes free)
```

Verifying Connectivity

Ensure that the switch has a management interface configured with an IP addresses and default gateway. Refer the sections, Assigning a Virtual IP Address to Access the Active Ethernet Management Port and Configuring a Default Route to the Gateway (see [Assigning a Virtual IP Address to Access the Active Ethernet Management Port](#) and [Configuring a Default Route to the Gateway](#)), and confirm that it can be reached through the network by using the command and pinging the default gateway.

```
switch#show interfaces status
Port      Name      Status      Vlan      Duplex  Speed  Type
Et3/1                    notconnect  1         auto    auto   1000BASE-T

<-----OUTPUT OMITTED FROM EXAMPLE----->
Ma1/1                    connected   routed    unconf   unconf  Unknown

switch#ping 1.1.1.10
PING 172.22.26.1 (172.22.26.1) 72(100) bytes of data.
 80 bytes from 1.1.1.10: icmp_seq=1 ttl=64 time=0.180 ms
 80 bytes from 1.1.1.10: icmp_seq=2 ttl=64 time=0.076 ms
 80 bytes from 1.1.1.10: icmp_seq=3 ttl=64 time=0.084 ms
 80 bytes from 1.1.1.10: icmp_seq=4 ttl=64 time=0.073 ms
 80 bytes from 1.1.1.10: icmp_seq=5 ttl=64 time=0.071 ms
```

Verifying Configuration

Verify that the switch configuration is valid for SSU by using the `show reload hitless` command. If parts of the configuration are blocking execution of SSU, an error message will be displayed explaining what they are. For SSU to proceed, the configuration conflicts must be corrected before issuing the `reload hitless` command.

```
switch#show reload hitless
switch#'reload hitless' cannot proceed due to the following:
Spanning-tree portfast is not enabled for one or more ports
Spanning-tree BPDU guard is not enabled for one or more ports
switch#
```

Configuring BGP

For hitless restart of BGP and MP-BGP, BGP graceful restart must first be enabled using the `graceful-restart` command. The default restart time value (300 seconds) is appropriate for most configurations.

The BGP configuration mode in which the `graceful-restart` command is issued determines which BGP connections will restart gracefully.

- For all BGP connections, use the `graceful-restart` command in BGP configuration mode:

```
switch#config
switch(config)#router bgp 64496
switch(config-router-bgp)#graceful-restart
switch(config-router-bgp)#
```

- For all BGP connections in a specific VRF, use the **graceful-restart** command in BGP VRF configuration mode:

```
switch#config
switch(config)#router bgp 64496
switch(config-router-bgp)#vrf purple
switch(config-router-bgp-vrf-purple)#graceful-restart
switch(config-router-bgp-vrf-purple)#exit
switch(config-router-bgp)#
```

- For all BGP connections in a specific BGP address family, use the **graceful-restart** command in BGP address-family configuration mode:

```
switch#config
switch(config)#router bgp 64496
switch(config-router-bgp)#address-family ipv6
switch(config-router-bgp-af)#graceful-restart
switch(config-router-bgp-af)#exit
switch(config-router-bgp)#
```

BGP graceful restart can also be configured for a specific interface.

7.3.1.2 Transfer the Image File for SSU

The target image must be copied to the file system on the switch, typically onto the flash drive. After verifying that there is space for two copies of the image plus an optional 240MB for diagnostic information, use the **copy** command to copy the image to the flash drive, then confirm that the new image file has been correctly transferred.

These command examples transfer an image file to the flash drive from various locations.

USB Memory

Command

```
copy usb1:/sourcefile flash:/destfile
```

Example

```
Sch#copy usb1:/EOS-4.14.4.swi flash:/EOS-4.14.4.swi
```

FTP Server

Command

```
copy ftp://ftp-source/sourcefile flash:/destfile
```

Example

```
sch#copy ftp://user:password@10.0.0.3/EOS-4.14.4.swi flash:/EOS-4.14.4.swi
```

SCP

Command

```
copy scp://scp-source/sourcefile flash:/destfile
```

Example

```
sch#copy scp://user:password@10.1.1.8/user/EOS-4.14.4.swi flash:/EOS-4.14.4.swi
```

HTTP**Command**

```
copy http://http-source/sourcefile flash:/destfile
```

Example

```
sch#copy http://10.0.0.10/EOS-4.14.4.swi flash:/EOS-4.14.4.swi
```

Once the file has been transferred, verify that it is present in the directory, then confirm the MD5 checksum using the **verify** command. The MD5 checksum is available from the EOS download page of the Arista website.

```
switch#dir flash:
Directory of flash:/
-rwx      293168526   Nov 4      22:17      EOS4.14.2.swi
-rwx           36    Nov 8      10:24      boot-config
-rwx      37339     Jun 16     14:18      cfg_06162014
-rwx      394559902   May 30     02:57      EOS4.13.1.swi

606638080 bytes total (208281186 bytes free)
switch#53#verify /md5 flash:EOS-4.14.4.swi
verify /md5 (flash:EOS-4.14.4.swi) =c277a965d0ed48534de6647b12a86991
```

7.3.1.3 Modify boot-config

After transferring and confirming the desired image file, use the **boot system** command to update the **boot-config** file to point to the new EOS image.

This command changes the **boot-config** file to point to the image file located in flash memory at EOS-4.14.4.swi.

```
switch#configure terminal
switch(config)#boot system flash:/EOS-4.14.4.swi
```

Use the **show boot-config** command to verify that the **boot-config** file is correct:

```
switch(config)#show boot-config
Software image: flash:/EOS-4.14.4.swi
Console speed: (not set)
Aboot password (encrypted): $1$ap1QMbmz$DTqsFYeauuMSa7/Qxbi211
```

Save the configuration to the **startup-config** file with the **write** command.

```
switch#write
```

7.3.1.4 Start the SSU Process

After updating the **boot-config** file, verify that your configuration supports SSU (if you have not already done so) by using the **show reload hitless** command. If parts of the configuration are blocking execution of SSU, an error message will be displayed explaining what they are.

```
switch#show reload hitless
switch#'reload hitless' cannot proceed due to the following:
Spanning-tree portfast is not enabled for one or more ports
Spanning-tree BPDU guard is not enabled for one or more ports
```

Then start the SSU process using the **reload hitless** command to reload the switch and activate the new image. The CLI will identify any changes that must be made to the configuration before starting SSU, prompt to save any modifications to the system configuration, and request confirmation before reloading.

```
switch#reload hitless
System configuration has been modified. Save? [yes/no/cancel/diff]:y
Copy completed successfully.
Proceed with reload? [confirm]y
```

7.3.1.5 Verify Success of the Upgrade

Before making any configuration changes to the switch after reload, verify that the SSU process is complete using the command **show boot stages log**. If the process is complete, the last message should be Asu Hitless boot stages complete.

```
switch#show boot stages log
Timestamp          Delta Begin Msg
2015-03-28 15:18:30 000.000000 Asu Hitless boot stages started
2015-03-28 15:18:30 000.069732 stage CriticalAgent started
2015-03-28 15:18:30 000.069811 event CriticalAgent:SuperServer
  completed
2015-03-28 15:20:20 110.224504 stage BootSanityCheck is complete
2015-03-28 15:20:20 110.225439 Asu Hitless boot stages complete
switch#
```

Completion of the SSU process may also be verified by checking the syslog for the following message:

```
LAUNCHER-6-BOOT_STATUS: 'reload hitless' reconciliation complete
```

To verify whether the SSU upgrade was successful, use the **show reload cause** command. If a fatal error occurred during the upgrade process, the switch will have completely rebooted and the fatal error will be displayed along with the directory in which diagnostic information can be found. If the SSU upgrade succeeded, it will read Hitless reload requested by the user.

Fatal Error Display

```
switch#show reload cause
Reload Cause 1:
-----
Reload requested by the user.

Reload Time:
-----
Reload occurred at Sat Feb 28 02:34:26 2015 PST.

Recommended Action:
```

```

-----
No action necessary.

Debugging Information:
-----
None available.

Reload Cause 2:
-----
Fatal error during 'reload hitless'. (stageMgr - LinkStatusUpdate timed
out)

Reload Time:
-----
Reload occurred at Sat Feb 28 02:33:54 2015 PST.

Recommended Action:
-----
A fatal error occurred during hitless reload.
If the problem persists, contact your customer support representative.

Debugging Information:
-----
/mnt/flash/persist/fatalError-2015-02-28_023355
switch#

```

Successful Upgrade Display

```

switch#show reload cause
Reload Cause 1:
-----
Hitless reload requested by the user.

Reload Time:
-----
Reload occurred at Wed Mar 25 14:49:04 2015 PDT.

Recommended Action:
-----
No action necessary.

Debugging Information:
-----
None available.
switch#

```

The **show version** command will confirm whether the correct image is loaded. The **Software image version** line displays the version of the active image file.

```

switch#show version
Arista DCS-7050QX-32-F
Hardware version:    02.00
Serial number:      JPE14071098
System MAC address: 001c.7355.556f

Software image version: 4.14.5F-2353054.EOS4145F
Architecture:         i386
Internal build version: 4.14.5F-2353054.EOS4145F
Internal build ID:    e8748ea7-916d-4217-878f-4bfe2adc7122

Uptime:              4 minutes
Total memory:        3981328 kB

```

```
Free memory:          1342408 kB
```

```
switch#
```



Note: If a fatal error occurs during the SSU process, the new EOS image will still be loaded and booted.

7.4 Standard Upgrades and Downgrades

Standard software upgrades and downgrades on Arista switches are accomplished by installing a different EOS image and reloading the switch. On switches with redundant supervisors, the EOS image must be installed on both supervisors. Using the procedure described below will minimize packet loss during a standard upgrade or downgrade.

These sections describe standard switch upgrade and downgrade procedures

- [Upgrading or Downgrading the EOS on a Single-Supervisor Switch](#)
- [Upgrading or Downgrading the EOS on a Dual-Supervisor Switch](#)

7.4.1 Upgrading or Downgrading the EOS on a Single-Supervisor Switch

Modifying the active EOS image is a five-step process:

1. Prepare switch for upgrade ([Prepare the Switch](#)).
2. Transfer image file to the switch ([Transfer the Image File](#)). (Not required if desired file is on the switch).
3. Modify **boot-config** file to point to the desired image file ([Modify boot-config for Single-Supervisor switch](#)).
4. Reload switch ([Reload](#)).
5. Verify that switch is running the new image ([Verify the New Image for Single-Supervisor Switch](#)).

7.4.1.1 Prepare the Switch

Before upgrading the EOS image, ensure that backup copies of the currently running EOS version and the **running-config** file are available in case of corruption during the upgrade process. To copy the **running-config** file, use the **copy running-config** command. In this example, **running-config** is copied to a file in the flash drive on the switch.

```
switch#copy running-config flash:/cfg_06162014
Copy completed successfully.
switch#
```

Determine the size of the new EOS image. Then verify that there is enough space available on the flash drive for two copies of this image (use the **dir** command to check the bytes free figure).

```
switch#dir flash:
Directory of flash:/
-rwx   293168526   Nov  4   22:17   EOS4.11.0.swi
-rwx         36   Nov  8   10:24   boot-config
-rwx    37339    Jun 16   14:18   cfg_06162014
<-----OUTPUT OMITTED FROM EXAMPLE----->
606638080 bytes total (602841088 bytes free)
```

Ensure that the switch has a management interface configured with an IP addresses and default gateway. Refer the sections, [Assigning a Virtual IP Address to Access the Active Ethernet Management Port](#) and [Configuring a Default Route to the Gateway](#) (see [Assigning a Virtual IP Address to Access the Active Ethernet Management Port](#) and [Configuring a Default Route to the Gateway](#)),

and confirm that it can be reached through the network by using the **show interfaces status** command and pinging the default gateway.

```
switch#show interfaces status
Port      Name      Status      Vlan      Duplex  Speed  Type
Et3/1     Et3/1     notconnect  1         auto    auto   1000BASE-T

<-----OUTPUT OMITTED FROM EXAMPLE----->
Ma1/1     Ma1/1     connected  routed    unconf  unconf Unknown

switch#ping 1.1.1.10
PING 172.22.26.1 (172.22.26.1) 72(100) bytes of data.
80 bytes from 1.1.1.10: icmp_seq=1 ttl=64 time=0.180 ms
80 bytes from 1.1.1.10: icmp_seq=2 ttl=64 time=0.076 ms
80 bytes from 1.1.1.10: icmp_seq=3 ttl=64 time=0.084 ms
80 bytes from 1.1.1.10: icmp_seq=4 ttl=64 time=0.073 ms
80 bytes from 1.1.1.10: icmp_seq=5 ttl=64 time=0.071 ms
```

7.4.1.2 Transfer the Image File

The target image must be copied to the file system on the switch, typically onto the flash drive. After verifying that there is space for the image, use the CLI **copy** command to copy the image to the flash drive, then confirm that the new image file has been correctly transferred.

These command examples transfer an image file to the flash drive from various locations.

USB Memory

Command

```
copy usb1:/sourcefile flash:/destfile
```

Example

```
Sch#copy usb1:/EOS-4.13.2.swi flash:/EOS-4.13.2.swi
```

FTP Server

Command

```
copy ftp:/ftp-source/sourcefile flash:/destfile
```

Example

```
sch#copy ftp:/user:password@10.0.0.3/EOS-4.13.2.swi flash:/EOS-4.13.2.swi
```

SCP

Command

```
copy scp://scp-source/sourcefile flash:/destfile
```

Example

```
sch#copy scp://user:password@10.1.1.8/user/EOS-4.13.2.swi flash:/EOS-4.13.2.swi
```

HTTP

Command

```
copy http://http-source/sourcefile flash:/destfile
```

Example

```
sch#copy http://10.0.0.10/EOS-4.13.2.swi flash:/EOS-4.13.2.swi
```

Once the file has been transferred, verify that it is present in the directory, then confirm the MD5 checksum using the **verify** command. The MD5 checksum is available from the EOS download page of the Arista website.

```
switch#dir flash:
Directory of flash:/
-rwx      293168526   Nov 4    22:17    EOS4.11.0.swi
-rwx           36    Nov 8    10:24    boot-config
-rwx      37339     Jun 16   14:18    cfg_06162014
-rwx      394559902   May 30   02:57    EOS-4.12.2.swi

606638080 bytes total (208281186 bytes free)
switch#53#verify /md5 flash:EOS-4.13.2.swi
verify /md5 (flash:EOS-4.13.2.swi) =c277a965d0ed48534de6647b12a86991
```

7.4.1.3 Modify boot-config for Single-Supervisor switch

After transferring and confirming the desired image file, use the **boot system** command to update the **boot-config** file to point to the new EOS image.

This command changes the **boot-config** file to point to the image file located in flash memory at EOS-4.12.2.swi.

```
switch#configure terminal
switch(config)#boot system flash:/EOS-4.13.2.swi
```

Use the **show boot-config** command to verify that the **boot-config** file is correct:

```
switch(config)#show boot-config
Software image: flash:/EOS-4.13.2.swi
Console speed: (not set)
Aboot password (encrypted): $1$ap1QMbmz$DTqsFYeauuMSa7/Qxbi211
```

Save the configuration to the **startup-config** file with the **write** command.

```
switch#write
```

7.4.1.4 Reload

After updating the **boot-config** file, reset the switch to activate the new image. The **reload** command resets the switch, resulting in temporary downtime and packet loss on single supervisor switches.

When reloading from the console port, all rebooting messages are displayed on the terminal. From any port except the console, the CLI displays this text:

```
switch#reload
The system is going down for reboot NOW!
```

 **Note:** The EOS boot process makes a copy of the .swi image file in the internal flash while booting, so sufficient space for **two copies** must be present when loading the new EOS image. If the switch is reloaded without adequate space on the flash drive, it will boot to the About prompt from which you can delete files from /mnt/flash to free up additional space. Exiting About will begin the boot process again.

7.4.1.5 Verify the New Image for Single-Supervisor Switch

After the switch finishes reloading, log into the switch and use the `show version` command to confirm the correct image is loaded. The **Software image version** line displays the version of the active image file.

```
switch#show version
Arista DCS-7150S-64-CL-F
Hardware version:    01.01
Serial number:      JPE13120819
System MAC address: 001c.7326.fd0c

Software image version: 4.13.2F
Architecture:         i386
Internal build version: 4.13.2F-1649184.4132F.2
Internal build ID:    eeb3c212-b4bd-4c19-ba34-1b0aa36e43f1

Uptime:              14 hours and 48 minutes
Total memory:        4017088 kB
Free memory:         1569760 kB

switch>
```

7.4.2 Upgrading or Downgrading the EOS on a Dual-Supervisor Switch

Modifying the active EOS image is a four-step process:

1. Prepare switch for upgrade ([Prepare the switch for Dual-Supervisor Switch](#)).
2. Transfer image file to primary supervisor ([Transfer the Image File to the Primary Supervisor](#)). (Not required if desired file is on switch)
3. Use the `install` command to install the new EOS image and update **boot-config** ([Install the New EOS Image](#)).
4. Verify that the switch is running the new image ([Verify the New Image](#)).

 **Note:** Due to a change in the supervisor heartbeat timeout, booting one supervisor with a post-SSO image (version 4.10.0-SSO, 4.11.X and later) while the other supervisor is running a pre-SSO image will cause the supervisor running the pre-SSO image to reload. This will cause a disruption as both supervisors will be inactive for a short time. To minimize downtime, upgrade the images on both supervisors and reload the entire chassis using the `install` command.

7.4.2.1 Prepare the switch for Dual-Supervisor Switch

To prepare the switch for an EOS upgrade, take the following steps:

- Back up essential files.
- Ensure that you are logged in to the primary supervisor.
- Ensure that the primary supervisor is reachable and that the management interfaces are configured.
- Ensure that there is enough room on both supervisors for the new image file.
- Ensure that any extensions running on the active supervisor are also available on the standby.

Before upgrading the EOS image, ensure that backup copies of the currently running EOS version and the **running-config** file are available in case of corruption during the upgrade process. To copy the **running-config** file, use the `copy running-config` command. In this example, **running-config** is copied to a file called "backup2" on the flash drive.

```
switch#copy running-config backup2
Copy completed successfully.
switch#
```

Ensure that you are logged in to the primary supervisor, not the standby. Use the `show redundancy status` command, and verify that **my state** reads "ACTIVE" and not "STANDBY."

```
switch#show redundancy status
my status = Active
peer state = STANDBY HOT
Unit = Secondary
Unit ID = 1
Redundancy Protocol (Operational) = Stateful Switchover
Redundancy Protocol (Configured) = Stateful Switchover
Communications = Up
Ready for switchover
Last switchover time = 25 days, 19:51:34 ago
Last switchover reason = Other supervisor stopped sending heartbeats
```

Ensure that the switch has a management interface configured with an IP addresses and default gateway. Refer the sections, Assigning a Virtual IP Address to Access the Active Ethernet Management Port and Configuring a Default Route to the Gateway (see [Assigning a Virtual IP Address to Access the Active Ethernet Management Port](#) and [Configuring a Default Route to the Gateway](#)), and confirm that both management interfaces are in the up state and can ping the default gateway by using the `show interfaces status` command and `ping` command.



Note: If the management VRF interface is used, use the virtual management interface (management 0) instead of the IP address on the physical management interface.

```
switch#show interfaces status
Port      Name      Status      Vlan      Duplex      Speed      Type
Et3/1     Et3/1     notconnect  1         auto        auto       1000BASE-T

<-----OUTPUT OMITTED FROM EXAMPLE----->
Ma1/1     Ma1/1     connected   routed    unconf      unconf     Unknown

switch#ping 1.1.1.10
PING 172.22.26.1 (172.22.26.1) 72(100) bytes of data.
 80 bytes from 1.1.1.10: icmp_seq=1 ttl=64 time=0.180 ms
 80 bytes from 1.1.1.10: icmp_seq=2 ttl=64 time=0.076 ms
 80 bytes from 1.1.1.10: icmp_seq=3 ttl=64 time=0.084 ms
 80 bytes from 1.1.1.10: icmp_seq=4 ttl=64 time=0.073 ms
 80 bytes from 1.1.1.10: icmp_seq=5 ttl=64 time=0.071 ms
```

Determine the size of the new EOS image. Then verify that there is enough space available on the flash drive for two copies of this image (use the `dir` command to check the bytes free figure).

```
switch#dir flash:
Directory of flash:/
-rwx   293168526   Nov 4   22:17   EOS4.11.0.swi
-rwx         36   Nov 8   10:24   boot-config
-rwx   37339      Jun 16  14:18   cfg_06162014
<-----OUTPUT OMITTED FROM EXAMPLE----->
606638080 bytes total (602841088 bytes free)
Standby supervisor:
switch#dir supervisor-peer:mnt/flash/
```



```
Directory of flash:/
-rwx 293168526 Nov 4 22:17 EOS4.11.0.swi
-rwx 36 Nov 8 10:24 boot-config
-rwx 37339 Jun 16 14:18 cfg_06162014
<-----OUTPUT OMITTED FROM EXAMPLE----->
606638080 bytes total (602841088 bytes free)
```

And, finally, ensure that any extensions running on the primary supervisor are also available on the secondary supervisor.

7.4.2.2 Transfer the Image File to the Primary Supervisor

Load the desired image to the file system on the primary supervisor, typically into the flash. Use the CLI `copy` command to load files to the flash on the primary supervisor, then confirm that the new image file has been correctly transferred.

These command examples transfer an image file to flash from various locations.

USB Memory

Command

```
copy usb1:/sourcefile flash:/destfile
```

Example

```
Sch#copy usb1:/EOS-4.13.2.swi flash:/EOS-4.13.2.swi
```

FTP Server

Command

```
copy ftp:/ftp-source/sourcefile flash:/destfile
```

Example

```
Sch#copy ftp:/user:password@10.0.0.3/EOS-4.13.2.swi flash:/EOS-4.13.2.swi
```

SCP

Command

```
copy scp://scp-source/sourcefile flash:/destfile
```

Example

```
sch#copy scp://user:password@10.1.1.8/user/EOS-4.13.2.swi flash:/EOS-4.13.2.swi
```

HTTP

Command

```
copy http://http-source/sourcefile flash:/destfile
```

Example

```
sch#copy http://10.0.0.10/EOS-4.13.2.swi flash:/EOS-4.13.2.swi
```

Once the file has been transferred, verify that it is present in the directory, then confirm the MD5 checksum using the **verify** command. The MD5 checksum for each available image can be found on the EOS download page of the Arista website.

```
switch#dir flash:
Directory of flash:/
-rwx      293168526      Nov  4   22:17      EOS4.11.0.swi
-rwx           36      Nov  8   10:24      boot-config
-rwx      37339      Jun 16   14:18      cfg_06162014
-rwx      394559902      May 30   02:57      EOS-4.12.2.swi

<-----OUTPUT OMITTED FROM EXAMPLE----->

606638080 bytes total (208281186 bytes free)
switch#53#verify /md5 flash:EOS-4.13.2.swi
verify /md5 (flash:EOS-4.13.2.swi) =c277a965d0ed48534de6647b12a86991
```

7.4.2.3 Install the New EOS Image

Once the EOS image has been copied to the flash drive of the primary supervisor, use the **install** command to update the **boot-config**, copy the new image to the secondary supervisor and reload both supervisors. When upgrading to a new image, both supervisors will briefly be unavailable; using the **install** command minimizes packet loss during reload.

```
switch(config)#install source EOS-4.13.2.swi reload
Preparing new boot-config... done.
Copying new software image to standby supervisor... done.
Copying new boot-config to standby supervisor... done.
Committing changes on standby supervisor... done.
Reloading standby supervisor... done.
Committing changes on this supervisor... done.
Reloading this supervisor...
```

7.4.2.4 Verify the New Image

After the switch finishes reloading, log into the switch and use the **show version** command to confirm the correct image is loaded. The **Software image version** line displays the version of the active image file.

```
switch#show version
Arista DCS-7504
Hardware version:      01.01
Serial number:         JPE13120819
System MAC address:   001c.7326.fd0c

Software image version: 4.13.2F
Architecture:         i386
Internal build version: 4.13.2F-1649184.4132F.2
Internal build ID:     eeb3c212-b4bd-4c19-ba34-1b0aa36e43f1

Uptime:                1 hour and 36 minutes
Total memory:          4017088 kB
Free memory:           1473280 kB

switch#
```

7.5 Upgrade/Downgrade Commands

- [install](#)
- [reload fast-boot](#)
- [reload hitless](#)

7.5.1 install

The `install` command copies the specified EOS image onto the switch (if the source is external), configures the `boot-config` file to point to the specified EOS image, copies the image to the standby supervisor (on dual-supervisor switches), and optionally reloads the switch to run the new EOS.

Command Mode

Privileged EXEC

Command Syntax

```
install source source_path [destination destination_path] [now] [reload]
```

Parameters

- **source_path** file path and name of EOS image. If no file path is specified, the switch will look for the image on the flash drive of the primary supervisor.
- **destination destination_path** destination file path and name of the EOS image. If no destination or name is specified, the EOS image will be stored on the flash drive with its original file name.
- **now** command is executed immediately without further prompts.
- **reload** supervisor is reloaded after the image and updated `boot-config` file are installed. On dual-supervisor switches, reloads both supervisors, after which control is returned to the primary supervisor.

Example

- This command updates the `boot-config` file to point to the EOS.swi file on the primary supervisors flash drive, copies the image and `boot-config` file to the secondary supervisor, and reboots both.

```
switch(config)#install source EOS.swi reload
Preparing new boot-config... done.
Copying new software image to standby supervisor... done.
Copying new boot-config to standby supervisor... done.
Committing changes on standby supervisor... done.
Reloading standby supervisor... done.
Committing changes on this supervisor... done.
Reloading this supervisor...
```

7.5.2 reload fast-boot

The `reload fast-boot` command starts the Accelerated Software Upgrade (ASU) process using the EOS image specified by the `boot-config` file (configured by the `boot system` command).

ASU significantly decreases downtime and packet loss during a software upgrade, but the data plane is still restarted after the control plane has loaded, resulting in approximately 30 seconds of downtime. If available, Arista recommends using Smart System Upgrade (SSU) instead.

ASU shortens downtime and minimizes packet loss during EOS upgrades in three ways:

- performing time-intensive tasks (including copying the EOS image) before rebooting the control plane
- forwarding packets in hardware (based on the last known good state) while the control-plane is offline
- optimizing the boot process by performing only tasks essential for software upgrade

Command Mode

Privileged EXEC

Command Syntax

```
reload fast-boot
```

Guidelines

- ASU is supported only for upgrades (not downgrades).
- ASU is not supported if the EOS upgrade requires an FPGA upgrade.
- Enough free space must be available on the flash drive to store two copies of the target EOS image.

Example

- This command starts the Accelerated Software Upgrade process.

```
switch#reload fast-boot  
Proceed with reload? [confirm]
```

When the `reload fast-boot` command is entered, the switch sends a message prompting the user to save the configuration if it contains unsaved modifications, then asks the user to confirm the reload request.

7.5.3 reload hitless

The `reload hitless` command starts the Smart System Upgrade (SSU) process using the EOS image specified by the `boot-config` file (configured by the `boot system` command).

Command Mode

Privileged EXEC

Command Syntax

```
reload hitless
```

Guidelines

- SSU is supported only for upgrades (not downgrades).
- SSU is not supported if the EOS upgrade requires an FPGA upgrade.
- Enough free space must be available on the flash drive to store two copies of the target EOS image. It is also recommended that an additional 240MB be available to store diagnostic information.

Example

- This command starts the SSU process.

```
switch#reload hitless  
Proceed with reload? [confirm]
```

- If there are issues with the current switch configuration that will prevent SSU from being performed, the switch lists the changes that must be made before SSU can begin.

```
switch#reload hitless  
switch#'reload hitless' cannot proceed due to the following:  
Spanning-tree portfast is not enabled for one or more ports  
Spanning-tree BPDU guard is not enabled for one or more ports  
switch#
```

- When the `reload hitless` command is entered, the switch sends a message prompting the user to save the configuration if it contains unsaved modifications, then asks the user to confirm the reload request.

```
switch#reload hitless  
System configuration has been modified. Save? [yes/no/cancel/  
diff]:y  
Copy completed successfully.  
Proceed with reload? [confirm]y
```

Security

The Security chapter contains the following sections:

- [User Security](#)
- [Control Plane Security](#)
- [Data Plane Security](#)

8.1 User Security

This section covers the following:

- [AAA Configuration](#)

8.1.1 AAA Configuration

This section describes Authentication, Authorization, and Accounting (AAA), and contains these topics:

- [Authentication, Authorization, and Accounting Overview](#)
- [Configuring the Security Services](#)
- [Server Groups](#)
- [Activating Security Services](#)
- [Role-Based Authorization](#)
- [TACACS+ Configuration Examples](#)
- [AAA Commands](#)

8.1.1.1 Authentication, Authorization, and Accounting Overview

This section contains the following topics:

- [Methods](#)
- [Configuration Statements](#)
- [Encryption](#)

8.1.1.1.1 Methods

The switch controls access to EOS commands by authenticating user identity and verifying user authorization. Authentication, Authorization, and Accounting (AAA) activities are conducted through three data services - a local security database, TACACS+ servers, and RADIUS servers. [Configuring the Security Services](#) describes these services.

8.1.1.1.2 Configuration Statements

Enabling AAA on the switch requires two steps:

1. Configure security service parameters.

The switch provides configuration commands for each security service:

- A local file supports authentication through **username** and [enable password](#) commands.
 - TACACS+ servers provide security services through **tacacs-server** commands.
 - RADIUS servers provide security services through **radius-server** commands.

[Configuring the Security Services](#) describes security service configuration commands.

2. Activate AAA services.

EOS provides **aaa authorization**, **aaa authentication**, and **aaa accounting** commands to select the primary and backup services. [Activating Security Services](#) provides information on implementing a security environment.

8.1.1.1.3 Encryption

The switch uses clear-text passwords and server access keys to authenticate users and communicate with security systems. To prevent accidental disclosure of passwords and keys, running-config stores their corresponding encrypted strings. The encryption method depends on the type of password or key.

Commands that configure passwords or keys can accept the clear-text password or an encrypted string that was generated by the specified encryption algorithm with the clear-text password as the seed.

8.1.1.2 Configuring the Security Services

The switch can access three security data services to authenticate users and authorize switch tasks: a local file, TACACS+ servers, and RADIUS Servers.

This section contains the following topics:

- [Local Security File](#)
- [TACACS+](#)
- [RADIUS](#)
- [AAA with LDAP](#)

8.1.1.2.1 Local Security File

The local file uses passwords to provide these authentication services:

- authenticate users as they log into the switch
- control access to configuration commands
- control access to the switch root login

The local file contains username-password combinations to authenticate users. Passwords also authorize access to configuration commands and the switch root login.

8.1.1.2.1.1 Passwords

The switch recognizes passwords as clear text and encrypted strings.

- **Clear-text** passwords are the text that a user enters to access the CLI, configuration commands, or the switch root login.
- **Encrypted strings** are MD5-encrypted strings generated with the **clear text** as the seed. The local file stores passwords in this format to avoid unauthorized disclosure. When a user enters the clear-text password, the switch generates the corresponding secure hash and compares it to the stored version.

 **Note:** The switch cannot recover the clear text from which an encrypted string is generated.

Valid passwords contain the characters A-Z, a-z, 0-9 and any of these punctuation characters:

! @ # \$ % ^ & * () - _ = + { } [] ; : < > , . ? / ~ \

8.1.1.2.1.2 Usernames

Usernames control access to the EOS and all switch commands. The switch is typically accessed through an SSH login, using a previously defined username-password combination. To create a new username or modify an existing username, use the [username](#) command.

Valid usernames begin with A-Z, a-z, or 0-9 and may also contain any of these characters:

@ # \$ % ^ & * - _ = + ; < > , . ~ |

The default username is **admin**, which is described in [Admin Username](#).

Examples

- These equivalent commands create the username “john” and assign it the password “x245.” The password is entered in clear text because the encrypt-type parameter is omitted or zero.

```
switch(config)#username john secret x245
switch(config)#username john secret 0 x245
```

- This command creates the username “john” and assigns it to the text password that corresponds to the encrypted string “\$1\$sU.7hptc\$TsJ1qslCL7ZYVbyXNG1wg1.” The string was generated by an MD5-encryption program using “x245” as the seed.

```
switch(config)# username john secret 5 $1$sU.7hptc$TsJ1qslCL7ZYVb
yXNG1wg1
```

The username is authenticated by entering “x245” when the CLI prompts for a password.

- This command creates the username “jane” without securing it with a password. It also removes a password if the “jane” username exists.

```
switch(config)# username jane nopassword
```

- This command removes the username “william” from the local file.

```
switch(config)# no username william
```

8.1.1.2.1.3 Logins by Unprotected Usernames

The default switch configuration allows usernames that are not password-protected to log in only from the console. The [aaa authentication policy local allow-nopassword-remote-login](#) command configures the switch to allow unprotected usernames to log in from any port. To reverse this setting to the default state, use no form of [aaa authentication policy local allow-nopassword-remote-login](#).

 **Note:** Allowing remote access to accounts without passwords is a severe security risk. Arista Networks recommends assigning strong passwords to all usernames.

Examples

- This command configures the switch to allow unprotected usernames to log in from any port.

```
switch(config)#aaa authentication policy local allow-nopassword-remote-
login
```

- This command configures the switch to allow unprotected usernames to log in only from the console port.

```
switch(config)#no aaa authentication policy local allow-nopassword-remote-login
```

8.1.1.2.1.4 Enable Command Authorization

The **enable** command controls access to Privileged EXEC and all configuration command modes. The enable password authorizes users to execute the **enable** command. When the enable password is set, the CLI displays a password prompt when a user attempts to enter Privileged EXEC mode.

```
main-host> enable
Password:
main-host#
```

If an incorrect password is entered three times in a row, the CLI displays the EXEC mode prompt.

If no enable password is set, the CLI does not prompt for a password when a user attempts to enter Privileged EXEC mode.

To set the enable password, use the [enable password](#) command.

Examples

- These equivalent commands assign “xyrt1” as the enable password.

```
switch(config)#enable password xyrt1
switch(config)#enable password 0 xyrt1
```

- This command assigns the enable password to the clear text “12345” corresponding to the encrypted string “\$1\$8bPBrJnd\$Z8wbKLHpJEd7d4tc5Z/6h/.” The string was generated by an MD5-encryption program using “12345” as the seed.

```
switch(config)#enable password 5 $1$8bPBrJnd$Z8wbKLHpJEd7d4tc5Z/6h/
```

- This command deletes the enable password.

```
switch(config)#no enable password
```

8.1.1.2.1.5 Root Account Password

The root account accesses the root directory in the underlying Linux shell. When it is not password protected, you can log into the root account only through the console port. After you assign a password to the root account, you can log into it through any port.

To set the password for the root account, use the [aaa root](#) command.

Examples

- These equivalent commands assign “f4980” as the root account password.

```
switch(config)#aaa root secret f4980
switch(config)#aaa root secret 0 f4980
```

- This command assigns the text “ab234” that corresponds to the encrypted string “\$1\$HW05LEY8\$QEVw6JqjD9VqDfh.O8r.b.” as the root password.

```
switch(config)#aaa root secret 5 $1$HW05LEY8$QEVw6JqjD9VqDfh.O8r.b
```

- This command removes the password from the root account.

```
switch(config)#aaa root nopassword
```

- This command disables the root login.

```
switch(config)#no aaa root
```

8.1.1.2.2 TACACS+

Terminal Access Controller Access-Control System Plus (TACACS+), derived from the TACACS protocol defined in RFC 1492, is a network protocol that provides centralized user validation services. TACACS+ information is maintained on a remote database. EOS support of TACACS+ services requires access to a TACACS+ server.

TACACS+ manages multiple network access points from a single server. The switch defines a TACACS+ server connection by its address and port, allowing the switch to conduct multiple data streams to a single server by addressing different ports on the server.

These sections describe steps that configure access to TACACS+ servers. Configuring TACACS+ access is most efficiently performed when TACACS+ is functioning prior to configuring switch parameters.

8.1.1.2.2.1 Configuring TACACS+ Parameters

TACACS+ parameters define settings for the switch to communicate with TACACS+ servers. A set of values can be configured for individual TACACS+ servers that the switch accesses. Global parameters define settings for communicating with servers for which parameters are not individually configured.

The switch supports the following TACACS+ parameters.

Encryption Key

The encryption key is code that the switch and the TACACS+ server share to facilitate communications.

- The [tacacs-server host](#) command defines the encryption key for a specified server.
- The [tacacs-server key](#) command defines the global encryption key.

Examples

- This command configures the switch to communicate with the TACACS+ server assigned the host name “TAC_1” using the encryption key “rp31E2v.”

```
switch(config)#tacacs-server host TAC-1 key rp31E2v
```

- This command configures “cv90jr1” as the global encryption key.

```
switch(config)#tacacs-server key 0 cv90jr1
```

- This command assigns “cv90jr1” as the global key, using the corresponding encrypted string.

```
switch(config)#tacacs-server key 7 020512025B0C1D70
```

Session Multiplexing

The switch supports multiplexing sessions on a single TCP connection.

- The [tacacs-server host](#) command configures the multiplexing option for a specified server.
- There is no global multiplexing setting.

Example

- This command configures the switch to communicate with the TACACS+ server at 10.12.7.9 and indicates the server supports session multiplexing on a TCP connection.

```
switch(config)#tacacs-server host 10.12.7.9 single-connection
```

Timeout

The timeout is the period the switch waits for a successful connection to, or response from, the TACACS+ server. The default is 5 seconds.

- The [tacacs-server host](#) command defines the timeout for a specified server.
- The [tacacs-server timeout](#) command defines the global timeout.

Examples

- This command configures the switch to communicate with the TACACS+ server assigned the host name "TAC_1" and configures the timeout period as 20 seconds.

```
switch(config)#tacacs-server host TAC_1 timeout 20
```

- This command configures 40 seconds as the period that the server waits for a response from a TACACS+ server before issuing an error.

```
switch(config)#tacacs-server timeout 40
```

Port

The port specifies the port number through which the switch and the servers send information. The TACACS+ default port is 49.

- The [tacacs-server host](#) command specifies the port number for an individual TACACS+ server.
- The global TACACS+ port number cannot be changed from the default value of 49.

Example

- This command configures the switch to communicate with the TACACS+ server at 10.12.7.9 through port 54.

```
switch(config)#tacacs-server host 10.12.7.9 port 54
```

8.1.1.2.2.2 TACACS+ Status

To display the TACACS+ servers and their interactions with the switch, use the [show tacacs](#) command.

Example

- This command lists the configured TACACS+ servers.

```
switch(config)#show tacacs

server1: 10.1.1.45
Connection opens: 15
Connection closes: 6
Connection disconnects: 6
Connection failures: 0
Connection timeouts: 2
```

```

Messages sent: 45
Messages received: 14
Receive errors: 2
Receive timeouts: 2
Send timeouts: 3

Last time counters were cleared: 0:07:02 ago

```

To reset the TACACS+ status counters, use the `clear aaa counters tacacs+` command.

Example

- This command clears all TACACS+ status counters.

```
switch(config)#clear aaa counters tacacs
```

8.1.1.2.3 RADIUS

Remote Authentication Dial-In User Service (RADIUS) is a networking protocol that provides centralized AAA services for computers connecting to and using network resources. RADIUS is used to manage access to the Internet, internal networks, wireless networks, and integrated email services.

These sections describe steps that configure RADIUS server access. Configuring RADIUS parameters is most efficiently performed when RADIUS is functioning prior to configuring switch parameters.

8.1.1.2.3.1 RADIUS Vendor-Specific Attribute-Value Pairs

RADIUS servers and client companies extend basic RADIUS functionality through vendor-specific attributes. A dictionary file includes a list of RADIUS attribute-value pairs that Arista switches use to perform AAA operations through the RADIUS server.

Arista switches use the following attribute values:

- Arista Vendor number: 30065
- Attribute: Arista-AVPair 1 string

Acceptable string values for Arista-AVPair include:

- "shell:priv-lvl=<privilege level of a user, 0-15>"
- "shell:roles=<list of roles for a user>"

Example

- This is a sample dictionary file that identifies Arista RADIUS vendor-specific attribute value pairs.

```

#
# dictionary.arista
#
VENDOR          Arista      30065
# Standard Attribute
BEGIN-VENDOR    Arista
ATTRIBUTE       Arista-AVPair  1      string
END-VENDOR      Arista

```

8.1.1.2.3.2 Configuring RADIUS Defaults

RADIUS policies specify settings for the switch to communicate with RADIUS servers. A set of values can be configured for individual RADIUS servers that the switch accesses. Global parameters define settings for communicating with servers for which parameters are not individually configured.

The switch defines the following RADIUS parameters.

Encryption Key

The encryption key is the key shared by the switch and RADIUS servers to facilitate communications.

- The `radius-server host` command defines the encryption key for a specified server.
- The `radius-server key` command specifies the global encryption key.

Examples

- This command configures the switch to communicate with the RADIUS server assigned the host name "RAD-1" using the encryption key "rp31E2v."

```
switch(config)#radius-server host RAD-1 key rp31E2v
```

- This command configures "cv90jr1" as the global encryption key.

```
switch(config)#radius-server key 0 cv90jr1
```

- This command assigns cv90jr1 as the key by specifying the corresponding encrypted string.

```
switch(config)#radius-server key 7 020512025B0C1D70
```

Timeout

The timeout is the period that the switch waits for a successful connection to, or response from, a RADIUS server. The default period is 5 seconds.

- The `radius-server host` command defines the timeout for a specified server.
- The `radius-server key` command defines the global timeout.

Examples

- This command configures the switch to communicate with the RADIUS server assigned the host name *RAD-1* and configures the timeout period as *20 seconds*.

```
switch(config)#radius-server host RAD-1 timeout 20
```

- This command configures *50 seconds* as the period that the server waits for a response from a RADIUS server before issuing an error.

```
switch(config)#radius-server timeout 50
```

Retransmit

Retransmit is the number of times the switch attempts to access the RADIUS server after the first server timeout expiry. The default value is 3 times.

- The `radius-server host` command defines the retransmit for a specified server.
- The `radius-server retransmit` command defines the global retransmit value.

Examples

- This command configures the switch to communicate with the RADIUS server assigned the host name "RAD-1" and configures the retransmit value as 2.

```
switch(config)#radius-server host RAD-1 retransmit 2
```

- This command configures the switch to attempt five RADIUS server contacts after the initial timeout. If the timeout parameter is set to 50 seconds, then the total period that the switch waits for a response is $((5+1)*50) = 300$ seconds.

```
switch(config)#radius-server retransmit 5
```

Deadtime

Deadtime is the period when the switch ignores a non-responsive RADIUS server or a server that does not answer retransmit attempts after timeout expiry. Deadtime is disabled if a value is not specified.

- The [radius-server host](#) command defines the deadtime for a specified server.
- The [radius-server deadtime](#) command defines the global deadtime setting.

Examples

- This command configures the switch to communicate with the RADIUS server assigned the host name “RAD-1” and configures the deadtime period as 90 minutes.

```
switch(config)#radius-server host RAD-1 deadtime 90
```

- This command programs the switch to ignore a server for two hours if the server does not respond to a request during the timeout-retransmit period.

```
switch(config)#radius-server deadtime 120
```

Port

The port specifies the port number through which the switch and servers send information.

- The [radius-server host](#) command specifies the port numbers for an individual RADIUS server.
- The global RADIUS port numbers cannot be changed from the default values of 1812 for an authorization port and 1813 for an accounting port.

Example

- These commands configure the switch to communicate with the RADIUS server named “RAD-1” through port number 1850 for authorization and port number 1851 for accounting.

```
switch(config)#radius-server host RAD-1 auth-port 1850
switch(config)#radius-server host RAD-1 acct-port 1851
```

To remove the configuration for this server, use `no radius-server host` command and specify the hostname or IP address with both the authorization and accounting port numbers.

8.1.1.2.3.3 DSCP Support for CPU-generated Traffic

The differentiated services code point (DSCP) is a 6 bit field in the IP header, which marks traffic for providing quality of service (QoS). All protocol-specific traffic from the switch is marked with the configured DSCP value set individually for the following network management protocols:

- RADIUS
- TACACS
- SNMP
- SSH
- sFlow

Configuring DSCP Value

The following commands are applicable to all platforms for configuring DSCP value.

Example

This command configures the DSCP value of 62 for RADIUS-server.

```
switch(config)#radius-server qos dscp 62
```

This command configures the DSCP value of 36 for TACACS-server.

Example

```
switch(config)#tacacs-server qos dscp 36
```

This command configures the DSCP value of 36 for snmp-server.

```
switch(config)#snmp-server qos dscp 36
```

Example

This command configures the DSCP value of 36 for sFlow.

```
switch(config)#sFlow qos dscp 36
```

This command configures the DSCP value of 36 for snmp-server.

```
switch(config)#snmp-server qos dscp 36
```

8.1.1.2.3.4 RADIUS Status

The [show radius](#) command displays configured RADIUS servers and their interactions with the switch.

Example

- This command lists the configured RADIUS servers.

```
switch(config)#show radius

server1: 10.1.1.45
Messages sent: 24
Messages received: 20
Requests accepted: 14
Requests rejected: 8
Requests timeout: 2
Requests retransmitted: 1
Bad responses: 1
Last time counters were cleared: 0:07:02 ago
```

To reset the RADIUS status counters, use the [clear aaa counters radius](#) command.

Example

- This command clears all RADIUS status counters.

```
switch(config)#clear aaa counters radius
```

8.1.1.2.4 AAA with LDAP

The switches support AAA with LDAP protocol for authentication and authorization using TLS communication with a remote LDAP server, and interoperates with Microsoft's ActiveDirectory when configured with LDAP plugins. LDAP authentication configuration is required for LDAP to work. AAA requests to servers are made in the order of their configuration. Once a server is marked as unreachable, it is tried only after all other servers are also found unreachable.

Configuring LDAP Authentication

For all platforms, the `ldap` command is configured from the management `ldap` mode and requires configuration files to provide remote authentication.

Active Directory Server with LDAP Plug-in Configured

The file extract below configures the authentication for *rdn attribute user* and *search filter*.

```
aaa authentication login default group ldap local
aaa authorization exec default group ldap local
!
management ldap
  server host ldap-server.samplecompany.com
  !
  server defaults
    base-dn dc=samplecompany,dc=com
    rdn attribute user cn
    ssl-profile testProfile
    authorization group policy basic-role-example
    search username cn=ldap-admin-acct,OU=ServiceAccounts,O
U=Sample,dc=samplecompany,dc=com password 0 secretString
  !
  group policy basic-role-example
    search filter objectclass group attribute member
    group "Network Admin" role network-admin
    group "Network Newbie" role network-operator
  !
management security
  ssl profile testProfile
  fips restrictions
  trust certificate caCert
!
```

The file extract below configures the management `ldap` mode.

```
management ldap
  server host ldap-server.samplecompany.com
    ssl-profile testProfile2
    authorization group policy company1
  !
  Server host ldap-server.company2.com
  !
  server defaults
    base-dn dc=samplecompany,dc=com
    rdn attribute user cn
    ssl-profile testProfile1
    authorization group policy basic-role-example
```

```

search username cn=ldap-admin-acct,OU=ServiceAccounts,O
U=Sample,dc=samplecompany,dc=com password 0 secretString
!
group policy basic-role-example
search filter objectclass group attribute member
group "Network Admin" role network-admin
group "Network Newbie" role network-operator
!
group policy company1
search filter objectclass group attribute member
group "Network Admin2" role network-admin
group "Network Newbie2" role network-operator
!

```

Use LDAP with the following configuration as a minimum.

```

aaa authentication login default group ldap
!
management ldap
server host <ldap server hostname/ip>
!
server defaults
base-dn <base distinguished name>
rdn attribute user <relative distinguished attribute name>
search username <full distinguished name> password <password>

```

The configuration sets up aaa authentication with LDAP. The LDAP server supports IPv4, IPv6, hostnames, and VRFs for specifying the address. The RDN , relative distinguished name, is typically an attribute/value pair to specify a user. When a user attempts to connect to the switch, the admin username searches recursively for the RDNs which match the passed-in username from the base-dn folder to generate a shortened list of potential DNS, which are then searched for a match with the provided password.

Configuring LDAP Authorization

Active Directory Server with LDAP Plug-in Configured

The file extract below configures the authorization for a user.

```

aaa authorization exec default group ldap
!
management ldap
server defaults
authorization group policy basic-role-example
!
group policy basic-role-example
search filter objectclass group attribute member
group "Network Admin" role network-admin
group "Network Newbie" role network-operator

```

The group / role maps an LDAP group to an EOS role for RBAC. The matching is done so that the first group that is matched against results in the role being mapped to the user. `before` and `after` commands are used to insert rules in the appropriate priority.

The LDAP admin account uses the `search filter` command to search for LDAP groups which contain the user, where `objectclass` defines the object which contains the LDAP group and `attribute` is the entry attribute name which contains the DN of the group member.

TLS Communication

LDAP supports TLS communication using SSL profiles. A trust certificate, or multiple intermediate certificates, is required to verify the root of trust of the LDAP server. The server will not be used for authentication if ssl profiles are configured and the server does not support TLS or fails x509 verification. Other ssl profiles supported commands are:

- fips restrictions
- crl
- tls version
- cipher-list

Active Directory Server with LDAP Plug-in Configured

The file extract below configures TLS communication.

```
management ldap
!
  server defaults
    ssl-profile testProfile
management security
  ssl profile testProfile
  trust certificate <root of trust>
```

8.1.1.3 Server Groups

A server group is a collection of servers that are associated with a single group name. Subsequent authorization and authentication commands can access all servers in a group by invoking the group name. The switch supports TACACS+ and RADIUS server groups.

The `aaa group server` commands create server groups and place the switch in a server-group configuration mode to assign servers to the group. Commands that reference an existing group place the switch in a server-group configuration mode to modify the group.

These commands create named server groups and enter the appropriate command mode for the specified group:

- [aaa group server radius](#)
- [aaa group server tacacs+](#)

The [server \(server-group-RADIUS configuration mode\)](#) commands add servers to the configuration mode server group. Servers must be previously configured with a [radius-server host](#) or [tacacs-server host](#) command before they are added to a group.

Examples

- This command creates the TACACS+ server group named “TAC-GR” and enters server-group configuration mode for the new group.

```
switch(config)#aaa group server tacacs+ TAC-GR
switch(config-sg-tacacs+-TAC-GR)#
```

- These commands add two servers to the “TAC-GR” server group. To add servers to this group, the switch must be in sg-tacacs+-TAC-GR configuration mode.

The CLI remains in server-group configuration mode after adding the “TAC-1” server (port 49) and the server located at 10.1.4.14 (port 151) to the group.

```
switch(config-sg-tacacs+-TAC-GR)#server TAC-1
switch(config-sg-tacacs+-TAC-GR)#server 10.1.4.14 port 151
switch(config-sg-tacacs+-TAC-GR)#
```

- This command exits server-group configuration mode.

```
switch(config-sg-tacacs+-TAC-GR) #exit
switch(config) #
```

- This command creates the RADIUS server group named “RAD-SV1” and enters server-group configuration mode for the new group.

```
switch(config) #aaa group server radius RAD-SV1
switch(config-sg-radius-RAD-SV1) #
```

- These commands add two servers to the “RAD-SV1” server group. To add servers to this group, the switch must be in sg-radius-RAD-SV1 configuration mode.

The CLI remains in server-group configuration mode after adding the RAC-1 server (authorization port 1812, accounting port 1813) and the server located at 10.1.5.14 (authorization port 1812, accounting port 1850) to the group.

```
switch(config-sg-radius-RAD-SV1) #server RAC-1
switch(config-sg-radius-RAD-SV1) #server 10.1.5.14 acct-port 1850
switch(config-sg-radius-RAD-SV1) #
```

8.1.1.4 Role-Based Authorization

Role-based authorization is a method of restricting access to CLI commands through the assignment of profiles, called “roles,” to user accounts. Each role consists of rules that permit or deny access to a set of commands within specified command modes.

All roles are accessible to the local security file through a `username` parameter and to remote users through RADIUS servers. Each role can be applied to multiple user accounts. Only one role may be applied to a user.

8.1.1.4.1 Role Types

The switch defines two types of roles: user-defined and built-in.

- User-defined roles are created and edited through CLI commands.
- Built-in roles are supplied with the switch and are not user-editable.

Built-in roles supplied by the switch are “network-operator” and “network-admin.”

8.1.1.4.2 Role Structure

A role is an ordered list of rules that restricts access to specified commands from users on whom it is applied. Roles consist of deny and permit rules. Each rule references a set of command modes and contains a regular expression that specifies one or more CLI commands. Commands are compared sequentially to the rules within a role until a rule’s regular expression matches the command.

- Commands that match a regular expression in a permit rule are executed.
- Commands that match a regular expression in a deny rule are disregarded.
- Commands that do not match a regular expression are evaluated against the next rule in the role.

Upon its entry in the CLI, a command is compared to the first rule of the role. Commands that match the rule are executed (permit rule) or disregarded (deny rule). Commands that do not match the rule are compared to the next rule. This process continues until the command either matches a rule or the rule list is exhausted. The switch disregards commands not matching any rule.

8.1.1.4.3 Role Rules

Role rules consist of four components: sequence number, filter type, mode expression, and command expression.

Sequence Number

The sequence number designates a rule's placement in the role. Sequence numbers range in value from 1 to 256. Rule commands that do not include a sequence number append the rule at the end of the list, deriving its sequence number by adding 10 to the sequence number of the last rule in the list.

Example

- These rules have sequence numbers 10 and 20.

```
10 deny mode exec command reload
20 deny mode config command (no |default )?router
```

Filter Type

The filter type specifies the disposition of matching commands. Filter types are permit and deny. Commands matching permit rules are executed. Commands matching deny rules are disregarded.

Example

- These rules are deny and permit rules, respectively.

```
10 deny mode exec command reload
20 permit mode config command interface
```

Mode Expression

The mode expression specifies the command mode under which the command expression is effective. The mode expression may be a regular expression or a designated keyword. Rules support the following mode expressions:

- **exec** EXEC and Privileged EXEC modes
- **config** Global Configuration Mode
- **config-all** All configuration modes, including Global Configuration Mode
- *short_name* short key name of a command mode (exact match)
- *long_name* long key name of a command mode (regular expression match of one or more modes)
- <no parameter> all command modes

The `prompt` command configures the CLI to display a configuration mode's key name:

- %P long key name
- %p short key name

Example

- These commands use the `prompt` command to display short key name (**if**) and long key name (**if-Et1**) for interface-ethernet 1.

```
switch(config)#prompt switch%p
switch(config)#interface ethernet 1
switch(config-if)#exit
switch(config)#prompt switch%P
switch(config)#interface ethernet 1
```

```
switch(config-if-Et1) #
```

The command supports the use of regular expressions to reference multiple command modes.

Example

These regular expressions correspond to the listed command modes:

- **if-Vlan(1|2)** matches interface-VLAN 1 or interface-VLAN 2
- **if** matches all interface modes
- **acl-text1** matches ACL configuration mode for “text1” ACL

Command Expression

The command expression is a regular expression that corresponds to one or more CLI commands.

Examples

These regular expressions correspond to the specified commands:

- **reload** reload command
- **(no |default)?router** commands that enter routing protocol configuration modes
- **(no |default)?(ip|mac) access-list** commands that enter ACL configuration modes
- **(no |default)?(ip|mac) access-group** commands that bind ACLs to interfaces
- **lacp|spanning-tree** LACP and STP commands
- **.*** all commands

8.1.1.4.4 Creating and Modifying Roles

This section contains the following topics:

- [Built-in Role](#)
- [Managing Roles](#)
- [Modifying Roles](#)

8.1.1.4.4.1 Built-in Role

The switch provides the following two built-in roles:

- **network-operator** Allows all commands in EXEC (Privileged) modes. Commands in all other modes are denied.
- **network-admin** Allows all CLI commands in all modes.

The **network-admin** role is typically assigned to the **admin** user to allow it to run any command.

Built-in roles are not editable.

Example

These **show users roles** commands display the contents of the built-in roles.

```
switch(config) #show users roles network-operator
The default role is network-operator
role: network-operator
    10 deny mode exec command bash|\|
    20 permit mode exec command .*
switch(config) #show users roles network-admin
The default role is network-operator
role: network-admin
    10 permit command .*
```

```
switch(config)#
```

8.1.1.4.4.2 Managing Roles

Creating and Opening a Role

Roles are created and modified in Role Configuration Mode. To create a role, enter the `role` command with the role's name. The switch enters Role Configuration Mode. If the command is followed by the name of an existing role, subsequent commands edit that role.

Example

This command places the switch in Role Configuration Mode to create a role named "sysuser."

```
switch(config)#role sysuser
switch(config-role-sysuser)#
```

Saving Role Changes

Role Configuration Mode is a group-change mode; changes are saved by exiting the mode.

Examples

- These commands create a role, then add a deny rule to the role. Because the changes are not yet saved, the role remains empty, as shown by `show users roles`.

```
switch(config)#role sysuser
switch(config-role-sysuser)#deny mode exec command reload
switch(config-role-sysuser)#show users roles sysuser
The default role is network-operator

switch(config-role-sysuser)#
```

To save all current changes to the role and exit role configuration mode, type `exit`.

```
switch(config-role-sysuser)#exit
switch(config)#show users roles sysuser
The default role is network-operator

role: sysuser
    10 deny mode exec command reload
switch(config)#
```



Note: After exiting role mode, `running-config` must be saved to `startup-config` to preserve role changes past system restarts.

Discarding Role Changes

The `abort` command exits Role Configuration Mode without saving pending changes.

Example

These commands enter Role Configuration Mode to add deny rules, but discard the changes before saving them to the role.

```
switch(config)#role sysuser
switch(config-role-sysuser)#deny mode exec command reload
switch(config-role-sysuser)#abort
```

```
switch(config)#show users roles sysuser
The default role is network-operator

switch(config)#
```

8.1.1.4.4.3 Modifying Roles

Adding Rules to a Role

The `deny (Role)` command adds a deny rule to the configuration mode role. The `permit (Role)` command adds a permit rule to the configuration mode role.

To append a rule to the end of a role, enter the rule without a sequence number while in Role Configuration Mode. The new rule's sequence number is derived by adding 10 to the last rule's sequence number.

Example

These commands enter the first three rules into a new role.

```
switch(config)#role sysuser
switch(config-role-sysuser)#deny mode exec command reload
switch(config-role-sysuser)#deny mode config command (no |default )?
router
switch(config-role-sysuser)#permit command .*
switch(config-role-sysuser)#exit
switch(config)#show users roles sysuser
The default role is network-operator

role: sysuser
    10 deny mode exec command reload
    20 deny mode config command (no |default )?router
    30 permit command .*
switch(config)#
```

Inserting a Rule

To insert a rule into a role, enter the rule with a sequence number between the existing rules numbers.

Example

This command inserts a rule between the first two rules by assigning it the sequence number 15.

```
switch(config)#role sysuser
switch(config-role-sysuser)#15 deny mode config-all command lACP
switch(config-role-sysuser)#exit
switch(config)#show users roles sysuser
The default role is network-operator

role: sysuser
    10 deny mode exec command reload
    15 deny mode config-all command lACP
    20 deny mode config command (no |default )router
    30 permit command .*
switch(config)#
```

Deleting a Rule

To remove a rule from the current role, perform one of these commands:

- Enter **no**, followed by the sequence number of the rule to be deleted.
- Enter **no**, followed by the rule to be deleted.
- Enter **default**, followed by the sequence number of the rule to be deleted.
- Enter **default**, followed by the rule to be deleted.

Example

These equivalent commands remove rule 30 from the list.

```
switch(config-role-sysuser) #no 30
switch(config-role-sysuser) #default 30
switch(config-role-sysuser) #no permit command .*

switch(config-role-sysuser) #default permit command .*
```

This role results from entering one of the preceding commands.

```
switch(config) #show users roles sysuser
The default role is network-operator

role: sysuser
    10 deny mode exec command reload
    15 deny mode config-all command lacp|spanning-tree
    20 deny mode config command (no |default )router
switch(config) #
```

Redistributing Sequence Numbers

Sequence numbers determine the order of the rules in a role. After a list editing session where existing rules are deleted and new rules are inserted between existing rules, the sequence number distribution may not be uniform. Redistributing rule numbers changes adjusts the sequence number of rules to provide a constant difference between adjacent rules. The [resequence \(Role\)](#) command adjusts the sequence numbers of role rules.

Example

The **resequence** command renumbers rules in the sysuser role. The sequence number of the first rule is 100; subsequent rules numbers are incremented by 20.

```
switch(config) #show users roles sysuser
The default role is network-operator

role: sysuser
    10 deny mode exec command reload
    20 deny mode config-all command lacp|spanning-tree
    25 deny mode config command (no |default )?router
    30 permit command .*
switch(config) #role sysuser
switch(config-role-sysuser) #resequence 100 20
switch(config-role-sysuser) #exit
switch(config) #show users roles sysuser
The default role is network-operator

role: sysuser
    100 deny mode exec command reload
    120 deny mode config-all command lacp|spanning-tree
    140 deny mode config command (no |default )?router
    160 permit command .*
switch(config) #
```

8.1.1.4.5 Assigning a Role to a Username

Roles are assigned to local users through the `username` command and to remote users through RADIUS servers. Each user is assigned one role. Each role can be assigned to multiple local and remote users.

8.1.1.4.5.1 Default Roles

Users that are not explicitly assigned a role are assigned the default role. The `aaa authorization policy local default-role` command designates the default role. The “network-operator” built-in role is the default role when the default role is not configured.

Examples

- These commands assign “sysuser” as the default role, then display the name of the default role.

```
switch(config)#aaa authorization policy local default-role sysuser
switch(config)#show users roles
The default role is sysuser

switch(config)#
```

- These commands restore “network-operator” as the default role by deleting the `aaa authorization policy local default-role` statement from *running-config*, then display the default role name.

```
switch(config)#no aaa authorization policy local default-role
switch(config)#show users roles
The default role is network-operator

switch(config)#
```

8.1.1.4.5.2 Local Security File (Username command)

Roles are assigned to users with the `username` command's `role` parameter. A username whose *running-config* `username` statement does not include a `role` parameter is assigned the default role.

The `role` parameter function in a command creating a username is different from its function in a command editing an existing name.

Assigning a Role to a New Username

A `username` command creating a username explicitly assigns a role to the username by including the `role` parameter; commands without a `role` parameter assigns the default role to the username.

Example

- These commands create two usernames. The first user is assigned a role; the second user assumes the default role.

```
switch(config)#username FRED secret 0 axced role sysuser1
switch(config)#username JANE nopassword
switch(config)#show running-config
<-----OUTPUT OMITTED FROM EXAMPLE----->
!
username FRED role sysuser1 secret 5 $1$dhJ6vrPV$PFOvJCX/vcqyIHV.vd.120
username JANE nopassword
!
<-----OUTPUT OMITTED FROM EXAMPLE----->
```

```
switch(config)#
```

Editing the Role of an Existing Username

The role of a previously configured username may be edited by a `username` command without altering its password. The role assignment of a username is not changed by `username` commands that do not include a `role` parameter.

Examples

- These commands assign a role to a previously configured username.

```
switch(config)#username JANE role sysuser2
switch(config)#show running-config

<-----OUTPUT OMITTED FROM EXAMPLE----->
!
username FRED role sysuser1 secret 5 $1$dhJ6vrPV$PFOvJCX/vcqyIHV.vd.120
username JANE role sysuser2 nopassword
!
<-----OUTPUT OMITTED FROM EXAMPLE----->
switch(config)#
```

- These commands reverts a username to the default role by removing its role assignment.

```
switch(config)#no username FRED role
switch(config)#show running-config

<-----OUTPUT OMITTED FROM EXAMPLE----->
!

username FRED secret 5 $1$dhJ6vrPV$PFOvJCX/vcqyIHV.vd.120
username JANE role sysuser2 nopassword
!
<-----OUTPUT OMITTED FROM EXAMPLE----->
switch(config)#
```

Displaying the Role Assignments

The `show users accounts` command displays role assignment of the configured users. The `show users detail` command displays roles of users that are currently logged into the switch.

Example

- This command displays the configured users and their role assignments.

```
switch(config)#show users accounts
user: FRED
    role: <unknown>
    privilege level: 1
user: JANE
    role: sysuser2
    privilege level: 1
user: admin
    role: network-admin
    privilege level: 1
switch(config)#
```

- This command displays information about the active AAA login sessions.

```
switch(config)# show aaa session
Session Username Roles          TTY   State Duration Auth      Remote Host
```

2	admin	network-operator	ttyS0	E	0:01:21	local	
4	Fred	sysadmin	telnet	E	0:02:01	local	sf.example.com
6	Jane	sysuser2	ssh	E	0:00:52	group radius	ny.example.com
9	admin	network-admin	ssh	E	0:00:07	local	bj.example.com
10	max	network-admin	telnet	E	0:00:07	local	sf.example.com

8.1.1.4.5.3 Radius Servers

A role can be assigned to a remote user authenticated through a RADIUS server. Roles are assigned through the vendor-specific attribute-value (AV) pair named "Arista-AVPair." The switch extracts the remote user's role upon a successful authentication when RADIUS authentication is enabled.

Example

This file extract is sample FreeRadius server code that includes the AV pair that assigns roles to three remote users.

```
# Sample RADIUS server users file
"Jane"
    Cleartext-Password := "Abc1235"
    Arista-AVPair = "shell:roles=sysuser2",
    Service-Type = NAS-Prompt-User
"Mary"
    Cleartext-Password := "xYz$2469"
    Arista-AVPair = "shell:roles=sysadmin",
    Service-Type = NAS-Prompt-User
"Fred"
    Cleartext-Password := "rjx4#222"
    Arista-AVPair = "shell:roles=network-operator",
    Service-Type = NAS-Prompt-User
```

The [aaa authentication login](#) command selects the user authentication service (see [Configuring Service Lists](#)).

Example

This command configures the switch to authenticate users through all RADIUS servers.

```
switch(config) #aaa authentication login default group radius
```

8.1.1.4.5.4 Enable Role-Based Access Control

To enable Role-Based Access Control on the switch, apply the following configuration:

```
switch(config) #aaa authorization commands all default local
```

8.1.1.5 Activating Security Services

After configuring the access databases, **aaa authentication**, **aaa authorization**, and **aaa accounting** commands designate active and backup services for handling access requests.

These sections describe the methods of selecting the database that the switch uses to authenticate users and authorize access to network resources.

8.1.1.5.1 Authenticating Usernames and the Enable Password

Service lists specify the services the switch uses to authenticates usernames and the enable password.

8.1.1.5.1.1 Service List Description

Service list elements are service options, ordered by their priority.

 **Note:** When the local file is one of the service list elements, any attempts to locally authenticate a username that is not included in the local file will result in the switch continuing to the next service list element.

Example

- This is an example service list for username authentication:
 1. Location_1 server group - specifies a server group (see [Server Groups](#)).
 2. Location_2 server group - specifies a server group.
 3. TACACS+ servers - specifies all hosts for which a `tacacs-server host` command exists.
 4. Local file - specifies the local file.
 5. None - specifies that no authentication is required - all access attempts succeed.

To authenticate a username, the switch checks Location_1 server group. If a server in the group is available, the switch authenticates the username through that group. Otherwise, it continues through the list until it finds an available service or utilizes option 5, which allows the access attempt to succeed without authentication.

8.1.1.5.1.2 Configuring Service Lists

Service lists are incorporated into these `aaa authentication` commands to specify services the switch uses to authenticate usernames and the enable password.

- `aaa authentication login` specifies services the switch uses to authenticate usernames
- `aaa authentication enable` specifies services the switch uses to authenticate the enable password

Examples

- This command configures the switch to authenticate usernames through the TAC-1 server group. The local database is the backup method if TAC-1 servers are unavailable.

```
switch(config)#aaa authentication login default group TAC-1 local
```

- This command configures the switch to authenticate usernames through all TACACS+ servers, then all RADIUS servers if the TACACS+ servers are not available. If the RADIUS servers are unavailable, the switch does not authenticate any login attempts.

```
switch(config)#aaa authentication login default group tacacs+ group
radius none
```

- This command configures the switch to authenticate the enable password through all TACACS+ servers, then through the local database if the TACACS+ servers are unavailable.

```
switch(config)#aaa authentication enable default group TACACS+ local
```

8.1.1.5.2 Authorization

Authorization commands control EOS shell access, CLI command access, and configuration access through the console port. The switch also supports role-based authorization, which allows access to specified CLI commands by assigning command profiles (or roles) to usernames. See [Role-Based Authorization](#) for details.

During the exec authorization process, TACACS+ server responses may include attribute-value (AV) pairs. The switch recognizes the mandatory AV pair named “priv-lvl=x” (where x is between 0 and 15).

By default, a TACACS+ server that sends any other mandatory AV pair is denied access to the switch. The receipt of optional AV pairs by the switch has no affect on decisions to permit or deny access to the TACACS+ server. The [tacacs-server policy](#) command programs the switch to allow access to TACACS+ servers that send unrecognized mandatory AV pairs.

Authorization to switch services is configured by the following **aaa authorization** commands.

- To specify the method of authorizing the opening of an EOS shell, enter [aaa authorization exec](#) .
- To specify the method of authorizing CLI commands, enter [aaa authorization commands](#) .

Examples

- This command specifies that TACACS+ servers authorize users attempting to open a CLI shell.

```
switch(config)#aaa authorization exec default group tacacs+
```

- This command programs the switch to authorize configuration commands (privilege level 15) through the local file and to deny command access to users not listed in the local file.

```
switch(config)#aaa authorization commands all default local
```

- This command programs the switch to permit all commands entered on the CLI.

```
switch(config)#aaa authorization commands all default none
```

- This command configures the switch to permit access to TACACS+ servers that send unrecognized mandatory AV pairs.

```
switch(config)#tacacs-server policy unknown-mandatory-attribute ignore
```

All commands are typically authorized through [aaa authorization commands](#). However, the **no aaa authorization config-commands** command disables the authorization of configuration commands. In this state, authorization to execute configuration commands can be managed by controlling access to global configuration commands. The default setting authorizes configuration commands through the policy specified for all other commands.

- To enable the authorization of configuration commands with the policy specified for all other commands, enter [aaa authorization config-commands](#).
- To require authorization of commands entered on the console, enter [aaa authorization serial-console](#) .

By default, EOS does not verify authorization of commands entered on the console port.

Examples

- This command disables the authorization of configuration commands.

```
switch(config)#no aaa authorization config-commands
```

- This command enables the authorization of configuration commands.

```
switch(config)#aaa authorization config-commands
```

- This command configures the switch to authorize commands entered on the console, using the method specified through a previously executed **aaa authorization** command.

```
switch(config)#aaa authorization serial-console
```

8.1.1.5.3 Accounting

The accounting service collects information for billing, auditing, and reporting. The switch supports TACACS+ and RADIUS accounting by reporting user activity to either the TACACS+ server or RADIUS server in the form of accounting records.

The switch supports two types of accounting:

- EXEC: Provides information about user CLI sessions.
- Commands: Command authorization for all commands, including configuration commands that are associated with a privilege level.

The accounting mode determines when accounting notices are sent. Mode options include:

- start-stop: a *start* notice is sent when a process begins; a *stop* notice is sent when it ends.
- stop-only: a *stop* accounting record is generated after a process successfully completes.

Accounting is enabled by the `aaa accounting` command.

Examples

- This command configures the switch to maintain start-stop accounting records for all commands executed by switch users and submits them to all TACACS+ hosts.

```
switch(config)#aaa accounting commands all default start-stop group tacacs+
```

- This command configures the switch to maintain stop accounting records for all user EXEC sessions performed through the console and submits them to all TACACS+ hosts.

```
switch(config)#aaa accounting exec console stop group tacacs+
```

8.1.1.6 TACACS+ Configuration Examples

These sections describe two sample TACACS+ host configurations.

8.1.1.6.1 Single Host Configuration

The example single host configuration consists of a TACACS+ server with these attributes:

- IP address: 10.1.1.10
- encryption key: example_1
- port number: 49 (global default)
- timeout: 5 seconds (global default)

The switch authenticates the username and enable command against all TACACS+ servers which, in this case, is one host. If the TACACS+ server is unavailable, the switch authenticates with the local file.

1. This step configures TACACS+ server settings â€” port number and timeout are global defaults.

```
switch(config)#tacacs-server host 10.1.1.10 key example_1
```

2. This step configures the login authentication service.

```
switch(config)#aaa authentication login default group tacacs+ local
```

3. This step configures the `enable` command password authentication service.

```
switch(config)#aaa authentication enable default group tacacs+ local
```

8.1.1.6.2 Multiple Host Configuration

The example multiple host configuration consists of three TACACS+ servers at these locations:

- IP address 10.1.1.2 - port 49
- IP address 172.16.4.12 - port 4900
- IP address 192.168.2.10 - port 49

The configuration combines the servers into these server groups:

- **Bldg_1** group consists of the servers at 10.1.1.2 and 172.16.4.12
- **Bldg_2** group consists of the servers at 192.168.2.10

All servers use these global TACACS+ defaults:

- encryption key - example_2
- timeout - 10 seconds

The switch authenticates these access methods:

- username access against **Bldg_1** group then, if they are not available, against the local file.
- enable command against **Bldg_2** group, then **Bldg_1** group, then against the local file.

1. TACACS+ Host commands:

These commands configure the IP address and ports for the three TACACS+ servers. The port for the first and third server is default 49.

```
switch(config)#tacacs-server host 10.1.1.12
switch(config)#tacacs-server host 172.16.4.12 port 4900
switch(config)#tacacs-server host 192.168.2.10
```

2. Global Configuration Commands:

These commands configure the global encryption key and timeout values.

```
switch(config)#tacacs-server key example_2
switch(config)#tacacs-server timeout 10
```

3. Group Server Commands:

The **aaa group server** commands create the server groups and place the CLI in server group configuration mode, during which the servers are placed in the group. The port number must be included if it is not the default port, as in the line that adds 192.168.1.1.

```
switch(config)#aaa group server tacacs+ Bldg_1
switch(config-sg-tacacs+-Bldg_1)#server 10.1.1.2
switch(config-sg-tacacs+-Bldg_1)#server 192.168.1.1 port 4900
switch(config-sg-tacacs+-Bldg_1)#exit
switch(config)#aaa group server tacacs+ Bldg_2
switch(config-sg-tacacs+-Bldg_2)#server 192.168.2.2
switch(config-sg-tacacs+-Bldg_2)#exit
switch(config)#
```

4. Login and enable configuration authentication responsibility commands:

These commands configure the username and enable command password authentication services.

```
switch(config)#aaa authentication login default group Bldg_1 local
switch(config)#aaa authentication enable default group Bldg_1 group
Bldg_2 local
```

8.1.1.7 AAA Commands

Local Security File Commands

- `aaa root`
- `enable password`
- `show privilege`
- `show users`
- `show users accounts`
- `username`
- `username ssh-key`

Accounting, Authentication, and Authorization Commands

- `aaa accounting`
- `aaa accounting dot1x`
- `aaa accounting system`
- `aaa authentication dot1x`
- `aaa authentication enable`
- `aaa authentication login`
- `aaa authentication policy local allow-nopassword-remote-login`
- `aaa authentication policy log`
- `aaa authorization commands`
- `aaa authorization config-commands`
- `aaa authorization exec`
- `aaa authorization policy local default-role`
- `aaa authorization serial-console`
- `clear aaa counters`
- `clear aaa counters radius`
- `clear aaa counters tacacs+`
- `show aaa`
- `show aaa counters`
- `show aaa methods`
- `show management ldap`
- `show users detail`

Server (RADIUS and TACACS+) Configuration Commands

- `ip radius source-interface`
- `ip tacacs source-interface`
- `radius-server deadline`
- `radius-server host`
- `radius-server key`
- `radius-server retransmit`
- `radius-server timeout`
- `show radius`
- `show tacacs`
- `tacacs-server host`
- `tacacs-server key`
- `tacacs-server policy`
- `tacacs-server timeout`

Server Group Configuration Commands

- `aaa group server radius`
- `aaa group server tacacs+`
- `server` (server-group-RADIUS configuration mode)
- `server` (server-group-TACACS+ configuration mode)

Role-Based Authorization Configuration Commands

- `deny` (Role)
- `no <sequence number>` (Role)
- `permit` (Role)
- `resequence` (Role)
- `role`
- `show users roles`

8.1.1.7.1 aaa accounting dot1x

The **aaa accounting dot1x** command enables the accounting of requested 802.1X services for network access.

The **no aaa accounting dot1x** and **default aaa accounting dot1x** commands disable the specified method list by removing the corresponding **aaa accounting dot1x** command from *running-config*.

Command Mode

Global Configuration

Command Syntax

```
aaa accounting dot1x default[ METHOD_1][METHOD_2] ... [METHOD_N]
```

```
no aaa accounting dot1x default
```

```
default aaa accounting dot1x default
```

Parameters

- **MODE** accounting mode that defines when accounting notices are sent. Options include:
 - **start-stop** a *start* notice is sent when a process begins; a *stop* notice is sent when it ends.
- **METHOD_X** server groups (methods) to which the switch can send accounting records. The switch sends the method list to the first listed group that is available.

Parameter value is not specified if **MODE** is set to **none**. If **MODE** is not set to **none**, the command must provide at least one method. Each method is composed of one of the following:

- **group name** the server group identified by *name*.
 - **group radius** server group that includes all defined RADIUS hosts.
 - **logging** server group that includes all defined TACACS+ hosts.

Examples

- This example configures IEEE 802.1X accounting on the switch.

```
switch(config)#aaa accounting dot1x default start-stop group
radius
switch(config)#
```

- This example disables IEEE 802.1X accounting on the switch.

```
switch(config)#no aaa accounting dot1x default
switch(config)#
```

8.1.1.7.2 aaa accounting system

The **aaa accounting system** command performs accounting for all system-level events.

The **no aaa accounting system** and **default aaa accounting system** commands clear the specified method list by removing the corresponding **aaa accounting system** command from *running-config*.

Command Mode

Global Configuration

Command Syntax

```
aaa accounting system default [METHOD_1][METHOD_2] ... [METHOD_N]
```

```
no aaa accounting system default
```

```
default aaa accounting system default
```

Parameters

- **MODE** accounting mode that defines when accounting notices are sent. Options include:
 - **none** no notices are sent.
 - **start-stop** a *start* notice is sent when a process begins; a *stop* notice is sent when it ends.
 - **stop-only** a *stop* accounting record is generated after a process successfully completes.
- **METHOD_X** server groups (methods) to which the switch can send accounting records. The switch sends the method list to the first listed group that is available.

Parameter value is not specified if **MODE** is set to **none**. If **MODE** is not set to **none**, the command must provide at least one method. Each method is composed of one of the following:

- **group name** the server group identified by *name*.
 - **group radius** server group that includes all defined RADIUS hosts.
 - **group tacacs+** server group that includes all defined TACACS+ hosts.
 - **logging** server group that includes all defined TACACS+ hosts.

Examples

- This command configures AAA accounting to not use any accounting methods for system events.

```
switch(config)#aaa accounting system default none
switch(config)#
```

- This command configures the switch to maintain stop accounting records for system events to all defined RADIUS hosts.

```
switch(config)#aaa accounting system default stop-only group
radius
switch(config)#
```

8.1.1.7.3 aaa accounting

The **aaa accounting** command configures accounting method lists for a specified authorization type. Each list consists of a prioritized list of methods. The accounting module uses the first available listed method for the authorization type.

The **no aaa accounting** and **default aaa accounting** commands clear the specified method list by removing the corresponding **aaa accounting** command from *running-config*.

Command Mode

Global Configuration

Command Syntax

```
aaa accounting TYPE CONNECTION MODE [METHOD_1][METHOD_2] ... [METHOD_N]
```

```
no aaa accounting TYPE CONNECTION
```

```
default aaa accounting TYPE CONNECTION
```

Parameters

- **TYPE** authorization type for which the command specifies a method list. Options include:
 - **EXEC** records user authentication events.
 - **COMMANDS ALL** records all entered commands.
 - **COMMANDS level** records entered commands of the specified *level* (ranges from 0 to 15).
- **CONNECTION** connection type of sessions for which method lists are reported. Options include:
 - **console** console connection.
 - **default** all connections not covered by other command options.
- **MODE** accounting mode that defines when accounting notices are sent. Options include:
 - **none** no notices are sent.
 - **start-stop** a *start* notice is sent when a process begins; a *stop* notice is sent when it ends.
 - **stop-only** a *stop* accounting record is generated after a process successfully completes.
- **METHOD_X** server groups (methods) to which the switch can send accounting records. The switch sends the method list to the first listed group that is available.

Parameter value is not specified if **MODE** is set to **none**. If **MODE** is not set to **none**, the command must provide at least one method. Each method is composed of one of the following:

- **group name** the server group identified by *name*.
 - **group radius** server group that includes all defined RADIUS hosts.
 - **group tacacs+** server group that includes all defined TACACS+ hosts.
 - **logging** log all accounting messages to syslog.

Examples

- This command configures the switch to maintain start-stop accounting records for all commands executed by switch users and submits them to all TACACS+ hosts.

```
switch(config)#aaa accounting commands all default start-stop
group tacacs+
switch(config)#
```

- This command configures the switch to maintain stop accounting records for all user EXEC sessions performed through the console and submits them to all TACACS+ hosts.

```
switch(config)#aaa accounting exec console stop group tacacs+
```

```
switch(config)#
```

- This command configures the switch to maintain start-stop accounting records for all commands executed by switch users and submits them to all TACACS+ hosts.

```
switch(config)#aaa accounting commands all default start-stop  
group tacacs+  
switch(config)#
```

- This command configures the switch to maintain stop accounting records for all user EXEC sessions performed through the console and submits them to all TACACS+ hosts.

```
switch(config)#aaa accounting exec console stop group tacacs+  
switch(config)#
```

8.1.1.7.4 aaa authentication dot1x

The **aaa authentication dot1x** command configures the default authentication list of requested 802.1X services for network access.

The **no aaa authentication dot1x** and **default aaa authentication dot1x** commands remove the default authentication list for IEEE 802.1X.

Command Mode

Global Configuration

Command Syntax

```
aaa authentication dot1x default group {group_name | radius}
```

```
no aaa authentication dot1x default
```

```
default aaa authentication dot1x
```

Parameters

- **default** configures the default authentication list of requested 802.1X services for network access
- **group** configures server group
- **group_name** server group name; multiple group names can be entered in a single command
- **radius** list of all defined RADIUS hosts

Examples

- This command configures the switch in the auth1 group for IEEE 802.1X authentication.

```
switch(config)#aaa authentication dot1x default group auth1
switch(config)#
```

8.1.1.7.5 aaa authentication enable

The **aaa authentication enable** command configures the service list that the switch references to authorize access to Privileged EXEC command mode.

The list consists of a prioritized list of service options. Available service options include:

- a named server group
- all defined TACACS+ hosts
- all defined RADIUS hosts
- local authentication
- no authentication

The switch authorizes access by using the first listed service option that is available. When the local file is a service list element, attempts to locally authenticate a username that is not in the local file result in the switch continuing to the next service list element.

When the list is not configured, it is set to **local**.

The **no aaa authentication enable** and **default aaa authentication enable** commands revert the list configuration as **local** by removing the **aaa authentication enable** command from *running-config*.

Command Mode

Global Configuration

Command Syntax

```
aaa authentication enable default METHOD_1 [METHOD_2] ... [METHOD_N]
```

```
no aaa authentication enable default
```

```
default aaa authentication enable default
```

Parameters

- **METHOD_X** authentication service method list. The command must provide at least one method. Each method is composed of one of the following:
 - **group name** the server group identified by *name*.
 - **group radius** a server group that consists of all defined RADIUS hosts.
 - **group tacacs+** a server group that consists of all defined TACACS+ hosts.
 - **local** local authentication.
 - **none** users are not authenticated; all access attempts succeed.

Example

- This command configures the switch to authenticate the enable password through all configured TACACS+ servers. Local authentication is the backup if TACACS+ servers are unavailable.

```
switch(config)#aaa authentication default enable group TACACS+
local
switch(config)#
```

8.1.1.7.6 aaa authentication login

The **aaa authentication login** command configures service lists the switch references to authenticate usernames. Service lists consist of service options ordered by usage priority. The switch authenticates usernames through the first available service option. Supported service options include:

- a named server group
- all defined TACACS+ hosts
- all defined RADIUS hosts
- local authentication
- no authentication

When the local file is a service list element, attempts to locally authenticate a username that is not in the local file result in the switch continuing to the next service list element.

The switch supports a **console** list for authenticating usernames through the console and a default list for authenticating usernames through all other connections.

- When the **console** list is not configured, the console connection uses the **default** list.
- When the **default** list is not configured, it is set to *local*.

The **no aaa authentication login** and **default aaa authentication login** commands revert the specified list configuration to its default by removing the corresponding **aaa authentication login** command from *running-config*.

Command Mode

Global Configuration

Command Syntax

```
aaa authentication login CONNECTION SERVICE_1 [SERVICE_2] ... [SERVICE_N]
```

```
no aaa authentication login CONNECTION
```

```
default aaa authentication login CONNECTION
```

Parameters

- **CONNECTION** connection type of sessions for which authentication list is used
 - **default** the default authentication list
 - **console** the authentication list for console logins
- **SERVICE_X** an authentication service. Settings include:
 - **group name** identifies a previously defined server group
 - **group radius** a server group that consists of all defined RADIUS hosts
 - **group tacacs+** a server group that consists of all defined TACACS+ hosts
 - **local** local authentication
 - **none** The switch does not perform authentication. All access attempts succeed.

Examples

- This command configures the switch to authenticate usernames through the TAC-1 server group. The local database is the backup method if TAC-1 servers are unavailable.

```
switch(config)#aaa authentication login default group TAC-1
local
switch(config)#
```

- This command configures the switch to authenticate usernames through all TACACS+ servers, then all RADIUS servers if the TACACS+ servers are not available. If the

RADIUS servers are also unavailable, the switch allows access to all login attempts without authentication.

```
switch(config)#aaa authentication login default group tacacs+  
group radius none  
switch(config)#
```

8.1.1.7.7 aaa authentication policy local allow-nopassword-remote-login

The **aaa authentication policy local allow-nopassword-remote-login** command permits usernames without passwords to log in from any port. The default switch setting only allows unprotected usernames to log in from the console.

The **no aaa authentication policy local allow-nopassword-remote-login** and **default aaa authentication policy local allow-nopassword-remote-login** commands return the switch to the default setting of allowing unprotected usernames to log in only from the console.

Command Mode

Global Configuration

Command Syntax

```
aaa authentication policy local allow-nopassword-remote-login
```

```
no aaa authentication policy local allow-nopassword-remote-login
```

```
default aaa authentication policy local allow-nopassword-remote-login
```

Examples

- This command configures the switch to allow unprotected usernames to log in from any port.

```
switch(config)#aaa authentication policy local allow-nopassw  
ord-remote-login  
switch(config)#
```

- This command configures the switch to allow unprotected usernames to log in only from the console port.

```
switch(config)#no aaa authentication policy local allow-  
nopassword-remote-login  
switch(config)#
```

8.1.1.7.8 aaa authentication policy log

The **aaa authentication policy log** command configures the switch to generate syslog messages for login authentication success or failure events.

The **no aaa authentication policy log** and the **default aaa authentication policy log** commands restore the default behavior of not generating syslog messages for these events.

Command Mode

Global Configuration

Command Syntax

```
aaa authentication policy {on-failure | on-success} log
no aaa authentication policy {on-failure | on-success} log
default aaa authentication policy {on-failure | on-success} log
```

Parameters

- **on-failure** generates syslog messages for failed login events.
- **on-success** generates syslog messages for successful login events.

Examples

This command configures the switch to log successful and failed login attempts.

```
switch(config)#aaa authentication policy on-success log
switch(config)#aaa authentication policy on-failure log
```

8.1.1.7.9 aaa authorization commands

The **aaa authorization commands** command configures the service list that authorizes CLI command access. All switch commands are assigned a privilege level that corresponds to the lowest level command mode from which it can be executed:

- Level 1: Commands accessible from EXEC mode.
- Level 15: Commands accessible from any mode except EXEC.

Command usage is authorized for each privilege level specified in the command.

The list consists of a prioritized list of service options. The switch authorizes access by using the first listed service option that is available. The available service options include:

- a named server group
- all defined TACACS+ hosts
- all defined RADIUS hosts
- local authorization
- no authorization

The list is set to **none** for all unconfigured privilege levels, allowing all CLI access attempts to succeed.

The **no aaa authorization commands** and **default aaa authorization commands** commands revert the list contents to **none** for the specified privilege levels.

Command Mode

Global Configuration

Command Syntax

```
aaa authorization commands PRIV default SERVICE_1[SERVICE_2] ... [SERVICE_N]
```

```
no aaa authorization commands PRIV default
```

```
default aaa authorization commands PRIV default
```

Parameters

- **PRIV** Privilege levels of the commands. Options include:
 - **level** numbers from **0** and **15**. Number, range, comma-delimited list of numbers and ranges.
 - **all** commands of all levels.
- **SERVICE_X** Authorization service. Command must list at least one service. Options include:
 - **group name** the server group identified by *name*.
 - **group tacacs+** a server group that consists of all defined TACACS+ hosts.
 - **local** local authorization.
 - **none** the switch does not perform authorization. All access attempts succeed.

Examples

- This command authorizes configuration commands (privilege level 15) through the local file. The switch denies command access to users not listed in the local file.

```
switch(config)#aaa authorization commands all default local
switch(config)#
```

- This command authorizes all commands entered on the CLI.

```
switch(config)#aaa authorization commands all default none
```

```
switch(config)#
```

8.1.1.7.10 aaa authorization config-commands

The **aaa authorization config-commands** command enables authorization of commands in any configuration mode, such as Global Configuration and all interface configuration modes. Commands are authorized through the policy specified by the **aaa authorization commands** setting. Authorization is enabled by default, so issuing this command has no effect unless **running-config** contains the **no aaa authorization config-commands** command.

The **no aaa authorization config-commands** command disables configuration command authorization. When configuration command authorization is disabled, **running-config** contains the **no aaa authorization config-commands** command. The **default aaa authorization config-commands** command restores the default setting by removing the **no aaa authorization config-commands** from **running-config**.

Command Mode

Global Configuration

Command Syntax

```
aaa authorization config-commands
no aaa authorization config-commands
default aaa authorization config-commands
```

Example

- This command disables the authorization of configuration commands.

```
switch(config)#no aaa authorization config-commands
switch(config)#
```

- This command enables the authorization of configuration commands.

```
switch(config)#aaa authorization config-commands
switch(config)#
```

8.1.1.7.11 aaa authorization exec

The **aaa authorization exec** command configures the service list that the switch references to authorize access to open an EOS CLI shell.

The list consists of a prioritized list of service options. The switch authorizes access by using the first listed service option to which the switch can connect. When the switch cannot communicate with an entity that provides a specified service option, it attempts to use the next option in the list.

The available service options include:

- a named server group
- all defined TACACS+ hosts
- all defined RADIUS hosts
- local authentication
- no authentication

When the list is not configured, it is set to **none**, allowing all CLI access attempts to succeed.

The **no aaa authorization exec** and **default aaa authorization exec** commands set the list contents to **none**.

Command Mode

Global Configuration

Command Syntax

```
aaa authorization exec default METHOD_1[METHOD_2] ... [METHOD_N]
```

```
no aaa authorization exec default
```

```
default aaa authorization exec default
```

Parameters

- **METHOD_X** authorization service (method). The switch uses the first listed available method.

The command must provide at least one method. Each method is composed of one of the following:

- **group name** the server group identified by *name*.
 - **group radius** a server group that consists of all defined RADIUS hosts.
 - **group tacacs+** a server group that consists of all defined TACACS+ hosts.
 - **local** local authentication.
 - **none** the switch does not perform authorization. All access attempts succeed.

Guidelines

During the exec authorization process, the TACACS+ server response may include attribute-value (AV) pairs. The switch recognizes **priv-lvl=x** (where **x** is an integer between 0 and 15), which is a mandatory AV pair. A TACACS+ server that sends any other mandatory AV pair is denied access to the switch. The receipt of optional AV pairs by the switch has no affect on decisions to permit or deny access to the TACACS+ server.

Example

- This command specifies that the TACACS+ servers authorize users that attempt to open an EOS CLI shell.

```
switch(config)#aaa authorization exec default group tacacs+
switch(config)#
```

8.1.1.7.12 aaa authorization policy local default-role

The **aaa authorization policy local** command specifies the name of the default role. A role is a data structure that supports local command authorization through its assignment to user accounts. Roles consist of permit and deny rules that define authorization levels for specified commands. Applying a role to a username authorizes the user to execute commands specified by the role.

The default role is assigned to the following users:

- local or remote users assigned to a role that is not configured.
- local users to whom a role is not assigned.

When the default-role is not specified, **network-operator** is assigned to qualified users as the default role. The network-operator role authorizes assigned users access to all CLI commands in EXEC and Privileged EXEC modes.

The **no aaa authentication policy local default-role** and **default aaa authentication policy local default-role** commands remove the **authentication policy local default-role** statement from *running-config*. Removing this statement restores **network-operator** as the default role.

Command Mode

Global Configuration

Command Syntax

```
aaa authorization policy local default-role role_name
no aaa authorization policy local default-role
default aaa authorization policy local default-role
```

Parameters

- **role_name** Name of the default role.

Related Commands

The [role](#) command places the switch in role configuration mode for creating and editing roles.

Examples

- This command configures the sysuser as the default role.

```
switch(config)#aaa authorization policy local default-role
  sysuser
switch(config)#
```

- This command restores **network-operator** as the default role.

```
switch(config)#no aaa authorization policy local default-role
switch(config)#
```

- This command displays the contents of the **network-operator** role.

```
switch#show users roles network-operator
The default role is network-operator
role: network-operator
      10 deny mode exec command bash|\|
      20 permit mode exec command .*
switch#
```

8.1.1.7.13 aaa authorization serial-console

The **aaa authorization serial-console** command configures the switch to authorize commands entered through the console. By default, commands entered through the console do not require authorization.

The **no aaa authorization serial-console** and **default aaa authorization serial-console** commands restore the default setting.

Command Mode

Global Configuration

Command Syntax

```
aaa authorization serial-console
no aaa authorization serial-console
default aaa authorization serial-console
```

Example

- This command configures the switch to authorize commands entered on the console, using the method specified through a previously executed [aaa authorization commands](#) command.

```
switch(config)#aaa authorization serial-console
switch(config)#
```

8.1.1.7.14 aaa group server radius

The **aaa group server radius** command enters the Server-group-RADIUS Configuration Mode for the specified group name. The command creates the specified group if it was not previously created. Commands are available to add servers to the group.

A server group is a collection of servers that are associated with a single label. Subsequent authorization and authentication commands access all servers in a group by invoking the group name. Server group members must be previously configured with a [radius-server host](#) command.

The **no aaa group server radius** and **default aaa group server radius** commands delete the specified server group from *running-config*.

Command Mode

Global Configuration

Command Syntax

```
aaa group server radius group_name
no aaa group server radius group_name
default aaa group server radius group_name
```

Parameters

- **group_name** name (text string) assigned to the group. Cannot be identical to a name already assigned to a TACACS+ server group.

Commands Available in Server-group-RADIUS Configuration Mode

- [server](#) (server-group-RADIUS configuration mode)

Related Commands

- [aaa group server tacacs+](#)

Example

- This command creates the RADIUS server group named RAD-SV1 and enters Server-group-RADIUS Configuration Mode for the new group.

```
switch(config)#aaa group server radius RAD-SV1
switch(config-sg-radius-RAD-SV1)#
```

8.1.1.7.15 aaa group server tacacs+

The **aaa group server tacacs+** command enters Server-group-TACACS+ Configuration Mode for the specified group name. The command creates the specified group if it was not previously created. Commands are available to add servers to the group.

A server group is a collection of servers that are associated with a single label. Subsequent authorization and authentication commands access all servers in a group by invoking the group name. Server group members must be previously configured with a [tacacs-server host](#) command.

The **no aaa group server tacacs+** and **default aaa group server tacacs+** commands delete the specified server group from *running-config*.

Command Mode

Global Configuration

Command Syntax

```
aaa group server tacacs+ group_name
no aaa group server tacacs+ group_name
default aaa group server tacacs+ group_name
```

Parameters

group_name name (text string) assigned to the group. Cannot be identical to a name already assigned to a RADIUS server group.

Commands Available in Server-group-TACACS+ Configuration Mode

[server](#) (server-group-TACACS+ configuration mode)

Related Command

[aaa group server radius](#)

Example

This command creates the TACACS+ server group named TAC-GR and enters Server-group-TACACS+ Configuration Mode for the new group.

```
switch(config)#aaa group server tacacs+ TAC-GR
switch(config-sg-tacacs+-TAC-GR)#
```

8.1.1.7.16 aaa root

The `aaa root` command specifies the password security level for the root account and can assign a password to the account.

The `no aaa root` and `default aaa root` commands disable the root account by removing the `aaa root` command from *running-config*. The root account is disabled by default.

Command Mode

Global Configuration

Command Syntax

```
aaa root SECURITY_LEVEL [ENCRYPT_TYPE] [password]
```

```
no aaa root
```

```
default aaa root
```

Parameters

- **SECURITY_LEVEL** password assignment level. Settings include
 - **secret** the root account is assigned to the password.
 - **nopassword** the root account is not password protected.
- **ENCRYPT_TYPE** encryption level of the *password* parameter. This parameter is present only when **SECURITY_LEVEL** is **secret**. Settings include:
 - `<no parameter>` the password is entered as clear text.
 - **0** the password is entered as clear text. Equivalent to `<no parameter>`.
 - **5** the password is entered as an MD5-encrypted string.
 - **sha512** the password is entered as an SHA-512-encrypted string.
- *password* text that authenticates the username. The command includes this parameter only if **SECURITY_LEVEL** is **secret**.
 - *password* must be in clear text if **ENCRYPT_TYPE** specifies clear text.
 - *password* must be an appropriately encrypted string if **ENCRYPT_TYPE** specifies encryption.

Encrypted strings entered through this parameter are generated elsewhere.

Examples

- These equivalent commands assign **f4980** as the root account password.

```
switch(config)#aaa root secret f4980
switch(config)#aaa root secret 0 f4980
```

- This command assigns the text (ab234) that corresponds to the encrypted string of \$1\$HW05LEY8\$QEVw6JqjD9VqDfh.O8r.b. as the root password.

```
switch(config)#aaa root secret 5 $1$HW05LEY8$QEVw6JqjD9VqDf
h.O8r.b
switch(config)#
```

- This command removes the password from the root account.

```
switch(config)#aaa root nopassword
switch(config)#
```

- This command disables the root login.

```
switch(config)#no aaa root
```

```
switch(config)#
```

8.1.1.7.17 clear aaa counters radius

The **clear aaa counters radius** command resets the counters that track the statistics for the RADIUS servers that the switch accesses. The **show radius** command displays the counters reset by the **clear aaa counters radius** command.

Command Mode

Privileged EXEC

Command Syntax

```
clear aaa counters radius
```

Example

These commands display the effect of the **clear aaa counters radius** command on the RADIUS counters.

```
switch#show radius
RADIUS server          : radius/10
  Connection opens:    204
  Connection closes:   0
  Connection disconnects: 199
  Connection failures: 10
  Connection timeouts: 2
  Messages sent:       1490
  Messages received:   1490
  Receive errors:      0
  Receive timeouts:   0
  Send timeouts:       0

Last time counters were cleared: never
switch#clear aaa counters radius
switch#show radius
RADIUS server          : radius/10
  Connection opens:    0
  Connection closes:   0
  Connection disconnects: 0
  Connection failures: 0
  Connection timeouts: 0
  Messages sent:       0
  Messages received:   0
  Receive errors:      0
  Receive timeouts:   0
  Send timeouts:       0

Last time counters were cleared: 0:00:03 ago
switch#
```

8.1.1.7.18 clear aaa counters tacacs+

The **clear aaa counters tacacs+** command resets the counters that track the statistics for the TACACS+ servers that the switch accesses. The **show tacacs** command displays the counters reset by the **clear aaa counters tacacs+** command.

Command Mode

Privileged EXEC

Command Syntax

```
clear aaa counters tacacs+
```

Example

- These commands display the effect of the **clear aaa counters tacacs+** command on the tacacs+ counters.

```
switch#show tacacs
TACACS+ server          : tacacs/49
  Connection opens:      15942
  Connection closes:     7
  Connection disconnects: 1362
  Connection failures:   0
  Connection timeouts:   0
  Messages sent:         34395
  Messages received:     34392
  Receive errors:        0
  Receive timeouts:     2
  Send timeouts:         0

Last time counters were cleared: never

TACACS+ source-interface: Enabled
  TACACS+ outgoing packets will be sourced with an IP address
  associated with the
  Loopback0 interface
switch#clear aaa counters tacacs+
switch#show tacacs
TACACS+ server          : tacacs/49
  Connection opens:      0
  Connection closes:     0
  Connection disconnects: 0
  Connection failures:   0
  Connection timeouts:   0
  Messages sent:         0
  Messages received:     0
  Receive errors:        0
  Receive timeouts:     0
  Send timeouts:         0

Last time counters were cleared: 0:00:03 ago
switch#

TACACS+ source-interface: Enabled
  TACACS+ outgoing packets will be sourced with an IP address
  associated with the
  Loopback0 interface
switch#
```

8.1.1.7.19 clear aaa counters

The **clear aaa counters** command resets the counters that track the number of service transactions performed by the switch since the last time the counters were reset. The [show aaa counters](#) command displays the counters reset by the **clear aaa counters** command.

Command Mode

Privileged EXEC

Command Syntax

```
clear aaa counters [SERVICE_TYPE]
```

Example

- These commands display the effect of the **clear aaa counters** command on the AAA counters.

```
switch#clear aaa counters
switch#show aaa counters
Authentication
    Successful:          0
    Failed:              0
    Service unavailable: 0

Authorization
    Allowed:             1
    Denied:              0
    Service unavailable: 0

Accounting
    Successful:          0
    Error:               0
    Pending:             0

Last time counters were cleared: 0:00:44 ago
```

8.1.1.7.20 deny (Role)

The **deny** command adds a deny rule to the configuration mode role. Deny rules prohibit access of specified commands from usernames to which the role is applied. Sequence numbers determine rule placement in the role. Commands are compared sequentially to rules within a role until it matches a rule. A command's authorization is determined by the first rule it matches. Sequence numbers for commands without numbers are derived by adding 10 to the number of the role's last rule.

Deny rules use regular expressions to denote commands. A **mode** parameter specifies command modes from which commands are restricted. Modes are denoted either by predefined keywords, a command modes short key, or a regular expression that specifies the long key of one or more command modes.

The **no deny** and **default deny** commands remove the specified rule from the configuration mode role. The **no <sequence number> (Role)** command also removes the specified rule from the role.

Command Mode

Role Configuration

Command Syntax

```
[SEQ_NUM] deny [MODE_NAME] command command_name
```

```
no deny [MODE_NAME] command command_name
```

```
default deny [MODE_NAME] command command_name
```

Parameters

- **SEQ_NUM** Sequence number assigned to the rule. Options include:
 - **<no parameter>** Number is derived by adding 10 to the number of the role's last rule.
 - **<1 - 256>** Number assigned to entry.
- **MODE_NAME** Command mode from which command access is prohibited. Values include:
 - **<no parameter>** All command modes
 - **mode short_name** Exact match of a mode's short key name.
 - **mode long_name** Regular expression matching long key name of one or more modes.
 - **mode config** Global configuration mode.
 - **mode config-all** All configuration modes, including global configuration mode.
 - **mode exec** EXEC and Privileged EXEC modes.
- **command_name** Regular expression that denotes the name of one or more commands.

Guidelines

These CLI **prompt** format commands program the prompt to display the following mode keys:

- **%p** Short mode key.
- **%P** Long mode key.

Deny statements are saved to **running-config** only upon exiting **Role Configuration Mode**.

Related Commands

The **role** command places the switch in **Role Configuration Mode**.

Example

These commands append a **deny** rule at the end of the **sysuser** role that restricts access to the **reload** command from EXEC and Privileged EXEC mode.

```
switch(config)#role sysuser
switch(config-mode-sysuser)#deny mode exec command reload
```

```
switch(config-mode-sysuser) #
```

8.1.1.7.21 enable password

The **enable password** command creates a new enable password or changes an existing password.

The **no enable password** and **default enable password** commands delete the **enable password** by removing the **enable password** command from **running-config**.

Command Mode

Global Configuration

Command Syntax

```
enable password [ENCRYPT_TYPE] password
```

```
no enable password
```

```
default enable password
```

Parameters

- **ENCRYPT_TYPE** encryption level of the *password* parameter. Settings include:
 - **<no parameter>** the password is entered as clear text.
 - **0** the password is entered as clear text. Equivalent to <no parameter>.
 - **5** the password is entered as an MD5 encrypted string.
 - **sha512** the password is entered as an SHA-512-encrypted string.
- **password** text that authenticates the username.
 - **password** must be in clear text if **ENCRYPT_TYPE** specifies clear text.
 - **password** must be an appropriately encrypted string if **ENCRYPT_TYPE** specifies encryption.

Encrypted strings entered through this parameter are generated elsewhere.

Examples

- These equivalent commands assign *xyrt1* as the enable password.

```
switch(config)#enable password xyrt1
switch(config)#enable password 0 xyrt1
```

- This command assigns the enable password to the clear text (12345) that corresponds to the encrypted string *\$1\$8bPBrJnd\$Z8wbKLHpJEd7d4tc5Z/6h/*. The string was generated by an MD5-encryption program using 12345 as the seed.

```
switch(config)#enable password 5 $1$8bPBrJnd$Z8wbKLHpJEd7d4
tc5Z/6h/
switch(config)#
```

- This command deletes the enable password.

```
switch(config)#no enable password
switch(config)#
```

8.1.1.7.22 ip radius source-interface

The **ip radius source-interface** command specifies the interface from which the IPv4 address is derived for use as the source for outbound RADIUS packets. When a source interface is not specified, the switch selects an interface.

The **no ip radius source-interface** and **default ip radius source-interface** commands remove the **ip radius source-interface** command from *running-config*.

Command Mode

Global Configuration

Command Syntax

```
ip radius [VRF_INST] source-interface INT_NAME
```

```
no ip radius [VRF_INST] source-interface
```

```
default ip radius [VRF_INST] source-interface
```

Parameters

- **VRF_INST** specifies the VRF instance used to communicate with the specified server.
 - **<no parameter>** switch communicates with the server using the default VRF.
 - **vrf vrf_name** switch communicates with the server using the specified user-defined VRF.
- **INT_NAME** Interface type and number. Options include:
 - **interface ethernet** *e_num* Ethernet interface specified by *e_num*.
 - **interface loopback** *l_num* Loopback interface specified by *l_num*.
 - **interface management** *m_num* Management interface specified by *m_num*.
 - **interface port-channel** *p_num* Port-channel interface specified by *p_num*.
 - **interface vlan** *v_num* VLAN interface specified by *v_num*.

Example

This command configures the source address for outbound RADIUS packets as the IPv4 address assigned to the loopback interface.

```
switch(config)#ip radius source-interface loopback 0
switch(config)#
```

8.1.1.7.23 ip tacacs source-interface

The `ip tacacs source-interface` command specifies the interface from which the IPv4 address is derived for use as the source for outbound TACACS+ packets. When a source interface is not specified, the switch selects an interface.

The `no ip tacacs source-interface` and `default ip tacacs source-interface` commands remove the `ip tacacs source-interface` command from *running-config*.

Command Mode

Global Configuration

Command Syntax

```
ip tacacs [VRF_INST] source-interface INT_NAME
```

```
no ip tacacs [VRF_INST] source-interface
```

```
default ip tacacs [VRF_INST] source-interface
```

Parameters

- **VRF_INST** specifies the VRF instance used to communicate with the specified server.
 - **<no parameter>** switch communicates with the server using the default VRF.
 - **vrf vrf_name** switch communicates with the server using the specified user-defined VRF.
- **INT_NAME** Interface type and number. Options include:
 - **interface ethernet e_num** Ethernet interface specified by **e_num**.
 - **interface loopback l_num** Loopback interface specified by **l_num**.
 - **interface management m_num** Management interface specified by **m_num**.
 - **interface port-channel p_num** Port-channel interface specified by **p_num**.
 - **interface vlan v_num** VLAN interface specified by **v_num**.

Example

This command configures the source address for outbound TACACS+ packets as the IPv4 address assigned to the loopback interface.

```
switch(config)#ip tacacs source-interface loopback 0
switch(config)#
```

8.1.1.7.24 no <sequence number> (Role)

The **no <sequence number>** command removes the rule with the specified sequence number from the configuration-mode role. The **default <sequence number>** command also removes the specified rule.

Command Mode

Role Configuration

Command Syntax

```
no sequence_num
```

```
default sequence_num
```

Parameters

- **sequence_num** sequence number of rule to be deleted. Values range from 1 to 256.

Guidelines

Role statement changes are saved to **running-config** only upon exiting Role Configuration Mode.

Related Command

The **role** command places the switch in Role Configuration Mode.

Example

These commands display the rules in the sysuser role, remove rule 30 from the role, then display the edited role.

```
switch(config)#show users roles sysuser
The default role is network-operator

role: sysuser
    10 deny mode exec command reload
    20 deny mode config command (no |default )?router
    30 deny mode config command (no |default )?(ip|mac)
  access-list
    40 deny mode if command (no |default )?(ip|mac) access-
group
    50 deny mode config-all command lcp|spanning-tree
    60 permit command .*
switch(config)#role sysuser
switch(config-role-sysuser)#no 30
switch(config-role-sysuser)#exit
switch(config)#show users roles sysuser
The default role is network-operator

role: sysuser
    10 deny mode exec command reload
    20 deny mode config command (no |default )?router
    40 deny mode if command (no |default )?(ip|mac) access-
group
    50 deny mode config-all command lcp|spanning-tree
    60 permit command .*
switch(config)#
```

8.1.1.7.25 radius-server deadtime

The **radius-server deadtime** command defines global deadtime period, when the switch ignores a non-responsive RADIUS server. A non-responsive server is one that fails to answer any attempt to retransmit after a timeout expiry. Deadtime is disabled if a value is not configured.

The **no radius-server deadtime** and **default radius-server deadtime** commands restore the default global deadtime period of three minutes by removing the **radius-server deadtime** command from *running-config*.

Command Mode

Global Configuration

Command Syntax

```
radius-server deadtime dead_interval
```

```
no radius-server deadtime
```

```
default radius-server deadtime
```

Parameters

- **dead_interval** period that the switch ignores non-responsive servers (minutes). Values range from 1 to 1000. Default is 3.

Related Command

[radius-server host](#)

Example

This command programs the switch to ignore a server for two hours if it fails to respond to a request during the period defined by timeout and retransmit parameters.

```
switch(config)#radius-server deadtime 120  
switch(config)#
```

8.1.1.7.26 radius-server host

The `radius-server host` command sets parameters for communicating with a specific RADIUS server. These values override global settings when the switch communicates with the specified server.

A RADIUS server is defined by its server address, authorization port, and accounting port. Servers with different address-authorization port-accounting port combinations have separate configurations.

The `no radius-server host` and `default radius-server` commands remove settings for the RADIUS server configuration at the specified address-authorization port-accounting port location by deleting the corresponding `radius-server host` command from *running-config*.

Command Mode

Global Configuration

Command Syntax

```
radius-server host ADDR [VRF_INST][AUTH][ACCT][TIMEOUT][DEAD][RETRAN][ENCRYPT]
no radius-server host [ADDR][VRF_INST][AUTH][ACCT]
default radius-server host [ADDR][VRF_INST][AUTH][ACCT]
```

Parameters

- **ADDR** RADIUS server location. Options include:
 - *ipv4_addr* server's IPv4 address.
 - *host_name* server's DNS host name (FQDN).
- **VRF_INST** specifies the VRF instance used to communicate with the specified server.
 - *<no parameter>* switch communicates with the server using the default VRF.
 - *vrf vrf_name* switch communicates with the server using the specified user-defined VRF.
- **AUTH** Authorization port number.
 - *<no parameter>* default port of 1812.
 - *auth-port number* number ranges from 1 to 65535.
- **ACCT** Accounting port number.
 - *<no parameter>* default port of 1813.
 - *acct-port number* numbers range from 1 to 65535.
- **TIMEOUT** timeout period (seconds). Ranges from 1 to 1000.
 - *<no parameter>* assigns global timeout value (see [radius-server timeout](#)).
 - *timeout number* assigns number as the timeout period. Ranges from 1 to 1000.
- **DEAD** period (minutes) when the switch ignores a non-responsive RADIUS server.
 - *<no parameter>* assigns global deadtime value (see [radius-server deadtime](#)).
 - *deadtime number* specifies deadtime, where number ranges from 1 to 1000.
- **RETRAN** attempts to access RADIUS server after the first timeout expiry.
 - *<no parameter>* assigns global retransmit value (see [radius-server retransmit](#)).
 - *retransmit number* specifies number of attempts, where number ranges from 1 to 100.
- **ENCRYPT** encryption key that switch and server use to communicate.
 - *<no parameter>* assigns global encryption key (see [radius-server key](#)).
 - *key key_text* where *key_text* is in clear text.
 - *key 5 key_text* where *key_text* is in clear text.
 - *key 7 key_text* where *key_text* is provide in an encrypted string.

Examples

-
- This command configures the switch to communicate with the RADIUS server located at *10.1.1.5*. The switch uses the global timeout, deadtime, retransmit, and key settings to communicate with this server, and communicates through port 1812 for authorization and 1813 for accounting.

```
switch(config)#radius-server host 10.1.1.5  
switch(config)#
```

- This command configures the switch to communicate with the RADIUS server assigned the host name *RAD-1*. Communication for authorization is through port 1850; communication for accounting is through port 1813 (the default).

```
switch(config)#radius-server host RAD-1 auth-port 1850  
switch(config)#
```

8.1.1.7.27 radius-server key

The **radius-server key** command defines the global encryption key the switch uses when communicating with any RADIUS server for which a key is not defined.

The **no radius-server key** and **default radius-server key** commands remove the global key from *running-config*.

Command Mode

Global Configuration

Command Syntax

```
radius-server key [ENCRYPT_TYPE] encrypt_key
```

```
no radius-server key
```

```
default radius-server key
```

Parameters

- **ENCRYPT_TYPE** encryption level of *encrypt_key*.
 - **<no parameter>** encryption key is entered as clear text.
 - **0** encryption key is entered as clear text. Equivalent to **<no parameter>**.
 - **7** *encrypt_key* is an encrypted string.
- **encrypt_key** shared key that authenticates the username.
 - **encrypt_key** must be in clear text if **ENCRYPT_TYPE** specifies clear text.
 - **encrypt_key** must be an encrypted string if **ENCRYPT_TYPE** specifies an encrypted string.

Encrypted strings entered through this parameter are generated elsewhere.

Related Commands

- [radius-server host](#)

Examples

- This command configures *cv90jr1* as the global encryption key.

```
switch(config)#radius-server key 0 cv90jr1  
switch(config)#
```

- This command assigns *cv90jr1* as the key by specifying the corresponding encrypted string.

```
switch(config)#radius-server key 7 020512025B0C1D70  
switch(config)#
```

8.1.1.7.28 radius-server retransmit

The **radius-server retransmit** command defines the global retransmit count, which specifies the number of times the switch attempts to access the RADIUS server after the first timeout expiry.

The **no radius-server retransmit** and **default radius-server retransmit** commands restore the global retransmit count to its default value of three by deleting the **radius-server retransmit** command from *running-config*.

Command Mode

Global Configuration

Command Syntax

```
radius-server retransmit count
no radius-server retransmit
default radius-server retransmit
```

Parameters

- **count** retransmit attempts after first timeout expiry. Values range from 1 to 100. Default is 3.

Related Command

[radius-server host](#)

Example

This command configures the switch to attempt five RADIUS server contacts after the initial timeout. If the timeout parameter is set to 50 seconds, then the total period that the switch waits for a response is $((5+1)*50) = 300$ seconds.

```
switch(config)#radius-server retransmit 5
switch(config)#
```

8.1.1.7.29 radius-server timeout

The `radius-server timeout` command defines the global timeout the switch uses when communicating with any RADIUS server for which a timeout is not defined.

The `no radius-server timeout` and `default radius-server timeout` commands restore the global timeout default period of five seconds by removing the `radius-server timeout` command from *running-config*.

Command Mode

Global Configuration

Command Syntax

```
radius-server timeout time_period
```

```
no radius-server timeout
```

```
default radius-server timeout
```

Parameters

- *time_period* timeout period (seconds). Values range from 1 to 1000. Default is 5.

Related Commands

- [radius-server host](#)
- [radius-server key](#)
- [radius-server deadtime](#)
- [radius-server retransmit](#)

Example

This command configures the switch to wait 50 seconds for a RADIUS server response before issuing an error.

```
switch(config)#radius-server timeout 50  
switch(config)#
```

8.1.1.7.30 resequence (Role)

The **resequence** command assigns sequence numbers to rules in the configuration mode role. Command parameters specify the number of the first rule and the numeric interval between consecutive rules.

The maximum sequence number is 256.

Command Mode

Role Configuration

Command Syntax

```
resequence start_num inc_num
```

Parameters

- **start_num** sequence number assigned to the first rule. Value ranges from 1 to 256. Default is 10.
- **inc_num** numeric interval between consecutive rules. Value ranges from 1 to 256. Default is 10.

Guidelines

Role statement changes are saved to **running-config** only upon exiting Role Configuration Mode.

Related Command

The **role** command places the switch in Role Configuration Mode.

Example

The **resequence** command renumbers the rules in the sysuser role, starting the first rule at 15 and incrementing subsequent lines by 5.

```
switch(config)#show users roles sysuser
The default role is network-operator

role: sysuser
    10 deny mode exec command reload
    20 deny mode config command (no |default )?router
    40 deny mode if command (no |default )?(ip|mac) access-
group
    50 deny mode config-all command lacp|spanning-tree
    60 permit command .*
switch(config)#role sysuser
switch(config-role-sysuser)#resequence 15 5
switch(config-role-sysuser)#exit
switch(config)#show users roles sysuser
The default role is network-operator

role: sysuser
    15 deny mode exec command reload
    20 deny mode config command (no |default )?router
    25 deny mode if command (no |default )?(ip|mac) access-
group
    30 deny mode config-all command lacp|spanning-tree
    35 permit command .*
switch(config)#
```

8.1.1.7.31 permit (Role)

The **permit** command adds a permit rule to the configuration mode role. Permit rules authorize access to specified commands for usernames to which the role is applied. Sequence numbers determine rule placement in the role. Commands are compared sequentially to rules within a role until it matches a rule. A command's authorization is determined by the first rule it matches. Sequence numbers for commands without numbers are derived by adding 10 to the number of the role's last rule.

Permit rules use regular expression to denote commands. A **mode** parameter specifies command modes in which commands are authorized. Modes are denoted either by predefined keywords, a command modes short key, or a regular expression that specifies the long key of one or more command modes.

The **no deny** and **default deny** commands remove the specified rule from the configuration mode role. The **no <sequence number> (Role)** command also removes the specified rule from the role.

Command Mode

Role Configuration

Command Syntax

```
[SEQ_NUM] permit [MODE_NAME] command command_name
```

```
no permit [MODE_NAME] command ] command_name
```

```
default permit [MODE_NAME] command command_name
```

Parameters

- **SEQ_NUM** Sequence number assigned to the rule. Options include:
 - **<no parameter>** Number is derived by adding 10 to the number of the roles last rule.
 - **<1 - 256>** Number assigned to entry.
- **MODE_NAME** Command mode in which command access is authorized. Values include:
 - **<no parameter>** All command modes
 - **mode short_name** Exact match of a modes short-key name.
 - **mode long_name** Regular expression matching long-key name of one or more modes.
 - **mode config** Global configuration mode.
 - **mode config-all** All configuration modes, including global configuration mode.
 - **mode exec** EXEC and Privileged EXEC modes.
- **command_name** Regular expression that denotes the name of one or more commands.

Guidelines

These CLI **prompt** format commands program the prompt to display the following mode keys:

- **%p** Short-mode key.
- **%P** Long-mode key.

Permit statements are saved to **running-config** only upon exiting **Role Configuration Mode**.

Related Commands

The **role** command places the switch in **Role Configuration Mode**.

Example:

These commands append a **permit** rule at the end of the **sysuser** role that authorizes all commands from **VLAN 1** or **VLAN 2** interface configuration modes.

```
switch(config)#role sysuser
switch(config-mode-sysuser)#permit mode if-Vl(1|2) command .*
```

```
switch(config-mode-sysuser) #
```

8.1.1.7.32 role

The **role** command places the switch in Role Configuration Mode, which is a group-change mode that modifies a role. A role is a data structure that supports local command authorization through its assignment to user accounts. Roles consist of permit and deny rules that define authorization levels for specified commands. Applying a role to a username authorizes the user to execute commands specified by the role.

The **role** command specifies the name of the role that subsequent commands modify and creates a role if it references a nonexistent role. All changes in a group change mode edit session are pending until the session ends:

- The **exit** command saves pending changes to **running-config** and returns the switch to Global Configuration Mode. Changes are also saved by entering a different configuration mode.
- The **abort** command discards pending changes, returning the switch to Global Configuration Mode.

The **no role** and **default role** commands delete the specified role by removing the role and its statements from **running-config**.

Command Mode

Global Configuration

Command Syntax

```
role role_name
```

```
no role role_name
```

```
default role role_name
```

Parameters

- **role_name** Name of role.

Commands Available in Role Configuration Mode:

- [deny \(Role\)](#)
- [permit \(Role\)](#)
- [no <sequence number> \(Role\)](#)
- [resequence \(Role\)](#)

Related Commands

- [show users roles](#)

Examples

- This command places the switch in Role Configuration Mode to modify the speaker role.

```
switch(config)#role speaker
switch(config-role-speaker)#
```

- This command saves changes to **speaker** role, then returns the switch to Global Configuration Mode.

```
switch(config-role-speaker)#exit
switch(config)#
```

- This command discards changes to **speaker**, then returns the switch to Global Configuration Mode.

```
switch(config-role-speaker)#abort
```

```
switch(config)#
```

8.1.1.7.33 server (server-group-RADIUS configuration mode)

The **server (server-group-RADIUS configuration mode)** command adds the specified RADIUS server to the configuration-mode group. Servers must be configured with the [radius-server host](#) command before adding them to the server group.

A RADIUS server is defined by its server address, authorization port, and accounting port. A group can contain multiple servers with the same IP address that have different authorization or accounting ports.

The **no server** and **default server** commands remove the specified server from the group.

Command Mode

Server-Group-RADIUS Configuration

Command Syntax

```
server LOCATION [VRF_INST][AUTH][ACCT]
no server LOCATION [VRF_INST][AUTH][ACCT]
default server LOCATION [VRF_INST][AUTH][ACCT]
```

Parameters

- **LOCATION** RADIUS server location. Options include:
 - **ipv4_addr** server's IPv4 address.
 - **host_name** server's DNS host name (FQDN).
- **VRF_INST** specifies the VRF instance used to communicate with the specified server.
 - **<no parameter>** switch communicates with the server using the default VRF.
 - **vrf vrf_name** switch communicates with the server using the specified user-defined VRF.
- **AUTH** Authorization port number.
 - **<no parameter>** default port of 1812.
 - **auth-port number number** ranges from 1 to 65535.
- **ACCT** Accounting port number.
 - **<no parameter>** default port of 1813.
 - **acct-port number number** ranges from 1 to 65535.

Related Commands

The [aaa group server radius](#) command places the switch in Server-group-RADIUS Configuration Mode.

Example

These commands add two servers to the RAD-SV1 server group.

```
switch(config)#aaa group server radius RAD-SV1
switch(config-sg-radius-RAD-SV1)#server RAC-1
switch(config-sg-radius-RAD-SV1)#server 10.1.5.14 acct-port 1851
switch(config-sg-radius-RAD-SV1)#
```

8.1.1.7.34 server (server-group-TACACS+ configuration mode)

The `server (server-group-TACACS+ configuration mode)` command adds the specified TACACS+ server to the configuration-mode group. Servers must be configured with the `tacacs-server host` command before adding them to the server group.

A TACACS+ server is defined by its server address and port number. Servers with different address-port combinations have separate statements in *running-config*.

The `no server` and `default server` commands remove the specified server from the group.

Command Mode

Server-group-TACACS+ Configuration

Command Syntax

```
server LOCATION [VRF_INST][PORT]
no server LOCATION [VRF_INST][PORT]
default server LOCATION [VRF_INST][PORT]
```

Parameters

- **LOCATION** TACACS+ server location. Options include:
 - *ipv4_addr* server's IPv4 address.
 - *ipv6_addr* server's IPv6 address.
 - *host_name* server's DNS host name (FQDN).
- **VRF_INST** specifies the VRF instance used to communicate with the specified server.
 - *<no parameter>* switch communicates with the server using the default VRF.
 - *vrf vrf_name* switch communicates with the server using the specified user-defined VRF.
- **PORT** TCP connection port number.
 - *<no parameter>* default port of 49.
 - *port number number* ranges from 1 to 65535.

Related Command

The `aaa group server tacacs+` command places the switch in Server-group-TACACS+ Configuration Mode.

Example

These commands add two servers to the TAC-GR server group with default port number 49.

```
switch(config)#aaa group server tacacs+ TAC-GR
switch(config-sg-tacacs+-TAC-GR)#server TAC-1
switch(config-sg-tacacs+-TAC-GR)#server 10.1.4.14
switch(config-sg-tacacs+-TAC-GR)#
```

8.1.1.7.35 show aaa

The **show aaa** command displays the user database. The command displays the encrypted enable password first, followed by a table of usernames and their corresponding encrypted password.

The command does not display unencrypted passwords.

Command Mode

Privileged EXEC

Command Syntax

```
show aaa
```

Example

This command displays the local user database.

```
switch#show aaa
Enable password (encrypted): $1$UL4gDWy6$3KqCPYPGRvxDxUq3qA/Hs/
Username  Encrypted passwd
-----  -----
admin
janis     $1$VVnDH/Ea$iwsfnrGNO8nbDsf0tazp9/
thomas    $1$/MmXTUil$.fJxLfcumzppNSEDVDWq9.
switch#
```

8.1.1.7.36 show aaa counters

The **show aaa counters** command displays the number of service transactions performed by the switch since the last time the counters were reset.

Command Mode

Privileged EXEC

Command Syntax

```
show aaa counters
```

Example

This command displays the number of AAA transactions.

```
switch#show aaa counters
Authentication
    Successful:          30
    Failed:              0
    Service unavailable: 0

Authorization
    Allowed:            188
    Denied:             0
    Service unavailable: 0

Accounting
    Successful:         0
    Error:              0
    Pending:            0

Last time counters were cleared: never
switch#
```

8.1.1.7.37 show aaa methods

The **show aaa methods** command displays all the named method lists defined in the specified Authentication, Authorization, and Accounting (AAA) service.

Command Mode

Privileged EXEC

Command Syntax

```
show aaa methods SERVICE_TYPE
```

Parameters

- **SERVICE_TYPE** the service type of the method lists that the command displays.
 - **accounting** accounting services.
 - **authentication** authentication services.
 - **authorization** authorization services.
 - **all** accounting, authentication, and authorization services.

Example

This command configures the named method lists for all AAA services.

```
switch#show aaa methods all
Authentication method lists for LOGIN:
  name=default methods=group tacacs+, local
Authentication method list for ENABLE:
  name=default methods=local
Authorization method lists for COMMANDS:
  name=privilege0-15 methods=group tacacs+, local
Authentication method list for EXEC:
  name=exec methods=group tacacs+, local
Accounting method lists for COMMANDS:
  name=privilege0-15 default-action=none
Accounting method list for EXEC:
  name=exec default-action=none
switch#
```

8.1.1.7.38 show management ldap

The `show management ldap` command displays information about the LDAP configuration.

Command Mode

EXEC

Command Syntax

```
show management ldap
```

`show management ldap` command displays the information for the current state of the system.

Parameters

- <no parameter> state of the system.

The following command shows general information for LDAP.

```
switch#show management ldap
LDAP server: prod-dc-hq1.aristanetworks.com/389
  Binds requested: 6
  Binds successful: 6
  Binds failed: 0
  Binds timed out: 0
  FIPS is ON
```

Last time counters were cleared: 1:16:41 ago

The authentication action in LDAP is the **bind**, which is equivalent to attempting a log-in. There will be 2 binds per login attempt, one for the admin account and one for the user account.

The FIPS mode is controlled by the SSL profile in AAA. To validate an SSL profile use the following:

```
switch#show management security ssl profile
  Profile          State
  -----
  testProfile      valid
```

To verify a user accounts authorization being performed by ldap, use "show users detail":

```
switch#show users detail
Session      Username          Roles          TTY
  State      Duration         Auth           Remote Host
-----
-----
1006         erahn            network-admin  vty3
           E              0:00:05       group ldap    fd7a:629f:52a
4:dc25:b08d:feff:feed:2ce7
```

To validate the role for a current session the `vtty` information in the TTY column must be matched against the Line column in the following command. The row with a "*" character at the start is the current session where the command was run:

```
switch#show users
      Line      User           Host(s)      Idle
Location
  1 con 0      admin           idle         01:19:00   -
  2 vty 10     srv-sw-ldaptest idle         01:19:00
172.16.124.151
* 3 vty 3      erahn           idle         00:00:04
fd7a:629f:52a4:dc25:b08d:feff:feed:2ce7
```

8.1.1.7.39 show privilege

The **show privilege** command displays the current privilege level for the CLI session.

Command Mode

EXEC

Command Syntax

```
show privilege
```

Example

This command displays the current privilege level.

```
switch>show privilege  
Current privilege level is 15  
switch>
```

8.1.1.7.40 show radius

The **show radius** command displays statistics for the RADIUS servers that the switch accesses.

Command Mode

EXEC

Command Syntax

```
show radius
```

Example

This command displays statistics for connected RADIUS servers.

```
switch#show radius
RADIUS server          : radius/10
  Connection opens:      204
  Connection closes:    0
  Connection disconnects: 199
  Connection failures:  10
  Connection timeouts:  2
  Messages sent:        1490
  Messages received:    1490
  Receive errors:       0
  Receive timeouts:    0
  Send timeouts:       0

Last time counters were cleared: never
switch#
```

8.1.1.7.41 show tacacs

The **show tacacs** command displays statistics for the TACACS+ servers that the switch accesses.

Command Mode

EXEC

Command Syntax

```
show tacacs
```

Example

This command displays statistics for connected TACACS+ servers.

```
switch#show tacacs
TACACS+ server          : tacacs/49
  Connection opens:      15942
  Connection closes:    7
  Connection disconnects: 1362
  Connection failures:  0
  Connection timeouts:  0
  Messages sent:        34395
  Messages received:    34392
  Receive errors:       0
  Receive timeouts:    2
  Send timeouts:        0

Last time counters were cleared: never

TACACS+ source-interface: Enabled
  TACACS+ outgoing packets will be sourced with an IP address
  associated with the
  Loopback0 interface
switch#
```

8.1.1.7.42 show users accounts

The **show users accounts** command displays the names, roles, and privilege levels of users that are listed in *running-config*. The SSH public key is also listed for names for which an SSH key is configured.

Command Mode

Privileged EXEC

Command Syntax

```
show users accounts
```

Example

This command displays the usernames that are configured on the switch.

```
switch#show users accounts
user: FRED
      role: <unknown>
      privilege level: 1
      ssh public key: ssh-rsa AAAAB3NzaC1yc2EAAAADAQABAAQBAQDjUg2VDiBX7In0q
HtN5PyHOWtYvIoeZsxF5YmesQ/rh++mbpT504dL7So+Bpr9T/0qIj+zilat8fX/J
lO42+3pjfkHY/+1
sT2EPNjGTK7uJv1wSGmhc3+90dNmJtr5YVlJFjjQ5m+5Pa+PGe3z4JIV11Y2Nh
LrV2fXtbciLdijnj6F
AlhXjiLt51DJhG13uUxGBJe0+NlGvpEsTJVJvMdJuS6weMi+xSXc9yQimVD2
weJBHsYFngHST2j0pAy
F2S7/EOU13pY42RztDSs42nMNNrutPT0q5Z17aAKvhpd0dDlc+qIwrCrXb
eIChHem7+0N8/zA3alBK4
eKSFSZBd3Pb admin@switch
switch#
user: JANE
      role: sysuser2
      privilege level: 1
user: admin
      role: network-admin
      privilege level: 1
```

8.1.1.7.43 show users detail

The **show users detail** command displays information about active AAA login sessions. Information includes username, roles, TTY, state of the session (pending or established), duration, authentication method, and if available, remote host and remote username.

Command Mode

Privileged EXEC

Command Syntax

```
show users detail
```

Example

This command displays information about the active AAA login sessions.

```
switch# show users detail
Session Username Roles TTY State Duration Auth Remote Host
-----
2 admin network-admin ttyS0 E 0:01:21 local
4 joe sysadmin telnet E 0:02:01 local sf.example.com
6 alice sysadmin ssh E 0:00:52 group radius ny.example.com
7 bob sysadmin ssh E 0:00:48 group radius la.example.com
8 kim network-admin1 ssh E 0:00:55 group radius de.example.com
9 admin network-admin ssh E 0:00:07 local bj.example.com
10 max network-admin telnet E 0:00:07 local sf.example.com
```

8.1.1.7.44 show users roles

The **show users roles** command displays the name of the default role and the contents of the specified roles. Commands that do not specify a role display the rules in all built-in and configured roles.

Command Mode

Privileged EXEC

Command Syntax

```
show users roles [ROLE_LIST]
```

Parameters

- **ROLE_LIST** Roles that the command displays. Options include:
 - **<no parameter>** Command displays all roles.
 - **role_name** Name of role displayed by command.

Related Command

The **role** command places the switch in Role Configuration Mode, which is used to create new roles or modify existing roles.

Example

This command displays the contents of all user-defined and built-in roles.

```
switch#show users roles
The default role is network-operator

role: network-admin
    10 permit command .*
role: network-operator
    10 deny mode exec command bash|\|
    20 permit mode exec command .*
role: sysuser
    15 deny mode exec command reload
    20 deny mode config command (no |default )?router
    25 deny mode if command (no |default )?(ip|mac) access-
group
    30 deny mode config-all command lacp|spanning-tree
    35 permit command .*
    40 deny mode exec command .*
    50 permit mode exec command show|clear (counters|pla
tform)|configure
```

8.1.1.7.45 show users

The **show users** command displays the usernames that are currently logged into the switch.

Command Mode

Privileged EXEC

Command Syntax

```
show users
```

Example

This command displays the users that are logged into the switch.

```
switch#show users
  Line      User      Host(s)      Idle      Location
  1 vty 2    john      idle        1d       10.22.6.113
  2 vty 4    jane      idle        21:33:00 10.22.26.26
 * 3 vty 6    ted       idle        00:00:01 10.17.18.71
switch#
```

8.1.1.7.46 tacacs-server host

The **tacacs-server host** command sets communication parameters for communicating with a specific TACACS+ server. These values override global settings when the switch communicates with the specified server.

A TACACS+ server is defined by its server address and port number. Servers with different combinations of address-port-VRF-multiplex settings have separate statements in **running-config**.

The **no tacacs-server host** and **default tacacs-server host** commands remove settings for the TACACS+ server configuration at the specified address-port-VRF combination by deleting the corresponding **tacacs-server host** command from **running-config**.

Command Mode

Global Configuration

Command Syntax

```
tacacs-server host SERVER_ADDR [MULTIPLEX][VRF_INST][PORT][TIMEOUT][ENCRYPT]
no tacacs-server host [SERVER_ADDR][MULTIPLEX][VRF_INST][PORT]
default tacacs-server host [SERVER_ADDR][MULTIPLEX][VRF_INST][PORT]
```

Parameters

- **SERVER_ADDR** TACACS+ server location. Options include:
 - **ipv4_addr** server's IPv4 address.
 - **ipv6_addr** server's IPv6 address.
 - **host_name** server's DNS host name (FQDN).
- **MULTIPLEX** TACACS+ server support of multiplex sessions on a TCP connection.
 - **<no parameter>** server does not support multiplexing.
 - **single-connection** server supports session multiplexing.
- **VRF_INST** specifies the VRF instance used to communicate with the specified server.
 - **<no parameter>** switch communicates with the server using the default VRF.
 - **vrf vrf_name** switch communicates with the server using the specified user-defined VRF.
- **PORT** port number of the TCP connection.
 - **<no parameter>** default port of 49.
 - **port number** port number ranges from 1 to 65535.
- **TIMEOUT** timeout period (seconds).
 - **<no parameter>** assigns the globally configured timeout value (see [tacacs-server timeout](#)).
 - **timeout number** timeout period (seconds). *number* ranges from 1 to 1000.
- **ENCRYPT** encryption key the switch and server use to communicate. Settings include
 - **<no parameter>** assigns the globally configured encryption key (see [tacacs-server key](#)).
 - **key key_text** where *key_text* is in clear text.
 - **key 5 key_text** where *key_text* is in clear text.
 - **key 7 key_text** where *key_text* is an encrypted string.

Examples

- This command configures the switch to communicate with the TACACS+ server located at 10.1.1.5. The switch uses the global timeout, encryption key, and port settings.

```
switch(config)#tacacs-server host 10.1.1.5
switch(config)#
```

-
- This command configures the switch to communicate with the TACACS+ server assigned the host name *TAC_1*. The switch defines the timeout period as *20 seconds* and the encryption key as *rp31E2v*.

```
switch(config)#tacacs-server host TAC_1 timeout 20 key rp31E2v
switch(config)#
```

- This command configures the switch to communicate with the TACACS+ server located at *10.12.7.9*, indicates that the server supports multiplexing sessions on the same TCP connection, and that access is through port 54.

```
switch(config)#tacacs-server host 10.12.7.9 single-connection
port 54
switch(config)#
```

8.1.1.7.47 tacacs-server key

The **tacacs-server key** command defines the global encryption key the switch uses when communicating with any TACACS+ server for which a key is not defined.

The **no tacacs-server key** and **default tacacs-server key** commands remove the global key from *running-config*.

Command Mode

Global Configuration

Command Syntax

```
tacacs-server key [ENCRYPT_TYPE] encrypt_key
```

```
no tacacs-server key
```

```
default tacacs-server key
```

Parameters

- **ENCRYPT_TYPE** encryption level of *encrypt_key*.
 - **<no parameter>** encryption key is entered as clear text.
 - **0** encryption key is entered as clear text. Equivalent to **<no parameter>**.
 - **7** *encrypt_key* is an encrypted string.
- **encrypt_key** shared key that authenticates the username.
 - *encrypt_key* must be in clear text if **ENCRYPT_TYPE** specifies clear text.
 - *encrypt_key* must be an encrypted string if **ENCRYPT_TYPE** specifies an encrypted string.

Encrypted strings entered through this parameter are generated elsewhere.

Related Commands

- [tacacs-server host](#)

Examples

- This command configures *cv90jr1* as the encryption key.

```
switch(config)#tacacs-server key 0 cv90jr1  
switch(config)#
```

- This command assigns *cv90jr1* as the key by specifying the corresponding encrypted string.

```
switch(config)#tacacs-server key 7 020512025B0C1D70  
switch(config)#
```

8.1.1.7.48 tacacs-server policy

The **tacacs-server policy** command programs the switch to permit access to TACACS+ servers that send mandatory attribute-value (AV) pairs that the switch does not recognize. By default, the switch denies access to TACACS+ servers when it receives unrecognized AV pairs from the server.

The switch recognizes the following mandatory AV pairs:

- **priv-lvl=x** where x is an integer between 0 and 15.

The **no tacacs-server policy** and **default tacacs-server policy** commands restore the switch default of denying access to servers from which it receives unrecognized mandatory AV pair by deleting the **tacacs-server policy** statement from *running-config*.

Command Mode

Global Configuration

Command Syntax

```
tacacs-server policy unknown-mandatory-attribute ignore
no tacacs-server policy unknown-mandatory-attribute ignore
default tacacs-server policy unknown-mandatory-attribute ignore
```

Example

This command configures the switch to permit access to TACACS+ servers that send unrecognized mandatory AV pairs.

```
switch(config)#tacacs-server policy unknown-mandatory-attribute
ignore
switch(config)#
```

8.1.1.7.49 tacacs-server timeout

The **tacacs-server timeout** command defines the global timeout the switch uses when communicating with any TACACS+ server for which a timeout is not defined.

The **no tacacs-server timeout** and **default tacacs-server timeout** commands restore the global timeout default period of five seconds by removing the **tacacs-server timeout** command from *running-config*.

Command Mode

Global Configuration

Command Syntax

```
tacacs-server timeout time_period
```

```
no tacacs-server timeout
```

```
default tacacs-server timeout
```

Parameters

time_period timeout period (seconds). Values range from 1 to 1000. Default is 5.

Related Command

[tacacs-server host](#)

Example

This command configures the switch to wait 20 seconds for a TACACS+ server response before issuing an error.

```
switch(config)#tacacs-server timeout 20  
switch(config)#
```

8.1.1.7.50 username ssh-key

The **username ssh-key** command configures an SSH key for the specified username. Command options allow the key to be entered directly into the CLI or referenced from a file.

The specified username must be previously configured through a **username** command.

The **no username ssh-key** and **default username ssh-key** commands delete the SSH key for the specified username by removing the corresponding **username ssh-key** command from **running-config**.

The **no username ssh-key role** and **default username ssh-key role** commands perform the following:

- delete the SSH key for the specified username by removing the corresponding **username ssh-key** command from **running-config**.
- delete the role assignment from the specified username by editing the corresponding **username** statement in **running-config**.

Command Mode

Global Configuration

Command Syntax

```
username name sshkey KEY
no username name sshkey [role]
default username name sshkey [role]
```

Parameters

- **name** username text that the user enters at the login prompt to access the CLI.

Valid usernames begin with A-Z, a-z, or 0-9 and may also contain any of these characters:

```
@ # $ % ^ & * - _ = + ; < > , . ~ |
```

- **KEY** SSH key. Options include:
 - **key_text** username is associated with ssh key specified by *key_text* string.
 - **file** *key_file* username is associated with SSH key in the specified file.

Example

These commands create the username **john**, assign it the password **x245**, then associate it to the SSH key listed in the file named **john-ssh**.

```
switch(config)#username john secret x245
switch(config)#username john sshkey file john-ssh
switch(config)#
```

8.1.1.7.51 username

The **username** command adds a username to the local file and optionally assigns a password to the username. If the command specifies an existing username, the command replaces the password in the local file. The command can also define a username without a password or remove the password from a username.

The **no username** command deletes the specified username by removing the corresponding **username** statement from *running-config*. The **default username** command removes user-specified usernames, but restores the **admin** username to its default parameters.

The **no username role** command assigns the default role assignment to the specified **username** statement by editing the corresponding **username** statement in *running-config*. The **default username role** command reverts the specified username to its default role by editing the corresponding **username** statement in *running-config*. For the **admin** username, this restores **network-admin** as its role, even if the **admin** username has been deleted and then created again.

Command Mode

Global Configuration

Command Syntax

```
username name [PRIVILEGE_LEVEL] SECURITY [ROLE_USER]
no username name[role]
default username name [role]
```

All parameters except *name* can be placed in any order.

Parameters

- **name** username text that the user enters at the login prompt to access the CLI.
 - Valid usernames begin with A-Z, a-z, or 0-9 and may also contain any of these characters:

```
@ # $ % ^ & * - _ = + ; < > , . ~ |
```
- **PRIVILEGE_LEVEL** user's initial session privilege level. This parameter is used when an authorization command includes the local option.
 - **<no parameter>** the privilege level is set to 1.
 - **privilege rank** where *rank* is an integer between 0 and 15.
- **SECURITY** password assignment option.
 - **nopassword** *name* is not password protected.
 - **secret password** *name* is protected by specified password (clear-text string).
 - **secret 0 password** *name* is protected by specified password (clear-text string).
 - **secret 5 password** *name* is protected by specified password. (MD5-encrypted string).
 - **secret sha5 password** *name* is protected by specified password (SHA-512-encrypted string).
- **ROLE_USER** specifies the role for performing command authorization. Options include:
 - **<no parameter>** user is assigned default role [aaa authorization policy local default-role](#).
 - **role** *role_name* specifies role assigned to the user.

Guidelines

Encrypted strings entered through this parameter are generated elsewhere. The secret 5 option (**SECURITY**) is typically used to enter a list of username-passwords from a script.

The **SECURITY** parameter is mandatory for unconfigured usernames. For previously configured users, the command can specify a **PRIVILEGE_LEVEL** or **ROLE** without a **SECURITY** setting.

The **admin** username is provided by the initial configuration, but it can be deleted, and its parameters are editable. The initial **admin** configuration is:

```
username admin privilege 1 role network-admin nopassword
```



Note: when deleting the **admin** username, it is advisable to create at least one other username on the switch before saving the configuration.

Examples

- These equivalent commands create the username *john* and assign it the password *x245*. The password is entered in clear text because the **ENCRYPTION** parameter is either omitted or zero.

```
switch(config)#username john secret x245
switch(config)#username john secret 0 x245
```

- This command creates the username *john* and assigns it to the text password that corresponds to the encrypted string *\$1\$sU.7hptc\$TsJ1qslCL7ZYVbyXNG1wg1*. The string was generated by an MD5-encryption program using *x245* as the seed.

```
switch(config)#username john secret 5 $1$sU.7hptc$T
sJ1qslCL7ZYVbyXNG1wg1
switch(config)#
```

- A user authenticates the username *john* by entering **x245** when the CLI prompts for a password.
- This command creates the username *jane* without securing it with a password or removes a password if the *jane* username exists.

```
switch(config)#username jane nopassword
switch(config)#
```

- This command removes the username *william* from the local file.

```
switch(config)#no username william
switch(config)#
```

8.2 Control Plane Security

This section contains the following topics:

- [Transport Layer Security](#)
- [802.1X Port Security](#)

8.2.1 Transport Layer Security

Transport Layer Security (TLS), the successor to Secure Sockets Layer (SSL), is a security protocol used to communicate between client and server. It establishes an encrypted communication channel to secure data.

By default, EOS uses a self signed certificate for client and server connections. However, some browsers or TLS libraries may refuse connections to the default self-signed certificates on EOS and in such case it is recommended to install the TLS server certificates that meet the following criteria:

- RSA key sizes must be greater than or equal to 2048 bits.

- There must be less than 825 days to expiry.
- Certificate must use SHA-2 family of Hashing function.



Note:

Although Arista switches use TLS, the terms TLS and SSL are used interchangeably in this document.

Following are the two main components used by TLS for authentication of identity before any communication starts.

- Certificate
- Key

An SSL certificate is required to establish a secure connection between the client and server. The certificate includes all of the details which are necessary for authentication. Cryptographic keys are used to provide a secure channel of communication. TLS uses two cryptographic keys: a private key known only to the server and a public key embedded in the certificate. The keys are used to validate the certificate.

This chapter contains the following sections.

[Overview](#)

[Configuration](#)

[Rotating Certificate and Key Pair](#)

[Resetting Diffie-Hellman Parameters](#)

[Configuring the TLS Handshake Settings](#)

[Displaying Certificate and Key Information](#)

[TLS Commands](#)

8.2.1.1 Overview

With SSL certificate, key, and profile management framework we can manage and configure SSL certificates, keys and profiles. The SSL is an application-layer protocol which transfers the data securely between the client and server using a combination of authentication, encryption, and data integrity. The SSL uses certificates and private-public key pairs to provide this security. An user can configure a SSL profile which includes certificate, key and trusted CA certificates used in SSL communication. A user can manage certificates, keys, and also multiple SSL profiles. A SSL profile can be configured and attached to any other EOS configuration which supports SSL communication. The individual EOS configuration using this framework includes details of using SSL profile in their configuration.

The only private keys supported are those using the RSA algorithm. Both the certificate and keys must be encoded in Privacy Enhanced Mail (PEM) format.

Example

This is a code sample of a PEM encoded certificate.

\$cat server.crt

```
-----BEGIN CERTIFICATE-----
MIIC3zCCAkgCAQkwDQYJKoZIhvcNAQEEBQAwwTELMAkGA1UEBhMCVVMx
CzAJBgNVBAMkNBMQswCQYDVQQHDAJBTQzEPMA0GA1UECgwGQXJpc3Rh
MQwwCgYDVQQQLDANTRE4xCzAJBgNVBAMMAmNhMRwwGgYJKoZIhvcNAQk
BFg1jYUBhcmlzdGEuY29tMCAXDTE0MDgxmTlxNDQxN1oYDzIwNjkw
NTE0MjE0NDUzWjB5MQswCQYDVQQGEwJVUzELMAkGA1UECwQ0ExCzAJ
BgNVBACMA1NDMQ8wDQYDVQQKDAZBcm1zdGExDDAKBgNVBAAsMA1NETj
EPMA0GA1UEAwwGc2VydmVyMSAwHgYJKoZIhvcNAQkBFhFzZXJ2ZXJJA
```

```
YXJpc3RhLmNvbTCCASiWdQYJKoZIhvcNAQEBBQADggEPADCCAQoCggEBAOBOP/jh
xk28sUH+lhM/mY6QoyLGcbnygwe/hzIjn2mASnf7uPFGHb62Jtt7tQv2xmu/MJfs
aVsNeYXP3ZOcmR00uk9suGVbII7QJUomnsqldJh59UyMfws6V6ergmhwezCDiirV
7nbUDz+uSdNutQL4w/VB+juuWXQ8ztbmygT2ymySaHRK3XnDrAiva0UUvBsmEHH0
wLPsNVNYUxJ4PpOB9luw4upe6ACF9SftMDz3BDcrL6Gq5idWw3YkQfzBwEl+5hkF
hu0owON29I5T8FpAx+Hzpl48YWW65d/4F40S3XRN312xALM8RrQOU/Chx9Sfg0iJ
dsXWNagxleyW2EECAwEAATANBgkqhkiG9w0BAQQFAAOBgQBedfuKHvNDpEkdO2AE
Kihs/YeRGgp+5g7hXU0U2TMAMS545ZQ99pFbnScmIC0m68aw1VXILuj+v1kxAM27
oc8iB+gG7oaFtJpWTvmIHqzeHWb0zrwjPhtXTafWEoam8sJZt38Pc4UVb7lQCd6v
ZCLZZJmC2IL0SG7bLN7yaALCSQ==
-----END CERTIFICATE-----
```

Example

This is a code sample of a PEM encoded RSA key.

\$cat server.key

```
-----BEGIN RSA PRIVATE KEY-----
MIIEowIBAAKCAQEAA4E4/+OHGTbyxQf6WEz+ZjpCjIsZxufKDB7+HMiOfaYBKd/u4
8UaEhrYlO3u1C/bGa78wl+xpWw15hc/dk5yZE7S6T2y4ZVsgjtAlSiaeyrV0mHn1
TIx/CzpXp6uCaHARKIMiKtXudtQPP65J0261AvjD9UH6065ZdDz01ubKBPbKbJJo
dErdecOsCK9rRRRVtKYQcfTAs+w1U1hTEng+k4H2W7Di6l7oAIX1IW0wPPcENysv
oarmJ1bDdiRB/MHASX7mGQWG7SjA43b0j1PwWkDH4fOmXjxhZbrl3/gXjRLddE3f
XbEAszxGtA5T8KHH1J+DSI12xdY1qDhV7JbYQQIDAQABAoIBACv/TU8NQI+HXqGa
RwE7Juyu9EDi+fXGWutPjz6vfBpenrzQNGOnOE0p3z2+szGIkz0ZQHfCWIIISr460
ymCk6+XQombn5XeEG2vH6jiUQLt0Qk2SRopgWJ8kL4NlAexoZxmYj0AlvGO0jtUn
47VEvt8hWpal/WZteYByWQQQOvoj7EhLANIKUGUG9yOcBcEApdHsgOcXewrbilZQ
d4kbpegxQhJKU9jLUXRsIPV2YFrDcT83/94PFTRk/vFBOnWS/Ygt5vRedcoF2HcR
TJMyE+JwnwGJzTPKwbPJgLnjrEGVrQeEerCuTU9v0PpFxu0AOEeV1kPyNBRZzzC+p
al70ZI0CgYEA/Ge1Hj50BjS2DLUYG0zhmc4xoiIqcgPJcN6QQmfqa6DbScQzXsnp
GqNlwb76L0mwNOSABX53YaXhFCrYXMRsXWl95hK7NYCGnD6f/fYcr3u+NdBm5+N
qEiqcQ779arAXqGaN/TGKsm507ngyLBrMbUlaPQEXfaBjrQL3f0k7qMCgYEA44AW
1ptUWy0Wx5oa1wdYVgGw+Wbxb8JY88pj29JhE3Qwhy9FBq7x0wZooQDSkyvbu9aZ
bEiUtctXDDNE/Fy7XgEBMiqrn4R383pbZ5LnmsFKZEcADU1Pe4HjDgSq1rjNSJSA
xEz8xRQvIvy4kpp/tpKsN/Xg2ZBnQmqqj6LWv8sCgYBKeSsWnlmVOS5R94kCXR/f
qtg4N46Aj59dC1T0Uwb29MJ95B8oI7k00+ttp11ZJZ5unL5iahmMhG7maor2uOYK
j2UF9hh9YvPB633uDin+SQ5eu9yu11gLxE0Og5TyOoyCH3qKch2aeGtTFNY/QNaQ
FxpPqNg1BUva2EL8H/oqswKBgQDjbW1nZSjTbSPURq4eQG2CrXYqHUthmlYqgS2K
16nMNN8+hXbP05xUhX2dXqEkFzg3c7U0lupzQq/mtmpEjr+Qnhh/+kBP27G+aZdu
12FJR+ocjsf0JFFM+u/tV6UhuUdpbeEhiI7Mo5cv6AUjvcVoVMhLmB1nvJbZxTU
AsoEOQKBgHHVuuq4kWdfORCYwTvZPX0byQu++Qh1OFfclYBIVuCP4/cU0o3Kw1Z6
tf+zP2rBM015eD7IBHjAt0lNjXcFgiyymNxJDKJSmTpw1VePncmuT5UMq8rb1jSW
Yg0QGwyvB1Cat2mpgqVVS7YT0nmTooWmQdO3Qp48f+bVvmO/dJXS
-----END RSA PRIVATE KEY-----
```

8.2.1.2 Configuration

[Configuring Certificates](#)

[Configuring Keys](#)

[Configuring a certificate with a RSA key in SSL Profile](#)

8.2.1.2.1 Configuring Certificates

Copying a certificate to the Switch

The `copy certificate` command copies the certificate to certificate: file system from any supported source URLs of the copy command.

Example

This command copies a server.crt certificate to certificate: file system.

```
switch#copy file:/tmp/ssl/server.crt certificate:
Copy completed successfully.
```

Errors while Copying the certificates

Examples

- A single source file can contain multiple PEM encoded certificates but only one PEM encoded certificate per file is supported. An error occurs when such multiple PEM encoded file is copied and the copy fails and error is displayed as shown.

```
switch#copy file:tmp/ssl/multi.crt certificate:
% Error copying file:tmp/ssl/multi.crt to certificate:
(Multiple PEM entities in
single file not supported)
```

- An error occurs when a source file containing an invalid PEM encoded certificate is copied. When such files are copied, the copy fails and an error is displayed as shown.

```
switch#copy file:tmp/ssl/bad.crt certificate:
% Error copying file:tmp/ssl/bad.crt to certificate: (Invalid
certificate)
```

- An error occurs when a source file containing a certificate with password protected key is copied. When such files are copied, the copy fails and an error is displayed as shown.

```
switch#copy file:tmp/ssl/pass.key sslkey:
% Error copying file:tmp/ssl/pass.key to sslkey: (Password
protected keys are not
supported)
```



Note: Only certificates with RSA public keys are supported. When a certificate, without RSA public keys, is copied, the copy fails and an error is displayed as shown below.

```
switch#copy file:tmp/ssl/dsa.crt certificate:
% Error copying file:tmp/ssl/dsa.crt to certificate:
(Certificate does not have
RSA key)
```

Deleting a certificate

The `delete` command deletes the certificate configuration from the certificate: file system on switch.

Example

This command deletes the server.crt certificate from the switch.

```
switch#delete certificate:server.crt
```

Generating certificates

The following commands help user to generate a self-signed certificate or certificate signing request (CSR).

Examples

- This command generates a self-signed certificate or certificate signing request (CSR). In the example below an existing private key (test.key) is used to generate the certificates. The generated certificate signing request (CSR) can be viewed on the CLI, whereas a self-signed certificate will be saved to the certificate: file system.

```
switch#security pki certificate generate self-signed test.crt  
key test.key
```

- This command specifies the digest and the validity (in days) of the certificate. The validity is applicable only for self-signed certificates:

```
switch#security pki certificate generate signing-request key  
test.key digest sha256 validity 365
```

- This command adds the certificate parameters such as common-name, country, email and others.

```
switch#security pki certificate generate signing-request key  
test.key parameters common-name Test [country US ...]
```

8.2.1.2.2 Configuring Keys

Copying a key to the Switch

The `copy` command copies the RSA key to sslkey: file system. The key can be copied from any supported source URLs of the copy command.

Example

This command copies a server.key RSA key to sslkey: file system.

```
switch#copy file:/tmp/ssl/server.key sslkey:  
Copy completed successfully.
```

Errors While Copying the keys

Examples

- Generally a single source file can contain multiple PEM encoded keys but only one PEM encoded key per file is supported. An error occurs when such multiple PEM encoded file is copied and the copy fails and error is displayed as shown.

```
switch#copy file:tmp/ssl/multi.key sslkey:
% Error copying file:tmp/ssl/multi.key to sslkey: (Multiple
  PEM entities in
  single file not supported)
```

- An error occurs when a source file containing invalid PEM encoded key is copied. When such files are copied the copy fails, and an error is displayed as shown.

```
switch#copy file:tmp/ssl/bad.key sslkey:
% Error copying file:tmp/ssl/bad.key to sslkey: (Invalid RSA
  key)
```

Deleting a key

The `delete` command deletes the key configuration from the switch.

Example

This command deletes the `server.key` key from the switch.

```
switch#delete sslkey:server.key
```

Generating keys

The following commands help user to generate RSA keys.

Examples

- This command generate a 2048-bit long RSA private key and saves it to `sslkey:test.key`.

```
switch#security pki key generate rsa 2048 test.key
```

- This command generate a 4096-bit long self-signed certificate RSA key and 2048-bit long certificate signing request RSA key.

```
switch#security pki certificate generate self-signed test.crt
  key test.key
generate rsa 4096
switch#security pki certificate generate signing-request key
  test.key
generate rsa 2048
```

8.2.1.2.3 Configuring a certificate with a RSA key in SSL Profile

A SSL profile is configured with a certificate and its corresponding RSA key. The public key information in the certificate must match the RSA key. This certificate and RSA key pair are used to authenticate

to the peer during SSL negotiation. The individual EOS features that use SSL profile configuration will decide whether the certificate and key configuration is optional or mandatory.

Example

```
switch#config
switch(config)#management security
switch(config-mgmt-security)#ssl profile server
switch(config-mgmt-sec-ssl-profile-server)#certificate server.crt
key server.key
```

In case, if the RSA key configured in SSL profile does not match with the configured certificate, the SSL profile state becomes invalid, and an error is displayed.

Example

```
switch(config-mgmt-security)#ssl profile server
switch(config-mgmt-sec-ssl-profile-server)#certificate server.crt
key client.key
switch(config-mgmt-sec-ssl-profile-server)#show management
security ssl profile
```

Profile	State	Error
server	invalid	Certificate 'server.crt' does not match

8.2.1.2.3.1 Configuring SSL Profile with a certificate authority (CA)

During SSL negotiation with mutual authentication, the peer (or client) certificate is verified by checking if it is signed by one of these trusted certificates. For peer certificates that do not have a chain to a trusted certificate, the full bundle of certificates leading to the trusted certificates must be included. The individual EOS features that use SSL profile configuration will decide whether the trusted certificate configuration is optional or mandatory.

Example

```
switch#config
switch(config)#management security
switch(config-mgmt-security)#ssl profile server
switch(config-mgmt-sec-ssl-profile-server)#trust certificate ca1.crt
switch(config-mgmt-sec-ssl-profile-server)#trust certificate ca2.crt
```

8.2.1.2.3.2 Configuring certificate chains

The certificate chains are used to provide a chain of trust for the SSL Profile server certificate to a remote party. Several chain certificate commands can be issued to build a certificate chain with many intermediate CAs, regardless of the order. Use the `chain certificate` command to configure the certificate chain for a SSL profile. The `no` form of the command deletes the certificate configuration.

Examples

- These commands configure the certificate chains for intermediate.crt, assuming that server.crt is issued by an intermediate CA intermediate.crt and intermediate.crt is itself issued by the root CA ca.crt.

```
switch#config
switch#(config)#management security
switch#(config-mgmt-security)#ssl profile server
switch#(config-mgmt-sec-ssl-profile-server)#certificate
server.crt key
server.key
switch#(config-mgmt-sec-ssl-profile-server)#chain certificate
intermediate.crt
```

- The other peer can be configured to trust ca.crt in order to verify the certificate chain during the TLS handshake as shown in the below example.

```
switch#config
switch#(config)#management security
switch#(config-mgmt-security)#ssl profile client
switch#(config-mgmt-sec-ssl-profile-client)#certificate
client.crt key client.key
switch#(config-mgmt-sec-ssl-profile-client)#trust certificate
ca.crt
```

- To check the revocation status of the server certificate chain, the client can add the certificate Revocation List (CRLs) to its SSL profile configuration. One CRL needs to be specified for every CA in the chain, even if its not revoking any certificate.

```
switch#config
switch#(config)#management security
switch#(config-mgmt-security)#ssl profile client
switch#(config-mgmt-sec-ssl-profile-client)#crl intermediate.
crl
switch#(config-mgmt-sec-ssl-profile-client)#crl ca.crl
```

-  **Note:** Both the chain certificate and crl commands look into the certificate: directory to find the right PEM file.

8.2.1.2.3.3 Local certificate checks

The way certificates are verified locally before SSL negotiation can be modified to add or relax some checks. The following are the few checks to perform before any communication with the peer.

Examples

- Check if the certificate has an extended key usage attribute:

```
switch#(config-mgmt-sec-ssl-profile-client)#certificate
requirement extended-key-usage
```

- Check if all the trusted certificates or certificates in the chain have a CA basic constraints set to true.

```
switch#(config-mgmt-sec-ssl-profile-client)#trust certificate
requirement
basic-constraints ca true
switch#(config-mgmt-sec-ssl-profile-client)#chain certificate
requirement
```

```
basic-constraints ca true
```

- Do not mark an expired certificate as invalid.

```
switch(config-mgmt-sec-ssl-profile-client)#certificate policy  
expiry-date ignore
```

8.2.1.2.3.4 Displaying SSL profile status and SSL profile errors

The `show management security ssl profile` command displays the SSL profile status information. To view a specific SSL profile status use the name of the SSL profile, else all SSL profile status are displayed.

Example

This command displays the status of SSL profile server.

```
switch#show management security ssl profile server  
Profile      State  
-----  
server       valid
```

If there are any errors in the SSL profile, an **invalid** state is displayed and the errors are listed in the third column. Once the error is fixed, the SSL profile becomes **valid**.

Examples

- When the certificate 'server.crt' does not match with the key the following error is shown.

```
switch#show management security ssl profile server  
Profile      State      Error  
-----  
server       invalid    Certificate 'server.crt' does not  
match                               with key
```

- When a trusted certificate 'ca2.crt' does not exist the following error is shown.

```
switch#show management security ssl profile server  
Profile      State      Error  
-----  
server       invalid    Certificate 'ca2.crt' does not  
exist
```

- When a trusted certificate 'foo.crt' is not self-signed root certificate the following error is shown.

```
switch#show management security ssl profile server  
Profile      State      Error  
-----  
server       invalid    Certificate 'foo.crt' is trusted  
and not
```

a root certificate

- When the certificate 'server.crt' is expired the following error is shown.

```
switch#show management security ssl profile server
  Profile          State      Error
  -----
  server           invalid   Certificate 'server.crt' has
  expired
```

- When the certificate chain is missing an intermediate certificate the following error is shown.

```
switch#show management security ssl profile server
  Profile          State      Error
  -----
  server           invalid   Profile has invalid certificate
  chain
  does not exist   Certificate 'intermediate.crt'
```

8.2.1.3 Rotating Certificate and Key Pair

The certificate and key pair used in SSL profile can be rotated using rotation commands. For example, let's say we want to rotate **cert.pem** and **key.pem** in the SSL profile profile01.

```
switch01#show running-config section ssl
management security
ssl profile profile01
certificate cert.pem key key.pem
```

Run the `security pki certificate generate signing-request rotation ssl profile` command to generate a new key and corresponding signing request for SSL profile profile01. This command also generates a unique rotation ID that can be later used to import the certificate.

```
switch01#security pki certificate generate signing-request rotation ssl
  profile profile01 key generate rsa 2048 parameters common-name switch01
Rotation ID: 2ad7771e8cbc11ebbba37483ef8d9c4b
Certificate Signing Request:
-----BEGIN CERTIFICATE REQUEST-----
MIICZzCCAUA8CAQAwEzERMA8GA1UEAwIc3dpdGNoMDEwggEiMA0GCSqGSIb3DQEB
AQUAA4IBDwAwggEKAoIBAQCy5EsczfeZ1AVNZQ8/nfRgEF3bg/tz0XrQJwP/zHhI
UFx1A1VI407XhUrYReH1h40QWhXXX0AHTLTsaClJWHH9m7SXb4iZVo/Y1zXGdyju
1FmnWnNDi72M8f60WXG9gAMtnZK9K53A3lwvrKS+CwJkLCOjlH4xyp1Wsgl+yfay
AdfXAJ+s1Vmg3Rux/XR8iP3N620YVbQ+AfWUQkSNFSsykcTeLvX2WybqX4p4Kids
nqU28ml/NZPS5wEc20XhagrBn3jHbxdmI33/4SJHN8iNZ6h+gQz+JI18bQrlTHng
RzAx1ENvz7ZzzzE/n/wh/ArZ6Q9aojrBtAk55aGuY4hAgMBAAGgDzANBgkqhkiG
9w0BCQ4xADANBgkqhkiG9w0BAQsFAAOCAQEAgwQbAsdw6UhpvjDk8OdmXLgCNOSC
jGFLFZe4I67gDmyGQR2lG1brRTQPKp7OphpPxaqr3YvxErEFdQ35gvIUyo9j8qp1
F22yAZGjLqU3prnGLEAZ/I3PcdiVNVzL9UJw/JMfHI1CMH6yGtbEI2BXsCTetfxm
JE+N9ujfB1Q/MjUR6IszNxEB2YkFh/DvnVUHoqV0ka+JRmMhGkmTrXwad8bhxYZs
g7cwXktsMLuy2otK21fkFcRvd9OHXssJ2Mf7914ALiDe2sfixHX+35SytR8bahTk
z09HPCkxJmfl+cdhS9SWXrXpHHwXicjwYCj1lpqZulBFXtgnVs2Kmd3NnRA==
-----END CERTIFICATE REQUEST-----
```

The complete syntax of the above command is as follows. The **import-timeout** specifies the timeout for this rotation ID. If no certificate is imported within this timeout, the rotation ID expires and will be deleted.

```
switch#security pki certificate generate signing-request rotation ssl
  profile <profile-name>
key generate rsa <2048|3072|4096>
[ import-timeout <minutes> ] (default: 60 mins)
[ digest <sha256|sha384|sha512> ] (default: sha256) parameters common-
name <common-name>
[ country <country-code> ]
[ state <state-name> ]
[ locality <locality-name> ]
[ organization <org-name> ]
[ organization-unit <org-unit-name> ]
[ email <email> ]
[ subject-alternative-name [ ip <ip1 ip2 ...> ]
[ dns <nml nm2 ...> ] [ dns <nml nm2 ...> ]
```

Use the `show security pki certificate rotation` command to view the status of rotation IDs.

Example

```
switch#show security pki certificate rotation
  Rotation ID                               Profile Name           State
  Expiry
-----
  2ad7771e8cbc11ebba37483ef8d9c4b         profile01             Import
  Pending      2021-03-24 10:15:37
```

Copy the signing request, get it signed by a CA and import the certificate using the `security pki certificate rotation import <rotation-id>` command. Use the rotation ID that was generated with the signing request.

```
switch#security pki certificate rotation import 2ad7771e8cbc1
1ebba37483ef8d9c4b
Enter TEXT certificate. Type 'EOF' on its own line to end.
-----BEGIN CERTIFICATE-----
MIICnTCCAYWgAwIBAgIJANzHst31jdWfMA0GCSqGSIb3DQEBCwUAMA4xDDAKBgNV
BAMMA2ZvbzAeFw0yMTAzMjQxNjYMDdaFw0yMjAzMjQxNjYMDdaMA4xDDAKBgNV
BAMMA2ZvbzCCASIdQYJKoZIhvcNAQEBBQADggEPADCCAQoCggEBAK2LhqPnQ3Oz
1Pg1PB5toNyCNB60IdCDUVXZcwmyCgS6ifwBYgmw/mCq3iOFncEilaCNIkaFKiWf
b7s43jQd9tmAbnnQw3xU08jDweus+yCumMNjLLQApbTOZDE4zDonmbWh6kswh8qI
batiz9wR7l5K1bPbbmQx6nO28LrcLCuFSZWrw4R2nprQxdoo5eAotMsGDQdh2vn7
k4yD0CQGVcquVzKI+iVgW7yIfiz9cwWdFTALtmkrqQsq+edZmvnuNcOaZm22R5Sb
aPy9osv82ozk8iMX+oDYddY2wMQzLd7ByWlAh4bzCJxNMPiZ8hrxU84up0I4srXi
xDVXdL1d2JsCAwEAATANBgkqhkiG9w0BAQsFAAOCAQEADkjfoBx7BAVFDIjyWHL
ID+9D1t96JvCe+PDUyggow6iZE8R0q2fIFHuXhXMrd/neN3WtxqtjvGBnS49t4fa
qIcjerkiPwLaBSwWdpm/1FrIFejYqU0symRE3bKJULLBEdQhyox37D2uqPm71ado
5rXCX9pSu2oNOThd/877QKxtrKa5pekxlacxEa4E0QJ0/YPwKA5nCzM9jy7DZlH2
+cdtCxREeq1hOJUJxQ2354LyykU2fOXe6AGGdVE9hdIOJDnG26VVb+gFt2qaKD5+
3D3/Gdlpm4P3+9aENlhAcr0PUoL3xUApeIdkEf7n8KHiNP+gmlPyVDTCAudwHnwg
Vg==
-----END CERTIFICATE-----
EOF
Success
```

Commit the rotation ID using the `security pki certificate rotation commit <rotation-id>` command. This will rotate **cert.pem** and **key.pem** of SSL profile **profile01** with new certificate and key.

```
switch#security pki certificate rotation commit 2ad7771e8cbcl
1ebba37483ef8d9c4b
Success
```



Note: If the key is generated outside EOS, then instead of the above workflow, we can rotate the certificate and key pair using a single command as below:

```
switch#security pki certificate rotation commit ssl profile
profile01
Enter TEXT private key. Type 'EOF' on its own line to end.
-----BEGIN PRIVATE KEY-----
MIIEvAIBADANBgkqhkiG9w0BAQEFAASCbKYwggSiAgEAAoIBAQCti4aj50Nzs9T4
NTwebaDcgjQetCHQg1FV2XMJsgoEuon8AWIJsP5gqt4jhZ3BIpWgjSJGhSoln2+7
ON40HfbZgG550MN8VDvIw8HrrPsgprjDYyy0AKW0zmQxOMw6J5mloepLMIfKiG2r
Ys/cEe5eStWz225kMepztvc63CwrhUmVq80Edp6a0MXaK0XgKLTlBg0HYdr5+50M
g9AkBlQqrlyciPolYFu8iH4mfXMFnrUwJU5pK6kLKvnnWZr57jXDmmZttkeUm2j8
vaLL/NqGZPIjF/qA2HXWNSDEMY3ewclpQIEg8wicTTDyM/Ia8VPOLqdCOLK14sQ1
V3S9XdbAgMBAECCggEAEdMMLSD4HTVzDFoBW8mlpQ10G/TNBd1Sk7gY0FV9JCLM
OIPmfzHdeKoB15lcv691DIARp8cQM8A21ab5tKr2JOTuMnDaffXIagyikzb0/tQT
lqhaFeHaHCTFP4yBQKBgQDczahFFYJRP0jot4Hu
iywlkhhbyOHV7b9xuPPhqwQxFYqHvEE0qBnmjBzXujbpdv+V18QFGyl0uH4mHr+lt
izcyAbEx5YL/y5Vu08bITZr0mUxS0ZkDXg6n6GKJVIPUH05xSZb/eqtSFIq/DsBQ
YSwu6WzOj4dNpEQAE8jMmGalwKBgQDJNWTNyc2JgDYmf039gWNEOY+UuJQ3v/Jo
Ei2IHG4ISxVlZc9lZgLuWHDyS6zNOIeSAYIzDVSsRAGH9sWaK4E4Yno4KHptRC5F
MEbtnrojTO2ANC9JcWo2EgP31r10JolFpKUiPhOEazdEYd/sdp9tWEusszTrn8fb
PHvSHUFknQKBgDe8VhByOH4HyoCRqUusp80oDlDAPa+V8f+FtnNEHbPaDORKqh/E
mKmlZUC9V+DEIRjfaCIVbOX6of21Quga7yjZUoA03hdxrVvXa2Mea9H4bFKvg79c
27g4qb7erZQ6/tML72i370z90HQf5h2kGcIRvBx8EHxhzaSmtetNiV0rAoGAP3Qz
QiJrGf3xFborwlNa6F0uxrwlIiXkKl+K1G4C1WK4cK3W5idxrTD/DaqH6IB3YLhR
E0CU/27C/Nn6H1Cx9MqsCMz2NmzreY3uCBimldbXx8V+pd1439y+Ooj8U195RSz
b0UcanmJKGulbrFKPfwMh+RMQDK3mJBOjEjlopECgYAR6F+60TZ7ZAvA0vZ9Plrn
tzvY7GhopJgJfAvfi5nBXPS+fkdKtWzOmHw1jonlka0fEerQnQjB7DSYB4zldufPKid+
EXgJtQbhS
qfdtgL7QlhVrp0/s5tUrPE/KRu/yLgTEWruQlDCawpMPA63eP4XER/MHVXBkqbWy
85vx46SisOBAnuEum0yMngru5fARoBKO1aV7G94FI7Eu5rdqeVYsE5jrdnWJTZTg
pHf9RYU0lZ8RwwbD/xUs+cKbMlqhaFeHaHCTFP4yBQKBgQDczahFFYJRP0jot4Hu
iywlkhhbyOHV7b9xuPPhqwQxFYqHvEE0qBnmjBzXujbpdv+V18QFGyl0uH4mHr+lt
izcyAbEx5YL/y5Vu08bITZr0mUxS0ZkDXg6n6GKJVIPUH05xSZb/eqtSFIq/DsBQ
YSwu6WzOj4dNpEQAE8jMmGalwKBgQDJNWTNyc2JgDYmf039gWNEOY+UuJQ3v/Jo
Ei2IHG4ISxVlZc9lZgLuWHDyS6zNOIeSAYIzDVSsRAGH9sWaK4E4Yno4KHptRC5F
MEbtnrojTO2ANC9JcWo2EgP31r10JolFpKUiPhOEazdEYd/sdp9tWEusszTrn8fb
PHvSHUFknQKBgDe8VhByOH4HyoCRqUusp80oDlDAPa+V8f+FtnNEHbPaDORKqh/E
mKmlZUC9V+DEIRjfaCIVbOX6of21Quga7yjZUoA03hdxrVvXa2Mea9H4bFKvg79c
27g4qb7erZQ6/tML72i370z90HQf5h2kGcIRvBx8EHxhzaSmtetNiV0rAoGAP3Qz
QiJrGf3xFborwlNa6F0uxrwlIiXkKl+K1G4C1WK4cK3W5idxrTD/DaqH6IB3YLhR
E0CU/27C/Nn6H1Cx9MqsCMz2NmzreY3uCBimldbXx8V+pd1439y+Ooj8U195RSz
b0UcanmJKGulbrFKPfwMh+RMQDK3mJBOjEjlopECgYAR6F+60TZ7ZAvA0vZ9Plrn
tzvY7GhopJgJfGr1GYQPJi38DJ5NR/w64js21t5X2yJ4xcCB3H7R0QWJ9EE+fc+7
nBYFJlaDzSRBbES24yGh4n4Vc6luYW9A+YJR3Eae1E6RMWyzIY8J8kV2xuTaK9xe
pdM9x1J1kIm2rAlmcO4Xqw==
-----END PRIVATE KEY-----
EOF
Enter TEXT certificate. Type 'EOF' on its own line to end.
-----BEGIN CERTIFICATE-----
MIICnTCCAYWgAwIBAgIJANzHst3ljdwfMA0GCSqGSIb3DQEBCwUAMA4xDDAKBgNV
BAMMA2ZvbzAeFw0yMTAzMjQxNjAyMDdaFw0yMjAzMjQxNjAyMDdaMA4xDDAKBgNV
BAMMA2ZvbzCCASIdQYJKoZIhvcNAQEBBQADggEPADCCAQoCggEBBAK2LhqPnQ3Oz
1Pg1PB5toNycNB60IdCDUVXZcwmyCgS6ifwBYgmw/mCq3iOfncEilaCNIkaFKiWf
```

```

b7s43jQd9tmAbnnQw3xUO8jDweus+yCumMNjLLQApbTOZDE4zDonmbWh6kswh8qI
batiz9wR715K1bPbbmQx6nO28LrcLCuFSZWrw4R2nprQxdoo5eAotMsGDQdh2vn7
k4yD0CQGVCquVzKI+iVgW7yIfiz9cwWdFTA1TmkrqQsq+edZmvnuNcOaZm22R5Sb
aPy9osv82ozk8iMX+oDYddY2wMQzLd7ByWlAh4bzCJxNMPIz8hrxU84up0I4srXi
xDVXdL1d2JsCAwEAATANBgkqhkiG9w0BAQsFAAOCAQEADkj fobxF7BAVfDIjyWHL
ID+9D1t96JvCe+PDUyggow6iZE8ROq2fIFHuXhXMrd/eneN3WtxqtjvGBnS49t4fa
qIcjerkiPwLaBSwWdpm/1FrIFejYqU0symRE3bKJULLBEDQhyox37D2uqPm71ado
5rXCX9pSu2oNOThd/877QKxtrKa5pekx1acxEa4E0QJ0/YPwKA5nCzM9jy7DZ1H2
+cdtCxREeqlhOJUJxQ2354LyykU2fOXe6AGGdVE9hdIOJDnG26VVb+gFt2qaKD5+
3D3/Gd1pm4P3+9aENlhAcr0PUoL3xUApeIdkEf7n8KHINP+gmlPyVDTCAudwHnwq
Vg==
-----END CERTIFICATE-----
EOF
Success

```

Once the certificate and key pair is rotated, use the `show management security ssl certificate cert.pem` and `show management security ssl key key.pem` commands to display the new contents.

8.2.1.4 Resetting Diffie-Hellman Parameters

The Diffie-Hellman parameters file is used for symmetric key exchange during SSL negotiation. When the system is booted, the system auto generates a Diffie-Hellman parameters file if one does not exist. To reset the auto generated Diffie-Hellman parameters file, use the `reset` command. The individual features that use SSL profile configuration will decide whether they also use the Diffie-Hellman parameters file. The switch uses 2048-bit Diffie-Hellman parameters with no options to select the size.

 **Note:** Not all features that use SSL profile configuration will use Diffie-Hellman parameters file.

Example

This command resets the Diffie-Hellman parameters file.

```
switch#reset ssl diffie-hellman parameters
```

8.2.1.4.1 Displaying the Diffie-Hellman parameters

The `show management security ssl diffie-hellman` command displays the Diffie-Hellman parameters.

Example

This command displays the Diffie-Hellman parameters.

```

switch#show management security ssl diffie-hellman
Last successful reset on Apr 10 16:18:08 2015
Diffie-Hellman Parameters 1024 bits
Generator: 2
Prime:      dc47b5edc0d2b41451432f79f45efab452bba7b1ab118c194d67
1d6752ed1c550
           664ed8f052ad0fdad623c1d54ae5aee5e728d2bd7a6221636b78
7a4c08d1fef8c
           6dcd10759d38f8b70b47d1c7972d69b0b295a2ee6ab44cfc7352
cb133e85197c8

```

```
9f1fc27aac7e8e02afb4fb01ca1cb05558a7bef505b73a8d06cd
fe403576b
```

8.2.1.5 Configuring the TLS Handshake Settings

During a TLS handshake, both peers send each other a list of the TLS versions they support as a way to agree on and use the highest common version. In a SSL profile the following allowable versions can be configured using the `tls versions` command. By default, TLSv1, TLSv1.1 and TLSv1.2 are enabled.

Examples

- This command will force TLSv1.2 to be used. If the other peer doesn't support this version, the TLS handshake will fail.

```
switch#config
switch#(config)#management security
switch(config-mgmt-security)#ssl profile client
switch(config-mgmt-sec-ssl-profile-client)#
switch(config-mgmt-sec-ssl-profile-client)#tls versions 1.2
```

- These commands add support for TLSv1.1 on top of the already configured TLSv1.2.

```
switch(config-mgmt-sec-ssl-profile-client)#tls versions add
1.1
switch(config-mgmt-sec-ssl-profile-client)#tls versions 1.1
1.2
```

Similarly to the TLS version, the cipher suite is negotiated between the client and the server during a TLS handshake. Ideally, the client will send the list of cipher suites it supports and the server will choose a common cipher suite after looking at the client's list as well as its own list of cipher suites. The cipher-list setting here is an Open SSL cipher string that is **HIGH:!NULL:!MD5**, which only allows key length larger than 128 bits and forbids cipher suites using MD5. The full list of cipher suites can be expanded using the shell command **openssl ciphers HIGH:!NULL:!MD5**

Example

This command builds a cipher suite list.

```
switch(config-mgmt-sec-ssl-profile-client)#cipher-list AESGCM
switch(config-mgmt-sec-ssl-profile-client)#cipher-list
SHA256:SHA384
switch(config-mgmt-sec-ssl-profile-client)#cipher-list ECDHE-
ECDSA-AES256-GCM-SHA384
```

8.2.1.5.1 Enabling the Federal Information Processing Standards (FIPS) Mode

Federal Information Processing Standards (FIPS) is a cryptographic standard used to restrict the cryptographic functions and protocol versions that are used by OpenSSL.

Example

This command enables the FIPS mode for a SSL profile.

```
switch(config-mgmt-sec-ssl-profile-client)#fips restrictions
```

8.2.1.6 Displaying Certificate and Key Information

[Displaying Certificate Information](#)

[Displaying Key Information](#)

8.2.1.6.1 Displaying Certificate Information

Displaying the directory information

The `dir` command displays the directory output of certificate file systems.

Example

This command displays the directory output of certificate: file-system.

```
switch#dir certificate:
Directory of certificate:/
-rw- 3319 Apr 10 11:50 server.crt
No space information available
```

Displaying the certificate information

The `show management security ssl certificate` command displays the certificate information. To view a specific certificate use the name of the certificate, else all the certificates are displayed.

Example

This command displays the server.crt certificate information.

```
switch#show management security ssl certificate server.crt
Certificate server.crt:
Version:                1
Serial Number:          9
Issuer:
  Common name:           ca
  Email address:         ca@foo.com
  Organizational unit:   Foo Org
  Organization:          Foo
  Locality:              SC
  State:                 CA
  Country:               US
Validity:
  Not before:            Aug 11 21:44:17 2014 GMT
  Not After:             May 14 21:44:17 2069 GMT
Subject:
  Common name:           server
```

```

Email address:      server@arista.com
Organizational unit: Foo Org
Organization:      Foo
Locality:          SC
State:             CA
Country:           US
Subject public key info:
Encryption Algorithm: RSA
Size:              2048 bits
Public exponent:   65537
Modulus:           e04e3ff8e1c64dbcb141fe9613
3f998e90a322c671b9f28307bf873
                   2239f69804a77fbb8f146841eb
6253b7bb50bf6c66bbf3097ec695b
                   0d7985cfdd939c9913b4ba4f6c
b8655b208ed0254a269ecab574987
                   ea5ee80085f5216d303cf70437
2b2fa1aae62756c3762441fcc1c04
                   635a831d5ec96d841

```

Displaying Certificate Revocation List (CRL) information

The **show management security ssl crl** command displays the installed Certificate Revocation List (CRL) information. To view a specific CRL use the name of the CRL, else all the CRLs are displayed.

Example

This command displays the intermediate.crl information.

```

switch#show management security ssl crl intermediate.crl
CRL intermediate.crl:
  CRL Number: 11
  Issuer:
    Common name: intermediate
    Email address: intermediate@foo.com
    Organizational unit: Foo Org
    Organization: Foo
    State: CA
    Country: US
  Validity:
    Last Update: Jul 19 19:27:34 2016 GMT
    Next Update: Dec 05 19:27:34 2043 GMT

```

8.2.1.6.2 Displaying Key Information

Displaying the directory information

The **dir** command displays the directory output of SSL key file systems.

Example

This command displays the directory output of sslkey: file-system.

```

switch#dir sslkey:

```

```
Directory of sslkey:/
-rw- 1675 Apr 10 12:55 server.key
No space information available
```

Displaying the RSA key information

The **show management security ssl key** command displays the RSA key information. To view a specific RSA key use the name of the key, else all the keys are displayed. For security reasons, only the public part of the key is displayed.

Example

This command displays the server.key key information.

```
switch#show management security ssl key server.key
Key server.key:
  Encryption Algorithm: RSA
  Size:                2048 bits
  Public exponent:    65537
  Modulus:            e04e3ff8e1c64dbcb141fe96133f998e90a322c
671b9f28307bf873
                    2239f69804a77fbb8f146841eb6253b7bb50bf6
c66bbf3097ec695b
                    0d7985cfd939c9913b4ba4f6cb8655b208ed02
54a269ecab574987
                    b502f8c3f541fa3bae59743cced6e6ca04f6ca6
c9268744add79c3a
                    f8178d12dd744ddf5db100b33c46b40e53f0a1c
7d49f83488976c5d
```

8.2.1.7 TLS Commands

Configuration Commands

- `copy file: certificate:`
- `copy file: sslkey:`
- `delete certificate:`
- `delete sslkey:`
- `dir certificate:`
- `dir sslkey:`
- `reset ssl diffie-hellman parameters`
- `security pki certificate generate`
- `security pki key generate`
- `ssl profile`

Show Commands

- `show management security ssl certificate`
- `show management security ssl crl`
- `show management security ssl diffie-hellman`
- `show management security ssl key`
- `show management security ssl profile`

8.2.1.7.1 copy file: certificate:

The **copy file: certificate:** command copies the certificate to certificate: file system. The certificate can be copied from any supported source URLs of the **copy** command.

Command Mode

Global Configuration

Command Syntax

```
copy file: file_name certificate:
```

Parameters

- *file_name* location or the path of the file or the directory where the certificate is saved.

Guidelines

The following points to be considered while using the copy command:

- Generally a single source file can contain multiple PEM encoded certificates but only one PEM encoded certificate per file is supported. An error occurs when such multiple PEM encoded file is copied and the copy fails and displays an error.
- An error occurs when a source file containing invalid PEM encoded certificate is copied. When such files are copied the copy fails, and displays an error.
- An error occurs when a source files containing a certificate with password protected key is copied. When such files are copied the copy fails, and displays an error.

The following errors occur while copying the certificates:

- When multiple PEM encoded certificates are copied, the copy task fails and the following error is displayed.

```
switch(config)#copy file:tmp/ssl/multi.crt certificate:
% Error copying file:tmp/ssl/multi.crt to certificate: (Multiple PEM
entities in
single file not supported)
```

- When a source file containing invalid PEM encoded certificate is copied, the copy task fails and the following error is displayed.

```
switch(config)#copy file:tmp/ssl/bad.crt certificate:
% Error copying file:tmp/ssl/bad.crt to certificate: (Invalid
certificate)
```

- When a source file containing a certificate with password protected key is copied, the copy task fails and the following error is displayed.

```
switch(config)#copy file:tmp/ssl/pass.key sslkey:
% Error copying file:tmp/ssl/pass.key to sslkey: (Password protected
keys are not
supported)
```

- Only certificates with RSA public keys are supported. When a certificate without RSA public key is copied the copy fails, and an error is displayed.

```
switch(config)#copy file:tmp/ssl/dsa.crt certificate:
% Error copying file:tmp/ssl/dsa.crt to certificate: (Certificate does
not have
RSA key)
```

Example

This command copies a server.crt certificate to certificate: file system.

```
switch(config)#copy file:/tmp/ssl/server.crt certificate:  
Copy completed successfully.
```

8.2.1.7.2 copy file: sslkey:

The **copy file: sslkey:** command copies the SSL key to the sslkey: file system. The key can be copied from any supported source URLs of the **copy** command.

Command Mode

Global Configuration

Command Syntax

```
copy file: file_name sslkey:
```

Parameters

file_name location or the path of the file or the directory where the key is saved.

Guidelines

The following points to be considered while using the copy command:

- Generally a single source file can contain multiple PEM encoded keys but only one PEM encoded key per file is supported. An error occurs when such multiple PEM encoded file is copied and the copy fails and shows an error.
- An error occurs when a source file containing invalid PEM encoded key is copied. When such files are copied the copy fails, and shows an error.

The following errors occur while copying the certificates:

- When multiple PEM encoded keys are copied, the copy fails and the following error occurs.

```
switch#copy file:tmp/ssl/multi.key sslkey:
% Error copying file:tmp/ssl/multi.key to sslkey: (Multiple PEM
entities in
single file not supported)
```

- When a source file containing invalid PEM encoded key is copied, the following error occurs.

```
switch#copy file:tmp/ssl/bad.key sslkey:
% Error copying file:tmp/ssl/bad.key to sslkey: (Invalid RSA key)
```

Example

This command copies a server.key key to the sslkey: file system.

```
switch(config)#copy file:/tmp/ssl/server.key sslkey:
Copy completed successfully.
```

8.2.1.7.3 delete certificate:

The **delete certificate:** command deletes a specified certificate from certificate: file system on the switch.

Command Mode

Global Configuration

Command Syntax

```
delete certificate: certificate_name
```

Parameters

certificate_name name of the certificate to be deleted.

Example

This command deletes the server.crt certificate from the switch.

```
switch(config)#delete certificate:server.crt
```

8.2.1.7.4 delete sslkey:

The `delete sslkey:` command deletes a SSL key from sslkey: file system on a switch.

Command Mode

Global Configuration

Command Syntax

```
delete sslkey: key_name
```

Parameters

key_name name of the key.

Example

This command deletes the server.key SSL key on the switch.

```
switch(config)#delete sslkey:server.key
```

8.2.1.7.5 `dir certificate:`

The `dir certificate:` command displays the directory output of certificate: file system on the switch.

Command Mode

Global Configuration

Command Syntax

`dir certificate:`

Example

This command shows the directory output of certificate: file system on the switch.

```
switch(config)#dir certificate:
Directory of certificate:/
  -rw- 3319 Apr 10 11:50 server.crt
No space information available
```

8.2.1.7.6 `dir sslkey:`

The `dir sslkey:` command displays the directory output of `sslkey:` file system on the switch.

Command Mode

Global Configuration

Command Syntax

`dir sslkey:`

Example

This command shows the directory output of `sslkey:` file system on the switch.

```
switch(config)#dir sslkey:  
Directory of sslkey:/  
  -rw- 1675 Apr 10 12:55 server.key  
No space information available
```

8.2.1.7.7 reset ssl diffie-hellman parameters

The `reset ssl diffie-hellman parameters` command resets the Diffie-Hellman parameters file after a system reboot.

Command Mode

Global Configuration

Command Syntax

```
reset ssl diffie-hellman parameters
```

Example

This command resets the Diffie-Hellman parameters file.

```
switch(config)#reset ssl diffie-hellman parameters
switch(config)#
```

8.2.1.7.8 security pki certificate generate

The **security pki certificate generate** command is used to generate a self-signed certificate or a certificate signing request (CSR) certificate. The generated CSR is displayed on the CLI, whereas a self-signed certificate is saved to the certificate: file system.

Many other parameters can be entered and applied to the certificate as shown in the following examples below.

Command Mode

Global Configuration

Command Syntax

```
security pki certificate generate {self-signed | signing-request} certificate_name  
Key key_name
```

Parameters

- *certificate_name* name of the certificate to generate. Options includes.
 - self-signed request to generate self-signed certificate.
 - signing-request request to generate signing-request.
 - **digest** signs the certificate or key with the following cryptographic hash algorithm (sha256, sha384, sha512).
 - *key_name* name of the key to modify.
- *parameters* signing request parameters for a certificate. Option includes.
 - **common-name** common name for use in subject.
 - **country** two-letter country code for use in subject
 - **email** email address for use in subject
 - **locality** locality name for use in subject
 - **organization** organization name for use in subject
 - **organization-unit** organization Unit Name for use in subject
 - **state** state for use in subject
 - **subject-alternative-name** subject alternative name extension
 - **rotation** to generate a unique rotation ID
- **validity** validity of the certificate in days. Value ranges from 1 to 30000 .

Examples

- This command generates a self-signed certificate or CSR certificate. In the example below an existing private key (test.key) is used to generate the certificates.

```
switch(config)#security pki certificate generate self-signed test.crt  
key test.key
```

- This command specifies the digest and the validity (in days) of the certificate or key.

```
switch(config)#security pki certificate generate signing-request key  
test.key digest sha256 validity 365
```

- This command adds the certificate parameters such as common-name, country, email, and others.

```
switch(config)#security pki certificate generate signing-request key  
test.key parameters common-name Test [country US ...]
```

8.2.1.7.9 security pki key generate

The **security pki key generate** command generates a RSA key used to validate a specific certificate.

The key generated can be modified and saved by entering the value of the length in **generate rsa <length>** parameter.

Command Mode

Global Configuration

Command Syntax

```
security pki key generate rsa key_name
```

Parameters

- *rsa* use Rivest-Shamir-Adleman (RSA) algorithm. Options include.
 - **2048** Use 2048-bit keys
 - **3072** Use 3072-bit keys
 - **4096** Use 4096-bit keys
- *key_name* name of the key to generate.

Examples

- This command generates a a 2048-bit long RSA private key(test.key) and save it to sslkey:test.key.

```
switch(config)#security pki key generate rsa 2048 test.key
```

- This command modifies the generated RSA key length value.

```
switch(config)#security pki certificate generate self-signed test.crt  
key  
test.key generate rsa 4096  
switch(config)#security pki certificate generate signing-request key  
test.key  
generate rsa 2048
```

8.2.1.7.10 show management security ssl certificate

The **show management security ssl certificate** command displays information about the certificate. Provide the name of the certificate if you want to view more information of the certificate. If no name is provided, this command displays information of all the certificates.

Command Mode

EXEC

Command Syntax

```
show management security ssl certificate [certificate_name]
```

Parameter

certificate_name name of the certificate. This is optional.

Example

This command displays the server.crt certificate information.

```
switch#show management security ssl certificate server.crt
Certificate server.crt:
Version:                1
Serial Number:          9
Issuer:
  Common name:           ca
  Email address:         ca@foo.com
  Organizational unit:   Foo Org
  Organization:          Foo
  Locality:              SC
  State:                 CA
  Country:               US
Validity:
  Not before:            Aug 11 21:44:17 2014 GMT
  Not After:             May 14 21:44:17 2069 GMT
Subject:
  Common name:           server
  Email address:         server@arista.com
  Organizational unit:   Foo Org
  Organization:          Foo
  Locality:              SC
  State:                 CA
  Country:               US
Subject public key info:
Encryption Algorithm:   RSA
Size:                   2048 bits
Public exponent:        65537
Modulus:                e04e3ff8e1c64dbcb141fe96133f998e90a322c671b9f28307bf873
                        2239f69804a77fbb8f146841eb6253b7bb50bf6c66bbf3097ec695b
                        0d7985cfd939c9913b4ba4f6cb8655b208ed0254a269ecab574987
                        9f54c8c7f0b3a57a7ab826870119083222ad5ee76d40f3fae49d36e
                        b502f8c3f541fa3bae59743cced6e6ca04f6ca6c9268744add79c3a
                        c08af6b451455b4a61071f4c0b3ec3553585312783e9381f65bb0e2
                        ea5ee80085f5216d303cf704372b2fa1aae62756c3762441fcc1c04
                        97ee6190586ed28c0e376f48e53f05a40c7e1f3a65e3c6165bae5df
                        f8178d12dd744ddf5db100b33c46b40e53f0a1c7d49f83488976c5d
                        635a831d5ec96d841
```

8.2.1.7.11 show management security ssl crl

The **show management security ssl crl** command displays the basic information on the installed certificate revocation list (CRLs). To view information of a specific CRL provide the name of the CRL. If no name is provided, this command shows information of all the CRLs.



Note: The command only shows basic information and does not show any information on the revocation status of certificates.

Command Mode

EXEC

Command Syntax

```
show management security ssl crl
```

Example

This command displays the basic information of the intermediate.crl CRL.

```
switch#show management security ssl crl intermediate.crl
CRL intermediate.crl:
  CRL Number: 11
  Issuer:
    Common name: intermediate
    Email address: intermediate@foo.com
    Organizational unit: Foo Org
    Organization: Foo
    State: CA
    Country: US
  Validity:
    Last Update: Jul 19 19:27:34 2016 GMT
    Next Update: Dec 05 19:27:34 2043 GMT
```

8.2.1.7.12 show management security ssl diffie-hellman

The **show management security ssl diffie-hellman** command displays the Diffie-Hellman parameter information.

Command Mode

EXEC

Command Syntax

```
show management security ssl diffie-hellman
```

Example

This command displays the Diffie-Hellman parameter information.

```
switch#show management security ssl diffie-hellman  
Last successful reset on Apr 10 16:18:08 2015  
Diffie-Hellman Parameters 1024 bits  
Generator: 2  
Prime:      dc47b5edc0d2b41451432f79f45efab452bba7b1ab118c194d67  
1d6752ed1c550  
           664ed8f052ad0fdad623c1d54ae5aee5e728d2bd7a6221636b78  
7a4c08d1fef8c  
           6dcd10759d38f8b70b47d1c7972d69b0b295a2ee6ab44cfc7352  
cb133e85197c8  
           9f1fc27aac7e8e02afb4fb01ca1cb05558a7bef505b73a8d06cdfe403576b
```

8.2.1.7.13 show management security ssl key

The **show management security ssl key** command displays the RSA key information. To view information of a specific key, provide the name of the key in the command. If no name is provided, this command displays information of all the keys.

 **Note:** For security reasons, only the public part of the key is shown.

Command Mode

EXEC

Command Syntax

show management security ssl key [*key_name*]

Parameter

key_name name of the key. This is optional.

Example

This command displays the server.key key information.

```
switch#show management security ssl key server.key
Key server.key:
Encryption Algorithm: RSA
Size:                2048 bits
Public exponent:     65537
Modulus:             e04e3ff8e1c64dbcb141fe96133f998e90a322c
671b9f28307bf873
                    2239f69804a77fbb8f146841eb6253b7bb50bf6
c66bbf3097ec695b
                    0d7985cfd939c9913b4ba4f6cb8655b208ed02
54a269ecab574987
                    9f54c8c7f0b3a57a7ab826870119083222ad5ee
76d40f3fae49d36e
                    b502f8c3f541fa3bae59743cced6e6ca04f6ca6
c9268744add79c3a
                    c08af6b451455b4a61071f4c0b3ec3553585312
783e9381f65bb0e2
                    ea5ee80085f5216d303cf704372b2fa1aae6275
6c3762441fcc1c04
                    97ee6190586ed28c0e376f48e53f05a40c7e1f3
a65e3c6165bae5df
                    f8178d12dd744ddf5db100b33c46b40e53f0a1c
7d49f83488976c5d
                    635a831d5ec96d841
```

8.2.1.7.14 show management security ssl profile

The **show management security ssl profile** command displays the SSL profile status information. To display information of a specific SSL profile, provide the name of the profile. If no name is provided, this command displays profile status of all the SSL profiles.

If there are any errors in the SSL profile, the state is shown invalid and the errors are listed in the third column as shown in the example below.

Command Mode

EXEC

Command Syntax

```
show management security ssl profile [profile_name]
```

Parameter

profile_name name of the SSL profile, this is optional.

Examples

- This command displays the SSL profile status of profile server.

```
switch#show management security ssl profile server
Profile      State
-----
server       valid
```

- If the certificate 'server.crt' does not match with the key the following error occurs.

```
switch#show management security ssl profile server
Profile      State      Error
-----
server       invalid    Certificate 'server.crt' does not match
with key
```

- If a trusted certificate 'ca2.crt' does not exist the following error occurs.

```
switch#show management security ssl profile server
Profile      State      Error
-----
server       invalid    Certificate 'ca2.crt' does not exist
```

- If a trusted certificate 'foo.crt' is not self-signed root certificate the following error occurs.

```
switch#show management security ssl profile server
Profile      State      Error
-----
server       invalid    Certificate 'foo.crt' is trusted and not
a root certificate
```

- If the certificate 'server.crt' is expired the following error occurs.

```
switch#show management security ssl profile server
Profile      State      Error
-----
server       invalid    Certificate 'server.crt' has expired
```

- If the certificate chain is missing an intermediate certificate the following error occurs.

```
switch#show management security ssl profile server
Profile      State      Error
-----
-----
```



```
server      invalid  Profile has invalid certificate chain
            exist    Certificate 'intermediate.crt' does not
```

8.2.1.7.15 ssl profile

The **ssl profile** command places the switch in the SSL profile configuration mode. Various SSL profile management configurations are allowed in this mode. For example, this mode allows to configure a SSL profile with a certificate and its corresponding RSA key.

Similarly, other configurations such as trust certificate, chain certificate, crl, tls, cipher-list can be configured to a SSL profile in this mode.

The no form of the command deletes the SSL profile management configuration from *running-config*.

Command Mode

Management Security Mode

SSL Profile Mode

Command Syntax

```
ssl profile profile_name
```

Parameter

profile_name name of the profile.

Examples

- These commands place the switch in SSL profile mode.

```
switch#config
switch(config)#management security
switch(config-mgmt-security)#ssl profile server
switch(config-mgmt-sec-ssl-profile-server)#
```

- These commands configure SSL profile server with a certificate and its corresponding RSA key. The **no** command deletes the certificate configuration.

```
switch#config
switch(config)#management security
switch(config-mgmt-security)#ssl profile server
switch(config-mgmt-sec-ssl-profile-server)#certificate server.crt key
server.key
switch(config-mgmt-sec-ssl-profile-server)#no certificate server.crt
key server.key
```

- These commands configure the trust certificate ca1.crt to an SSL profile. The **no** command deletes a trusted certificate configuration.

```
switch#config
switch(config)#management security
switch(config-mgmt-security)#ssl profile server
switch(config-mgmt-sec-ssl-profile-server)#trust certificate ca1.crt
switch(config-mgmt-sec-ssl-profile-server)#no trust certificate ca1.crt
```

- These commands configure the intermediate.crt chain certificate to an SSL profile. The **no** command deletes a chain certificate configuration.

```
switch#config
switch(config)#management security
switch(config-mgmt-security)#ssl profile server
switch(config-mgmt-sec-ssl-profile-server)#certificate server.crt key
server.key
switch(config-mgmt-sec-ssl-profile-server)#chain certificate
intermediate.crt
```

```
switch(config-mgmt-sec-ssl-profile-server) #no chain certificate
intermediate.crt
```

- These commands provides certificate revocation list (CRL) to a SSL profile to check the revocation status of the certificate chain. The **no** command deletes the crl configuration.

```
switch#config
switch(config) #management security
switch(config-mgmt-security) #ssl profile server
switch(config-mgmt-sec-ssl-profile-server) #crl intermediate.crl
switch(config-mgmt-sec-ssl-profile-server) #crl ca.crl
switch(config-mgmt-sec-ssl-profile-server) #no crl ca.crl
```

- These commands configure TLSv1.2 to be used in the SSL profile.

```
switch#config
switch(config) #management security
switch(config-mgmt-security) #ssl profile server
switch(config-mgmt-sec-ssl-profile-server) #tls versions 1.2
```

- These commands build a cipher suite list.

```
switch#config
switch(config) #management security
switch(config-mgmt-security) #ssl profile server
switch(config-mgmt-sec-ssl-profile-server) #cipher-list AESGCM
switch(config-mgmt-sec-ssl-profile-server) #cipher-list SHA256:SHA38
switch(config-mgmt-sec-ssl-profile-server) #cipher-list ECDHE-ECDSA-A
ES256-GCM-SHA384
```

- This command check that the certificate has an extended key usage attribute.

```
switch(config-mgmt-sec-ssl-profile-client) #certificate requirement
extended-key-usage
```

- These commands check that all the trusted certificates or certificates in the chain have a CA basic constraints set to true.

```
switch(config-mgmt-sec-ssl-profile-client) #trust certificate
requirement basic-constraints ca true
switch(config-mgmt-sec-ssl-profile-client) #chain certificate
requirement basic-constraints ca true
```

- This command enables the Federal Information Processing Standards (FIPS) mode for a SSL profile.

```
switch(config-mgmt-sec-ssl-profile-client) #fips restrictions
```

8.2.2 802.1X Port Security

This section explains the basic concepts behind 802.1X port security, including switch roles, how the switches communicate, and the procedure used for authenticating clients.

- [802.1X Port Security Introduction](#)
- [802.1X Port Security Description](#)
- [Configuring 802.1X Port Security](#)
- [802.1X AAA Unresponsive VLAN](#)
- [Displaying 802.1X Information](#)
- [802.1X Configuration Commands](#)

8.2.2.1 802.1X Port Security Introduction

802.1X is an IEEE standard protocol that prevents unauthorized devices from gaining access to the network.

802.1X defines three device roles,

- Supplicant (client)
- Authenticator (switch)
- Authentication server (RADIUS)

Before authentication can succeed, switchport is in unauthorized mode and blocks all traffic but, after authentication has succeeded, normal data can then flow through the switchport.

Port security control who can send or receive traffic from an individual switch port. An end node is not allowed to send or receive traffic through a port until the node is authenticated by a RADIUS server.

This prevents unauthorized individuals from connecting to a switch port to access your network. Only designated valid users on a RADIUS server will be allowed to use the switch to access the network.

8.2.2.2 802.1X Port Security Description

802.1X port security controls can send traffic through and receive traffic from the individual switch ports. A supplicant must authenticate itself using EAPoL packets with the switch before it can gain full access to the port. Arista switches act as an authenticator, passing the messages from 802.1X supplicants through to the RADIUS server and vice versa. 802.1X can operate in two different modes:

Single Host Mode: Once the 802.1X supplicant is authenticated on the port, only the traffic coming from the supplicant's MAC is allowed through the port.

Multi-Host Mode: Once the 802.1X supplicant is authenticated on the port, traffic coming from any source MAC is allowed through the port.

Both these modes allow only one 802.1X supplicant to be authenticated for one port. Once it is successfully authenticated, no other 802.1X supplicant can be authenticated, unless the current one logs off.

Apart from 802.1X authentication, Arista switches also support MAC-Based Authentication (MBA), which allows devices not speaking 802.1X to have access to the network. The authenticator uses the MAC address of such devices as username/password in its RADIUS request packets. Depending on the MAC-Based Authentication configuration on the RADIUS server, it decides whether to authenticate the supplicant or not. Unlike 802.1X supplicants, multiple MBA supplicants are allowed on a single port. The MBA configuration is independent of the 802.1X host modes. MBA supplicants will not be considered to allow or reject unauthenticated traffic, based on the host mode.

Arista switches also support Dynamic VLAN assignment, which allows the RADIUS server to indicate the desired VLAN for the supplicant, using the tunnel attributes with the Access-Accept message. Both 802.1X and MBA supplicants can be assigned a VLAN via the RADIUS server. Note that only one VLAN per port is supported. When the first host authenticates, the authenticator port is put in the respective VLAN (via dynamic VLAN assignment) and subsequently, all other hosts must belong to that VLAN as well.

802.1X features are now supported on 802.1Q trunk ports allowing the user to have Port-Based Network Access Control (PNAC) on such a port. With this feature, traffic coming into an 802.1X enabled port with a VLAN tag can also be authenticated via both 802.1X or MBA.

By default, traffic from any unauthenticated device on an 802.1X enabled port is dropped. By configuring Authentication Failure VLAN on the authenticator switch, 802.1X or MBA supplicants traffic can be put into a specific VLAN, if the supplicant fails to authenticate via the RADIUS server.



Note: Only one configurable VLAN for failure is supported. That is, failure due to server timeout, server unreachable, server AUTH-FAIL, or Quarantine.

8.2.2.2.1 Switch Roles for 802.1X Configurations

The 802.1X standard specifies the roles of **Supplicant (client)**, **Authenticator**, and **Authentication Server** in a network. [Switch Roles for 802.1X Configurations](#) illustrates these roles.

Authentication server The switch that validates the client and specifies whether or not the client may access services on the switch. The switch supports Authentication Servers running RADIUS.

Authenticator The switch that controls access to the network. In an 802.1X configuration, the switch serves as the Authenticator. As the Authenticator, it moves messages between the client and the Authentication Server. The Authenticator either grants or does not grant network access to the client based on the identity data provided by the client, and the authentication data provided by the Authentication Server.

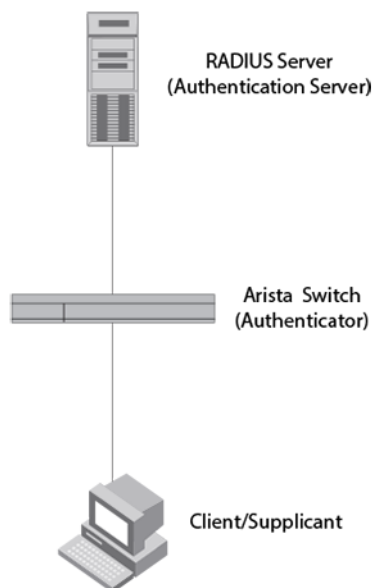

Figure 3: Authenticator, Supplicant, and Authentication Server in an 802.1X configuration

Supplicant/Client The client provides a username or password data to the Authenticator. The Authenticator sends this data to the Authentication Server. Based on the supplicants information, the Authentication Server determines whether the supplicant can use services given by the Authenticator. The Authentication Server gives this data to the Authenticator, which then provides services to the client, based on the authentication result.

8.2.2.2.2 Authentication Process

The authentication that occurs between a supplicant, authenticator, and authentication server include the following processes.

- Either the authenticator (a switch port) or the supplicant starts an authentication message exchange. The switch starts an exchange when it detects a change in the status of a port, or if it gets a packet on the port with a source MAC address that is not included in the MAC address table.
- An authenticator starts the negotiation by sending an EAP-Request/Identity packet. A supplicant starts the negotiation with an EAPOL-Start packet, to which the authenticator answers with a EAP-Request/Identity packet.
- The supplicant answers with an EAP-Response/Identity packet to the authentication server via the authenticator.
- The authentication server responds with an EAP-Request packet to the supplicant via the authenticator.
- The supplicant responds with an EAP-Response.

- The authentication server transmits either an EAP-Success packet or EAP-Reject packet to the supplicant.
- If an EAP-Reject is received, the supplicant will receive an EAP-Reject message and their traffic will not be forwarded.

8.2.2.2.3 Communication Between the Switches

For communication between the switches, 802.1X port security uses the Extensible Authentication Protocol (EAP), defined in RFC 2284 and the RADIUS authentication protocol.

The 802.1X standard defines a method for encapsulating EAP messages so they can be sent over a LAN. This encapsulated kind of EAP is known as EAP over LAN (EAPOL). The standard also specifies a means of transferring the EAPOL information between the client or Supplicant, Authenticator, and Authentication Server.

EAPOL messages are passed between the Supplicants and Authenticators Port Access Entity (PAE). [Communication Between the Switches](#) shows the relationship between the Authenticator PAE and the Supplicant PAE.

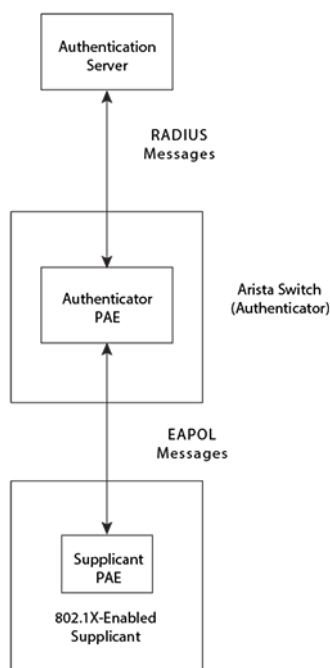

Figure 4: Authenticator PAE and Supplicant PAE

Authenticator PAE: The Authenticator PAE communicates with the Supplicant PAE to receive the Supplicants identifying information. Behaving as a RADIUS client, the Authenticator PAE passes the Supplicants information to the Authentication Server, which decides whether to grant the Supplicant access. If the Supplicant passes authentication, the Authenticator PAE allows it access to the port.

Supplicant PAE The Supplicant PAE provides information about the client to the Authenticator PAE and replies to requests from the Authenticator PAE. The Supplicant PAE may initiate the authentication procedure with the Authenticator PAE, as well as send logoff messages.

8.2.2.2.4 Dot1x Dropped Counters

The Dot1x Dropped Counters count the packets dropped by dot1x interfaces. The dropped counter will not represent all the dropped packets in case of high volume dropping, and the CPU queue drop counter will reflect the rest of the dropped packet counter. This is due to the fact that EOS limits the bandwidth for the packets that get sent to the CPU.

The following counters are supported and increment depending on the dot1x interface configuration mode:

- Eapol unauthorized port (indicates the dropped packet number due to the unauthorized Eapol port when Mac Base Authorization is disabled).
- Eapol unauthorized host (indicates the dropped packet number due to the unauthorized Eapol host).
- MBA unauthorized host (counts the dropped packet due to the unauthorized host when Mac Base Authorization is enabled.)

Platform Compatibility

- 7050X/X2/X3 series
- 7060X/X2/X3 series
- CCS-720XP series
- 7300X/7320X/7300X3 series
- DCS-7060DX4 series
- DCS-7260 series

8.2.2.2.5 Enable 802.1X Port Control

To enable 802.1X port authentication on the switch, global command configuration is required:

```
switch(config) #dot1x system-auth-control
```

Port mode can be set to access/trunk port and 802.1X port access entity is set to authenticator:

```
switch(config-if-Et1) #switchport mode access  
switch(config-if-Et1) #dot1x pae authenticator
```

8.2.2.2.6 Controlled and Uncontrolled Ports

A physical port on the switch used with 802.1X has two virtual access points that include a controlled port and an uncontrolled port. The controlled port grants full access to the network. The uncontrolled port only gives access for EAPOL traffic between the client and the Authentication Server. When a client is authenticated successfully, the controlled port is opened to the client.

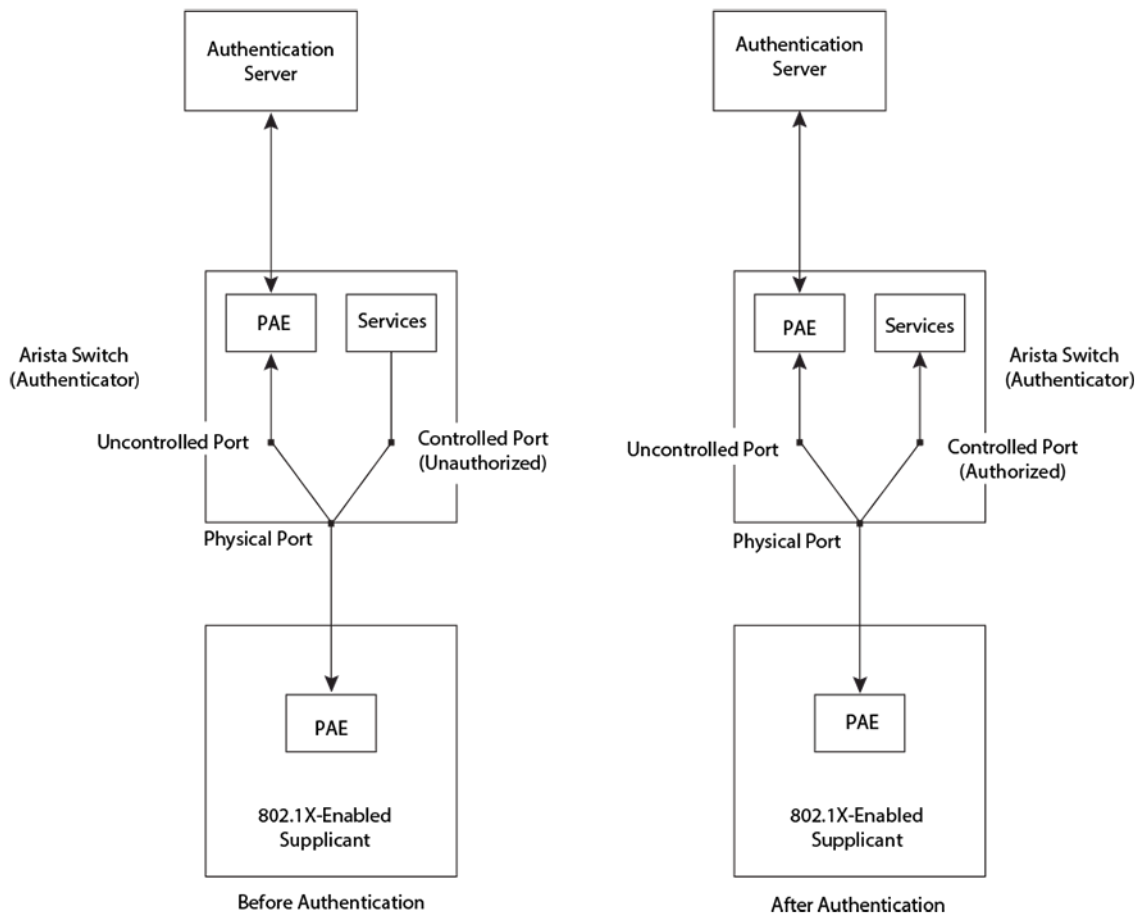

Figure 5: Ports before and after client authentication

8.2.2.2.6.1 Control Port State

Before the port is authenticated, the port is in an unauthorized state. In this state, only EAPOL packets are processed by 802.1X agent and all other packets are dropped. After the port is successfully authenticated, the port is in the authorized state and all packets are allowed to pass. The state transition is controlled by authentication exchange between supplicant and authentication server. However, the user can control the state by using any one of the following commands:

```
switch(config-if-Et1)#dot1x port-control force-authorized
switch(config-if-Et1)#dot1x port-control force-unauthorized
switch(config-if-Et1)#dot1x port-control auto
```

- **force-authorized** disables 802.1X authentication and directly put the port to the authorized state. This is the default setting.
- **force-unauthorized** also disables 802.1X authentication and directly put the port to unauthorized state, ignoring all attempts by the client to authenticate.
- **auto** enables 802.1X authentication and put the port to unauthorized state first. The port state remains in an unauthorized state or transit to authorized state according to authentication result and configuration.

8.2.2.2.6.2 Uncontrolled Port State

The uncontrolled port on the Authenticator is the only one open before a client is authenticated. The uncontrolled port permits only EAPOL frames to be swapped between the client and the Authentication Server. No traffic is allowed to pass through the controlled port in the unauthorized state.

During authentication, EAPOL messages are swapped between the Supplicant PAE and the Authenticator PAE, and RADIUS messages are swapped between the Authenticator PAE and the Authentication Server. If the client is successfully authenticated, the controlled port becomes authorized, and traffic from the client can flow through the port normally.

All controlled ports on the switch are placed in the authorized state, allowing all traffic, by default. When authentication is initiated, the controlled port on the interface is initially set in the unauthorized state. If a client connected to the port is authenticated successfully, the controlled port is set in the authorized state.

8.2.2.2.7 Message Exchange During Authentication

[Multiple clients connected to a 802.1X-enabled port](#) illustrates an exchange of messages between an 802.1X-enabled client, a switch operating as Authenticator, and a RADIUS server operating as an Authentication Server.

Arista switches support MD5-challenge TLS and any other EAP-encapsulated authentication types in EAP Request or Response messages. In other words, the switches are transparent to the authentication scheme used.

8.2.2.2.8 Authenticating Multiple Clients Connected to the Same Port

Arista switches support 802.1X authentication for ports with more than one client connected to them. [Multiple clients connected to a 802.1X-enabled port](#) illustrates a sample configuration where multiple clients are connected to a single 802.1X port. 802.1X authentication may use multi-host mode, or (on selected switches) single-host mode. In both modes, the port authenticates the packets received from any one client, and the packets received from other clients are dropped, until the connected client is authenticated by the RADIUS server.

8.2.2.2.8.1 Single-host Mode

In single-host mode, once the 802.1X client has been authenticated by the RADIUS server further authentication is not required, but the port accepts packets only from the MAC address of the authenticated client.

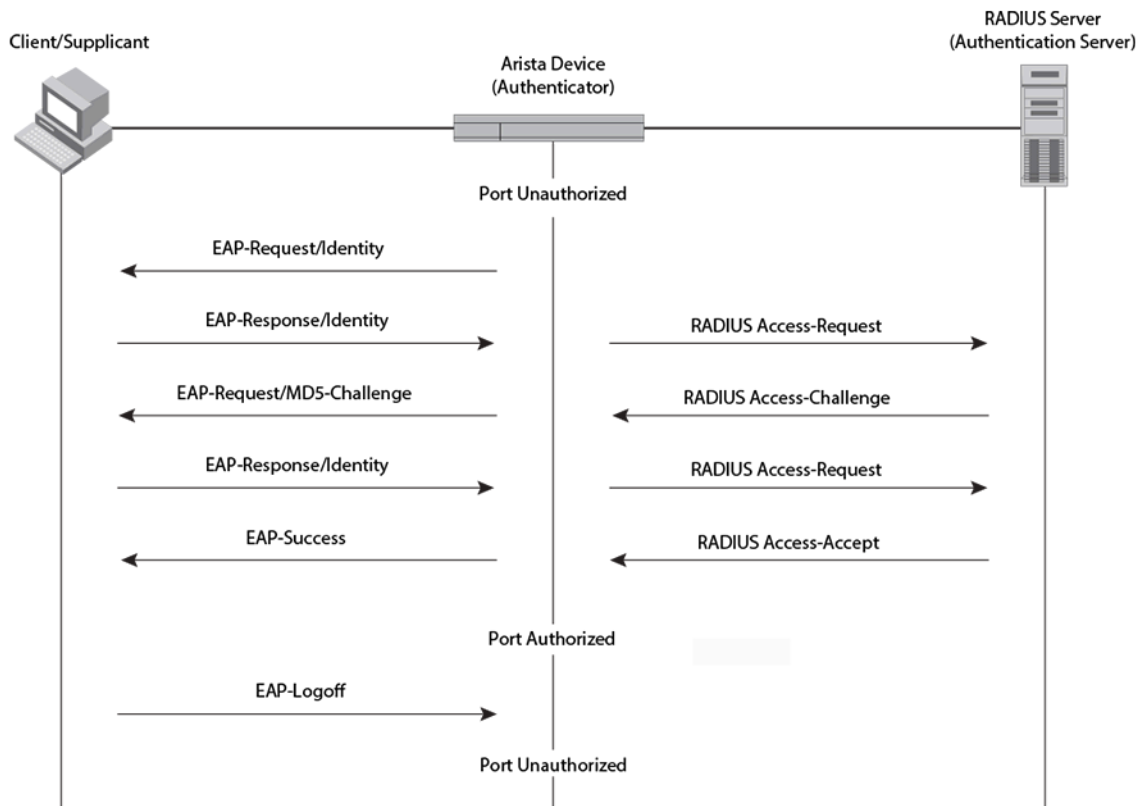

Figure 6: Message Exchange During Authentication

8.2.2.2.8.2 Multi-host Mode

In multi-host mode, once the 802.1X client has been authenticated by the RADIUS server, the port is open to accept all packets from any connected client, and these packets do not require any authentication.

8.2.2.2.9 802.1X MAC- Based Authentication

The 802.1X MAC-based authentication allows a set of MAC addresses to be programmed into the RADIUS server. These MAC addresses (MAC-based authentication supplicants) do not connect to 802.1X profiles but are still allowed access to the network. The authenticator identifies devices that do not support 802.1X and uses the MAC address of these devices as username and password in its RADIUS request packets.

In a MAC-based authentication, every supplicant trying to gain access to the authenticator port is individually authenticated as opposed to authenticating just one supplicant on a given VLAN or port with 802.1X. The behavior is different for MAC-based authentication supplicants when we have a 802.1.x supplicant authenticated in single host and multi-host 802.1X modes.

To enable Mac-based authentication, use the following command:

```
switch(config-if-Et1/1)#dot1x mac based authentication
```



Note: This command is added to the existing 802.1X configuration on the port, so a typical 802.1X interface configuration with MAC-Based Authentication enabled may look something like this:

```
switch(config-if-Et1/1)#show active
speed forced 1000full
dot1x pae authenticator
```

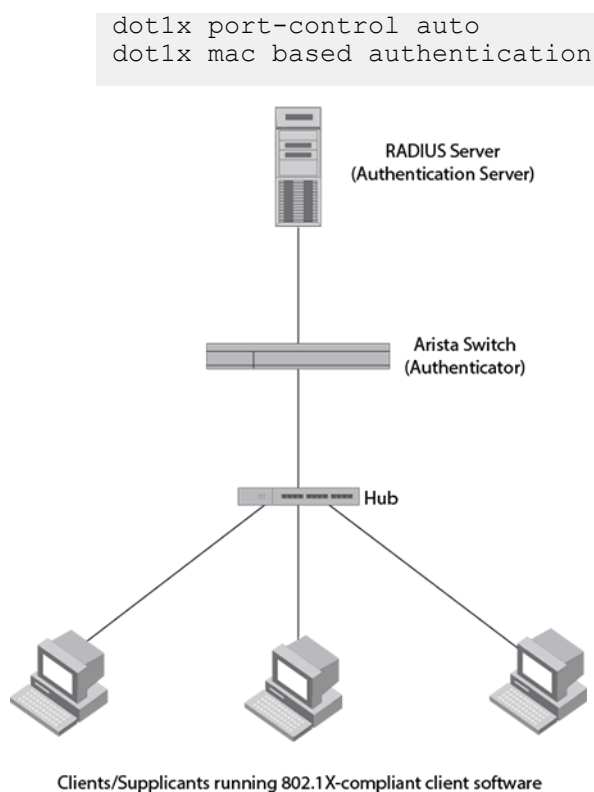

Figure 7: Multiple clients connected to a 802.1X-enabled port

Mac-Based Authentication Delay

Use the `mac based authentication delay` command to configure a Mac-based Authentication delay. By default, the delay is triggered after 5 seconds.

```
switch(config-dot1x)#mac based authentication delay <0-300> seconds
```

Mac-Based Authentication Hold-Period

When Mac Based Authentication is rejected by a AAA server, there is a default hold period of 60 seconds before the Mac Based Authentication is retried again even if the host continues to send traffic. However, the hold-period can be configured manually using the `mac based authentication hold period` command.

```
switch(config-dot1x)#mac based authentication hold period <1-300> seconds
```



Note: Configuring a low value for the hold-period can significantly increase the load on a AAA server in- case MAC-Based Authentication is not enabled for a host.

8.2.2.3 802.1X AAA Unresponsive VLAN

Overview

Devices connected to 802.1X controlled ports must perform authentication before their generic traffic is allowed into the network. During this process, the switch contacts a configured AAA server that determines if the device's access to the network is accepted or denied. When the AAA server is unresponsive, the default behavior is to deny all authentication attempts. The AAA Unresponsive VLAN feature allows the user to specify different behavior for this case, accepting authentication attempts and assigning devices to the native VLAN or a specified VLAN. As in other failure scenarios, the switch tries to authenticate the supplicant after the quiet period has passed.

Platform Compatibility

This is currently supported in all platforms that support 802.1X.

8.2.2.3.1 Configuring 802.1X AAA Unresponsive VLAN

The `aaa unresponsive action traffic allow vlan` command is configured under the dot1x configuration sub-mode to enable the dot1x AAA unresponsive VLAN feature on the switch. When configured, the switch changes the action taken with regards to authentication attempts when the AAA server is unresponsive. The AAA server is considered unresponsive when communication with it times out.

Example

- These commands places the switch in the dot1x configuration mode and enables the dot1x AAA unresponsive VLAN feature on the switch.

```
switch(config)#dot1x
switch(config-dot1x)#aaa unresponsive action traffic allow vlan <vlan-id>
```

8.2.2.3.2 Troubleshooting

When AAA unresponsive VLAN does not act on a device, the following should be checked:

- If the device is the first/only one to try to authenticate on the port or the appropriate host-mode is configured.
- If **reauth-timeout-ignore** is configured.
- If the device tried to authenticate using vlan-tagged frames.

Tracing



Note: In some cases, enabling tracing can seriously impact the performance of the switch. Please use it cautiously and seek advice from an Arista representative before enabling this in any production environments.

- Tracing messages for this feature are under the Dot1x trace handle, on the Dot1x agent
- The decision process is tagged with maybeApplyAaaUnresponsiveVlan and the messages shows the feature activation, and why it was not activated when that is the case.

8.2.2.3.3 Limitations

- AAA unresponsive VLAN does not act on devices that tried to authenticate using VLAN-tagged frames.
- When AAA unresponsive VLAN is enabled without a VLAN, devices get assigned to the native VLAN – even phones that would otherwise be assigned to the phone VLAN. If phones should be assigned to the phone VLAN when AAA is unavailable, the knob `aaa unresponsive phone vlan action allow` should be additionally used.

8.2.2.4 Configuring 802.1X Port Security

Basic steps to implementing 802.1X Port-based Network Access Control and RADIUS accounting on the switch:

1. A RADIUS server is required on one or more of your network servers or management stations. 802.1X is not supported with the TACACS+ authentication protocol.

2. You must create supplicant accounts on the RADIUS server:
 - The account for a supplicant connected to an authenticator port must have a username and password combination when set to the 802.1X authentication mode.
 - An account for the supplicant connected to an authenticator port and placed in the MAC address-based authentication mode needs use the MAC address of the node as both the username and password.
 - Connected clients to an 802.1X authenticator port will require 802.1X client software.
3. The RADIUS client must be configured by entering the IP addresses and encryption keys of the authentication servers on your network.
4. The port access control settings must be configured on the switch. This includes the following:
 - Specifying the port roles.
 - Configuring 802.1X port parameters.
 - Enabling 802.1X Port-based Network Access Control.

Guidelines

- Do not set a port that is connected to a RADIUS authentication server to the authenticator role as an authentication server cannot authenticate itself.
- A supplicant connected to an authenticator port set to the 802.1X username and password authentication method must have 802.1X client software.
- To prevent unauthorized individuals from accessing the network through unattended network workstations, end users of 802.1X port-based network access control should always log off when they are finished with a work session.
- The RADIUS client should be configured on the switch before activating port-based access control.

8.2.2.4.1 Configuring 802.1X Authentication Methods

IEEE 802.1X port security relies on external client-authentication methods, which must be configured for use. The method currently supported on Arista switches is RADIUS authentication. To configure the switch to use a RADIUS server for client authentication, use the `aaa authentication dot1x` command.

Example

This command configures the switch to use RADIUS authentication.

```
switch(config)#aaa authentication dot1x default group radius
switch(config)#
```

8.2.2.4.2 Configuring Dot1x Dropped Counters

Use the `statistics packets dropped` command to configure the dot1x dropped counters on the switch under dot1x configuration mode. By default, the dot1x dropped counters is disabled. The `no` form of the command disables the dot1x dropped counters from the running configuration.

Example

- These commands places the switch in the dot1x mode and enables the dot1x dropped counters.

```
switch(config-dot1x)#statistics packets dropped
```

8.2.2.4.3 Globally Enable IEEE 802.1X

To enable IEEE 802.1X port authentication globally on the switch, use the `dot1x system-auth-control` command.

Example

This command enables IEEE 802.1X globally on the switch.

```
switch(config) #dot1x system-auth-control
switch(config)
```

8.2.2.4.4 Designating Authenticator Ports

To set the port access entity (PAE) type of an Ethernet or management interface to the **authenticator**, use the **dot1x pae authenticator** command.

Example

These commands configure the PAE type to **authenticator** on the Ethernet interface 1 to enable IEEE 802.1X on the port.

```
switch(config) #interface ethernet 1
switch(config-if-Et1) #dot1x pae authenticator
switch(config-if-Et1) #
```

Example

For ports to act as authenticator ports to connected supplicants, those ports must be designated using the **dot1x port-control** command.

The **auto** option of the **dot1x port-control** command designates an authenticator port for immediate use, blocking all traffic that is not authenticated by the AAA server.

Example

This command configures Ethernet 1 to immediately begin functioning as an authenticator port.

```
switch(config) #interface ethernet 1
switch(config-if-Et1) #dot1x port-control auto
switch(config-if-Et1) #
```

The **force-authorized** option of the **dot1x port-control** command sets the state of the port to **authorized** without authentication, allowing traffic to continue uninterrupted.

Example

These commands designate Ethernet 1 as an authenticator port that will forward packets without authentication.

```
switch(config) #interface ethernet 1
switch(config-if-Et1) #dot1x port-control force-authorized
switch(config-if-Et1) #
```

To designate a port as an authenticator but prevent it from authorizing any traffic, use the **force-unauthorized** option of the **dot1x port-control** command.

Example

The **force-unauthorized** option of the **dot1x port-control** command places the specified port in the unauthorized state, which will deny any access requests from users of the ports.

```
switch(config) #interface ethernet 1
switch(config-if-Et1) #dot1x port-control force-unauthorized
switch(config-if-Et1) #
```

8.2.2.4.5 Specifying the Authentication Mode for Multiple Clients

By default, Arista switches authenticate in multi-host mode, allowing packets from any source MAC address once 802.1X authentication has taken place. To configure the switch for single-host mode (allowing traffic only from the authenticated clients MAC address), use the `dot1x host-mode` command.

Example

These commands configure Ethernet interface 1 to use single-host mode for 802.1X authentication.

```
switch(config)#interface Ethernet 1
switch(config-if-Et1)#dot1x host-mode single-host
switch(config-if-Et1)#
```

8.2.2.4.6 Configuring Re-authentication

The `dot1x reauthentication` command enables re-authentication of authenticator ports with the default values.

The `dot1x timeout reauth-period` command allows to customize the re-authentication period of authenticator ports.

Examples

- These commands configures the configuration mode interface to require re-authentication from clients at regular intervals.

```
switch(config)#interface Ethernet 1
switch(config-if-Eth)#dot1x reauthentication
```

- These commands configure the Ethernet interface 1 authenticator to require re-authentication from clients every 6 hours (21600 seconds).

```
switch(config)#interface Ethernet 1
switch(config-if-Et1)#dot1x reauthentication
switch(config-if-Et1)#dot1x timeout reauth-period 21600
switch(config-if-Et1)#
```

- These commands deactivate re-authentication on Ethernet interface 1.

```
switch(config)#interface Ethernet 1
switch(config-if-Et1)#no dot1x reauthentication
switch(config-if-Et1)#
```

8.2.2.4.7 Setting the EAP Request Maximum

The `dot1x reauthorization request limit` command configures the number of times the switch retransmits an 802.1X Extensible Authentication Protocol (EAP) request packet before ending the conversation and restarting authentication.

Example

These commands set the number of times the authenticator sends an EAP request packet to the client before restarting authentication.

```
switch(config)#interface ethernet 1
switch(config-if-Et1)#dot1x reauthorization request limit 4
switch(config-if-Et1)#
```

The default value is 2.

8.2.2.4.8 Disabling Authentication on a Port

To disable authentication on an authenticator port, use the **no** form of the **dot1x port-control** command.

Example

These commands disable authentication on Ethernet interface 1.

```
switch(config)#interface ethernet 1
switch(config-if-Et1)#no dot1x port-control
switch(config-if-Et1)#
```

8.2.2.4.9 Setting the Quiet Period

If the switch fails to immediately authenticate the client, the time the switch waits before trying again is specified by the **dot1x timeout quiet-period** command. This timer also indicates how long a client that failed authentication is blocked.

Example

These commands set the 802.1X quiet period for Ethernet interface 1 to 30 seconds.

```
switch(config)#interface ethernet 1
switch(config-if-Et1)#dot1x timeout quiet-period 30
```

The default value is 60 seconds.

8.2.2.4.10 Setting the Dot1x Timeout Reauth-period

The **dot1x timeout reauth-period** command specifies the time period in seconds that the configuration mode interface waits before requiring re-authentication from clients.

Example

These commands configure the timeout reauth-period to 21600 seconds.

```
switch(config)#interface Ethernet 1
switch(config-if-Et1)#dot1x reauthentication
switch(config-if-Et1)#dot1x timeout reauth-period 21600
```

The default value is 3600 seconds.

8.2.2.4.11 Setting the Transmission Timeout

Authentication and re-authentication are accomplished by the authenticator sending an Extensible Authentication Protocol (EAP) request to the supplicant and the supplicant sending a reply which the authenticator forwards to an authentication server. If the authenticator doesn't receive a reply to the EAP request, it waits a specified period of time before retransmitting. To configure that wait time, use the **dot1x timeout tx-period** command.

Example

These commands configure Ethernet interface 1 to wait 30 seconds before retransmitting EAP requests to the supplicant.

```
switch(config)#interface Ethernet 1
switch(config-if-Et1)#dot1x timeout tx-period 30
switch(config-if-Et1)#
```

The default value is 5 seconds.

8.2.2.4.12 Enable Authentication Failure VLAN

Configure Authentication Failure VLAN on a dot1x-enabled port using the following CLI command under the **interface-config** mode. The CLI command to set VLAN10 as authentication failure VLAN is as follows:

```
switch(config-if-Et1/1)#dot1x authentication failure action traffic allow
vlan 10
```

When **no authentication failure** VLAN is configured on a dot1x-enabled port, the default action is to drop any unauthorized traffic on the port. This behavior can also be specified using the following command:

Example

```
switch(config-if-Et1/1)#dot1x authentication failure action traffic drop
```

8.2.2.4.13 Clearing 802.1X Statistics

The **clear dot1x statistics** command resets the 802.1X counters.

Examples

- This command clears the 802.1X counters on all interfaces.

```
switch#clear dot1x statistics all
switch#
```

- This command clears the 802.1X counters on Ethernet interface 1.

```
switch#clear dot1x statistics interface ethernet 1
switch#
```

8.2.2.5 Displaying 802.1X Information

You can display information about 802.1X on the switch and on individual ports.

8.2.2.5.1 Displaying 802.1X statistics

Use the **show dot1x statistics** command to display 802.1X statistics for the specified port or ports.

Example

- This command displays IEEE 802.1X statistics for Ethernet interface 5.

```
switch#show dot1x interface ethernet 5 statistics
Dot1X Authenticator Port Statistics for Ethernet5
-----
RxStart = 0      RxLogoff = 0      RxRespId = 0
RxResp = 0      RxInvalid = 0    RxTotal = 0
TxReqId = 0     TxReq = 0       TxTotal = 0
RxVersion = 0   LastRxSrcMAC = 0000.0000.0000
switch#
```

- This command displays the dot1x dropped counters for all the dot1x interfaces.

```
switch#show dot1x all statistics
Dot1X Authenticator Port Statistics for Ethernet51/1
-----
RX start = 1     RX logoff = 0    RX response ID = 1
```

```

RX response = 10          RX invalid = 0  RX total = 12
TX request ID = 2        TX request = 11  TX total = 13
RX version = 2    Last RX src MAC = ded6.404b.ec94
Data packet drop counters:
EAPOL unauthorized port = 2
EAPOL unauthorized host = 1
MBA unauthorized host = 0

Dot1X Authenticator Port Statistics for Ethernet49
-----
RX start = 1      RX logoff = 0  RX response ID = 1
RX response = 10  RX invalid = 0  RX total = 12
TX request ID = 2  TX request = 11  TX total = 13
RX version = 2    Last RX src MAC = ded6.404b.ec94
Data packet drop counters:
EAPOL unauthorized port = 2
EAPOL unauthorized host = 1
MBA unauthorized host = 0

```

8.2.2.5.2 Displaying 802.1X supplicant information

Use the `show dot1x hosts` command to display information for all the supplicants.

Example

This command displays 802.1X supplicant information.

```

switch#show dot1x hosts
Interface: Ethernet1/1
Supplicant MAC      Auth Method      State      VLAN Id
-----
e2:29:cb:11:2f:4a  EAPOL            SUCCESS    300
e2:29:cb:11:2f:4b  MAC-BASED-AUTH   SUCCESS    300

```

8.2.2.5.3 Displaying Mac-address Tables

Use the `show mac address-table` command to display the MAC address of the supplicants allowed to pass the traffic through the port.

Example

```

switch#show mac address-table
Mac Address Table
-----
Vlan    Mac Address      Type      Ports      Moves      Last Move
----    -
300     e229.cb11.2f4a  STATIC    Et1/1      0          0
300     e229.cb11.2f4b  STATIC    Et1/1      0          0
Total Mac Addresses for this criterion: 2

```

8.2.2.5.4 Displaying Port Security Configuration Information

The `show dot1x` command shows information about the 802.1X configuration on the specified port or ports.

Example

This commands displays IEEE 802.1X configuration information for Ethernet interface 5.

```

switch#show dot1x interface ethernet 5

```

```

Dot1X Information for Ethernet5
-----
PortControl           : auto
QuietPeriod           : 60 seconds
TxPeriod              : 5 seconds
ReauthPeriod          : 3600 seconds
MaxReauthReq          : 2
switch#

```

8.2.2.5.5 Displaying the Status of the 802.1X Attributes for each Port.

Use the **show dotx1 interface *interface-id*** command to display the status of the 802x1 attributes for each port.

Example

```

switch(config-if-Et1/1)#show dot1x interface ethernet1/1
Dot1X Information for Ethernet1
-----
PortControl           : force-authorized
HostMode              : multi-host
QuietPeriod           : 60 seconds
TxPeriod              : 5 seconds
ReauthPeriod          : 0 seconds
MaxReauthReq          : 2
ReauthTimeoutIgnore   : No
AuthFailVlan          : 10

```

8.2.2.5.6 Displaying VLANS

Use the **show vlan** command to display if a VLAN has been dynamically assigned to the port.

Example

```

switch#show vlan
VLAN  Name                               Status  Ports
-----
1     default                               active
2     VLAN0002                               active  Et7, Et17, Et18, Et41
300*  VLAN0300                               active  Et1/1, Et6, Et19, Et20, Et29
                                           Et30, Et31, Et32, Et42, Et43, Et44

* indicates a Dynamic VLAN

```

8.2.2.5.7 Displaying_802.1X_Information

Use the **show dot1x all brief** command to display IEEE 802.1X status for all ports.

Example

- The following commands display a summary of IEEE 802.1X status.

```

switch#show dot1x all brief
Interface Client Status
-----
Ethernet5 None Unauthorized
switch#

```

8.2.2.6 802.1X Configuration Commands

Global Configuration Commands

- [dot1x system-auth-control](#)

Dot1x Configuration Commands

- [aaa unresponsive action traffic allow vlan](#)
- [dot1x mac based authentication delay](#)
- [dot1x mac based authentication hold period](#)

Interface Configuration Commands Ethernet Interface

- [dot1x host-mode](#)
- [dot1x mac based authentication](#)
- [dot1x pae authenticator](#)
- [dot1x port-control](#)
- [dot1x reauthentication](#)
- [dot1x reauthorization request limit](#)
- [dot1x timeout quiet-period](#)
- [dot1x timeout reauth-period](#)
- [dot1x timeout tx-period](#)
- [statistics packets dropped](#)

Privileged EXEC Commands

- [clear dot1x statistics](#)
- [show dot1x](#)
- [show dot1x all brief](#)
- [show dot1x hosts](#)
- [show dot1x statistics](#)

8.2.2.6.1 aaa unresponsive action traffic allow vlan

The **aaa unresponsive action traffic allow vlan** enables the the dot1x AAA unresponsive VLAN feature on the switch.

The **no aaa unresponsive action traffic allow vlan** command disbales the dot1x AAA unresponsive VLAN feature from the **running-config**.

Command Mode

Dot1x Configuration Mode

Command Syntax

```
aaa unresponsive action traffic allow vlan VLAN-ID
```

```
no unresponsive action traffic allow vlan
```

Parameters

- unresponsive Configure AAA timeout options.
- action Set action for supplicant when AAA times out.
- traffic Set action for supplicant traffic when AAA times out.
- allow Allow traffic when AAA times out.
- vlan Allow traffic in VLAN when AAA times out.
- *VLAN-ID* Identifier for a Virtual LAN. Value ranges from 1 to 4094.

Example

- These commands places the switch in the dot1x configuration mode and enables the dot1x AAA unresponsive VLAN feature on the switch.

```
switch(config)#dot1x
switch(config-dot1x)#aaa unresponsive action traffic allow vlan 50
```

8.2.2.6.2 clear dot1x statistics

The `clear dot1x statistics` command resets the 802.1X counters on the specified interface or all interfaces.

Command Mode

Privileged EXEC

Command Syntax

```
clear dot1x statistics INTERFACE_NAME
```

Parameters

- **INTERFACE_NAME** Interface type and number. Options include:
 - **all** Display information for all interfaces.
 - **interface ethernet** *e_num* Ethernet interface specified by *e_num*.
 - **interface loopback** *l_num* Loopback interface specified by *l_num*.
 - **interface management** *m_num* Management interface specified by *m_num*.
 - **interface port-channel** *p_num* Port-Channel Interface specified by *p_num*.
 - **interface vlan** *v_num* VLAN interface specified by *v_num*.

Example

This command resets the 802.1X counters on all interfaces.

```
switch#clear dot1x statistics all
switch#
```

8.2.2.6.3 dot1x mac based authentication

The **dot1x mac based authentication** command enables MAC-based authentication on the existing 802.1X authenticator port.

The **no dot1x mac based authentication** and the **default dot1x mac based authentication** commands restore the switch default by disabling the corresponding dot1x mac based authentication command for the specific 802.1X authenticator port.

Command Mode

Interface-Ethernet Configuration

Command Syntax

```
dot1x mac based authentication
```

```
no dot1x mac based authentication
```

```
default dot1x mac based authentication
```

Related Command

```
show dot1x hosts
```

Example

These commands configure MAC-based authentication on *Ethernet interface 1*.

```
switch(config)#interface ethernet 1  
switch(config-if-Et1)#dot1x mac based authentication  
switch(config-if-Et1)#
```

8.2.2.6.4 dot1x mac based authentication delay

The **dot1x mac based authentication delay** command enables MAC-based authentication delay. By default, the delay is triggered after 5 seconds.

The **no dot1x mac based authentication delay** and the **default dot1x mac based authentication delay** commands restore the switch default by disabling the corresponding dot1x mac based authentication delay command.

Command Mode

Dot1x Configuration

Command Syntax

```
dot1x mac based authentication delay delay-time seconds
```

```
no dot1x mac based authentication delay
```

```
default dot1x mac based authentication delay
```

Parameter

- *delay-time* Delay in seconds. The value is from 0 to 300.
- seconds Unit in seconds.

Example

These commands configure a MAC-based authentication delay of 30 seconds on a switch.

```
switch(config)#dot1x  
switch(config-dot1x)#mac based authentication delay 30 seconds
```

8.2.2.6.5 dot1x mac based authentication hold period

The **dot1x mac based authentication hold period** command enables MAC-based authentication hold period. By default, the hold period is 60 seconds.

The **no dot1x mac based authentication hold period** and the **default dot1x mac based authentication hold period** commands restore the switch default by disabling the corresponding dot1x mac based authentication hold period command.

Command Mode

Dot1x Configuration

Command Syntax

```
dot1x mac based authentication hold period hold period-time seconds
```

```
no dot1x mac based authentication hold period
```

```
default dot1x mac based authentication hold period
```

Parameter

- *hold period-time* Hold period in seconds. The value is from 1 to 300 in seconds.
- seconds Unit in seconds.

Example

These commands configure a MAC-based authentication hold period of 100 seconds on a switch.

```
switch(config)#dot1x  
switch(config-dot1x)#mac based authentication hold period 100 seconds
```

8.2.2.6.6 dot1x pae authenticator

The `dot1x pae authenticator` command sets the port access entity (PAE) type of the configuration mode interface to **authenticator**, which enables IEEE 802.1X on the port. IEEE 802.1X is disabled on all ports by default.

The `no dot1x pae authenticator` and `default dot1x pae authenticator` commands restore the switch default by deleting the corresponding `dot1x pae authenticator` command from *running-config*.

Command Mode

Interface-Ethernet Configuration

Interface-Management Configuration

Command Syntax

```
dot1x pae authenticator
```

```
no dot1x pae authenticator
```

```
default dot1x pae authenticator
```

Examples

- These commands configure *Ethernet interface 2* as a port access entity (PAE) authenticator, enabling IEEE 802.1X on the port.

```
switch(config-if-Et1)#interface ethernet 2  
switch(config-if-Et1)#dot1x pae authenticator  
switch(config-if-Et1)#
```

- These commands disable IEEE 802.1X authentication on *Ethernet interface 2*.

```
switch(config-if-Et1)#interface ethernet 2  
switch(config-if-Et1)#no dot1x pae authenticator  
switch(config-if-Et1)#
```

8.2.2.6.7 dot1x reauthentication

The `dot1x reauthentication` command configures the configuration mode interface to require re-authentication from clients at regular intervals. The interval is set by the `dot1x timeout reauth-period` command.

The `no dot1x reauthentication` and `default dot1x reauthentication` commands restore the default setting by deleting the corresponding `dot1x reauthentication` command from *running-config*.

Command Mode

Interface-Ethernet Configuration

Interface-Management Configuration

Command Syntax

```
dot1x reauthentication
```

```
no dot1x reauthentication
```

```
default dot1x reauthentication
```

Example

These commands configure the *Ethernet interface 1* authenticator to require periodic re-authentication from clients.

```
switch(config)#interface Ethernet 1
switch(config-if-Et1)#dot1x reauthentication
switch(config-if-Et1)#
```

8.2.2.6.8 dot1x reauthorization request limit

The **dot1x reauthorization request limit** command configures how many times the switch retransmits an 802.1X Extensible Authentication Protocol (EAP) request packet before ending the conversation and restarting authentication.

The **no dot1x reauthorization request limit** and **default dot1x reauthorization request limit** commands restore the default value of 2 by deleting the corresponding **dot1x reauthorization request limit** command from *running-config*.

Command Mode

Interface-Ethernet Configuration

Interface-Management Configuration

Command Syntax

```
dot1x reauthorization request limit attempts
no dot1x reauthorization request limit
default dot1x reauthorization request limit
```

Parameters

attempts Maximum number of attempts. Values range from 1 to 10; default value is 2.

Examples

- This command sets the 802.1X EAP-request retransmit limit to 6.

```
switch(config)#interface ethernet 1
switch(config-if-Et1)#dot1x reauthorization request limit 6
switch(config-if-Et1)#
```

- This command restores the default request repetition value of 2.

```
switch(config)#interface ethernet 1
switch(config-if-Et1)#no dot1x reauthorization request limit
switch(config-if-Et1)#
```

8.2.2.6.9 dot1x system-auth-control

The `dot1x system-auth-control` command enables 802.1X authentication on the switch.

The `no dot1x system-auth-control` and `default dot1x system-auth-control` commands disables 802.1X authentication by removing the `dot1x system-auth-control` command from *running-config*.

Command Mode

Global Configuration

Command Syntax

```
dot1x system-auth-control
no dot1x system-auth-control
default dot1x system-auth-control
```

Examples

- This command enables 802.1X authentication on the switch.

```
switch(config)#dot1x system-auth-control
switch(config)#
```

- This command disables 802.1X authentication on the switch.

```
switch(config)#no dot1x system-auth-control
switch(config)#
```

8.2.2.6.10 dot1x timeout quiet-period

If the switch fails to immediately authenticate the client, the time the switch waits before trying again is specified by the `dot1x timeout quiet-period` command. This timer also indicates how long a client that failed authentication is blocked.

The `no dot1x timeout quiet-period` and `default dot1x timeout quiet-period` commands restore the default quiet period of 60 seconds by removing the corresponding `dot1x timeout quiet-period` command from *running-config*.

Command Mode

Interface-Ethernet Configuration

Interface-Management Configuration

Command Syntax

```
dot1x timeout quiet-period quiet_time
no dot1x timeout quiet-period
default dot1x timeout quiet-period
```

Parameter

quiet_time Interval in seconds. Values range from 1 to 65535. Default value is 60.

Example

These commands set the 802.1X quiet period for Ethernet interface 1 to 30 seconds.

```
switch(config)#interface Ethernet 1
switch(config-if-Et1)#dot1x timeout quiet-period 30
switch(config-if-Et1)#
```

8.2.2.6.11 dot1x timeout reauth-period

The `dot1x timeout reauth-period` command specifies the time period that the configuration mode interface waits before requiring re-authentication from clients.

The `no dot1x timeout reauth-period` and `default dot1x timeout reauth-period` commands restore the default period of 60 minutes by removing the corresponding `dot1x timeout reauth-period` command from *running-config*.

Command Mode

Interface-Ethernet Configuration

Interface-Management Configuration

Command Syntax

```
dot1x timeout reauth-period reauth_time
```

```
no dot1x timeout reauth-period
```

```
default dot1x timeout reauth-period
```

Parameter

`reauth_time` The number of seconds the interface passes traffic before requiring re-authentication. Values range from 1 to 65535. Default value is 3600.

Example

These commands configure the Ethernet interface 1 authenticator to require re-authentication from clients every 6 hours (21600 seconds).

```
switch(config)#interface Ethernet 1
switch(config-if-Et1)#dot1x reauthentication
switch(config-if-Et1)#dot1x timeout reauth-period 21600
switch(config-if-Et1)#
```

8.2.2.6.12 dot1x timeout tx-period

Authentication and re-authentication are accomplished by the authenticator sending an Extensible Authentication Protocol (EAP) request to the supplicant and the supplicant sending a reply which the authenticator forwards to an authentication server. If the authenticator does not get a reply to the EAP request, it waits a specified period of time before retransmitting. The `dot1x timeout tx-period` command configures that wait time.

The `no dot1x timeout tx-period` and `default dot1x timeout tx-period` commands restore the default wait time by removing the corresponding `dot1x timeout tx-period` command from *running-config*.

Command Mode

Interface-Ethernet Configuration

Interface-Management Configuration

Command Syntax

```
dot1x timeout tx-period tx_time
```

```
no dot1x timeout tx-period
```

```
default dot1x timeout tx-period
```

Parameter

tx_time Values range from 1 to 65535. Default value is 5.

Example

These commands configure *Ethernet interface 1* to wait 30 seconds before retransmitting EAP requests to the supplicant.

```
switch(config)#interface Ethernet 1
switch(config-if-Et1)#dot1x timeout tx-period 30
switch(config-if-Et1)#
```

8.2.2.6.13 dot1x host-mode

When multiple clients are connected to an Ethernet interface providing 802.1X authentication, the port can either accept packets from all MAC addresses once the supplicant has been authenticated (multi-host mode), or it can accept only those packets originating from the MAC address of the authenticated client (single-host mode). The `dot1x host-mode` command specifies the host mode for authentication of multiple clients on the configuration mode interface.

The `no dot1x host-mode` and `default dot1x host-mode` commands restore the switch default (multi-host mode) by removing the corresponding dot1x host-mode command for the configuration mode interface.

Command Mode

Interface-Ethernet Configuration

Command Syntax

```
dot1x host-mode [multi-host | single-host]
```

```
no dot1x host-mode
```

```
default dot1x host-mode
```

Parameters

- **multi-host** Configures the interface to use multi-host mode (the default).
- **single-host** Configures the interface to use single-host mode.

Example

- These commands configure Ethernet interface 1 to use single-host mode for 802.1X authentication.

```
switch(config)#interface ethernet 1  
switch(config-if-Et1)#dot1x host-mode single-host  
switch(config-if-Et1)#
```

8.2.2.6.14 dot1x port-control

The `dot1x port-control` command configures the configuration mode interface as an authenticator port and specifies whether it will authenticate traffic.

The `no dot1x port-control` and `default dot1x port-control` commands configure the port to pass traffic without authorization by removing the corresponding `dot1x port-control` command from **running-config**.

Command Mode

Interface-Ethernet Configuration

Interface-Management Configuration

Command Syntax

```
dot1x port-control STATE
```

```
no dot1x port-control
```

```
default dot1x port-control
```

Parameters

- STATE Specifies whether the interface will authenticate traffic. The default value is **force-authorized**. Options include:
 - **auto** Configures the port to authenticate traffic using Extensible Authentication Protocol messages.
 - **force-authorized** Configures the port to pass traffic without authentication.
 - **force-unauthorized** Configures the port to block all traffic regardless of authentication.

Examples

- These commands configure Ethernet interface 1 to pass traffic without authentication. This is the default setting.

```
switch(config)#interface Ethernet 1
switch(config-if-Et1)#dot1x port-control force-authorized
switch(config-if-Et1)#
```

- These commands configure Ethernet interface 1 to block all traffic.

```
switch(config)#interface Ethernet 1
switch(config-if-Et1)#dot1x port-control force-unauthorized
switch(config-if-Et1)#
```

- These commands configure Ethernet interface 1 to authenticate traffic using EAP messages.

```
switch(config)#interface Ethernet 1
switch(config-if-Et1)#dot1x port-control auto
switch(config-if-Et1)#
```

8.2.2.6.15 show dot1x all brief

The `show dot1x all brief` command displays the IEEE 802.1X status for all ports.

Command Mode

EXEC

Command Syntax

```
show dot1x all brief
```

Example

This command displays the IEEE 802.1X status.

```
switch#show dot1x all brief
Interface          Client          Status
-----
Ethernet5          None            Unauthorized
switch#
```

8.2.2.6.16 show dot1x hosts

The `show dot1x hosts` command displays 802.1X information for all the supplicants.

Command Mode

EXEC

Command Syntax

```
show dot1x hosts [ethernet]
```

Parameter

ethernet *e_num* Ethernet interface specified by *e_num*.

Related Command

[dot1x mac based authentication](#)

Example

This command displays 802.1X information for all the supplicants.

```
switch#show dot1x hosts
Interface: Ethernet1/1
  Supplicant MAC          Auth Method          State          VLAN Id
  -----
  e2:29:cb:11:2f:4a      MAC-BASED-AUTH      SUCCESS        300
```

8.2.2.6.17 show dot1x statistics

The `show dot1x statistics` command displays 802.1X statistics for the specified port or ports.

Command Mode

EXEC

Command Syntax

```
show dot1x INTERFACE_NAME statistics
```

Parameters

- **INTERFACE_NAME** Interface type and number. Options include:
 - **all** Display information for all interfaces.
 - **ethernet** *e_num* Ethernet interface specified by *e_num*.
 - **loopback** *l_num* Loopback interface specified by *l_num*.
 - **management** *m_num* Management interface specified by *m_num*.
 - **port-channel** *p_num* Port-Channel Interface specified by *p_num*.
 - **vlan** *v_num* VLAN interface specified by *v_num*.

Output Fields

- **RxStartNumber** of EAPOL-Start frames received on the port.
- **TxReqIdNumber** of EAP-Request/Identity frames transmitted on the port.
- **RxVersionVersion** number of the last EAPOL frame received on the port.
- **RxLogoffNumber** of EAPOL-Logoff frames received on the port.
- **RxInvalidNumber** of invalid EAPOL frames received on the port.
- **TxReqNumber** of transmitted EAP-Request frames that were not EAP-Request/Identity.
- **LastRxSrcMAC**The source MAC address in the last EAPOL frame received on the port.
- **RxRespld**The number of EAP-Response/Identity frames received on the port
- **RxTotal**The total number of EAPOL frames transmitted on the port.
- **TxTotal**The total number of EAPOL frames transmitted on the port.

Example

This command displays the 802.1X statistics for *Ethernet interface 5*.

```
switch#show dot1x interface ethernet 5 statistics
Dot1X Authenticator Port Statistics for Ethernet5
-----
RxStart = 0          RxLogoff = 0          RxRespId = 0
RxStart= 0          RxInvalid = 0        RxTotal = 0
TxReqId = 0         TxReq = 0           TxTotal = 0
RxVersion = 0      LastRxSrcMAC = 0000.0000.0000
switch#
```

8.2.2.6.18 show dot1x

The **show dot1x** command displays 802.1X information for the specified interface.

Command Mode

EXEC

Command Syntax

```
show dot1x INTERFACE_NAME INFO
```

Parameters

- INTERFACE_NAME Interface type and number. Options include:
 - all Display information for all interfaces.
 - ethernet *e_num* Ethernet interface specified by *e_num*.
 - loopback *l_num* Loopback interface specified by *l_num*.
 - management *m_num* Management interface specified by *m_num*.
 - port-channel *p_num* Port-Channel Interface specified by *p_num*.
 - vlan *v_num* VLAN interface specified by *v_num*.
- INFO Type of information the command displays. Values include:
 - *<no parameter>* displays summary of the specified interface.
 - detail displays all 802.1X information for the specified interface.

Examples

- This command displays 802.1X summary information for Ethernet interface 5.

```
switch#show dot1x interface ethernet 5
Dot1X Information for Ethernet5
-----
PortControl           : auto
QuietPeriod           : 60 seconds
TxPeriod              : 5 seconds
ReauthPeriod          : 3600 seconds
MaxReauthReq          : 2
switch#
```

- This command displays detailed 802.1X information for Ethernet interface 5.

```
switch#show dot1x interface ethernet 5 detail
Dot1X Information for Ethernet5
-----
PortControl           : auto
QuietPeriod           : 60 seconds
TxPeriod              : 5 seconds
ReauthPeriod          : 3600 seconds
MaxReauthReq          : 2

Dot1X Authenticator Client

Port Status           : Unauthorized
switch#
```

8.2.2.6.19 statistics packets dropped

The `statistics packets dropped` command configures the dot1x dropped counters on the switch under dot1x configuration mode. By default, the dot1x dropped counters are disabled. The `no` form of the command disables the dot1x dropped counters from the running configuration.

The `no statistics packets dropped` command disables the dot1x dropped counters from the running configuration.

Command Mode

Dot1x Configuration

Command Syntax

```
statistics packets dropped
```

```
no statistics packets dropped
```

Example

- These commands place the switch in the dot1x mode and enable the dot1x dropped counters.

```
switch(config-dot1x)#statistics packets dropped
```

8.3 Data Plane Security

This section contains the following topics:

- [IP NAT](#)
- [Media Access Control Security](#)
- [Internet Protocol Security \(IPsec\)](#)
- [Macro-Segmentation Service \(CVX\)](#)

8.3.1 IP NAT

Network address translation (NAT) is a router process that modifies address information of IP packets in transit. NAT is typically used to correlate address spaces between a local network and a remote, often public, network. Static NAT defines a one-to-one map between local and remote IP addresses. Static maps are configured manually through CLI commands. An interface can support multiple NAT commands, but each command must specify a unique local IP address-port location.

NAT is configured on routers that have interfaces connecting to the local networks and interfaces connecting to a remote network.

Inside and Outside Addresses

In NAT configurations, IP addresses are placed into one of two categories: inside or outside. Inside refers to IP addresses used within the organizational network. Outside refers to addresses on an external network outside the organizational network.

8.3.1.1 Static IP NAT

Static NAT configurations create a one-to-one mapping and translate a particular address to another address. This type of configuration creates a permanent entry in the NAT table as long as the configuration is present, and it enables both inside and outside hosts to initiate a connection.

Static NAT options include source NAT, destination NAT, and twice NAT.

- Source NAT modifies the source address in the IP header of a packet exiting the interface, and can optionally change the source port referenced in the TCP/UDP headers.

- Destination NAT modifies the destination address in the IP header of a packet entering the interface, and can optionally change the destination port referenced in the TCP/UDP headers.
- Twice NAT modifies both the source and destination address of packets entering and exiting the interface, and can optionally change the L4 port information in the TCP/UDP headers. Twice NAT is generally used when inside network addresses overlap or otherwise conflict with outside network addresses. When a packet exits the interface, local source and destination addresses are translated to global source and destination addresses. When a packet enters the interface, global source and destination addresses are translated to local source and destination addresses.

8.3.1.1.1 Configuring Static NAT

Configuring Source NAT

Network address translation of a source address (source NAT) is enabled by the `ip nat source static` command for the configuration mode interface. Applying source NAT to interfaces that connect to local hosts shields the IP address of the host when sending IP packets to remote destinations.

This command installs hardware translation entries for forward and reverse unicast traffic. When the rule specifies a multicast group, the command does not install the reverse path in hardware. The command may include an access control list to filter packets for translation.

Note: The switch uses a common NAT table for the entire switch, not a per interface one. For example, if a customer has the same inside local address translated to different inside global addresses depending on which interface it exits. It might be translated to exit interface B's inside global address even though it exits through interface A. A way to avoid this is to use an access list that differentiates based on the destination IP address.

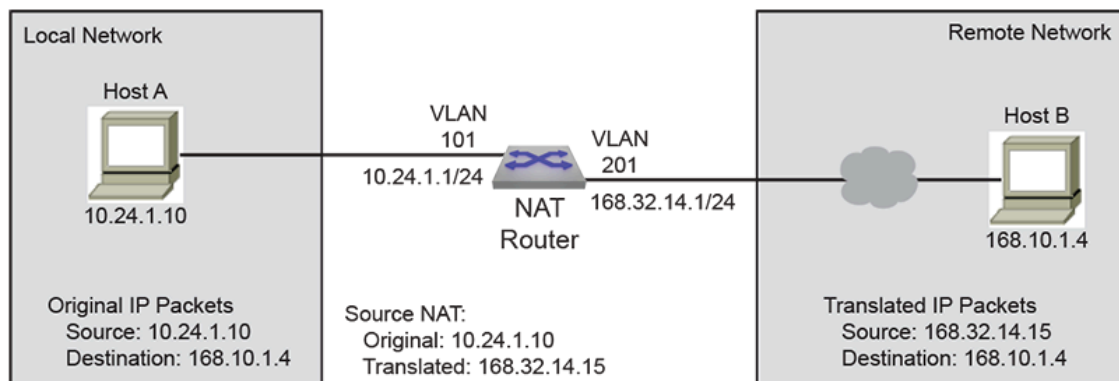

Figure 8: Source NAT Example

Example:

These commands configure `VLAN 201` to translate source address `10.24.1.10` to `168.32.14.15`.

```
switch(config)#interface vlan 201
switch(config-if-Vl201)#ip nat source static 10.24.1.10
168.32.14.15
switch(config-if-Vl201)#
```

The `ip nat source static` command may include an ACL to limit packet translation. Only packets whose source IP address matches the ACL are cleared. ACLs configured for source NAT must specify a source IP address of `any`. Source port or protocol matching is not permitted. The destination may be an IP subnet. Commands referencing nonexistent ACLs are accepted by the CLI but not installed in

hardware until the ACL is created. Modifying a referenced ACL causes the corresponding hardware entries to be replaced by entries that match the new command.

Example:

These commands configure *VLAN 101* to translate the source address *10.24.1.10* to *168.32.14.15* for all packets with IP destination addresses in the *168.10.1.1/32* subnet.

```
switch(config)#ip access-list ACL1
switch(config-acl-ACL1)#permit ip any 168.10.1.0/24
switch(config-acl-ACL1)#exit
switch(config)#interface vlan 101
switch(config-if-Vl101)#ip nat source static 168.32.14.15 access-
list ACL1
10.24.1.10
switch(config-if-Vl101)#
```

Configuring Destination NAT

Network address translation of a destination address (destination NAT) is enabled by the `ip nat destination static` command for the configuration mode interface. Applying destination NAT to interfaces that connect to remote hosts shields the IP address of the recipient host when receiving IP packets from remote destinations.

This command installs hardware translation entries for forward and reverse unicast traffic. When the rule specifies a multicast group, the command does not install the reverse path in hardware. The command may include an access control list to filter packets for translation.

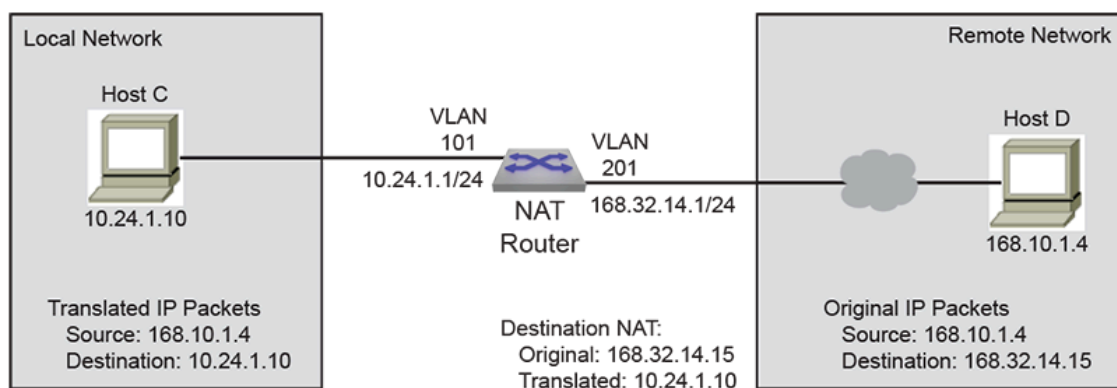

Figure 9: Detination NAT Example

Example:

These commands configure *VLAN 201* to translate destination address *168.32.14.15* to *10.24.1.10*.

```
switch(config)#interface vlan 201
switch(config-if-Vl201)#ip nat destination static 168.32.14.15
10.24.1.10
switch(config-if-Vl201)#
```

The `ip nat destination static` command may include an ACL to limit packet translation. Only packets whose source IP address matches the ACL are cleared. ACLs configured for destination NAT must

specify a destination IP address of **any**. Destination port or protocol matching is not permitted. The source may be an IP subnet. Commands referencing nonexistent ACLs are accepted by the CLI but not installed in hardware until the ACL is created. Modifying a referenced ACL causes the corresponding hardware entries to be replaced by entries that match the new command.

Example:

These commands configure *VLAN 201* to translate the destination address *168.32.14.15* to *10.24.1.10* for all packets with IP source addresses in the *168.10.1.4/32* subnet.

```
switch(config)#ip access-list ACL2
switch(config-acl-ACL2)#permit ip 168.10.1.4/32 any
switch(config-acl-ACL2)#exit
switch(config)#interface vlan 201
switch(config-if-Vl201)#ip nat destination static 168.32.14.15
access-list ACL2
10.24.1.10
switch(config-if-Vl201)#
```

Configuring Twice NAT

Network address translation of both source and destination addresses on the same interface (twice NAT) is enabled by creating one source NAT rule and one destination NAT rule on the same interface and associating them through a NAT group using the `ip nat source static` and `ip nat destination static` commands.

The `ip nat source static` command translates the actual local source address to a source address which can be used outside the local network to reference the source. The `ip nat destination static` command translates an internally used destination address to the actual IP address that is the destination of the packet.

The source and destination NAT rules must reference the same NAT group, and both should either specify only IP addresses or specify both IP addresses and L4 port information. If L4 port information is configured in one rule but not in the other, an error message will be displayed.

Each NAT rule installs hardware translation entries for forward and reverse unicast traffic. When the rule specifies a multicast group, the command does not install the reverse path in hardware. Twice NAT does not support the use of access control lists to filter packets for translation.

Example:

These commands configure *Ethernet interface 2* to translate the local source address *10.24.1.10* to the global source address *168.32.14.15*, and to translate the local destination address *10.68.104.3* to the global destination address *168.25.10.7* for all packets moving through the interface. The use of NAT *group 3* is arbitrary, but must be the same in both rules.

```
switch(config)#interface ethernet 2
switch(config-if-Et2)#ip nat source static 10.24.1.10
168.32.14.15 group 3
switch(config-if-Et2)#ip nat destination static 10.68.104.3
168.25.10.7 group 3
```

8.3.1.1.2 Static NAT Configuration Considerations

Egress VLAN filter for static NAT

When a static source NAT is configured on an interface, the source IP translation happens only for those packets that is going 'out' of this interface. If a packet is egressing on an interface which does not have NAT configured, then the source IP is not translated.

When there are two interfaces on which static SNAT is configured then the translation specified for one interface can be applied to a packet going out on the other interface.

Examples:

- In this example, the packets with source IP *20.1.1.1* going out of *E1* will still have the source IP translated to *172.1.1.1* even though the rule is configured in *E2* and not on *E1*.

```
switch(config)#interface ethernet 1
switch(config-if-Et1)#ip nat source static 10.1.1.1 171.1.1.1
switch(config)#interface ethernet 2
switch(config-if-Et2)#ip nat source static 20.1.1.1 172.1.1.1
```

- To prevent this, use an ACL to filter the traffic that needs NAT on the interfaces.

```
switch(config)#ip access-list acl1
switch(config-acl-acl1)#permit ip any 171.1.1.0/24
switch(config)#ip access-list acl2
switch(config-acl-acl2)#permit ip any 172.1.1.0/24
switch(config)#interface ethernet 1
switch(config-if-Et1)#ip nat source static 10.1.1.1 access-
list acl1 171.1.1.1
switch(config)#interface ethernet 2
switch(config-if-Et2)#ip nat source static 20.1.1.1 access-
list acl2 172.1.1.1
```

- ACL filtering is not supported when using twice NAT.

8.3.1.2 Dynamic NAT

Dynamic NAT can be used when fewer addresses are accessible than the number of hosts to be translated. A NAT table entry is created when the host starts a connection and establishes a one-to-one mapping between addresses. The mapping can vary and is dependent upon the registered addresses in the pool at the time of the communication. Dynamic NAT sessions are only allowed to be initiated only from inside networks. NAT should be configured on a Layer 3 interface, either a routed port or Switch Virtual Interface (SVI). If the host doesn't communicate for a specific period, dynamic NAT entries are removed from the translation table. The address will then returned to the pool for use by another host

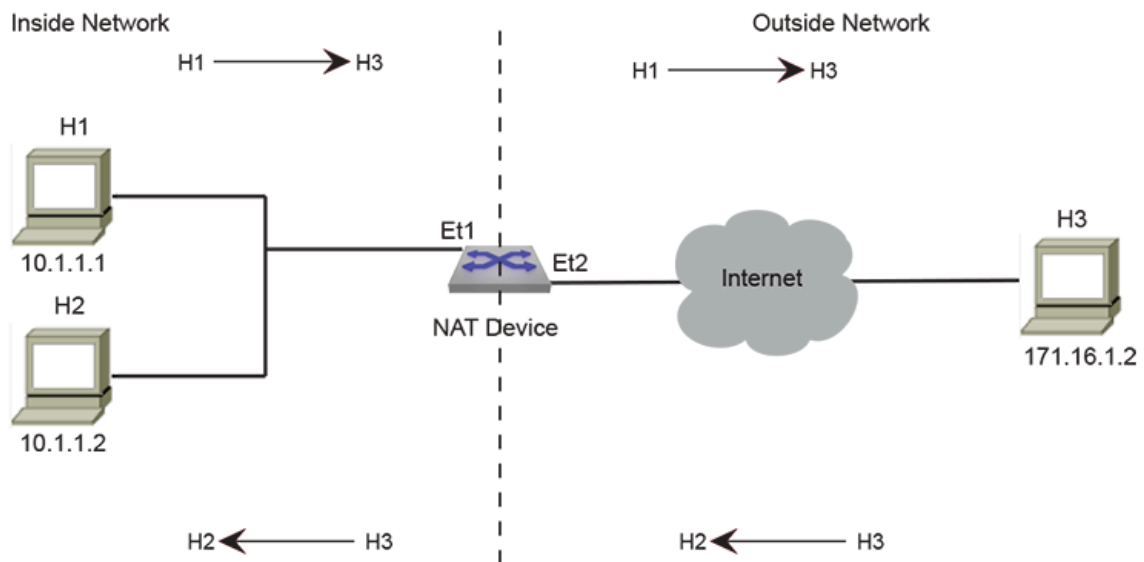

Figure 10: Dynamic NAT Scenario

Dynamic NAT options:

- Many-to-Many NAT

Maps local addresses to a global address that is selected from a pool of global addresses. After pool is configured, the first available address from the pool is picked dynamically on receiving the first packet.

- Many-to-One NAT (PAT)

PAT is a form of dynamic NAT where multiple local addresses are mapped to a single global address (many-to-one) using different source ports. This method is also called NAT Overloading, NAPT (Network and Port address translation), and Masquerade. The global address can be the IP address configured on the outside interface.

Hardware entries that translate packets are created when the CLI command is processed. Entries for forward and reverse traffic are created for unicast traffic. The hardware entry for reverse traffic is not created for multicast traffic.

Commands may include ACLs to filter packets that are cleared. Source NAT use ACLs to filter packets based on destination IP address. Destination NAT use ACLs to filter packets based on source IP address. Upon using NAT, inside usually refers to a private network while outside usually refers to a public network.

A switch with NAT configured translates forwarded traffic between inside and outside interfaces, and the flow that matches the criteria specified for translation.

The same IP address can't be used for the NAT static configuration and in the pool for dynamic NAT configurations. Public IP addresses must be unique. The global addresses used in static translations aren't excluded with dynamic pools containing the same global addresses.

Hardware entries that translate packets are created when the CLI command is processed. Entries for forward and reverse traffic are created for unicast traffic. The hardware entry for reverse traffic is not created for multicast traffic.

Commands may include ACLs to filter packets that are cleared. Source NAT use ACLs to filter packets based on destination IP address. Destination NAT use ACLs to filter packets based on source IP address. When using NAT, inside usually refers to a private network while outside usually refers to a public network.

A switch with NAT configured translates forwarded traffic between inside and outside interfaces, and the flow that matches the criteria specified for translation.



Note: The same IP address can't be used for the NAT static configuration and in the pool for dynamic NAT configurations. Public IP addresses must be unique. The global addresses used in static translations aren't excluded with dynamic pools containing the same global addresses.

8.3.1.2.1 Configuring Dynamic NAT

Prerequisites

- Configure an ACL to specify IP addresses allowed to be translated.
- Determine if you should use an IP address as the translated source address.
- Decide on a public IP address pool for address translation.

Configure the Address Pool

The addresses used for translation are configured by issuing the `ip nat pool` command in global configuration mode.

Example

This command configures the pool of addresses using start address, and end address.

```
switch(config)#ip nat pool p1 10.15.15.15 10.15.15.25
switch(config)#
```

Set the IP Address

The `ip address` command configures VLAN 201 with an IP address.

Examples

- This command configures an IPv4 address for *VLAN 201*.

```
switch(config)#interface vlan 201
switch(config-if-Vl201)#ip address 10.0.0.1/24
switch(config-if-Vl201)#
```

- This command configures the dynamic NAT source address and sets the NAT overload for pool *P2*.

```
switch(config-if-Vl201)#ip nat source dynamic access-list ACL2
pool p2
switch(config-if-Vl201)#
```

Configuring Dynamic NAT Priority

For each Dynamic NAT configuration, you can specify the priority from lowest to highest in an interface mode. The `ip nat source dynamic` command allows you to configure dynamic NAT priority from the source IP address. Multiple dynamic NAT configurations have the same priority irrespective of the order. If priority is not specified in NAT rule, by default the priority is 0 (lowest priority).

Service FTP dynamic NAT rules with a single IP in the pool are considered to be of highest priority.



Note: Priorities in address-only and non-address-only NAT rules are independent of each other.

Example

This command configures the dynamic NAT priority of the access-list in the pool with the order a5 > a4 > a3 > a2 > a1 > a0.

```
switch(config)#interface vlan 201
switch(config-if-Vl201)#ip address 10.0.0.1/24
switch(config-if-Vl201)#ip nat source dynamic access-list a0 pool
p0
switch(config-if-Vl201)#ip nat source dynamic access-list a1 pool
p1 priority 1
switch(config-if-Vl201)#ip nat source dynamic access-list a2 pool
p2 priority 2
switch(config-if-Vl201)#ip nat source dynamic access-list a3 pool
p3 priority 3
switch(config-if-Vl201)#ip nat source dynamic access-list a4 pool
p4 priority 4
switch(config-if-Vl201)#ip nat source dynamic access-list a5 pool
p5 priority 5
switch(config-if-Vl201)#
```

Define the NAT Source Address for Translation

The `ip nat source dynamic` command specifies a dynamic translation from the source IP address to the pool and to overload the pool address (or addresses).

Example

This command configures the dynamic NAT source address and sets the pool P2 NAT overload.

```
switch(config)#interface ethernet 3/1
switch(config-if-Et3/1)#ip nat source dynamic access-list ACL2
pool p2
switch(config-if-Et3/1)#
```

Specify the Timeout Values

The `ip nat translation tcp-timeout` or `ip nat translation udp-timeout` commands alter the translation timeout period for NAT translation table entries.

Examples

- This command globally sets the timeout for TCP to 600 seconds.

```
switch(config)#ip nat translation tcp-timeout 600
switch(config)#
```

- This command globally sets the timeout for UDP to 800 seconds.

```
switch(config)#ip nat translation udp-timeout 800
switch(config)#
```

8.3.1.2.2 Verify the NAT Configuration

Display the Address Pools

The `show ip nat pool` command displays the configuration of the address pool.

Example:

This command displays all the address pools configured on the switch.

```
switch#show ip nat pool

Pool      StartIp      EndIp        Prefix
p1        10.15.15.15  10.15.15.25  24
p2        10.10.15.15  10.10.15.25  22
p3        10.12.15.15  10.12.15.25  12

switch#
```

8.3.1.2.3 Clearing IP NAT Table Entries

Use the `clear ip nat flow translation` command to remove all or the specified NAT table entries.

Example:

This command clears all dynamic entries from the NAT table.

```
switch#clear ip nat flow translation
switch#
```

8.3.1.2.4 Dynamic NAT Configuration Considerations

Configuring Dynamic NAT Using Pools in a L2 Adjacent Network

When many-to-one dynamic NAT is configured using a NAT pool, and the next hop router for the NAT device is on the same network (L2 adjacent), then you must configure the IP addresses in the NAT pool as a secondary address on the interface.

Example:

The IP addresses in the NAT pool are configured as the secondary address on the interface.

```
switch(config)#ip nat pool p1 10.1.1.1 10.1.1.4 prefix-length 24
switch(config)#interface ethernet 1
switch(config-if-Et1)#ip nat source dynamic access-list a1 pool
p1
switch(config-if-Et1)#ip address 10.1.1.1/24 secondary
switch(config-if-Et1)#ip address 10.1.1.2/24 secondary
switch(config-if-Et1)#ip address 10.1.1.3/24 secondary
switch(config-if-Et1)#ip address 10.1.1.4/24 secondary
```

Configuring Dynamic NAT Using Pool in a L3 Network

If the next hop of the NAT device is on a different subnet, then you should configure a static Null route for the IP addresses in the NAT pool. Redistribute the static route using BGP/OSPF.

Examples:

- Outside Interface

```
switch(config)#interface port-channel 319
switch(config-if-Po319)#ip nat source dynamic access-list
dynamic-nat-m2m pool
natpl-dynamic-nat-m2m
switch(config)#ip access-list dynamic-nat-m2m
switch(config-acl-dynamic-nat-m2m)#10 permit ip 192.168.93.0/
24 any
switch(config)#ip nat pool natpl-dynamic-nat-m2m prefix-length
24
switch(config-natpool-p1)#range 11.3.3.2 11.3.3.10
```

- Static Null Route for Virtual IP

```
switch(config)#ip route 11.0.0.0/8 Null0
switch(config)#router ospf 1
switch(config-router-ospf)#redistribute static
```

Configuring Dynamic NAT Using Overload with ECMP Routes

Dynamic many-to-one NAT using overload (PAT) should not be configured on interfaces that form an ECMP group. When one interface in the group goes down, the return packet for connections that are already established will continue to go to the IP address of the interface that went down and will not be forwarded to the inside host. For this type of scenario, use Dynamic NAT with pool configurations.

8.3.1.2.5 Dynamic NAT Peer State Synchronization

The NAT peer state synchronization provides redundancy and resiliency for dynamic NAT across a pair of devices to avoid single NAT device failure. Both devices in redundant pair are active and they track new sessions and create or delete NAT entries dynamically. Essentially, an active NAT entry is maintained on both devices irrespective of who created the NAT entry.

Configuring Dynamic NAT Peer State Synchronization

The following prerequisites should be fulfilled before configuring NAT peer state synchronization on devices in a redundant pair.

- Both devices in redundant pair must be reachable across an IP address within the same subnet.
- NAT version on both devices in redundant pair must be compatible.
- Dynamic NAT configuration must be identical across both devices in redundant pair.

The following configuration output indicates a valid running configuration of the NAT peer state synchronization on one device.

```
ip nat pool POOL61 prefix-length 24
range 170.24.0.2 170.24.0.200

ip access-list NatACL61
10 permit ip 61.0.0.0/16 any
```



```
interface Port-Channel5
  mtu 9214
  no switchport
  ip address 10.0.0.1/31
  ip nat source dynamic access-list NatACL61 pool POOL61

ip nat synchronization
  peer-address 11.11.11.1
  local-interface Vlan1111
  port-range 1024 2048
```

The following limitations are applicable during NAT peer state synchronization.

- While configuring dynamic NAT peer state synchronization across peer switches, the port range values of the switches should always be disjoint to avoid virtual IP conflict.
- NAT peer state synchronization does not support asymmetrical TCP setup (SYN - SYNACK - ACK should always be hashed to the same peer.)
- The connection is only synchronized with a peer if the TCP state is established.

8.3.1.3 IP NAT Commands

IP NAT Commands

- `clear ip nat flow translation`
- `ip address`
- `ip nat destination static`
- `ip nat pool`
- `ip nat source dynamic`
- `ip nat source static`
- `ip nat translation counters`
- `ip nat translation low-mark`
- `ip nat translation max-entries`
- `ip nat translation tcp-timeout`
- `ip nat translation udp-timeout`
- `show ip nat access-list interface`
- `show ip nat pool`
- `show ip nat synchronization advertised-translations`
- `show ip nat synchronization discovered-translations`
- `show ip nat synchronization peer`
- `show ip nat translation`

8.3.1.3.1 clear ip nat flow translation

The `clear ip nat flow translation` command clears all or the specified NAT table entries.

Command Mode

Privileged EXEC

Command Syntax

```
clear ip nat flow translation [HOST_ADDR [DEST_ADDR]] [INTF][ PROT_TYPE]
```

Parameters

DEST_ADDR must immediately follow **HOST_ADDR**. All other parameters, including **HOST_ADDR** may be placed in any order.

- **HOST_ADDR** Host address to be modified. Options include:
 - *<no parameter>* All packets with specified destination address are cleared.
 - **address local_ipv4** IPv4 address.
 - **address local_ipv4 local_port** IPv4 address and port (port value ranges from 1 to 65535).
- **DEST_ADDR** Destination address of translated packet. Destination address can be entered only when the **HOST_ADDR** is specified. Options include:
 - *<no parameter>* All packets with specified destination address are cleared.
 - *global_ipv4* IPv4 address.
 - **global_ipv4 global_port** IPv4 address and port (port value ranges from 1 to 65535).
- **INTF** Route source. Options include:
 - *<no parameter>* All packets with specified destination address are cleared.
 - **interface ethernet e_num** Ethernet interface specified by *e_num*.
 - **interface loopback l_num** Loopback interface specified by *l_num*.
 - **interface management m_num** Management interface specified by *m_num*.
 - **interface port-channel p_num** Port-channel interface specified by *p_num*.
 - **interface vlan v_num** VLAN interface specified by *v_num*.
- **PROT_TYPE** Filters packets based on protocol type. Options include:
 - *<no parameter>* All packets with specified destination address are cleared.
 - **tcp** TCP packets with specified destination address are cleared.
 - **udp** UDP packets with specified destination address are cleared.

Examples:

- This command clears all dynamic entries from the NAT translation table.

```
switch#clear ip nat flow translation
switch#
```

- This command clears a specific NAT IP address *172.22.30.52*.

```
switch#clear ip nat flow translation address 172.22.30.52
switch#
```

- This command clears the inside entry that maps the private address *10.10.10.3* to Internet address *172.22.30.52*.

```
switch#clear ip nat flow translation address 172.22.30.52
10.10.10.3
```

```
switch#
```

8.3.1.3.2 ip address

The **ip address** command configures the IPv4 address and connected subnet on the configuration mode interface. Each interface can have one primary address and multiple secondary addresses.

The **no ip address** and **default ip address** commands remove the IPv4 address assignment from the configuration mode interface. Entering the command without specifying an address removes the primary and all secondary addresses from the interface. The primary address cannot be deleted until all secondary addresses are removed from the interface.

Removing all IPv4 address assignments from an interface disables IPv4 processing on that port.

Command Mode

Interface-Ethernet Configuration

Interface-Loopback Configuration

Interface-Management Configuration

Interface-Port-channel Configuration

Interface-VLAN Configuration

Command Syntax

```
ip address [ipv4_subnet][PRIORITY]
```

```
no ip address [ipv4_subnet][PRIORITY]
```

```
default ip address [ipv4_subnet][PRIORITY]
```

Parameters

- **ipv4_subnet** IPv4 and subnet address (CIDR or address-mask notation). *Running-config* stores value in CIDR notation.
- **PRIORITY** interface priority. Options include:
 - **<no parameter>** The address is the primary IPv4 address for the interface.
 - **secondary** The address is the secondary IPv4 address for the interface.

Guidelines

The **ip address** command is supported on routable interfaces.

Example:

This command configures an IPv4 address for VLAN 200.

```
switch(config)#interface vlan 200
switch(config-if-Vl200)#ip address 10.0.0.1/24
switch(config-if-Vl200)#
```

8.3.1.3.3 ip nat destination static

The **ip nat destination static** command enables NAT of a specified destination address for the configuration mode interface. This command installs hardware translation entries for forward and reverse unicast traffic. When the rule specifies a multicast group, the command does not install the reverse path in hardware. The command may include an access control list to filter packets for translation.

When configuring twice NAT, an arbitrary NAT group number is used to associate the source NAT and destination NAT rules. This number must be the same in both rules.

The **no ip nat destination static** and **default ip nat destination static** commands disables NAT translation of the specified destination address by removing the corresponding **ip nat destination static** command from *running-config*.

Command Mode

Interface-Ethernet Configuration

Interface-Port-channel Configuration

Interface-VLAN Configuration

Command Syntax

```
ip nat destination static ORIGINAL [FILTER] TRANSLATED [PROT_TYPE][group group_number]
```

```
no ip nat destination static ORIGINAL [FILTER] TRANSLATED [PROT_TYPE] [group group_number]
```

```
default ip nat destination static ORIGINAL [FILTER] TRANSLATED [PROT_TYPE] [group group_number]
```

Parameters

- **ORIGINAL** Destination address to be modified. Options include:
 - **local_ipv4** IPv4 address.
 - **local_ipv4 local_port** IPv4 address and port (port value ranges from 1 to 65535).
- **FILTER** Access control list that filters packets. Options include:
 - **<no parameter>** All packets with specified destination address are cleared.
 - **access-list list_name** List that specifies the packets that are cleared. Not supported when configuring twice NAT.
- **TRANSLATED** Destination address of translated packet. Options include:
 - **global_ipv4** IPv4 address.
 - **global_ipv4 global_port** IPv4 address and port (port value ranges from 1 to 65535). When configuring twice NAT, source and destination NAT rules must either both specify a port translation or both not specify a port translation.
- **PROT_TYPE** Filters packets based on protocol type. Options include:
 - **<no parameter>** All packets with specified destination address are cleared.
 - **protocol tcp** TCP packets with specified destination address are cleared.
 - **protocol udp** UDP packets with specified destination address are cleared.
- **group group_number** Used only when configuring twice NAT, the NAT group number associates a source NAT rule with a destination NAT rule on the same interface. The group number (values range from 1 to 255) is arbitrary, but must be the same in both rules.

Examples:

- These commands configure VLAN 201 to translate destination address *10.24.1.10* to *168.32.14.15*.

```
switch(config)#interface vlan 201
switch(config-if-Vl201)#ip nat destination static 10.24.1.10
168.32.14.15
switch(config-if-Vl201)#
```

- These commands configure VLAN 201 to translate the source address *10.24.1.10* to *168.32.14.15* for all packets with IP destination addresses in the *168.10.1.1/32* subnet.

```
switch(config)#ip access-list ACL2
switch(config-acl-ACL2)#permit ip 168.10.1.1/32 any
switch(config-acl-ACL2)#exit
switch(config)#interface vlan 201
switch(config-if-Vl201)#
switch(config-if-Vl201)#
```

- These commands configure Ethernet interface 2 to translate the local source address *10.24.1.10* to the global source address *168.32.14.15*, and to translate the local destination address *10.68.104.3* to the global destination address *168.25.10.7* for all packets moving through the interface. The use of NAT *group 3* is arbitrary, but must be the same in both rules.

```
switch(config)#interface ethernet 2
switch(config-if-Et2)#ip nat source static 10.24.1.10
168.32.14.15 group 3
switch(config-if-Et2)#ip nat destination static 10.68.104.3
168.25.10.7 group 3
```

8.3.1.3.4 ip nat pool

The `ip nat pool` command identifies a pool of addresses using start address, end address, and either netmask or prefix length. If its starting IP address and ending IP address are the same, there is only one address in the address pool.

The `no ip nat pool` removes the `ip nat pool` command from *running_config*.

Command Mode

Global Configuration

Command Syntax

```
ip nat pool pool_name [ADDRESS_SPAN] SUBNET_SIZE
```

```
no ip nat pool pool_name
```

```
default ip nat pool pool_name
```

Parameters

- ***pool_name*** Name of the IP address pool.
- ***ADDRESS_SPAN*** Options include:
 - ***start_addr*** The first IP address in the address pool (IPv4 addresses in dotted decimal notation).
 - ***end_addr*** The last IP address in the address pool. (IPv4 addresses in dotted decimal notation).
- ***SUBNET_SIZE*** This functions as a sanity check to ensure it is not a network or broadcast network. Options include:
 - ***netmask ipv4_addr*** The netmask of the address pool's network (dotted decimal notation).
 - ***prefix-length* <0 to 32>** The number of bits of the netmask (of the address pool's network) that are ones (how many bits of the address indicate network).

Examples:

- This command configures the pool of addresses using start address, end address, and prefix length of 24.

```
switch(config)#ip nat pool pool1 10.15.15.15 10.15.15.25
prefix-length 24
switch(config)
```

- This command removes the pool of addresses.

```
switch(config)#no ip nat pool pool1 10.15.15.15 10.15.15.25
prefix-length 24
switch(config)
```

8.3.1.3.5 ip nat source dynamic

The **ip nat source dynamic** command enables NAT of a specified source address for packets sent and received on the configuration mode interface. This command installs hardware translation entries for forward and reverse traffic. When the rule specifies a multicast group, the command does not install the reverse path in hardware. The command may include an access control list to filter packets for translation.

The **no ip nat source dynamic** and **default ip nat source dynamic** commands disables NAT translation of the specified destination address by removing the corresponding **ip nat source dynamic** command from *running_config*.

 **Note:** Ethernet and Port-channel interfaces should be configured as routed ports.

Command Mode

Interface-Ethernet Configuration

Interface-Port-channel Configuration

Interface-VLAN Configuration

Command Syntax

```
ip nat source dynamic access-list acl_name POOL_TYPE
```

```
no ip nat source dynamic access-list acl_name
```

```
default ip nat source dynamic access-list acl_name
```

Parameters

- **acl_name** Access control list that controls the internal network addresses eligible for NAT.
- **POOL_TYPE** Options include:
 - **overload** Translates multiple local addresses to a single global address. When overloading is enabled, conversations using the same IP address are distinguished by their TCP or UDP port number.
 - **pool pool_name** The name of the IP address pool. The pool is defined using the [ip nat pool](#) command.

The pool option is required even if the pool has just one address. NAT uses that one address for all of the translations.

- **pool_fullcone** Enables full cone NAT where all requests from the same internal IP address and port are mapped to the same external IP address and port.

Examples:

- This command configures the dynamic NAT source address and sets the NAT overload for pool *P2*.

```
switch(config)#interface ethernet 3/1
switch(config-if-Et3/1)#ip nat source dynamic access-list ACL2
pool p2
switch#
```

- This command disables the NAT source translation on interface Ethernet *3/1*.

```
switch(config)#interface ethernet 3/1
switch(config-if-Et3/1)#no ip nat source dynamic access-list
ACL2
```

```
switch(config-if-Et3/1)#
```

8.3.1.3.6 ip nat source static

The `ip nat source static` command enables NAT of a specified source address for the configuration mode interface. This command installs hardware translation entries for forward and reverse unicast traffic. When the rule specifies a multicast group, the command does not install the reverse path in hardware. The command may include an access control list to filter packets for translation.

When configuring twice NAT, an arbitrary NAT group number is used to associate the source NAT and destination NAT rules. This number must be the same in both rules.

The `no ip nat source static` and `default ip nat source static` commands disables NAT translation of the specified source address by removing the corresponding `ip nat source` command from *running_config*.

Command Mode

Interface-Ethernet Configuration

Interface-Port-channel Configuration

Interface-VLAN Configuration

Command Syntax

```
ip nat source static ORIGINAL [FILTER] TRANSLATED [PROT_TYPE] [group group_number]
```

```
no ip nat source static ORIGINAL [FILTER] TRANSLATED [PROT_TYPE] [group group_number]
```

```
default ip nat source static ORIGINAL [FILTER] TRANSLATED [PROT_TYPE] [group group_number]
```

Parameters

- **ORIGINAL** Source address to be modified. Options include:
 - **original_ipv4** IPv4 address.
 - **original_ipv4 original_port** IPv4 address and port (port value ranges from 1 to 65535).
- **FILTER** Access control list that filters packets. Options include:
 - **<no parameter>** All packets with specified source address are cleared.
 - **access-list list_name** List that specifies the packets that are cleared. Not supported when configuring twice NAT.
- **TRANSLATED** Source address of translated packet. Options include:
 - **translated_ipv4** IPv4 address.
 - **translated_ipv4 translated_port** IPv4 address and port (port value ranges from 1 to 65535). When configuring twice NAT, source and destination NAT rules must either both specify a port translation or both not specify a port translation.
- **PROT_TYPE** Filters packets based on protocol type. Options include:
 - **<no parameter>** All packets with specified source address are cleared.
 - **protocol tcp** TCP packets with specified source address are cleared.
 - **protocol udp** UDP packets with specified source address are cleared.
- **group group_number** Used only when configuring twice NAT, the NAT group number associates a source NAT rule with a destination NAT rule on the same interface. The group number (values range from 1 to 255) is arbitrary, but must be the same in both rules.

Restrictions

- If **ORIGINAL** includes a port, **TRANSLATED** must also include a port.
- If **ORIGINAL** does not include a port, **TRANSLATED** cannot include a port.

Examples

- These commands configure VLAN 101 to translate source address *10.24.1.10* to *168.32.14.15*.

```
switch(config)#interface vlan 101
switch(config-if-Vl101)#ip nat source static 10.24.1.10
168.32.14.15
switch(config-if-Vl101)#
```

- These commands configure VLAN 101 to translate the source address *10.24.1.10* to access-list ACL1 *168.32.14.15* for all packets with IP destination addresses in the *168.10.1.1/32* subnet.

```
switch(config)#ip access-list ACL1
switch(config-acl-ACL1)#permit ip any 168.10.1.1/24
switch(config-acl-ACL1)#exit
switch(config)#interface vlan 101
switch(config-if-Vl101)#ip nat source static 10.24.1.10
access-list ACL1
168.32.14.15
switch(config-if-Vl101)#
```

- These commands configure Ethernet interface 2 to translate the local source address *10.24.1.10* to the global source address *168.32.14.15*, and to translate the local destination address *10.68.104.3* to the global destination address *168.25.10.7* for all packets moving through the interface. The use of NAT *group* 3 is arbitrary, but must be the same in both rules.

```
switch(config)#interface ethernet 2
switch(config-if-Et2)#ip nat source static 10.24.1.10
168.32.14.15 group 3
switch(config-if-Et2)#ip nat destination static 10.68.104.3
168.25.10.7 group 3
```

8.3.1.3.7 ip nat translation counters

The `ip nat translation counters` command enables the feature to count packets that are translated by static and twice NAT rules in hardware. Once this feature is enabled, all current rules in hardware and new rules that are configured after running this command receive policers for counting packets.

The `no ip nat translation counters` and `default ip nat translation counters` commands disable the packet counter feature for static and twice NAT connections.

Command Mode

Global Configuration

Command Syntax

```
ip nat translation counters
no ip nat translation counters
default ip nat translation counters
```

Guidelines

The `ip nat translation counters` command is supported on the DCS-7150 series switches only. This command is solely intended to debug static and twice NAT translation failures in hardware. Disable this feature after completing troubleshooting. If this feature remains enabled even when the count of static connections exceed 275, it can cause unpredictable behavior including restart of FocalPointV2 agent. The restart of FocalPointV2 agent results in traffic disruption.

Example:

The `ip nat translation counters` command enables the packet counter feature for static and twice NAT connections. Using the `show ip nat translation hardware detail` and `show ip nat translation twice hardware detail` commands, you can verify the packet count.

```
switch(config)#ip nat translation counters
switch(config)#show ip nat translation hardware detail
```

Source IP	Destination IP	Translated IP	TGT	Type	Intf	Proto	Packets	Packets Reply
192.168.10.2:0	-	20.1.10.2:0	SRC	STAT	V12640	-	2	1
192.168.110.2:0	-	20.1.110.2:0	SRC	STAT	V12640	-	2	1

```
switch(config)#show ip nat translation twice hardware detail
```

Source IP	Destination IP	Translated Src IP	Translated Dst IP	Intf	Group	Proto	Packets	Packets Reply
192.16.50.2:0	10.1.50.2:0	20.1.50.2:0	10.1.60.2:0	v12922	2	-	2	1
19.16.150.2:0	10.1.150.2:0	20.1.150.2:0	10.1.160.2:0	v12922	12	-	2	

8.3.1.3.8 ip nat translation low-mark

The `ip nat translation low-mark` command configures the minimum threshold that triggers the resumption of programming new NAT translation connections.

The `ip nat translation max-entries` command specifies the maximum number of NAT translation connections that can be stored. When this limit is reached, new connections are dropped instead of being programmed in hardware or software. At this point no new connections will be programmed until the number of stored entries drop below the configured low-mark, expressed as a percentage of the max-entries value. The default low mark value is 90%.

The `no ip nat translation low-mark` and `default ip nat translation low-mark` commands restores the default low-mark value by removing the `ip nat translation low-mark` command from *running_config*.

Command Mode

Global Configuration

Command Syntax

```
ip nat translation low-mark threshold
```

```
no ip nat translation low-mark
```

```
default ip nat translation low-mark
```

Parameters

- ***threshold*** Percentage of maximum connection entries. Value ranges from 1 to 99. Default is 90.

Example:

This command globally sets the translation low mark of 93%.

```
switch(config)#ip nat translation low-mark 93  
switch(config)#
```

8.3.1.3.9 ip nat translation max-entries

The **ip nat translation max-entries** command specifies maximum number of NAT translation connections. After this threshold is reached, new connections are dropped until the number of programmed connections is reduced below the level specified by the [ip nat translation low-mark](#) command.

The **no ip nat translation max-entries** and **default ip nat translation max-entries** commands removes the maximum connection limit and resets the parameter value to zero by removing the **ip nat translation max-entries** command from *running_config*.

Command Mode

Global Configuration

Command Syntax

```
ip nat translation max-entries connections
no ip nat translation max-entries
default ip nat translation max-entries
```

Parameters

- **connections** The maximum number of NAT translation connections. Value ranges from 0 to 4294967295. Default value is 0, which removes the connection limit.

Example:

This command limits the number of NAT translation connections the switch can store to **3000**.

```
switch(config)#ip nat translation max-entries 3000
switch(config)#
```

8.3.1.3.10 ip nat translation tcp-timeout

The `ip nat translation tcp-timeout` command specifies the translation timeout period for translation table entries. The timeout period specifies the interval during which the switch will attempt to reuse an existing TCP translation for devices specified by table entries.

The `no ip nat translation tcp-timeout` and `default ip nat translation tcp-timeout` commands reset the timeout to its default by removing the corresponding `ip nat translation tcp-timeout` command from *running_config*.

Command Mode

Global Configuration

Command Syntax

```
ip nat translation tcp-timeout period
no ip nat translation tcp-timeout
default ip nat translation tcp-timeout
```

Parameters

- *period* Time-out period in seconds for port translations. Value ranges from 0 to 4294967295. Default value is 86400 (24 hours).

Examples:

- This command sets the TCP timeout for translations to 600 seconds.

```
switch(config)#ip nat translation tcp-timeout 600
switch(config)#
```

- This command removes the TCP translation timeout.

```
switch(config)#no ip nat translation tcp-timeout
switch(config)#
```

8.3.1.3.11 ip nat translation udp-timeout

The `ip nat translation udp-timeout` command specifies the translation timeout period for translation table entries. The timeout period specifies the interval the switch attempts to establish a UDP connection with devices specified by table entries.

The `no ip nat translation udp-timeout` and `default ip nat translation udp-timeout` commands disables NAT translation of the specified destination address by removing the corresponding `ip nat translation udp-timeout` command from *running_config*.

Command Mode

Global Configuration

Command Syntax

```
ip nat translation udp-timeout period
```

```
no ip nat translation udp-timeout
```

```
default ip nat translation udp-timeout
```

Parameters

- ***period*** Value ranges from 0 to 4294967295. Default value is 300 (5 minutes).

Examples:

- This command globally sets the timeout for UDP to 800 seconds.

```
switch(config)#ip nat translation udp-timeout 8 00
```

- This command removes the timeout for UDP.

```
switch(config)#no ip nat translation udp-timeout
```

8.3.1.3.12 show ip nat access-list interface

The **show ip nat acl interface** command displays the access control lists (ACLs) that are configured as source NAT or destination NAT filters. The display indicates ACL rules that do not comply with these NAT requirements:

- Source IP address is any.
- Destination IP address may use any mask size.
- Source port matching is not allowed.
- Protocol matching is not allowed.

Command Mode

EXEC

Command Syntax

```
show ip nat access-list [INTF][LISTS]
```

Parameters

- **INTF** Filters NAT statements by interface. Options include:
 - **<no parameter>** Includes all statements on all interfaces.
 - **interface ethernet e_num** Statements on specified Ethernet interface.
 - **interface loopback l_num** Statements on specified Loopback interface.
 - **interface management m_num** Statements on specified Management interface.
 - **interface port-channel p_num** Statements on specified Port-Channel Interface.
 - **interface vlan v_num** Statements on specified VLAN interface.
 - **interface vxlan vx_num** Statements on specified VXLAN interface.
- **LISTS** ACLs displayed by command. Options include:
 - **<no parameter>** All ACLs.
 - **acl_name** Specifies individual ACL.

Example:

These commands display the NAT command usage of the ACL1 and ACL2 access control lists.

```
switch>show ip nat acl ACL1

acl ACL1
    (0.0.0.0/0, 168.10.1.1/32)
Interfaces using this ACL for Nat:
    Vlan100

switch>show ip nat acl ACL2
acl ACL2
    (168.10.1.1/32, 0.0.0.0/0)
Interfaces using this ACL for Nat:
    Vlan201
switch>
```

8.3.1.3.13 show ip nat pool

The `show ip nat pool` command displays the configuration of the address pool.

Command Mode

EXEC

Command Syntax

```
show ip nat pool POOL_SET
```

Parameters

- **pool_name** The name of the pool.
- **POOL_SET** Options include:
 - *<no parameter>* All configured port channels.
 - **pool_name** The name of the pool.

Examples:

- This command displays all the address pools configured on the switch.

```
switch#show ip nat pool
Pool          StartIp      EndIp
  Prefix
p1            10.15.15.15  10.15.15.25
  24
p2            10.10.15.15  10.10.15.25
  22
p3            10.12.15.15  10.12.15.25
  12
switch#
```

- These commands display specific information for the address pools configured on the switch.

```
switch#show ip nat pool p1
Pool          StartIp      EndIp
  Prefix
p1            4.1.1.1     4.1.1.2
  24
              1.1.1.1     1.1.1.2
  24
              3.1.1.1     3.1.1.2
  24
switch#show ip nat pool p2
Pool          StartIp      EndIp
  Prefix
p2            10.1.1.1    10.1.1.2
  16
switch#
```

8.3.1.3.14 show ip nat synchronization advertised-translations

The **show ip nat synchronization advertised-translations** command displays the detailed status of devices that are advertised to a peer device.

Command Mode

EXEC

Command Syntax

```
show ip nat synchronization advertised-translations
```

Example:

This command displays details of devices that are advertised to a peer device.

```
switch#show ip nat synchronization advertised-translations
```

Source IP Type Intf	Destination IP	Translated IP	TGT
61.0.0.15:6661 DYN Et5	100.0.0.2:80	192.170.230.171:6661	SRC
61.0.0.41:2245 DYN Et5	100.0.0.2:80	192.170.230.170:2245	SRC
61.0.0.48:22626 DYN Et5	100.0.0.2:80	192.170.230.169:22626	SRC
61.0.0.41:22601 DYN Et5	100.0.0.2:80	192.170.230.170:22601	SRC
61.0.0.41:16798 DYN Et5	100.0.0.2:80	192.170.230.170:16798	SRC
61.0.0.18:22605 DYN Et5	100.0.0.2:80	192.170.230.177:22605	SRC
61.0.0.16:2256 DYN Et5	100.0.0.2:80	192.170.230.166:2256	SRC

8.3.1.3.15 show ip nat synchronization discovered-translations

The **show ip nat synchronization discovered-translations** command displays details of what has been advertised from a peer device.

Command Mode

EXEC

Command Syntax

```
show ip nat synchronization discovered-translations
```

Example:

This command displays details of devices that are advertised to a peer device.

```
switch#show ip nat synchronization discovered-translations
```

Source IP Type Intf	Destination IP	Translated IP	TGT
61.0.2.229:63 DYN Et5	100.0.0.2:63	170.24.86.180:63	SRC
61.0.15.51:63 DYN Et5	100.0.0.2:63	170.24.73.90:63	SRC
61.0.6.68:63 DYN Et5	100.0.0.2:63	170.24.110.128:63	SRC
61.0.7.163:63 DYN Et5	100.0.0.2:63	170.24.104.35:63	SRC

8.3.1.3.16 show ip nat synchronization peer

The **show ip nat synchronization peer** command displays the detailed status of a peer device.

Command Mode

EXEC

Command Syntax

```
show ip nat synchronization peer
```

Example:

This command displays details of a peer device with an IP address of *11.11.11.0* and interface *Vlan 1111* that is used to connect to the peer device.

```
switch#show ip nat synchronization peer
Description : Value
Peer : 11.11.11.0
Connection Port : 4532
Connection Source : 0.0.0.0
Kernel Interface : vlan1111
Local Interface : Vlan1111
Established Time : 1969-12-31 16:00:00
Connection Attempts : 0
Oldest Supported Version : 1
Newest Supported Version : 1
Version Compatible : True
Connection State : connected
Shutdown State : False
Status Mount State : mountMounted
Version Mount State : mountMounted
Recover Mount State : mountMounted
Reboot Mount State : mountMounted
```

8.3.1.3.17 show ip nat translation

The **show ip nat translation** command displays configured NAT statements in the switch hardware.

Command Mode

EXEC

Command Syntax

```
show ip nat translation [address | address-only | destination | detail | dynamic | hardware |
interface | kernel | max-entries | source | static | summary | twice]
```

Command position of all parameters are interchangeable.

Parameters

- **<no parameter>** Displays all NAT connections installed in software.
- **address *ipv4_addr*** Displays NAT connections of the specified IPv4 host address.
- **address-only *ipv4_addr*** Displays address-only NAT connections of the specified IPv4 host address.
- **destination** Displays destination NAT connections installed in software.
- **detail** Displays detailed output of all NAT connections.
- **dynamic** Displays dynamic NAT connections.
- **hardware** Displays NAT connections installed in hardware.
- **interface** Filters NAT connections by interface. Options include:
 - **interface ethernet *e_num*** Displays NAT connections of the specified ethernet interface.
 - **interface port-channel *p_num*** Displays NAT connections of the specified port-channel interface.
 - **interface vlan *v_num*** Displays NAT connections of the specified VLAN interface.
- **kernel** Displays NAT connections installed in kernel.
- **max-entries** Displays the configured NAT connection limits of a hardware.
- **source** Displays source NAT connections installed in software.
- **static** Displays static NAT connections.
- **summary** Displays summary of all NAT connections.
- **twice** Displays twice NAT connections.

Examples:

- This command displays all configured NAT translations.

```
switch>show ip nat translation

Source IP           Destination IP      Translated IP      TGT Type Intf
-----
192.168.1.10:62822  172.22.22.40:53   172.17.254.161:62822  SRC DYN  V13925
192.152.1.10:20342  172.22.22.40:80   172.17.254.161:22222  SRC STAT V13945
switch#
```

- This command displays NAT connections of the specified ethernet interface.

```
switch>show ip nat translation dynamic interface Ethernet 26

Source IP           Destination IP      Translated IP      TGT Type Intf
-----
192.168.1.2:8080    10.1.1.5:600      20.1.1.5:8080      SRC DYN  Et26
```

- This command displays the configured NAT connection limits of a hardware.

```
switch>show ip nat translation max-entries

Global connection limit          100
```

```

Global connection limit low mark          90 (90%)
Hosts connection limit                    20
Hosts connection limit low mark          18 (90%)
Total number of connections                1

Host          Max-Entries          Low-Mark          Connections
-----
10.1.1.1      10                    9 (90%)           0

```

8.3.2 Media Access Control Security

This section explains the basic concepts about Media Access Control Security (MACsec) including overview, configuration, and the different MACsec commands that are used.

- [MACsec Overview](#)
- [Configuring MACsec](#)
- [Displaying MACsec Information](#)
- [MACsec Key Retirement Immediate](#)
- [MACsec EAP-FAST Support](#)
- [MACsec Proxy For VXLAN](#)
- [MACsec Fallback to Unprotected Traffic](#)
- [MACsec Commands](#)

8.3.2.1 MACsec Overview

Media Access Control Security (MACsec) is an industry standard encryption mechanism that protects all traffic flowing on the Ethernet links. MACsec is based on IEEE 802.1X and IEEE 802.1AE standards.

The major benefits of MACsec are:

- MACsec supports packet authentication by providing integrity checking so that packet data is not altered during a packet flow.
- MACsec provides secure encryption at Layer 2 level by ensuring complete data confidentiality.
- A high density MACsec solution for Cloud Data Centers is integrated with 7500R for highest density and performance in a modular platform.
- Cost and performance is optimized for Data Center Interconnect to transport massive volumes of traffic through metro or long haul networks.
- Secure transport of data over distance with MACsec encryption eliminating additional intermediate devices.

8.3.2.1.1 MACsec Terminology

MACsec Key Agreement Protocol (MKA) - It is the key agreement protocol for discovering MACsec peers and negotiating keys between MACsec peers (IEEE 802.1X-REV).

Connectivity Association Key (CAK) - Endpoints that share CAK are part of the same secure Connectivity Association (CA). This key can either be a static pre-shared key or dynamically derived when 802.1X authentication is used. CAK is a master key that is used to generate all other keys that are used for MACsec.

Connectivity Associations (CA) - CA is a security relationship between MACsec-capable devices. Endpoints that share CAK are part of the same CA. There can be more than two endpoints in a secure CA. Arista implementation is limited to 2 endpoints.

Primary Key- It is ideally the CAK for the MKA session in progress.

Fallback Key- In case the primary configured key does not establish its connection, the fallback key is used, so as to ensure no loss of traffic.

Secure Association Key (SAK) - The SAK is derived from the CAK and is the key used by the network device ports to encrypt traffic for a given session.

Key Server - One of the MACsec peers in the CA becomes the Key Server. The main role of the Key Server is to create and distribute Secure Association Keys (SAKs), which are used in actual data encryption.

8.3.2.1.2 MACsec Limitations

The limitations of MACsec are:

- MACsec is supported only on point-to-point links.
- When MACsec is enabled on an interface for the first time, interface flapping occurs for MACsec to take effect.
- Until MKA protocol converges and negotiates encryption keys, the port does not forward any traffic. This occurs initially when MACsec is configured on a port.

8.3.2.1.3 MACsec Licensing

MACsec encryption is a EOS licensed feature. A valid MACsec license must be configured on a switch. MACsec licenses are tied to a switch serial number and the licensee. Every switch running MACsec requires a separate license of its own.

Please contact your system engineer to acquire the required license codes before attempting to configure MACsec.

8.3.2.1.4 MACsec in FIPS mode

Federal Information Processing Standards (FIPS) are a set of standards defined by the United States federal government related to the processing of data in computer systems by non-military government agencies and government contractors. These standards define specific requirements for various purposes such as ensuring computer security and interoperability within and across the computer networking industry.

Arista devices are compliant with FIPS 140-2 Level 1. This set of standards govern the processing of data for cryptographic modules. FIPS is enabled using the CLI configuration.

8.3.2.2 Configuring MACsec

Basic steps to configuring MACsec on the switch:

1. Enable MACsec on the switch using the **mac security** command.

```
switch(config)#mac security
```

2. Create a MACsec profile using the profile command. Profiles are mandatory for MACsec to be provisioned.

```
switch(config-mac-security)#profile <profile-name>
```

3. Configure a valid MACsec cipher authentication on the switch using the **cipher** command.

```
switch(config-mac-security-profile-test)#cipher
```

4. Configure the primary key so that the MACsec profile is made active using the **key** command.

```
switch(config-mac-security-profile-sampleProfile)#key 0abcd1 0 1234abcd
```

Optionally a fallback CAK can also be configured on a profile. This CAK is picked up by MACsec to negotiate keys if the primary CAK fails. A CAK can be configured as a backup key using the fallback keyword with the **key** command.

```
switch(config-mac-security-profile-sampleProfile)#key 1234 0 abcd
fallback
```

5. Configure a key server among the MACsec peers. The key server is responsible for generating and distributing encryption keys. The election of the key server can be influenced by configuring a key-server priority into a profile using the following command:

```
switch(config-mac-security-profile-sampleProfile)#mka key-server
priority <value>
```

A lower value indicates higher priority. If the MACsec peers have identical priority, the peer with the lower MAC address is elected as the key server. The default key server priority is 16.

6. Configure the period at which the SAK is refreshed. Since MACsec uses a Session Association Key (SAK) for encrypting data traffic, the SAK is derived from the CAK.

```
switch(config-mac-security-profile-sampleProfile)#mka session rekey-
period <period in seconds>
```

The default session rekey-period is 0. The SAK is not refreshed periodically in the absence of the above configuration.

7. Generate the cryptographic keys to strengthen the random number generator used by MACsec.

```
switch(config-mgmt-security)#entropy source hardware
```

Example

```
mac security
  license productTest db7cf232
  !
  profile macsec-test
  cipher aes256-gcm-xpn
    key 0abc1234 7 06070E234E4D0A48544540585F507E
    key 0def5678 7 09484A0C1C0311475E5A527D7C7C70 fallback
    mka session rekey-period 30
  !

interface Ethernet5/3/1
  mac security profile macsec-test
  !
management security
```

```
entropy source hardware
```

8.3.2.2.1 Configuring the FIPS mode

To configure the FIPS mode on the MACsec protocol, use the **FIPS** command.

- This command configures the FIPS mode on the MACsec protocol.

```
switch(config)#mac security
switch(config-mac-security)fips restrictions
```

8.3.2.3 Displaying MACsec Information

The following sections provide information about MACsec on a switch.

This section contains the following topics:

- [Displaying MACsec Information](#)
- [Displaying MACsec detailed information](#)
- [Displaying MACsec participants](#)
- [Displaying MACsec participants detailed information](#)
- [Displaying MACsec MKA Counters](#)
- [Displaying MACsec Security Counters Detailed Information](#)
- [Displaying MACsec Security Counters](#)
- [Displaying MACsec MKA Counters detailed information](#)
- [Displaying MACsec FIPS Status](#)

8.3.2.3.1 Displaying MACsec Information

The **show mac security interface** command shows information about the MACsec on the interface.

Example

```
switch#show mac security interface
Interface SCI Controlled Port Key in Use
Ethernet4/1/1 28:99:3a:82:6f:82::605 True 9d5bc0d3076ea4a08b99b9d9:1
Ethernet4/3/1 28:99:3a:82:6f:85::613 True 9d5bc0d3076ea4a08b99b9d9:1
```

8.3.2.3.2 Displaying MACsec detailed information

Use the **show mac security interface detail** command to display detailed information about MACsec.

Example

```
switch#show mac security interface detail
Interface: Ethernet4/1/1
  SCI: 28:99:3a:82:6f:82::605
  SSCI: 00000002
  Controlled port: True
  Key server priority: 16
  Session rekey period: 0
  Traffic: Protected
  Key in use: 9d5bc0d3076ea4a08b99b9d9:1
  Latest key: None
  Old key: 9d5bc0d3076ea4a08b99b9d9:1 (RT)

Interface: Ethernet4/3/1
  SCI: 28:99:3a:82:6f:85::613
  SSCI: 00000001
  Controlled port: True
  Key server priority: 16
  Session rekey period: 0
  Traffic: Protected
  Key in use: 9d5bc0d3076ea4a08b99b9d9:1
  Latest key: None
  Old key: 9d5bc0d3076ea4a08b99b9d9:1 (RT)
```

About the Output:

- Interface: Name of the interface.

- Secure Channel Identifier (SCI): Combination of MAC address and port number. Used to uniquely identify a Mac Security port.
 - Controlled Port: Indicates if Mac Security is enabled on the port. A value of True indicates that encryption is enabled on the port.
 - Key In Use: The SAK identifier currently in use. Combination of Key Servers message identifier (see below) and key number.
 - Key Server priority: Configured key server priority.
 - Session Rekey Period: Configured session rekey period.
 - Latest Key: Latest SAK being negotiated by Mac Security Key Agreement Protocol (MKA)
 - Old Key: The last SAK negotiated by Mac Security Key Agreement Protocol (MKA)
-  **Note:** Latest and Old key are MKA protocol specific terminology and are used to refer to the last two keys in use. For all practical purposes, Key In Use field is used to identify the current key.

8.3.2.3.3 Displaying MACsec participants

Use the **show mac security participants** command to display information about the MACsec participants.

Example

```
switch#show mac security participants
Interface: Ethernet4/1/1
  CKN: abcd
    Message ID: 9d5bc0d3076ea4a08b99b9d9
    Elected self: True
    Success: True
    Principal: True
    Default: False

  CKN: dead
    Message ID: 4ef4cf009161bd551b5e7434
    Elected self: True
    Success: True
    Principal: False
    Default: True

Interface: Ethernet4/3/1
  CKN: abcd
    Message ID: c79ad8882c2dd3a8e838a691
    Elected self: False
    Success: True
    Principal: True
    Default: False

  CKN: dead
    Message ID: 3dfd4486b5f68a81014a37ec
    Elected self: False
    Success: True
    Principal: False
    Default: True
```

8.3.2.3.4 Displaying MACsec participants detailed information

Use the **show mac security participants detail** command to display detailed information about the MACsec participants.

Example

```

switch#show mac security participants detail
Interface: Ethernet4/1/1
  CKN: abcd
    Message ID: 9d5bc0d3076ea4a08b99b9d9
    Elected self: True
    Success: True
    Principal: True
    Default: False
    KeyServer SCI: 28:99:3a:82:6f:82::605
    SAK transmit: True
    LLPN exhaustion: 0
    Distributed key identifier: 9d5bc0d3076ea4a08b99b9d9:1
    Live peer list: ['c79ad8882c2dd3a8e838a691']
    Potential peer list: []

  CKN: dead
    Message ID: 4ef4cf009161bd551b5e7434
    Elected self: True
    Success: True
    Principal: False
    Default: True
    KeyServer SCI: 28:99:3a:82:6f:82::605
    SAK transmit: False
    LLPN exhaustion: 0
    Distributed key identifier: None
    Live peer list: ['3dfd4486b5f68a81014a37ec']
    Potential peer list: []

Interface: Ethernet4/3/1
  CKN: abcd
    Message ID: c79ad8882c2dd3a8e838a691
    Elected self: False
    Success: True
    Principal: True
    Default: False
    KeyServer SCI: 28:99:3a:82:6f:82::605
    SAK transmit: True
    LLPN exhaustion: 0
    Distributed key identifier: 9d5bc0d3076ea4a08b99b9d9:1
    Live peer list: ['9d5bc0d3076ea4a08b99b9d9']
    Potential peer list: []

  CKN: dead
    Message ID: 3dfd4486b5f68a81014a37ec
    Elected self: False
    Success: True
    Principal: False
    Default: True
    KeyServer SCI: 28:99:3a:82:6f:82::605
    SAK transmit: False
    LLPN exhaustion: 0
    Distributed key identifier: None
    Live peer list: ['4ef4cf009161bd551b5e7434']
    Potential peer list:

```

About the Output

- **Connectivity Association Key Name (CKN):** Configured name of the key in use.
- **Message ID:** A random 92 bit string used as an identifier for an MKA participant.
- **Elected Self:** True if this participant is the elected key server.

- Success: True if this participant is live and has at least one live peer.
- Principal: True if this participant is the principal participant elected to distribute SAKs or if participant receives SAKs from key server.
- Default: True if this participant is a fallback/backup participant (spawned when a fallback key is configured in a Mac Security profile).
- Key Server SCI: The SCI of the key server.
- SAK Transmit: True if the participant is ready to use the negotiated key for transmit.
- LLPN Exhaustion: Increments if the number of data packets sent using the current key exceeds a certain threshold.
- Distributed Key Identifier: Message ID + key number of the most recently generated SAK.
- Live Peer List: Message IDs of all the live peers of the participant.
- Potential Peer List: Message IDs of all the potential peers of the participant. These are peers which haven't yet established mutual liveness but have sent out at least one control packet.

8.3.2.3.5 Displaying MACsec MKA Counters

Use the `show mac security mka counters` command to display information about the MACsec MKA counters.

Example

```
switch#show mac security mka counters
Interface      Rx Success    Rx Failure    Tx Success    Tx
Failure
Ethernet4/1/1  287           0             288           0
Ethernet4/3/1  288           0             287           0
```

8.3.2.3.6 Displaying MACsec Security Counters Detailed Information

Use the `show mac security counters detail` command to display detailed information about the MACsec security counters.

Example

```
switch#show mac security counters detail
Ethernet4/1/1  Counter Name    Count
-----
                outPktsEncrypted  112
                outOctetsEncrypted  11984
                outPktsUntagged     0
                outPktsTooLong      0
                outPktCtrl          224
                inPktsDecrypted     2
                inOctetsDecrypted   214
                inPktsUnchecked     0
                inPktsOK            2
                inPktsNotValid      0
                inPktsNotUsingSA    0
                inPktsCtrl          223
                inPktsNoTag         8
                inPktsTagged        0
                inPktsBadTag        0
                inPktsNoSCI         0
                inPktsLate          0

Ethernet4/3/1  Counter Name    Count
-----
                outPktsEncrypted     2
                outOctetsEncrypted   214
```

```

outPktsUntagged      0
outPktsTooLong       0
outPktCtrl           223
inPktsDecrypted      111
inOctetsDecrypted    11877
inPktsUnchecked      0
inPktsOK             111
inPktsNotValid       0
inPktsNotUsingSA    0
inPktsCtrl           224
inPktsNoTag          9
inPktsTagged         0
inPktsBadTag         0
inPktsNoSCI          0
inPktsLate           0

```

8.3.2.3.7 Displaying MACsec Security Counters

Use the **show mac security counters** command to display information about the MACsec security counters.

Example

```

switch#show mac security counters
Port      InPktsDecrypted  InOctetsDecrypted  OutPktsEncrypted  OutOctetsEncrypted
Et4/1/1   2                214                109               11663
Et4/3/1   109              11663              2                 214

```

8.3.2.3.8 Displaying MACsec MKA Counters detailed information

Use the **show mac security mka counters detail** command to display detailed information about the MACsec MKA counters.

Example

```

switch#show mac security mka counters detail
Interface: Ethernet4/1/1
Tx packet success: 290
Tx packet failure: 0
  Tx invalid: 0
Rx packet success: 289
Rx packet failure: 0
  Rx invalid: 0
  Rx eapol error: 0
  Rx basic parameter set error: 0
  Rx unrecognized CKN error: 0
  Rx ICV validation error: 0
  Rx live peer list error: 0
  Rx potential peer list error: 0
  Rx SAK use set error: 0
  Rx distributed SAK set error: 0
  Rx distributed CAK set error: 0
  Rx ICV Indicator error: 0
  Rx unrecognized parameter set error: 0

Interface: Ethernet4/3/1
Tx packet success: 289
Tx packet failure: 0
  Tx invalid: 0
Rx packet success: 290
Rx packet failure: 0
  Rx invalid: 0

```

```
Rx eapol error: 0
Rx basic parameter set error: 0
Rx unrecognized CKN error: 0
Rx ICV validation error: 0
Rx live peer list error: 0
Rx potential peer list error: 0
Rx SAK use set error: 0
Rx distributed SAK set error: 0
Rx distributed CAK set error: 0
Rx ICV Indicator error: 0
Rx unrecognized parameter set error: 0
```

8.3.2.3.9 Displaying MACsec FIPS Status

Use `show mac sec status` command to display information about the MACsec FIPS status.

Example

```
switch(config)#mac security
switch(config-mac-security)#show mac sec status
Active Profiles:          1
FIPS Mode:                Yes
Secured Interfaces:      2
```

8.3.2.4 MACsec Key Retirement Immediate

The MACsec uses the concept of configuring two keys for MKA negotiation: Primary and Fallback (as a backup). Given a mac security profile configured on an interface, there is an actor created per key which is responsible for MKA negotiation with the other peer. When a new primary key is configured, old primary keys actor is retained in the system till the time MKA session becomes successful with the configured new primary key. Same holds good for fallback key as well. When `key retirement immediate` command is used it removes the actor corresponding to old key, be it primary or fallback, from the system immediately.

MACsec Key Retirement Immediate Operations

- If a new primary key is configured in a mac security profile, old primary keys actor is deleted from the system immediately.
- If a new fallback key is configured in a mac security profile, old fallback keys actor is deleted from the system immediately.
- Removing the feature configuration from mac security profile will just prevent cleaning up of old keys immediately when new keys are configured. It will not create old actor again.



Note: The `key retirement immediate` command only deletes the actor corresponding to old key. It does not clean up the SAK programmed in the hardware until a new SAK is available to be programmed. However, as a side effect of deletion of actor, a new principal actor will be chosen (if an eligible actor is available) over which a new SAK will be distributed subsequently.

MACsec Key Retirement Immediate Feature Interactions

MACsec EAP-FAST Support

If Dynamic MAC Security keys is used with key retirement immediate, then on every new primary key derived from 802.1X, old primary keys actor will be deleted from the system. This will usually happen based on the reauth time interval configuration for 802.1X.

MACsec Fallback to Unprotected Traffic Support

The key retirement immediate is configured with Fallback to Unprotected Traffic feature, transition between unprotected traffic and protected traffic may become more frequent. This is because with Key Retirement Immediate feature, whenever a new key is configured, existing successful MKA session corresponding to the old key are not maintained, which might bring down the number of successful MKA sessions to zero, which eventually moves the interface to unprotected traffic state as per Fallback to Unprotected Traffic feature functionality.

8.3.2.4.1 MACsec Key Retirement Immediate Configuration

The `show dot1x supplicant` command is configured in mac security profile mode, the configuration needs to be present on both key server and non key server peers. Since key server decides the principal actor for SAK distribution, it is recommended that this configuration is present in key server for triggering the re-election of principal actor immediately.

If key retirement immediate is configured only on key server, non key server will still try to negotiate MKA over old primary key unnecessarily utilizing some system resources and some time even when not required.

If key retirement immediate is configured only on non key server, it will take 6 seconds (MKA Lifetime) for triggering any re-election on key server as a result of session failure.

```
switch(config-mac-security-profile-sampleProfile) # [no] key retirement
immediate
```

Configuration Scenarios

When both Primary Key and Fallback Key configured: without configuring key retirement immediate, when a new primary is configured, the actor corresponding to the old actor will stay active till MKA session on the new primary becomes successful. With key retirement immediate, the actor corresponding to the old primary is deleted immediately. Since fallback is also configured, key server will choose it as the new principal actor, if eligible. Once a new principal actor is chosen, new SAK is distributed which will eventually get programmed and used for encryption & decryption.

When only Primary Key is configured: the behavior is same as above except the fact that no other actor will become principal until the new primary becomes successful. Till then hardware will continue to use SAK generated with old primary.

When Fallback is Principal actor: without key retirement immediate, when a new fallback key is configured, old fallback will stay in the system till the time new fallback becomes active or primary becomes active. With key retirement immediate, old fallback actor is deleted immediately. Till the time a new principal actor is elected, hardware will continue to use SAK generated with old fallback.

The `show mac security participants` command shows all the participants present in the system. When key retirement immediate is configured, the actor corresponding to old keys will no longer list up in the output of the above `show` command.

8.3.2.5 MACsec EAP-FAST Support

The Media Access Control Security (MACsec) with static keys feature brings support for dynamic Mac Security keys. To derive Mac Security keys dynamically, both peers must be configured for 802.1X authentication. One peer must be configured to be the Authenticator and the other peer to be the Supplicant. Upon a successful 802.1X authentication sequence between the peers, keying material is generated by both the authenticator and the supplicant. This keying material is then used to derive Mac Security keys to establish a MACsec Key Agreement (MKA) protocol session. This feature brings in support for Arista devices to act as the supplicant to derive Mac Security keys in a bidirectional fashion.

The following diagram illustrates a typical Mac Security + 802.1X topology:

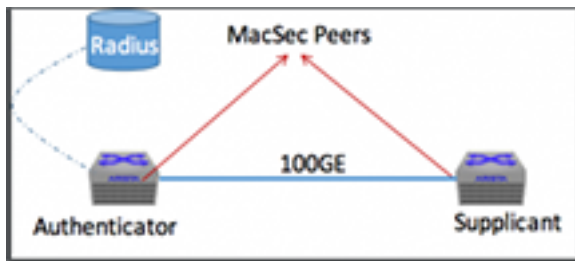

8.3.2.5.1 Platform Compatibility

Mac Security dynamic key derivation is supported on all MACsec capable switches. This includes 7500E-6CFPX-LC, 7500R-8CFPX-LC, 7500RM-36CQ-LC, 7500R2M-36CQ-LC, 7280SRAM-48C6, 7280SRM-40CX2, and 7280CR2M-30.

8.3.2.5.2 Configuring MAC Security Dynamic Key Derivation

8.3.2.5.2.1 802.1X Authenticator Configuration

A new option is added to 802.1X authenticator configuration to make the authenticator more strong to unreliable authentication servers. By default, when an authentication server is unreachable, the authenticator blocks all traffic on the port and keeps the port as Unauthorized until it gets replies from the authentication server. The following option changes the behavior and maintains the port in its current state if the authentication server is not reachable:

Example

```
switch(config-if-Et1) #dot1x timeout reauth-timeout-ignore always
```

8.3.2.5.2.2 802.1X Supplicant Configuration

The 802.1X supplicant configurations are done through MACsec profiles. MACsec profile contain all the credentials necessary for 802.1X authentication to succeed.

Following are the steps to configure an 802.1X supplicant profile:

1. Use `dot1x` command to enter the dot1x mode to configure a supplicant profile.

```
switch(config) #dot1x
switch(config-dot1x) #
```

2. Use `supplicant profile` command to configure a 802.1X supplicant profile.

```
switch(config) #supplicant profile <profileName>
```

The following mandatory commands must be configured for a supplicant profile to be operational:

3. An Extensible Authentication Protocol (EAP) method must be configured for the profile. The only method supported by Arista supplicants is EAP-FAST.

```
switch(config-dot1x-supp-profile-test)#eap-method fast
```

- a. Configure EAP Identity which is used to authenticate the supplicant with the Radius server:

```
switch(config-dot1x-supp-profile-test)#identity <user-identity>
```

- b. Configure EAP pass-phrase the password used to authenticate the supplicant with the Radius server:

```
switch(config-dot1x-supp-profile-test)#passphrase <options>
```

Example

- This is an sample 802.1X supplicant profile:

```
switch(config-dot1x-supp-profile-test)#show active
dot1x
  supplicant profile test
    identity arista
    passphrase 7 070E334D5D1D0B04
```

- a. Apply the supplicant profile by enabling it on the Mac Security interface:

```
switch(config-if-Et6/1)#dot1x pae supplicant test
```

Mac Security

Mac Security configuration remains the same as described in the configuration guide with a single important difference. Instead of configuring manual keys, a Mac security profile must instead be configured to use dynamic keys:

```
switch(config-mac-security-profile-test)#key source dot1x
```

8.3.2.5.3 Displaying 802.1X Supplicant Status

- The `show dot1x supplicant` command displays the 802.1X supplicant status.

```
switchb#show dot1x supplicant
Interface: Ethernet6/1
  Identity: arastra
  EAP method: fast
  Status: success
  Supplicant MAC: 44:4c:a8:34:bf:20
  Authenticator MAC: 00:1c:73:e0:d3:76
```

About the Output

Interface: The port on which the supplicant is running.

Identity: Configured supplicant identity.

EAP method: Configured EAP method (Currently just EAP-FAST)

Status: Supplicant Status. Can be one of the following:

- Success Authentication has been successful.
- Down Authentication sequence has not begun.
- Failed Authentication has failed.

- Connecting Authentication is in progress.
- Unused Supplicant is uninitialized.

Supplicant MAC: MAC address of the supplicant.

Authenticator MAC: MAC address of the authenticator (peer).

Existing Mac Security show commands can be used to look at Mac Security status.

8.3.2.6 MACsec Proxy For VXLAN

The MACsec Proxy for VXLAN feature enables the MACsec service over VXLAN. MACsec over VXLAN is provided by mapping a Visual Networking Index (VNI), Remote VXLAN tunnel endpoint (VTEP) IP to a MACsec proxy sub interface.

Any packets routed to the MACsec proxy sub interface is encrypted and tunneled to the remote VTEP. On the receiving path the packets are decrypted, then decapsulated and forwarded. MKA negotiates and renews the encryption keys, for this purpose a MACsec capable front panel port has to be dedicated and cannot be plugged in as it will be used to recycle packets being encrypted and decrypted.

8.3.2.6.1 Configuring MACsec Proxy For VXLAN

The switch platforms which use this feature are:

- 7280SRAM-48C6
- 7280CR2M-30
- 7500R2M-36CQ-LC

The mandatory steps to configure a MACsec proxy sub-interface on an Arista switch are:

1. Configure the parent interface to be a routed port.
2. Create a L3 sub-interface on the parent interface. This is the MACsec proxy sub-interface.
3. Create a L2 sub-interface on the parent interface. This is the MACsec patch sub-interface.
4. Configure and enable the MACsec proxy port on a sub-interface.
5. Configure the VXLAN tunnel.
6. Assign the forwarding VLAN ID for the MACsec patch sub-interface and VXLAN tunnel.

Example Configurations

- a. Configure a 100g MACsec interface as a routed port.

```
switch(config)#interface et49/1
switch(config-if-Et49/1)#no switchport
```

- b. Create a new L3 sub-interface - et49/1.1

```
switch(config-if-Et49/1)#interface et49/1.1
```

- c. Create a new L2 sub-interface - et49/1.2

```
switch(config-if-Et49/1)#interface et49/1.2
```

- d. Configure the MACsec proxy port, and enable MACsec on the proxy port.

```
switch(config)#interface et49/1.1
switch(config-if-Et49/1.1)#mac security proxy patch Ethernet49/1.2
switch(config-if-Et49/1.1)#mac security profile test1
```

```
switch(config-if-Et49/1.1)#ip address 2.2.2.1/24
```

- e. Configure the VXLAN tunnel. The remote VTEP is provided as the flood VTEP.

```
switch(config)#interface vxlan 1
switch(config-if-Vx1)#vxlan source-interface Loopback0
switch(config-if-Vx1)#vxlan udp-port 4789
switch(config-if-Vx1)#vxlan vlan 20 vni 20
switch(config-if-Vx1)#vxlan vlan 20 flood vtep 100.100.100.2
```

- f. Configure the L2 MACsec patch interface to be in the same VLAN as VXLAN.

```
switch(config)#interface et49/1.2
switch(config-if-Et49/1.2)#vlan id 20
```

8.3.2.6.2 Displaying MACsec Proxy For VXLAN Information

- Use `show mac security interface` command to display the proxy sub-interface information.

Example

- Use `show mac security mka counters` command to display the MACsec counters and detailed values.

```
switch(config)#show mac security interface
Interface      SCI                               Controlled Port  Key in Use
Ethernet4/1/1  28:99:3a:82:6f:82::605          True             9d5bc0d3076ea4a08b99b9d9:1
Ethernet4/3/1  28:99:3a:82:6f:85::613          True             9d5bc0d3076ea4a08b99b9d9:1
```

Example

```
switch(config)#show mac security mka counters
Interface      Rx Success  Rx Failure  Tx Success  Tx Failure
Ethernet4/1/1  287         0           288         0
Ethernet4/3/1  288         0           287         0

switch(config)#show mac security mka counters ethernet 49/1.1 detail
Interface: Ethernet49/1.1
Tx packet success: 84
Tx packet failure: 0
Tx invalid: 0
Rx packet success: 82
Rx packet failure: 0
Rx invalid: 0
Rx eapol error: 0
Rx basic parameter set error: 0
Rx unrecognized CKN error: 0
Rx ICV validation error: 0
Rx live peer list error: 0
Rx potential peer list error: 0
Rx SAK use set error: 0
Rx distributed SAK set error: 0
Rx distributed CAK set error: 0
Rx ICV Indicator error: 0
Rx unrecognized parameter set error: 0
```

8.3.2.6.3 Limitations

When this feature is in use, following limitations can be noticed :

- An interface while moving from allowing unprotected traffic to allowing only protected traffic can experience a traffic disruption of up to 4 seconds.
- If the key server interface manages to establish a MKA session with its old credentials (CKN/CAK pair) while unprotected traffic was allowed, then traffic disruption for a duration of up to 6 seconds can be noticed in addition to the duration mentioned in the above point.

8.3.2.7 MACsec Fallback to Unprotected Traffic

When MACsec is enabled on an interface, it tries to establish MACsec Key Agreement (MKA) session(s) with its peer. If no MKA sessions is successfully established, then the interface can continue to protect the traffic with the last known negotiated key, and if such a key does not exist then it blocks the traffic. The MACsec Fallback to Unprotected Traffic feature introduces an optional configuration which, if provided, allows unprotected traffic whenever there is no successful MKA session with the peer in the following scenarios:

- If MACsec is enabled on an interface with this feature configured, then the interface allows unprotected traffic immediately without waiting for MKA session establishment
- If a MACsec enabled interface was blocking traffic as no MKA sessions were established and its corresponding MACsec profile is changed to enable this feature, the interface will start allowing unprotected traffic immediately.
- If a MACsec enabled interface was allowing unprotected traffic and its corresponding MACsec profile is changed to disable this feature, the interface will block traffic immediately.
- While an interface is allowing unprotected traffic, it will stop doing so when a new Secure Association Key (SAK) is generated (if this interface is key server) or when a SAK is received from the key-server (if this interface is not the key server).
- If MACsec Fallback to Unprotected Traffic is configured and all MKA sessions between the peers fail, the peers will switch to unprotected traffic. If not configured, protected traffic could have continued with last known negotiated key.

To protect traffic between pairs, primary MKA session derived keys are given priority over Fallback MKA session. With this feature enabled, the priority order of traffic between peers is -

1. Protected using derived keys from primary MKA sessions
2. Protected using derived keys from Fallback MKA sessions
3. Unprotected traffic



Note: Arista allows a primary and a Fallback Connectivity Association Key (CAK) and Connectivity Association Key Name (CKN) pair to be configured on an interface. And interfaces tries to establish a MKA session with its peer corresponding to each CAK/CKN pair.

8.3.2.7.1 MACsec Fallback to Unprotected Traffic Feature Interaction

This feature interacts with other related features in following way -

- MACsec EAP-FAST Support - If dynamic MAC Security keys (derived from 802.1X authentication) are used, then the feature configuration has no effect.
- MACsec Proxy Interfaces -This feature does not work with MACsec proxy sub interfaces.
- Key Retirement Immediate - If this feature is configured with Key Retirement Immediate feature on an interface, transition between unprotected traffic and protected traffic may become more frequent. This is because with Key Retirement Immediate feature, whenever a new key is configured, existing successful MKA session corresponding to the old key is not maintained.

8.3.2.7.2 Limitations

When this feature is in use, following limitations can be noticed :

- An interface while moving from allowing unprotected traffic to allowing only protected traffic can experience a traffic disruption of up to 4 seconds.
- If the key server interface manages to establish a MKA session with its old credentials (CKN/CAK pair) while unprotected traffic was allowed, then traffic disruption for a duration of up to 6 seconds can be noticed in addition to the duration mentioned in the above point.

8.3.2.7.3 Configuring MACsec Fallback to Unprotected Traffic

This feature is supported on all MACsec capable cards except for 7500E-6CFPX-LC.

The MACsec Fallback to Unprotected Traffic feature is configured under MACsec profile mode using the `[no] traffic unprotected allow` command. The `no` form of the command removes the configuration from the switch. This configuration must be present in both the peers for the unprotected traffic to flow between them successfully.

Example

```
switch(config-mac-security-profile-sampleProfile)#no traffic unprotected allow
```

8.3.2.7.4 Displaying MACsec Fallback to Unprotected Traffic Information

The `show mac security interface detail` command can be used to verify if the interface is currently allowing unprotected traffic.

```
switch#show mac security interface Ethernet 6/1/1 detail
Interface: Ethernet4/1/1
  SCI: 28:99:3a:82:6f:82::605
  SSCI: 00000002
  Controlled port: True
  Key server priority: 16
  Session rekey period: 0
  Traffic: Unprotected
  Key in use: 9d5bc0d3076ea4a08b99b9d9:1
  Latest key: None
  Old key: 9d5bc0d3076ea4a08b99b9d9:1 (RT)

Interface: Ethernet4/3/1
  SCI: 28:99:3a:82:6f:85::613
  SSCI: 00000001
  Controlled port: True
  Key server priority: 16
  Session rekey period: 0
  Traffic: Protected
  Key in use: 9d5bc0d3076ea4a08b99b9d9:1
  Latest key: None
  Old key: 9d5bc0d3076ea4a08b99b9d9:1 (RT)
```

8.3.2.8 MACsec Commands

MACsec Configuration Commands

- [cipher](#)
- [entropy source hardware](#)
- [key \(MACsec\)](#)
- [license](#)
- [mac security](#)
- [mka key-server](#)
- [mka session](#)
- [profile](#)

MACsec Key Retirement Immediate Commands

- [key retirement immediate](#)

MACsec Show Commands

- [show mac security counters](#)
- [show mac security counters detail](#)
- [show mac security interface](#)
- [show mac security interface detail](#)
- [show mac security mka counters](#)
- [show mac security participants](#)
- [show mac security participants detail](#)
- [show mac security status](#)

MACsec EAP FAST Support Commands

- [dot1x](#)
- [dot1x pae supplicant](#)
- [dot1x timeout reauth-timeout-ignore always](#)
- [show dot1x supplicant](#)
- [supplicant profile](#)

MACsec Fallback to Unprotected Traffic

- [traffic unprotected allow](#)

8.3.2.8.1 cipher

The **cipher** command configures the cipher authentication for MAC security on the switch.

Command Mode

MACsec Profile

Command Syntax

```
cipher <options>
```

Parameters

- options The cipher authentication options.
 - aes128-gcm-xpn Advanced Encryption Standard (128 bit, Galois/Counter mode, Extended Packet Numbering)
 - aes256-gcm-xpn Advanced Encryption Standard (256 bit, Galois/Counter mode, Extended Packet Numbering)

Example

The following command configures the **cipher aes128-gcm-xpn** for MAC security on the switch for the MACsec profile called test.

```
switch(config-mac-security-profile-test)#cipher aes128-gcm-xpn
```

8.3.2.8.2 dot1x pae supplicant

The `dot1x pae supplicant` command applies the supplicant profile by enabling it on the Mac Security interface.

Command Mode

Interface Configuration

Command Syntax

```
dot1x pae supplicant
```

Example

The following command applies the supplicant profile test on the *MACsec interface 6/1*.

```
switch(config-if-Et6/1)#dot1x pae supplicant test
```

8.3.2.8.3 dot1x timeout reauth-timeout-ignore always

The `dot1x timeout reauth-timeout-ignore always` command retains the current port state without blocking it irrespective of when the authentication server is unreachable or in-case of supplicant time outs.

Command Mode

Interface Configuration

Command Syntax

```
dot1x timeout reauth-timeout-ignore always
```

Example

The following command retains the current port status of *interface Ethernet 6/1* when there is authentication server timeout.

```
switch(config-if-Et6/1)#dot1x timeout reauth-timeout-ignore always
```

8.3.2.8.4 dot1x

The **dot1x** command places the switch in the dot1x mode. In this mode user is allowed to configure various MACsec configurations.

Command Mode

Global Configuration

Command Syntax

```
dot1x
```

Example

The following command places the switch in the **dot1x** mode.

```
switch(config) #dot1x  
switch(config-dot1x) #
```

8.3.2.8.5 entropy source hardware

The **entropy source hardware** command generates the cryptographic keys to strengthen the random number generator used by MACsec.

Command Mode

Management Configuration

Command Syntax

```
entropy source hardware
```

Example

The following command configures the entropy source hardware and generates the cryptographic keys.

```
switch(config)#management security  
switch(config-mgmt-security)#entropy source hardware
```

8.3.2.8.6 key (MACsec)

The **key** command configures the primary key so that the MACsec profile is activated.

 **Note:** Optionally a fallback CAK can also be configured on a profile. This CAK is picked up by MACsec to negotiate keys if the primary CAK fails. A CAK can be configured as a backup key using the fallback keyword with the key command.

Command Mode

MACsec Profile Configuration

Command Syntax

key <options>

Parameter

- CKN Connectivity association key name in hex octets. Options include.
 - 0Specifies that an UNENCRYPTED key will follow
 - 7Specifies that an HIDDEN key will follow
 - CAKConnectivity association key in hex octets
 - fallbackConfigure the key as a fallback
- retirement Retire the key. Options include.
 - immediate Retire the key immediately
- source List of sources to derive MAC security keys. Options include.
 - dot1xDerive MAC security keys from IEEE 802.1X based port authentication
 - group-cak Derive MAC security keys from Group CAK Distribution.

Examples

- The following example configures the primary key for the profile called sample profile for MAC security on the switch.

```
Switch(config)#mac security
Switch(config-mac-security)#profile sample_Profile
Switch(config-mac-security-profile-sample_Profile)#key 0abcd1 0
1234abcd
```

- The following example configures the fallback CAK on a profile.

```
Switch(config)#mac security
Switch(config-mac-security)#profile sample_Profile
Switch(config-mac-security-profile-sample_Profile)#key 0abcd1 0
1234abcd fallback
```

8.3.2.8.7 key retirement immediate

The **key retirement immediate** command configures the key retirement feature on the key server and assists the key server to decide the principal actor for SAK distribution by triggering the re-election of principal actor immediately. It is recommended that the key retirement is configured on both key server and non key server peers.

The **no key retirement immediate** command disable the key retirement function by removing the key retirement immediate command from running-config.

Command Mode

MACsec Profile

Command Syntax

```
key retirement immediate
```

Example

The following commands configures the key retirement immediate feature on a switch for a MACsec profile called sample.

```
Switch(config)#mac security
Switch(config-mac-security)#profile sample
Switch(config-mac-security-profile-sample)#key retirement immediate
```

8.3.2.8.8 license

The **license** command configures the license for MAC security on the switch. MACsec licenses are tied to a switch. Every switch running MACsec requires a separate license of its own.



Note: Contact your system engineer to acquire the required license codes before attempting to configure MACsec.

Command Mode

MACsec Profile

Command Syntax

```
license <options>
```

Parameters

- options The options through which the license is configured.
 - WORD Licensee name.
 - import Import license from a URL. Options include.
 - 8-digit hex numberKey to authorize Mac security
 - alert-base:Path to license file
 - certificate:Path to license file
 - checkpoint:Path to license file
 - extension:Path to license file
 - file:Path to license file
 - flash:Path to license file
 - ftp:Path to license file
 - http:Path to license file
 - https:Path to license file
 - scp:Path to license file
 - sftp:Path to license file
 - system:Path to license file
 - terminal:Path to license file
 - tftp:Path to license file
 - update Trigger a check for license. Option include.
 - 8-digit hex numberKey to authorize Mac security

Example

The following example configures the license for MAC security on the switch.

```
Switch(config)#mac security  
Switch(config-mac-security)#  
Switch(config-mac-security-profile-test)#license ABC RRGGBBAA
```

8.3.2.8.9 mac security

The **mac security** command enables MAC security provision on the switch.

The **no mac security** and **default mac security** commands restore the switch to its default state by removing the corresponding mac security command from **running-config**.

Command Mode

Global Configuration

Command Syntax

```
mac security
```

```
no mac security
```

```
default mac security
```

Example

The following command will place the switch in MAC security mode.

```
Switch(config)#mac security  
Switch(config-mac-security)#
```

8.3.2.8.10 mka key-server

The **mka key-server** command configures key server among the MACsec peers.

Command Mode

MACsec Profile Configuration

Command Syntax

```
mka key-server priority <value>
```

Parameters

- *priority* MKA key server priority.
- *value* Key server priority value. Value ranges from 0 to 255.

Example

The following example configures the key server value of 10 among the MACsec peers.

```
Switch(config)#mac security  
Switch(config-mac-security)#profile sample_Profile  
Switch(config-mac-security-sample_Profile)#mka key-server priority 10
```

8.3.2.8.11 mka session

The **mka session** command configures period at which the SAK is refreshed .

Command Mode

MACsec Profile Configuration

Command Syntax

```
mka session rekey-period <value>
```

Parameter

- *rekey-period* Sets MKA session re-key period.
- *value* Session re-key period in seconds. Value ranges from 30 to 100000.

Example

- The following example configures the mka session rekey-period time of 10 seconds at which the SAK is refreshed.

```
Switch(config)#mac security  
Switch(config-mac-security)#profile sample_Profile  
Switch(config-mac-security-sample_Profile)#mka session rekey-period 10
```

8.3.2.8.12 profile

The **profile** command configures the MACsec profile for MAC security on the switch. Profiles are mandatory for MACsec to be provisioned.

Command Mode

MACsec Configuration

Command Syntax

```
profile <profile-name>
```

Parameter

profile-name Name of the MACsec profile.

Example

The following example configures the MACsec profile called sample profile for MAC security on the switch.

```
Switch(config) #mac security  
Switch(config-mac-security) #profile sample_Profile
```

8.3.2.8.13 show dot1x supplicant

The `show dot1x supplicant` command displays the 802.1X supplicant status.

Command Mode

EXEC

Command Syntax

```
show dot1x supplicant
```

Example

The following example displays information about 802.1X supplicant status.

```
switchb#show dot1x supplicant

Interface: Ethernet6/1
  Identity: arastra
  EAP method: fast
  Status: success
  Supplicant MAC: 44:4c:a8:34:bf:20
  Authenticator MAC: 00:1c:73:e0:d3:76
```

About the Output

Interface: The port on which the supplicant is running.

Identity: Configured supplicant identity.

EAP method: Configured EAP method (Currently just EAP-FAST)

Status: Supplicant Status. Can be one of the following:

- Success Authentication has been successful.
- Down Authentication sequence has not begun.
- Failed Authentication has failed.
- Connecting Authentication is in progress.
- Unused Supplicant is uninitialized.

Supplicant MAC: MAC address of the supplicant.

Authenticator MAC: MAC address of the authenticator (peer). Existing Mac Security show commands can be used to look at Mac Security status.

8.3.2.8.14 show mac security counters detail

The **show mac security counters detail** command displays the detail information about the MACsec security counters.

Command Mode

EXEC

Command Syntax

```
show mac security counters detail
```

Example

The following example displays detail information about MACsec security counters.

```
switch#show mac security counters detail
Ethernet4/1/1      Counter Name      Count
-----
                outPktsEncrypted      112
                outOctetsEncrypted  11984
                outPktsUntagged     0
                outPktsTooLong      0
                outPktCtrl          224
                inPktsDecrypted     2
                inOctetsDecrypted    214
                inPktsUnchecked     0
                inPktsOK            2
                inPktsNotValid      0
                inPktsNotUsingSA    0
                inPktsCtrl          223
                inPktsNoTag         8
                inPktsTagged        0
                inPktsBadTag        0
                inPktsNoSCI         0
                inPktsLate          0

Ethernet4/3/1      Counter Name      Count
-----
                outPktsEncrypted     2
                outOctetsEncrypted    214
                outPktsUntagged       0
                outPktsTooLong        0
                outPktCtrl            223
                inPktsDecrypted       111
                inOctetsDecrypted     11877
                inPktsUnchecked       0
                inPktsOK              111
                inPktsNotValid        0
                inPktsNotUsingSA      0
                inPktsCtrl            224
                inPktsNoTag           9
                inPktsTagged          0
                inPktsBadTag          0
                inPktsNoSCI           0
                inPktsLate            0
```

8.3.2.8.15 show mac security counters

The `show mac security counters` command displays information about the MACsec security counters.

Command Mode

EXEC

Command Syntax

```
show mac security counters
```

Example

The following example displays information about MACsec security counters.

```
switch#show mac security counters
Port          InPktsDecrypted  InOctetsDecrypted  OutPktsEncrypted  OutOctetsEncrypted
Et4/1/1      2                214                109               11663
Et4/3/1      109              11663              2                 214
```

8.3.2.8.16 show mac security interface detail

The `show mac security interface detail` command displays the detail information about the MACsec on the interface.

Command Mode

EXEC

Command Syntax

```
show mac security interface detail
```

Example

The following example displays detail information about MACsec on the interface.

```
switch#show mac security interface detail
Interface: Ethernet4/1/1
  SCI: 28:99:3a:82:6f:82::605
  SSCI: 00000002
  Controlled port: True
  Key server priority: 16
  Session rekey period: 0
  Traffic: Protected
  Key in use: 9d5bc0d3076ea4a08b99b9d9:1
  Latest key: None
  Old key: 9d5bc0d3076ea4a08b99b9d9:1 (RT)

Interface: Ethernet4/3/1
  SCI: 28:99:3a:82:6f:85::613
  SSCI: 00000001
  Controlled port: True
  Key server priority: 16
  Session rekey period: 0
  Traffic: Protected
  Key in use: 9d5bc0d3076ea4a08b99b9d9:1
  Latest key: None
  Old key: 9d5bc0d3076ea4a08b99b9d9:1 (RT)
```

About the Output

- **Interface:** Name of the interface.
- **Secure Channel Identifier (SCI):** Combination of MAC address and port number. Used to uniquely identify a Mac Security port.
- **Controlled Port:** Indicates if Mac Security is enabled on the port. A value of True indicates that encryption is enabled on the port.
- **Key In Use:** The SAK identifier currently in use. Combination of Key Servers message identifier (see below) and key number.
- **Key Server priority:** Configured key server priority.
- **Session Rekey Period:** Configured session rekey period.
- **Latest Key:** Latest SAK being negotiated by Mac Security Key Agreement Protocol (MKA)
- **Old Key:** The last SAK negotiated by Mac Security Key Agreement Protocol (MKA)



Note: Latest and Old key are MKA protocol specific terminology and are used to refer to the last two keys in use. For all practical purposes, Key In Use field is used to identify the current key.

8.3.2.8.17 show mac security interface

The `show mac security interface` command shows information about the MACsec on the interface.

Command Mode

EXEC

Command Syntax

```
show mac security interface
```

Example

The following example displays information about MACsec on the interface.

```
Switch#show mac security interface
Interface      SCI                               Controlled Port Key in Use
Ethernet4/1/1  28:99:3a:82:6f:82::605           True           9d5bc0d3076ea4a08b99b9d9:1
Ethernet4/3/1  28:99:3a:82:6f:85::613           True           9d5bc0d3076ea4a08b99b9d9:1
```

8.3.2.8.18 show mac security mka counters

The `show mac security mka counters` command to display information about the MACsec MKA counters.

Command Mode

EXEC

Command Syntax

```
show mac security mka counters
```

Example

The following example displays information about MACsec MKA counters.

```
switch#show mac security mka counters
Interface      Rx Success    Rx Failure    Tx Success    Tx
Failure
Ethernet4/1/1  287           0             288           0
Ethernet4/3/1  288           0             287           00
```

8.3.2.8.19 show mac security participants detail

The **show mac security participants detail** command displays detail information about the MACsec participants.

Command Mode

EXEC

Command Syntax

```
show mac security participants detail
```

Example

The following example displays information about MACsec participants details.

```
switch#show mac security participants detail
Interface: Ethernet4/1/1
  CKN: abcd
    Message ID: 9d5bc0d3076ea4a08b99b9d9
    Elected self: True
    Success: True
    Principal: True
    Default: False
    KeyServer SCI: 28:99:3a:82:6f:82::605
    SAK transmit: True
    LLPN exhaustion: 0
    Distributed key identifier: 9d5bc0d3076ea4a08b99b9d9:1
    Live peer list: ['c79ad8882c2dd3a8e838a691']
    Potential peer list: []

  CKN: dead
    Message ID: 4ef4cf009161bd551b5e7434
    Elected self: True
    Success: True
    Principal: False
    Default: True
    KeyServer SCI: 28:99:3a:82:6f:82::605
    SAK transmit: False
    LLPN exhaustion: 0
    Distributed key identifier: None
    Live peer list: ['3dfd4486b5f68a81014a37ec']
    Potential peer list: []

Interface: Ethernet4/3/1
  CKN: abcd
    Message ID: c79ad8882c2dd3a8e838a691
    Elected self: False
    Success: True
    Principal: True
    Default: False
    KeyServer SCI: 28:99:3a:82:6f:82::605
    SAK transmit: True
    LLPN exhaustion: 0
    Distributed key identifier: 9d5bc0d3076ea4a08b99b9d9:1
    Live peer list: ['9d5bc0d3076ea4a08b99b9d9']
    Potential peer list: []

  CKN: dead
    Message ID: 3dfd4486b5f68a81014a37ec
    Elected self: False
    Success: True
    Principal: False
    Default: True
```

```
KeyServer SCI: 28:99:3a:82:6f:82::605
SAK transmit: False
LLPN exhaustion: 0
Distributed key identifier: None
Live peer list: ['4ef4cf009161bd551b5e7434']
Potential peer list:
```

About the Output

- **Connectivity Association Key Name (CKN):** Configured name of the key in use.
- **Message ID:** A random 92 bit string used as an identifier for an MKA participant.
- **Elected Self:** True if this participant is the elected key server.
- **Success:** True if this participant is live and has at least one live peer.
- **Principal:** True if this participant is the principal participant elected to distribute SAKs.
- **Default:** True if this participant is a fallback/backup participant (spawned when a fallback key is configured in a Mac Security profile).
- **Key Server SCI:** The SCI of the key server.
- **SAK Transmit:** True if the participant is ready to use the negotiated key for transmit.
- **LLPN Exhaustion:** Increments if the number of data packets sent using the current key exceeds a certain threshold. Because we use a 64 bit packet number cipher suite, this should never increment.
- **Distributed Key Identifier:** Message ID + key number of the most recently generated SAK.

8.3.2.8.20 show mac security participants

The **show mac security participants interface** command displays information about the MACsec participants.

Command Mode

EXEC

Command Syntax

```
show mac security interface
```

Example

The following example displays information about MACsec participants.

```
switch#show mac security participants
Interface: Ethernet4/1/1
  CKN: abcd
    Message ID: 9d5bc0d3076ea4a08b99b9d9
    Elected self: True
    Success: True
    Principal: True
    Default: False

  CKN: dead
    Message ID: 4ef4cf009161bd551b5e7434
    Elected self: True
    Success: True
    Principal: False
    Default: True

Interface: Ethernet4/3/1
  CKN: abcd
    Message ID: c79ad8882c2dd3a8e838a691
    Elected self: False
    Success: True
    Principal: True
    Default: False

  CKN: dead
    Message ID: 3dfd4486b5f68a81014a37ec
    Elected self: False
    Success: True
    Principal: False
    Default: True
```

8.3.2.8.21 show mac security status

The `show mac security status` command displays the MACsec status information on a switch.

Command Mode

EXEC

Command Syntax

```
show mac security status
```

Example

The following command displays the MACsec status information.

```
switch#show mac security status
Active Profiles:          1
Data Delay Protection:   No
FIPS Mode:               No
Secured Interfaces:      2
License:                 Enabled
```

8.3.2.8.22 supplicant profile

The **supplicant profile** command configures the supplicant profile containing all the credentials necessary for 802.1X authentication to succeed.

Command Mode

dot1x Configuration

Command Syntax

```
supplicant profile <profile_name> <options>
```

Parameters

- *profile_name* Name of the supplicant profile.
- The following parameters can be included after entering the profile mode.
 - *eap-method* Extensible Authentication Protocol (EAP) method. Option include.
 - *fastEAP* Flexible Authentication via Secure Tunneling (FAST)
 - *identity* Extensible Authentication Protocol (EAP) user identity. Option include.
 - *WORD* User identity name.
 - *passphrase* Extensible Authentication Protocol (EAP) password. Options include.
 - *0* Specifies that an UNENCRYPTED key will follow.
 - *7* Specifies that an HIDDEN key will follow.
 - *LINE* The UNENCRYPTED (clear-text) shared key.

Examples

- The following commands place the switch in the supplicant profile mode.

```
Switch(config)#dot1x
Switch(config-dot1x)#supplicant profile test
Switch(config-dot1x-supp-profile-test)#
```

- The following commands configures the EAP FAST method for the supplicant profile called test profile for MAC security on the switch.

```
Switch(config)#dot1x
Switch(config-dot1x)#supplicant profile test
Switch(config-dot1x-supp-profile-test)#eap-method fast
```

- The following commands configures the Identity for the supplicant profile called test profile for MAC security on the switch.

```
Switch(config)#dot1x
Switch(config-dot1x)#supplicant profile test
Switch(config-dot1x-supp-profile-test)#identity New_User
```

- The following commands configures the passphrase for the supplicant profile called test profile for MAC security on the switch.

```
Switch(config)#dot1x
Switch(config-dot1x)#supplicant profile test
Switch(config-dot1x-supp-profile-test)#passphrase 7 070E334D5D1D0B04
```

8.3.2.8.23 traffic unprotected allow

The **traffic unprotected allow** command configures the switch to allow the unprotected traffic whenever there is no successful MKA session established with the peer.

The **no traffic unprotected allow** command disable the MACsec Fallback to Unprotected Traffic function by removing the traffic unprotected allow command from **running-config**.

Command Mode

MACsec Profile

Command Syntax

```
traffic unprotected allow
no traffic unprotected allow
```

Example

The following commands configures the MACsec Fallback traffic unprotected allow feature on a switch for a MACsec profile called sample.

```
Switch(config)#mac security
Switch(config-mac-security)#profile sample
Switch(config-mac-security-profile-sample)#no traffic unprotected allow
```

8.3.3 Internet Protocol Security (IPsec)

This section describes Aristas IPsec implementation. Topics in this section include:

- [IPsec Introduction](#)
- [IPsec Overview](#)
- [Configuring IPsec](#)
- [IPsec Commands](#)

8.3.3.1 IPsec Introduction

Internet Protocol Security (IPsec) is a protocol suite for securing Internet Protocol (IP) communications by authenticating and encrypting each IP packet of a communication session. IPsec includes protocols for establishing mutual authentication between agents periodically during the session and negotiation of cryptographic keys to be used during the session. IPsec supports network-level peer authentication, data origin authentication, data integrity, data confidentiality (encryption), and replay protection.

IPsec is used to protect data traffic between sites for example between Branch, HQ and Data center sites in an enterprise.

IPsec uses the following protocols to perform various functions:

- Authentication Headers (AH): provides the connectionless integrity and data origin authentication for IP datagrams and provides protection against replay attacks.
- Encapsulating Security Payloads (ESP): provides the confidentiality, data-origin authentication, connectionless integrity and an anti-replay service (a form of partial sequence integrity).
- Internet Key Exchange (IKE): is a key management protocol which provides security for virtual private networks' (VPNs) negotiations and network access to random hosts. It is also described as a method for exchanging keys for encryption and authentication over an unsecured medium, such as the Internet.

8.3.3.2 IPsec Overview

8.3.3.2.1 Security Associations

Security Associations (SA) provide the bundle of algorithms and data that provide the parameters necessary for AH and/or ESP operations. The Internet Security Association and Key Management Protocol (ISAKMP) provides a framework for authentication and key exchange, with actual authenticated keying material provided either by manual configuration with pre-shared keys, Internet Key Exchange (IKE and IKEv2) and other mechanisms. In order to decide what protection is to be provided for an outgoing packet, IPsec uses the Security Parameter Index (SPI), an index to the security association database (SADB), along with the destination address in a packet header, which together uniquely identify a security association for that packet. A similar procedure is performed for an incoming packet, where IPsec gathers decryption and verification keys from the security association database.

Full bidirectional communication requires at least two SAs, one for each direction. SA is defined by the following parameters

- Security Algorithms (AH) or Encapsulating Security Payloads (ESP) and keys
- Mode: Tunnel or Transport
- Key Management Method: Manual or IKE
- Lifetime: Expressed in hours.

8.3.3.2.2 Mode of Operation

IPsec on Arista switches operates in tunnel mode. In tunnel mode, the entire IP packet is encrypted and/or authenticated. It is then encapsulated into a new IP packet with a new IP header.

Tunnel mode is used to create virtual private networks for network-to-network communications (for example, between routers to link sites). Tunnel mode is used for most network-to-network IPsec.

8.3.3.2.3 Key Management

Key management on Arista switches uses the Internet Key Exchange (IKE) method. Internet Key Exchange (IKE) supports automated generation and renegotiation of SAs (includes keys) between the devices at a configured interval so it is much more scalable and secure.

IPsec needs SAs to define the algorithms and keys to use for protecting traffic. IKE establishes the SA so IPsec can protect traffic.

There are two IKE versions, IKEv1 and IKEv2. IKEv2 builds on IKEv1 but both are still widely used today.

8.3.3.2.3.1 IKEv1

IKEv1 has two phases.

- IKEv1 Phase 1
- IKEv1 Phase 2

IKEv1 Phase 1

- Uses main or aggressive mode exchange
- Negotiates IKE SA
- Used for control plane
- Peer authentication

IKEv1 Phase 2

- Uses quick mode exchange

-
- Negotiates IPsec SAs

Note that there are two different SAs that are established. The IKE SA protects only the IKE key management session using the IKE policy defined. The policy should include the following parameters:

- Encryption algorithm
- Hash MAC (HMAC) algorithm
- Peer authentication procedure
- Diffie-Hellman group for initial key exchange
- SA lifetime

IKE initially performs a Diffie-Hellman (DH) exchange at the start of the IKE session. A Diffie-Hellman (DH) exchange allows participants to produce a shared secret value. The strength of the technique is that it allows participants to create the secret value over an unsecured medium without passing the secret value through the wire. From that exchange, peers get shared keying material, which is then used for IKE encryption and integrity functions. The strength of that keying material can be used for faster performance, by choosing lower key sizes for Diffie-Hellman exchanges. The key length (strength) of Diffie-Hellman exchanges can be changed with the use of different DH groups.

When an IKE session's lifetime expires, a new Diffie-Hellman exchange is performed between peers and the IKE SA is re-established.

The IPsec protection policy resulting in IPsec SAs, defines the protection of network traffic. These IPsec SAs are usually negotiated over IKE sessions. The parameters that define the IPsec protection policy are:

- Encryption Algorithm
- Hash MAC (HMAC) Algorithm

Note that the key material for IPsec SA (also called Child SA) is derived from keying material from IKEv1 phase 1.

There are two different modes for phase 1:

- Main Mode
- 6 packet exchange
- Full identity protection and better anti-DoS protection
- Aggressive Mode
- 3 packet faster session establishment
- Identities are exchanged in clear
- Weak DoS protection

Authentication

- Pre-Shared Keys (PSK)- As the name suggests, a shared secret is distributed out-of-band to the peers. The peers use this information and nonce parameters to create a hash that is used to authenticate messages.
- PKI Certificates- Here, certificates of the peers are exchanged and hashes are calculated over these certificates to authenticate each other.

8.3.3.2.3.2 IKEv2

IKEv2 differs from IKEv1 in the following ways:

- Faster setup because of reduced number of messages
- More secure
- ESP is reused for all IKEv2 messages
- Suite-B support
- There is no aggressive mode, so IKEv2 always provides identity protection

- Additional authentication methods
- Local and remote can use different authentication methods and use different pre-shared keys
- Authentication is done unidirectionally in IKEv2

8.3.3.2.4 Certificate Management

There are many protocols and standards available now that ease the process of certificate enrollment, certificate request, and certificate status checking. Some popular ones are RSA Labs' PKCS #7, PKCS #10, Cisco's Simple Certificate Enrollment Protocol (SCEP), and Online Certificate Status Protocol (OCSP).

8.3.3.2.4.1 Certificate Enrollment

There are two methods for certificate enrollment:

- **SCEP** Simple Certificate Enrollment Protocol. In this mode, EOS will automatically enroll the certificate with the CA.
- **Manual** This is used if the CA does not support SCEP or there is no network access from the device to the CA. The steps are as follows:
 1. Generate a Certificate Signing Request (CSR) and display on the terminal. CSR is represented as a Base64 encoded PKCS#10. The admin has to cut and paste the request into the CA to generate the certificate. The admin will have to specify the router FQDN and IP address.
 - a. Import the certificate into EOS.

8.3.3.2.4.2 Certificate Validation

To verify the validity of certificates, Arista switches use two mechanisms:

- **CRL** Certificate Revocation List (CRL) is a list of certificates (or more specifically, a list of serial numbers for certificates) that have been revoked. Entities presenting those (revoked) certificates should no longer be trusted. CRLs can be obtained through Simple Certificate Enrollment Protocol (SCEP).
- **OCSP** The Online Certificate Status Protocol (OCSP) is an Internet protocol used for obtaining the revocation status of an X.509 digital certificate. Since it is an online protocol it is accessed in real time and avoids the caching-related security problems CRLs pose. OCSP also reduces the load on all devices since they don't have to be updated on the entire CRL. However, the devices need to have access to the OCSP server.

8.3.3.2.5 Route-based VPN

A route-based VPN employs routed tunnel interfaces as the endpoints of the virtual network. All traffic passing through a tunnel interface is placed into the VPN. Rather than relying on an explicit policy to dictate which traffic enters the VPN, static and/or dynamic IP routes are formed to direct the desired traffic through the VPN tunnel interface.

Since route-based VPNs support dynamic routing information through VPN tunnels. EOS supports only route based VPN for dynamic routing support and for easier configuration and management.

In route-based VPN, features like NAT, ACL, QoS is applied to packets before they are encrypted by applying these features to tunnel interface and can be applied to encrypted packets to applying these features on the physical interface carrying the tunnel traffic.

Virtual Template Interface (VTI)

A new tunnel interface type vti is introduced to represent the VPN tunnel. This tunnel interface will participate in the routing and any packets forwarded to it will be encrypted and forwarded to the other end of the tunnel. Note, that this does not add a new header to the packet.

8.3.3.3 Configuring IPsec

Complete the following steps to configure IPsec tunnels over the switch.

This configuration will use the default IKE version 2 procedure.

1. Use `ip security` command to enter IP security mode.

```
switch(config)#ip security
```

2. To use IKE version 1, complete the following before completing the default IKE version the steps below.

```
switch(config)#ip security
switch(config-ipsec)#ike policy ike-peerRtr
switch(config-ipsec-ike)#version 1
```

3. Create an IKE Policy to be used to communicate with the peer to establish IKE. You have the option of configuring multiple IKE policies.

The default IKE Policy values are:

- Encryption- AES256 / AES128
- Integrity - SHA256 / SHA128
- DH group - Group 14
- IKE lifetime - 8 hours

```
switch(config-ipsec)#ike policy ike-router
switch(config-ipsec-ike)#encryption aes256
switch(config-ipsec-ike)#integrity sha256
switch(config-ipsec-ike)#dh-group 24
switch(config-ipsec-ike)#version 2
```

4. If the router is behind a NAT, configure the local-id with the local public IP address. The public IP corresponds to the underlying interface over which the IKE communications are done with the peer.

```
switch(config-ipsec-ike)#local-id <public ip address>
```

5. Create an IPsec Security Association policy to be used in the data path for encryption and integrity. Use the option of enabling Perfect Forward Secrecy by configuring a DH group to the SA. In this example, AES256 is used for encryption, SHA 256 is used for integrity, and Perfect Forward Secrecy is enabled (the DH group is 14).

```
switch(config-ipsec)#sa policy sa-vrouter
switch(config-ipsec-sa)#esp encryption aes256
switch(config-ipsec-sa)#esp integrity sha256
switch(config-ipsec-sa)#pfs dh-group 14
switch(config-ipsec-sa)#sa lifetime 2
switch(config-ipsec-sa)#exit
```

6. Bind or associate the IKE and SA policies together using an IPsec profile. Provide a shared-key, which must be common on both peers. The default profile assigns default values for all parameters that are not explicitly configured in the other profiles. In this example, the IKE Policy ike-peerRtr and SA Policy sa-peerRtr are applied to profile peer-Rtr. Dead Peer Detection is enabled and configured to delete the connection when the peer is down for more than 50 seconds. The peer peer-Rtr is set to be the responder.

```
switch(config-ipsec)#profile default
switch(config-ipsec-profile)#ike-policy ikedefault
switch(config-ipsec-profile)#sa-policy sadefault
switch(config-ipsec-profile)#shared-key arista
switch(config-ipsec-profile)#connection start
```

```
switch(config-ipsec)#profile vrouter
switch(config-ipsec-profile)#ike-policy ike-vrouter
switch(config-ipsec-profile)#sa-policy sa-vrouter
switch(config-ipsec-profile)#dpd 10 50 clear
switch(config-ipsec-profile)#connection add
```

7. Configure the WAN interface to be the underlying interface for the tunnel. You must specify an L3 address for the tunnel. If you do not, the switch cannot route packets using the tunnel.

```
switch(config)#interface Et1
switch(config-if-Et1)#no switchport
switch(config-if-Et1)#ip address 1.0.0.1/24
switch(config-if-Et1)#mtu 1500
```

8. Apply the IPsec profile to a new tunnel interface. You create the new tunnel interface as part of this step. You can configure the tunnel as a VTI IPsec tunnel. In this example, the new tunnel interface is Tunnel0. The new tunnel interface is configured to use IPsec. The other end of the tunnel also needs to be configured as a GRE-over-IPsec tunnel.

```
switch(config)#interface tunnel0
switch(config-if-Tu0)#ip address 1.0.3.1/24
switch(config-if-Tu0)#mtu 1394
switch(config-if-Tu0)#tunnel source 1.0.0.1
switch(config-if-Tu0)#tunnel destination 1.0.0.2
switch(config-if-Tu0)#tunnel ipsec profile vrouter
```

Example Configuration

```
ip security
ike policy ikebranch1
integrity sha256
dh-group 15
!
sa policy sabranch1
sa lifetime 2
pfs dh-group 14
!
profile hq
mode tunnel
ike-policy ikebranch1
sa-policy sabranch1
connection add
shared-key keyAristaHq
dpd 10 50 clear
!
interface Tunnel1
mtu 1404
ip address 1.0.3.1/24
tunnel source 1.0.0.1
tunnel destination 1.0.0.2
tunnel ipsec profile hq
!
interface Ethernet1
no switchport
ip address 1.0.0.1/24
!
```

8.3.3.3.1 Displaying IPsec Information

- Use the `show ip security policy` command to display the IPsec policy information.

```
switch#show ip security policy
Policy Name      Authentication  Encryption    Integrity    Lifetime  Rekey  DH Group
ike-policy       Pre-shared     256-bit AES   256bit Hash  8 hours   False  3072 bit
```

- Use the `show ip security profile` command to display the IP security profile information.

```
switch#show ip security profile
Profile name      IKE Policy Name      SA
ipsec-profile    ike-policy           sa-policy
```

8.3.3.4 IPsec Commands

- [ike policy](#)
- [interface tunnel \(IPsec\)](#)
- [ip security](#)
- [profile \(IPsec\)](#)
- [sa policy](#)
- [show ip security applied-profile](#)
- [show ip security connection](#)
- [show ip security policy](#)
- [show ip security profile](#)
- [show ip security security-association](#)

8.3.3.4.1 ike policy

The **ike policy** command configures the Internet Security Association and Key Mgmt Protocol on the switch and related policies. The IKE policy is configured in IP security configuration mode.

The **no ike policy** command deletes the IKE policy configuration from the switch.

The **exit** command returns the switch to the global configuration mode.

Command Mode

IP Security Configuration

Command Syntax

```
ike policy <policy-name>
no ike policy <policy-name>
```

Parameters

- *policy-name* Specifies the IKE policy name.

The following parameters are allowed to configure when the switch is placed in IKE policy configuration mode:

- authentication specifies the authentication type.
- dh-group specifies Diffie-Hellman Group value.
- encryption specifies the encryption type.
- ike-lifetime sets the ikeLifetime for ISAKMP security association. Expressed in hours.
- integrity specifies the Integrity algorithm.
- local-id specifies the local IKE identification.
- remote-id remote peer IKE identification.
- version specifies the IKE version.

Example

This command configures the IKE policy test for IP security configuration.

```
switch(config)#ike policy test
switch(config-ipsec-ike)#
```

8.3.3.4.2 interface tunnel (IPsec)

The **interface tunnel** command places the switch in the interface tunnel configuration mode.

Interface tunnel configuration mode is not a group change mode; **running-config** is changed immediately after commands are executed.

The **no interface tunnel** command deletes the interface tunnel configuration.

The **exit** command returns the switch to the global configuration mode.

Command Mode

Global Configuration

Command Syntax

```
interface tunnel <value>
```

```
no interface tunnel <value>
```

Parameter

value Tunnel interface number. The value ranges from 0 to 255.

Example

This command places the switch in interface tunnel configuration mode with a tunnel value *10*.

```
switch(config)#interface tunnel 10  
switch(config-if-Tu10)#
```

8.3.3.4.3 ip security

The **ip security** command places the switch in the IP security configuration mode.

IP security configuration mode is not a group change mode; **running-config** is changed immediately after commands are executed.

The **no ip security** command deletes the IP security configuration.

The **exit** command returns the switch to the global configuration mode.

Command Mode

Global Configuration

Command Syntax

```
ip security
```

```
no ip security
```

Example

This command places the switch in IP security configuration mode.

```
switch(config)#ip security
switch(config-ipsec)#ike policy IKE1
switch(config-ipsec-IKE1)#exit
switch(config-ipsec)#sa policy SA1
switch(config-SA1)#
```

8.3.3.4.4 profile (IPsec)

The **profile** command configures the IP security profile on the switch. The profile is configured in IP security configuration mode.

The **no profile** command deletes the IP security profile configuration from the switch.

The **exit** command returns the switch to the global configuration mode.

Command Mode

IP Security Configuration

Command Syntax

```
profile <profile-name>
```

```
no profile <profile-name>
```

Parameter

- *profile-name* Specifies the IP security profile name.

The following parameters can be configured in SA policy configuration mode:

- connection IPsec Connection (Initiator/Responder/Dynamic).
- dpd Dead Peer Detection.
- flow sets the flow.
- ike-policy ISAKMP policy.
- mode IP security mode type.
- sa-policy security association name.
- shared-key specifies key value.

Example

This command configures the IP security profile test for IP security configuration.

```
switch(config)#profile test  
switch(config-ipsec-profile)#
```

8.3.3.4.5 sa policy

The **sa policy** command specifies a Security Association (SA) policy to be used for IPsec configuration, and enters IP security SA policy configuration mode to configure the named policy.

The **no sa policy** command deletes the specified SA policy configuration from the switch.

The **exit** command returns the switch to the global configuration mode.

 **Note:** Arista EOS 4.22.0F release supports two combinations of encapsulations only: "esp encryption aes128" with "esp integrity sha1" and "esp encryption aes256" with "esp integrity sha256".

Command Mode

IP Security Configuration

Command Syntax

```
sa policy <policy_name>
```

```
no sa policy <policy_name>
```

Parameter

- *policy_name* Specifies the SA policy name.

The following parameters are configured in IP security SA policy configuration mode:

- anti-replay IPsec duplicate IP datagram detection
- esp Encapsulation Security Payload
- pfs Perfect Forward Secrecy
- sa Security Association

Example

This command applies the SA policy called test for IP security and enters IP security SA policy configuration mode for the test policy.

```
switch(config)#sa policy test
switch(config-ipsec-sa)#
```

8.3.3.4.6 show ip security applied-profile

The **show ip security applied-profile** command displays the IP security profile names and the interfaces on which they are applied.

Command Mode

EXEC

Command Syntax

```
show ip security applied-profile
```

Example

This command displays the IP security profile-1 and the interfaces on which it is applied.

```
switch#show ip sec applied-profile
Profile Name      Interface
ipsec-profile-1  Tunnel1,
                 Tunnel2,
                 Tunnel3,
                 Tunnel4,
                 Tunnel5,
                 Tunnel6,
                 Tunnel7,
                 Tunnel8,
                 Tunnel9,
                 Tunnel10,
                 Tunnel11,
                 Tunnel12,
                 Tunnel13,
                 Tunnel14,
                 Tunnel15,
                 Tunnel16,
                 Tunnel17,
                 Tunnel18,
                 Tunnel19,
                 Tunnel20,
                 Tunnel21,
                 Tunnel22,
                 Tunnel23,
                 Tunnel24,
                 Tunnel25,
                 Tunnel26,
```

8.3.3.4.7 show ip security connection

The **show ip security connection** command displays the IP security connection status information.

Command Mode

EXEC

Command Syntax

```
show ip security connection
```

Example

These commands display the IP security connection status information.

```
switch#show ip sec conn tunnel 1
Tunnel Source Dest Status Uptime Input Output Rekey Time
Tunnell 11.1.1.1 11.2.1.1 Established 19 hours 0 bytes 0 bytes 4 hours
0 pkts 62937679 pkts

switch#show ip sec conn tunnel 1 detail
Tunnell:
source address 11.1.1.1, dest address 11.2.1.1
state: Established
uptime: 19 hours, 7 minutes, 23 seconds
Inbound SPI 0xca5560f4:
request id 193, mode tunnel replay-window 16384, seq 0x0
stats errors:
replay-window 0, replay 0, integrity_failed 0
lifetime config:
softlimit 4534352933249 bytes, hardlimit 6442450944000 bytes
softlimit 2077499095 pkts, hardlimit 4000000000 pkts
expire add soft 85619 secs, hard 86400 secs
lifetime current:
0 bytes, 0 pkts
add time Mon May 13 17:33:54 2019, use time Mon May 13 17:33:54 2019
Outbound SPI 0xc60da749:
request id 193, mode tunnel replay-window 16384, seq 0x0
stats errors:
replay-window 0, replay 0, integrity_failed 0
lifetime config:
softlimit 3286021368749 bytes, hardlimit 6442450944000 bytes
softlimit 2480571031 pkts, hardlimit 4000000000 pkts
expire add soft 85418 secs, hard 86400 secs
lifetime current:
0 bytes, 62937679 pkts
add time Mon May 13 17:33:54 2019, use time Mon May 13 18:06:42 2019
```

8.3.3.4.8 show ip security policy

The **show ip security policy** command displays the IP security policy information.

Command Mode

EXEC

Command Syntax

```
show ip security policy
```

Example

This command displays IP security policy configuration information.

```
switch#show ip security policy
Policy Name      Authentication  Encryption    Integrity     Lifetime    Rekey  DH Group
ike-policy       Pre-shared     256-bit AES   256bit Hash   8 hours    False  3072 bit
```

8.3.3.4.9 show ip security profile

The `show ip security profile` command displays the IP security profile information.

Command Mode

EXEC

Command Syntax

```
show ip security profile
```

Example

This command displays IP security profile configuration information.

```
switch#show ip security profile
Profile name          IKE Policy Name      SA
ipsec-profile         ike-policy           sa-policy
```

8.3.3.4.10 show ip security security-association

The `show ip security security-association` command displays the IP security SA information.

Command Mode

EXEC

Command Syntax

```
show ip security security-association
```

Example

This command displays the IP security SA information.

```
switch#show ip sec security-association
SA Name          ESP Encryption   ESP Integrity    Lifetime   PFS Group
sa-policy-1     256-bit AES      256bit Hash     24 hours   2k bit
```

8.3.4 Macro-Segmentation Service (CVX)

Arista MSS is designed as a service in CloudVision that provides the point of integration between individual vendor firewalls or a firewall manager and the Arista network fabric. MSS provides flexibility on where to place the service devices and workloads. It is specifically aimed at Physical-to-Physical (P-to-P) and Physical-to-Virtual (P-to-V) workloads.

Topics in this section include:

- [Overview](#)
- [How MSS Works](#)
- [Configuration](#)
- [MSS Integration with Check Point](#)
- [MSS for Layer 3 Firewall Enhancements](#)
- [MSS Commands](#)

8.3.4.1 Overview

The advent of contemporary networking features such as mobile applications and the Internet of Things (IoT) bring in additional security challenges that are unprotected by legacy infrastructure. These security breaches cannot be handled by installing a firewall at the Internet edge. Arista Macro-Segmentation Service (MSS) addresses the security breach issue, besides securing access, protecting critical data and end-user privacy.

Arista MSS is designed as a service in CloudVision that provides the point of integration between a vendor firewall or a firewall manager and the Arista network fabric. MSS provides flexibility on where to place the service devices and workloads. It is specifically aimed at Physical-to-Physical (P-to-P) and Physical-to-Virtual (P-to-V) workloads.

MSS components include:

- Arista leaf-spine switch fabric
- Arista CloudVision
- Vendor firewall attached to a spine or service leaf switches. Different vendor firewalls can be attached to different switches to enhance scalability.

The above component topology allows for consistency in application deployment, scale, manageability, and easier scalability of the network and service layers.

- [Benefits](#)

-
- [Terminology](#)
 - [Usage Scenarios](#)

8.3.4.1.1 Benefits

MSS provides the following key benefits:

- Enhanced security between any physical and virtual workloads in the data center.
- The automatic and seamless service insertion ability of MSS eliminates manual steering of traffic for a workload or a tenant.
- Security policies are applied to the host and application throughout the network.
- MSS is flexible since there are no proprietary frame formats, tagging, or encapsulation.

8.3.4.1.2 Terminology

The following terms related to MSS are used to describe the MSS feature:

- **Intercept Switch/VTEP:** TOR switch and VXLAN tunnel end-point connected to host from which traffic is intercepted. In the topology diagram, Intercept-1 and Intercept-2 are intercept switches.
- **Service Switch/VTEP:** TOR switch and VXLAN tunnel end-point connected to a firewall. In the topology diagram, Service-1 is the service switch.
- **VXLAN:** Virtual eXtensible LAN - a standards-based method of encapsulating Layer 2 traffic across a Layer 3 fabric.
- **CVX:** Arista CloudVision eXchange (CVX) is a part of CloudVision and is a virtualized instance of the same Extensible Operating System (EOS) that runs on physical switches. It functions as a point of integration between customer firewalls or firewall policy managers and the Arista network in order to steer traffic to the firewall.

8.3.4.1.3 Usage Scenarios

The following usage scenarios describe a few major security challenges in today's data center that are successfully handled by MSS.

1. Securing server-to-server traffic.

This scenario provides information about the role of MSS in securing network traffic between physical-to-physical (P-to-P) and physical to virtual (P-to-V) servers. Prior to MSS, network

infrastructure devices followed the firewall sandwich setup where firewalls were placed in line between the security zones. This setup would impact scalability and performance of the servers.

Using MSS, this restriction on firewall placement is reduced. Firewalls are now attached to a service leaf switch in the network fabric and they still protect hosts without concern about their physical location. The following topology demonstrates the usage scenario.

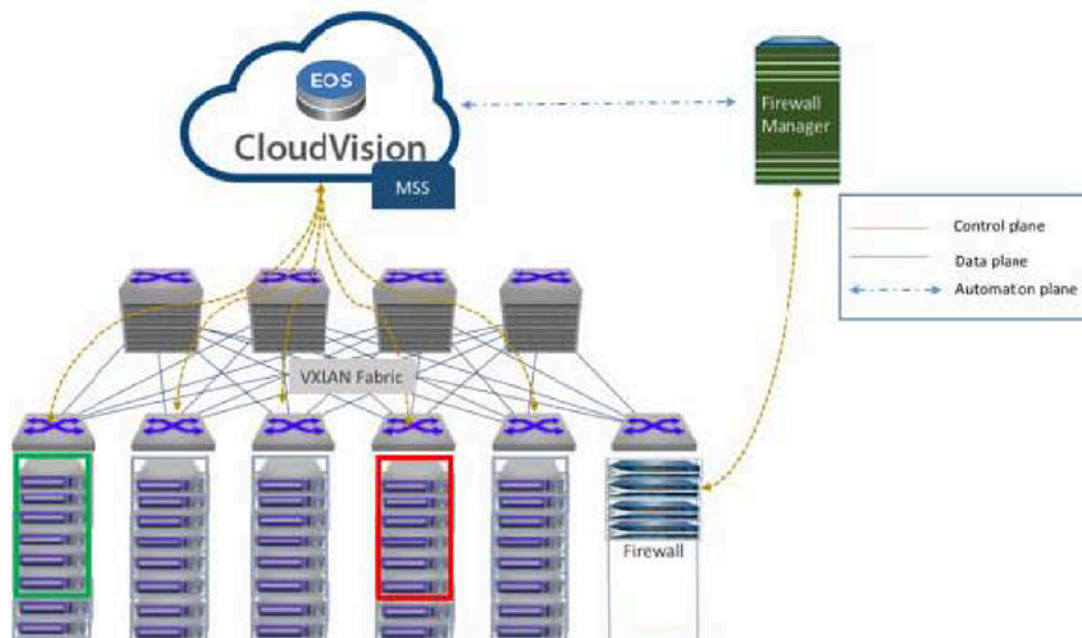

Figure 11: Securing server-server traffic

2. Monitoring and securing management traffic.

This usage scenario demonstrates how MSS successfully monitors and secures management interfaces in the data center.

The modern data center caters to managing the application, storage, virtualization, network, analytics and other layers. With virtualization, the hypervisor management also needs to be secured to prevent unwanted access to a hypervisor management interface. In the event of a rogue access, Aristas MSS protects management interfaces. The explicitly allowed hosts can gain access through

a jump host or administrator end-user computing instances. The following topology diagram illustrates the role of MSS in a data center.

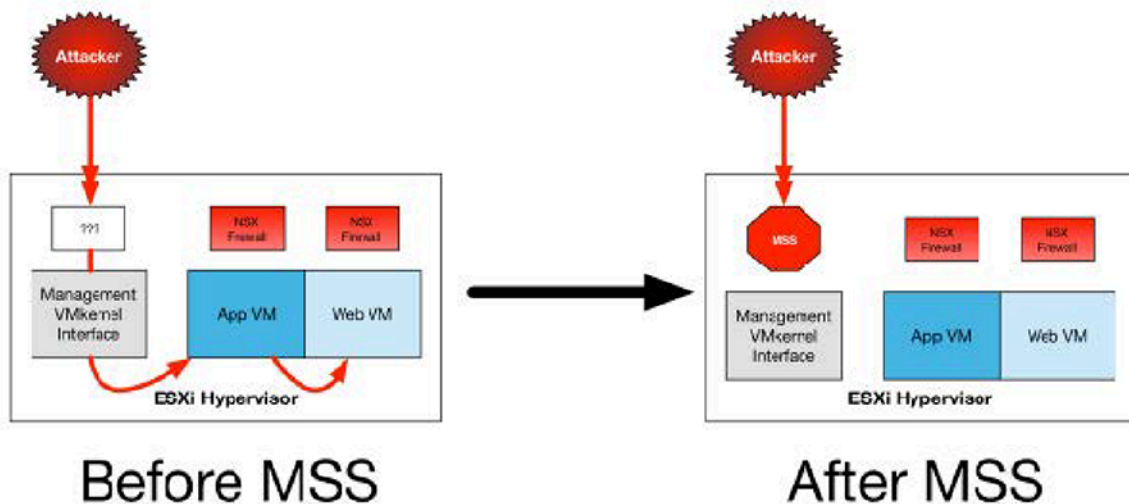

Figure 12: Monitoring and Securing management traffic

8.3.4.2 How MSS Works

The following steps provide information about how MSS works as a service in the data center.

1. MSS is enabled on the CloudVision eXchange (CVX) and the Arista switches are configured to stream their active state to CVX. This allows CVX to build a database of hosts and firewalls attached to the network and also to identify physical ports and IP addresses. CVX is also configured to communicate and synchronize policies from a vendor's firewall.
2. CVX sends a request to the firewall or firewall manager to provide information about the security policies which are tagged for MSS usage.
3. The MSS service on CVX determines the flow based forwarding rules to be pushed to the switches in the network.

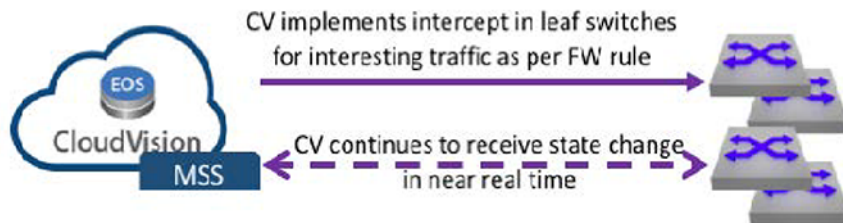

Figure 13: CVX intercept

4. The leaf switch starts sending intercepted traffic to the service leaf when the intercept has been applied to the leaf switch.

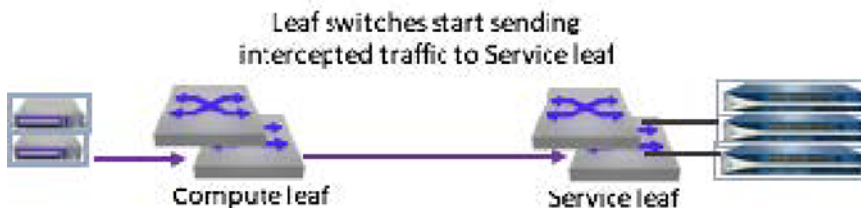

Figure 14: Leaf switches intercept

5. Traffic is forwarded completely unmodified to the firewall after it enters the service leaf where the firewall is attached. Based on the configuration policy, the firewall applies the required actions such as inspection, log, allow, or deny.
6. The service leaf switch sends the inspected traffic to its final destination or to the destination based on the firewall policy.

8.3.4.3 Configuration

The following sections provide detailed information about MSS configuration, system requirements, recommendations, and limitations.

The traffic flow below is an example of a typical MSS deployment with a 3-tiered application. The goal of this design is to limit access between hosts in the following zones: web-untrust, app-untrust, db-untrust, web-trust, app-trust, and db-trust.

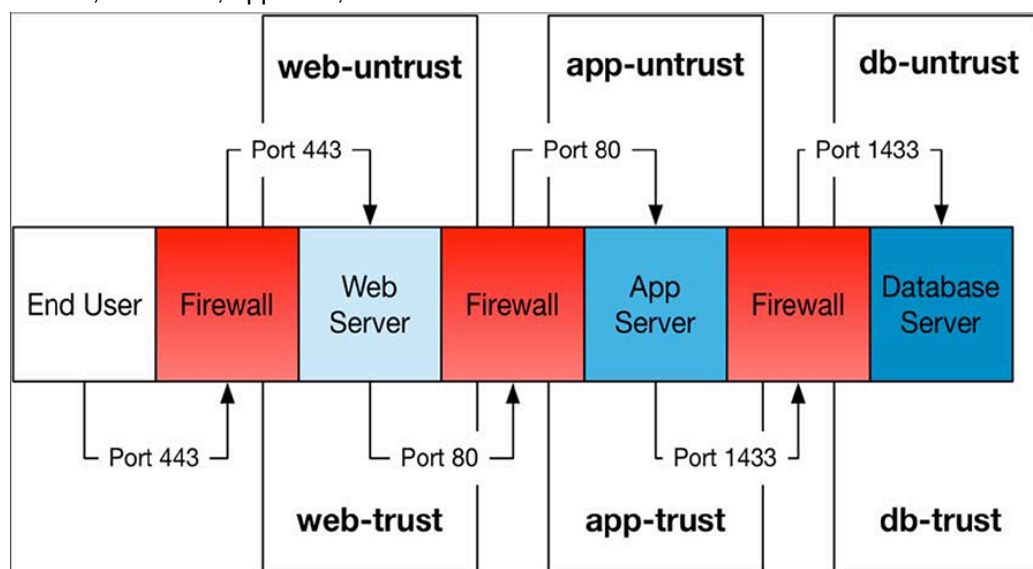

Figure 15: Traffic flow in an MSS deployment

End users in the untrust zone access the web server through the TCP/443 port. Traffic flows through the active firewall to the web server interface in the web-untrust security zone. The web server interface in the web-trust security zone accesses the application server interface in the app-untrust security zone through port TCP/80 after traversing the firewall. From there, the application server interface in the app-trust security zone accesses the database through TCP/1433 in the db-untrust zone.

The following physical topology indicates the MSS setup.

The hosts are attached to a pair of intercept leaf switches. A firewall is connected to a service leaf switch using a pair of physical interfaces with a subinterface per zone or vWire.

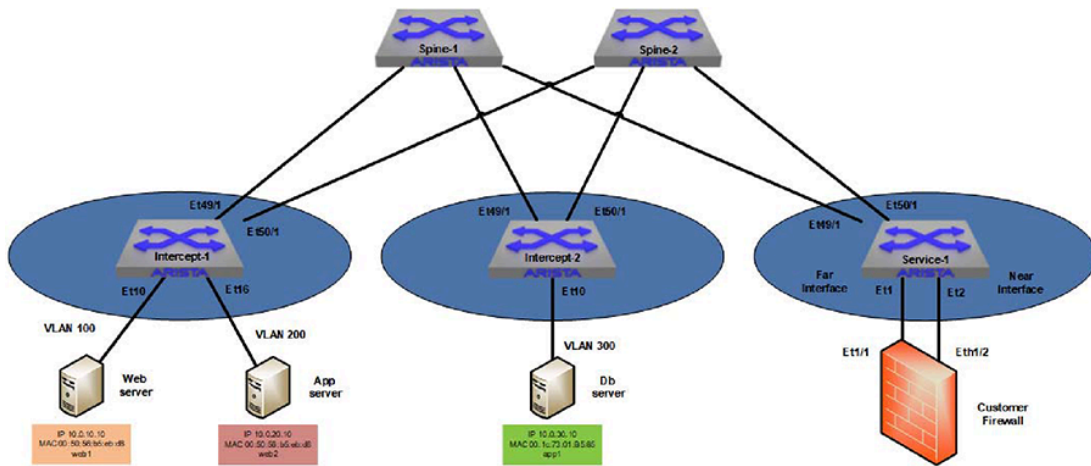

Figure 16: Physical topology of the MSS

- [System Requirements](#)
- [Recommendations and Limitations](#)
- [Configuring MSS](#)

8.3.4.3.1 System Requirements

The system requirements to effectively run MSS are listed below.

- Arista CloudVision eXchange (CVX)
- Arista 7280SR, 7280TR, 7280CR, 7020SR, 7020TR series switches; 7050X, 7050X2, 7060X, and 7060X2 series top of rack (TOR) switches
- Connected to the hosts to intercept traffic from the firewall devices
- The network must be a VXLAN-enabled fabric with CVX running the VXLAN Control Service (VCS) or EVPN

8.3.4.3.2 Recommendations and Limitations

Firewall

- The firewall policy name must not have any whitespace character in the name. As an example, *PCI policy* is an unacceptable policy name. An acceptable name would be *PCI_policy*.

8.3.4.3.3 Configuring MSS

These sections describe steps to configure MSS.

- [Deploying CVX](#)
- [Enabling the VXLAN Control Service on CVX](#)
- [Configuring the Access switches and the Service switch ports](#)
- [Enabling DirectFlow on access switches and service switches](#)
- [Enabling VXLAN routing on the TOR switches](#)
- [Configuring MSS on CVX](#)
- [Configuring the Firewall](#)

8.3.4.3.3.1 Deploying CVX

Deploy CloudVision and configure the Arista TOR switches to connect to it. A CVX cluster of 3 instances with host names of cvx01, cvx02, and cvx03 are configured as an example.

 **Note:** As a best practice, always deploy the CV in a HA cluster with a minimum of three instances.

8.3.4.3.3.2 Enabling the VXLAN Control Service on CVX

Enable the VXLAN Control Service (VCS) on every CVX instance after the three Arista CVX instances have been deployed and the TOR switches are configured to be managed by them.

VCS allows hardware VXLAN Tunnel End Points (VTEPs) to share state with each other in order to establish VXLAN tunnels without the need for a multicast control plane.

Example

CVX instance cvx01

```
cvx01 (config-cvx) #service vxlan
cvx01 (config-cvx-vxlan) #no shutdown
```

Similarly, VCS is enabled on the cvx02 and cvx03 devices.

8.3.4.3.3.3 Configuring the Access switches and the Service switch ports

Configure the switch ports that are connected to the hosts, whose traffic should be steered to the firewalls and the service switch ports which are connected to the firewalls.

Access switch configuration

The switch ports connected to the hosts, whose traffic needs to be intercepted, need to be configured as 802.1q trunks with the VLAN that is mapped to the VNI requiring interception. Unique VLAN IDs are configured for each tier of the application.

Access switch (intercept-1)

```
intercept-1# configure
intercept-1 (config)# interface et10
intercept-1 (config-if-Et10)# description web server
intercept-1 (config-if-Et10)# switchport mode trunk
intercept-1 (config-if-Et10)# switchport trunk allowed vlan 100

intercept-1 (config)# interface et16
intercept-1 (config-if-Et16)# description app server
intercept-1 (config-if-Et16)# switchport mode trunk
intercept-1 (config-if-Et16)# switchport trunk allowed vlan 200
```

Access switch (intercept-2)

```
intercept-2# configure
intercept-2 (config)# interface et10
intercept-2 (config-if-Et1)# description db server
intercept-2 (config-if-Et1)# switchport mode trunk
intercept-2 (config-if-Et1)# switchport trunk allowed vlan 300
```

 **Note:** For untagged traffic, configure a native VLAN on the port using the **switchport trunk native vlan** command.

Service switch (service-1)

```
service-1# configure
service-1 (config)# interface port-channel 10
service-1 (config-if-Po10)# description Far Interface
service-1 (config-if-Po10)# switchport mode trunk
service-1 (config-if-Po10)# switchport trunk allowed vlan none
```



```

service-1(config-if-Po10)# spanning-tree bpdufilter enable

service-1(config)#interface port-channel 20
service-1(config-if-Po20)# description Near Interface
service-1(config-if-Po20)# switchport mode trunk
service-1(config-if-Po20)# switchport trunk allowed vlan none
service-1(config-if-Po20)# spanning-tree bpdufilter enable

```

 **Note:** Dynamically mapped VLANs are not shown in the switch port configuration. You can view them by running the `show vlan` command on the switch once a policy is applied.

8.3.4.3.3.4 Enabling DirectFlow on access switches and service switches

Arista MSS uses DirectFlow to intercept traffic while the VxLAN is used to carry tunnel traffic from the intercepted host to the firewall and back. DirectFlow should be enabled on every intercept switch as well as the service switches.

Switch service-1

```

service-1# configure
service-1(config)# directflow
service-1(config-directflow)# no shutdown

```

Switch intercept-1

```

intercept-1# configure
intercept-1(config)# directflow
intercept-1(config-directflow)# no shutdown

```

Switch intercept-2

```

intercept-2# configure
intercept-2(config)# directflow
intercept-2(config-directflow)# no shutdown

```

8.3.4.3.3.5 Enabling VXLAN routing on the TOR switches

CVX uses Address Resolution Protocol (ARP) to determine where intercept hosts are physically located in the network. VXLAN routing should be configured on every TOR switch that will be intercepting traffic to ensure that CVX is aware of every host ARP entry.

The following configuration shows the routing configuration for each tier of the application, but not the entire VXLAN configuration. For more information on how to configure VXLAN and VXLAN routing, refer to the VXLAN section of the *Arista EOS Configuration Guide*.

Switch intercept-1

```

intercept-1# configure
intercept-1(config)# ip routing
intercept-1(config)# interface vlan100
intercept-1(config-if-Vl100)# ip address virtual 10.0.10.254/24
intercept-1(config)# interface vlan200
intercept-1(config-if-Vl200)# ip address virtual 10.0.20.254/24
intercept-1(config)# interface vlan300
intercept-1(config-if-Vl300)# ip address virtual 10.0.30.254/24

```

Switch intercept-2

```

intercept-2# configure
intercept-2(config)# ip routing

```



```

intercept-2(cofig)# interface vlan100
intercept-2(config-if-Vl100)# ip address virtual 10.0.10.254/24
intercept-2(config)# interface vlan200
intercept-2(config-if-Vl200)# ip address virtual 10.0.20.254/24
intercept-2(config)# interface vlan300
intercept-2(config-if-Vl300)# ip address virtual 10.0.30.254/24

```

Switch service-1

```

service-1# configure
service-1(config)# ip routing
service-1(cofig)# interface vlan100
service-1(config-if-Vl100)# ip address virtual 10.0.10.254/24
service-1(config)# interface vlan200
service-1(config-if-Vl200)# ip address virtual 10.0.20.254/24
service-1(config)# interface vlan300
service-1(config-if-Vl300)# ip address virtual 10.0.30.254/24

```

8.3.4.3.3.6 Configuring MSS on CVX

This step enables configuring Arista MSS on CVX. The topology diagram depicts three CVX instances in a cluster and the configuration is the same for every instance. The active and standby vendor firewalls are configured. If Panorama is used, only Panorama should be configured.

Example

In the example, the primary vendor firewall has a DNS name of *fw-ha-node-1*. The standby firewall has a DNS name of *fw-ha-node-2*. The username and password are set as *admin*.

CVX instance cvx01

```

cvx01# configure
cvx01(config)# cvx
cvx01(config-cvx)# no shutdown
cvx01(config-cvx)# service mss
cvx01(config-cvx-mss)# no shutdown
cvx01(config-cvx-mss)# vni range 20000-30000
cvx01(config-cvx-mss)# dynamic device-set panfw1
cvx01(config-cvx-mss-panfw1)# tag Arista_MSS
cvx01(config-cvx-mss-panfw1)# type palo-alto firewall
cvx01(config-cvx-mss-panfw1)# state active
cvx01(config-cvx-mss-panfw1)# device fw-ha-node-1
cvx01(config-cvx-mss-panfw1-fw-ha-node-1)# username admin password 0
admin

```

CVX instance cvx02

```

cvx02# configure
cvx02(config)# cvx
cvx02(config-cvx)# no shutdown
cvx02(config-cvx)# service mss
cvx02(config-cvx-mss)# no shutdown
cvx02(config-cvx-mss)# vni range 20000-30000
cvx02(config-cvx-mss)# dynamic device-set panfw1
cvx02(config-cvx-mss-panfw1)# tag Arista_MSS
cvx02(config-cvx-mss-panfw1)# type palo-alto firewall
cvx02(config-cvx-mss-panfw1)# state active
cvx02(config-cvx-mss-panfw1)# device fw-ha-node-1
cvx02(config-cvx-mss-panfw1-fw-ha-node-1)# username admin password 0
admin

```

CVX instance cvx03

```

cvx03# configure
cvx03(config)# cvx
cvx03(config-cvx)# no shutdown
cvx03(config-cvx)# service mss
cvx03(config-cvx-mss)# no shutdown
cvx03(config-cvx-mss)# vni range 20000-30000
cvx03(config-cvx-mss)# dynamic device-set panfwl
cvx03(config-cvx-mss-panfwl)# tag Arista_MSS
cvx03(config-cvx-mss-panfwl)# type palo-alto firewall
cvx03(config-cvx-mss-panfwl)# state active
cvx03(config-cvx-mss-panfwl)# device fw-ha-node-1
cvx03(config-cvx-mss-panfwl-fw-ha-node-1)# username admin password 0
admin

```

8.3.4.3.3.7 Configuring the Firewall

Three policies are created in addition to the default implicit deny policy for inter-zone traffic. The implicit deny ensures that the inter-zone traffic is not allowed unless a policy explicitly allows for it.

The first policy **untrust_to_web1** is from the **untrust** zone to the **web1** zone, that allows HTTPS traffic from anywhere to the web server web.

The third policy **web2_to_app1** is from the **web2** zone to the **app1** zone that allows HTTP traffic between the web server web and the application server app.

The fifth policy **app2_to_db1** is from the **app2** zone to the **db1** zone that allows database traffic on port **TCP/1433** between the application server app and the database server db.

The second, fourth, and sixth policies prevent the firewall to drop a session for which does not see the initial connection to the protected resource. This could happen if the protected resource has not sent any traffic previous to this point.

Refer to the following images for more clarity about the above policies and interface configuration.

Name	Tags	Type	Source		Destination		Rule Usage			Application	Service	Action
			Zone	Address	Zone	Address	Hit Count	Last Hit	First Hit			
1 vi 150 allow	offload	universal	any	150.0.1.0/30	phy int	160.0.5.1/32	0	-	-	any	UDP_dst_2000-1	Allow
2 test	offload	universal	any	170.0.1.0/30	any	any	0	-	-	any	application-default	Allow
3 vi 150 drop	offload	universal	any	150.0.1.0/30	any	any	0	-	-	any	udp_10000	Drop
4 vi 150 offload	offload	universal	any	150.0.1.0/29	any	any	0	-	-	any	UDP_dst_2000-1	Allow
5 vi 170-171	mss	universal	any	170.0.1.0/30	phy int	171.0.7.0/30	0	-	-	any	udp 17100	Allow
6 vi 150	mss	universal	any	150.0.1.0/27	any	any	0	-	-	any	application-default	Allow
7 intrazone-default	none	intrazone	any	any	(intrazone)	any	0	-	-	any	any	Allow
8 interzone-default	none	interzone	any	any	any	any	160	2019-03-11 13:38:35	2019-02-11 20:03:33	any	any	Allow

Figure 17: Firewall policy configuration

Interface	Interface Type	Management Profile	Link State	IP Address	Virtual Router	Tag	VLAN / Virtual-Wire	Security Zone	Features	Comment
ethernet1/1	Aggregate (ae1)			none	none	Untagged	none	none		Po 100 - near interface
ethernet1/2	Aggregate (ae1)			none	none	Untagged	none	none		po 100 - near interface
ethernet1/3	Aggregate (ae2)			none	none	Untagged	none	none		po 101 - far interface
ethernet1/4	Aggregate (ae2)			none	none	Untagged	none	none		po 101 - far interface
ethernet1/5	Layer2			none	none	Untagged	none	none		
ethernet1/6	Virtual Wire			none	none	Untagged	none	none		
ethernet1/7	Tap			none	none		none	none		
ethernet1/8	Layer2			none	none	Untagged	none	none		
ethernet1/9	Layer2			none	none	Untagged	none	none		
ethernet1/10	Aggregate (ae7)			none	none	Untagged	none	none		
ethernet1/11	Aggregate (ae8)			none	none	Untagged	none	none		
ethernet1/12	Aggregate (ae7)			none	none	Untagged	none	none		
ethernet1/13	Aggregate (ae8)			none	none	Untagged	none	none		
ethernet1/14	Tap			none	none		none	none		
ethernet1/15	Virtual Wire			none	none	Untagged	none	none		
ethernet1/16	Virtual Wire			none	none	Untagged	none	none		
ethernet1/17	Layer3	allow ping		none	none	Untagged	none	none		
ethernet1/17.1200	Layer3	allow ping		199.2.0.2/21 199.2::100:2/64	default	1200	none	vi 1200		
ethernet1/17.1201	Layer3	allow ping		199.2.8.2/21	default	1201	none	vi 1201		

Figure 18: Firewall interface configuration

Create a rule that Arista MSS will use to intercept and redirect traffic and add a firewall policy with the default Arista_MSS tag as shown in the example above. MSS intercepts all traffic from endpoints identified in policies that match the tag values configured in CVX. The firewall will apply all rules (tagged or untagged) to all traffic.



Note: LLDP should always be enabled on the firewall interfaces attached to the service switches. To minimize reconvergence time on the network changes, reduce the LLDP transmit interval and hold time multiples on the firewall, while keeping the LLDP hold time above the LLDP timer configured on the connected Arista switches.

Alternatively, the **device interface map** command can be used on CVX to manually map a device to Arista switch interfaces. To map multiple devices, add a mapping entry for each device.

```
dynamic device-set fw1
device dc-firewall-1
map device-interface ethernet1/1 switch 00:1c:73:7e:21:bb interface
  Ethernet1
map device-interface ethernet1/2 switch 00:1c:73:7e:21:bb interface
  Ethernet9
```

The first policy “untrust_to_web1” is from the untrust zone to the web1 zone, that allows HTTPS traffic from anywhere to the web server web.

The third policy “web2_to_app1” is from the web2 zone to the app1 zone that allows HTTP traffic between the web server web and the application server app.

The fifth policy “app2_to_db1” is from the app2 zone to the db1 zone that allows database traffic on port TCP/1433 between the application server app and the database server db.

The second, fourth, and sixth policies prevent the firewall to drop a session for which does not see the initial connection to the protected resource. This could happen if the protected resource has not sent any traffic previous to this point.

Refer to the following images for more clarity about the above policies and interface configuration.

Name	Tags	Type	Source		Destination		Rule Usage			Application	Service	Action
			Zone	Address	Zone	Address	Hit Count	Last Hit	First Hit			
1 vl 150 allow	offload	universal	phy vl 1200	150.0.1.0/30	phy phy int	160.0.5.1/32	0	-	-	any	UDP_dst_2000-1	Allow
2 test	offload	universal	phy vl 1200	170.0.1.0/30	any	any	0	-	-	any	application-default	Allow
3 vl 150 drop	offload	universal	phy vl 1200	150.0.1.0/30	any	any	0	-	-	any	udp_10000	Drop
4 vl 150 offload	offload	universal	phy vl 1200	150.0.1.0/29	any	any	0	-	-	any	UDP_dst_2000-1	Allow
5 vl 170-171	mss	universal	phy vl 1200	170.0.1.0/30	phy phy int	171.0.7.0/30	0	-	-	any	udp 17100	Allow
6 vl 150	mss	universal	phy vl 1200	150.0.1.0/27	any	any	0	-	-	any	application-default	Allow
7 intrazone-default	none	intrazone	any	any	(intrazone)	any	0	-	-	any	any	Allow
8 interzone-default	none	interzone	any	any	any	any	160	2019-03-11 13:38:35	2019-02-11 20:03:33	any	any	Allow

Figure 19: Firewall policy configuration

Interface	Interface Type	Management Profile	Link State	IP Address	Virtual Router	Tag	VLAN / Virtual-Wire	Security Zone	Features	Comment
ethernet1/1	Aggregate (ae1)		🔴	none	none	Untagged	none	none		po 100 - near interface
ethernet1/2	Aggregate (ae1)		🔴	none	none	Untagged	none	none		po 100 - near interface
ethernet1/3	Aggregate (ae2)		🔴	none	none	Untagged	none	none		po 101 - far interface
ethernet1/4	Aggregate (ae2)		🔴	none	none	Untagged	none	none		po 101 - far interface
ethernet1/5	Layer2		🔴	none	none	Untagged	none	none		
ethernet1/6	Virtual Wire		🔴	none	none	Untagged	none	none		
ethernet1/7	Tap		🔴	none	none	Untagged	none	none		
ethernet1/8	Layer2		🔴	none	none	Untagged	none	none		
ethernet1/9	Layer2		🔴	none	none	Untagged	none	none		
ethernet1/10	Aggregate (ae7)		🔴	none	none	Untagged	none	none		
ethernet1/11	Aggregate (ae8)		🔴	none	none	Untagged	none	none		
ethernet1/12	Aggregate (ae7)		🔴	none	none	Untagged	none	none		
ethernet1/13	Aggregate (ae8)		🔴	none	none	Untagged	none	none		
ethernet1/14	Tap		🔴	none	none	Untagged	none	none		
ethernet1/15	Virtual Wire		🔴	none	none	Untagged	none	none		
ethernet1/16	Virtual Wire		🔴	none	none	Untagged	none	none		
ethernet1/17	Layer3	allow ping	🔴	none	none	Untagged	none	none		
ethernet1/17.1200	Layer3	allow ping	🟢	199.2.0.2/21	default	1200	none	vl 1200		
ethernet1/17.1201	Layer3	allow ping	🟢	199.2.0.2/21 199.2.8.2/21	default	1201	none	vl 1201		

Figure 20: Firewall interface configuration

Create a rule that Arista MSS will use to intercept and redirect traffic and add a firewall policy with the default “Arista_MSS” tag as shown in the example above. MSS intercepts all traffic from endpoints identified in policies that match the tag values configured in CVX. The firewall will apply all rules (tagged or untagged) to all traffic.

Note: LLDP should always be enabled on the firewall interfaces attached to the service switches. To minimize reconvergence time on the network changes, reduce the LLDP transmit interval and hold time multiples on the firewall, while keeping the LLDP hold time above the LLDP timer configured on the connected Arista switches.

Alternatively, the **device interface map** command can be used on CVX to manually map a device to Arista switch interfaces. To map multiple devices, add a mapping entry for each device.

```
dynamic device-set fw1
device dc-firewall-1
map device-interface ethernet1/1 switch 00:1c:73:7e:21:bb interface Ethernet1
map device-interface ethernet1/2 switch 00:1c:73:7e:21:bb interface Ethernet9
```

8.3.4.4 MSS Integration with Check Point

Macro Segmentation Service (MSS) is configurable for Check Point Software Technologies (Check Point) Firewalls. The configuration and deployment requires the use of Check Point Management Server (Gaia), a security management platform which allows central management of Check Point gateway security devices.

Requirements

The following requirements apply to the deployment.

- MSS version R80.30 version 1.5 and above and a special URL access on the Management Server using a Gateway API provided by Check Point.
- Gateway version R80.30 with API version 1.2 and above.
- Check Point Management Server release R31 and above.

Configuration and Deployment

The following components of the solution require configuration:

- Check Point Gateway firewalls
- Check Point Management Server
- Arista leaf switches
- CVX

Check Point Firewalls (Gateways)

Interface Configuration

Configure IPv4 addresses on the routed L3 interfaces on the firewall interfaces connected to the Arista TORs.

IPv4 Static Routes Configuration

Configure IPv4 static routes to include routes to all subnets of the hosts which MSS will be intercepting either using a WebUI or CLI as shown below. The nexthop gateway addresses are the gateway of the subnet to which the firewall interfaces. The static route information is used by MSS to identify which firewall interface is connected to the subnet to which the intercepted traffic needs to be forwarded.

```
set static-route 192.0.2.0/24 nexthop gateway address 192.0.2.155 on
```

The following displays the configuration.

```
gateway1> show route static
Codes: C - Connected, S - Static, R - RIP, B - BGP (D - Default),
       O - OSPF IntraArea (IA - InterArea, E - External, N - NSSA),
       A - Aggregate, K - Kernel Remnant, H - Hidden, P - Suppressed,
       U - Unreachable, i - Inactive

S          0.0.0.0/0          via 172.2.18.12, Mgmt, cost 0, age
3134690
S          10.6.10.0/24       via 10.6.100.2, eth1, cost 0, age
3134690
S          10.6.20.0/24       via 10.6.200.2, eth2, cost 0, age
3134690
```

Check Point Management Server Configuration

The Check Point firewall devices intended to be used with Arista MSS must be registered and fully manageable via a Check Point Management Server.

- Identify or define a new security policy network layer to be considered by MSS where 'TestPolicy' is the security policy network layer that is referenced in the CVX configuration.
- Create firewall access rules (to be used by Arista MSS).
- In the access rule, the supported source and destination object types are Host, Network, and Security Zone.
- In the "Services & Applications," the following services are supported: 1: ICMP, IGMP, IPv4, TCP, EGP, UDP, IPv6, RSVP, GRE, OSPFIGP, SCTP.

- Add tags in the policy comments/description field in this format: "tags(<tag1>, <tag2>, ...)", e.g. "tags(Arista_MSS1, Arista_MSS2)"
 - Arista MSS inspects management server access rules that have an embedded "tags()" string in the comments field. Individual tags are extracted from within the enclosing parentheses and compared with the tags configured in the Arista MSS device-set on CVX.

1-to-1 HA Cluster Configuration

The following figure shows the 1-to-1 HA cluster. The HA interface pairs connected to the Arista switches should have Virtual IP addresses where the intercepted traffic will be forwarded. The active firewall sends out a GARP with its own MAC to indicate where traffic sent to the VIP should be forwarded.

Arista Leaf Switches Configuration

The following configures the switch interfaces connected to the firewall.

```
switchport trunk native vlan <interface vlan>
switchport mode trunk
spanning-tree portfast
spanning-tree bpduguard enable

interface Vlan<interface vlan>
  ip address virtual <interface IPv4 address>/<mask>
```

CVX Configuration

The following displays the CVX configuration with Standalone Check Point firewall.

```
!! Standalone firewall
cvx
  no shutdown
  service mss
  no shutdown
  !
  dynamic device-set chkpt
    device <management-server-ip-or-dnsName>
      username admin password 7 PKigsm//o3IcnW5rqoZXWQ==
      protocol https 4434 (or the configured https port like 443)
      group <management-server-network-layer>
    !
    device member <checkpoint-device-name>
      map device-interface eth1 switch 00:1c:73:7e:28:11 interface
Ethernet39
      map device-interface eth2 switch 00:1c:73:7e:28:11 interface
Ethernet40
      type check-point management-server
      policy tag offload Arista_MSS_offload
      policy tag redirect Arista_MSS
      state active
```

The checkpoint-device-name used in the 'device member <checkpoint-device-name>' command is the name used in the Management Server to identify that firewall. A sample CVX configuration with Check Point firewalls in 1-to-1 High Availability cluster configuration will include more than one device member as follows:

```
!! HA Active/Passive firewall pair
cvx
  no shutdown
  service mss
  no shutdown
  !
```

```

dynamic device-set chkpt
  device <management-server-ip-or-dnsName>
    username admin password 7 PKigsm//o3IcnW5rqoZXWQ==
    protocol https 4434 (or the configured https port like 443)
    group <management-server-network-layer>
  !
  device member <checkpoint-device1-name>
    map device-interface eth1 switch 00:1c:73:7e:28:11 interface
Ethernet39
    map device-interface eth2 switch 00:1c:73:7e:28:11 interface
Ethernet40
  device member <checkpoint-device2-name>
    map device-interface eth1 switch 00:1c:73:7e:28:11 interface
Ethernet41
    map device-interface eth2 switch 00:1c:73:7e:28:11 interface
Ethernet42
  type check-point management-server
  policy tag offload Arista_MSS_offload
  policy tag redirect Arista_MSS
  state active

```

8.3.4.5 MSS for Layer 3 Firewall Enhancements

The *verbatim* qualifier enhances the Macro Segmentation Service (MSS) with two policy actions: *redirect* and *offload*. For firewall policies tagged with the *redirect* tag, MSS extracts IP addresses from the policy and forwards all traffic destined to or generated from that set of IP addresses to the firewall. The additional *verbatim* tag, redirecting bidirectional traffic is restricted to the subset that matches the additional qualifiers of a firewall policy to a firewall (such as the source, destination IP addresses or subnets, protocol, L4 ports).

The *verbatim* tag can also be paired with the *offload* tag for a policy which installs necessary DirectFlow rules at the TORs to drop or allow the traffic matching the exact qualifiers in the policy definition. If the *verbatim* tag is not used with the *offload* tag, the behavior is to offload enforcement for all traffic matching the specific policy rule, while redirecting the remainder of the (non-matching) traffic to the firewall to ensure the security policy for the protected host remains in compliance. The addition of the *verbatim* tag removes this implicit redirection

Configuring for *verbatim* Use

Firewall Configuration

The *verbatim* is a modifier of the original policy enforcement scheme and works with multiple firewalls such as those from Palo Alto Networks and Fortinet.

Policy Semantics

IP address extraction for *redirect* or *offload* tag:

- If IP addresses are specified in source or destination field, Mss extracts those for redirection.
- If no IP addresses are specified, then Mss extracts the subnets corresponding to the source and destination zone for redirection.
- If no zones are specified, then Mss extracts all subnets in the *default* virtual-router for redirection.

Constraints on *offload* tag policies:

- Must have IP address specified in source or destination field if the corresponding zone is an *external* zone (zone towards default route).

Constraints on *redirect verbatim* tag policies:

- Must have IP address specified in source or destination field if the corresponding zone is an *external* zone (zone towards default route).

- Must have either zone or IP specified in both source and destination field. 'Any', 'All', or similar constructs are not supported for source or destination fields.

Policies with broadcast or multicast destination:

- Only *offload* and *offloadverbatim* tags are supported for policies with IPv4 broadcast or IPv4 multicast destination.

CVX Configuration

The following configuration commands set 'tag-list' as the verbatim modifier on a per device basis for the *redirect* and *offload* tags.

```
cvx
  service mss
    dynamic device-set <device-set-name>
      device <device-name>
        [no | default] policy tag redirect <tag-list>
        [no | default] policy tag offload <tag-list>
        [no | default] policy tag modifier verbatim <tag-list>
```

TCAM Profile Configuration

The following depicts a recommended TCAM profile to be used with MSS.

 **Note:** This is an example for some of the devices that are currently supported.

```
hardware tcam
  profile direct-flow-mssl3-vxlan
    feature acl port ip
      sequence 50
      key size limit 160
      key field dscp dst-ip ip-frag ip-protocol 14-dst-port 14-ops 14-
src-port src-ip tcp-control ttl
      action count drop
      packet ipv4 forwarding bridged
      packet ipv4 forwarding routed
      packet ipv4 forwarding routed multicast
      packet ipv4 mpls ipv4 forwarding mpls decap
      packet ipv4 mpls ipv6 forwarding mpls decap
      packet ipv4 non-vxlan forwarding routed decap
      packet ipv4 vxlan eth ipv4 forwarding routed decap
      packet ipv4 vxlan eth ipv6 forwarding routed decap
      packet ipv4 vxlan forwarding bridged decap
    feature acl port ip egress mpls-tunnelled-match
      sequence 100
    feature acl port ipv6
      sequence 30
      key field dst-ipv6 ipv6-next-header ipv6-traffic-class 14-dst-
port 14-ops-3b 14-src-port
      src-ipv6-high src-ipv6-low tcp-control
      action count drop
      packet ipv6 forwarding bridged
      packet ipv6 forwarding routed
      packet ipv6 forwarding routed multicast
      packet ipv6 ipv6 forwarding routed decap
    feature acl port mac
      sequence 60
      key size limit 160
      key field dst-mac ether-type src-mac
      action count drop
      packet ipv4 forwarding bridged
      packet ipv4 forwarding routed
```



```
packet ipv4 forwarding routed multicast
packet ipv4 mpls ipv4 forwarding mpls decap
packet ipv4 mpls ipv6 forwarding mpls decap
packet ipv4 non-vxlan forwarding routed decap
packet ipv4 vxlan eth ipv4 forwarding routed decap
packet ipv4 vxlan forwarding bridged decap
packet ipv6 forwarding bridged
packet ipv6 forwarding routed
packet ipv6 forwarding routed decap
packet ipv6 forwarding routed multicast
packet ipv6 ipv6 forwarding routed decap
packet mpls forwarding bridged decap
packet mpls ipv4 forwarding mpls
packet mpls ipv6 forwarding mpls
packet mpls non-ip forwarding mpls
packet non-ip forwarding bridged
feature acl subintf ip
sequence 45
key size limit 160
key field dscp dst-ip ip-frag ip-protocol l4-dst-port l4-ops-18b
l4-src-port src-ip tcp-control ttl
action count drop
packet ipv4 forwarding routed
feature acl subintf ipv6
sequence 20
key field dst-ipv6 ipv6-next-header l4-dst-port l4-src-port src-
ipv6-high src-ipv6-low tcp-control
action count drop
packet ipv6 forwarding routed
feature acl vlan ip
sequence 40
key size limit 160
key field dscp dst-ip ip-frag ip-protocol l4-dst-port l4-ops-18b
l4-src-port src-ip tcp-control ttl
action count drop
packet ipv4 forwarding routed
packet ipv4 mpls ipv4 forwarding mpls decap
packet ipv4 mpls ipv6 forwarding mpls decap
packet ipv4 non-vxlan forwarding routed decap
packet ipv4 vxlan eth ipv4 forwarding routed decap
packet ipv4 vxlan eth ipv6 forwarding routed decap
feature acl vlan ipv6
sequence 15
key field dst-ipv6 ipv6-next-header l4-dst-port l4-src-port src-
ipv6-high src-ipv6-low tcp-control
action count drop
packet ipv6 forwarding routed
packet ipv6 ipv6 forwarding routed decap
feature acl vlan ipv6 egress
sequence 25
key field dst-ipv6 ipv6-next-header ipv6-traffic-class l4-dst-port l4-
src-port src-ipv6-high src-ipv6-low
tcp-control
action count drop
packet ipv6 forwarding routed
feature flow
key size limit 160
key field dst-ip ether-type in-port ip-protocol l4-dst-port l4-
src-port src-ip
action drop redirect set-fwd-header
packet ipv4 forwarding bridged
packet ipv4 forwarding routed
feature forwarding-destination mpls
sequence 105
```

```

feature mpls
  sequence 5
  key size limit 160
  action drop redirect set-ecn
  packet ipv4 mpls ipv4 forwarding mpls decap
  packet ipv4 mpls ipv6 forwarding mpls decap
  packet mpls ipv4 forwarding mpls
  packet mpls ipv6 forwarding mpls
  packet mpls non-ip forwarding mpls
feature mpls pop ingress
  sequence 95
feature pbr mpls
  sequence 70
  key size limit 160
  key field mpls-inner-ip-tos
  action count drop redirect
  packet mpls ipv4 forwarding mpls
  packet mpls ipv6 forwarding mpls
  packet mpls non-ip forwarding mpls
feature tunnel vxlan
  sequence 55
  key size limit 160
  key field in-port vxlan-inner-etype vxlan-inner-ip-options
vxlan-inner-ip-ttl
  packet ipv4 vxlan eth ipv4 forwarding routed decap
  packet ipv4 vxlan eth ipv6 forwarding routed decap
  packet ipv4 vxlan forwarding bridged decap
feature tunnel vxlan routing
  sequence 10
  packet ipv4 forwarding routed
  packet ipv4 non-vxlan forwarding routed decap
  packet ipv4 vxlan eth ipv4 forwarding routed decap
  packet ipv4 vxlan eth ipv6 forwarding routed decap

```

The following displays the profile. The platform does not support any arbitrarily created PMF profile. If the PMF profile cannot be programmed, the show command will print 'ERROR' in the status column.

```

switch#show hardware tcam profile
Configuration Status
FixedSystem direct-flow-mssl3-vxlan direct-flow-mssl3-vxlan

```

Limitations

- DirectFlow needs to be enabled at the TOR so that the policies enforced by MSS are correctly programmed.
- *Group* option is available only for some switches.
- Deployments with a mix of switches require special considerations. The following table summarizes supported configurations in different deployment models.

Table 5: Configuration Summary

Both compute and service TORs: DCS-7050X, DCS-7050X2, DCS-7050X3, DCS-7060X, DCS-7060X2	group, verbatim	<ul style="list-style-type: none"> • redirect • offload • redirect, verbatim • offload, verbatim
Both compute and service TORs: DCS-7020R, DCS-7280R, DCS-7280R2, DCS-7500R, DCS-7500R2	verbatim	<ul style="list-style-type: none"> • redirect, verbatim • offload, verbatim

Both compute and service TORs: DCS-7050X, DCS-7050X2, DCS-7050X3, DCS-7060X, DCS-7060X2, DCS-7020R, DCS-7280R, DCS-7280R2, DCS-7500R, DCS-7500R2	verbatim	<ul style="list-style-type: none"> • redirect, verbatim • offload, verbatim
DCS-7050X, DCS-7050X2, DCS-7050X3, DCS-7060X, DCS-7060X2 as compute TOR and other series as service TOR (with no intercepted hosts connected).	group, verbatim	<ul style="list-style-type: none"> • redirect • offload • redirect, verbatim • offload, verbatim

Backward Compatibility and other considerations

For existing deployments, (where any of DCS-7020R, DCS-7280R, DCS-7280R2, DCS-7500R, DCS-7500R2 switch platforms are used in the service rack), in order to upgrade hitlessly, upgrade the CVX cluster first and execute the following command prior to upgrading EOS on any switch:

```
cvx
  service mss
    policy enforcement rules group verbatim
```

The command [**no|default**] **policy enforcement rules { group verbatim | verbatim }** disables / enables policy enforcement.

Displaying CVX Status

The following displays the status of the mss policy.

```
switch#show service mss policy

<--snip-->
                Macro-Segmentation L3 Policy Table
-----
Source          Device      Policy      Offload      Redirect
Unconverged
                status      status      IPs
-----
-----
PaloAltoFirewall fwpan1    policy1     N/A          Active       N/A
PaloAltoFirewall fwpan1    policy2     Active       N/A         N/A
PaloAltoFirewall fwpan1    policy3     Active       Active       0 of
2
PaloAltoFirewall fwpan1    policy4     N/A          Active       0 of
2
```

The following displays the status of the mss policy in more detail.

```
switch#show service mss policy detail
-----
Source: PaloAltoFirewall
-----
Device: fwpan1
Policy (L3): policy1
Offload Status: N/A
Redirect Status: Active
```

```

Tags: MSS_redirect, MSS_verbatim
Policy Modifier: Verbatim
VRF: default
Policy (L3): policy2
Offload Status: Active
Redirect Status: N/A
Tags: MSS_offload, MSS_verbatim
Policy Modifier: Verbatim
VRF: default
Policy (L3): policy3
Offload Status: Active
Redirect Status: Active
Tags: MSS_offload
VRF: default
IP Addresses:
  Active: 10.10.10.1
  Active: 10.10.20.1
Policy (L3): policy4
Offload Status: N/A
Redirect Status: Active
Tags: MSS_redirect
VRF: default
IP Addresses:
  Active: 10.10.10.1
  Active: 10.10.10.2

```

Displaying Flow Information Details on TOR Switch

```

switch#show directflow detail
Flow default:spm:fwpan1:30000::10.10.20.2/32::10.10.20.3/32::::nh-1.10
0.0.2:(Flow programmed)
persistent: False
priority: 30000
priorityGroupType: default
hard timeout: 0
idle timeout: 0
match:
  Ethernet type: IPv4
  source IPv4 address: 10.10.20.2/255.255.255.255
  destination IPv4 address: 10.10.20.3/255.255.255.255
  IPv4 protocol: TCP
  destination TCP/UDP port: 22
actions:
  output nexthop: 1.10.100.2
source: mssl3
matched: 0 packets, 0 bytes

Flow default:spm:fwpan1:30000::10.10.20.3/32::10.10.20.2/32::::nh-1.10
0.0.2:(Flow programmed)
persistent: False
priority: 30000
priorityGroupType: default
hard timeout: 0
idle timeout: 0
match:
  Ethernet type: IPv4
  source IPv4 address: 10.10.20.3/255.255.255.255
  destination IPv4 address: 10.10.20.2/255.255.255.255
  IPv4 protocol: TCP
  source TCP/UDP port: 22
actions:
  output nexthop: 1.10.100.2
source: mssl3

```

```
matched: 0 packets, 0 bytes  
<--snip-->
```

8.3.4.6 MSS Commands

Configuration Commands

- [dynamic device-set](#)
- [exception device](#)
- [group](#)
- [name-resolution interval \(CVX-OpenStack\)](#)
- [service mss](#)
- [state](#)
- [tag](#)
- [type palo-alto](#)

CVX Show Commands

- [show service mss dynamic device-set](#)
- [show service mss policy](#)
- [show service mss status](#)
- [show service mss zone](#)

8.3.4.6.1 dynamic device-set

The **dynamic device-set** command configures a device such as a firewall to communicate with the MSS in the MSS configuration mode.

The **no dynamic device-set** command removes a previously configured device from the MSS configuration and returns to the CVX mode.

Command Mode

MSS Configuration

Command Syntax

```
dynamic device-set device-set_name
```

```
no dynamic device-set device-set_name
```

Parameters

device-set_name a unique name for the device set.

Example

This example creates a set of firewalls with the name **panfw1**.

```
cvx#configure
cvx(config)#cvx
cvx(config-cvx)#no shutdown
cvx(config-cvx)#service mss
cvx(config-cvx-mss)#no shutdown
cvx(config-cvx-mss)#vni range 30000-40000
cvx(config-cvx-mss)#dynamic device-set panfw1
cvx(config-cvx-mss-panfw1)#
```



Note: The **vni range** command configures a range of VXLAN Network Identifiers (VNI) that MSS uses to tunnel traffic to the firewall. If VNI range is not configured, the default VNIs in the range of 1 to 16777214 are used.

8.3.4.6.2 exception device

The **exception device** command bypasses or continues redirecting traffic to service device such as a firewall if the service device control-plane API is unreachable after initial policies have been processed.

The no exception device command.

Command Mode

MSS Configuration

Command Syntax

```
exception device unreachable [bypass | redirect]
no exception device unreachable [bypass | redirect]
default exception device unreachable bypass
```

Parameters

- **device**: service device in the device set.
- **unreachable**: service device control-plane API is unreachable.
- **bypass**: bypass the service device.
- **redirect**: continue redirecting traffic to the service device.

Example

This example redirects traffic to the service device.

```
cvx#configure
cvx(config)#cvx
cvx(config-cvx)#no shutdown
cvx(config-cvx)#service mss
cvx(config-cvx-mss)#no shutdown
cvx(config-cvx-mss)#vni range 30000-40000
cvx(config-cvx-mss)#dynamic device-set fw
cvx(config-cvx-mss-fw)#device firewall-dc7
cvx(config-cvx-mss-fw)#username admin password 7 PKigsmo3IcnW5rqoZXWQ
cvx(config-cvx-mss-fw)#state active
cvx(config-cvx-mss-fw)#type palo-alto firewall
cvx(config-cvx-mss-fw)#exception device unreachable redirect
```

8.3.4.6.3 group

The **group** command configures the Panorama device group name to be used with MSS.

The **no group** command removes the group from the MSS configuration when the Panorama firewall manager is used.

See the type `palo-altocommand` for more information about the firewall manager.

Command Mode

Device-set mode

Command Syntax

```
group group_name
```

```
no group group_name
```

Parameters

group_name the name of the group.

Example

This command configures the group name as ***mssDevices***.

```
cvx(config)#cvx
cvx(config-cvx)#service mss
cvx(config-cvx-mss)#dynamic device-set pano2
cvx(config-cvx-mss-pano2)#type palo-alto panorama
cvx(config-cvx-mss-pano2)#device myPanorama
cvx(config-cvx-mss-pano2-myPanorama)#group mssDevices
```

8.3.4.6.4 name-resolution interval (CVX-OpenStack)

The **name-resolution interval** command specifies the period between consecutive requests that the OpenStack controller sends to the Keystone service for VM and tenant name updates. Keystone is OpenStack's authentication and authorization service.

The default period is 21600 seconds (6 hours).

The name-resolution force (CVX-OpenStack) command performs an immediate update, as opposed to waiting for the periodic update.

Command Mode

CVX-OpenStack Configuration

Command Syntax

```
name-resolution interval period
```

Parameters

- period: Keystone identity service polling interval (seconds).

Comment

service openstack places the switch in **CVX-OpenStack** configuration mode.

Example

These commands set the name resolution interval period at five hours.

```
switch(config)#cvx
switch(config-cvx)#service openstack
switch(config-cvx-openstack)#name-resolution interval 18000
switch(config-cvx-openstack)#
```

8.3.4.6.5 service mss

The **service mss** command enters the MSS configuration sub-mode.

The **no service mss** command exits the MSS configuration mode and returns to the CVX mode.

Command Mode

CVX Configuration

Command Syntax

```
service mss
```

```
no service mss
```

```
default service mss
```

Example

This example enables MSS on CVX and enters the MSS config mode.

 **Note:** The **no shutdown** command enables MSS on the CloudVision eXchange (CVX).

```
cvx# configure
cvx(config)# cvx
cvx(config-cvx)# no shutdown
cvx(config-cvx)# service mss
cvx(config-cvx-mss)# no shutdown
```

8.3.4.6.6 show service mss dynamic device-set

The **show service mss dynamic device-set** command displays detailed information about a specific service device set. Information such as device group members, high availability, network, resource details are displayed.

 **Note:** Interfaces from multiple switches can be placed in the same zone by the device.

Command Mode

EXEC

CVX Configuration

Command Syntax

```
show service mss dynamic device-set device_set_name [device device_name [group-  
members | high-availability | neighbors | network | policies | resources]]
```

Parameters

- *device_set_name* defines the device set name.
- device *device name* defines the service device properties such as the DNS hostname or IP address of the service device.
- group members lists device-group members for an aggregation manager.
- high-availability displays service device high availability information.
- neighbors displays the service devices ethernet interface neighbor information.
- network displays the service devices network interface information.
- policies displays the list of policies read from service device that have the MSS tag.
- resources displays the service devices system resource information.

Related Commands

- [show service mss status](#)
- [show service mss policy](#)

Examples

- This command displays information about interfaces that are placed in a zone by the device1.

```
switch#show service mss zone  
Source: static  
-----  
Device: device1
```

- This command displays information about interfaces that are placed in a zone by the device1.

```
switch#show service mss zone  
Source: static  
-----  
Device: device1  
Zone: zone1  
Switch: 00:00:00:00:00:01  
Hostname: switch1.arista.com  
Interfaces:  
Ethernet1/1  
Allowed VLAN: 1000-1010  
Port-Channel2/1:  
Allowed VLAN: 1000-2000  
Switch: 00:00:00:00:00:02  
Hostname: switch2.arista.com  
Interfaces:  
Ethernet10/1
```

```
Allowed VLAN: 1000-1010
Zone: zone2
Switch: 00:00:00:00:00:01
Hostname: switch1.arista.com
Interfaces:
Ethernet10/1
Allowed VLAN: 1000-1010
Ethernet 20/1
Allowed VLAN: 1000-2000
```

8.3.4.6.7 show service mss policy

The **show service mss policy** command displays generic information about the configuration and operational state of the macro-segmentation service (MSS) policies on a device.

Command Mode

EXEC

CVX Configuration

Command Syntax

```
show service mss policy [[device device_name] [name policy-name] [source (static |  
plugin_name)]]
```

Parameters

- device *device name* defines the service device name.
- name *policy-name* the filter policy name.
- source the source of the policy.
- static the policy configured using the command line interface.
- *plugin_name* the service device type.

Related Commands

- [show service mss status](#)
- [show service mss zone](#)

Example

This command displays information about the MSS policy policy1 enabled on the device.

```
cvx#show service mss policy name policy1  
Source Device Policy Config Status  
-----  
vendor Firewall pan100 policy1 Enabled Initialized
```

The "Config" column indicates the configuration state of a policy. The different states are: *Enabled*, *dry run*, and *disabled* states.

The "Status" column indicates the operational state of a policy. The different status types are *initialized*, *pending*, *initializing*, *active*, *reinitializing*, *dry-run Complete*, and *deactivating*.

8.3.4.6.8 show service mss status

The **show service mss status** command displays the status of a macro-segmentation service (MSS) on the device.

Command Mode

EXEC

CVX Configuration

Command Syntax

```
show service mss status
```

Related Commands

- [show service mss policy](#)
- [show service mss zone](#)

Examples

- This command displays the MSS status on the device as Enabled.

```
switch#show service mss status  
State: Enabled  
Service VNIs: 1500-1600,1800,1900-2000
```

- This command displays the MSS status on the device as Disabled.

```
switch#show service mss status  
State: Disabled  
Service VNIs: 1-16777214
```

8.3.4.6.9 show service mss zone

The **show service mss zone** command displays information about the interfaces that are placed in a single zone by the service device. Along with the **show service mss policy** command, we can use this command to identify issues with the policy configuration.

Interfaces from multiple switches can be placed in the same zone by the device.

Command Mode

EXEC

CVX Configuration

Command Syntax

```
show service mss zone [[device device_name][[name zone_name]] [source (static |  
dynamic_source)]]
```

Parameters

- *device device name* defines the service device properties.
- *name policy-name* the filter zone name.
- *source* the source of the zone.
- *static* the zone configured using the command line interface.
- *dynamic_source* the service device type.

Related Commands

- [show service mss status](#)
- [show service mss policy](#)

Example

This command displays information about interfaces that are placed in a zone by the **device1**.

```
switch#show service mss zone
Source: static
-----
Device: device1
Zone: zone1
Switch: 00:00:00:00:00:01
Hostname: switch1.arista.com
Interfaces:
Ethernet1/1
Allowed VLAN: 1000-1010
Port-Channel2/1:
Allowed VLAN: 1000-2000
Switch: 00:00:00:00:00:02
Hostname: switch2.arista.com
Interfaces:
Ethernet10/1
Allowed VLAN: 1000-1010
Zone: zone2
Switch: 00:00:00:00:00:01
Hostname: switch1.arista.com
Interfaces:
Ethernet10/1
Allowed VLAN: 1000-1010
Ethernet 20/1
Allowed VLAN: 1000-2000
```

8.3.4.6.10 state

The **state** command configures device set as active or disabled or suspended state.

The no state command disables the previously configured state of the device set.

Command Mode

MSS Configuration

Command Syntax

```
state [active | shutdown | suspend]
```

```
no state
```

Parameters

- **active**: the active state of the device set. Policy monitoring and network traffic redirection are enabled.
- **shutdown**: the disabled state of the device set. Policy monitoring and network traffic redirection is stopped.
- **suspend**: the suspended state of the device set. Policy monitoring is suspended but there is no change in the existing traffic redirection.

Example

This output example configures the device set state as active.

```
cvx#configure
cvx(config)#cvx
cvx(config-cvx)#no shutdown
cvx(config-cvx)#service mss
cvx(config-cvx-mss)#no shutdown
cvx(config-cvx-mss)#vni range 30000-40000
cvx(config-cvx-mss)#dynamic device-set panfwl
cvx(config-cvx-mss-panfwl)#tag Arista_MSS
cvx(config-cvx-mss-panfwl)#type palo-alto firewall
cvx(config-cvx-mss-panfwl)#state active
```

8.3.4.6.11 tag

The **tag** command specifies the tag or tags that MSS searches when it is reading the security policy from the firewall or firewall manager in the dynamic device-set configuration mode. You can specify more than one tag as well.

The **no tag** command removes the tag from the MSS configuration.

 **Note:** The tag specified should always match with the firewall policy tags in the vendor firewall policy for the MSS to read the policy and set up the intercept.

Command Mode

MSS Configuration

Command Syntax

```
tag tag_name
```

```
no tag
```

```
default tag Arista_MSS
```

Parameters

tag_name: a unique name for the tag.

Examples

- This command specifies the tag with the name **Arista_MSS**.

```
cvx#configure
cvx(config)#cvx
cvx(config-cvx)#no shutdown
cvx(config-cvx)#service mss
cvx(config-cvx-mss)#no shutdown
cvx(config-cvx-mss)#vni range 30000-40000
cvx(config-cvx-mss)#dynamic device-set panfw1
cvx(config-cvx-mss-panfw1)#tag Arista_MSS
```

- This command specifies multiple tags with names **mss1**, **mss2**, and **mss3**.

```
cvx#configure
cvx(config)#cvx
cvx(config-cvx)#no shutdown
cvx(config-cvx)#service mss
cvx(config-cvx-mss)#no shutdown
cvx(config-cvx-mss)#vni range 30000-40000
cvx(config-cvx-mss)#dynamic device-set panfw1
cvx(config-cvx-mss-panfw1)#tag mss1 mss2 mss3
```

8.3.4.6.12 type palo-alto

The `type palo-alto` command configures the firewall type to be used in the MSS configuration.

The `no type palo-alto` command disables the firewall type from the MSS configuration.

Command Mode

MSS Configuration

Command Syntax

```
type palo-alto [firewall | panorama]
```

```
no type palo-alto
```

Parameters

- `firewall`: the Palo Alto Networks firewall.
- `panorama`: the Palo Alto Networks Panorama firewall manager.

Example

This command configures the Palo Alto Networks firewall type.

```
cvx#configure
cvx(config)#cvx
cvx(config-cvx)#service mss
cvx(config-cvx-mss)#dynamic device-set panfw1
cvx(config-cvx-mss-panfw1)#type palo-alto firewall
```

Quality of Service and Traffic Management

This chapter describes Arista's Quality of Service (QoS) implementation and Traffic Management, including configuration instructions and command descriptions. Topics covered by this chapter include:

- [Quality of Service](#)
- [Traffic Management](#)

9.1 Quality of Service

This chapter describes Arista's Quality of Service (QoS) implementation, including configuration instructions and command descriptions. Topics covered by this chapter include:

- [Quality of Service Conceptual Overview](#)
- [QoS Configuration: Platform-Independent Features](#)
- [QoS Configuration: Arad Platform Switches](#)
- [QoS Configuration: Jericho Platform Switches](#)
- [QoS Configuration: FM6000 Platform Switches](#)
- [QoS Configuration: Petra Platform Switches](#)
- [QoS Configuration: Trident and Tomahawk Platform Switches](#)
- [QoS Configuration: Trident II and Helix Platform Switches Support for Configuring Color Extended Communities](#)
- [ACL based QoS Configuration](#)
- [Quality of Service Configuration Commands](#)

9.1.1 Quality of Service Conceptual Overview

QoS processes apply to traffic that flows through Ethernet ports and control planes. These processes can modify data fields (CoS or DSCP) or assign data streams to traffic classes for prioritized handling. Transmission queues are configurable for individual Ethernet ports to shape traffic based on its traffic class. Many switches also support traffic policies that apply to data that is filtered by access control lists.

The following sections describe QoS features:

- [QoS Data Fields and Traffic Classes](#)
- [Transmit Queues and Port Shaping](#)
- [Explicit Congestion Notification \(ECN\)](#)
- [ACL Policing](#)
- [Quality of Service \(QoS\) Profiles](#)

9.1.1.1 QoS Data Fields and Traffic Classes

Quality of Service (QoS) defines a method of differentiating data streams to provide varying levels of service to the different streams.

Criteria determining a packet's priority level include packet field contents and the port where data packets are received. QoS settings are translated into traffic classes, which are then used by switches to manage all traffic flows. Traffic flow management varies with each switch platform.

9.1.1.1.1 QoS Data Fields

Quality of service decisions are based on the contents of the following packet fields:

- CoS (three bits): Class of service (CoS) is a 3-bit field in Ethernet frame headers using VLAN tagging. The field specifies a priority value between zero and seven. Class of service operates at layer 2.
- DSCP (six bits): Differentiated Service Code Point (DSCP) is a 6-bit field in the Type Of Service (TOS) field of IP packet headers.

9.1.1.1.2 Port Settings – Trust Mode and Traffic Class

Ethernet and port channel interfaces support three QoS trust modes:

- CoS Trust: Ports use inbound packet CoS field contents to derive the traffic class.
- DSCP Trust: Ports use inbound packets DSCP field contents to derive the traffic class.
- Untrusted: Ports use their default values to derive the traffic class, ignoring packet contents.

The default mode setting is **CoS trust** for switched ports and **DSCP trust** for routed ports.

Ports are associated with default CoS, DSCP, and traffic class settings; defaults vary by platform.

These sections describe procedures for configuring port settings:

- [CoS and DSCP Port Settings – Arad Platform Switches](#)
- [CoS and DSCP Port Settings – FM6000 Platform Switches](#)
- [CoS and DSCP Port Settings – Petra Platform Switches](#)
- [CoS and DSCP Port Settings – Trident and Tomahawk Platform Switches](#)
- [CoS and DSCP Port Settings – Trident II and Helix Platform Switches](#)

9.1.1.1.3 Rewriting CoS and DSCP

CoS Rewrite

Switches can rewrite the CoS field for outbound tagged packets. The new CoS value is configurable, and is derived from a data stream's traffic class as specified by the traffic class-to-CoS rewrite map. CoS rewrite is disabled on all the traffic received on CoS trusted ports.

On Arad, Jericho, FM6000, Trident and Tomahawk, Trident II, and Helix platform switches, CoS rewrite can be enabled or disabled on DSCP trusted ports and untrusted ports.

- CoS rewrite is globally enabled by default for packets received on untrusted ports and DSCP trusted ports if at least one port is explicitly configured in **DSCP trust** or **untrusted** mode.
- CoS rewrite is globally disabled by default for packets received on untrusted ports and DSCP trusted ports if there are no ports explicitly configured in **DSCP trust** or **untrusted** mode.

On Petra platform switches, CoS rewrite is always enabled on DSCP trusted ports and untrusted ports.

DSCP Rewrite

Switches can rewrite the DSCP field for outbound IP packets. On FM6000, Trident and Tomahawk, Trident II, and Helix platform switches, DSCP rewrite is disabled by default on all ports and always disabled for traffic received on DSCP trusted ports. On Petra, Arad, and Jericho platform switches, DSCP rewrite is always disabled.

FM6000, Trident and Tomahawk, Trident II, and Helix platform switches provide a command that enables or disables DSCP rewrite for packets received on CoS trusted ports and untrusted ports. The new DSCP value is configurable, based on the data stream's traffic class, as specified by the traffic class-to-DSCP rewrite map.

These sections describe procedures for rewriting CoS and DSCP fields:

- [CoS Rewrite – Arad Platform Switches](#)
- [CoS and DSCP Rewrite – FM6000 Platform Switches](#)
- [CoS Rewrite – Petra Platform Switches](#)
- [CoS and DSCP Rewrite – Trident and Tomahawk Platform Switches](#)
- [CoS and DSCP Rewrite – Trident II and Helix Platform Switches](#)

9.1.1.1.4 Traffic Classes

Data stream distribution is based on their traffic classes. Data stream management varies by switch platform. Traffic classes are derived from these data stream, inbound port, and switch attributes:

- CoS field contents
- DSCP field contents
- Inbound port trust setting
- CoS default setting (Arad, Jericho, FM6000, Trident and Tomahawk, Trident II, and Helix platform switches)
- DSCP default setting (Arad, Jericho, FM6000, Trident and Tomahawk, and Trident II platform switches)
- Traffic class default setting (Petra platform switches)

When a port is configured to derive a data stream's traffic class from the CoS or DSCP value associated with the stream, the traffic class is determined from a conversion map.

- A CoS-to-traffic class map derives a traffic class from a CoS value.
- A DSCP-to-traffic class map derives a traffic class from a DSCP value.

Map entries are configurable through CLI commands. Default maps determine the traffic class value when CLI map entry commands are not configured. Default maps vary by switch platform.

These sections describe traffic class configuration procedures:

- [Traffic Class Derivations – Arad Platform Switches](#)
- [Traffic Class Derivations – Jericho Platform Switches](#)
- [Traffic Class Derivations – FM6000 Platform Switches](#)
- [Traffic Class Derivations – Petra Platform Switches](#)
- [Traffic Class Derivations – Trident and Tomahawk Platform Switches](#)
- [Traffic Class Derivations – Trident II and Helix Platform Switches](#)

9.1.1.2 Transmit Queues and Port Shaping

Transmit queues are logical partitions of an Ethernet port's egress bandwidth. Data streams are assigned to queues based on their traffic class, then sent as scheduled by port and transmit settings. Support varies by switch platform. A queue's label determines its priority: queues with the suffix "0" have the lowest priority.

Parameters that determine transmission schedules include:

- **Traffic class-to-transmit queue** mapping determines the transmit queue for transmitting data streams based on traffic class. The set of available transmit maps vary by switch platforms:
 - Arad, Jericho, FM6000, Trident II, and Helix platforms: one map for all unicast and multicast traffic.
 - Trident and Tomahawk platform: one map for unicast traffic and one map for multicast traffic.
 - Petra platform: one map for unicast traffic. Queue shaping is not available for multicast traffic.
- **Port shaping** specifies a port's maximum egress bandwidth.

- **Queue shaping** specifies a transmit queue's maximum egress bandwidth, and implementation varies by platform.
 - Trident and Tomahawk platform: queue shaping is configurable separately for unicast and multicast queues.
 - Trident II platform: queue shaping is configurable for transmit queues. Port shaping and queue shaping are supported only in store-and-forward switching mode.
 - Petra platform: queue shaping is not available for multicast traffic.
 - Helix platform: queue shaping is configurable for transmit queues.
 - FM6000 platform: switches do not support simultaneous port shaping and queue shaping. Enabling port shaping on an FM6000 switch disables queue shaping, regardless of the previous configuration.
- **Guaranteed bandwidth** guarantees the allocation of a specified bandwidth for a transmit queue. Guaranteed bandwidth is supported only on Trident II platforms.
- **Queue priority** specifies the priority at which a transmit queue is serviced. The switch defines two queue priority types:
 - *Strict priority queues* are serviced in the order of their priority rank - subject to each queue's configured maximum bandwidth. Data is not handled for a queue until all queues with higher priority are emptied or their transmission limit is reached. These queues typically carry low latency real time traffic and require highest available priority.
 - *Round robin queues* are serviced simultaneously subject to assigned bandwidth percentage and configured maximum bandwidth. All round robin queues have lower priority than strict priority queues. Round robin queues can be starved by strict priority queues.
- **Queue scheduling** determines how packets from different transmit queues are serviced to be sent out on the port.
- **Queue bandwidth allocation** specifies the time slice (percentage) assigned to a round robin queue, relative to all other round robin queues.

These sections describe transmit queue and port shaping configuration procedures:

- [Transmit Queues and Port Shaping – Arad Platform Switches](#)
- [Transmit Queues and Port Shaping – Jericho Platform Switches](#)
- [Transmit Queues and Port Shaping – FM6000 Platform Switches](#)
- [Transmit Queues and Port Shaping – Petra Platform Switches](#)
- [Transmit Queues and Port Shaping – Trident and Tomahawk Platform Switches](#)
- [Transmit Queues and Port Shaping – Trident II and Helix Platform Switches](#)

9.1.1.3 Explicit Congestion Notification (ECN)

Explicit Congestion Notification (ECN) is an IP and TCP extension that facilitates end-to-end network congestion notification without dropping packets. ECN recognizes early congestion and sets flags that signal affected hosts. Trident and Tomahawk, Trident II, and Helix platform switches extend ECN support to non-TCP packets.

ECN usage requires that it is supported and enabled by both endpoints. Although only unicast flows are modified by ECN markers, the multicast, broadcast, and unmarked unicast flows can affect network congestion and influence the indication of unicast packet congestion.

9.1.1.3.1 ECN Conceptual Overview

The ECN field in the IP header (bits 6 and 7 in the IPv4 TOS or IPv6 traffic class octet) advertises ECN capabilities:

- 00: Router does not support ECN.
- 10: Router supports ECN.
- 01: Router supports ECN.

- 11: Congestion encountered.

Networks typically signal congestion by dropping packets. After an ECN-capable host negotiates ECN, it signals impending congestion by marking the IP header of packets encountering the congestion instead of dropping the packets. The recipient echoes the congestion indication back to the sender, which reduces its transmission rate as if it had detected a dropped packet.

Switches support ECN for unicast queues through Weighted Random Early Detection (WRED), an Active Queue Management (AQM) algorithm that extends Random Early Detection (RED) to define multiple thresholds for an individual queue. WRED determines congestion by comparing average queue size with queue thresholds. Average queue size depends on the previous average and current queue size:

$$\text{average queue size} = (\text{old_avg} * (1 - 2^{(-\text{weight}))) + (\text{current_queue_size} * 2^{(-\text{weight}))}$$

where weight is the exponential weight factor used for averaging the queue size.

Packets are marked based on WRED as follows:

- If average queue size is below the minimum threshold, packets are queued as in normal operation without ECN.
- If average queue size is greater than the maximum threshold, packets are marked for congestion.
- If average queue size is between minimum and maximum queue threshold, packets are either queued or marked. The proportion of packets that are marked increases linearly from 0% at the minimum threshold to 100% at the maximum threshold.

Treatment of packets marked as not ECN capable varies by platform.

These sections describe ECN configuration procedures:

- [ECN Configuration – Arad Platform Switches](#)
- [ECN Configuration – Trident and Tomahawk Platform Switches](#)

9.1.1.4 ACL Policing

ACL policing monitors the ingress data rates for a particular class of traffic and performs the action configured when the traffic exceeds the user configured value. Therefore, it allows the user to control ingress bandwidth based on packet classification. The incoming traffic is metered and marked by the policing, and based on the metering results the actions are performed.

ACL policing uses a token bucket shaping algorithm for packet transmission. Packets are eligible for transmission when token count is positive, and when token count is negative the next packet will have to wait until the token count turns positive again. The tokens are renewed at 96ns time interval (Tc). The tokens are collected in the policer bucket up to a max burst size of 16KB, and any traffic beyond this shape rate and burst size is buffered in the shared memory. The packets are dropped if there is a memory overflow.

 **Note:** The policer bucket is refilled at a sweeper period of 0.333 millisecond. This is applicable for all the platforms.

For example, let us assume that shaping is not enabled, and the link is at 10 Gbps, that is 1.25 bytes/nsec. In such case a each refill cycle will add tokens worth 120 bytes. For a shape rate of 500 Mbps, each refill cycle will add 6 bytes. And for 64 byte worth of tokens we need around 11 refill cycles = 1us. A 64 byte packet coming immediately after a jumbo frame will have to wait longer compared to a jumbo frame coming after 64 byte packet.

Token size depends on the interface speed, following the last example:

- For 10 Gbps, each refill cycle will add tokens worth 120 bytes.
- For 1 Gbps, each refill cycle will add tokens worth 12 bytes.

At lower shaping rates (less than 10 Mbps), granularity and rounding errors may alter the actual shaping rate by 20% from the specified rate, and the rounding errors are much less at higher speeds.

For example, At 100 Mbps you will see 98.9 Mbps configured in hardware. User can use the `show qos interfaces` command to verify the interface speed.

The policing uses three types of traffic metering and coloring mechanisms.

- **Single Rate Two Color Marker**
- **Single Rate Three Color Marker**
- **Two Rate Three Color Marker**

Single Rate Two Color Marker

It meters the packet stream and marks packets based on committed burst size (bc) and excess burst size (be).

Single Rate Three Color Marker

It meters the packet stream and marks packets based on single rate committed information rate (cir), and committed burst size (bc) and excess burst size (be). The packets are marked in green if it does not exceed the set burst size, and marked in yellow if it does exceed the burst size but not the excess burst size, and marked red otherwise. The packets are marked in two color modes.

- **Color-blind Mode:** In color-blind mode the incoming packet color is ignored.
- **Color-aware Mode:** In color-aware mode it is assumed that incoming packet is colored by preceding entity. And, in color-aware mode, a packet never get better than it was. If the input color of the packet is green, it can be marked as green, yellow, or red. But if the input color is yellow, then it can be marked only yellow or red

Two Rate Three Color Marker

It meters the packet stream and marks its packets based on two rates, peak information rate (pir) and committed information rate (cir), and associated burst sizes (bc and be).The packet is marked red if rate exceeds 'pir', and yellow if it exceeds 'cir' but not 'pir' and marked green if rate is lower than 'cir'. The two rate mode is configured by setting four parameters pir, cir, bc, and be.

The ACL policing is supported on platforms specified in the table below.

ACL Policing Support Matrix

Platform Supported	ACL Policing	ACL Policing on LAG Interface
Trident	Yes	Yes
Trident II	Yes	Yes
Trident+	Yes	Yes
FM6000	Yes	Yes
Arad	Yes	Only Per-Port
Jericho	Yes	Yes
Helix	Yes	Yes
XP	Yes	Yes
Trident 3	Yes	Yes

Tomahawk	Yes	Yes
Tomahawk 2	Yes	Yes
Tofino	No	No

9.1.1.4.1 Configuring ACL Policing

The policer is applied to the class inside the policy map. Policy maps can contain one or more policy map classes, each with different match criteria and policers. The following is the default behavior on conditions and available policing actions:

- Police command creates a per-interface policer. If you attach per-interface policers to multiple ingress ports, each one polices the matched traffic on each ingress port separately. Per interface statistics gathered for conformed/allowed traffic and exceeded/dropped traffic
- When there is no policer configured within a class, all traffic is transmitted without any policing. If there are any actions configured, the configured actions are applied
 - conform-action (green): transmit (default)
 - exceed-action (yellow): drop (default)
 - violate-action (red): drop (default)
- The policer bucket is refilled at a sweeper period of 0.333 milliseconds, and the tokens in the policer bucket are renewed at 96ns time interval (Tc). This is applicable for all the platforms.

Steps to Configure ACL Policing

These commands set the CIR, burst size, and creates a class and applies the policing to the policy map:

1. Create a policy map.
2. Create a class-map.
3. Apply the policer to the policy map created.

Examples

- These commands configure the ACL policing for a policy map.

```
switch#configure terminal
switch(config)#policy-map [type qos] policy-name
switch(config-pmap)#class { class-name }
switch(config-pmap-c)#[no] police cir cir [{bps|kpbs|mbps}] bc
committed-burst-size [{bytes|kbytes|mbytes}]
```

- These commands configure ACL policing in single-rate, two-color mode.

```
switch(config)#class-map type qos match-any class1
switch(config-cmap-class1)#match ip access-group acl1
switch(config-cmap-class1)#exit

switch(config)#policy-map type quality-of-service policy1
switch(config-pmap)#class class1
switch(config-pmap-c)#police cir 512000 bc 96000
switch(config-pmap-c)#exit
switch(config-pmap)#
```

Displaying ACL Policing Information

Examples

- This command shows the contents of all policy maps on the switch.

```
switch(config)#show policy-map
Service-policy p

Class-map: c (match-any)
  Match: ip access-group name a
    police rate 1000 mbps burst-size 100 bytes
Class-map: class-default (match-any)
Service-policy p
Class-map: c (match-any)
  Match: ip access-group name a
    police rate 1000 mbps burst-size 100 bytes
Class-map: class-default (match-any)
```

- This command shows the interface-specific police counters for *interface Ethernet 1*.

```
switch(config)#show policy-map interface Ethernet 1 input counters
Service-policy input: policy1
Hardware programming status: Successful

Class-map: class1 (match-any) Match: ip access-group name acl1
Police cir 512000 bps bc 96000 bytes Conformed 4351 packets, 1857386
bytes
Conformed 2536 packets, 3384260 bytes

Class-map: class-default (match-any) matched packets: 0
```

- This command shows the counters associated with the policy map called *p1*.

```
switch(config)#show policy-map type qos p1 input counters
Service-policy input: p1 Class-map: c1 (match-any)
Match: ip access-group name a1
Police cir 512000 bps bc 96000 bytes Interface: Ethernet1
Conformed 4351 packets, 1857386 bytes
Exceeded 2536 packets, 3384260 bytes
Interface: Ethernet2
Conformed 2351 packets, 957386 bytes
Exceeded 1536 packets, 1384260 bytes
Class-map: class-default (match-any)
Matched packets : 3229
```

- This command shows the QoS policy map for *interface Ethernet 1*.

```
switch(config)#show policy-map interface Ethernet 1 input type qos
Interface: Ethernet 1 Service-policy input: policy1
Hardware programming status: Successful Class-map: class1 (match-any)
Match: ip access-group name acl1
Police cir 512000 bps bc 9000 bytes
Class-map: class2 (match-any)
Match: ip access-group name acl2 set dscp 2
Class-map: class3 (match-any) Match: ip access-group name acl3
Police cir 1280000 bps bc 9000 bytes
Class-map: class-default (match-any)
```

9.1.1.5 Quality of Service (QoS) Profiles

Quality of Service (QoS) profiles are sets of QoS configuration instructions defined and applied at the interface level. A QoS profile serves the traffic better by reducing disorder in the running configuration. QoS profiles can modify all interface-level QoS configurations, and are supported on fabric, Ethernet, and port-channel interfaces. Control-plane policies cannot be applied using QoS profiles. Because configuration can be applied through QoS profiles or directly at the interface level,

multiple configurations can be applied to the same interface. In such cases, QoS configurations with non-default values, whether configured through the CLI at the interface level or through a QoS profile, are given priority. In the case of multiple non-default values being configured, the interface-level CLI configuration is given priority.

Policy maps incorporating traffic resolution commands can also be applied by a QoS profile. If two policy maps are applied to the same interface (one through a QoS profile and another directly to the CLI).

Policy maps cannot be used on fabric interfaces. If a QoS profile which includes a policy map is applied to a fabric interface, a warning message will be displayed and the policy map will not be applied to the interface, but any additional supported configurations in the QoS profile will be applied. On SVIs and subinterfaces, QoS profiles are not supported, so policy maps must be applied directly through the CLI for these interfaces.



Note: For tx-queue configuration, conflicts between QoS profiles and configuration entered via the CLI are resolved at the tx-queue level and not at the tx-queue attribute level. If any non-default configuration has been entered for the tx-queue through the CLI, all tx-queue configuration included in the QoS profile is ignored.

9.1.2 QoS Configuration: Platform-Independent Features

9.1.2.1 Creating QoS Profiles

QoS profiles are created by using the `qos profile` command. This also places the switch in QoS profile configuration mode, where the QoS parameters applied to interfaces are configured. To delete a QoS profile from the running configuration, use the no form of the command.

Example

This command creates a QoS profile named **Test-Profile** and places the switch in QoS profile configuration mode for the profile.

```
switch(config)#qos profile Test-Profile
switch(config-qos-profile-Test-Profile)#
```

9.1.2.2 Configuring QoS Profiles

The parameters that a QoS profile applies to interfaces are configured in QoS profile configuration mode by issuing the same QoS configuration commands that are available in interface configuration mode. **QoS profile** configuration mode is a group change mode, and changes made in the mode are not saved until the mode is exited. To abandon all changes made while in the mode, use the **abort** command.

Example

These commands enter QoS profile configuration mode for a QoS profile named **Test Profile**, configure the CoS value and transmit queue, and save the changes to the profile.

```
switch(config)#qos profile Test-Profile
switch(config-qos-profile-Test-Profile)#qos cos 3
switch(config-qos-profile-Test-Profile)#priority-flow-control on
switch(config-qos-profile-Test-Profile)#exit
switch(config)#
```

These commands enter QoS profile configuration mode for a QoS profile named **Latency**, configure the maximum latency value for VOQ tail-drop threshold, and save the changes to the profile. The

latency value can be specified to a maximum of **50** ms. Both milliseconds and microseconds may be used.

```
switch(config)#qos profile Latency
switch(config-qos-profile-Latency)#tx-queue 3
switch(config-qos-profile-Latency)#latency maximum <1-50000> microseconds
switch(config-qos-profile-Latency)#latency maximum <1-50> milliseconds
switch(config-qos-profile-Latency)#exit
switch(config)#
```

9.1.2.3 Attaching Policy-Map to a QoS Profile

The `qos profile` command places the switch in QoS profile configuration mode. The profile applies the QoS configurations to Ethernet and Port-Channel, and even to the Fabric interfaces, if it exists. A profile specifies the policy-map and other QoS supported configurations. The policy-map is then attached to the QoS profile using `service-policy` command.

Profiles are created in QoS-profile configuration mode, then applied to an interface in interface configuration mode.

Examples

- This command places the switch in QoS profile configuration mode, the policy-map is then attached to the profile using `service-policy` command in this mode.

```
switch(config)#qos profile TP
switch(config-qos-profile-TP)#
```

- This command applies the policy-map to the QoS profile.

```
switch(config-qos-profile-TP)#service-policy type qos input PM-1
```

9.1.2.4 Applying a QoS profile on an Interface

The `service-profile` command applies a QoS profile to the configuration mode interface.

Example

This command applies the QoS profile TP to *interface Ethernet 13*.

```
switch(config)#interface ethernet 13
switch(config-if-Et13)#service-profile TP
```

9.1.2.5 Displaying the QoS Profile Information

The `show qos profile` command displays information about the QoS profiles configured and their parameters. To display the attribute of a specific profile, add the name of the profile. To display a list of configured QoS profiles and the interfaces on which they are configured, add the `summary` keyword.

Examples

- This command displays the configured profiles and their configuration.

```
switch#show qos profile
qos profile p
  qos cos 1
  no priority-flow-control pause watchdog
  priority-flow-control priority 1 no-drop
  priority-flow-control priority 2 no-drop
```

```
qos profile p2
qos cos 3
priority-flow-control priority 0 no-drop
```

- This command displays the contents of a specific profile.

```
switch#show qos profile p2
qos profile p2
qos cos 3
priority-flow-control priority 0 no-drop
```

- This command displays the interfaces on which each profile is applied.

```
switch#show qos profile summary
Qos Profile: p
Configured on: Et13,7
Fabric
Po12
Qos Profile: p2
Configured on: Et56
```

9.1.3 QoS Configuration: Arad Platform Switches

Implementing QoS on an Arad platform switch consists of configuring port trust settings, default port settings, default traffic classes, conversion maps, and transmit queues.

- [CoS and DSCP Port Settings – Arad Platform Switches](#)
- [Traffic Class Derivations – Arad Platform Switches](#)
- [CoS Rewrite – Arad Platform Switches](#)
- [Transmit Queues and Port Shaping – Arad Platform Switches](#)
- [ECN Configuration – Arad Platform Switches](#)
- [ACL Policing – Arad Platform Switches](#)



Note: QoS traffic policy is supported on Trident and Tomahawk, Trident II, FM6000, Arad, and Jericho.

9.1.3.1 CoS and DSCP Port Settings – Arad Platform Switches

[Port Settings – Trust Mode and Traffic Class](#) describes port trust and default port CoS and DSCP values.

Configuring Port Trust Settings

The `qos trust` command configures the QoS port trust mode for the configuration mode interface. Trust enabled ports use packet CoS or DSCP values to classify traffic. The port-trust default for switched ports is **CoS**. The port-trust default for routed ports is **DSCP**.

- `qos trust cos` specifies **CoS** as the port's port-trust mode.
- `qos trust dscp` specifies **DSCP** as the port's port-trust mode.
- `no qos trust` specifies **untrusted** as the port's port-trust mode.

The `show qos interfaces trust` command displays the trust mode of specified interfaces.

Example

- These commands configure and display the following trust modes:
 - Ethernet 3/5/1: dscp
 - Ethernet 3/5/2: untrusted
 - Ethernet 3/5/3: cos
 - Ethernet 3/5/4: default as a switched port
 - Ethernet 3/6/1: default as a routed port

```

switch(config)#interface ethernet 3/5/1
switch(config-if-Et3/5/1)#qos trust dscp
switch(config-if-Et3/5/1)#interface ethernet 3/5/2
switch(config-if-Et3/5/2)#no qos trust
switch(config-if-Et3/5/2)#interface ethernet 3/5/3
switch(config-if-Et3/5/3)#qos trust cos
switch(config-if-Et3/5/3)#interface ethernet 3/5/4
switch(config-if-Et3/5/4)#switchport
switch(config-if-Et3/5/4)#default qos trust
switch(config-if-Et3/5/4)#interface ethernet 3/6/1
switch(config-if-Et3/6/1)#no switchport
switch(config-if-Et3/6/1)#default qos trust
switch(config-if-Et3/6/1)#show qos interface ethernet 3/5/1 - 3/6/1
trust

```

Port	Trust Mode	
	Operational	Configured
Ethernet3/5/1	DSCP	DSCP
Ethernet3/5/2	UNTRUSTED	UNTRUSTED
Ethernet3/5/3	COS	COS
Ethernet3/5/4	COS	DEFAULT
Ethernet3/6/1	DSCP	DEFAULT

```

switch(config-if-Et3/6/1)#

```

Configuring Default Port Settings

Default CoS and DSCP values are assigned to each Ethernet and port channel interface. These commands specify the configuration mode interface commands specify the port's default CoS and DSCP values.

- `qos cos` configures a port's default CoS value.
- `qos dscp` configures a port's default DSCP value.

Example

```

These commands configure default CoS (4) and DSCP (44) values on
Ethernet
interface 3/6/2.
switch(config)#interface ethernet 3/6/2
switch(config-if-Et3/6/2)#qos cos 4
switch(config-if-Et3/6/2)#qos dscp 44
switch(config-if-Et3/6/2)#show active
interface Ethernet3/6/2
  qos cos 4
  qos dscp 44
switch(config-if-Et3/6/2)#show qos interfaces ethernet 3/6/2
Ethernet3/6/2:
  Trust Mode: COS
  Default COS: 4
  Default DSCP: 44

```



```
switch(config-if-Et3/6/2) #
```

9.1.3.2 Traffic Class Derivations – Arad Platform Switches

[Traffic Classes](#) describes traffic classes.

Traffic Class Derivation Source

The following table displays the source for deriving a data stream's traffic class.

Table 6: Traffic Class Derivation Source: Arad Platform Switches

	Untrusted	CoS Trusted	DSCP Trusted
Untagged Non-IP	Default CoS (port)	Default CoS (port)	Default DSCP (port)
Untagged IP	Default CoS (port)	Default CoS (port)	DSCP (packet)
Tagged Non-IP	Default CoS (port)	CoS (packet)	Default DSCP (port)
Tagged IP	Default CoS (port)	CoS (packet)	DSCP (packet)

[CoS and DSCP Port Settings – Arad Platform Switches](#) describes the default CoS and DSCP settings for each port.

Mapping CoS to Traffic Class

The `qos map cos` command assigns a traffic class to a list of CoS values. Multiple commands create a complete CoS to traffic class map. The switch uses this map to assign a traffic class to data packets on the basis of the packet's CoS field or the chip upon which it is received.

Example

This command assigns the traffic class of 5 to the classes of service 1, 3, 5, and 7.

```
switch(config) #qos map cos 1 3 5 7 to traffic-class 5
switch(config) #show qos maps
  Number of Traffic Classes supported: 8

  Cos-tc map:
  cos:  0  1  2  3  4  5  6  7
  -----
  tc:   1  5  2  5  4  5  6  5

switch(config) #
```

The following table displays the default CoS to Traffic Class map on Arad platform switches.

Table 7: Default CoS to Traffic Class Map: Arad Platform Switches

Inbound CoS	Untagged	0	1	2	3	4	5	6	7
Traffic Class	Derived: use default CoS as inbound	1	0	2	3	4	5	6	7

Mapping DSCP to Traffic Class

The `qos map dscp` command assigns a traffic class to a set of DSCP values. Multiple commands create a complete DSCP to traffic class map. The switch uses this map to assign a traffic class to data packets on the basis of the packet's DSCP field or the chip upon which it is received.

Example

This command assigns the traffic class of 0 to DSCP values of 12, 24, 41, and 44-47.

```
switch(config)#qos map dscp 12 24 41 44 45 46 47 to traffic-class 0
switch(config)#show qos maps
Number of Traffic Classes supported: 8

Dscp-tc map:
d1 : d2 0 1 2 3 4 5 6 7 8 9
-----
0 : 1 1 1 1 1 1 1 1 0 0
1 : 0 0 0 0 0 0 2 2 2 2
2 : 2 2 2 2 0 3 3 3 3 3
3 : 3 3 4 4 4 4 4 4 4 4
4 : 5 0 5 5 0 0 0 0 6 6
5 : 6 6 6 6 6 6 7 7 7 7
6 : 7 7 7 7

switch(config)#
```

The following table displays the default DSCP to traffic class map on Arad platform switches.

Table 8: Default DSCP to Traffic Class Map: Arad Platform Switches

Inbound DSCP	0-7	8-15	16-23	24-31	32-39	40-47	48-55	56-63
Traffic Class	1	0	2	3	4	5	6	7

9.1.3.3 CoS Rewrite – Arad Platform Switches

[Rewriting CoS and DSCP](#) describes the CoS rewrite functions.

Traffic Class to CoS Rewrite Map

The CoS rewrite value is configurable and based on a data stream's traffic class, as specified by the traffic class-CoS rewrite map. The `qos map traffic-class to cos` command assigns a CoS rewrite value to a list of traffic classes. Multiple commands create the complete traffic class-CoS rewrite map.

Example

This command assigns the CoS of two to traffic classes 1, 3, and 5.

```
switch(config)#qos map traffic-class 1 3 5 to cos 2
switch(config)#show qos map
Number of Traffic Classes supported: 8

Tc-cos map:
tc: 0 1 2 3 4 5 6 7
-----
cos: 1 2 2 2 4 2 6 7
```

```
switch(config)#
```

The following table displays the default Traffic Class to CoS rewrite value map on Arad platform switches.

Table 9: Default Traffic Class to CoS Rewrite Value Map: Arad Platform Switches

Traffic Class	0	1	2	3	4	5	6	7
CoS Rewrite Value	1	0	2	3	4	5	6	7

Traffic Class to DSCP Rewrite Map

DSCP rewrite is always disabled on Arad platform switches.

9.1.3.4 Transmit Queues and Port Shaping – Arad Platform Switches

[Transmit Queues and Port Shaping](#) describes transmit queues and port shaping.

Arad platform switches provide 16 physical queues for each egress port: eight unicast and eight multicast queues. Data is scheduled to the physical queues based on transmit queue assignments.

Multicast queue capacity that remains after multicast traffic is serviced is available for unicast traffic of a corresponding priority. Similarly, unicast queue capacity that remains after unicast traffic is serviced is available for overflow multicast traffic. Under conditions of unicast and multicast congestion, egress traffic is evenly split between unicast and multicast traffic.

A data stream's traffic class determines the transmit queue it uses. The switch defines a single traffic class–transmit queue map for unicast and multicast traffic on all Ethernet and port channel interfaces. The [show qos maps](#) command displays the traffic class–transmit queue map.

The following table displays the default traffic class to transmit queue map on Arad platform switches.

Table 10: Default Traffic Class to Transmit Queue Map: Arad Platform Switches

Traffic Class	0	1	2	3	4	5	6	7
Transmit Queue	0	1	2	3	4	5	6	7

Transmit queue parameters are configured in tx-queue configuration command mode, which is entered from interface-ethernet configuration mode.

Mapping Traffic Classes to a Transmit Queue

The [qos map traffic-class to tx-queue](#) command assigns traffic classes to a transmit queue. Multiple commands complete the traffic class-transmit queue map. Traffic class 7 and transmit queue 7 are always mapped to each other. This association is not editable.

Example

These commands assign traffic classes of **1**, **3**, and **5** to **transmit queue 1**, traffic classes **2**, **4**, and **6** to transmit queue **2**, and traffic class **0** to transmit queue **0**, then display the resultant map.

```
switch(config)#qos map traffic-class 1 3 5 to tx-queue 1
switch(config)#qos map traffic-class 2 4 6 to tx-queue 2
switch(config)#qos map traffic-class 0 to tx-queue 0
switch(config)#show qos maps
  Number of Traffic Classes supported: 8
  Number of Transmit Queues supported: 8
```

```

Tc - tx-queue map:
tc:          0  1  2  3  4  5  6  7
-----
tx-queue:   0  1  2  1  2  1  2  7

switch(config)#

```

Entering Tx-Queue Configuration Mode

The `tx-queue` (Arad/Jericho) command places the switch in tx-queue configuration mode to configure a transmit queue on the configuration mode interface. Tx-queue 7 is not configurable. The `show qos interfaces` displays the transmit queue configuration for a specified port.

Example

This command enters Tx-queue configuration mode for **transmit queue 4** of **interface Ethernet 3/3/3**.

```

switch(config)#interface ethernet 3/3/3
switch(config-if-Et3/3/3)#tx-queue 4
switch(config-if-Et3/3/3-txq-4)#

```

Configuring the Shape Rate – Port and Transmit Queues

A port's shape rate specifies its maximum outbound traffic bandwidth. A transmit queue's shape rate specifies the queue's maximum outbound bandwidth. Shape rate commands specify data rates in kbps.

- To configure a port's shape rate, enter `shape rate (Interface – Arad/Jericho)` from the port's interface configuration mode.
- To configure a transmit queue's shape rate, enter `shape rate (Tx-queue – Arad/Jericho)` from the queue's tx-queue configuration mode.

Examples

- This command configures a port shape rate of **5 Gbps** on **interface Ethernet 3/5/1**.

```

switch(config)#interface ethernet 3/5/1
switch(config-if-Et3/5/1)#shape rate 5000000
switch(config-if-Et3/5/1)#show qos interfaces ethernet 3/5/1
Ethernet3/5/1:

  Port shaping rate: 5000012 / 5000000 kbps

  Tx      Bandwidth      Shape Rate      Priority  ECN
  Queue   (percent)           (units)
  -----
  7       - / -             - / -   ( - )   SP / SP   D

switch(config-if-Et3/5/1)#

```

- These commands configure a shape rate of **1 Gbps** on transmit queues **3** and **4** of **interface Ethernet 3/4/1**.

```

switch(config)#interface ethernet 3/4/1
switch(config-if-Et3/4/1)#tx-queue 4
switch(config-if-Et3/4/1-txq-4)#shape rate 1000000 kbps
switch(config-if-Et3/4/1-txq-4)#tx-queue 3
switch(config-if-Et3/4/1-txq-3)#shape rate 1000000 kbps
switch(config-if-Et3/4/1-txq-3)#show qos interface ethernet 3/4/1
Ethernet3/4/1:

```

```

Port shaping rate: disabled

```

Tx Queue	Bandwidth (percent)	Shape Rate (units)	Priority	ECN
7	- / -	- / - (-)	SP / SP	D
6	- / -	- / - (-)	SP / SP	D
5	- / -	- / - (-)	SP / SP	D
4	- / -	999 / 1000 (Mbps)	SP / SP	D
3	- / -	999 / 1000 (Mbps)	SP / SP	D
2	- / -	- / - (-)	SP / SP	D
1	- / -	- / - (-)	SP / SP	D
0	- / -	- / - (-)	SP / SP	D

```

switch(config-if-Et3/4/1-txq-3)#

```

Configuring Queue Priority

The `priority (Arad/Jericho)` command configures a transmit queue's priority type:

- The `priority strict` command configures the queue as a strict priority queue.
- The `no priority` command configures the queue as a round robin queue.

A queue's configuration as **round robin** also applies to all lower priority queues regardless of other configuration statements.

The `bandwidth percent (Arad/Jericho)` command configures a round robin queue's bandwidth share. The cumulative operational bandwidth of all round robin queues is always less than or equal to 100%. If the cumulative configured bandwidth is greater than 100%, each port's operational bandwidth is its configured bandwidth divided by the cumulative configured bandwidth.

Examples

- These commands configure queues **0** through **3** (*interface Ethernet 3/5/1*) as round robin, then allocate bandwidth for three queues at **30%** and one queue at **10%**.

The `no priority` statement for queue **3** also configures queues **0**, **1**, and **2** as round robin queues. Removing this statement reverts the other queues to **strict priority** type unless *running-config* contains a `no priority` statement for one of these queues.

```

switch(config)#interface ethernet 3/5/1
switch(config-if-Et3/5/1)#tx-queue 3
switch(config-if-Et3/5/1-txq-3)#no priority
switch(config-if-Et3/5/1-txq-3)#bandwidth percent 10
switch(config-if-Et3/5/1-txq-2)#tx-queue 2
switch(config-if-Et3/5/1-txq-2)#bandwidth percent 30
switch(config-if-Et3/5/1-txq-1)#tx-queue 1
switch(config-if-Et3/5/1-txq-1)#bandwidth percent 30
switch(config-if-Et3/5/1-txq-0)#tx-queue 0
switch(config-if-Et3/5/1-txq-0)#bandwidth percent 30
switch(config-if-Et3/5/1-txq-0)#show qos interfaces ethernet 3/5/1
Ethernet3/5/1:

```

Tx Queue	Bandwidth (percent)	Shape Rate (units)	Priority	ECN
7	- / -	- / - (-)	SP / SP	D
6	- / -	- / - (-)	SP / SP	D
5	- / -	- / - (-)	SP / SP	D
4	- / -	- / - (-)	SP / SP	D
3	10 / 10	- / - (-)	RR / RR	D
2	30 / 30	- / - (-)	RR / SP	D
1	30 / 30	- / - (-)	RR / SP	D

```

0      30 / 30      - / -      ( - )      RR / SP      D
switch(config-if-Et3/5/1-txq-0)#

```

- Changing the bandwidth percentage for queue **3** to **30** changes the operational bandwidth of each queue to its configured bandwidth divided by **120%** (10%+20%+30%+60%).

```

switch(config-if-Et3/5/1-txq-0)#tx-queue 3
switch(config-if-Et3/5/1-txq-3)#bandwidth percent 30
switch(config-if-Et3/5/1-txq-3)#show qos interfaces ethernet 3/5/1
Ethernet3/5/1:

```

Port shaping rate: disabled

Tx Queue	Bandwidth (percent)	Shape Rate (units)	Priority	ECN
7	- / -	- / - (-)	SP / SP	D
6	- / -	- / - (-)	SP / SP	D
5	- / -	- / - (-)	SP / SP	D
4	- / -	- / - (-)	SP / SP	D
3	24 / 30	- / - (-)	RR / RR	D
2	24 / 30	- / - (-)	RR / SP	D
1	24 / 30	- / - (-)	RR / SP	D
0	24 / 30	- / - (-)	RR / SP	D

Note: Values are displayed as Operational/Configured

```

switch(config-if-Et3/5/1-txq-3)#

```

9.1.3.5 ECN Configuration – Arad Platform Switches

[Explicit Congestion Notification \(ECN\)](#) describes Explicit Congestion Notification (ECN).

ECN is independently configurable on all egress queues of each Ethernet interface. ECN settings for Port-Channels are applied on each of the channel's member Ethernet interfaces. Average queue length is tracked for transmit queues. When it reaches maximum threshold, all subsequent packets are marked.

Although the switch does not limit the number of queues that can be configured for ECN, hardware table limitations restrict the number of queues that can simultaneously implement ECN.

The [random-detect ecn \(Arad/Jericho\)](#) command enables ECN marking for the configuration mode unicast transmit queue and specifies threshold queue sizes.

Example

These commands enable ECN marking of unicast packets from **unicast transmit queue 4** of **interface Ethernet 3/5/1**, setting thresholds at **128** kbytes and **1280** kbytes.

```

switch(config)#interface ethernet 3/5/1
switch(config-if-Et3/5/1)#tx-queue 4
switch(config-if-Et3/5/1-txq-4)#random-detect ecn minimum-threshold 128
kbytes
maximum-threshold 1280 kbyte
switch(config-if-Et3/5/1-txq-4)#show active
interface Ethernet3/5/1
    tx-queue 4
        random-detect ecn minimum-threshold 128 kbytes maximum-threshold
        1280 kbytes
switch(config-if-Et3/5/1-txq-4)#

```

9.1.3.6 ACL Policing – Arad Platform Switches

[ACL Policing](#) describes ACL policing.

Implementing ACL policing consists of configuring the following:

- policy-map settings
- class-name
- committed information rate (CIR) the data speed committed to any given circuit regardless of the number of users
- burst size the maximum burst size in bytes the network commits to moving under normal conditions

The default unit for the metering rate CIR is bits per second; the default unit for the burst size is bytes.

The policer is applied to the class inside the policy map. Policy maps can contain one or more policy map classes, each with different match criteria and policer.

Default behavior and available policing actions are as follows:

- Policy map can be applied on multiple interfaces. Interfaces on the same chip will share the policer. (Applicable for Arad only.)
- If there is no policer configured within a class, all traffic is transmitted without any policing.
- If there are any actions configured, the configured actions are applied:
 - Conform-action (green): transmit (default)
 - Violate-action (red): drop (default)

Example

These commands configure ACL policing in single-rate, two-color mode.

```
switch(config)#class-map type qos match-any class1
switch(config-cmap-class1)#match ip access-group acl1
switch(config-cmap-class1)#exit
switch(config)#policy-map type quality-of-service policy1
switch(config-policy1)#class class1
switch(config-policy1-class1)#police cir 512000 bc 96000
switch(config-policy1-class1)#exit
switch(config-policy1)#exit
switch(config)#
```

Displaying ACL Policing Information

Examples

- This command shows the contents of all policy maps on the switch.

```
switch(config)#show policy-map
Service-policy policy1

Class-map: class1 (match-any)
Match: ip access-group name acl1
Police cir 512000 bps bc 96000 bytes

Class-map: class-default (match-any)
switch(config)#
```

- This command shows the interface-specific police counters for *interface Ethernet 1*.

```
switch(config)#show policy-map interface Ethernet 1 input counters
Service-policy input: policy1
```

```

Hardware programming status: Successful

Class-map: class1 (match-any) Match: ip access-group name acl1
Police cir 512000 bps bc 96000 bytes Conformed 4351 packets, 1857386
bytes
Conformed 2536 packets, 3384260 bytes

Class-map: class-default (match-any) matched packets: 0

switch(config)#

```

- This command shows the counters associated with the policy map called **p1**.

```

switch(config)#show policy-map type qos p1 input counters
Service-policy input: p1 Class-map: c1 (match-any)
Match: ip access-group name a1
Police cir 512000 bps bc 96000 bytes Interface: Ethernet1
Conformed 4351 packets, 1857386 bytes
Exceeded 2536 packets, 3384260 bytes
Interface: Ethernet2
Conformed 2351 packets, 957386 bytes
Exceeded 1536 packets, 1384260 bytes
Class-map: class-default (match-any)
Matched packets : 3229

switch(config)#

```

- This command shows the QoS policy map for **interface Ethernet 1**.

```

switch(config)#show policy-map interface Ethernet 1 input type qos
Interface: Ethernet 1 Service-policy input: policy1
Hardware programming status: Successful Class-map: class1 (match-any)
Match: ip access-group name acl1
Police cir 512000 bps bc 9000 bytes
Class-map: class2 (match-any)
Match: ip access-group name acl2 set dscp 2
Class-map: class3 (match-any) Match: ip access-group name acl3
Police cir 1280000 bps bc 9000 bytes
Class-map: class-default (match-any)

switch(config)#

```

9.1.4 QoS Configuration: Jericho Platform Switches

Implementing QoS on an Jericho platform switch consists of configuring port trust settings, default port settings, default traffic classes, conversion maps, and transmit queues.

- [CoS and DSCP Port Settings – Jericho Platform Switches](#)
- [Traffic Class Derivations – Jericho Platform Switches](#)
- [CoS Rewrite – Jericho Platform Switches](#)
- [Transmit Queues and Port Shaping – Jericho Platform Switches](#)
- [ACL Policing – Jericho Platform Switches](#)

 **Note:** QoS traffic policy is supported on Trident and Tomahawk, Trident II, FM6000, Arad, and Jericho.

9.1.4.1 CoS and DSCP Port Settings – Jericho Platform Switches

[Port Settings – Trust Mode and Traffic Class](#) describes port trust and default port CoS and DSCP values.

Configuring Port Trust Settings

The `qos trust` command configures the QoS port trust mode for the configuration mode interface. Trust enabled ports use packet CoS or DSCP values to classify traffic. The port-trust default for switched ports is **CoS**. The port-trust default for routed ports is **DSCP**.

- `qos trust cos` specifies **CoS** as the port's port-trust mode.
- `qos trust dscp` specifies **DSCP** as the port's port-trust mode.
- `no qos trust` specifies **untrusted** as the port's port-trust mode.

The `show qos interfaces trust` command displays the trust mode of specified interfaces.

Example

- These commands configure and display the following trust modes:

- Ethernet 3/5/1: dscp
- Ethernet 3/5/2: untrusted
- Ethernet 3/5/3: cos
- Ethernet 3/5/4: default as a switched port
- Ethernet 3/6/1: default as a routed port

```
switch(config)#interface ethernet 3/5/1
switch(config-if-Et3/5/1)#qos trust dscp
switch(config-if-Et3/5/1)#interface ethernet 3/5/2
switch(config-if-Et3/5/2)#no qos trust
switch(config-if-Et3/5/2)#interface ethernet 3/5/3
switch(config-if-Et3/5/3)#qos trust cos
switch(config-if-Et3/5/3)#interface ethernet 3/5/4
switch(config-if-Et3/5/4)#switchport
switch(config-if-Et3/5/4)#default qos trust
switch(config-if-Et3/5/4)#interface ethernet 3/6/1
switch(config-if-Et3/6/1)#no switchport
switch(config-if-Et3/6/1)#default qos trust
switch(config-if-Et3/6/1)#show qos interface ethernet 3/5/1 - 3/6/1
trust
Port                                     Trust Mode
Operational                               Configured
-----
Ethernet3/5/1                             DSCP                               DSCP
Ethernet3/5/2                             UNTRUSTED                          UNTRUSTED
Ethernet3/5/3                             COS                                 COS
Ethernet3/5/4                             COS                                 DEFAULT
Ethernet3/6/1                             DSCP                               DEFAULT

switch(config-if-Et3/6/1)#
```

Configuring Default Port Settings

Default CoS and DSCP values are assigned to each Ethernet and port channel interface. These commands specify the configuration mode interface commands specify the port's default CoS and DSCP values.

- `qos cos` configures a port's default CoS value.
- `qos dscp` configures a port's default DSCP value.

Example

These commands configure default CoS (**4**) and DSCP (**44**) values on *interface Ethernet 3/6/2*.

```
switch(config)#interface ethernet 3/6/2
switch(config-if-Et3/6/2)#qos cos 4
```

```

switch(config-if-Et3/6/2) #qos dscp 44
switch(config-if-Et3/6/2) #show active
interface Ethernet3/6/2
  qos cos 4
  qos dscp 44
switch(config-if-Et3/6/2) #show qos interfaces ethernet 3/6/2
Ethernet3/6/2:
  Trust Mode: COS
  Default COS: 4
  Default DSCP: 44

switch(config-if-Et3/6/2) #

```

9.1.4.2 Traffic Class Derivations – Jericho Platform Switches

[Traffic Classes](#) describes traffic classes.

Traffic Class Derivation Source

The following table displays the source for deriving a data stream’s traffic class on Jericho platform switches.

Table 11: Traffic Class Derivation Source: Jericho Platform Switches

	Untrusted	CoS Trusted	DSCP Trusted
Untagged Non-IP	Default CoS (port)	Default CoS (port)	Default DSCP (port)
Untagged IP	Default CoS (port)	Default CoS (port)	DSCP (packet)
Tagged Non-IP	Default CoS (port)	CoS (packet)	Default DSCP (port)
Tagged IP	Default CoS (port)	CoS (packet)	DSCP (packet)

[CoS and DSCP Port Settings – Arad Platform Switches](#) describes the default CoS and DSCP settings for each port.

Mapping CoS to Traffic Class

The `qos map cos` command assigns a traffic class to a list of CoS values. Multiple commands create a complete CoS to traffic class map. The switch uses this map to assign a traffic class to data packets on the basis of the packet’s CoS field or the chip upon which it is received.

Example

This command assigns the traffic class of **5** to the classes of service **1, 3, 5, and 7**.

```

switch(config) #qos map cos 1 3 5 7 to traffic-class 5
switch(config) #show qos maps
  Number of Traffic Classes supported: 8

  Cos-tc map:
  cos:  0  1  2  3  4  5  6  7
  -----
  tc:   1  5  2  5  4  5  6  5

switch(config) #

```

The following table displays the default CoS to Traffic Class map on Jericho platform switches.

Table 12: Default CoS to Traffic Class Map: Jericho Platform Switches

Inbound CoS	Untagged	0	1	2	3	4	5	6	7
Traffic Class	Derived: use default CoS as inbound	1	0	2	3	4	5	6	7

Mapping DSCP to Traffic Class

The `qos map dscp` command assigns a traffic class to a set of DSCP values. Multiple commands create a complete DSCP to traffic class map. The switch uses this map to assign a traffic class to data packets on the basis of the packet's DSCP field or the chip upon which it is received.

Example

This command assigns the traffic class of 0 to DSCP values of **12, 24, 41, and 44-47**.

```
switch(config)#qos map dscp 12 24 41 44 45 46 47 to traffic-class 0
switch(config)#show qos maps
    Number of Traffic Classes supported: 8

Dscp-tc map:
d1 : d2 0 1 2 3 4 5 6 7 8 9
-----
0 :    1 1 1 1 1 1 1 1 0 0
1 :    0 0 0 0 0 0 2 2 2 2
2 :    2 2 2 2 0 3 3 3 3 3
3 :    3 3 4 4 4 4 4 4 4 4
4 :    5 0 5 5 0 0 0 0 6 6
5 :    6 6 6 6 6 6 7 7 7 7
6 :    7 7 7 7

switch(config)#
```

The following table displays the default DSCP to traffic class map on Jericho platform switches.

Table 13: Default DSCP to Traffic Class Map: Jericho Platform Switches

Inbound DSCP	0-7	8-15	16-23	24-31	32-39	40-47	48-55	56-63
Traffic Class	1	0	2	3	4	5	6	7

9.1.4.3 CoS Rewrite – Jericho Platform Switches

[Rewriting CoS and DSCP](#) describes the CoS rewrite functions.

Traffic Class to CoS Rewrite Map

The CoS rewrite value is configurable and based on a data stream's traffic class, as specified by the traffic class-CoS rewrite map. The `qos map traffic-class to cos` command assigns a CoS rewrite value to a list of traffic classes. Multiple commands create the complete traffic class-CoS rewrite map.

Example

This command assigns the CoS of two to traffic classes **1, 3, and 5**.

```
switch(config)#qos map traffic-class 1 3 5 to cos 2
switch(config)#show qos map
    Number of Traffic Classes supported: 8
```

```
Tc-cos map:
tc:  0  1  2  3  4  5  6  7
-----
cos:  1  2  2  2  4  2  6  7
```

```
switch(config)#
```

The following table displays the default Traffic Class to CoS rewrite value map on Jericho platform switches.

Table 14: Default Traffic Class to CoS Rewrite Value Map: Jericho Platform Switches

Traffic Class	0	1	2	3	4	5	6	7
CoS Rewrite Value	1	0	2	3	4	5	6	7

Traffic Class to DSCP Rewrite Map

DSCP rewrite is always disabled on Jericho platform switches.

9.1.4.4 Transmit Queues and Port Shaping – Jericho Platform Switches

[Transmit Queues and Port Shaping](#) describes transmit queues and port shaping.

Jericho platform switches provide 16 physical queues for each egress port: eight unicast and eight multicast queues. Data is scheduled to the physical queues based on transmit queue assignments.

Multicast queue capacity that remains after multicast traffic is serviced is available for unicast traffic of a corresponding priority. Similarly, unicast queue capacity that remains after unicast traffic is serviced is available for overflow multicast traffic. Under conditions of unicast and multicast congestion, egress traffic is evenly split between unicast and multicast traffic.

A data stream's traffic class determines the transmit queue it uses. The switch defines a single traffic class–transmit queue map for unicast and multicast traffic on all Ethernet and port channel interfaces. The [show qos maps](#) command displays the traffic class–transmit queue map.

The following table displays the default traffic class to transmit queue map on Jericho platform switches.

Table 15: Default Traffic Class to Transmit Queue Map: Jericho Platform Switches

Traffic Class	0	1	2	3	4	5	6	7
Transmit Queue	0	1	2	3	4	5	6	7

Transmit queue parameters are configured in tx-queue configuration command mode, which is entered from interface-ethernet configuration mode.

Mapping Traffic Classes to a Transmit Queue

The [qos map traffic-class to tx-queue](#) command assigns traffic classes to a transmit queue. Multiple commands complete the traffic class-transmit queue map. Traffic class 7 and transmit queue 7 are always mapped to each other. This association is not editable.

Example

These commands assign traffic classes of **1, 3, and 5** to **transmit queue 1**, traffic classes **2, 4, and 6** to **transmit queue 2**, and **traffic class 0** to **transmit queue 0**, then display the resultant map.

```
switch(config)#qos map traffic-class 1 3 5 to tx-queue 1
switch(config)#qos map traffic-class 2 4 6 to tx-queue 2
switch(config)#qos map traffic-class 0 to tx-queue 0
switch(config)#show qos maps
    Number of Traffic Classes supported: 8
    Number of Transmit Queues supported: 8

Tc - tx-queue map:
tc:          0  1  2  3  4  5  6  7
-----
tx-queue:   0  1  2  1  2  1  2  7

switch(config)#
```

Entering Tx-Queue Configuration Mode

The `tx-queue (Arad/Jericho)` command places the switch in tx-queue configuration mode to configure a transmit queue on the configuration mode interface. **Tx-queue 7** is not configurable. The `show qos interfaces` displays the transmit queue configuration for a specified port.

Example

This command enters Tx-queue configuration mode for **transmit queue 4** of **interface Ethernet 3/3/3**.

```
switch(config)#interface ethernet 3/3/3
switch(config-if-Et3/3/3)#tx-queue 4
switch(config-if-Et3/3/3-txq-4)#
```

Configuring the Shape Rate – Port and Transmit Queues

A port's shape rate specifies its maximum outbound traffic bandwidth. A transmit queue's shape rate specifies the queue's maximum outbound bandwidth. Shape rate commands specify data rates in kbps.

- To configure a port's shape rate, enter `shape rate (Interface – Arad/Jericho)` from the port's interface configuration mode.
- To configure a transmit queue's shape rate, enter `shape rate (Tx-queue – Arad/Jericho)` from the queue's tx-queue configuration mode.

Examples

- This command configures a port shape rate of **5 Gbps** on **interface Ethernet 3/5/1**.

```
switch(config)#interface ethernet 3/5/1
switch(config-if-Et3/5/1)#shape rate 5000000
switch(config-if-Et3/5/1)#show qos interfaces ethernet 3/5/1
Ethernet3/5/1:

    Port shaping rate: 5000012 / 5000000 kbps

Tx   Bandwidth   Shape Rate   Priority   ECN
Queue (percent)   (units)
-----
  7   - / -       - / -       ( - )     SP / SP   D

switch(config-if-Et3/5/1)#
```

- These commands configure a shape rate of **1 Gbps** on transmit queues **3** and **4** on **interface Ethernet 3/4/1**.

```
switch(config)#interface ethernet 3/4/1
switch(config-if-Et3/4/1)#tx-queue 4
switch(config-if-Et3/4/1-txq-4)#shape rate 1000000 kbps
switch(config-if-Et3/4/1-txq-4)#tx-queue 3
switch(config-if-Et3/4/1-txq-3)#shape rate 1000000 kbps
switch(config-if-Et3/4/1-txq-3)#show qos interface ethernet 3/4/1
Ethernet3/4/1:
```

Port shaping rate: disabled

Tx Queue	Bandwidth (percent)	Shape Rate (units)	Priority	ECN
7	- / -	- / - (-)	SP / SP	D
6	- / -	- / - (-)	SP / SP	D
5	- / -	- / - (-)	SP / SP	D
4	- / -	999 / 1000 (Mbps)	SP / SP	D
3	- / -	999 / 1000 (Mbps)	SP / SP	D
2	- / -	- / - (-)	SP / SP	D
1	- / -	- / - (-)	SP / SP	D
0	- / -	- / - (-)	SP / SP	D

```
switch(config-if-Et3/4/1-txq-3)#
```

Configuring Queue Priority

The `priority (Arad/Jericho)` command configures a transmit queue's priority type:

- The `priority strict` command configures the queue as a strict priority queue.
- The `no priority` command configures the queue as a round robin queue.

A queue's configuration as **round robin** also applies to all lower priority queues regardless of other configuration statements.

The `bandwidth percent (Arad/Jericho)` command configures a round robin queue's bandwidth share. The cumulative operational bandwidth of all round robin queues is always less than or equal to 100%. If the cumulative configured bandwidth is greater than 100%, each port's operational bandwidth is its configured bandwidth divided by the cumulative configured bandwidth.

Examples

- These commands configure queues **0** through **3** (**interface Ethernet 3/5/1**) as round robin, then allocate bandwidth for three queues at **30%** and one queue at **10%**.

The `no priority` statement for queue **3** also configures queues **0**, **1**, and **2** as round robin queues. Removing this statement reverts the other queues to **strict priority** type unless **running-config** contains a `no priority` statement for one of these queues.

```
switch(config)#interface ethernet 3/5/1
switch(config-if-Et3/5/1)#tx-queue 3
switch(config-if-Et3/5/1-txq-3)#no priority
switch(config-if-Et3/5/1-txq-3)#bandwidth percent 10
switch(config-if-Et3/5/1-txq-3)#tx-queue 2
switch(config-if-Et3/5/1-txq-2)#bandwidth percent 30
switch(config-if-Et3/5/1-txq-2)#tx-queue 1
switch(config-if-Et3/5/1-txq-1)#bandwidth percent 30
switch(config-if-Et3/5/1-txq-1)#tx-queue 0
switch(config-if-Et3/5/1-txq-0)#bandwidth percent 30
switch(config-if-Et3/5/1-txq-0)#show qos interfaces ethernet 3/5/1
```

```
Ethernet3/5/1:
```

Tx Queue	Bandwidth (percent)	Shape Rate (units)	Priority	ECN
7	- / -	- / - (-)	SP / SP	D
6	- / -	- / - (-)	SP / SP	D
5	- / -	- / - (-)	SP / SP	D
4	- / -	- / - (-)	SP / SP	D
3	10 / 10	- / - (-)	RR / RR	D
2	30 / 30	- / - (-)	RR / SP	D
1	30 / 30	- / - (-)	RR / SP	D
0	30 / 30	- / - (-)	RR / SP	D

```
switch(config-if-Et3/5/1-txq-0)#
```

- Changing the bandwidth percentage for queue **3** to **30** changes the operational bandwidth of each queue to its configured bandwidth divided by **120%** (10%+20%+30%+60%).

```
switch(config-if-Et3/5/1-txq-0)#tx-queue 3
switch(config-if-Et3/5/1-txq-3)#bandwidth percent 30
switch(config-if-Et3/5/1-txq-3)#show qos interfaces ethernet 3/5/1
Ethernet3/5/1:
```

```
Port shaping rate: disabled
```

Tx Queue	Bandwidth (percent)	Shape Rate (units)	Priority	ECN
7	- / -	- / - (-)	SP / SP	D
6	- / -	- / - (-)	SP / SP	D
5	- / -	- / - (-)	SP / SP	D
4	- / -	- / - (-)	SP / SP	D
3	24 / 30	- / - (-)	RR / RR	D
2	24 / 30	- / - (-)	RR / SP	D
1	24 / 30	- / - (-)	RR / SP	D
0	24 / 30	- / - (-)	RR / SP	D

```
Note: Values are displayed as Operational/Configured
```

```
switch(config-if-Et3/5/1-txq-3)#
```

9.1.4.5 ACL Policing – Jericho Platform Switches

[ACL Policing](#) describes ACL policing.

Implementing ACL policing consists of configuring the following:

- **policy-map settings**
- **class-name**
- **committed information rate (CIR)** the data speed committed to any given circuit regardless of the number of users
- **burst size** the maximum burst size in bytes the network commits to moving under normal conditions

The default unit for the metering rate CIR is bits per second; the default unit for the burst size is bytes.

The policer is applied to the class inside the policy map. Policy maps can contain one or more policy map classes, each with different match criteria and policer.

Default behavior and available policing actions are as follows:

- Policy map can be applied on multiple interfaces. Interfaces on the same chip will share the policer. (Applicable for Arad and Jericho only.)
- If there is no policer configured within a class, all traffic is transmitted without any policing.
- If there are any actions configured, the configured actions are applied:
 - Conform-action (green): transmit (default)
 - Violate-action (red): drop (default)

Example

These commands configure ACL policing in single-rate, two-color mode.

```
switch(config)#class-map type qos match-any class1
switch(config-cmap-class1)#match ip access-group acl1
switch(config-cmap-class1)#exit
switch(config)#policy-map type quality-of-service policy1
switch(config-policy1)#class class1
switch(config-policy1-class1)#police cir 512000 bc 96000
switch(config-policy1-class1)#exit
switch(config-policy1)#exit
switch(config)#
```

Displaying ACL Policing Information

Examples

- This command shows the contents of all policy maps on the switch.

```
switch(config)#show policy-map
Service-policy policy1

Class-map: class1 (match-any)
Match: ip access-group name acl1
Police cir 512000 bps bc 96000 bytes

Class-map: class-default (match-any)
switch(config)#
```

- This command shows the interface-specific police counters for *interface Ethernet 1*.

```
switch(config)#show policy-map interface Ethernet 1 input counters
Service-policy input: policy1
Hardware programming status: Successful

Class-map: class1 (match-any) Match: ip access-group name acl1
Police cir 512000 bps bc 96000 bytes Conformed 4351 packets, 1857386
bytes
Conformed 2536 packets, 3384260 bytes

Class-map: class-default (match-any) matched packets: 0

switch(config)#
```

- This command shows the counters associated with the policy map called *p1*.

```
switch(config)#show policy-map type qos p1 input counters
Service-policy input: p1 Class-map: c1 (match-any)
Match: ip access-group name a1
Police cir 512000 bps bc 96000 bytes Interface: Ethernet1
Conformed 4351 packets, 1857386 bytes
Exceeded 2536 packets, 3384260 bytes
```



```

Interface: Ethernet2
Conformed 2351 packets, 957386 bytes
Exceeded 1536 packets, 1384260 bytes
Class-map: class-default (match-any)
Matched packets : 3229

switch(config)#

```

- This command shows the QoS policy map for *interface Ethernet 1*.

```

switch(config)#show policy-map interface Ethernet 1 input type qos
Interface: Ethernet 1 Service-policy input: policy1
Hardware programming status: Successful Class-map: class1 (match-any)
Match: ip access-group name acl1
Police cir 512000 bps bc 9000 bytes
Class-map: class2 (match-any)
Match: ip access-group name acl2 set dscp 2
Class-map: class3 (match-any) Match: ip access-group name acl3
Police cir 1280000 bps bc 9000 bytes
Class-map: class-default (match-any)

switch(config)#

```

9.1.5 QoS Configuration: FM6000 Platform Switches

Implementing QoS on an FM6000 platform switch consists of configuring port trust settings, default port settings, default traffic classes, conversion maps, and transmit queues.

- [CoS and DSCP Port Settings – FM6000 Platform Switches](#)
- [Traffic Class Derivations – FM6000 Platform Switches](#)
- [CoS and DSCP Rewrite – FM6000 Platform Switches](#)
- [Transmit Queues and Port Shaping – FM6000 Platform Switches](#)

9.1.5.1 CoS and DSCP Port Settings – FM6000 Platform Switches

[Port Settings – Trust Mode and Traffic Class](#) describes port trust and default port CoS and DSCP values.

Configuring Port Trust Settings

The `qos trust` command configures the QoS port trust mode for the configuration mode interface. Trust enabled ports use packet CoS or DSCP values to classify traffic. The port-trust default for switched ports is `cos`. The port-trust default for routed ports is `dscp`.

- `qos trust cos` specifies `cos` as the port's port-trust mode.
- `qos trust dscp` specifies `dscp` as the port's port-trust mode.
- `no qos trust` specifies untrusted as the port's port-trust mode.

The `show qos interfaces trust` command displays the trust mode of specified interfaces.

Example

These commands configure and display the following trust modes:

- Ethernet 15: `dscp`
- Ethernet 16: `untrusted`
- Ethernet 17: `cos`
- Ethernet 18: default as a switched port

- Ethernet 19: default as a routed port

```

switch(config)#interface ethernet 15
switch(config-if-Et15)#qos trust dscp
switch(config-if-Et15)#interface ethernet 16
switch(config-if-Et16)#no qos trust
switch(config-if-Et16)#interface ethernet 17
switch(config-if-Et17)#qos trust cos
switch(config-if-Et17)#interface ethernet 18
switch(config-if-Et18)#switchport
switch(config-if-Et18)#default qos trust
switch(config-if-Et19)#interface ethernet 19
switch(config-if-Et19)#no switchport
switch(config-if-Et19)#default qos trust
switch(config-if-Et19)#show qos interface ethernet 15 - 19 trust

```

Port	Operational	Trust Mode	Configured
Ethernet15	DSCP		DSCP
Ethernet16	UNTRUSTED		UNTRUSTED
Ethernet17	COS		COS
Ethernet18	COS		DEFAULT
Ethernet19	DSCP		DEFAULT

```

switch(config-if-Et19)#

```

Configuring Default Port Settings

Default CoS and DSCP settings are assigned to individual port channel and Ethernet interfaces. These configuration mode interface commands specify the port's default CoS and DSCP values.

- `qos cos` configures a port's default CoS value.
- `qos dscp` configures a port's default DSCP value.

Example

These commands configure default CoS (4) and DSCP (44) settings on *interface Ethernet 19*.

```

switch(config)#interface ethernet 19
switch(config-if-Et19)#qos cos 4
switch(config-if-Et19)#qos dscp 44
switch(config-if-Et19)#show active
interface Ethernet19
  qos cos 4
  qos dscp 44
switch(config-if-Et19)#show qos interfaces ethernet 19
Ethernet19:
  Trust Mode: COS
  Default COS: 4
  Default DSCP: 44
switch(config-if-Et19)#

```

9.1.5.2 Traffic Class Derivations – FM6000 Platform Switches

[Traffic Classes](#) describes traffic classes.

Traffic Class Derivation Source

The following table displays the source for deriving a data stream's traffic class.

Table 16: Traffic Class Derivation Source: FM6000 Platform Switches

	Untrusted	CoS Trusted	DSCP Trusted
Untagged Non-IP	Default CoS (port)	Default CoS (port)	Default DSCP (port)
Untagged IP	Default CoS (port)	Default CoS (port)	DSCP (packet)
Tagged Non-IP	Default CoS (port)	CoS (packet)	Default DSCP (port)
Tagged IP	Default CoS (port)	CoS (packet)	DSCP (packet)

[CoS and DSCP Port Settings – FM6000 Platform Switches](#) describes the default CoS and DSCP settings for each port.

Mapping CoS to Traffic Class

The `qos map cos` command assigns a traffic class to a list of CoS settings. Multiple commands create a complete CoS to traffic class map. The switch uses this map to assign a traffic class to data packets on the basis of the packet's CoS field or the port upon which it is received.

Example

This command assigns the traffic class of **5** to the classes of service **1, 3, 5, and 7**.

```
switch(config)#qos map cos 1 3 5 7 to traffic-class 5
switch(config)#show qos maps
  Number of Traffic Classes supported: 8
  Number of Transmit Queues supported: 8

  Cos-tc map:
  cos:  0  1  2  3  4  5  6  7
  -----
  tc:   1  5  2  5  4  5  6  5

switch(config)#
```

The following table displays the default CoS to Traffic Class map on FM6000 platform switches.

Table 17: Default CoS to Traffic Class Map: FM6000 Platform Switches

Inbound CoS	Untagged	0	1	2	3	4	5	6	7
Traffic Class	Derived: use default CoS as inbound CoS	1	0	2	3	4	5	6	7

Mapping DSCP to Traffic Class

The `qos map dscp` command assigns a traffic class to a set of DSCP values. Multiple commands create a complete DSCP to traffic class map. The switch uses this map to assign a traffic class to data packets on the basis of the packet's DSCP field or the chip upon which it is received.

Example

This command assigns the traffic class of three to the DSCP values of **12, 13, 25, and 37**.

```
switch(config)#qos map dscp 12 13 25 37 to traffic-class 3
switch(config)#show qos map
  Number of Traffic Classes supported: 8
```

```

Dscp-tc map:
d1 : d2 0 1 2 3 4 5 6 7 8 9
-----
0 : 1 1 1 1 1 1 1 1 0 0
1 : 0 0 3 3 0 0 2 2 2 2
2 : 2 2 2 2 3 3 3 3 3 3
3 : 3 3 4 4 4 4 4 3 4 4
4 : 5 5 5 5 5 5 5 5 6 6
5 : 6 6 6 6 6 6 7 7 7 7
6 : 7 7 7 7

```

```
switch(config)#
```

The following displays the default DSCP to Traffic Class map on FM6000 platform switches.

Table 18: Default DSCP to Traffic Class Map: FM6000 Platform Switches

Inbound DSCP	0-7	8-15	16-23	24-31	32-39	40-47	48-55	56-63
Traffic Class	1	0	2	3	4	5	6	7

9.1.5.3 CoS and DSCP Rewrite – FM6000 Platform Switches

[Rewriting CoS and DSCP](#) describes the CoS and DSCP rewrite functions.

Traffic Class to CoS Rewrite Map

The CoS rewrite value is configurable and based on a data stream’s traffic class, as specified by the traffic class–CoS rewrite map. The `qos map traffic-class to cos` command assigns a CoS rewrite value to a list of traffic classes. Multiple commands create the complete traffic class–CoS rewrite map.

Example

This command assigns the CoS rewrite value of two to traffic classes **1, 3, and 5**.

```

switch(config)#qos map traffic-class 1 3 5 to cos 2
switch(config)#show qos map
Number of Traffic Classes supported: 8

Tc - tx-queue map:
tc:      0 1 2 3 4 5 6 7
-----
tx-queue: 0 1 2 3 4 5 6 7

switch(config)#

```

The following table displays the default traffic class–CoS rewrite map on FM6000 platform switches.

Table 19: Default Traffic Class to CoS Rewrite Map: FM6000 Platform Switches

Traffic Class	0	1	2	3	4	5	6	7
CoS Rewrite Value	1	0	2	3	4	5	6	7

Traffic Class to DSCP Rewrite Map

The DSCP rewrite value is configurable and based on a data stream's traffic class, as specified by the traffic class-DSCP rewrite map. The `qos map traffic-class to dscp` command assigns a DSCP rewrite value to a list of traffic classes. Multiple commands create the complete traffic class-DSCP rewrite map.

Example

This command assigns the DSCP rewrite value of 37 to traffic classes **2, 4, and 6**.

```
switch(config)#qos map traffic-class 2 4 6 to dscp 37
switch(config)#show qos map
  Number of Traffic Classes supported: 8

Tc-dscp map:
  tc:    0  1  2  3  4  5  6  7
  -----
  dscp:  8  0 37 24 37 40 37 56

switch(config)#
```

The following table displays the default traffic class–DSCP rewrite map on on FM6000 platform switches.

Table 20: Default Traffic Class to DSCP Rewrite Map: FM6000 Platform Switches

Traffic Class	0	1	2	3	4	5	6	7
DSCP Rewrite Value	8	0	16	24	32	40	48	56

9.1.5.4 Transmit Queues and Port Shaping – FM6000 Platform Switches

[Transmit Queues and Port Shaping](#) describes transmit queues and port shaping.

A data stream's traffic class determines the transmit queue it uses. The switch defines a single traffic class-transmit queue map for all Ethernet and port channel interfaces and is used for unicast and multicast traffic. The `show qos maps` command displays the traffic class to transmit queue map.

The following table displays the default traffic class to transmit queue map on FM6000 platform switches.

Table 21: Default Traffic Class to Transmit Queue Map: FM6000 Platform Switches

Traffic Class	0	1	2	3	4	5	6	7
Transmit Queue	0	1	2	3	4	5	6	7

Mapping Traffic Classes to a Transmit Queue

The `qos map traffic-class to tx-queue` command assigns traffic classes to a transmit queue. Multiple commands create the complete map.

Example

These commands assign traffic classes of **1, 3, and 5** to **transmit queue 1**, traffic classes **2, 4, and 6** to **transmit queue 2**, and **traffic class 0** to **transmit queue 0**, then display the resultant map.

```
switch(config)#qos map traffic-class 1 3 5 to tx-queue 1
switch(config)#qos map traffic-class 2 4 6 to tx-queue 2
switch(config)#qos map traffic-class 0 to tx-queue 0
switch(config)#show qos maps
    Number of Traffic Classes supported: 8
    Number of Transmit Queues supported: 8

Tc - tx-queue map:
tc:          0  1  2  3  4  5  6  7
-----
tx-queue:   0  1  2  1  2  1  2  7

switch(config)#
```

Entering TX-Queue Configuration Mode

Transmit queues are configurable on Ethernet ports and port channels. Queue parameters are configured in tx-queue configuration command mode, which is entered from interface ethernet configuration mode. The `tx-queue (FM6000)` command places the switch in tx-queue configuration mode. The `show qos interfaces` displays the transmit queue configuration for a specified port.

Example

This command enters tx-queue configuration mode for **transmit queue 3** of **interface Ethernet 5**.

```
switch(config)#interface ethernet 5
switch(config-if-Et5)#tx-queue 3
switch(config-if-Et5-txq-3)#
```

Configuring the Shape Rate – Port and Transmit Queues

A port's shape rate specifies its maximum outbound traffic bandwidth. A transmit queue's shape rate specifies the queue's maximum outbound bandwidth. Shape rate commands specify data rates in kbps.

 **Note:** Enabling port shaping on an FM6000 interface disables queue shaping internally. Disabling port shaping restores queue shaping as specified in *running-config*.

- To configure a port's shape rate, enter `shape rate (Interface – FM6000)` from the port's interface configuration mode.
- To configure a transmit queue's shape rate, enter `shape rate (Tx-queue – FM6000)` from the queue's tx-queue configuration mode.

Example

These commands configure a shape rate of **5 Gbs** on **interface Ethernet 3**, then configure the shape rate for the following transmit queues:

- transmit queues **0, 1, and 2: 500 Mbps**
- transmit queues **3, 4, and 5: 400 Mbps**

```
switch(config)#interface ethernet 3
switch(config-if-Et3)#shape rate 5000000
switch(config-if-Et3)#tx-queue 0
switch(config-if-Et3-txq-0)#shape rate 500000
switch(config-if-Et3-txq-0)#tx-queue 1
switch(config-if-Et3-txq-1)#shape rate 500000
```

```

switch(config-if-Et3-txq-1)#tx-queue 3
switch(config-if-Et3-txq-3)#shape rate 400000
switch(config-if-Et3-txq-3)#tx-queue 4
switch(config-if-Et3-txq-4)#shape rate 400000
switch(config-if-Et3-txq-4)#tx-queue 5
switch(config-if-Et3-txq-5)#shape rate 400000
switch(config-if-Et3-txq-5)#exit
switch(config-if-Et3)#show qos interface ethernet 3
Ethernet3:

Port shaping rate: 5000000Kbps

Tx-Queue    Bandwidth    Shape Rate    Priority
(percent)    (Kbps)
-----
          7         N/A         disabled      strict
          6         N/A         disabled      strict
          5         N/A         400000        strict
          4         N/A         400000        strict
          3         N/A         400000        strict
          2         N/A         disabled      strict
          1         N/A         500000        strict
          0         N/A         500000        strict

switch(config-if-Et3)#

```

Configuring Queue Priority

Queue priority rank is denoted by the queue number; transmit queues with higher numbers have higher priority. The `priority (FM6000)` command configures a transmit queue's priority type:

- `priority strict` configures the queue as a strict priority queue.
- `no priority` configures the queue as a round robin queue.

A queue's configuration as **round robin** also applies to all lower priority queues regardless of other configuration statements.

The `bandwidth percent (FM6000)` command configures a round robin queue's bandwidth share. The cumulative operational bandwidth of all round robin queues is always less than or equal to 100%. If the cumulative configured bandwidth is greater than 100%, each port's operational bandwidth is its configured bandwidth divided by the cumulative configured bandwidth.

Examples

- These commands configure **transmit queue 3** (on **interface Ethernet 19**) as a round robin queue, then allocates **10%**, **20%**, **30%**, and **40%** bandwidth to queues **0** through **3**.

The `no priority` statement for **queue 3** also configures queues **0**, **1**, and **2** as round robin queues. Removing this statement reverts the other queues to **strict priority** type unless **running-config** contains a `no priority` statement for one of these queues.

```

switch(config)#interface ethernet 19
switch(config-if-Et19)#tx-queue 3
switch(config-if-Et19-txq-3)#no priority
switch(config-if-Et19-txq-3)#bandwidth percent 40
switch(config-if-Et19-txq-3)#tx-queue 2
switch(config-if-Et19-txq-2)#bandwidth percent 30
switch(config-if-Et19-txq-2)#tx-queue 1
switch(config-if-Et19-txq-1)#bandwidth percent 20
switch(config-if-Et19-txq-1)#tx-queue 0
switch(config-if-Et19-txq-0)#bandwidth percent 10
switch(config-if-Et19-txq-0)#show qos interface ethernet 19

```

```

Ethernet19:
  Port shaping rate: disabled

  Tx-Queue   Bandwidth   Shape Rate   Priority
             (percent)   (Kbps)
  -----
             7       N/A       disabled     strict
             6       N/A       disabled     strict
             5       N/A       disabled     strict
             4       N/A       disabled     strict
             3        40       disabled     round-robin
             2        30       disabled     round-robin
             1        20       disabled     round-robin
             0        10       disabled     round-robin

switch(config-if-Et19-txq-0) #

```

- Changing the bandwidth percentage for queue **3** to **60** changes the operational bandwidth of each queue to its configured bandwidth divided by **120%** (10%+20%+30%+60%).

```

switch(config-if-Et19-txq-0) #tx-queue 3
switch(config-if-Et19-txq-3) #bandwidth percent 60
switch(config-if-Et19-txq-3) #show qos interface ethernet 19
Ethernet19:
  Port shaping rate: disabled

  Tx-Queue   Bandwidth   Shape Rate   Priority
             (percent)   (Kbps)
  -----
             7       N/A       disabled     strict
             6       N/A       disabled     strict
             5       N/A       disabled     strict
             4       N/A       disabled     strict
             3        49       disabled     round-robin
             2        24       disabled     round-robin
             1        16       disabled     round-robin
             0         8       disabled     round-robin

switch(config-if-Et19-txq-3) #

```

9.1.6 QoS Configuration: Petra Platform Switches

Implementing QoS on a Petra platform switch consists of configuring port trust settings, default port settings, default traffic classes, conversion maps, and transmit queues.

- [CoS and DSCP Port Settings – Petra Platform Switches](#)
- [Traffic Class Derivations – Petra Platform Switches](#)
- [CoS Rewrite – Petra Platform Switches](#)
- [Transmit Queues and Port Shaping – Petra Platform Switches](#)

9.1.6.1 CoS and DSCP Port Settings – Petra Platform Switches

[Port Settings – Trust Mode and Traffic Class](#) describes port trust and default port CoS and DSCP values.

Configuring Port Trust Settings

The `qos trust` command configures the QoS port trust mode for the configuration mode interface. Trust enabled ports use packet CoS or DSCP values to classify traffic. The port-trust default for switched ports is **cos**. The port-trust default for routed ports is **dscp**.

- `qos trust cos` specifies `cos` as the port's port-trust mode.
- `qos trust dscp` specifies `dscp` as the port's port-trust mode.
- `no qos trust` specifies untrusted as the port's port-trust mode.

The `show qos interfaces trust` command displays the trust mode of specified interfaces.

Example

These commands configure and display the following trust modes:

- Ethernet 3/25: dscp
- Ethernet 3/26: untrusted
- Ethernet 3/27: cos
- Ethernet 3/28: default as a switched port
- Ethernet 3/29: default as a routed port

```
switch(config)#interface ethernet 3/25
switch(config-if-Et3/25)#qos trust dscp
switch(config-if-Et3/25)#interface ethernet 3/26
switch(config-if-Et3/26)#no qos trust
switch(config-if-Et3/26)#interface ethernet 3/27
switch(config-if-Et3/27)#qos trust cos
switch(config-if-Et3/27)#interface ethernet 3/28
switch(config-if-Et3/28)#switchport
switch(config-if-Et3/28)#default qos trust
switch(config-if-Et3/28)#interface ethernet 3/29
switch(config-if-Et3/29)#no switchport
switch(config-if-Et3/29)#default qos trust
switch(config-if-Et3/29)#show qos interface ethernet 3/25 - 3/29 trust
```

Port	Trust Mode	
	Operational	Configured
Ethernet3/25	DSCP	DSCP
Ethernet3/26	UNTRUSTED	UNTRUSTED
Ethernet3/27	COS	COS
Ethernet3/28	COS	DEFAULT
Ethernet3/29	DSCP	DEFAULT

```
switch(config-if-Et3/29)#
```

Configuring Default Port Settings

Port channel and Ethernet interfaces are not assigned default CoS or DSCP settings.

9.1.6.2 Traffic Class Derivations – Petra Platform Switches

[Traffic Classes](#) describes traffic classes.

Traffic Class Derivation Source

The following table displays the source for deriving a data stream's default traffic class.

Table 22: Traffic Class Derivation Source: Petra Platform Switches

	Untrusted	CoS Trusted	DSCP Trusted
Untagged Non-IP	Default TC (chip)	Default TC (chip)	Default TC (chip)
Untagged IP	Default TC (chip)	Default TC (chip)	DSCP (packet)
Tagged Non-I	Default TC (chip)	CoS (packet)	Default TC (chip)

Tagged IP	Default TC (chip)	CoS (packet)	DSCP (packet)
-----------	-------------------	--------------	---------------

Configuring Default Traffic Class

Petra platform switches assign a default traffic class to the set of Ethernet interfaces controlled by individual PetraA chips. Default traffic class values are configurable for each PetraA chip, not individual interfaces.

The `platform petraA traffic-class` command specifies the default traffic class used by all ports controlled by a specified chip. The `show platform petraA traffic-class` command displays traffic class assignments.

Examples

- This command configures the default traffic class to five for the ports 32-39 on linecard 3 (7500 Series).

```
switch(config)#platform petraA petra3/4 traffic-class 5
switch(config)#show platform petraA module 3 traffic-class
Petra3/0 traffic-class: 1
Petra3/1 traffic-class: 1
Petra3/2 traffic-class: 1
Petra3/3 traffic-class: 1
Petra3/4 traffic-class: 5
Petra3/5 traffic-class: 1
switch(config)#
```

- This command configures the default traffic class to three for all ports on *linecard 6* (7500 Series).

```
switch(config)#platform petraA module 6 traffic-class 6
switch(config)#show platform petraA module 6 traffic-class
Petra6/0 traffic-class: 6
Petra6/1 traffic-class: 6
Petra6/2 traffic-class: 6
Petra6/3 traffic-class: 6
Petra6/4 traffic-class: 6
Petra6/5 traffic-class: 6
switch(config)#
```

Mapping CoS to Traffic Class

The `qos map cos` command assigns a traffic class to a list of CoS settings. Multiple commands create a complete CoS–traffic class map. The switch uses this map to assign a traffic class to data packets on the basis of the packet’s CoS field or the port upon which it is received.

Example

This command assigns *traffic class 4* to the classes of service *1, 3, 5, and 7*.

```
switch(config)#qos map cos 1 3 5 7 to traffic-class 4
switch(config)#show qos maps
Number of Traffic Classes supported: 8

Cos-tc map:
cos:  0  1  2  3  4  5  6  7
-----
tc:   1  4  2  4  4  4  6  4

switch(config)#
```

The following table displays the default CoS to traffic class map on Petra platform switches.

Table 23: Default CoS to Traffic Class Map: Petra Platform Switches

Inbound CoS	untagged	0	1	2	3	4	5	6	7
Traffic Class	Derived: use default CoS as inbound CoS	1	0	2	3	4	5	6	7

Mapping DSCP to Traffic Class

The `qos map dscp` command assigns a traffic class to a set of DSCP values. Multiple commands create a complete DSCP to traffic class map. The switch uses this map to assign a traffic class to data packets on the basis of the packet's DSCP field or the chip upon which it is received.

Example

This command assigns **traffic class 3** to the DSCP values of **12, 13, 25, and 37**.

```
switch(config)#qos map dscp 12 13 14 25 48 to traffic-class 3
switch(config)#show qos maps
Number of Traffic Classes supported: 8

Dscp-tc map:
d1 : d2 0 1 2 3 4 5 6 7 8 9
-----
0 : 1 1 1 1 1 1 1 1 0 0
1 : 0 0 3 3 3 0 2 2 2 2
2 : 2 2 2 2 3 3 3 3 3 3
3 : 3 3 4 4 4 4 4 4 4 4
4 : 5 5 5 5 5 5 5 5 3 6
5 : 6 6 6 6 6 6 7 7 7 7
6 : 7 7 7 7

switch(config)#
```

The following table displays the default DSCP to Traffic Class map on Petra platform switches.

Table 24: Default DSCP to Traffic Class Map: Petra Platform Switches

Inbound DSCP	0-7	8-15	16-23	24-31	32-39	40-47	48-55	56-63
Traffic Class	1	0	2	3	4	5	6	7

9.1.6.3 CoS Rewrite – Petra Platform Switches

[Rewriting CoS and DSCP](#) describes the CoS rewrite function.

Traffic Class to CoS Rewrite Map

The CoS rewrite value is configurable and based on a data stream's traffic class, as specified by the traffic class-CoS rewrite map. The `qos map traffic-class to cos` command assigns a CoS rewrite value to a list of traffic classes. Multiple commands create the complete traffic class-CoS rewrite map.

Example

This command assigns the CoS of two to traffic classes **1, 3, and 5**.

```
switch(config)#qos map traffic-class 1 3 5 to cos 2
switch(config)#show qos map
    Number of Traffic Classes supported: 8

    Tc-cos map:
      tc:   0  1  2  3  4  5  6  7
      -----
      cos:  1  2  2  2  4  2  6  7

switch(config)#
```

The following table displays the default Traffic Class to CoS rewrite value map on Petra platform switches.

Table 25: Default Traffic Class to CoS Rewrite Value Map: Petra Platform Switches

Traffic Class	0	1	2	3	4	5	6	7
CoS Rewrite Value	1	0	2	3	4	5	6	7

Traffic Class to DSCP Rewrite Map

DSCP rewrite is always disabled on Petra platform switches.

9.1.6.4 Transmit Queues and Port Shaping – Petra Platform Switches

[Transmit Queues and Port Shaping](#) describes transmit queues and port shaping.

Petra platform switches provide four physical queues for each egress port: Unicast High, Unicast Low, Multicast High, and Multicast Low. Data is scheduled for the high or low queue based on its priority as defined by its transmit queue assignment (unicast traffic) or traffic class (multicast traffic), as shown in the table below. A Petra transmit queue is a data structure that defines scheduling of unicast traffic among physical egress queues.

Table 26: Traffic Distribution to Egress Port Queues

	High Priority Queue	Low Priority Queue
Unicast Traffic	Transmit Queues 5 – 7	Transmit Queues 0 – 4
Multicast Traffic	Traffic Classes 5 – 7	Traffic Classes 0 – 4

Multicast queue capacity that is available after multicast traffic is serviced is used for unicast traffic of a corresponding priority. Similarly, unicast queue capacity that is available after unicast traffic is serviced is used for overflow multicast traffic. Under conditions of unicast and multicast congestion, egress traffic is evenly split between unicast and multicast traffic.

[Unicast Transmit Queues and Port Shaping](#) describes unicast transmit queues and shaping. [Multicast Egress Scheduling](#) describes multicast priority and traffic classes.

9.1.6.4.1 Unicast Transmit Queues and Port Shaping

A data stream's traffic class determines the transmit queue it uses. The switch defines a single traffic class–transmit queue map for unicast traffic on all Ethernet interfaces. The [show qos maps](#) command displays the traffic class–transmit queue map. The following table displays the default traffic class to transmit queue map on Petra platform switches.

Table 27: Default Traffic Class to Transmit Queue Map: Petra Platform Switches

Traffic Class	0	1	2	3	4	5	6	7
Transmit Queue	0	1	2	3	4	5	6	7

Transmit queue parameters are configured in tx-queue configuration command mode.

Mapping Traffic Classes to a Transmit Queue

The `qos map traffic-class to tx-queue` command assigns traffic classes to a transmit queue. Multiple commands complete the traffic class-transmit queue map. Traffic class 7 and transmit queue 7 are always mapped to each other. This association is not editable.

Example

These commands assign traffic classes of **1, 3, and 5** to **transmit queue 1**, traffic classes **2, 4, and 6** to **transmit queue 2**, and **traffic class 0** to **transmit queue 0**, then display the resultant map.

```
switch(config)#qos map traffic-class 1 3 5 to tx-queue 1
switch(config)#qos map traffic-class 2 4 6 to tx-queue 2
switch(config)#qos map traffic-class 0 to tx-queue 0
switch(config)#show qos maps
  Number of Traffic Classes supported: 8
  Number of Transmit Queues supported: 8

  Tc - tx-queue map:
    tc:      0  1  2  3  4  5  6  7
    -----
    tx-queue: 0  1  2  1  2  1  2  7

switch(config)#
```

Entering Tx-Queue Configuration Mode

The `tx-queue (Petra)` command places the switch in tx-queue configuration mode to configure a transmit queue on the configuration mode interface. **Tx-queue 7** is not configurable. The `show qos interfaces` displays the transmit queue configuration for a specified port.

Example

This command enters tx-queue configuration mode for **transmit queue 3** of **interface Ethernet 3/28**.

```
switch(config)#interface ethernet 3/28
switch(config-if-Et3/28)#tx-queue 3
switch(config-if-Et3/28-txq-3)#
```

Configuring the Shape Rate – Port and Transmit Queues

A port's shape rate specifies its maximum outbound traffic bandwidth. A transmit queue's shape rate specifies the queue's maximum outbound bandwidth. Shape rate commands specify data rates in kbps.

- To configure a port's shape rate, enter `shape rate (Interface – Petra)` from the port's interface configuration mode.
- To configure a transmit queue's shape rate, enter `shape rate (Tx-queue – Petra)` from the queue's tx-queue configuration mode.

Example

These commands configure a shape rate of **5 Gbs** on **interface Ethernet 3**, then configure the shape rate for the following transmit queues:

- transmit queues **0, 1, and 2: 500 Mbps**
- transmit queues **3, 4, and 5: 400 Mbps**

```
switch(config)#interface ethernet 3/28
switch(config-if-Et3/28)#shape rate 5000000
switch(config-if-Et3/28)#tx-queue 0
switch(config-if-Et3/28-txq-0)#shape rate 500000
switch(config-if-Et3/28-txq-0)#tx-queue 1
switch(config-if-Et3/28-txq-1)#shape rate 500000
switch(config-if-Et3/28-txq-1)#tx-queue 2
switch(config-if-Et3/28-txq-2)#shape rate 500000
switch(config-if-Et3/28-txq-5)#tx-queue 3
switch(config-if-Et3/28-txq-3)#shape rate 400000
switch(config-if-Et3/28-txq-3)#tx-queue 4
switch(config-if-Et3/28-txq-4)#shape rate 400000
switch(config-if-Et3/28-txq-4)#tx-queue 5
switch(config-if-Et3/28-txq-5)#shape rate 400000
switch(config-if-Et3/28-txq-5)#show qos interface ethernet 3/28
Ethernet3/28:
```

Port shaping rate: 5000000Kbps

Tx-Queue	Bandwidth (percent)	Shape Rate (Kbps)	Priority
7	N/A	disabled	strict
6	N/A	disabled	strict
5	N/A	400000	strict
4	N/A	400000	strict
3	N/A	400000	strict
2	N/A	500000	strict
1	N/A	500000	strict
0	N/A	500000	strict

```
switch(config-if-Et3/28-txq-5)#
```

Configuring Queue Priority

The **priority (Petra)** command configures a transmit queue's priority type:

- The **priority strict** command configures the queue as a strict priority queue.
- The **no priority** command configures the queue as a round robin queue.

A queue's configuration as **round robin** also applies to all lower priority queues regardless of other configuration statements.

The **bandwidth percent (Petra)** command configures a round robin queue's bandwidth share. The cumulative operational bandwidth of all round robin queues is always less than or equal to 100%. If the cumulative configured bandwidth is greater than 100%, each port's operational bandwidth is its configured bandwidth divided by the cumulative configured bandwidth.

Examples

- These commands configure **transmit queue 3** (on **interface Ethernet 3/28**) as a round robin queue, then allocates **10%, 20%, 30%, and 40%** bandwidth to queues **0** through **3**.

The **no priority** statement for **queue 3** also configures queues **0, 1, and 2** as round robin queues. Removing this statement reverts the other queues to **strict priority** type unless **running-config** contains a **no priority** statement for one of these queues.

```
switch(config-if-Et3/28)#tx-queue 3
switch(config-if-Et3/28-txq-3)#no priority
switch(config-if-Et3/28-txq-3)#bandwidth percent 40
switch(config-if-Et3/28-txq-2)#tx-queue 2
switch(config-if-Et3/28-txq-2)#bandwidth percent 30
switch(config-if-Et3/28-txq-1)#tx-queue 1
switch(config-if-Et3/28-txq-1)#bandwidth percent 20
switch(config-if-Et3/28-txq-1)#tx-queue 0
switch(config-if-Et3/28-txq-0)#bandwidth percent 10
switch(config-if-Et3/28-txq-0)#show qos interface ethernet 3/28
Ethernet3/28:
```

Port shaping rate: 5000000Kbps

Tx-Queue	Bandwidth (percent)	Shape Rate (Kbps)	Priority
7	N/A	disabled	strict
6	N/A	disabled	strict
5	N/A	400000	strict
4	N/A	400000	strict
3	40	400000	round-robin
2	30	500000	round-robin
1	20	500000	round-robin
0	10	500000	round-robin

```
switch(config-if-Et3/28-txq-0)#
```

- Changing the bandwidth percentage for queue **3** to **60** changes the operational bandwidth of each queue to its configured bandwidth divided by **120%** (10%+20%+30%+60%).

```
switch(config-if-Et3/28-txq-0)#tx-queue 3
switch(config-if-Et3/28-txq-3)#bandwidth percent 60
switch(config-if-Et3/28-txq-3)#show qos interface ethernet 3/28
Ethernet3/28:
```

Port shaping rate: 5000000Kbps

Tx-Queue	Bandwidth (percent)	Shape Rate (Kbps)	Priority
7	N/A	disabled	strict
6	N/A	disabled	strict
5	N/A	400000	strict
4	N/A	400000	strict
3	49	400000	round-robin
2	24	500000	round-robin
1	16	500000	round-robin
0	8	500000	round-robin

```
switch(config-if-Et3/28-txq-3)#
```

9.1.6.4.2 Multicast Egress Scheduling

Multiclass traffic is not affected by traffic class assignment or port shaping statements. Multicast traffic is assigned to port egress queues based on traffic class and uses strict priority to schedule egress between the high and low queues.

9.1.7 QoS Configuration: Trident and Tomahawk Platform Switches

Implementing QoS on a Trident and Tomahawk platform switch consists of configuring port trust settings, default port settings, default traffic classes, conversion maps, and transmit queues.

- [CoS and DSCP Port Settings – Trident and Tomahawk Platform Switches](#)
- [Traffic Class Derivations – Trident and Tomahawk Platform Switches](#)
- [CoS and DSCP Rewrite – Trident and Tomahawk Platform Switches](#)
- [Transmit Queues and Port Shaping – Trident and Tomahawk Platform Switches](#)
- [ECN Configuration – Trident and Tomahawk Platform Switches](#)

9.1.7.1 CoS and DSCP Port Settings – Trident and Tomahawk Platform Switches

Configuring Port Trust Settings

The `qos trust` command configures the QoS port trust mode for the configuration mode interface. Trust-enabled ports use packet CoS or DSCP values to classify traffic. The port-trust default for switched ports is **CoS**. The port-trust default for routed ports is **DSCP**.

- `qos trust cos` specifies **CoS** as the port's trust mode.
- `qos trust dscp` specifies **DSCP** as the port's trust mode.
- `no qos trust` specifies **untrusted** as the port's trust mode.

The `show qos interfaces trust` command displays the trust mode of specified interfaces.

Example

- These commands configure and display the following trust modes:

- **Ethernet 15:** dscp
- **Ethernet 16:** untrusted
- **Ethernet 17:** cos
- **Ethernet 18:** default as a switched port
- **Ethernet 19:** default as a routed port

```
switch(config)#interface ethernet 15
switch(config-if-Et15)#qos trust dscp
switch(config-if-Et15)#interface ethernet 16
switch(config-if-Et16)#no qos trust
switch(config-if-Et16)#interface ethernet 17
switch(config-if-Et17)#qos trust cos
switch(config-if-Et17)#interface ethernet 18
switch(config-if-Et18)#switchport
switch(config-if-Et18)#default qos trust
switch(config-if-Et18)#interface ethernet 19
switch(config-if-Et19)#no switchport
switch(config-if-Et19)#default qos trust
switch(config-if-Et19)#show qos interface ethernet 15 - 19 trust
```

Port	Operational	Trust Mode	Configured
Ethernet15	DSCP		DSCP
Ethernet16	UNTRUSTED		UNTRUSTED
Ethernet17	COS		COS

```

Ethernet18          COS          DEFAULT
Ethernet19          DSCP          DEFAULT

switch(config-if-Et19) #

```

Configuring Default Port Settings

Default CoS and DSCP settings are assigned to individual port channel and Ethernet interfaces. These configuration mode interface commands specify the port's default CoS and DSCP values.

- `qos cos` configures a port's default CoS value.
- `qos dscp` configures a port's default DSCP value.

Example

These commands configure default CoS (**4**) and DSCP (**44**) values on *interface Ethernet 7*.

```

switch(config) #interface ethernet 7
switch(config-if-Et7) #qos cos 4
switch(config-if-Et7) #qos dscp 44
switch(config-if-Et7) #show active
interface Ethernet7
  qos cos 4
  qos dscp 44
switch(config-if-Et7) #show qos interfaces ethernet 7
Ethernet7:
  Trust Mode: COS
  Default COS: 4
  Default DSCP: 44

switch(config-if-Et7) #

```

9.1.7.2 Traffic Class Derivations – Trident and Tomahawk Platform Switches

[Traffic Classes](#) describes traffic classes.

Traffic Class Derivation Source

The following table displays the source for deriving a data stream's traffic class.

Table 28: Traffic Class Derivation Source: Trident and Tomahawk Platform Switches

	Untrusted	CoS Trusted	DSCP Trusted
Untagged Non-IP	Default CoS (port)	Default CoS (port)	Default DSCP (port)
Untagged IP	Default CoS (port)	Default CoS (port)	DSCP (packet)
Tagged Non-IP	Default CoS (port)	CoS (packet)	Default DSCP (port)
Tagged IP	Default CoS (port)	CoS (packet)	DSCP (packet)

[CoS and DSCP Port Settings – Trident and Tomahawk Platform Switches](#) describes the default CoS and DSCP settings for each port.

Mapping CoS to Traffic Class

The `qos map cos` command assigns a traffic class to a list of CoS settings. Multiple commands create a complete CoS to traffic class map. The switch uses this map to assign a traffic class to data packets on the basis of the packet's CoS field or the port upon which it is received.

Example

This command assigns the **traffic class 5** to the classes of service **1, 3, 5, and 7**.

```
switch(config)#qos map cos 1 3 5 7 to traffic-class 5
switch(config)#show qos maps
Number of Traffic Classes supported: 8

Cos-tc map:
cos:  0  1  2  3  4  5  6  7
-----
tc:   1  5  2  5  4  5  6  5

switch(config)#
```

The following table displays the default CoS–traffic class map on Trident and Tomahawk platform switches.

Table 29: Default CoS to Traffic Class Map: Trident II Platform Switches

Inbound CoS	0	1	2	3	4	5	6	7
Traffic Class	1	0	2	3	4	5	6	7

Mapping DSCP to Traffic Class

The `qos map dscp` command assigns a traffic class to a set of DSCP values. Multiple commands create a complete DSCP to traffic class map. The switch uses this map to assign a traffic class to data packets on the basis of the packet's DSCP field or the chip upon which it is received.

Example

This command assigns the **traffic class 0** to DSCP values of **12, 24, 41, and 44-47**.

```
switch(config)#qos map dscp 12 24 41 44 45 46 47 to traffic-class 0
switch(config)#show qos maps
Number of Traffic Classes supported: 8

Dscp-tc map:
d1 :  d2 0  1  2  3  4  5  6  7  8  9
-----
0 :    1  1  1  1  1  1  1  1  0  0
1 :    0  0  0  0  0  0  2  2  2  2
2 :    2  2  2  2  0  3  3  3  3  3
3 :    3  3  4  4  4  4  4  4  4  4
4 :    5  0  5  5  0  0  0  0  6  6
5 :    6  6  6  6  6  6  7  7  7  7
6 :    7  7  7  7

switch(config)#
```

The following table displays the default DSCP–traffic class map on Trident and Tomahawk platform switches.

Table 30: Default DSCP to Traffic Class Map: Trident and Tomahawk Platform Switches

Inbound DSCP	0-7	8-15	16-23	24-31	32-39	40-47	48-55	56-63
Traffic Class	1	0	2	3	4	5	6	7

9.1.7.3 CoS and DSCP Rewrite – Trident and Tomahawk Platform Switches

[Rewriting CoS and DSCP](#) describes the CoS and DSCP rewrite functions.

Traffic Class to CoS Rewrite Map

The CoS rewrite value is configurable and based on a data stream's traffic class, as specified by the traffic class-CoS rewrite map. The `qos map traffic-class to cos` command assigns a CoS rewrite value to a list of traffic classes. Multiple commands create the complete traffic class-CoS rewrite map.

Example

This command assigns the **CoS 2** to traffic classes **1, 3, and 5**.

```
switch(config)#qos map traffic-class 1 3 5 to cos 2
switch(config)#show qos map
  Number of Traffic Classes supported: 8

  Tc-cos map:
    tc:   0  1  2  3  4  5  6  7
    -----
    cos:  1  2  2  2  4  2  6  7

switch(config)#
```

The following table displays the default Traffic Class to CoS rewrite value map on Trident and Tomahawk platform switches.

Table 31: Default Traffic Class to CoS Rewrite Value Map: Trident and Tomahawk Platform Switches

Traffic Class	0	1	2	3	4	5	6	7
CoS Rewrite Value	1	0	2	3	4	5	6	7

Traffic Class to DSCP Rewrite Map

The DSCP rewrite value is configurable and based on a data stream's traffic class, as specified by the traffic class-DSCP rewrite map. The `qos map traffic-class to dscp` command assigns a DSCP rewrite value to a list of traffic classes. Multiple commands create the complete traffic class-DSCP rewrite map.

Example

This command assigns the DSCP value of **29** to traffic classes **2, 4, and 6**.

```
switch(config)#qos map traffic-class 2 4 6 to dscp 29
switch(config)#show qos map
  Number of Traffic Classes supported: 8

  Tc-dscp map:
    tc:   0  1  2  3  4  5  6  7
    -----
    dscp:  8  0 29 24 29 40 29 56

switch(config)#
```

The following displays the default traffic class to DSCP rewrite map on Trident and Tomahawk platform switches.

Table 32: Traffic Class to DSCP Rewrite Value Map: Trident and Tomahawk Platform Switches

Traffic Class	0	1	2	3	4	5	6	7
DSCP	8	0	16	24	32	40	48	56

9.1.7.4 Transmit Queues and Port Shaping – Trident and Tomahawk Platform Switches

[Transmit Queues and Port Shaping](#) describes transmit queues and port shaping.

Trident and Tomahawk platform switches define 12 transmit queues: eight unicast (UC0 – UC7) and four multicast (MC0 – MC03). The traffic class–transmit queue maps are configured globally and apply to all Ethernet interfaces. The [show qos maps](#) command displays the traffic class–transmit queue maps.

The following table displays the default traffic class–transmit queue maps.

Table 33: Default Traffic Class to Transmit Queue Map: Trident and Tomahawk Platform Switches

Traffic Class	0	1	2	3	4	5	6	7
Unicast Transmit Queue	0	1	2	3	4	5	6	7
Multicast Transmit Queue	0	0	1	1	2	2	3	3

Mapping Traffic Classes to a Transmit Queue

These commands assign traffic classes to a transmit queue:

- [qos map traffic-class to uc-tx-queue](#) associates a unicast queue to a traffic class set.
- [qos map traffic-class to mc-tx-queue](#) associates a multicast queue to a traffic class set.

Multiple commands create the complete maps.

Example

- These commands assign the following on *interface Ethernet 7*:
 - traffic classes **1, 3, and 5** to **unicast queue 1**
 - traffic classes **2, 4, and 6** to **unicast queue 5**
 - traffic classes **1, 2, and 3** to **multicast queue 1**
 - traffic classes **4, 5, and 6** to **multicast queue 3**
 - **traffic class 0** to **unicast queue 0** and **multicast queue 0**

```
switch(config)#default interface ethernet 7
switch(config)#qos map traffic-class 1 3 5 to uc-tx-queue 1
switch(config)#qos map traffic-class 2 4 6 to uc-tx-queue 5
switch(config)#qos map traffic-class 1 2 3 to mc-tx-queue 1
switch(config)#qos map traffic-class 4 5 6 to mc-tx-queue 3
switch(config)#qos map traffic-class 0 to uc-tx-queue 0
switch(config)#qos map traffic-class 0 to mc-tx-queue 0
switch(config)#show qos maps
  Number of Traffic Classes supported: 8
  Number of Transmit Queues supported: 12

Tc - uc-tx-queue map:
tc:          0  1  2  3  4  5  6  7
-----
uc-tx-queue: 0  1  5  1  5  1  5  7
```

```
Tc - mc-tx-queue map:
tc:          0  1  2  3  4  5  6  7
-----
mc-tx-queue: 0  1  1  1  3  3  3  3

switch(config)#
```

Entering a Transmit Queue Configuration Mode

Transmit queues are configurable on individual Ethernet ports. Parameters for individual transmit queues are configured in one of two transmit queue configuration modes. Transmit queue modes are accessed from an interface-ethernet configuration mode.

- [uc-tx-queue](#) places the switch in uc-tx-queue mode to configure a unicast transmit queue.
- [mc-tx-queue](#) places the switch in mc-tx-queue mode to configure a multicast transmit queue.

The [show qos interfaces](#) displays the transmit queue configuration for a specified port.

Examples

- This command enters the mode that configures **unicast transmit queue 3** of **interface Ethernet 5**.

```
switch(config)#interface ethernet 5
switch(config-if-Et5)#uc-tx-queue 3
switch(config-if-Et5-uc-txq-3)#
```

- This command enters the mode to configure **multicast transmit queue 3** of **interface Ethernet 5**.

```
switch(config-if-Et5)#mc-tx-queue 2
switch(config-if-Et5-mc-txq-2)#
```

Configuring the Shape Rate – Port and Transmit Queues

A port's shape rate specifies the port's maximum outbound traffic bandwidth. A shape rate can also be configured for all transmit queues on each port. All shape rate commands use kbps to specify data rates.

- To configure a port's shape rate, enter [shape rate \(Interface – Trident and Tomahawk\)](#) from the port's interface configuration mode.
- To configure a transmit queue's shape rate, enter [shape rate \(Tx-queue – Trident and Tomahawk\)](#) from the queue's tx-queue configuration mode.

Example

These commands configure a shape rate of **5 Gbs** on **interface Ethernet 7**, then configure the shape rate for the following transmit queues:

- unicast transmit queues **0** and **1**: **500** Mbps
- unicast transmit queues **3** and **4**: **400** Mbps
- multicast transmit queues **0** and **2**: **300** Mbps

```
switch(config)#interface ethernet 7
switch(config-if-Et7)#shape rate 5000000
switch(config-if-Et7)#uc-tx-queue 0
switch(config-if-Et7-uc-txq-0)#shape rate 500000
switch(config-if-Et7-uc-txq-0)#uc-tx-queue 1
switch(config-if-Et7-uc-txq-1)#shape rate 500000
switch(config-if-Et7-uc-txq-1)#uc-tx-queue 3
switch(config-if-Et7-uc-txq-3)#shape rate 400000
switch(config-if-Et7-uc-txq-3)#uc-tx-queue 5
switch(config-if-Et7-uc-txq-5)#shape rate 400000
```

```

switch(config-if-Et7-uc-txq-5) #mc-tx-queue 0
switch(config-if-Et7-mc-txq-0) #shape rate 300000
switch(config-if-Et7-mc-txq-0) #mc-tx-queue 2
switch(config-if-Et7-mc-txq-2) #shape rate 300000
switch(config-if-Et7-mc-txq-2) #exit
switch(config-if-Et7) #show qos interface ethernet 7
Ethernet7:

Port shaping rate: 5000000Kbps

Tx-Queue    Bandwidth    Shape Rate    Priority    Priority Group
  (percent)      (Kbps)
-----
UC7          N/A          disabled      strict      1
UC6          N/A          disabled      strict      1
MC3          N/A          disabled      strict      1
UC5          N/A          400000       strict      0
UC4          N/A          disabled      strict      0
MC2          N/A          300000       strict      0
UC3          N/A          400000       strict      0
UC2          N/A          disabled      strict      0
MC1          N/A          disabled      strict      0
UC1          N/A          500000       strict      0
UC0          N/A          500000       strict      0
MC0          N/A          300000       strict      0

switch(config-if-Et7) #

```

Configuring Queue Priority

Trident and Tomahawk platform switch queues are categorized into two priority groups. Priority group 1 queues have priority over priority 0 queues. The following lists display the priority group queues in order from higher priority to lower priority.

- Priority Group 1: UC7, UC6, MC3
- Priority Group 0: UC5, UC4, MC2, UC3, UC2, MC1, UC1, UC0, MC0

The `priority (Trident and Tomahawk)` command configures a transmit queue's priority type:

- The `priority strict` command configures the queue as a strict priority queue.
- The `no priority` command configures the queue as a round robin queue.

A queue's configuration as **round robin** also applies to all lower priority queues regardless of other configuration statements.

The `bandwidth percent (Trident and Tomahawk)` command configures a round robin queue's bandwidth share. The cumulative operational bandwidth of all round robin queues is always 100%. If the cumulative configured bandwidth is greater than 100%, each port's operational bandwidth is its configured bandwidth divided by the cumulative configured bandwidth.

Priority Group 1 queues (UC7, UC6, MC3) are not configurable as round robin queues. The `bandwidth percent` command is not available for these queues.

Examples

- These commands configure **unicast transmit queue 3** as a round robin queue, then allocates **5%, 15%, 25%, 35%, 8%, and 12%** bandwidth to unicast transmit queues **0** through **3** and multicast transmit queues **0** and **1**, respectively.

The **no priority** statement for **queue 3** also configures priority for all lower priority queues. Removing the statement reverts the other queues to **strict priority** type unless **running-config** contains a **no priority** statement for one of these queues.

```
switch(config)#interface ethernet 7
switch(config-if-Et7)#uc-tx-queue 3
switch(config-if-Et7-uc-txq-3)#no priority
switch(config-if-Et7-uc-txq-3)#bandwidth percent 5
switch(config-if-Et7-uc-txq-3)#uc-tx-queue 2
switch(config-if-Et7-uc-txq-2)#bandwidth percent 15
switch(config-if-Et7-uc-txq-2)#uc-tx-queue 1
switch(config-if-Et7-uc-txq-1)#bandwidth percent 25
switch(config-if-Et7-uc-txq-1)#uc-tx-queue 0
switch(config-if-Et7-uc-txq-0)#bandwidth percent 35
switch(config-if-Et7-uc-txq-0)#mc-tx-queue 1
switch(config-if-Et7-mc-txq-1)#bandwidth percent 12
switch(config-if-Et7-mc-txq-1)#mc-tx-queue 0
switch(config-if-Et7-mc-txq-0)#bandwidth percent 8
switch(config-if-Et7-mc-txq-0)#show qos interface ethernet 7
Ethernet7:
```

Port shaping rate: disabled

Tx-Queue	Bandwidth (percent)	Shape Rate (Kbps)	Priority	Priority Group
UC7	N/A	disabled	strict	1
UC6	N/A	disabled	strict	1
MC3	N/A	disabled	strict	1
UC5	N/A	disabled	strict	0
UC4	N/A	disabled	strict	0
MC2	N/A	disabled	strict	0
UC3	5	disabled	round-robin	0
UC2	15	disabled	round-robin	0
MC1	12	disabled	round-robin	0
UC1	25	disabled	round-robin	0
UC0	35	disabled	round-robin	0
MC0	8	disabled	round-robin	0

```
switch(config-if-Et7-mc-txq-0)#
```

- Changing the bandwidth percentage for unicast queue **3** to **30** changes the operational bandwidth of each queue to its configured bandwidth divided by **125%** (8%+12%+30%+15%+25%+35%).

```
switch(config-if-Et7-uc-txq-0)#uc-tx-queue 3
switch(config-if-Et7-uc-txq-3)#bandwidth percent 30
switch(config-if-Et7-uc-txq-3)#show qos interface ethernet 7
Ethernet7:
```

Port shaping rate: disabled

Tx-Queue	Bandwidth (percent)	Shape Rate (Kbps)	Priority	Priority Group
UC7	N/A	disabled	strict	1
UC6	N/A	disabled	strict	1
MC3	N/A	disabled	strict	1
UC5	N/A	disabled	strict	0

UC4	N/A	disabled	strict	0
MC2	N/A	disabled	strict	0
UC3	24	disabled	round-robin	0
UC2	12	disabled	round-robin	0
MC1	9	disabled	round-robin	0
UC1	20	disabled	round-robin	0
UC0	28	disabled	round-robin	0
MC0	6	disabled	round-robin	0

```
switch(config-if-Et7-uc-txq-3) #
```

9.1.7.5 ECN Configuration – Trident and Tomahawk Platform Switches

[Explicit Congestion Notification \(ECN\)](#) describes Explicit Congestion Notification (ECN).

ECN is independently configurable on all egress queues of each Ethernet interface. ECN settings for Port-Channels are applied on each of the channel's member Ethernet interfaces. ECN is also globally configurable to mark packets from the shared pool used for dynamically allocating memory to the queues. Multicast packets contribute to the globally shared pool and can contribute to global level congestion that result in ECN marking of unicast packets queued after the multicast packets.

Average queue length is tracked for transmit queues and the global pool independently. When either entity reaches its maximum threshold, all subsequent packets are marked.

Although the switch does not limit the number of queues that can be configured for ECN, hardware table limitations restrict the number of queues (including the global shared pool) that can simultaneously implement ECN.

The [qos random-detect ecn global-buffer \(Trident and Tomahawk\)](#) command enables ECN marking for globally shared packet memory and specifies minimum and maximum queue threshold sizes.

Examples

- This command enables ECN marking of unicast packets from the global data pool and sets the minimum and maximum thresholds at **20** and **500** segments.

```
switch(config) #qos random-detect ecn global-buffer minimum-threshold 20
segments
maximum-threshold 500 segments
switch(config) #
```

- This command disables ECN marking of unicast packets from the global data pool.

```
switch(config) #no qos random-detect ecn global-buffer
switch(config) #
```

The [random-detect ecn \(Trident and Tomahawk\)](#) command enables ECN marking for the configuration mode unicast transmit queue and specifies threshold queue sizes.

- These commands enable ECN marking of unicast packets from **transmit queue 4** of **interface Ethernet 15**, setting thresholds at **10** and **100** segments.

```
switch(config) #interface ethernet 15
switch(config-if-Et15) #uc-tx-queue 4
switch(config-if-Et15-uc-txq-4) #random-detect ecn minimum-threshold 10
segments
maximum-threshold 100 segments
switch(config-if-Et15-uc-txq-4) #show active
interface Ethernet15
uc-tx-queue 4
random-detect ecn minimum-threshold 10 segments maximum-threshold
100
segments
```



```
switch(config-if-Et15-uc-txq-4) #exit
switch(config-if-Et15) #
```

- This command disables ECN marking of unicast packets from *transmit queue 4* of *interface Ethernet 15*.

```
switch(config-if-Et15-uc-txq-4) #no random-detect ecn
switch(config-if-Et15-uc-txq-4) #show active
interface Ethernet15
switch(config-if-Et15-uc-txq-4) #exit
switch(config-if-Et15) #
```

9.1.8 QoS Configuration: Trident II and Helix Platform Switches

Implementing QoS on a Trident platform switch consists of configuring port trust settings, default port settings, default traffic classes, conversion maps, and transmit queues.

- [CoS and DSCP Port Settings – Trident II and Helix Platform Switches](#)
- [Traffic Class Derivations – Trident II and Helix Platform Switches](#)
- [CoS and DSCP Rewrite – Trident II and Helix Platform Switches](#)
- [Transmit Queues and Port Shaping – Trident II and Helix Platform Switches](#)
- [Ingress Policing on LAG](#)
- [Fabric QoS -- – Trident II Platform Switches](#)

9.1.8.1 CoS and DSCP Port Settings – Trident II and Helix Platform Switches

Configuring Port Trust Settings

The `qos trust` command configures the QoS port trust mode for the configuration mode interface. Trust enabled ports use packet CoS or DSCP values to classify traffic. The port-trust default for switched ports is **cos**. The port-trust default for routed ports is **dscp**.

- `qos trust cos` specifies **cos** as the port's port-trust mode.
- `qos trust dscp` specifies **dscp** as the port's port-trust mode.
- `no qos trust` specifies **untrusted** as the port's port-trust mode.

The `show qos interfaces trust` command displays the trust mode of specified interfaces.

Example

These commands configure and display the following trust modes:

- **Ethernet 7/1:** dscp.
- **Ethernet 7/2:** untrusted.
- **Ethernet 7/3:** cos.
- **Ethernet 7/4:** default as a switched port.
- **Ethernet 8/1:** default as a routed port.

```
switch(config) #interface ethernet 7/1
switch(config-if-Et7/1) #qos trust dscp
switch(config-if-Et7/1) #interface ethernet 7/2
switch(config-if-Et7/2) #no qos trust
switch(config-if-Et7/2) #interface ethernet 7/3
switch(config-if-Et7/3) #qos trust cos
switch(config-if-Et7/3) #interface ethernet 7/4
switch(config-if-Et7/4) #switchport
switch(config-if-Et7/4) #default qos trust
switch(config-if-Et7/4) #interface ethernet 8/1
switch(config-if-Et8/1) #no switchport
```

```

switch(config-if-Et8/1)#default qos trust
switch(config-if-Et8/1)#show qos interface ethernet 7/1 - 8/1 trust

Port                                     Trust Mode
                                     Operational   Configured
-----
Ethernet7/1                             DSCP
Ethernet7/2                             UNTRUSTED
Ethernet7/3                             COS
Ethernet7/4                             COS
Ethernet8/1                             DSCP
                                     DSCP
                                     DEFAULT
                                     DEFAULT

switch(config-if-Et8/1)#

```

Configuring Default Port Settings

Default CoS and DSCP settings are assigned to individual port channel and Ethernet interfaces. These configuration mode interface commands specify the port's default CoS and DSCP values.

- `qos cos` configures a port's default CoS value.
- `qos dscp` configures a port's default DSCP value.

Example

These commands configure default **CoS 4** and **DSCP 44** values on **interface Ethernet 7/3**.

```

switch(config)#interface ethernet 7/3
switch(config-if-Et7/3)#qos cos 4
switch(config-if-Et7/3)#qos dscp 44
switch(config-if-Et7/3)#show active

interface Ethernet7/3
  qos cos 4
  qos dscp 44

switch(config-if-Et7/3)#show qos interfaces ethernet 7/3

Ethernet7/3:
  Trust Mode: COS
  Default COS: 4
  Default DSCP: 44

switch(config-if-Et7/3)#

```

9.1.8.2 Traffic Class Derivations – Trident II and Helix Platform Switches

[Traffic Classes](#) describes traffic classes.

 **Note:** Qos traffic policy is supported on Trident II platform switches.

Traffic Class Derivation Source

The following table displays the source for deriving a data stream's traffic class.

Table 34: Traffic Class Derivation Source: Trident II Platform Switches

	Untrusted	CoS Trusted	DSCP Trusted
Untagged Non-IP	Default CoS (port)	Default CoS (port)	Default DSCP (port)
Untagged IP	Default CoS (port)	Default CoS (port)	DSCP (packet)

Tagged Non-IP	Default CoS (port)	CoS (packet)	Default DSCP (port)
Tagged IP	Default CoS (port)	CoS (packet)	DSCP (packet)

[CoS and DSCP Port Settings – Trident II and Helix Platform Switches](#) describes the default CoS and DSCP settings for each port.

Mapping CoS to Traffic Class

The `qos map cos` command assigns a traffic class to a list of CoS settings. Multiple commands create a complete CoS to traffic class map. The switch uses this map to assign a traffic class to data packets on the basis of the packet's CoS field or the port upon which it is received.

Example

This command assigns the *traffic class 5* to the classes of service **1, 3, 5, and 7**.

```
switch(config)#qos map cos 1 3 5 7 to traffic-class 5
switch(config)#show qos maps
  Number of Traffic Classes supported: 8

  Cos-tc map:
    cos:  0  1  2  3  4  5  6  7
    -----
    tc:   1  5  2  5  4  5  6  5

switch(config)#
```

The following table displays the default CoS–traffic class map on Trident II platform switches.

Table 35: Default CoS to Traffic Class Map: Trident II Platform Switches

Inbound CoS	0	1	2	3	4	5	6	7
Traffic Class	1	0	2	3	4	5	6	7

Mapping DSCP to Traffic Class

The `qos map dscp` command assigns a traffic class to a set of DSCP values. Multiple commands create a complete DSCP to traffic class map. The switch uses this map to assign a traffic class to data packets on the basis of the packet's DSCP field or the chip upon which it is received.

Example

This command assigns the *traffic class 0* to DSCP values of **12, 24, 41, and 44-47**.

```
switch(config)#qos map dscp 12 24 41 44 45 46 47 to traffic-class 0
switch(config)#show qos maps
  Number of Traffic Classes supported: 8

  Dscp-tc map:
    d1 :  d2 0  1  2  3  4  5  6  7  8  9
    -----
    0 :    1  1  1  1  1  1  1  1  0  0
    1 :    0  0  0  0  0  0  2  2  2  2
    2 :    2  2  2  2  0  3  3  3  3  3
    3 :    3  3  4  4  4  4  4  4  4  4
    4 :    5  0  5  5  0  0  0  0  6  6
    5 :    6  6  6  6  6  6  7  7  7  7
```

```

6 :      7 7 7 7
switch(config)#

```

The following table displays the default DSCP–traffic class map on Trident II platform switches.

Table 36: Default DSCP to Traffic Class Map: Trident II Platform Switches

Inbound DSCP	0-7	8-15	16-23	24-31	32-39	40-47	48-55	56-63
Traffic Class	1	0	2	3	4	5	6	7

9.1.8.3 CoS and DSCP Rewrite – Trident II and Helix Platform Switches

[Rewriting CoS and DSCP](#) describes the CoS and DSCP rewrite functions.

Traffic Class to CoS Rewrite Map

The CoS rewrite value is configurable and based on a data stream’s traffic class, as specified by the traffic class-CoS rewrite map. The `qos map traffic-class to cos` command assigns a CoS rewrite value to a list of traffic classes. Multiple commands create the complete traffic class–CoS rewrite map.

Example

This command assigns the CoS of two to traffic classes **1**, **3**, and **5**.

```

switch(config)#qos map traffic-class 1 3 5 to cos 2
switch(config)#show qos map

Number of Traffic Classes supported: 8

Tc-cos map:
tc:   0  1  2  3  4  5  6  7
-----
cos:  1  2  2  2  4  2  6  7

switch(config)#

```

The following table displays the default Traffic Class to CoS rewrite value map on Trident II platform switches.

Table 37: Default Traffic Class to CoS Rewrite Value Map: Trident II Platform Switches

Traffic Class	0	1	2	3	4	5	6	7
CoS Rewrite Value	1	0	2	3	4	5	6	7

Traffic Class to DSCP Rewrite Map

The DSCP rewrite value is configurable and based on a data stream’s traffic class, as specified by the traffic class-DSCP rewrite map. The `qos map traffic-class to dscp` command assigns a DSCP rewrite value to a list of traffic classes. Multiple commands create the complete traffic class-DSCP rewrite map.

Example

This command assigns the DSCP value of **29** to traffic classes **2**, **4**, and **6**.

```

switch(config)#qos map traffic-class 2 4 6 to dscp 29
switch(config)#show qos map

```

```

Number of Traffic Classes supported: 8

Tc-dscp map:
tc:    0  1  2  3  4  5  6  7
-----
dscp:  8  0 29 24 29 40 29 56

switch(config)#

```

The following table displays the default traffic class to DSCP rewrite map on Trident II platform switches.

Table 38: Traffic Class to DSCP Rewrite Value Map: Trident II Platform Switches

Traffic Class	0	1	2	3	4	5	6	7
DSCP	8	0	16	24	32	40	48	56

9.1.8.4 Transmit Queues and Port Shaping – Trident II and Helix Platform Switches

[Transmit Queues and Port Shaping](#) describes transmit queues and port shaping.

A data stream's traffic class determines the transmit queue it uses. The switch defines a single traffic class-transmit queue map for all Ethernet interfaces and is used for unicast and multicast traffic. The traffic class to transmit queue maps are configured globally and apply to all Ethernet and port channel interfaces. The [show qos maps](#) command displays the traffic class to transmit queue map.

Trident II platform switches have eight unicast (UC0 – UC7) and eight multicast (MC0 – MC7) queues. Each UCx-MCx queue set is combined into a single queue group (L1.x), which is exposed to the CLI through this command.

The following table displays the default traffic class to transmit queue maps.

Table 39: Default Traffic Class to Transmit Queue Map: Trident II Platform Switches

Traffic Class	0	1	2	3	4	5	6	7
Transmit Queue Group	0	1	2	3	4	5	6	7

Mapping Traffic Classes to a Transmit Queue

The [qos map traffic-class to tx-queue](#) command assigns traffic classes to a transmit queue. Multiple commands create the complete map.

Example

These commands assign traffic classes of **1, 3, and 5** to **transmit queue 1**, traffic classes **2, 4, and 6** to **transmit queue 2**, and **traffic class 0** to **transmit queue 0**, then display the resultant map.

```

switch(config)#qos map traffic-class 1 3 5 to tx-queue 1
switch(config)#qos map traffic-class 2 4 6 to tx-queue 2
switch(config)#qos map traffic-class 0 to tx-queue 0
switch(config)#show qos maps
Number of Traffic Classes supported: 8
Number of Transmit Queues supported: 8

Tc - tx-queue map:
tc:    0  1  2  3  4  5  6  7
-----

```

```
tx-queue: 0 1 2 1 2 1 2 7
switch(config)#
```

Entering a Transmit Queue Configuration Mode

Transmit queues are configurable on Ethernet ports and port channels. Queue parameters are configured in tx-queue configuration command mode, which is entered from the appropriate interface configuration mode. The `tx-queue` (Trident II) command places the switch in tx-queue configuration mode. The `show qos interfaces` displays the transmit queue configuration for a specified port.

Example

This command enters tx-queue configuration mode for **transmit queue 3** of **interface Ethernet 5**.

```
switch(config)#interface ethernet 5
switch(config-if-Et5)#tx-queue 3
switch(config-if-Et5-txq-3)#
```

Configuring the Shape Rate – Port and Transmit Queues

A port's shape rate specifies the port's maximum outbound traffic bandwidth. A shape rate can also be configured for all transmit queues on each port. All shape rate commands use kbps to specify data rates.

- To configure a port's shape rate, enter `shape rate (Interface – Trident II)` from the port's interface configuration mode.
- To configure a transmit queue's shape rate, enter `shape rate (Tx-queue – Trident II)` from the queue's tx-queue configuration mode.

Example

These commands configure a shape rate of **5 Gbs** on **interface Ethernet 3**, then configure the shape rate for the following transmit queues:

- transmit queues **0, 1, and 2: 500 Mbps**
- transmit queues **3, 4, and 5: 400 Mbps**

```
switch(config)#interface ethernet 17/3
switch(config-if-Et17/3)#shape rate 5000000
switch(config-if-Et17/3)#tx-queue 0
switch(config-if-Et17/3-txq-0)#shape rate 500000
switch(config-if-Et17/3-txq-0)#tx-queue 1
switch(config-if-Et17/3-txq-1)#shape rate 500000
switch(config-if-Et17/3-txq-1)#tx-queue 3
switch(config-if-Et17/3-txq-3)#shape rate 400000
switch(config-if-Et17/3-txq-3)#tx-queue 4
switch(config-if-Et17/3-txq-4)#shape rate 400000
switch(config-if-Et17/3-txq-4)#tx-queue 5
switch(config-if-Et17/3-txq-5)#shape rate 400000
switch(config-if-Et17/3-txq-5)#exit
switch(config-if-Et17/3)#show qos interface ethernet 17/3
Ethernet17/3:
```

Tx Queue	Bandwidth Guaranteed (units)	Shape Rate (units)	Priority
7	- / - (-)	- / - (-)	SP / SP
6	- / - (-)	- / - (-)	SP / SP
5	- / - (-)	400 / 400 (Mbps)	SP / SP
4	- / - (-)	400 / 400 (Mbps)	SP / SP

```

3      - / -      ( - )      400 / 400 ( Mbps )      SP / SP
2      - / -      ( - )      - / -      ( - )      SP / SP
1      - / -      ( - )      500 / 500 ( Mbps )      SP / SP
0      - / -      ( - )      500 / 500 ( Mbps )      SP / SP

```

```
switch(config-if-Et17/3) #
```

Configuring Queue Priority

Queue priority rank is denoted by the queue number; transmit queues with higher numbers have higher priority. Trident II supports strict priority queues; round robin queues are not supported.

The [bandwidth guaranteed \(Trident II\)](#) command configures specifies the minimum bandwidth for outbound traffic on the transmit queue.

Example

These commands configure a minimum egress bandwidth of **1 Mbps** for **transmit queue 4** on **interface Ethernet 17/3**.

```
switch(config-if-Et17/3) #tx-queue 4
switch(config-if-Et17/3-txq-4) #show qos interface ethernet 17/3
```

Tx Queue	Bandwidth Guaranteed (units)	Shape Rate (units)	Priority
7	- / - (-)	- / - (-)	SP / SP
6	- / - (-)	- / - (-)	SP / SP
5	- / - (-)	400 / 400 (Mbps)	SP / SP
4	1 / 1 (Mbps)	400 / 400 (Mbps)	SP / SP
3	- / - (-)	400 / 400 (Mbps)	SP / SP
2	- / - (-)	- / - (-)	SP / SP
1	- / - (-)	500 / 500 (Mbps)	SP / SP
0	- / - (-)	500 / 500 (Mbps)	SP / SP

```
switch(config-if-Et17/3-txq-4) #
```

9.1.8.5 Ingress Policing on LAG

Ingress policing on a port-channel polices the matched traffic from all member interfaces combined, i.e. it provides aggregate policing and statistics (DCS-7050X, DCS-7010T, DCS-7250X, and DCS-7300X series). When a per-interface policer is attached to a port-channel, one set of TCAM entries is created for all member interfaces. The associated interface bitmap is updated, and aggregate policing is performed on all member interfaces.

Examples

- These commands configure a service-policy (with policer action) on LAG by creating the service-policy and applying the service-policy on a port-channel.

```

switch(config) #policy-map policy-1
switch(config-pmap-qos-policy-1) #class class-1
switch(config-pmap-c-qos-policy-1-class-1) #police cir 512000 bps bc
96000
switch(config-pmap-c-qos-policy-1-class-1) #exit
switch(config-pmap-qos-policy-1) #exit
switch(config) #interface Et 4 / 5 / 4
switch(config-if-Et4/5/4) #channel-group 2 mode active
switch(config-if-Et4/5/4) #exit
switch(config) #interface po2
switch(config-if-Po2) #service-policy type qos input policy-1

```

```
switch(config-if-Po2)#exit
switch(config)#
```

- These commands configure ACL policing in single-rate, two-color mode.

```
switch(config)#class-map type qos match-any class1
switch(config-cmap-qos-class1)#match ip access-group acl1
switch(config-cmap-qos-class1)#exit
switch(config)#policy-map type quality-of-service policy1
switch(config-pmap-qos-policy1)#class class1
switch(config-pmap-c-qos-policy1-class1)#police cir 512000 bc 96000
switch(config-pmap-c-qos-policy1-class1)#exit
switch(config-pmap-qos-policy1)#exit
switch(config)#show policy-map
Service-policy policy1

Class-map: class1 (match-any)
  Match: ip access-group name acl1
        police rate 512000 bps burst-size 96000 bytes

Class-map: class-default (match-any)

switch(config)#
```

9.1.8.6 Fabric QoS -- Trident II Platform Switches

EOS is optimized to support QoS configuration on the Fabric interfaces on 7250x and 7300 series switches. Configuring QoS on the Fabric interfaces in addition to front panel ports allows user to have end-to-end control and helps to manage traffic better over these switches. By default, tx queues are configured as strict priority on 7250X and 7300X series.

The following QoS configuration options are supported on Fabric interfaces on 7250x and 7300 series switches.

- **Guaranteed Bandwidth:** In order to prevent queue starvation on fabric ports EOS supports minimum bandwidth configuration on per queue basis across all fabric ports.
- **Explicit Congestion Notification (ECN):** EOS supports enabling ECN on a per queue basis across all fabric ports.
- **Priority Flow Control (PFC):** Queue back-pressure propagates across the backplane such that flow control messages can be generated to the upstream devices. This is done by enabling PFC for the desired backplane traffic-classes.
- **Weight Round Robin (WRR):** EOS supports configuring Weighted Round Robin (WRR) on a per queue basis across all fabric ports.

9.1.8.6.1 Configuring Fabric QoS on 7250X and 7300X Series

Fabric QoS is configured using a QoS profiles which is then applied on fabric interfaces on 7250x and 7300x series. Following are the steps to configure Fabric QoS.

1. Use **qos profile** command to create a QoS profile.
2. Use **tx-queue (Trident II)** command to configure a transmit queue on the configuration mode interface.
3. Use **bandwidth guaranteed (Trident II)** command to specify the minimum bandwidth for outbound traffic on the transmit queue.
4. Use **random-detect ecn (Trident)** command to enable the ECN marking for the configuration mode unicast transmit queue and specifies threshold queue sizes.
5. Use **priority-flow-control priority** command to configure the packet resolution setting on the configuration mode interface.

6. Use `interface fabric` command to configure Fabric interface.
7. Use `service-profile` command to apply the QoS profile to the Fabric interface.

Examples

- These commands create a QoS profile named `fabricProfile` with tx queue, bandwidth, ECN, PFC and DLB values defined in it and then the profile is attached to Fabric interface of the switch.



Note: To support PFC on a particular priority, DLB is disabled for that priority.

```
switch(config)#qos profile fabricProfile
switch(config-qos-profile-fabricProfile)#tx-queue 0
switch(config-qos-profile-fabricProfile-txq-0)#bandwidth
guaranteed 10000 kbps
switch(config-qos-profile-fabricProfile-txq-0)#random-detect
ecn
minimum-threshold 10 mbytes maximum-threshold 10 mbytes
switch(config-qos-profile-fabricProfile)#priority-flow-control
priority 1
no-drop
switch(config-qos-profile-fabricProfile)#priority-flow-control
priority 6
no-drop dlb
```

- Applying the QoS profile on `interface fabric` of the switch.

```
switch#configure terminal
switch(config)#interface fabric
switch(config-if-fabric)#service-profile fabricProfile
```

9.1.8.6.2 Displaying Fabric QoS Information

These show commands display the configured Fabric QoS information on the switch.

- `show qos profile [profile Name]`: Displays the list of QoS profiles configured on the switch.
- `show qos interfaces fabric`: Displays the profile applied on the fabric interface on the switch.

Examples

- This command displays the `fabricProfile` profile information.

```
switch#show qos profile fabricProfile
qos profile fabricProfile
  priority-flow-control priority 1 no-drop
  priority-flow-control priority 6 no-drop dlb
  tx-queue 0
    bandwidth guaranteed 10000 kbps
    random-detect ecn minimum-threshold 10 mbytes maximum-thres
hold 10 mbytes
```

- This command displays the profile applied on the fabric interface.

```
switch#show qos interfaces fabric
qos profile fabricProfile
```

9.1.9 Support for Configuring Color Extended Communities

EOS Release 4.23.1F introduces the ability to configure the color extended community in route-map set clauses and in an `extcommunity-list` for inbound and outbound policy application.

Use the color extended community for per-destination steering into Segment-Routing Traffic-Engineered (SR-TE) policies. If the next-hop and color of a BGP route match a particular policy (composed of an endpoint and color), any traffic bound to the destination can be steered according to the policy instead of forwarded via an IGP path or tunnel.

This section describes support for configuring color extended communities, including configuration instructions and command descriptions. Topics covered by this section include:

- [Platform Compatibility](#)
- [Configuration](#)
- [Limitations](#)

9.1.9.1 Platform Compatibility

Configuring color extended communities is supported on all platforms.

9.1.9.2 Configuration

Use the following command for color extended community expressions:

`color COLOR-VALUE [color-only (exact-match | (endpoint-match (any | null)))]`

Use this command in route-maps and extcommunity-lists to apply inbound and outbound policy.

Configuring Color Extended Community in route-map mode	
Command(config-route-map mode)	<code>[no default] set extcommunity COLOR-EXPRESSION [additive delete]</code>
Action	Adds a color extended community to be applied to routes affected by the route-map. Multiple set clauses can be applied to a single route-map to configure multiple colors for routes. Additive adds the extended communities to those received, while delete deletes any matching extended color communities. Negating the command removes the entry from the route-map.
Default	None
Example	<pre>switch(config)#route-map foo switch(config-route-map foo)#set extcommunity color 1 switch(config-route-map foo)#set extcommunity color 2 color-only exact-match switch(config-route-map foo)#set extcommunity color 3 color-only endpoint-match null switch(config-route-map foo)#set extcommunity color 4 color-only endpoint-match any</pre>

Configuring Color Extended Community in extcommunity-list	
Command(config mode)	<code>[(no default)] ip extcommunity-list WORD (permit deny) {COLOR-EXPRESSION}</code>
Action	Adds a color extended community to an extcommunity-list. Multiple color extended communities can be added to the list. Negating the command removes the corresponding color extended community from the list.

Configuring Color Extended Community in extcommunity-list	
Default	None
Example	<pre>switch(config)#ip extcommunity-list foo permit color 1 color 2 switch(config)#ip extcommunity-list bar permit color 3 color-only endpoint-match null color 4 color-only endpoint-match any</pre>

9.1.9.3 Limitations

The color extended community is only supported in multi-agent mode. Enable Multi-agent mode via the following command:

```
service routing protocols mode multi-agent
```

9.1.10 ACL based QoS Configuration

9.1.10.1 ACL Based QoS (DCS-7160)

The IPv4 ACL based QoS is enabled on switches through policy-map configuration. The ACL based QoS can be configured on front panel ports, port-channel interfaces on **DCS-7160** series switches.

9.1.10.1.1 ACL based QoS on SVIs

The ACL based QoS policy applied on SVIs modify the QoS parameters for SVI traffic (L3 VLAN) based on ACL classification. The ACL based QoS on Switched Virtual Interface (SVI) ports is supported on DCS-7500E, DCS-7280E, DCS-7010, DCS-7050, DCS-7050X, DCS-7250X, DCS-7300X, DCS-7020TR.

9.1.10.1.2 ACL Sharing on QoS

The ACLs applied on QoS shares the hardware resources (TCAM) when potentially large QoS policy-maps are applied to multiple SVIs. For ACL based QoS on SVIs in sharing mode we share TCAM for class-maps without policer action and replicate entries for policer class-maps. The ACL Sharing on QoS is supported only on selected platforms.

The QoS actions is applicable only to the routed traffic flowing through the members of the corresponding VLAN.

The steps to configure ACL based QoS is as follows:

1. Create a access list using `ip access-list` command.
2. Create a class map and attach it to the access list using `class-map` command.
3. Create a policy and attach the class map to the policy created, using the `policy-map` command.
4. Apply the policy to the interface using the `service-policy input` command.

Examples

- These command configure the access list **acl1**.

```
switch(config)#ip access-list acl1
switch(config-acl-acl1)#permit ip 10.1.1.1/24 any
```

```
switch(config-acl-acl1) #exit
```

- These commands configure the class map **class1**.

```
switch(config) #class-map match-any class1
switch(config-cmap-qos-class1) #match ip access-group acl1
switch(config-cmap-qos-class1) #exit
```

- These commands configure the policy map **policy1**.

```
switch(config) #policy-map policy1
switch(config-pmap-qos-policy1) #class class1
switch(config-pmap-c-qos-policy1-class1) #set dscp 20
switch(config-pmap-c-qos-policy1-class1) #set traffic-class 2
switch(config-pmap-c-qos-policy1-class1) #exit
switch(config-pmap-c-qos-policy1) #exit
```

- These commands apply the **policy1** to the **interface Ethernet 1/1**.

```
switch(config) #interface Et1/1
switch(config-if-Et1/1) #service-policy input policy1
switch(config-if-Et1/1) #exit
```

- These commands configure a ACL based QoS on the SVI interface **VLAN10**.

```
switch(config) #interface vlan 10
switch(config-if-Vl10) #service-policy [type qos] input policy1
```

- This command enables the resource (hardware) sharing when a ACL based QoS is attached to VLAN interface. The no form of the command disables it.

```
switch(config) #hardware access-list qos resource sharing vlan in
```

Show Commands

The following show commands display the status of policy-maps programmed on the interface, for more information on these commands refer [Quality of Service Configuration Commands](#).

- **show policy-map [policy-name]**: Displays the policy-map programming status.
- **show policy-map interface interface id**: Displays the policy-map that is currently programmed on the interface.
- **show policy-map [policy-name] counters**: Displays the policy-map traffic hits.
- **show platform xp qos tcam [hits]**: Displays the TCAM entries programmed for each policy-map as well as the traffic hits. The hits option is used to see the TCAM entries with nonzero traffic hits.
- **show run | grep sharing**: Displays if whether the ACL based QoS is enabled or disabled.
- **show platform trident tcam shared vlan interface-class-id**: Displays what SVIs are currently sharing the QoS policy-map.
- **show platform trident tcam qos detail**: Displays the list of all the SVIs that are sharing the TCAM entries.

9.1.10.1.3 Limitations

- Maximum number of TCAM entries that can be programmed in hardware for all QoS policy-maps on the box is 1024.
- Layer 4 port ranges are not supported for ACL based QoS. The ranges will be expanded into multiple TCAM rules and programmed in the hardware.
- Configured policer rate should be above 1mbps and recommended burst value is 2000 bytes.
- Policer action can't be associated with policy-maps applied to Port-Channels.

The following are the limitations specific to DCS-7500E, DCS-7280E and DCS-7020TR:

- User cannot apply more than 31 QoS service policies per chip on L3 interfaces.
 - When different QoS service policies are applied to the SVI and its member interfaces, the behavior is indeterministic.
 - When QoS service policies are applied on SVIs with partial failures due to limited hardware resources, any event that triggers a forwarding agent restart will lead to indeterministic behavior.
 - When QoS service policies are applied on 2 SVIs, any event that triggers the VLAN membership change of a member interface may result in a policy-map programming failure. To change the VLAN membership, remove the interface from the first VLAN and then add it to the other.
 - Outgoing COS rewrite is not supported.
 - QoS policy-map counters are not supported.

The following are the limitations specific to DCS-7010, DCS-7050, DCS-7050X, DCS-7250X, DCS-7300X:

- TCAM resources won't be shared for the same policy-map applied to multiple SVIs.
- Policy-map applied to a SVI will result in TCAM allocation on all chips irrespective of whether the SVI members are present or not.

When QoS service policies are applied to both SVI and its member interfaces and packets hit both policies, the behavior is indeterministic.

9.1.11 Quality of Service Configuration Commands

QoS Data Field and Traffic Class Configuration Commands

- `color`
- `hardware access-list qos resource sharing vlan in`
- `ip extcommunity-list`
- `platform petraA traffic-class`
- `qos cos`
- `qos dscp`
- `qos map cos`
- `qos map dscp`
- `qos map traffic-class to cos`
- `qos map traffic-class to dscp`
- `qos map traffic-class to mc-tx-queue`
- `qos map traffic-class to tx-queue`
- `qos map traffic-class to uc-tx-queue`
- `qos profile`
- `qos rewrite cos`
- `qos rewrite dscp`
- `qos trust`
- `service-policy type qos input`
- `service-profile`
- `set extcommunity`

QoS and ECN Display Commands

- `show platform petraA traffic-class`
- `show platform trident tcam shared vlan interface-class-id`
- `show platform trident tcam qos detail`
- `show platform xp qos tcam hit`
- `show policy-map`
- `show policy-map interface`
- `show qos interfaces`
- `show qos interfaces latency maximum`
- `show qos interfaces trust`
- `show qos interfaces random-detect ecn`
- `show qos maps`
- `show qos profile`
- `show run|grep sharing`
- `show qos profile summary`
- `show qos random-detect ecn`

ECN Configuration Commands

- `qos random-detect ecn allow non-ect chip-based (Tomahawk and Trident)`
- `qos random-detect ecn global-buffer (Helix)`
- `qos random-detect ecn global-buffer (Trident and Tomahawk)`
- `random-detect ecn (Arad/Jericho)`
- `random-detect ecn (Helix)`
- `random-detect ecn (Trident and Tomahawk)`

Transmit Queue and Port Shaping Commands – Arad and Jericho Platforms

- [bandwidth percent \(Arad/Jericho\)](#)
- [priority \(Arad/Jericho\)](#)
- [shape rate \(Interface – Arad/Jericho\)](#)
- [shape rate \(Tx-queue – Arad/Jericho\)](#)
- [tx-queue \(Arad/Jericho\)](#)

Transmit Queue and Port Shaping Commands – FM6000 Platform

- [bandwidth percent \(FM6000\)](#)
- [priority \(FM6000\)](#)
- [shape rate \(Interface – FM6000\)](#)
- [shape rate \(Tx-queue – FM6000\)](#)
- [tx-queue \(FM6000\)](#)

Transmit Queue and Port Shaping Commands – Helix Platform

- [bandwidth guaranteed \(Helix\)](#)
- [shape rate \(Interface – Helix\)](#)
- [shape rate \(Tx-queue – Helix\)](#)
- [tx-queue \(Helix\)](#)

Transmit Queue and Port Shaping Commands – Petra Platform

- [bandwidth percent \(Petra\)](#)
- [priority \(Petra\)](#)
- [shape rate \(Interface – Petra\)](#)
- [shape rate \(Tx-queue – Petra\)](#)
- [tx-queue \(Petra\)](#)

Transmit Queue and Port Shaping Commands – Trident and Tomahawk Platform

- [bandwidth percent \(Trident and Tomahawk\)](#)
- [mc-tx-queue](#)
- [priority \(Trident and Tomahawk\)](#)
- [shape rate \(Interface – Trident and Tomahawk\)](#)
- [shape rate \(Tx-queue – Trident and Tomahawk\)](#)
- [uc-tx-queue](#)

Transmit Queue and Port Shaping Commands – Trident II Platform

- [bandwidth guaranteed \(Trident II\)](#)
- [shape rate \(Tx-queue – Trident II\)](#)
- [shape rate \(Interface – Trident II\)](#)
- [tx-queue \(Trident II\)](#)
- [interface fabric \(Trident II\)](#)

9.1.11.1 bandwidth guaranteed (Helix)

The **bandwidth guaranteed** command specifies the minimum bandwidth for outbound traffic on the transmit queue. By default, no bandwidth is guaranteed to any transmit queue.

The **no bandwidth guaranteed** and **default bandwidth guaranteed** commands remove the minimum bandwidth guarantee on the transmit queue by deleting the corresponding **bandwidth guaranteed** command from *running-config*.

Command Mode

Tx-Queue Configuration

Command Syntax

```
bandwidth guaranteed rate DATA_MIN
```

```
no bandwidth guaranteed
```

```
default bandwidth guaranteed
```

Parameters

- **DATA_MIN** Minimum bandwidth. Value range varies with data unit:
 - **<8 to 40000000> 8 to 40000000** kbytes per second.
 - **<8 to 40000000>kbps 8 to 40000000** kbytes per second.
 - **<1 to 60000000>pps 1 to 60000000** packets per second.

Related Command

[tx-queue \(Helix\)](#) places the switch in tx-queue configuration mode.

Example

These commands configure a minimum egress bandwidth of 1 Mbps for *transmit queue 4* of *interface Ethernet 17/3*.

```
switch(config)#interface ethernet 17
switch(config-if-Et17)#tx-queue 4
switch(config-if-Et17-txq-4)#bandwidth guaranteed 1000 kbps
switch(config-if-Et17-txq-4)#show qos interfaces ethernet 17
```

Ethernet17/3:

```
Trust Mode: COS
Default COS: 0
Default DSCP: 0
```

Port shaping rate: disabled

Tx Queue	Bandwidth Guaranteed (units)	Shape Rate (units)	Priority
7	- / - (-)	- / - (-)	SP / SP
6	- / - (-)	- / - (-)	SP / SP
5	- / - (-)	- / - (-)	SP / SP
4	1 / 1 (Mbps)	- / - (-)	SP / SP
3	- / - (-)	- / - (-)	SP / SP
2	- / - (-)	- / - (-)	SP / SP
1	- / - (-)	- / - (-)	SP / SP
0	- / - (-)	- / - (-)	SP / SP

Note: Values are displayed as Operational/Configured

```
switch(config-if-Et17-txq-4) #
```

9.1.11.2 bandwidth guaranteed (Trident II)

The **bandwidth guaranteed** command specifies the minimum bandwidth for outbound traffic on the transmit queue. By default, no bandwidth is guaranteed to any transmit queue.

The **no bandwidth guaranteed** and **default bandwidth guaranteed** commands remove the minimum bandwidth guarantee on the transmit queue by deleting the corresponding **bandwidth guaranteed** command from *running-config*.

Command Mode

Tx-Queue Configuration

Command Syntax

```
bandwidth guaranteed rate DATA_MIN
```

```
no bandwidth guaranteed
```

```
default bandwidth guaranteed
```

Parameters

- **DATA_MIN** minimum bandwidth. Value range varies with data unit:
 - **8** to **40000000** kbytes per second.
 - **8** to **40000000 kbps** kbytes per second.
 - **1** to **60000000pps** packets per second.

Related Commands

[tx-queue \(Trident II\)](#) places the switch in tx-queue configuration mode.

Example

These commands configure a minimum egress bandwidth of 1 Mbps for *transmit queue 4* of *interface Ethernet 17/3*.

```
switch(config)#interface ethernet 17/3
switch(config-if-Et17/3)#tx-queue 4
switch(config-if-Et17/3-txq-4)#bandwidth guaranteed 1000 kbps
switch(config-if-Et17/3-txq-4)#show qos interfaces ethernet 17/3
```

```
Ethernet17/3:
```

```
Trust Mode: COS
Default COS: 0
Default DSCP: 0
```

```
Port shaping rate: disabled
```

Tx Queue	Bandwidth Guaranteed (units)	Shape Rate (units)	Priority
7	- / - (-)	- / - (-)	SP / SP
6	- / - (-)	- / - (-)	SP / SP
5	- / - (-)	- / - (-)	SP / SP
4	1 / 1 (Mbps)	- / - (-)	SP / SP
3	- / - (-)	- / - (-)	SP / SP
2	- / - (-)	- / - (-)	SP / SP
1	- / - (-)	- / - (-)	SP / SP
0	- / - (-)	- / - (-)	SP / SP

Note: Values are displayed as Operational/Configured

```
switch(config-if-Et17/3-txq-4) #
```

9.1.11.3 bandwidth percent (Arad/Jericho)

The **bandwidth percent** command configures the bandwidth share of the transmit queue when configured for round robin priority. Bandwidth is allocated to all queues based on the cumulative configured bandwidth of all the port's round robin queues.

The cumulative operational bandwidth of all round robin queues is always less than or equal to 100%. If the cumulative configured bandwidth is greater than 100%, each port's operational bandwidth is its configured bandwidth divided by the cumulative configured bandwidth.

The **no bandwidth percent** and **default bandwidth percent** commands restore the default bandwidth share of the transmit queue by removing the corresponding **bandwidth percent** command from *running-config*.

Command Mode

Tx-Queue Configuration

Command Syntax

```
bandwidth percent proportion
```

```
no bandwidth percent
```

```
default bandwidth percent
```

Parameters

proportion Bandwidth percentage assigned to queues. Values range from **1** to **100**.

Related Command

[tx-queue \(Arad/Jericho\)](#) places the switch in tx-queue configuration mode.

Examples

- These commands configure queues **0** through **3** (**interface Ethernet 3/5/1**) as round robin, then allocate bandwidth for three queues at **30%** and one queue at **10%**.

```
switch(config)#interface ethernet 3/5/1
switch(config-if-Et3/5/1)#tx-queue 3
switch(config-if-Et3/5/1-txq-3)#no priority
switch(config-if-Et3/5/1-txq-3)#bandwidth percent 10
switch(config-if-Et3/5/1-txq-3)#tx-queue 2
switch(config-if-Et3/5/1-txq-2)#bandwidth percent 30
switch(config-if-Et3/5/1-txq-2)#tx-queue 1
switch(config-if-Et3/5/1-txq-1)#bandwidth percent 30
switch(config-if-Et3/5/1-txq-1)#tx-queue 0
switch(config-if-Et3/5/1-txq-0)#bandwidth percent 30
switch(config-if-Et3/5/1-txq-0)#show qos interfaces ethernet
3/5/1
```

Ethernet3/5/1:

Tx Queue	Bandwidth (percent)	Shape Rate (units)	Priority	ECN
7	- / -	- / - (-)	SP / SP	D
6	- / -	- / - (-)	SP / SP	D
5	- / -	- / - (-)	SP / SP	D
4	- / -	- / - (-)	SP / SP	D
3	10 / 10	- / - (-)	RR / RR	D
2	30 / 30	- / - (-)	RR / SP	D
1	30 / 30	- / - (-)	RR / SP	D
0	30 / 30	- / - (-)	RR / SP	D

```
switch(config-if-Et3/5/1-txq-0)#
```

- These commands re-configure the bandwidth share of the fourth queue at **30%**.

```
switch(config-if-Et3/5/1-txq-0)#tx-queue 3
switch(config-if-Et3/5/1-txq-3)#bandwidth percent 30
switch(config-if-Et3/5/1-txq-3)#show qos interfaces ethernet
3/5/1
```

```
Ethernet3/5/1:
```

```
Port shaping rate: disabled
```

Tx Queue	Bandwidth (percent)	Shape Rate (units)	Priority	ECN
7	- / -	- / - (-)	SP / SP	D
6	- / -	- / - (-)	SP / SP	D
5	- / -	- / - (-)	SP / SP	D
4	- / -	- / - (-)	SP / SP	D
3	24 / 30	- / - (-)	RR / RR	D
2	24 / 30	- / - (-)	RR / SP	D
1	24 / 30	- / - (-)	RR / SP	D
0	24 / 30	- / - (-)	RR / SP	D

Note: Values are displayed as Operational/Configured

```
switch(config-if-Et3/5/1-txq-3)#
```

- These commands configure the bandwidth share of the fourth queue at **2%**.

```
switch(config-if-Et3/5/1-txq-3)#bandwidth percent 2
switch(config-if-Et3/5/1-txq-3)#show qos interfaces ethernet
3/5/1
```

```
Ethernet3/5/1:
```

```
Port shaping rate: disabled
```

Tx Queue	Bandwidth (percent)	Shape Rate (units)	Priority	ECN
7	- / -	- / - (-)	SP / SP	D
6	- / -	- / - (-)	SP / SP	D
5	- / -	- / - (-)	SP / SP	D
4	- / -	- / - (-)	SP / SP	D
3	2 / 2	- / - (-)	RR / RR	D
2	30 / 30	- / - (-)	RR / SP	D
1	30 / 30	- / - (-)	RR / SP	D
0	30 / 30	- / - (-)	RR / SP	D

Note: Values are displayed as Operational/Configured

```
switch(config-if-Et3/5/1-txq-3)#
```

9.1.11.4 bandwidth percent (FM6000)

The **bandwidth percent** command configures the bandwidth share of the transmit queue when configured for round robin priority. Bandwidth is allocated to all queues based on the cumulative configured bandwidth of all the port's round robin queues.

The cumulative operational bandwidth of all round robin queues is always less than or equal to 100%. If the cumulative configured bandwidth is greater than 100%, each port's operational bandwidth is its configured bandwidth divided by the cumulative configured bandwidth.

The **no bandwidth percent** and **default bandwidth percent** commands restore the default bandwidth share of the transmit queue by removing the corresponding **bandwidth percent** command *running-config*.

Command Mode

Tx-Queue Configuration

Command Syntax

```
bandwidth percent proportion
no bandwidth percent
default bandwidth percent
```

Parameters

proportion Configured bandwidth percentage. Value ranges from **1** to **100**. Default value is **0**.

Related Command

[tx-queue \(FM6000\)](#) places the switch in tx-queue configuration mode.

Examples

- These commands configure queues **0** through **3** (**Ethernet interface 19**) as round robin, then allocate bandwidth for three queues at **30%** and one queue at **10%**.

```
switch(config)#interface Ethernet 19
switch(config-if-Et19)#tx-queue 3
switch(config-if-Et19-txq-3)#no priority
switch(config-if-Et19-txq-3)#bandwidth percent 10
switch(config-if-Et19-txq-3)#tx-queue 2
switch(config-if-Et19-txq-2)#bandwidth percent 30
switch(config-if-Et19-txq-2)#tx-queue 1
switch(config-if-Et19-txq-1)#bandwidth percent 30
switch(config-if-Et19-txq-1)#tx-queue 0
switch(config-if-Et19-txq-0)#bandwidth percent 30
switch(config-if-Et19-txq-0)#show qos interface ethernet 19
```

```
Ethernet19:
  Trust Mode: COS
  Default COS: 0
  Default DSCP: 0
```

Port shaping rate: disabled

Tx	Bandwidth	Bandwidth	Shape Rate	Priority
ECN/WRED	Queue (percent)	Guaranteed (units)	units)	

```

7   - / -   - / -   ( - )   - / -   ( - )   SP / SP
D
6   - / -   - / -   ( - )   - / -   ( - )   SP / SP
D
5   - / -   - / -   ( - )   - / -   ( - )   SP / SP
D
4   - / -   - / -   ( - )   - / -   ( - )   SP / SP
D
3   10 / 10  - / -   ( - )   - / -   ( - )   RR / RR
D
2   30 / 30  - / -   ( - )   - / -   ( - )   RR / SP
D
1   30 / 30  - / -   ( - )   - / -   ( - )   RR / SP
D
0   30 / 30  - / -   ( - )   - / -   ( - )   RR / SP
D

```

Note: Values are displayed as Operational/Configured

Legend:

RR -> Round Robin

SP -> Strict Priority

- -> Not Applicable / Not Configured

ECN/WRED: L -> Queue Length ECN Enabled W -> WRED Enabled

D -> Disabled

- These commands re-configure the bandwidth share of *transmit queue 3* at **30%**.

```

cp118.14:04:20#config
cp118.14:04:23(config)#interface Ethernet 19
cp118.14:04:47(config-if-Et19-txq-0)#tx-queue 3
cp118.14:04:59(config-if-Et19-txq-3)#bandwidth percent 30
cp118.14:05:16(config-if-Et19-txq-3)#show qos interface
ethernet 19

```

Ethernet19:

Trust Mode: COS

Default COS: 0

Default DSCP: 0

Port shaping rate: disabled

Tx Queue	Bandwidth (percent)	Bandwidth Guaranteed (units)	ECN/WRED	Shape Rate (units)	Priority
7	- / -	- / -	(-)	- / - (-)	SP / SP
D					
6	- / -	- / -	(-)	- / - (-)	SP / SP
D					
5	- / -	- / -	(-)	- / - (-)	SP / SP
D					
4	- / -	- / -	(-)	- / - (-)	SP / SP
D					
3	24 / 30	- / -	(-)	- / - (-)	RR / RR
D					
2	24 / 30	- / -	(-)	- / - (-)	RR / SP
D					
1	24 / 30	- / -	(-)	- / - (-)	RR / SP
D					

```

0   24 / 30   - / -   ( - )   - / -   ( - )   RR / SP
D

```

Note: Values are displayed as Operational/Configured

Legend:

RR -> Round Robin

SP -> Strict Priority

- -> Not Applicable / Not Configured

ECN/WRED: L -> Queue Length ECN Enabled

W -> WRED Enabled

D -> Disabled

- These commands re-configure the bandwidth share of **transmit queue 3 at 2%**.

```

cp118.14:09:37(config-if-Et19-txq-3)#bandwidth percent 2
cp118.14:12:56(config-if-Et19-txq-3)#show qos interface
ethernet 19

```

Ethernet19:

Trust Mode: COS

Default COS: 0

Default DSCP: 0

Port shaping rate: disabled

Tx Queue	Bandwidth (percent)	Bandwidth Guaranteed (units)	ECN/WRED	Shape Rate (units)	Priority
7	- / -	- / -	(-)	- / - (-)	SP / SP
D					
6	- / -	- / -	(-)	- / - (-)	SP / SP
D					
5	- / -	- / -	(-)	- / - (-)	SP / SP
D					
4	- / -	- / -	(-)	- / - (-)	SP / SP
D					
3	2 / 2	- / -	(-)	- / - (-)	RR / RR
D					
2	30 / 30	- / -	(-)	- / - (-)	RR / SP
D					
1	30 / 30	- / -	(-)	- / - (-)	RR / SP
D					
0	30 / 30	- / -	(-)	- / - (-)	RR / SP
D					

Note: Values are displayed as Operational/Configured

Legend:

RR -> Round Robin

SP -> Strict Priority

- -> Not Applicable / Not Configured

ECN/WRED: L -> Queue Length ECN Enabled

W -> WRED Enabled

D -> Disabled

9.1.11.5 bandwidth percent (Petra)

The **bandwidth percent** command configures the bandwidth share of the transmit queue when configured for round robin priority. Bandwidth is allocated to all queues based on the cumulative configured bandwidth of all the port's round robin queues.

The cumulative operational bandwidth of all round robin queues is always less than or equal to 100%. If the cumulative configured bandwidth is greater than 100%, each port's operational bandwidth is its configured bandwidth divided by the cumulative configured bandwidth.

The **no bandwidth percent** and **default bandwidth percent** commands restore the default bandwidth share of the transmit queue by removing the corresponding **bandwidth percent** command *running-config*.

Command Mode

Tx-Queue Configuration

Command Syntax

```
bandwidth percent proportion
```

```
no bandwidth percent
```

```
default bandwidth percent
```

Parameters

proportion Bandwidth percentage assigned to queues. Values range from **1** to **100**.

Related Command

[tx-queue \(Petra\)](#) places the switch in tx-queue configuration mode.

Examples

- These commands configure queues **0** through **3** (**interface Ethernet 3/28**) as round robin, then allocate bandwidth for three queues at **30%** and one queue at **10%**.

```
switch(config)#interface ethernet 3/28
switch(config-if-Et3/28)#tx-queue 3
switch(config-if-Et3/28-txq-3)#no priority
switch(config-if-Et3/28-txq-3)#bandwidth percent 10
switch(config-if-Et3/28-txq-3)#tx-queue 2
switch(config-if-Et3/28-txq-2)#bandwidth percent 30
switch(config-if-Et3/28-txq-2)#tx-queue 1
switch(config-if-Et3/28-txq-1)#bandwidth percent 30
switch(config-if-Et3/28-txq-1)#tx-queue 0
switch(config-if-Et3/28-txq-0)#bandwidth percent 30
switch(config-if-Et3/28-txq-0)#show qos interface ethernet
3/28
```

Ethernet3/28:

Tx-Queue	Bandwidth (percent)	Shape Rate (Kbps)	Priority
7	N/A	disabled	strict
6	N/A	disabled	strict
5	N/A	disabled	strict
4	N/A	disabled	strict
3	10	disabled	round-robin
2	30	disabled	round-robin
1	30	disabled	round-robin
0	30	disabled	round-robin

```
switch(config-if-Et3/28-txq-0) #
```

- These commands re-configure the bandwidth share of the fourth queue at **30%**.

```
switch(config-if-Et3/28-txq-0) #tx-queue 3  
switch(config-if-Et3/28-txq-3) #bandwidth percent 30  
switch(config-if-Et3/28-txq-3) #show qos interface ethernet  
3/28
```

```
Ethernet3/28:
```

```
Trust Mode: COS
```

Tx-Queue	Bandwidth (percent)	Shape Rate (Kbps)	Priority
7	N/A	disabled	strict
6	N/A	disabled	strict
5	N/A	disabled	strict
4	N/A	disabled	strict
3	24	disabled	round-robin
2	24	disabled	round-robin
1	24	disabled	round-robin
0	24	disabled	round-robin

```
switch(config-if-Et3/28-txq-3) #
```

- These commands configure the bandwidth share of the fourth queue at **2%**.

```
switch(config-if-Et3/28) #tx-queue 3  
switch(config-if-Et3/28-txq-3) #bandwidth percent 2  
switch(config-if-Et3/28-txq-3) #show qos interface ethernet  
3/28
```

```
Ethernet3/28:
```

```
Trust Mode: COS
```

Tx-Queue	Bandwidth (percent)	Shape Rate (Kbps)	Priority
7	N/A	disabled	strict
6	N/A	disabled	strict
5	N/A	disabled	strict
4	N/A	disabled	strict
3	2	disabled	round-robin
2	30	disabled	round-robin
1	30	disabled	round-robin
0	30	disabled	round-robin

```
switch(config-if-Et3/28-txq-3) #
```

9.1.11.6 bandwidth percent (Trident and Tomahawk)

The **bandwidth percent** command configures the bandwidth share of the transmit queue when configured for round robin priority. Bandwidth is allocated to all queues based on the cumulative configured bandwidth of all the port's round robin queues.

The cumulative operational bandwidth of all round robin queues is always less than or equal to 100%. If the cumulative configured bandwidth is greater than 100%, each port's operational bandwidth is its configured bandwidth divided by the cumulative configured bandwidth.

The **no bandwidth percent** and **default bandwidth percent** commands restore the default bandwidth share of the transmit queue by removing the corresponding **bandwidth percent** command *running-config*.

Command Mode

Mc-Tx-Queue configuration

Uc-Tx-Queue configuration

Command Syntax

```
bandwidth percent proportion
```

```
no bandwidth percent
```

```
default bandwidth percent
```

Parameters

proportion Bandwidth percentage assigned to queues. Values range from **1** to **100**.

Related Commands

- [mc-tx-queue](#) places the switch in mc-tx-queue configuration mode.
- [uc-tx-queue](#) places the switch in uc-tx-queue configuration mode.

Examples

- These commands configure **unicast transmit queue 3** (and all other queues of lower priority) as round robin, then allocate bandwidth for unicast transmit queues **1, 2, and 3** at **30%** and **multicast transmit queue 1** at **10%**.

```
switch(config)#interface ethernet 7
switch(config-if-Et7)#uc-tx-queue 3
switch(config-if-Et7-uc-txq-3)#no priority
switch(config-if-Et7-uc-txq-3)#bandwidth percent 30
switch(config-if-Et7-uc-txq-3)#uc-tx-queue 2
switch(config-if-Et7-uc-txq-2)#bandwidth percent 30
switch(config-if-Et7-uc-txq-2)#uc-tx-queue 1
switch(config-if-Et7-uc-txq-1)#bandwidth percent 30
switch(config-if-Et7-uc-txq-1)#mc-tx-queue 1
switch(config-if-Et7-mc-txq-1)#bandwidth percent 10
switch(config-if-Et7-mc-txq-1)#show qos interfaces ethernet 7
```

```
Ethernet7:
```

```
Trust Mode: COS
```

```
Default COS: 0
```

```
Default DSCP: 0
```

```
Port shaping rate: disabled
```

Tx-Queue Group	Bandwidth (percent)	Shape Rate (Kbps)	Priority	Priority
-------------------	------------------------	----------------------	----------	----------

```

-----
1      UC7      N/A      disabled      strict
1      UC6      N/A      disabled      strict
1      MC3      N/A      disabled      strict
1      UC5      N/A      disabled      strict
0      UC4      N/A      disabled      strict
0      MC2      N/A      disabled      strict
0      UC3      30      disabled      round-robin
0      UC2      30      disabled      round-robin
0      MC1      10      disabled      round-robin
0      UC1      30      disabled      round-robin
0      UC0      0       disabled      round-robin
0      MC0      0       disabled      round-robin
0

switch(config-if-Et7-mc-txq-1)#

```

- These commands re-configure the bandwidth share of *unicast queue 3* at **55%**.

```

switch(config-if-Et7-mc-txq-1)#uc-tx-queue 3
switch(config-if-Et7-uc-txq-3)#bandwidth percent 55
switch(config-if-Et7-uc-txq-3)#show qos interface ethernet 7

Ethernet7:
Trust Mode: COS
Default COS: 0
Default DSCP: 0

Port shaping rate: disabled

Tx-Queue   Bandwidth   Shape Rate   Priority   Priority
Group      (percent)   (Kbps)

-----
1      UC7      N/A      disabled      strict
1      UC6      N/A      disabled      strict
1      MC3      N/A      disabled      strict
1      UC5      N/A      disabled      strict
0      UC4      N/A      disabled      strict
0      MC2      N/A      disabled      strict
0      UC3      44      disabled      round-robin
0      UC2      24      disabled      round-robin
0

```

```
0      MC1      8      disabled  round-robin
0      UC1     24      disabled  round-robin
0      UC0      0      disabled  round-robin
0      MC0      0      disabled  round-robin
0

switch(config-if-Et7-uc-txq-3) #
```

9.1.11.7 color

Use the `color` command for the ability to configure the color extended community in route-map set clauses and in an extcommunity-list for inbound and outbound policy application.

Command Mode

Route-maps and extcommunity-lists

Command Syntax

```
color COLOR-VALUE [ color-only [ exact-match | [ endpoint-match [any | null ]]]]
```

Parameters

- **COLOR-VALUE** A single policy color value, range **0** to **4294967295**.
- **color-only** Allows configuration of color-only bits.
- **exact-match** Explicitly sets the color-only bits of the extended community to **00** (optional).
- **endpoint-match any** Sets the color-only bits of the extended community to **10**.
- **endpoint-match null** Sets the color-only bits of the extended community to **01**.

Example

```
switch(config)#route-map foo
switch(config0route-map-foo)#set community color 2 color-only endpoint-
match any
```

9.1.11.8 hardware access-list qos resource sharing vlan in

The **hardware access-list qos resource sharing vlan in** command enables the ACL based QoS resources sharing on a VLAN interface.

The **no hardware access-list qos resource sharing vlan in** disables the ACL based QoS resources sharing on a VLAN interface. By default this function is disabled.

Command Mode

Global Configuration

Command Syntax

```
hardware access-list qos resource sharing vlan in
```

```
no hardware access-list qos resource sharing vlan in
```

Example

This commands enables the ACL based QoS resources sharing on a VLAN interface.

```
switch(config)#hardware access-list qos resource sharing vlan in
```

9.1.11.9 interface fabric (Trident II)

The **interface fabric** command places the switch in Fabric-interface configuration mode and allows the user to attach the QoS profile to the fabric interface of the switch.

Command Mode

Global Configuration

Command Syntax

```
interface fabric
```

Example

This command places the switch in Fabric-interface configuration mode.

```
switch(config) #interface fabric  
switch(config-if-fabric) #
```

9.1.11.10 ip extcommunity-list

The `ip extcommunity-list` command adds a color extended community to an extcommunity-list. Multiple color extended communities can be added to the list. Negating the command removes the corresponding color extended community from the list.

Command Mode

Configuration mode

Command Syntax

```
ip extcommunity-list WORD [permit | deny] [COLOR-EXPRESSION]
no ip extcommunity-list WORD [permit | deny] COLOR-EXPRESSION]
default ip extcommunity-list WORD [permit | deny] [COLOR-EXPRESSION]
```

Parameters

- **WORD** Community list name.
- **permit** Specifies community to accept.
- **deny** Specifies community to reject.
- **COLOR-EXPRESSION** Color extended community.

Example

```
arista(config)#ip extcommunity-list foo permit color 1 color 2
arista(config)#ip extcommunity-list bar permit color 3 color-only
endpoint-match null color 4 color-only endpoint-match any
```

9.1.11.11 mc-tx-queue

The `mc-tx-queue` command places the switch in mc-tx-queue configuration mode to configure a multicast transmit queue on the configuration mode interface. Mc-tx-queue configuration mode is not a group change mode; *running-config* is changed immediately after commands are executed. The `exit` command does not affect the configuration.

Trident and Tomahawk switches have four multicast queues (MC0 – MC3) and eight unicast queues (UC0 – UC7), categorized into two priority groups. All queues are exposed through the CLI and are user configurable.

- **Priority Group 1:** UC7, UC6, MC3
- **Priority Group 0:** UC5, UC4, MC2, UC3, UC2, MC1, UC1, UC0, MC0

The `exit` command returns the switch to the configuration mode for the base Ethernet or port channel interface.

The `no mc-tx-queue` and `default mc-tx-queue` commands remove the configuration for the specified transmit queue by deleting the all corresponding `mc-tx-queue` mode commands from *running-config*.

Command Mode

Interface-Ethernet Configuration

Interface-Port-Channel Configuration

Command Syntax

```
mc-tx-queue queue_level
```

Parameters

- ***queue_level*** The multicast transmit queue number. Values range from **0** to **3**.

Commands Available in tx-queue Configuration Mode

- [bandwidth percent \(Trident and Tomahawk\)](#)
- [priority \(Trident and Tomahawk\)](#)
- [shape rate \(Tx-queue – Trident and Tomahawk\)](#)

Related Command:

[Configures unicast transmit queues on Trident and Tomahawk platform switches.](#)

Example

This command enters mc-tx-queue configuration mode for **multicast transmit queue 3** of **interface Ethernet 5**.

```
switch(config)#interface ethernet 5
switch(config-if-Et5)#mc-tx-queue 3
switch(config-if-Et5-mc-txq-3)#
```

9.1.11.12 platform petraA traffic-class

The `platform petraA traffic-class` command configures the default traffic class used by all ports on a specified chip. The default traffic class is implemented by Petra platform switches to replace `qos cos` and `qos dscp` commands. Traffic class values range from **0** to **7**. The default traffic class is **1**.

When `platform ?` returns **Petra**:

- **CoS trusted ports:** inbound untagged packets are assigned to the default traffic class. Tagged packets are assigned to the traffic class that corresponds to the contents of its CoS field.
- **DSCP trusted ports:** inbound non-IP packets are assigned to the default traffic class. IP packets are assigned to the traffic class that corresponds to the contents of its DSCP field.
- **Untrusted ports:** all inbound packets are assigned to the default traffic class.

The `no platform petraA traffic-class` and `default platform petraA traffic-class` commands restore the default traffic class of one for all ports on the specified chips by deleting the corresponding `platform petraA traffic-class` command from *running-config*.

Command Mode

Global Configuration

Command Syntax

```
platform petraA [CHIP_NAME] traffic-class tc_value
no platform petraA [CHIP_NAME] traffic-class
default platform petraA [CHIP_NAME] traffic-class
```

Parameters

- **CHIP_NAME** Trust mode assigned to the specified ports. Port designation options include:
 - *no parameter* All ports on the switch.
 - **module cardX** All ports on specified linecard (7500 Series).
 - **petra cardX / chipY** All ports on PetraA chip **chipY** on linecard **cardX** (7500 Series).
 - **petra -chipZ** All ports on PetraA chip chipZ (7048 Series)

7500 Series

Switches can contain up to eight linecards. **CardX** varies from **3** to **10**.

Each linecard contains six PetraA chips. Each chip controls eight ports. **ChipY** varies from **0** to **5**:

- **0** controls ports **1** through **8**:
 - **1** controls ports **9** through **16**.
 - **2** controls ports **17** through **24**.
 - **3** controls ports **25** through **32**.
 - **4** controls ports **33** through **40**.
 - **5** controls ports **41** through **48**.

7048 Series

Each switch contains two PetraA chips. **ChipZ** varies from **0** to **1**:

- **0** controls ports **1** through **32**.
 - **1** controls ports **33** through **52**.
- **tc_value** Traffic class value. Values range from **0** to **7**. Default value is **1**.

Related Command

`show platform petraA traffic-class` displays the traffic class assignment on all specified Petra chips.

Example

This command configures the default *traffic class 6* for ports **25-32** on linecard **5**.

```
switch(config)#platform petraA petra5/3 traffic-class 6  
switch(config)#
```

9.1.11.13 priority (Arad/Jericho)

The **priority** command specifies the priority of the transmit queue. The switch supports two queue priorities:

- **strict priority:** contents are removed from the queue - subject to maximum bandwidth limits, before data from lower priority queues. The default setting on all queues is strict priority.
- **round robin priority:** contents are removed proportionately from all round robin queues - subject to maximum bandwidth limits assigned to the strict priority queues.

Tx-queue 7 is set to strict priority and is not configurable.

When a queue is configured as a round robin queue, all lower priority queues also function as round robin queues. A queue's numerical label denotes its priority: higher labels denote higher priority. **Tx-queue 6** has higher priority than **Tx-queue 5**, and **Tx-queue 0** has the lowest priority.

The **priority strict** and **default priority** commands configure a transmit queue to function as a strict priority queue unless a higher priority queue is configured as a round robin queue.

The **no priority** command configures a transmit queue as a round robin queue. All lower priority queues also function as round robin queues regardless of their configuration.

Command Mode

Tx-Queue Configuration

Command Syntax

```
priority strict
no priority
default priority
```

Related Command

[tx-queue \(Arad/Jericho\)](#) places the switch in tx-queue configuration mode.

Example

These commands perform the following on **interface Ethernet 3/4/1**:

- Displays the default state of all transmit queues.
- Configures **transmit queue 3** as a round robin queue.
- Displays the effect of the **no priority** command on all transmit queues on the interface.

```
switch(config)#interface ethernet 3/4/1
switch(config-if-Et3/4/1)#show qos interfaces ethernet 3/4/1
```

Ethernet3/4/1:

Tx Queue	Bandwidth (percent)	Shape Rate (units)	Priority	ECN
7	- / -	- / - (-)	SP / SP	D
6	- / -	- / - (-)	SP / SP	D
5	- / -	- / - (-)	SP / SP	D
4	- / -	999 / 1000 (Mbps)	SP / SP	D
3	- / -	999 / 1000 (Mbps)	SP / SP	D
2	- / -	- / - (-)	SP / SP	D
1	- / -	- / - (-)	SP / SP	D
0	- / -	- / - (-)	SP / SP	D

Note: Values are displayed as Operational/Configured

```
switch(config-if-Et3/4/1)#tx-queue 3
switch(config-if-Et3/4/1-txq-3)#no priority
switch(config-if-Et3/4/1-txq-3)#show qos interfaces ethernet
3/4/1
```

Ethernet3/4/1:

Tx Queue	Bandwidth (percent)	Shape Rate (units)	Priority	ECN
7	- / -	- / - (-)	SP / SP	D
6	- / -	- / - (-)	SP / SP	D
5	- / -	- / - (-)	SP / SP	D
4	- / -	999 / 1000 (Mbps)	SP / SP	D
3	25 / -	999 / 1000 (Mbps)	RR / RR	D
2	25 / -	- / - (-)	RR / SP	D
1	25 / -	- / - (-)	RR / SP	D
0	25 / -	- / - (-)	RR / SP	D

Note: Values are displayed as Operational/Configured

```
switch(config-if-Et3/4/1-txq-3)#
```

9.1.11.14 priority (FM6000)

The **priority** command specifies the priority of the transmit queue. The switch supports two queue priorities:

- **strict priority:** contents are removed from the queue - subject to maximum bandwidth limits, before data from lower priority queues. The default setting on all queues is strict priority.
- **round robin priority:** contents are removed proportionately from all round robin queues - subject to maximum bandwidth limits assigned to the strict priority queues.

When a queue is configured as a round robin queue, all lower priority queues also function as round robin queues. A queue's numerical label denotes its priority: higher labels denote higher priority. **Tx-queue 6** has higher priority than **Tx-queue 5**, and **Tx-queue 0** has the lowest priority.

The **priority strict** and **default priority** commands configure a transmit queue to function as a strict priority queue unless a higher priority queue is configured as a round robin queue.

The **no priority** command configures a transmit queue as a round robin queue. All lower priority queues also function as round robin queues regardless of their configuration.

Command Mode

Tx-Queue Configuration

Command Syntax

```
priority strict
```

```
no priority
```

```
default priority
```

Related Command

[tx-queue \(FM6000\)](#) places the switch in tx-queue configuration mode.

Example

These commands perform the following on **Ethernet interface 2**:

- Displays the default state of all transmit queues.
- Configures **transmit queue 3** as a round robin queue.
- Displays the effect of the **no priority** command on all transmit queues on the interface.

```
switch(config)#interface ethernet 19
switch(config-if-Et19)#show qos interface ethernet 19
```

```
Ethernet19:
```

```
Trust Mode: COS
```

Tx-Queue	Bandwidth (percent)	Shape Rate (Kbps)	Priority
6	N/A	disabled	strict
5	N/A	disabled	strict
4	N/A	disabled	strict
3	N/A	disabled	strict
2	N/A	disabled	strict
1	N/A	disabled	strict
0	N/A	disabled	strict

```
switch(config-if-Et19)#tx-queue 3
switch(config-if-Et19-txq-3)#no priority
switch(config-if-Et19-txq-3)#show qos interface ethernet 19
```

```
Ethernet19:
Trust Mode: COS

Tx-Queue   Bandwidth   Shape Rate   Priority
            (percent)   (Kbps)
-----
           6         N/A         disabled     strict
           5         N/A         disabled     strict
           4         N/A         disabled     strict
           3         25         disabled     round-robin
           2         25         disabled     round-robin
           1         25         disabled     round-robin
           0         25         disabled     round-robin

switch(config-if-Et19-txq-3)#
```

9.1.11.15 priority (Petra)

The **priority** command specifies the priority of the transmit queue. The switch supports two queue priorities:

- **strict priority:** contents are removed from the queue - subject to maximum bandwidth limits, before data from lower priority queues. The default setting on all queues is strict priority.
- **round robin priority:** contents are removed proportionately from all round robin queues - subject to maximum bandwidth limits assigned to the strict priority queues.

Tx-queue 7 is set to strict priority and is not configurable.

When a queue is configured as a round robin queue, all lower priority queues also function as round robin queues. A queue's numerical label denotes its priority: higher labels denote higher priority. **Tx-queue 6** has higher priority than **Tx-queue 5**, and **Tx-queue 0** has the lowest priority.

The **priority strict** and **default priority** commands configure a transmit queue to function as a strict priority queue unless a higher priority queue is configured as a round robin queue.

The **no priority** command configures a transmit queue as a round robin queue. All lower priority queues also function as round robin queues regardless of their configuration.

Command Mode

Tx-Queue Configuration

Command Syntax

```
priority strict
```

```
no priority
```

```
default priority
```

Related Command

[tx-queue \(Petra\)](#) places the switch in tx-queue configuration mode.

Example

These commands perform the following on **Ethernet interface 3/28**:

- Displays the default state of all transmit queues.
- Configures **transmit queue 3** as a round robin queue.
- Displays the effect of the **no priority** command on all transmit queues on the interface.

```
switch(config)#interface ethernet 3/28
switch(config-if-Et3/28)#show qos interface ethernet 3/28

Ethernet3/28:
Trust Mode: COS

Tx-Queue   Bandwidth   Shape Rate   Priority
           (percent)   (Kbps)
-----
           7           N/A         disabled     strict
           6           N/A         disabled     strict
           5           N/A         disabled     strict
           4           N/A         disabled     strict
           3           N/A         disabled     strict
           2           N/A         disabled     strict
           1           N/A         disabled     strict
           0           N/A         disabled     strict
```

```
switch(config-if-Et3/28)#tx-queue 3
switch(config-if-Et3/28-txq-3)#no priority
switch(config-if-Et3/28-txq-3)#show qos interface ethernet
3/28
```

Ethernet3/28:

Trust Mode: COS

Tx-Queue	Bandwidth (percent)	Shape Rate (Kbps)	Priority
7	N/A	disabled	strict
6	N/A	disabled	strict
5	N/A	disabled	strict
4	N/A	disabled	strict
3	25	disabled	round-robin
2	25	disabled	round-robin
1	25	disabled	round-robin
0	25	disabled	round-robin

```
switch(config-if-Et3/28-txq-3)#
```

9.1.11.16 priority (Trident and Tomahawk)

The **priority** command specifies the priority of the transmit queue. The switch supports two queue priorities:

- **strict priority:** contents are removed from the queue - subject to maximum bandwidth limits, before data from lower priority queues. The default setting on all other queues is strict priority.
- **round robin priority:** contents are removed proportionately from all round robin queues - subject to maximum bandwidth limits assigned to the strict priority queues.

Trident and Tomahawk switches have eight unicast queues (UC0 – UC7) and four multicast queues (MC0 – MC03), categorized into two priority groups. **Priority group 1** queues have priority over **priority 0** queues. The following lists display the priority group queues in order from higher priority to lower priority.

- **Priority Group 1:** UC7, UC6, MC3
- **Priority Group 0:** UC5, UC4, MC2, UC3, UC2, MC1, UC1, UC0, MC0

Priority group 1 queues are strict priority queues and are not configurable as round robin. **Priority 0** queues are strict priority by default and are configurable as round robin. When a queue is configured as a round robin queue, all lower priority queues automatically function as round robin queues.

The **priority strict** and **default priority** commands configure a transmit queue to function as a strict priority queue unless a higher priority queue is configured as a round robin queue.

The **no priority** command configures a transmit queue as a round robin queue. All lower priority queues also function as round robin queues regardless of their configuration.

Command Mode

Mc-Tx-Queue configuration

Uc-Tx-Queue configuration

Command Syntax

```
priority strict
```

```
no priority
```

```
default priority
```

Related Commands

- [mc-tx-queue](#) places the switch in mc-tx-queue configuration mode.
- [uc-tx-queue](#) places the switch in uc-tx-queue configuration mode.

Example

These commands perform the following on **Ethernet interface 7**:

- Displays the default state of all transmit queues.
- Configures **transmit queue 3** as a round robin queue.
- Displays the effect of the **no priority** command on all transmit queues on the interface.

```
switch(config)#interface ethernet 7
switch(config-if-Et7)#show qos interface ethernet 7

Ethernet7:
Trust Mode: COS

Tx-Queue   Bandwidth   Shape Rate   Priority   Priority Group
          (percent)   (Kbps)
-----
          UC7         N/A         disabled    strict     1
          UC6         N/A         disabled    strict     1
```

```

MC3      N/A      disabled    strict     1
UC5      N/A      disabled    strict     0
UC4      N/A      disabled    strict     0
MC2      N/A      disabled    strict     0
UC3      N/A      disabled    strict     0
UC2      N/A      disabled    strict     0
MC1      N/A      disabled    strict     0
UC1      N/A      disabled    strict     0
UC0      N/A      disabled    strict     0
MC0      N/A      disabled    strict     0

switch(config-if-Et7) #uc-tx-queue 3
switch(config-if-Et7-uc-txq-3) #no priority
switch(config-if-Et7-uc-txq-3) #show qos interface ethernet 7

Ethernet7:
Trust Mode: COS

Tx-Queue  Bandwidth  Shape Rate  Priority  Priority Group
          (percent)  (Kbps)
-----
UC7        N/A        disabled    strict     1
UC6        N/A        disabled    strict     1
MC3        N/A        disabled    strict     1
UC5        N/A        disabled    strict     0
UC4        N/A        disabled    strict     0
MC2        N/A        disabled    strict     0
UC3        20         disabled    round-robin 0
UC2        16         disabled    round-robin 0
MC1        16         disabled    round-robin 0
UC1        16         disabled    round-robin 0
UC0        16         disabled    round-robin 0
MC0        16         disabled    round-robin 0

switch(config-if-Et7-uc-txq-3) #

```

9.1.11.17 qos cos

The `qos cos` command specifies the default class of service (CoS) value of the configuration mode interface. CoS values range from **0** to **7**. Default value is **0**.

Arad, Jericho, fm6000, Trident, Tomahawk, and Trident II platform switches:

- CoS trusted ports: the default CoS value determines the traffic class for inbound untagged packets. Tagged packets are assigned to the traffic class that corresponds to the contents of its CoS field.
- Untrusted ports: the default CoS value determines the traffic class for all inbound packets.

Petra platform switches:

- CoS trusted ports: inbound untagged packets are assigned to the default traffic class, as configured by [platform petraA traffic-class](#). Tagged packets are assigned to the traffic class that corresponds to the contents of its CoS field.
- Untrusted ports: all inbound packets are assigned to the default traffic class.

The `no qos cos` and `default qos cos` commands restore the port's default CoS value to zero by deleting the corresponding `qos cos` command from *running-config*.

Command Mode

Interface-Ethernet Configuration

Interface-Port-Channel Configuration

Command Syntax

```
qos cos cos_value
```

```
no qos cos
```

```
default qos cos
```

Parameters

cos_value CoS value assigned to port. Value ranges from **0** to **7**. Default value is **0**.

Example

This command configures the default **CoS 4** on **interface Ethernet 8**.

```
switch(config-if-Et8)#qos cos 4
switch(config-if-Et8)#
```

9.1.11.18 qos dscp

The **qos dscp** command specifies the default Differentiated Services Code Point (DSCP) value of the configuration mode interface. The default DSCP determines the traffic class for non-IP packets that are inbound on DSCP trusted ports. DSCP trusted ports determine the traffic class for inbound packets as follows:

- **Arad, Jericho, fm6000, Trident, Tomahawk, and Trident II** platform switches:
 - non-IP packets: default DSCP value specified by **qos dscp** determines the traffic class.
 - IP packets: assigned to the traffic class corresponding to its DSCP field contents.
- **Petra** platform switches:
 - non-IP packets: assigned to default traffic class configured by [platform petraA traffic-class](#).
 - IP packets: assigned to the traffic class corresponding to its DSCP field contents.

The **no qos dscp** and **default qos dscp** commands restore the port's default DSCP value to zero by deleting the corresponding **qos dscp** command from **running-config**.

Command Mode

Interface-Ethernet Configuration

Interface-Port-Channel Configuration

Command Syntax

```
qos dscp dscp_value
```

```
no qos dscp
```

```
default qos dscp
```

Parameters

dscp_value DSCP value assigned to the port. Value ranges from **0** to **63**. Default value is **0**.

Example

This command sets the default DSCP of **44** on **interface Ethernet 7**.

```
switch(config)#interface ethernet 7
switch(config-if-Et7)#qos dscp 44
switch(config-if-Et7)
```

9.1.11.19 qos map cos

The `qos map cos` command associates a traffic class to a list of class of service (CoS) settings. Multiple commands create a complete CoS to traffic class map. The switch uses this map to assign a traffic class to data packets on the basis of the packet's CoS field or the port upon which it is received.

The `no qos map cos` and `default qos map cos` commands restore the specified CoS values to their default traffic class setting by deleting the corresponding `qos map cos` statements from *running-config*.

Command Mode

Global Configuration

Command Syntax

```
qos map cos cos_value_1 [cos_value_2 ... cos_value_n] to traffic-class tc_value
```

```
no qos map cos cos_value_1 [cos_value_2 ... cos_value_n]
```

```
default qos map cos cos_value_1 [cos_value_2 ... cos_value_n]
```

Parameters

- **cos_value_x** Class of service (CoS) value. Value ranges from **0** to **7**.
- **tc_value** Traffic class value. Value range varies by platform.

Default CoS to traffic class map varies by platform ([Table 40: Default CoS to Traffic Class Map](#)).

Default Inbound CoS to Traffic Class Map

[Table 40: Default CoS to Traffic Class Map](#) displays the default CoS to traffic class map for each platform.

Table 40: Default CoS to Traffic Class Map

Inbound CoS	untagged	0	1	2	3	4	5	6	7
Traffic Class (Arad / Jericho)	Derived: use default CoS as inbound CoS	1	0	2	3	4	5	6	7
Traffic Class (FM6000)	Derived: use default CoS as inbound CoS	1	0	2	3	4	5	6	7
Traffic Class (Helix)	Derived: use default CoS as inbound CoS	1	0	2	3	4	5	6	7
Traffic Class (Petra)	Assigned default traffic class	1	0	2	3	4	5	6	7
Traffic Class (Trident and Tomahawk)	Derived: use default CoS as inbound CoS	1	0	2	3	4	5	6	7
Traffic Class (Trident II)	Derived: use default CoS as inbound CoS	1	0	2	3	4	5	6	7

Related Commands

- [qos cos](#) specifies the default CoS.
- [platform petraA traffic-class](#) specifies the default traffic class.

Example

This command assigns the **traffic class 5** to the classes of service **1, 3, 5, and 7**.

```
switch(config)#qos map cos 1 3 5 7 to traffic-class 5
```

```
switch(config)#
```

9.1.11.20 qos map dscp

The `qos map dscp` command associates a traffic class to a set of Differentiated Services Code Point (DSCP) values. Multiple commands create a complete DSCP to traffic class map. The switch uses this map to assign a traffic class to data packets on the basis of the packet's DSCP field or the chip upon which it is received.

The `no qos map dscp` and `default qos map dscp` commands restore the specified DSCP values to their default traffic class settings by deleting corresponding `qos map dscp` statements from *running-config*.

Command Mode

Global Configuration

Command Syntax

```
qos map dscp dscpv_1 [dscpv_2...dscpv_n] to traffic-class tc_value
```

```
no qos map dscp dscpv_1 [dscpv_2...dscpv_n]
```

```
default qos map dscp dscpv_1 [dscpv_2...dscpv_n]
```

Parameters

- **dscpv_x** Differentiated services code point (DSCP) value. Value ranges from **0** to **63**.
- **tc_value** Traffic class value. Value range varies by platform.

Default map varies by platform ([Table 41: Default DSCP to Traffic Class Map](#)).

Default Inbound DSCP to Traffic Class Map

[Table 41: Default DSCP to Traffic Class Map](#) displays the default DSCP to traffic class map for each platform.

Table 41: Default DSCP to Traffic Class Map

Inbound DSCP	0-7	8-15	16-23	24-31	32-39	40-47	48-55	56-63
Traffic Class (Arad / Jericho)	1	0	2	3	4	5	6	7
Traffic Class (FM6000)	1	0	2	3	4	5	6	7
Traffic Class (Helix)	1	0	2	3	4	5	6	7
Traffic Class (Petra)	1	0	2	3	4	5	6	7
Traffic Class (Trident and Tomahawk)	1	0	2	3	4	5	6	7
Traffic Class (Trident II)	1	0	2	3	4	5	6	7

Example

This command assigns the **traffic class 3** to the DSCP values of **12, 13, 25, and 37**.

```
switch(config)#qos map dscp 12 13 25 37 to traffic-class 3
switch(config)#
```

9.1.11.21 qos map traffic-class to cos

The `qos map traffic-class to cos` command associates a class of service (CoS) to a list of traffic classes. Multiple commands create a complete traffic class to CoS map. The switch uses this map in CoS rewrite operations to fill the CoS field in outbound packets. This map is applicable to DSCP trusted ports and untrusted ports. CoS rewrite is disabled on CoS trusted ports. The `show qos maps` command displays the CoS to traffic class map.

The `no qos traffic-class to cos` and `default qos traffic-class to cos` commands restore the specified traffic class values to their default CoS settings by removing the corresponding `qos map traffic-class to cos` command from *running-config*.

Command Mode

Global Configuration

Command Syntax

```
qos map traffic-class tc_num_1 [tc_num_2 ... tc_num_n] to cos cos_value
```

```
no qos map traffic-class tc_num_1 [tc_num_2 ... tc_num_n] to cos
```

```
default qos map traffic-class tc_num_1 [tc_num_2 ... tc_num_n] to cos
```

Parameters

- ***tc_num_x*** Traffic class value. Value range varies by switch platform.
- ***cos_value*** Class of service (CoS) value. Value ranges from **0** to **7**.

Default Inbound Traffic Class to CoS Map

[Table 42: Default Traffic Class to CoS Rewrite Value Map](#) displays the default traffic class to CoS map for each platform.

Table 42: Default Traffic Class to CoS Rewrite Value Map

Traffic Class	0	1	2	3	4	5	6	7
CoS Rewrite Value (Arad and / Jericho)	1	0	2	3	4	5	6	7
CoS Rewrite Value (FM6000)	1	0	2	3	4	5	6	7
CoS Rewrite Value (Helix)	1	0	2	3	4	5	6	7
CoS Rewrite Value (Petra)	1	0	2	3	4	5	6	7
CoS Rewrite Value (Trident and Tomahawk)	1	0	2	3	4	5	6	7
CoS Rewrite Value (Trident II)	1	0	2	3	4	5	6	7

Example

This command assigns the **CoS 2** to traffic classes **1, 3, and 5**.

```
switch(config)#qos map traffic-class 1 3 5 to cos 2
switch(config)#
```

9.1.11.22 qos map traffic-class to dscp

The `qos map traffic-class to dscp` command associates a Differentiated Services Code Point (DSCP) value to a list of traffic classes. Multiple commands create a complete traffic class to DSCP map. The switch uses this map in DSCP rewrite operations to fill the DSCP field in outbound packets. This map is applicable to CoS trusted ports and untrusted ports but disabled by default on these ports. DSCP rewrite is disabled on DSCP trusted ports. The `show qos maps` command displays the traffic class to DSCP map.

The `no qos traffic-class to dscp` and `default qos traffic-class to dscp` commands restore the specified traffic class values to their default DSCP settings by removing the corresponding `qos map traffic-class to dscp` command from *running-config*.

Command Mode

Global Configuration

Command Syntax

```
qos map traffic-class tc_num_1 [tc_num_2 ... tc_num_n] to dscp dscp_value
```

```
no qos map traffic-class tc_num_1 [tc_num_2 ... tc_num_n] to dscp
```

```
default qos map traffic-class tc_num_1 [tc_num_2 ... tc_num_n] to dscp
```

Parameters

- ***tc_num_x*** Traffic class value. Value range varies by switch platform.
- ***dscp_value*** Differentiated services code point (DSCP) value. Value ranges from **0** to **63**.

Default Inbound Traffic Class to DSCP Map

[Table 43: Default Traffic Class to DSCP Rewrite Value Map](#) displays the default traffic class to DSCP map for each platform.

Table 43: Default Traffic Class to DSCP Rewrite Value Map

Traffic Class	0	1	2	3	4	5	6	7
DSCP Rewrite Value (FM6000)	8	0	16	24	32	40	48	56
DSCP Rewrite Value (Helix)	8	0	16	24	32	40	48	56
DSCP Rewrite Value (Trident and Tomahawk)	8	0	16	24	32	40	48	56
DSCP Rewrite Value (Trident II)	8	0	16	24	32	40	48	56

Example

This command assigns the DSCP value of **17** to traffic classes **1**, **2**, and **4**.

```
switch(config)# qos map traffic-class 1 2 4 to dscp 17
switch(config)#
```

9.1.11.23 qos map traffic-class to mc-tx-queue

The `qos map traffic-class to mc-tx-queue` command associates a multicast transmit queue to a list of traffic classes. Multiple commands create a complete traffic class to mc-tx-queue map. The switch uses this map to route outbound packets to transmit queues, which in turn schedules their transmission from the switch. The `show qos maps` command displays the traffic class to multicast transmit queue map.

The `no qos traffic-class to mc-tx-queue` and `default qos traffic-class to mc-tx-queue` commands restore the default traffic class to multicast transmit queue map for the specified traffic class values by removing the corresponding `qos map traffic-class to mc-tx-queue` command from *running-config*.

Command Mode

Global Configuration

Command Syntax

```
qos map traffic-class tc_num_1 [tc_num_2 ... tc_num_n] to mc-tx-queue mtq_value
no qos map traffic-class tc_num_1 [tc_num_2 ... tc_num_n] to mc-tx-queue
default qos map traffic-class tc_num_1 [tc_num_2 ... tc_num_n] to mc-tx-queue
```

Parameters

- ***tc_num_x*** Traffic class value. Value ranges from **0** to **7**.
- ***mtq_value*** Multicast transmit queue number. Value ranges from **0** to **3**.

Default Inbound Traffic Class to Multicast Transmit Queue Map

[Table 44: Default Traffic Class to Multicast Transmit Queue Map](#) displays the default traffic class to multicast transmit queue map for Trident and Tomahawk platform switches.

Table 44: Default Traffic Class to Multicast Transmit Queue Map

Traffic Class	0	1	2	3	4	5	6	7
Multicast Transmit Queue (Trident and Tomahawk)	0	0	1	1	2	2	3	3

Related Commands

- `qos map traffic-class to uc-tx-queue` (Trident and Tomahawk) associates traffic classes to a multicast transmit queue.
- `qos map traffic-class to tx-queue` (all other platforms) associates traffic classes to a transmit queue.

Example

This command maps traffic classes **0**, **4**, and **5** to **mc-tx-queue 2**.

```
switch(config)#qos map traffic-class 0 4 5 to mc-tx-queue 2
switch(config)#
```

9.1.11.24 qos map traffic-class to tx-queue

The `qos map traffic-class to tx-queue` command associates a transmit queue (tx-queue) to a list of traffic classes. Multiple commands create a complete traffic to tx-queue map. The switch uses this map to route outbound packets to transmit queues, which in turn schedules their transmission from the switch. The `show qos maps` command displays the transmit queue to traffic class map.

The `no qos traffic-class to tx-queue` and `default qos traffic-class to tx-queue` commands restore the specified traffic class values to their default transmit queue settings by removing the corresponding `qos map traffic-class to tx-queue` command from **running-config**.

Command Mode

Global Configuration

Command Syntax

```
qos map traffic-class tc_num_1 [tc_num_2 ... tc_num_n] to tx-queue txq_value
```

```
no qos map traffic-class tc_num_1 [tc_num_2 ... tc_num_n] to tx-queue
```

```
default qos map traffic-class tc_num_1 [tc_num_2 ... tc_num_n] to tx-queue
```

Parameters

- ***tc_num_x*** Traffic class value. Value range varies by platform.
- ***txq_value*** Transmit queue value. Value range varies by platform.

Restrictions

FM6000: When priority flow control (PFC) is enabled, traffic classes are mapped to their corresponding transmit queues, regardless of existing `qos map traffic-class to tx-queue` statements.

Arad, Jericho, and Petra: Traffic class 7 always maps to transmit queue 7. This association is not editable.

Default Inbound Traffic Class to Transmit Queue Map

[Table 45: Default Traffic Class to Transmit Queue Map](#) displays the transmit queue to traffic class map.

Table 45: Default Traffic Class to Transmit Queue Map

Traffic Class	0	1	2	3	4	5	6	7
Transmit Queue (Arad / Jericho)	0	1	2	3	4	5	6	7
Transmit Queue (FM6000)	0	1	2	3	4	5	6	7
Transmit Queue (Helix)	0	1	2	3	4	5	6	7
Transmit Queue (Petra)	0	1	2	3	4	5	6	7
Transmit Queue (Trident II)	0	1	2	3	4	5	6	7

Related Commands

- `qos map traffic-class to mc-tx-queue` (Trident and Tomahawk) associates traffic classes to a unicast transmit queue.
- `qos map traffic-class to uc-tx-queue` (Trident and Tomahawk) associates traffic classes to a multicast transmit queue.

Example

This command maps traffic classes **0**, **4**, and **5** to **tx-queue 4**.

```
switch(config)#qos map traffic-class 0 4 5 to tx-queue 4  
switch(config)#
```

9.1.11.25 qos map traffic-class to uc-tx-queue

The `qos map traffic-class to uc-tx-queue` command associates a unicast transmit queue to a list of traffic classes. Multiple commands create a complete traffic class to unicast transmit queue map. The switch uses this map to route outbound packets to transmit queues, which in turn schedules their transmission from the switch. The `show qos maps` command displays the traffic class to unicast transmit queue map.

The `no qos traffic-class to uc-tx-queue` and `default qos traffic-class to uc-tx-queue` commands restore the default traffic class to unicast transmit queue map for the specified traffic class values by removing the corresponding `qos map traffic-class to uc-tx-queue` command from *running-config*.

Command Mode

Global Configuration

Command Syntax

```
qos map traffic-class tc_num_1 [tc_num_2 ... tc_num_n] to uc-tx-queue utq_value
```

```
no qos map traffic-class tc_num_1 [tc_num_2 ... tc_num_n] to uc-tx-queue
```

```
default qos map traffic-class tc_num_1 [tc_num_2 ... tc_num_n] to uc-tx-queue
```

Parameters

- ***tc_num_x*** Traffic class value. Value ranges from **0** to **7**.
- ***utq_value*** Unicast transmit queue number. Value ranges from **0** to **7**.

Default Inbound Traffic Class to Unicast Transmit Queue Map

[Table 46: Default Traffic Class to Unicast Transmit Queue Map](#) displays the default traffic class to Unicast transmit queue map for Trident and Tomahawk platform switches.

Table 46: Default Traffic Class to Unicast Transmit Queue Map

Traffic Class	0	1	2	3	4	5	6	7
Unicast Transmit Queue (Trident and Tomahawk)	0	1	2	3	4	5	6	7

Related Commands

- `qos map traffic-class to mc-tx-queue` (Trident and Tomahawk) associates traffic classes to a unicast transmit queue.
- `qos map traffic-class to tx-queue` (all other platforms) associates traffic classes to a transmit queue.

Example

This command maps traffic classes **0**, **4**, and **5** to **unicast transmit queue 4**.

```
switch(config)#qos map traffic-class 0 4 5 to uc-tx-queue 4
switch(config)#
```

9.1.11.26 qos profile

The **qos profile** command places the switch in QoS profile configuration mode and for the specified profile and creates the profile if it does not already exist. QoS profiles are used to apply the same QoS configuration to multiple interfaces.

The **no qos profile** and **default qos profile** command deletes the QoS profile from the running configuration.

The **exit** command returns the switch to global configuration mode.

Command Mode

Global Configuration

Command Syntax

```
qos profile profile_name
```

```
no qos profile profile_name
```

```
default qos profile profile_name
```

Parameter

profile_name QoS profile name.



Note: Commands use a subset of the listed fields. Available subset depends on the specified parameter. Use CLI syntax assistance to view options for specific parameter when creating a QoS profile.

Example

This command places the switch in QoS profile configuration mode for policy map policy map **TP** and creates the policy map if it does not already exist.

```
switch(config)#qos profile TP  
switch(config-qos-profile-TP)#
```

9.1.11.27 qos random-detect ecn allow non-ect chip-based (Tomahawk and Trident)

The `qos random-detect ecn allow non-ect chip-based` enables per color queue thresholds using color based queue thresholds and drop-precedence values along with drop of non-ect traffic by allowing non-ect and set drop-precedence 1 in a policy map simultaneously.

The `no qos random-detect ecn allow non-ect chip-based` and `default qos random-detect ecn allow non-ect chip-based` commands disables the use of non-ect and set drop-precedence 1 simultaneously in a policy map in the `running-config`.

Command Mode

Global Configuration

Command Syntax

```
qos random-detect ecn allow non-ect chip-based
```

```
no qos random-detect ecn allow non-ect chip-based
```

```
default qos random-detect ecn allow non-ect chip-based
```

Example

- The following command enables the use of non-ect and ***set drop-precedence 1*** simultaneously in a policy map.

```
switch(config)#qos random-detect ecn allow non-ect chip-based
```

9.1.11.28 qos random-detect ecn global-buffer (Helix)

The `qos random-detect ecn global-buffer` command enables ECN marking for globally shared packet memory and specifies minimum and maximum queue threshold sizes. Hosts can advertise their ECN capabilities in the ToS DiffServ field's two least significant bits:

- **00** Non ECN Capable transport.
- **10** ECN Capable transport.
- **01** ECN Capable transport.
- **11** Congestion encountered.

Congestion is determined by comparing average queue size with queue thresholds. Average queue size is calculated through a formula based on the previous average and current queue size. Packets are marked based on this average size and the specified thresholds:

- Average queue size below minimum threshold: Packets are queued normally.
- Average queue size above maximum threshold: Packets are marked **congestion encountered**.
- Average queue size between minimum and maximum thresholds. Packets are queued or marked **congestion encountered**. The proportion of marked packets varies linearly with average queue size:
 - 0% are marked when average queue size is less than or equal to minimum threshold.
 - 100% are marked when average queue size is greater than or equal to maximum threshold.

When transmitted packets are marked **Non ECN Capable**, congestion packets are dropped, not marked.

The `no qos random-detect ecn global-buffer` and `default qos random-detect ecn global-buffer` commands disables ECN marking for the shared buffer by removing the `qos random-detect ecn global-buffer` command from *running-config*.

Command Mode

Global Configuration

Command Syntax

```
qos random-detect ecn global-buffer minimum-threshold MIN maximum-threshold MAX
no qos random-detect ecn global-buffer
default qos random-detect ecn global-buffer
```

Guidelines

Packet memory is divided into 46080 208-byte cells, whose allocation is managed by the memory management unit (MMU). The MMU tracks the cells that each entity uses and determines the number of cells that can be allocated to an entity.

Parameters

MIN and **MAX** parameters must use the same data unit.

- **MIN** Minimum threshold. Options include:
 - **1 to 19456 segments** 208-byte segments units.
 - **1 to 4 mbytes** Megabyte units.
 - **1 to 4046 kbytes** Kilobyte units.
 - **1 to 4046848 bytes** Byte units.

-
- **MAX** Maximum threshold. Options include:
 - <1 to **19456**> **segments** 208-byte segments units.
 - <1 to **4**> **mbytes** Megabyte units.
 - <1 to **4046**> **kbytes** Kilobyte units.
 - <1 to **4046848**> **bytes** Byte units.

Related Command

[random-detect ecn \(Helix\)](#) enables ECN marking for a unicast transmit queue.

Examples

- This command enables ECN marking of unicast packets from the global data pool and sets the minimum and maximum thresholds at **20** and **500** segments.

```
switch(config)#qos random-detect ecn global-buffer minimum-  
threshold 20 segments  
maximum-threshold 500 segments  
switch(config)#
```

- This command disables ECN marking of unicast packets from the global data pool.

```
switch(config)#no qos random-detect ecn global-buffer  
switch(config)#
```

9.1.11.29 qos random-detect ecn global-buffer (Trident and Tomahawk)

The `qos random-detect ecn global-buffer` command enables ECN marking for globally shared packet memory and specifies minimum and maximum queue threshold sizes. Hosts can advertise their ECN capabilities in the ToS DiffServ field's two least significant bits:

- **00** Non ECN Capable transport.
- **10** ECN Capable transport.
- **01** ECN Capable transport.
- **11** Congestion encountered.

Congestion is determined by comparing average queue size with queue thresholds. Average queue size is calculated through a formula based on the previous average and current queue size. Packets are marked based on this average size and the specified thresholds:

- Average queue size below minimum threshold: Packets are queued normally.
- Average queue size above maximum threshold: Packets are marked **congestion encountered**.
- Average queue size between minimum and maximum thresholds. Packets are queued or marked **congestion encountered**. The proportion of marked packets varies linearly with average queue size:
 - 0% are marked when average queue size is less than or equal to minimum threshold.
 - 100% are marked when average queue size is greater than or equal to maximum threshold.

When transmitted packets are marked **Non ECN Capable**, congestion packets are dropped, not marked.

The `no qos random-detect ecn global-buffer` and `default qos random-detect ecn global-buffer` commands disables ECN marking for the shared buffer by removing the `qos random-detect ecn global-buffer` command from *running-config*.

Command Mode

Global Configuration

Command Syntax

```
qos random-detect ecn global-buffer minimum-threshold MIN maximum-threshold MAX
no qos random-detect ecn global-buffer
default qos random-detect ecn global-buffer
```

Guidelines

Packet memory is divided into 46080 208-byte cells, whose allocation is managed by the memory management unit (MMU). The MMU tracks the cells that each entity uses and determines the number of cells that can be allocated to an entity.

Parameters

MIN and **MAX** parameters must use the same data unit.

- **MIN** Minimum threshold. Options include:
 - **1 to 46080 segments** 208-byte segments units.
 - **1 to 9 mbytes** Megabyte units.
 - **1 to 9584 kbytes** Kilobyte units.
 - **1 to 9584640 bytes** Byte units.

-
- **MAX** Maximum threshold. Options include:
 - **1 to 46080 segments** 208-byte segments units.
 - **1 to 9 mbytes** Megabyte units.
 - **1 to 9584 kbytes** Kilobyte units.
 - **1 to 9584640 bytes** Byte units.

Related Command

[random-detect ecn \(Trident and Tomahawk\)](#) enables ECN marking for a unicast transmit queue.

Examples

- This command enables ECN marking of unicast packets from the global data pool and sets the minimum and maximum thresholds at **20** and **500** segments.

```
switch(config)#qos random-detect ecn global-buffer minimum-  
threshold 20 segments maximum-threshold 500 segments  
switch(config)#
```

- This command disables ECN marking of unicast packets from the global data pool.

```
switch(config)#no qos random-detect ecn global-buffer  
switch(config)#
```

9.1.11.30 qos rewrite cos

The **qos rewrite cos** command enables the rewriting of the CoS field for outbound tagged packets that were received on DSCP trusted ports and untrusted ports. CoS rewrite is always disabled on CoS trusted ports. The CoS value that is written into the packet is based on the data stream's traffic class. CoS rewriting is active by default.

The **no qos rewrite cos** command disables CoS rewriting on the switch. The default **qos rewrite cos** command restores the default setting of enabling CoS rewriting by removing the **no qos rewrite cos** command from *running-config*.

Command Mode

Global Configuration

Command Syntax

```
qos rewrite cos
```

```
no qos rewrite cos
```

```
default qos rewrite cos
```

Related Command

[qos map traffic-class to cos](#) configures the traffic class to CoS rewrite map.

Example

This command enables CoS rewrite.

```
switch(config)#qos rewrite cos  
switch(config)#
```

9.1.11.31 qos rewrite dscp

The `qos rewrite dscp` command enables the rewriting of the DSCP field for outbound tagged packets that were received on CoS trusted ports and untrusted ports. DSCP rewrite is always disabled on DSCP trusted ports. The DSCP value that is written into the packet is based on the data stream's traffic class. DSCP rewriting is disabled by default.

The `no qos rewrite dscp` and `default qos rewrite dscp` commands disable DSCP rewriting on the switch by removing the `no qos rewrite dscp` command from *running-config*.

Command Mode

Global Configuration

Command Syntax

```
qos rewrite dscp
```

```
no qos rewrite dscp
```

```
default qos rewrite dscp
```

Related Command

[qos map traffic-class to dscp](#) configures the traffic class to DSCP rewrite map.

Example

This command enables DSCP rewrite.

```
switch(config)#qos rewrite dscp  
switch(config)#
```

9.1.11.32 qos trust

The `qos trust` command configures the quality of service port trust mode for the configuration mode interface. Trust-enabled ports classify traffic by examining the traffic's CoS or DSCP value. Port trust mode default setting is `cos` for switched interfaces and `dscp` for routed interfaces.

The `default qos trust` command restores the default trust mode on the configuration mode interface by removing the corresponding `qos trust` or `no qos trust` statement from *running-config*.

The `no qos trust` command performs the following:

- `no qos trust` places the port in *untrusted* mode.
- `no qos trust cos` removes the corresponding `qos trust cos` statement.
- `no qos trust dscp` removes the corresponding `qos trust dscp` statement.

Command Mode

Interface-Ethernet Configuration

Interface-Port-Channel Configuration

Command Syntax

```
qos trust [MODE]
```

```
no qos trust [MODE]
```

```
default qos trust
```

Parameters

- **MODE** Trust mode assigned to the port. Options include:
 - `cos` Enables cos trust mode.
 - `dscp` Enables dscp trust mode.

`no qos trust` Enables untrusted mode on the port.

Examples

- This command configures trust mode of dscp for *interface Ethernet 7*.

```
switch(config)#interface Ethernet 7
switch(config-if-Et7)#qos trust dscp
switch(config-if-Et7)#show active
interface Ethernet7
  qos trust dscp
switch(config-if-Et7)#
```

- This command configures trust mode of untrusted for *Port Channel interface 23*.

```
switch(config)#interface port-channel 23
switch(config-if-Po23)#no qos trust
switch(config-if-Po23)#show active
interface Port-Channel23
  no qos trust
switch(config-if-Po23)#
```

9.1.11.33 random-detect ecn (Arad/Jericho)

The `random-detect ecn` command enables ECN marking for the configuration mode unicast transmit queue and specifies threshold queue sizes. Hosts can advertise their ECN capabilities in the ToS DiffServ field's two least significant bits:

- **00** Non ECN Capable transport.
- **10** ECN Capable transport.
- **01** ECN Capable transport.
- **11** Congestion encountered.

Congestion is determined by comparing average queue size with queue thresholds. Average queue size is calculated through a formula based on the previous average and current queue size. Packets are marked based on this average size and the specified thresholds:

- Average queue size below minimum threshold: Packets are queued normally.
- Average queue size above maximum threshold: Packets are marked **congestion encountered**.
- Average queue size between minimum and maximum thresholds. Packets are queued or marked **congestion encountered**. The proportion of marked packets varies linearly with average queue size:
 - 0% are marked when average queue size is less than or equal to minimum threshold.
 - 100% are marked when average queue size is greater than or equal to maximum threshold.

When transmitted packets are marked **Non ECN Capable**, congestion packets are dropped, not marked.

The `no random-detect ecn` and `default qos random-detect ecn` commands disables ECN marking for the shared buffer by removing the `qos random-detect ecn` command from **running-config**.

Command Mode

Tx-Queue configuration

Command Syntax

```
random-detect ecn minimum-threshold MIN maximum-threshold MAX
```

```
no random-detect ecn
```

```
default random-detect ecn
```

Parameters

MIN and **MAX** parameters must use the same data unit.

- **MIN** Minimum threshold. Options include:
 - **1 to 256 mbytes** Megabyte units.
 - **1 to 256000 kbytes** Kilobyte units.
 - **1 to 256000000 bytes** Byte units.
- **MAX** Maximum threshold. Options include:
 - **1 to 256 mbytes** Megabyte units.
 - **1 to 256000 kbytes** Kilobyte units.
 - **1 to 256000000 bytes** Byte units.

Related Command

[tx-queue \(Arad/Jericho\)](#) places the switch in tx-queue configuration mode.

Example

These commands enable ECN marking of unicast packets from *unicast transmit queue 4* of *interface Ethernet 3/5/1*, setting thresholds at **128** kbytes and **1280** kbytes.

```
switch(config)#interface ethernet 3/5/1
switch(config-if-Et3/5/1)#tx-queue 4
switch(config-if-Et3/5/1-txq-4)#random-detect ecn minimum-thres
hold 128 kbytes
maximum-threshold 1280 kbyte
switch(config-if-Et3/5/1-txq-4)#show active
interface Ethernet3/5/1
    tx-queue 4
        random-detect ecn minimum-threshold 128 kbytes maximum-
threshold 1280 kbytes
switch(config-if-Et3/5/1-txq-4)#
```

9.1.11.34 random-detect ecn (Helix)

The `random-detect ecn` command enables ECN marking for the configuration mode unicast transmit queue and specifies threshold queue sizes. Hosts can advertise their ECN capabilities in the ToS DiffServ field's two least significant bits:

- **00** Non ECN Capable transport.
- **10** ECN Capable transport.
- **01** ECN Capable transport.
- **11** Congestion encountered.

Congestion is determined by comparing average queue size with queue thresholds. Average queue size is calculated through a formula based on the previous average and current queue size. Packets are marked based on this average size and the specified thresholds:

- Average queue size below minimum threshold: Packets are queued normally.
- Average queue size above maximum threshold: Packets are marked **congestion encountered**.
- Average queue size between minimum and maximum thresholds. Packets are queued or marked **congestion encountered**. The proportion of marked packets varies linearly with average queue size:
 - 0% are marked when average queue size is less than or equal to minimum threshold.
 - 100% are marked when average queue size is greater than or equal to maximum threshold.

When transmitted packets are marked Non ECN Capable, congestion packets are dropped, not marked.

Average queue length is tracked for transmit queues and the global pool independently. When either entity reaches its maximum threshold, all subsequent packets are marked.

The `no random-detect ecn` and `default random-detect ecn` commands disable ECN marking on the configuration mode queue, deleting the corresponding `random-detect ecn` command from *running-config*.

Command Mode

Tx-Queue configuration

Command Syntax

```
random-detect ecn minimum-threshold MIN maximum-threshold MAX
```

```
no random-detect ecn
```

```
default random-detect ecn
```

Parameters

MIN and **MAX** parameters must use the same data unit.

- **MIN** Minimum threshold. Options include:
 - **1 to 46080 segments** 208-byte segments units.
 - **1 to 9 mbytes** Megabyte units.
 - **1 to 9584 kbytes** Kilobyte units.
 - **1 to 9584640 bytes** Byte units.
- **MAX** Maximum threshold. Options include:
 - **1 to 46080 segments** 208-byte segments units.
 - **1 to 9 mbytes** Megabyte units.
 - **1 to 9584 kbytes** Kilobyte units.
 - **1 to 9584640 bytes** Byte units.

Related Commands

- [tx-queue \(Helix\)](#) places the switch in tx-queue configuration mode.
- [qos random-detect ecn global-buffer \(Helix\)](#) enables ECN marking for globally shared packet memory.

Examples

- These commands enable ECN marking of unicast packets from **transmit queue 4** of **interface Ethernet 15**, setting thresholds at **10** and **100** segments.

```
switch(config)#interface ethernet 15
switch(config-if-Et15)#uc-tx-queue 4
switch(config-if-Et15-txq-4)#random-detect ecn minimum-thres
hold 10 segments
maximum-threshold 100 segments
switch(config-if-Et15-txq-4)#show active
interface Ethernet15
    tx-queue 4
        random-detect ecn minimum-threshold 10 segments maximum-
threshold 100
segments
switch(config-if-Et15-txq-4)#exit
switch(config-if-Et15)
```

- This command disables ECN marking of unicast packets from **transmit queue 4** of **interface Ethernet 15**.

```
switch(config-if-Et15-txq-4)#no random-detect ecn
switch(config-if-Et15-txq-4)#show active
interface Ethernet15
switch(config-if-Et15-txq-4)#exit
switch(config-if-Et15)#
```

9.1.11.35 random-detect ecn (Trident and Tomahawk)

The `random-detect ecn` command enables ECN marking for the configuration mode unicast transmit queue and specifies threshold queue sizes. Hosts can advertise their ECN capabilities in the ToS DiffServ field's two least significant bits:

- **00** Non ECN Capable transport.
- **10** ECN Capable transport.
- **01** ECN Capable transport.
- **11** Congestion encountered.

Congestion is determined by comparing average queue size with queue thresholds. Average queue size is calculated through a formula based on the previous average and current queue size. Packets are marked based on this average size and the specified thresholds:

- Average queue size below minimum threshold: Packets are queued normally.
- Average queue size above maximum threshold: Packets are marked **congestion encountered**.
- Average queue size between minimum and maximum thresholds. Packets are queued or marked **congestion encountered**. The proportion of marked packets varies linearly with average queue size:
 - 0% are marked when average queue size is less than or equal to minimum threshold.
 - 100% are marked when average queue size is greater than or equal to maximum threshold.

When transmitted packets are marked **Non ECN Capable**, congestion packets are dropped, not marked.

Average queue length is tracked for transmit queues and the global pool independently. When either entity reaches its maximum threshold, all subsequent packets are marked.

The `no random-detect ecn` and `default random-detect ecn` commands disable ECN marking on the configuration mode queue, deleting the corresponding `random-detect ecn` command from *running-config*.

Command Mode

Uc-Tx-Queue configuration

Command Syntax

```
random-detect ecn minimum-threshold MIN maximum-threshold MAX
```

```
no random-detect ecn
```

```
default random-detect ecn
```

Parameters

MIN and **MAX** parameters must use the same data unit.

- **MIN** Minimum threshold. Options include:
 - **1 to 46080 segments** 208-byte segments units.
 - **1 to 9 mbytes** Megabyte units.
 - **1 to 9584 kbytes** Kilobyte units.
 - **1 to 9584640 bytes** Byte units.
- **MAX** Maximum threshold. Options include:
 - **1 to 46080 segments** 208-byte segments units.
 - **1 to 9 mbytes** Megabyte units.
 - **1 to 9584 kbytes** Kilobyte units.
 - **1 to 9584640 bytes** Byte units.

Related Commands

- `uc-tx-queue` places the switch in uc-tx-queue configuration mode.
- `qos random-detect ecn global-buffer (Trident and Tomahawk)` enables ECN marking for globally shared packet memory.

Examples

- These commands enable ECN marking of unicast packets from ***unicast transmit queue 4*** of ***interface Ethernet 15***, setting thresholds at ***10*** and ***100*** segments.

```
switch(config)#interface ethernet 15
switch(config-if-Et15)#uc-tx-queue 4
switch(config-if-Et15-uc-txq-4)#random-detect ecn minimum-
threshold 10 segments
maximum-threshold 100 segments
switch(config-if-Et15-uc-txq-4)#show active
interface Ethernet15
    uc-tx-queue 4
        random-detect ecn minimum-threshold 10 segments maximum-
threshold 100
segments
switch(config-if-Et15-uc-txq-4)#exit
switch(config-if-Et15)#
```

- This command disables ECN marking of unicast packets from ***unicast transmit queue 4*** of ***interface Ethernet 15***.

```
switch(config-if-Et15-uc-txq-4)#no random-detect ecn
switch(config-if-Et15-uc-txq-4)#show active
interface Ethernet15
switch(config-if-Et15-uc-txq-4)#exit
switch(config-if-Et15)#
```

9.1.11.36 service-policy type qos input

The **service-policy type qos input** command applies the specified policy map to a QoS profile. The profile is then applied to an interface in interface configuration mode using the **service-profile** command.

The **no service-policy type qos** and **default service-policy type qos** command deletes the policy map from the profile.

The **exit** command returns the switch to global configuration mode.

Command Mode

QoS Profile Configuration

Command Syntax

```
service-policy type qos input policy_map_name
no service-policy type qos input policy_map_name
default service-policy type qos input policy_map_name
```

Parameter

- ***policy_map_name*** QoS policy map name.

Example

This command applies the policy map **PM-1** to the QoS profile **TP**.

```
switch(config-qos-profile-TP)#service-policy type qos input PM-1
switch(config-qos-profile-TP)#
```

9.1.11.37 service-profile

The command applies the QoS profile to the configuration mode interface.

The **no service-profile** and the **default service-profile** command removes the QoS profile from the interface.

The **exit** command returns the switch to global configuration mode.

Command Mode

Interface-Ethernet Configuration

Interface-Port-Channel Configuration

Command Syntax

```
service-profile profile_name
```

```
no service-profile profile_name
```

```
default service-profile profile_name
```

Parameter

profile_name QoS profile name.

Example

This commands applies the QoS profile **TP** to **interface Ethernet 13**.

```
switch(config)#interface ethernet 13  
switch(config-if-Et13)#service-profile TP
```

9.1.11.38 set extcommunity

The **set extcommunity** command adds a color extended community to be applied to routes affected by the route-map. Multiple set clauses can be applied to a single route-map to configure multiple colors for routes. Negating the command removes the entry from the route-map.

Command Mode

Config-route-map mode

Command Syntax

```
set extcommunity COLOR-EXPRESSION [additive | delete]
no set extcommunity COLOR-EXPRESSION [additive | delete]
default set extcommunity COLOR-EXPRESSION [additive | delete]
```

Parameters

- **COLOR-EXPRESSION** The color extended community to be applied to routes affected by the route-map
- **additive** Adds the extended communities to those received.
- **delete** Deletes any matching extended color communities.

Example

```
arista(config)#route-map foo
arista(config-route-map foo)#set extcommunity color 1
arista(config-route-map foo)#set extcommunity color 2 color-only exact-
match
arista(config-route-map foo)#set extcommunity color 3 color-only
endpoint-match null
arista(config-route-map foo)#set extcommunity color 4 color-only
endpoint-match any
```

9.1.11.39 shape rate (Interface – Arad/Jericho)

The **shape rate** command specifies the maximum bandwidth for outbound traffic on the configuration mode interface, also known as queue shaping. The shape rate for individual transmit queues is configured by the **shape rate (Tx-queue – Arad/Jericho)** command. By default, outbound transmission rate is not bounded by a shape rate.

The **no shape rate** and **default shape rate** commands remove the shape rate bandwidth limit on the configuration mode interface by deleting the corresponding **shape rate** command from **running-config**.

Command Mode

Interface-Ethernet Configuration

Interface-Port-Channel Configuration

Command Syntax

```
shape rate byte_limit [kbps]
```

```
no shape rate
```

```
default shape rate
```

Parameters

byte_limit Shape rate applied to interface (Kbps). Value ranges from **162** to **100000000**.

Example

This command configures a port shape rate of 5 Gbps on **interface Ethernet 3/5/1**.

```
switch(config)#interface ethernet 3/5/1
switch(config-if-Et3/5/1)#shape rate 5000000
switch(config-if-Et3/5/1)#show qos interfaces ethernet 3/5/1
```

```
Ethernet3/5/1:
```

```
Port shaping rate: 5000012 / 5000000 kbps
```

Tx Queue	Bandwidth (percent)	Shape Rate (units)	Priority	ECN
7	- / -	- / - (-)	SP / SP	D
6	- / -	- / - (-)	SP / SP	D
5	- / -	- / - (-)	SP / SP	D
4	- / -	- / - (-)	SP / SP	D
3	- / -	- / - (-)	SP / SP	D
2	- / -	- / - (-)	SP / SP	D
1	- / -	- / - (-)	SP / SP	D
0	- / -	- / - (-)	SP / SP	D

```
switch(config-if-Et3/5/1)#
```

9.1.11.40 shape rate (Interface – FM6000)

The **shape rate** command specifies the maximum bandwidth for outbound traffic on the configuration mode interface, also known as queue shaping. The shape rate for individual transmit queues is configured by the [shape rate \(Tx-queue – FM6000\)](#) command. By default, outbound transmission rate is not bounded by a shape rate.

The **no shape rate** and **default shape rate** commands remove the shape rate bandwidth limit on the configuration mode interface by deleting the corresponding **shape rate** command from *running-config*.

Command Mode

Interface-Ethernet Configuration

Interface-Port-Channel Configuration

Command Syntax

```
shape rate byte_limit [kbps]
```

```
no shape rate
```

```
default shape rate
```

Parameters

byte_limit Shape rate applied to interface (Kbps). Value ranges from **7000** to **10000000**.

Guidelines

Enabling port shaping on an FM6000 interface disables queue shaping internally. Disabling port shaping restores queue shaping as specified in *running-config*.

Example

This command configures a port shape rate of **5 Gbps** on *interface Ethernet 5*.

```
switch(config)#interface ethernet 5  
switch(config-if-Et5)#shape rate 5000000  
switch(config-if-Et5)#
```

9.1.11.41 shape rate (Interface – Helix)

The **shape rate** command specifies the maximum bandwidth for outbound traffic on the configuration mode interface, also known as queue shaping. The shape rate for individual transmit queues is configured by the [shape rate \(Interface – Helix\)](#) command. By default, outbound transmission rate is not bounded by a shape rate.

The **no shape rate** and **default shape rate** commands remove the shape rate bandwidth limit on the configuration mode interface by deleting the corresponding **shape rate** command from *running-config*.

Command Mode

Interface-Ethernet Configuration

Interface-Port-Channel Configuration

Command Syntax

```
shape rate DATA_LIMIT
```

```
no shape rate
```

```
default shape rate
```

Parameters

- **DATA_LIMIT** Shape rate applied to interface. Value range varies with data unit:
 - **8 to 40000000** **8 to 40000000** kbytes per second.
 - **8 to 40000000kbps** **8 to 40000000** kbytes per second.
 - **8 to 60000000pps** **8 to 60000000** packets per second.

Guidelines

Shaping rates of at least **8** kbps are supported. At shaping rates smaller than **1** Mbps, granularity and rounding errors may skew the actual shaping rate by 20% from the specified rate.

Example

This command configures a port shape rate of **5 Gbps** on *interface Ethernet 17*.

```
switch(config)#interface ethernet 17
switch(config-if-Et17)#shape rate 5000000 kbps
switch(config-if-Et17)#show qos interface ethernet 17/3
```

```
Ethernet17:
```

```
Trust Mode: COS
Default COS: 0
Default DSCP: 0
```

```
Port shaping rate: 5000000 / 5000000 kbps
```

Tx Queue	Bandwidth Guaranteed (units)	Shape Rate (units)	Priority
7	- / - (-)	- / - (-)	SP / SP
6	- / - (-)	- / - (-)	SP / SP

```
switch(config-if-Et17)#
```

9.1.11.42 shape rate (Interface – Petra)

The **shape rate** command specifies the maximum bandwidth for outbound traffic on the configuration mode interface, also known as queue shaping. The shape rate for individual transmit queues is configured by the **shape rate (Tx-queue – Petra)** command. By default, outbound transmission rate is not bounded by a shape rate.

The **no shape rate** and **default shape rate** commands remove the shape rate bandwidth limit on the configuration mode interface by deleting the corresponding **shape rate** command from **running-config**.

Command Mode

Interface-Ethernet Configuration

Interface-Port-Channel Configuration

Command Syntax

```
shape rate data_limit [kbps]
```

```
no shape rate
```

```
default shape rate
```

Parameters

- **data_limit** Shape rate applied to interface (Kbps). Value ranges from **100** to **10000000**.

Guidelines

The following port shaping rates are supported:

- 1G ports: above 100 kbps.
- 10G ports: above 7900 kbps.

Commands that specify a smaller shape rate disable port shaping on the interface.

Example

This command configures a port shape rate of **5 Gbps** on **interface Ethernet 3/3**.

```
switch(config)#interface ethernet 3/3
switch(config-if-Et3/3)#shape rate 5000000
switch(config-if-Et3/3)#show active
interface Ethernet3/3
    shape rate 5000000
switch(config-if-Et3/3)#
```

9.1.11.43 shape rate (Interface – Trident and Tomahawk)

The **shape rate** command specifies the maximum bandwidth for outbound traffic on the configuration mode interface, also known as queue shaping. The shape rate for individual transmit queues is configured by the **shape rate (Tx-queue – Trident and Tomahawk)** command. By default, outbound transmission rate is not bounded by a shape rate.

The **no shape rate** and **default shape rate** commands remove the shape rate bandwidth limit on the configuration mode interface by deleting the corresponding **shape rate** command from **running-config**.

Command Mode

Interface-Ethernet Configuration

Interface-Port-Channel Configuration

Command Syntax

```
shape rate DATA_LIMIT
```

```
no shape rate
```

```
default shape rate
```

Parameters

- **DATA_LIMIT** Shape rate applied to interface. Value range varies with data unit:
 - **8** to **40000000** **8** to **40000000** kbytes per second.
 - **8** to **40000000kbps** **8** to **40000000** kbytes per second.
 - **8** to **60000000pps** **8** to **60000000** packets per second.

Guidelines

Shaping rates of at least **8** kbps are supported. At shaping rates smaller than **1** Mbps, granularity and rounding errors may skew the actual shaping rate by 20% from the specified rate.

Example

This command configures a port shape rate of **5 Gbps** on **interface Ethernet 5**.

```
switch(config)#interface ethernet 5
switch(config-if-Et5)#shape rate 5000000
switch(config-if-Et5)#
```

9.1.11.44 shape rate (Interface – Trident II)

The **shape rate** command specifies the maximum bandwidth for outbound traffic on the configuration mode interface, also known as queue shaping. The shape rate for individual transmit queues is configured by the [shape rate \(Tx-queue – Trident II\)](#) command. By default, outbound transmission rate is not bounded by a shape rate.

The **no shape rate** and **default shape rate** commands remove the shape rate bandwidth limit on the configuration mode interface by deleting the corresponding **shape rate** command from **running-config**.

Command Mode

Interface-Ethernet Configuration

Interface-Port-Channel Configuration

Command Syntax

```
shape rate DATA_LIMIT
```

```
no shape rate
```

```
default shape rate
```

Parameters

- **DATA_LIMIT** Shape rate applied to interface. Value range varies with data unit:
 - **8** to **40000000** **8** to **40000000** kbytes per second.
 - **8** to **40000000kbps** **8** to **40000000** kbytes per second.
 - **8** to **60000000pps** **8** to **60000000** packets per second.

Guidelines

Shaping rates of at least **8** kbps are supported. At shaping rates smaller than 1 Mbps, granularity and rounding errors may skew the actual shaping rate by 20% from the specified rate.

Example

This command configures a port shape rate of **5 Gbps** on **interface Ethernet 17/3**.

```
switch(config)#interface ethernet 17/3
switch(config-if-Et17/3)#shape rate 5000000 kbps
switch(config-if-Et17/3)#show qos interface ethernet 17/3

Ethernet17/3:
  Trust Mode: COS
  Default COS: 0
  Default DSCP: 0

  Port shaping rate: 5000000 / 5000000 kbps

  Tx      Bandwidth      Shape Rate      Priority
  Queue   Guaranteed (units) (units)
  -----
  7       - / -      ( - )          - / -      ( - )      SP / SP
  6       - / -      ( - )          - / -      ( - )      SP / SP

switch(config-if-Et17/3)#
```

9.1.11.45 shape rate (Tx-queue – Arad/Jericho)

The **shape rate** command specifies the maximum bandwidth for outbound traffic on the transmit queue, also known as queue shaping. The shape rate for interfaces is configured by the [shape rate \(Interface – Arad/Jericho\)](#) command. By default, the configured outbound transmission rate is not bounded by a transmit queue shape rate.

Shaping rates greater than **50000** kbps are supported. At lower shaping rates (less than 10 Mbps), granularity and rounding errors may skew the actual shaping rate by 20% from the specified rate.

The **no shape rate** and **default shape rate** commands remove the shape rate bandwidth limit on the configuration mode queue by deleting the corresponding **shape rate** command from **running-config**.

Command Mode

Tx-Queue Configuration

Command Syntax

```
shape rate byte_limit [kbps]
```

```
no shape rate
```

```
default shape rate
```

Parameters

byte_limit Shape rate applied to interface (Kbps). Value ranges from **50000** to **100000000**.

Related Command

[tx-queue \(Arad/Jericho\)](#) places the switch in tx-queue configuration mode.

Related information

- [shape rate \(Interface – Arad/Jericho\)](#)

Example

These commands configure a shape rate of 1 Gbps on transmit queues **3** and **4** of **interface Ethernet 3/4/1**.

```
switch(config)#interface ethernet 3/4/1
switch(config-if-Et3/4/1)#tx-queue 4
switch(config-if-Et3/4/1-txq-4)#shape rate 1000000 kbps
switch(config-if-Et3/4/1-txq-4)#tx-queue 3
switch(config-if-Et3/4/1-txq-3)#shape rate 1000000 kbps
switch(config-if-Et3/4/1-txq-3)#show qos interface ethernet 3/4/1
```

Ethernet3/4/1:

Port shaping rate: disabled

Tx Queue	Bandwidth (percent)	Shape Rate (units)	Priority	ECN
7	- / -	- / - (-)	SP / SP	D
6	- / -	- / - (-)	SP / SP	D
5	- / -	- / - (-)	SP / SP	D
4	- / -	999 / 1000 (Mbps)	SP / SP	D
3	- / -	999 / 1000 (Mbps)	SP / SP	D
2	- / -	- / - (-)	SP / SP	D
1	- / -	- / - (-)	SP / SP	D
0	- / -	- / - (-)	SP / SP	D

```
switch(config-if-Et3/4/1-txq-3) #
```

9.1.11.46 shape rate (Tx-queue – FM6000)

The **shape rate** command specifies the maximum bandwidth for outbound traffic on the transmit queue, also known as queue shaping. The shape rate for interfaces is configured by the [shape rate \(Interface – FM6000\)](#) command. By default, the configured outbound transmission rate is not bounded by a transmit queue shape rate.

Queue shaping on an FM6000 port is supported only when port shaping is not enabled on the interface. Enabling port shaping on a port disables queue shaping internally. Disabling port shaping restores queue shaping as specified by *running-config*.

Shaping rates greater than 460 kbps are supported. At lower shaping rates (less than 10 Mbps), granularity and rounding errors may skew the actual shaping rate by 20% from the specified rate.

The **no shape rate** and **default shape rate** commands remove the shape rate bandwidth limit on the transmit queue by deleting the corresponding **shape rate** command from *running-config*.

Command Mode

Tx-Queue Configuration

Command Syntax

```
shape rate byte_limit [kbps]
```

```
no shape rate
```

```
default shape rate
```

Parameters

byte_limit Shape rate applied to interface (Kbps). Value ranges from **464** to **1000000**.

Related Commands

- [tx-queue \(FM6000\)](#) places the switch in tx-queue configuration mode.
- [shape rate \(Interface – FM6000\)](#) configures the shape rate for a configuration mode interface.

Example

These commands configure a shape rate of 1 Gbps (1,000,000 Kbps) on transmit queues 3 and 4 of **interface Ethernet 19**.

```
switch(config)#interface ethernet 19
switch(config-if-Et19)#tx-queue 4
switch(config-if-Et19-txq-4)#shape rate 1000000
switch(config-if-Et19-txq-4)#tx-queue 3
switch(config-if-Et19-txq-3)#shape rate 1000000
switch(config-if-Et19-txq-3)#show qos interface ethernet 19
```

Ethernet19:

Trust Mode: COS

Tx-Queue	Bandwidth (percent)	Shape Rate (Kbps)	Priority
6	N/A	disabled	strict
5	N/A	disabled	strict
4	N/A	1000000	strict
3	25	1000000	round-robin
2	25	disabled	round-robin
1	25	disabled	round-robin
0	25	disabled	round-robin

```
switch(config-if-Et19-txq-3) #
```

9.1.11.47 shape rate (Tx-queue – Helix)

The **shape rate** command specifies the maximum bandwidth for outbound traffic on the transmit queue, also known as queue shaping. The shape rate for interfaces is configured by the **shape rate (Interface – Helix)** command. By default, the configured outbound transmission rate is not bounded by a transmit queue shape rate.

The **no shape rate** and **default shape rate** commands remove the shape rate bandwidth limit on the configuration mode transmit queue by deleting the corresponding **shape rate** command from **running-config**.

Command Mode

Tx-Queue Configuration

Command Syntax

```
shape rate byte_limit [kbps]
```

```
no shape rate
```

```
default shape rate
```

Parameters

- **DATA_LIMIT** Shape rate applied to the queue. Value range varies with data unit:
 - **8 to 40000000** **8** to 40,000,000 kbytes per second.
 - **8 to 40000000 kbps** **8** to **40000000** kbytes per second.
 - **8 to 60000000 pps** **8** to **60000000** packets per second.

Restrictions

Queue shaping is not supported in cut-through mode.

Related Commands

- **tx-queue (Helix)** places the switch in tx-queue configuration mode.
- **shape rate (Interface – Helix)** configures the shape rate for a configuration mode interface.

Example

These commands configure a shape rate of 1 Gbps (1,000,000 Kbps) on transmit queues 3 and 4 of **interface Ethernet 17/3**.

```
switch(config)#interface ethernet 17/3
switch(config-if-Et17/3)#tx-queue 4
switch(config-if-Et17/3-txq-4)#shape rate 1000000 kbps
switch(config-if-Et17/3-txq-4)#tx-queue 3
switch(config-if-Et17/3-txq-3)#shape rate 1000000 kbps
switch(config-if-Et17/3-txq-3)#show qos interface ethernet 17/3
```

Ethernet17/3:

Tx Queue	Bandwidth Guaranteed (units)	Shape Rate (units)	Priority
7	- / - (-)	- / - (-)	SP / SP
6	- / - (-)	- / - (-)	SP / SP
5	- / - (-)	- / - (-)	SP / SP
4	- / - (-)	1 / 1 (Gbps)	SP / SP
3	- / - (-)	1 / 1 (Gbps)	SP / SP
2	- / - (-)	- / - (-)	SP / SP
1	- / - (-)	- / - (-)	SP / SP
0	- / - (-)	- / - (-)	SP / SP

```
switch(config-if-Et17/3-txq-3) #
```

9.1.11.48 shape rate (Tx-queue – Petra)

The **shape rate** command specifies the maximum bandwidth for outbound traffic on the configuration mode transmit queue, also known as queue shaping. The shape rate for interfaces is configured by the [shape rate \(Interface – Petra\)](#) command. By default, the configured outbound transmission rate is not bounded by a transmit queue shape rate.

Queue shaping applies only to unicast traffic. Shaping rates of at least 162 Kbps are supported.

The **no shape rate** and **default shape rate** commands remove the shape rate bandwidth limit on the configuration mode queue by deleting the corresponding **shape rate** command from *running-config*.

Command Mode

Tx-Queue Configuration

Command Syntax

```
shape rate DATA_LIMIT
```

```
no shape rate
```

```
default shape rate
```

Parameters

- **DATA_LIMIT** Shape rate applied to the queue. Value range varies with data unit:
 - **8 to 40000000 kbps** Range is from **8** to **40000000** kbytes per second.
 - **8 to 40000000 kbps** Range is from **8** to **40000000** kbytes per second.
 - **8 to 60000000 pps** Range is from **8** to **60000000** packets per second.

Shaping rates greater than 460 kbps are supported. At lower shaping rates (less than 10 Mbps), granularity and rounding errors may skew the actual shaping rate by 20% from the specified rate.

Related Commands

- [tx-queue \(Petra\)](#) places the switch in tx-queue configuration mode.
- [shape rate \(Interface – Petra\)](#) configures the shape rate for a configuration mode interface.

Example

These commands configure a shape rate of 1 Gbps (1,000,000 Kbps) on transmit queues **3** and **4** of *interface Ethernet 3/28*.

```
switch(config)#interface ethernet 3/28
switch(config-if-Et3/28)#tx-queue 4
switch(config-if-Et3/28-txq-4)#shape rate 1000000
switch(config-if-Et3/28-txq-4)#tx-queue 3
switch(config-if-Et3/28-txq-3)#shape rate 1000000
switch(config-if-Et3/28-txq-3)#show qos interface ethernet 3/28
```

Ethernet3/28:

Tx-Queue	Bandwidth (percent)	Shape Rate (Kbps)	Priority
7	N/A	disabled	strict
6	N/A	disabled	strict
5	N/A	disabled	strict
4	N/A	1000000	strict
3	25	1000000	round-robin
2	25	disabled	round-robin
1	25	disabled	round-robin

```
0          25      disabled  round-robin  
switch(config-if-Et3/28-txq-3) #
```

9.1.11.49 shape rate (Tx-queue – Trident and Tomahawk)

The **shape rate** command specifies the maximum bandwidth for outbound traffic on the configuration mode transmit queue, also known as queue shaping. The shape rate for interfaces is configured by the **shape rate (Interface – Trident and Tomahawk)** command. By default, the configured outbound transmission rate is not bounded by a transmit queue shape rate.

The **no shape rate** and **default shape rate** commands remove the shape rate limit from the configuration mode transmit queue by deleting the corresponding **shape rate** command from **running-config**.

Command Mode

Mc-Tx-Queue configuration

Uc-Tx-Queue configuration

Command Syntax

```
shape rate DATA_LIMIT
```

```
no shape rate
```

```
default shape rate
```

Parameters

- **DATA_LIMIT** Shape rate applied to the queue. Value range varies with data unit:
- **8 to 4000000 kbps** Range is from **8** to **4000000** kbytes per second.
- **8 to 4000000 kbps** Range is from **8** to **4000000** kbytes per second.
- **8 to 6000000 pps** Range is from **8** to **6000000** packets per second.

Related Commands

- **mc-tx-queue** places the switch in mc-tx-queue configuration mode.
- **uc-tx-queue** places the switch in uc-tx-queue configuration mode.
- **shape rate (Interface – Trident and Tomahawk)** configures the shape rate for a configuration mode interface.

Guidelines

Shaping rates of at least 8 kbps are supported. At shaping rates smaller than 1 Mbps, granularity and rounding errors may skew the actual shaping rate by 20% from the specified rate.

When two queues source traffic from the same traffic class and the higher priority queue is shaped, that queue consumes all internal buffers, starving the lower priority queue even if bandwidth is available.

Example

These commands configure a shape rate of 1 Gbps (1,000,000 Kbps) on **unicast transmit queues 3** and **multicast transmit 4** of **interface Ethernet 7**.

```
switch(config)#interface ethernet 7
switch(config-if-Et7)#uc-tx-queue 3
switch(config-if-Et7-uc-txq-3)#shape rate 1000000
switch(config-if-Et7-uc-txq-3)#mc-tx-queue 2
switch(config-if-Et7-mc-txq-2)#shape rate 1000000
switch(config-if-Et7-mc-txq-2)#show qos interface ethernet 7
```

Ethernet7:	Tx-Queue Group	Bandwidth (percent)	Shape Rate (Kbps)	Priority	Priority

```
-----  
1      UC7      N/A      disabled  strict  
1      UC6      N/A      disabled  strict  
1      MC3      N/A      disabled  strict  
1      UC5      N/A      disabled  strict  
0      UC4      N/A      disabled  strict  
0      MC2      N/A      1000000  strict  
0      UC3      20      1000000  round-robin  
0      UC2      16      disabled  round-robin  
0      MC1      16      disabled  round-robin  
0      UC1      16      disabled  round-robin  
0      UC0      16      disabled  round-robin  
0      MC0      16      disabled  round-robin  
0  
switch(config-if-Et7-mc-txq-2) #
```

9.1.11.50 shape rate (Tx-queue – Trident II)

The **shape rate** command specifies the maximum bandwidth for outbound traffic on the configuration mode transmit queue, also known as queue shaping. The shape rate for interfaces is configured by the **shape rate (Interface – Trident II)** command. By default, the configured outbound transmission rate is not bounded by a transmit queue shape rate.

The **no shape rate** and **default shape rate** commands remove the shape rate bandwidth limit on the configuration mode transmit queue by deleting the corresponding **shape rate** command from **running-config**.

Command Mode

Tx-Queue Configuration

Command Syntax

```
shape rate byte_limit [kbps]
```

```
no shape rate
```

```
default shape rate
```

Parameters

- **DATA_LIMIT** Shape rate applied to the queue. Value range varies with data unit:
 - **8 to 40000000 kbps** Range is from **8** to **40000000** kbytes per second.
 - **8 to 40000000 kbps** Range is from **8** to **40000000** kbytes per second.
 - **8 to 60000000 pps** Range is from **8** to **60000000** packets per second.

Restrictions

Queue shaping is not supported in cut-through mode

Related Commands

- **tx-queue (Trident II)** places the switch in tx-queue configuration mode.
- **shape rate (Interface – Trident II)** configures the shape rate for a configuration mode interface.

Example

These commands configure a shape rate of 1 Gbps (1,000,000 Kbps) on transmit queues 3 and 4 of **interface Ethernet 17/3**.

```
switch(config)#interface ethernet 17/3
switch(config-if-Et17/3)#tx-queue 4
switch(config-if-Et17/3-txq-4)#shape rate 1000000 kbps
switch(config-if-Et17/3-txq-4)#tx-queue 3
switch(config-if-Et17/3-txq-3)#shape rate 1000000 kbps
switch(config-if-Et17/3-txq-3)#show qos interface ethernet 17/3
```

Ethernet17/3:

Tx Queue	Bandwidth Guaranteed (units)	Shape Rate (units)	Priority
7	- / - (-)	- / - (-)	SP / SP
6	- / - (-)	- / - (-)	SP / SP
5	- / - (-)	- / - (-)	SP / SP
4	- / - (-)	1 / 1 (Gbps)	SP / SP
3	- / - (-)	1 / 1 (Gbps)	SP / SP
2	- / - (-)	- / - (-)	SP / SP
1	- / - (-)	- / - (-)	SP / SP
0	- / - (-)	- / - (-)	SP / SP

```
switch(config-if-Et17/3-txq-3) #
```

9.1.11.51 show platform petraA traffic-class

The **show platform petraA traffic-class** command displays the traffic class assignment on all specified Petra chips. Each chip controls eight Ethernet interfaces. The default traffic class of an interface is specified by the traffic class assigned to the chip that controls the interface.

Traffic class assignments are configured with the [platform petraA traffic-class](#) command.

Valid command options include:

- **show platform petraA traffic-class** Traffic class of all chips on all linecard.
- **show platform petraA CHIP_NAME traffic-class** Traffic class of specified chip.
- **show platform petraA MODULE_NAME traffic-class** Traffic class of all chips on specified linecard.

Command Mode

EXEC

Command Syntax

```
show platform petraA traffic-class
```

```
show platform petraA CHIP_NAME traffic-class
```

```
show platform petraA MODULE_NAME traffic-class
```

Parameters

- **CHIP_NAME** Name of Petra chip on linecard that control Ethernet ports. Options include:
 - **petra cardX / chipY** All ports on PetraA chip **chipY** on linecard **cardX** (7500 Series).
 - **petra chipZ** All ports on PetraA chip **chipZ** (7048 Series).

7500 Series

Switches can contain up to eight linecards. **cardX** varies from **3** to **10**.

Each linecard contains six PetraA chips. Each chip controls eight ports. **chipY** varies from **0** to **5**:

- 0 controls ports 1 through 8
- 1 controls ports 9 through 16
- 2 controls ports 17 through 24
- 3 controls ports 25 through 32
- 4 controls ports 33 through 40
- 5 controls ports 41 through 48

7048 Series

Each switch contains two PetraA chips. **chipZ** varies from **0** to **1**:

- 0 controls ports 1 through 32
- 1 controls ports 33 through 52
- **MODULE_NAME** Name and number of linecard (7500 Series). Options include:
 - **module linecard mod_num** Linecard number (**3** to **10**).
 - **module mod_num** Linecard number (**3** to **10**).

Related Command

[platform petraA traffic-class](#) configures the default traffic class used by all ports on a specified chip.

Example

This command displays the traffic class of all chips on *linecard 3*.

```
switch#show platform petraA module linecard 3 traffic-class
Petra3/0 traffic-class: 1
Petra3/1 traffic-class: 1
Petra3/2 traffic-class: 1
Petra3/3 traffic-class: 1
Petra3/4 traffic-class: 5
Petra3/5 traffic-class: 1
switch#
```

9.1.11.52 show platform trident tcam qos detail

The `show platform trident tcam qos detail` command displays the list of all the SVIs that are sharing the TCAM entries.

Command Mode

EXEC

Command Syntax

```
show platform trident tcam qos detail
```

Example

This command displays the list of all the SVIs that are sharing the TCAM entries.

```
switch(config)#show platform trident tcam qos detail
=== Policy-map p01 type qos on switch Linecard0/0 ===
Interfaces : Vlan2 Vlan1
== Interface BitMap ==
0x00000000000000000000000000000001FFFFFFE
```

9.1.11.53 show platform trident tcam shared vlan interface-class-id

The **show platform trident tcam shared vlan interface-class-id** command displays what SVIs are currently sharing the QoS policy-map in the below output under QoS PMAP Data.

Command Mode

EXEC

Command Syntax

```
show platform trident tcam shared vlan interface-class-id
```

Example

This command displays what SVIs are currently sharing the QoS policy-map in the below output under QoS PMAP Data.

```
switch(config)#show platform trident tcam shared vlan interface-  
class-id  
  
=== Shared RACL Data on switch Linecard0/0 ===  
=== Shared QoS Policy-map Data on switch Linecard0/0 ===  
Interface Class Id          VLANs  
1                            1 2
```

9.1.11.54 show platform xp qos tcam hit

The `show platform xp qos tcam hit` command displays the TCAM entries programmed for each policy-map as well as the traffic hits. The `hits` option is used to see the TCAM entries with nonzero traffic hits.

Command Mode

EXEC

Command Syntax

```
show platform xp qos tcam hit
```

Example

This command displays the QoS TCAM hits on *interface Ethernet 10/1*.

```
switch#show platform xp qos tcam hit
=== Policy-map test type qos on switch 0 ===
Assigned to ports: Ethernet10/1
== Class-map test type qos ==
=== ACL test
=====
|Seq|AclId|Prot|Port|SPort|Ecn|Fflg|DPort|Vlan|Action|Hits|Src Ip|Dest Ip|hwId  | | | | | | | |
dscp|cos  |tc|PolID| | | |
=====
| 10| 0x01| | | | | |0x04| | | 4  |-  | -  | -  |91852787| | | 0 | 0x00 | | | |
|0xfb| | | | |
-----
```

9.1.11.55 show policy-map interface

The **show policy-map interface** command displays contents of the policy map applied to specified the interface.

Command Mode

EXEC

Command Syntax

```
show policy-map interface interface_name
```

Parameters

- ***interface_name*** Interface for which command returns data. Options include:
 - ***no parameter*** Returns data for all interfaces.
 - **ethernet *e_range*** Ethernet interfaces specified by ***e_range***.
 - **port-channel *p_range*** Port channel interfaces specified by ***p_range***.

Example

This command displays the name and contents of the policy map applied to ***interface Ethernet 1***.

```
switch#show policy-map interface ethernet 1
Service-policy input: p1
Hardware programming status: Successful

Class-map: c2001 (match-any)
  Match: vlan 2001 0xffff
        set dscp 4

Class-map: c2002 (match-any)
  Match: vlan 2002 0xffff
        set dscp 8

Class-map: c2003 (match-any)
  Match: vlan 2003 0xffff
        set dscp 12
```

9.1.11.56 show policy-map

The **show policy-map** command displays the policy map information for the configured policy map.

Command Mode

EXEC

Command Syntax

```
show policy-map policy_map_name [counters][interface | summary]
```

Parameters

- **policy_map_name** QoS policy map name.
- **counters** Specifies the policy map traffic match count (This parameter is applicable only on DCS-7010, DCS-7050X, DCS7250X, DCS-7300X and DCS-7280(E/R), DCS-7500(E/R) series switches.)
- **interface** Specifies the service policy on an interface.
- **summary** Policy map summary.

Examples

- The **show policy-map** command displays the information for the policy map **policy1**.

```
switch#show policy-map policy1
Service-policy policy1
Class-map: class1 (match-any)
Match: ip access-group name acl1
Police cir 512000 bps bc 96000 bytes
Class-map: class-default (match-any)
```

- The **show policy-map counters** command displays the policy map traffic match count for the policy map configured.

```
switch#show policy-map policy1 counters

Service-policy input: policy1
Hardware programming status: Successful
Class-map: class1 (match-any)
  Match: vlan 20-40,1000-1250
        police rate 100 mbps burst-size 100 kbytes
        Interface: Ethernet16/1
          Conformed 28621 packets, 7098008 bytes ----- packet match
count
Class-map: class-default (match-any)
  Matched Packets: 19 ----- packet match count
```

9.1.11.57 show qos interfaces random-detect ecn

The **show qos interfaces random-detect ecn** command displays the Explicit Congestion Notification (ECN) configuration for each transmit queue on the specified interfaces.

Command Mode

EXEC

Command Syntax

```
show qos interfaces [INTERFACE_NAME] random-detect ecn
```

Parameters

- **INTERFACE_NAME** Interface for which command returns data. Options include:
 - **no parameter** Returns data for all interfaces.
 - **ethernet e_range** Ethernet interfaces specified by **e_range**.
 - **port-channel p_range** Port-Channel Interfaces specified by **p_range**.

Example

This command configures ECN parameters for transmit queues **0** through **3** on **interface Ethernet 3/5/1**, then displays that configuration.

```
switch(config)#interface ethernet 3/5/1
switch(config-if-Et3/5/1)#tx-queue 0
switch(config-if-Et3/5/1-txq-0)#random-detect ecn minimum-threshold 2560 kbytes
maximum-threshold 256000 kbytes
switch(config-if-Et3/5/1-txq-0)#tx-queue 1
switch(config-if-Et3/5/1-txq-1)#random-detect ecn minimum-threshold 25600 kbytes
maximum-threshold 128000 kbytes
switch(config-if-Et3/5/1-txq-1)#tx-queue 2
switch(config-if-Et3/5/1-txq-2)#random-detect ecn minimum-threshold 25600 bytes
maximum-threshold 128000 bytes
switch(config-if-Et3/5/1-txq-2)#tx-queue 3
switch(config-if-Et3/5/1-txq-3)#random-detect ecn minimum-threshold 25 mbytes
maximum-threshold 128 mbytes
switch(config-if-Et3/5/1-txq-3)#show qos interfaces ethernet 3/5/1 random-detect
ecn
```

Ethernet3/5/1:

Tx-Queue	Minimum Threshold	Maximum Threshold	Threshold Unit
7	-	-	-
6	-	-	-
5	-	-	-
4	-	-	-
3	25	128	mbytes
2	25600	128000	bytes
1	25600	128000	kbytes
0	2560	256000	kbytes

```
switch(config-if-Et3/5/1-txq-3)#
```

9.1.11.58 show qos interfaces trust

The `show qos interfaces trust` command displays the configured and operational QoS trust mode of all specified interfaces.

Command Mode

EXEC

Command Syntax

```
show qos interfaces [INTERFACE_NAME] trust
```

Parameters

- **INTERFACE_NAME** Interface for which command returns data. Options include:
 - **no parameter** Returns data for all interfaces.
 - **ethernet e_range** Ethernet interfaces specified by **e_range**.
 - **port-channel p_range** Port-Channel Interfaces specified by **p_range**.

Example

These commands configure a variety of QoS trust settings on a set of interfaces, then displays the QoS trust mode on these interfaces.

```
switch(config)#interface ethernet 1/1
switch(config-if-Et1/1)#qos trust cos
switch(config-if-Et1/1)#interface ethernet 1/2
switch(config-if-Et1/2)#qos trust dscp
switch(config-if-Et1/2)#interface ethernet 1/3
switch(config-if-Et1/3)#no qos trust
switch(config-if-Et1/3)#interface ethernet 1/4
switch(config-if-Et1/4)#default qos trust
switch(config-if-Et1/4)#interface ethernet 2/1
switch(config-if-Et2/1)#no switchport
switch(config-if-Et2/1)#default qos trust
switch(config-if-Et2/1)#show qos interface ethernet 1/1 - 2/4
trust
```

Port	Trust Mode	
	Operational	Configured
Ethernet1/1	COS	COS
Ethernet1/2	DSCP	DSCP
Ethernet1/3	UNTRUSTED	UNTRUSTED
Ethernet1/4	COS	DEFAULT
Ethernet2/1	DSCP	DEFAULT
Ethernet2/2	COS	DEFAULT
Ethernet2/3	COS	DEFAULT
Ethernet2/4	COS	DEFAULT

```
switch(config-if-Et2/1)#
```

9.1.11.59 show qos interfaces

The **show qos interfaces** command displays the QoS, DSCP, and transmit queue configuration on a specified interface. Information provided by this command includes the ports trust setting, the default CoS value, and the DSCP value.

Command Mode

EXEC

Command Syntax

```
show qos interfaces INTERFACE_NAME
```

Parameters

- **INTERFACE_NAME** Interface For which command returns data. Options include:
 - **no parameter** Returns data for all interfaces.
 - **ethernet e_num** Ethernet interface specified by **e_num**.
 - **port-channel p_num** Port-Channel Interface specified by **p_num**.

Example

This command lists the QoS configuration for *interface Ethernet 4*.

```
switch>show qos interfaces ethernet 4

Ethernet4:
  Trust Mode: COS
  Default COS: 0
  Default DSCP: 0

  Port shaping rate: 5000000Kbps

  Tx-Queue   Bandwidth   ShapeRate   Priority
            (percent)   (Kbps)
  -----
            0         50     disabled   round-robin
            1         50     disabled   round-robin
            2        N/A     disabled   strict
            3        N/A     1000000    strict
            4        N/A     1000000    strict
            5        N/A     1500000    strict
            6        N/A     2000000    strict

switch>
```

9.1.11.60 show qos interfaces latency maximum

The `show qos interfaces latency maximum` command displays the maximum latency tail-drop threshold active on each Tx queue for a specified interface.

Command Mode

EXEC

Command Syntax

```
show qos interfaces INTERFACE_NAME latency maximum
```

Parameters

- ***INTERFACE_NAME***: Name of the interface.

This command lists the maximum latency for VOQ tail drop on ***interface Ethernet 23/1***.

```
switch#show qos interfaces ethernet 23/1 latency maximum
```

```
Ethernet23/1:
```

Tx Queue	Maximum Latency
-----	-----
7	-
6	-
5	-
4	-
3	10 ms
2	-
1	-
0	-

```
switch#show qos profile
```

```
qos profile latency
```

```
tx-queue 3
```

```
latency maximum 4000 microseconds
```

```
Tx-queue 4
```

```
latency maximum 30 milliseconds
```

```
switch#
```

9.1.11.61 show qos maps

The **show qos maps** command lists the number of traffic classes that the switch supports and displays the CoS-Traffic Class, DSCP-Traffic Class, Traffic Class-CoS, and Traffic Class-Transmit Queue maps.

Command Mode

EXEC

Command Syntax

```
show qos maps
```

Example

This command displays the QoS maps that are configured on the switch.

```
switch>show qos maps
Number of Traffic Classes supported: 8
Number of Transmit Queues supported: 8
Cos Rewrite: Disabled
Dscp Rewrite: Disabled

Cos-tc map:
cos:  0  1  2  3  4  5  6  7
-----
tc:   1  0  2  3  4  5  6  7

Dscp-tc map:
d1 :  d2 0  1  2  3  4  5  6  7  8  9
-----
0 :    1  1  1  1  1  1  1  1  0  0
1 :    0  0  0  0  0  0  2  2  2  2
2 :    2  2  2  2  3  3  3  3  3  3
3 :    3  3  4  4  4  4  4  4  4  4
4 :    5  5  5  5  5  5  5  5  6  6
5 :    6  6  6  6  6  6  7  7  7  7
6 :    7  7  7  7

Tc-cos map:
tc:   0  1  2  3  4  5  6  7
-----
cos:  1  0  2  3  4  5  6  7

Tc-dscp map:
tc:   0  1  2  3  4  5  6  7
-----
dscp:  8  0 16 24 32 40 48 56

Tc - tx-queue map:
tc:           0  1  2  3  4  5  6  7
-----
tx-queue:    0  1  2  3  4  5  6  7

switch>
```

9.1.11.62 show qos profile summary

The **show qos profile summary** command displays the QoS profile summary of those which are part of the running configuration.

Command Mode

EXEC

Command Syntax

```
show qos profile summary
```

Example

This command shows a summary of all QoS profiles configured on the switch.

```
switch(config)#show qos profile summary  
Qos Profile: p  
Configured on: Et13,7  
Fabric  
Po12  
Qos Profile: p2  
Configured on: Et56
```

9.1.11.63 show qos profile

The **show qos profile** command displays the contents of the specified QoS profile or of all QoS profiles in the running configuration.

Command Mode

EXEC

Command Syntax

```
show qos profile profile_name
```

Parameter

- ***profile_name*** QoS profile name.

Examples

- This command displays the contents of all QoS profiles configured on the switch.

```
switch(config)#show qos profile
qos profile p
qos cos 1
no priority-flow-control pause watchdog
priority-flow-control priority 1 no-drop
priority-flow-control priority 2 no-drop
qos profile p2
qos cos 3
priority-flow-control priority 0 no-drop
```

- This command displays the configuration attached and information specific to **QoS profile p2**.

```
switch#show qos profile p2
qos profile p2
qos cos 3
priority-flow-control priority 0 no-drop
```

9.1.11.64 show qos random-detect ecn

```
show qos random-detect ecn
```

The command displays the global Explicit Congestion Notification (ECN) configuration.

Command Mode

EXEC

Command Syntax

```
show qos random-detect ecn
```

Example

These commands configure global ECN parameters, then displays that configuration.

```
switch(config)#qos random-detect ecn global-buffer minimum-thres
hold 2 mbytes
maximum-threshold 5 mbytes
switch(config)#show qos random-detect ecn

Minimum Threshold: 2
Maximum Threshold: 5
Threshold Unit: mbytes

switch(config)#
```

9.1.11.65 show run|grep sharing

The **show run|grep sharing** command displays whether the QoS policy-map sharing on SVIs is enabled or disabled.

Command Mode

EXEC

Command Syntax

```
show run|grep sharing
```

Example

This command displays whether the QoS policy-map sharing on SVIs is enabled or disabled.

```
switch#show run|grep sharing  
hardware access-list qos resource sharing vlan in ----  
If this message is displayed then QoS policy-map sharing on SVIs  
is enabled.
```

9.1.11.66 tx-queue (Arad/Jericho)

The **tx-queue** command places the switch in Tx-queue configuration mode to configure a transmit queue on the configuration mode interface. Tx-queue configuration mode is not a group change mode; **running-config** is changed immediately after commands are executed. The **exit** command does not affect the configuration.

Arad and Jericho platform switches have eight queues, **0** through **7**, and all queues are exposed through the CLI. However, **queue 7** is not user-configurable. **Queue 7** is always mapped to **traffic class 7**, which is reserved for control traffic.

The **exit** command returns the switch to the configuration mode for the base Ethernet or port channel interface.

The **no tx-queue** and **default tx-queue** commands remove the configuration for the specified transmit queue by deleting all corresponding **tx-queue** mode statements from **running-config**.

Command Mode

Interface-Ethernet Configuration

Interface-Port-Channel Configuration

Command Syntax

```
tx-queue queue_level
```

Parameters

- **queue_level** The transmit queue. Values range from **0** to **7**.

Commands Available in tx-queue Configuration Mode

- [bandwidth percent \(Arad/Jericho\)](#)
- [priority \(Arad/Jericho\)](#)
- [shape rate \(Tx-queue – Arad/Jericho\)](#)

Guidelines

Arad and Jericho platform switch queues handle unicast traffic. Queues for multicast traffic are not supported.

Example

This command enters Tx-queue configuration mode for **transmit queue 4** of **interface Ethernet 3/3/3**.

```
switch(config)#interface ethernet 3/3/3
switch(config-if-Et3/3/3)#tx-queue 4
switch(config-if-Et3/3/3-txq-4)#
```

9.1.11.67 tx-queue (FM6000)

The **tx-queue** command places the switch in Tx-queue configuration mode to configure a transmit queue on the configuration mode interface. Tx-queue configuration mode is not a group change mode; **running-config** is changed immediately after commands are executed. The **exit** command does not affect the configuration.

FM6000 platform switches have eight queues, **0** through **7**. All queues are exposed through the CLI and are user configurable.

The **exit** command returns the switch to the configuration mode for the base Ethernet or port channel interface.

The **no tx-queue** and **default tx-queue** commands remove the configuration for the specified transmit queue by deleting the all corresponding **tx-queue** mode commands from **running-config**.

Command Mode

Interface-Ethernet Configuration

Interface-Port-Channel Configuration

Command Syntax

```
tx-queue queue_level
```

Parameters

queue_level The transmit queue. Values range from **0** to **7**.

Commands Available in tx-queue Configuration Mode

- [bandwidth percent \(FM6000\)](#)
- [priority \(FM6000\)](#)
- [shape rate \(Tx-queue – FM6000\)](#)

Guidelines

FM6000 platform switch queues handle unicast and multicast traffic.

Example

This command enters Tx-queue configuration mode for **transmit queue 3** of **interface Ethernet 5**.

```
switch(config)#interface ethernet 5  
switch(config-if-Et5)#tx-queue 3  
switch(config-if-Et5-txq-3)#
```

9.1.11.68 tx-queue (Helix)

The **tx-queue** command places the switch in Tx-queue configuration mode to configure a transmit queue on the configuration mode interface. Tx-queue configuration mode is not a group change mode; **running-config** is changed immediately after commands are executed. The **exit** command does not affect the configuration.

Helix platform switches have eight unicast (UC0 – UC7) and eight multicast (MC0 – MC7) queues. Each UCx-MCx queue set is combined into a single queue group (L1.x), which is exposed to the CLI through this command.

The **exit** command returns the switch to the configuration mode for the base Ethernet or port channel interface.

The **no tx-queue** and **default tx-queue** commands remove the configuration for the specified transmit queue by deleting the all corresponding **tx-queue** mode commands from **running-config**.

Command Mode

Interface-Ethernet Configuration

Interface-Port-Channel Configuration

Command Syntax `tx-queue queue_level`

Parameters

queue_level Transmit queue group number. Values range from **0** to **7**.

Commands Available in tx-queue Configuration Mode

- [bandwidth guaranteed \(Helix\)](#)
- [shape rate \(Tx-queue – Helix\)](#)

Guidelines

Helix platform switch queues handle unicast and multicast traffic.

Example

This command enters Tx-queue configuration mode for **transmit queue 4** of **interface Ethernet 17/3**.

```
switch(config)#interface ethernet 17/3
switch(config-if-Et17/3)#tx-queue 4
switch(config-if-Et17/3-txq-4)#
```

9.1.11.69 tx-queue (Petra)

The **tx-queue** command places the switch in Tx-queue configuration mode to configure a transmit queue on the configuration mode interface. Tx-queue configuration mode is not a group change mode; **running-config** is changed immediately after commands are executed. The **exit** command does not affect the configuration.

Petra platform switches have eight queues, **0** through **7**, and all queues are exposed through the CLI. However, **queue 7** is not user-configurable. **Queue 7** is always mapped to **traffic class 7**, which is reserved for control traffic.

The **exit** command returns the switch to the configuration mode for the base Ethernet or port channel interface.

The **no tx-queue** and **default tx-queue** commands remove the configuration for the specified transmit queue by deleting the all corresponding **tx-queue** mode commands from **running-config**.

Command Mode

Interface-Ethernet Configuration

Interface-Port-Channel Configuration

Command Syntax

```
tx-queue queue_level
```

Parameters

queue_level The transmit queue. Values range from **0** to **7**.

Commands Available in tx-queue Configuration Mode

- [bandwidth percent \(Petra\)](#)
- [priority \(Petra\)](#)
- [shape rate \(Tx-queue – Petra\)](#)

Guidelines

Petra platform switch queues handle unicast traffic. Queues for multicast traffic are not supported.

Example

This command enters Tx-queue configuration mode for **transmit queue 3** of **interface Ethernet 3/3**.

```
switch(config)#interface ethernet 3/3
switch(config-if-Et3/3)#tx-queue 3
switch(config-if-Et3/3-txq-3)#
```

9.1.11.70 tx-queue (Trident II)

The **tx-queue** command places the switch in Tx-queue configuration mode to configure a transmit queue on the configuration mode interface. Tx-queue configuration mode is not a group change mode; **running-config** is changed immediately after commands are executed. The **exit** command does not affect the configuration.

Trident II platform switches have eight unicast (UC0 – UC7) and eight multicast (MC0 – MC7) queues. Each UCx-MCx queue set is combined into a single queue group (L1.x), which is exposed to the CLI through this command.

The **exit** command returns the switch to the configuration mode for the base Ethernet or port channel interface.

The **no tx-queue** and **default tx-queue** commands remove the configuration for the specified transmit queue by deleting the all corresponding **tx-queue** mode commands from **running-config**.

Command Mode

Interface-Ethernet Configuration

Interface-Port-Channel Configuration

Command Syntax

```
tx-queue queue_level
```

Parameters

queue_level Transmit queue group number. Values range from **0** to **7**.

Commands Available in tx-queue Configuration Mode

- [bandwidth guaranteed \(Trident II\)](#)
- [shape rate \(Tx-queue – Trident II\)](#)

Trident II platform switch queues handle unicast and multicast traffic.

Example

This command enters Tx-queue configuration mode for **transmit queue 4** of **interface Ethernet 17/3**.

```
switch(config)#interface ethernet 17/3
switch(config-if-Et17/3)#tx-queue 4
switch(config-if-Et17/3-txq-4)#
```

9.1.11.71 uc-tx-queue

The `uc-tx-queue` command places the switch in uc-tx-queue configuration mode to configure a unicast transmit queue on the configuration mode interface. Uc-tx-queue configuration mode is not a group change mode; *running-config* is changed immediately after commands are executed. The `exit` command does not affect the configuration.

Trident and Tomahawk switches have eight unicast queues (UC0 – UC7) and four multicast queues (MC0 – MC3), categorized into two priority groups. All queues are exposed through the CLI and are user-configurable.

- **Priority Group 1:** UC7, UC6, MC3
- **Priority Group 0:** UC5, UC4, MC2, UC3, UC2, MC1, UC1, UC0, MC0

The `exit` command returns the switch to the configuration mode for the base Ethernet or port channel interface.

The `no uc-tx-queue` and `default uc-tx-queue` commands remove the configuration for the specified transmit queue by deleting the all corresponding `uc-tx-queue` mode commands from *running-config*.

Command Mode

Interface-Ethernet Configuration

Interface-Port-Channel Configuration

Command Syntax

```
uc-tx-queue queue_level
```

Parameters

queue_level The multicast transmit queue number. Values range from **0** to **7**.

Commands Available in uc-tx-queue Configuration Mode

- [bandwidth percent \(Trident and Tomahawk\)](#)
- [priority \(Trident and Tomahawk\)](#)
- [shape rate \(Tx-queue – Trident and Tomahawk\)](#)

Related Command

[mc-tx-queue](#): Configures multicast transmit queues on Trident and Tomahawk platform switches.

Example

This command enters mc-tx-queue configuration mode for **multicast transmit queue 4** of **interface Ethernet 5**.

```
switch(config)#interface ethernet 5  
switch(config-if-Et5)#uc-tx-queue 4  
switch(config-if-Et5-mc-txq-4)#
```

9.2 Traffic Management

This chapter describes Arista's Traffic Management, including configuration instructions and command descriptions. Topics covered by this chapter include:

- [Traffic Management Conceptual Overview](#)
- [Traffic Management Configuration Arad Platform Switches](#)

- [Traffic Management Configuration FM6000 Platform Switches](#)
- [Traffic Management Configuration Petra Platform Switches](#)
- [Traffic Management Configuration Trident Platform Switches](#)
- [Traffic Management Configuration Trident II Platform Switches](#)
- [Traffic Management Configuration Commands](#)

9.2.1 Traffic Management Conceptual Overview

Traffic is managed through policy maps that apply data shaping methods to specific data streams. A policy map is a data structure that identifies specific data streams and then defines shaping parameters that modify packets within the streams. The switch defines three types of policies:

- **Control Plane Policies:** Control plane policy maps are applied to the control plane.
- **QoS Policies:** QoS policy maps are applied to Ethernet and port channel interfaces.
- **Segment Routing Traffic Engineering Policy (SR-TE)**
- **PBR Policies:** PBR policy maps are applied to Ethernet interfaces, port channel interfaces and switch virtual interfaces (SVIs).

A policy map consists of classes. Each class contains an eponymous class map and traffic resolution commands.

- A class map is a data structure that defines a data stream by specifying characteristics of data packets that comprise that stream. Each class map is typed as either QoS, control plane, or PBR and is available only to identically typed policy maps.
- Traffic resolution commands specify data handling methods for traffic that matches a class map. Traffic resolution options vary by policy map type.

Data packets that enter an entity to which a policy map is assigned are managed with traffic resolution commands of the first class that matches the packets.

9.2.1.1 Control Plane Policies

The switch defines one control plane policy map named ***copp-system-policy***. The ***copp-system-policy*** policy map is always applied to the control plane and cannot be removed from the switch. Other control plane policy maps cannot be added. ***Copp-system-policy*** consists of preconfigured classes, each containing a static class map and traffic resolution commands. Preconfigured classes cannot be removed from ***copp-system-policy***.

Static class maps are provided by the switch and cannot be modified or deleted. The naming convention of static class maps is ***copp-system-name***, where *name* differentiates the class maps. Static class maps have pre-defined internal conditions, are not based on ACLs, and are only listed in ***running-config*** as components of ***copp-system-policy***. The sequence of static class maps in the policy map is not significant. Traffic resolution commands define minimum (bandwidth) and maximum (shape) transmission rates for data streams matching the corresponding class map.

Copp-system-policy can be modified through the following steps:

- Add classes consisting of an eponymous dynamic class map and traffic resolution commands.

Dynamic class maps are user created, can be edited or deleted, filter traffic with a single IPv4 ACL, and are listed in ***running-config***.

- Change traffic resolution commands for a preconfigured class.

These sections describe control plane traffic policy configuration procedures:

- [Configuring Control Plane Traffic Policies Arad Platform Switches](#)
- [Configuring Control Plane Traffic Policies FM6000 Platform Switches](#)
- [Configuring Control Plane Traffic Policies Petra Platform Switches](#)
- [Configuring Control Plane Traffic Policies Trident Platform Switches](#)

9.2.1.2 QoS Policies

QoS policy maps are user defined. The switch does not provide preconfigured QoS policy maps and in the default configuration, policy maps are not applied to any Ethernet or port channel interface. Policy maps and class maps are created and applied to interfaces through configuration commands.

A QoS policy map is composed of one or more classes. Each class contains an eponymous dynamic class map and traffic resolution commands. Dynamic class maps are user created, can be edited or deleted, filter traffic with a single IPv4 ACL, and are listed in *running-config*.

QoS traffic resolution commands perform one of the following:

- Set the Layer 2 CoS field
- Set the DSCP value in the ToS byte
- Specify a traffic class queue

The last class in all QoS policy maps is *class-default*, which is composed as follows:

- The *class-default* class map matches all traffic except IPv4 or IPv6 traffic and is not editable.
- By default, *class-default* class contains no traffic resolution commands. Traffic resolution commands can be added through configuration commands.

Data packets that enter an interface to which a policy map is assigned are managed with traffic resolution commands that correspond to the first class that matches the packet.

These sections describe QoS traffic policy configuration procedures:

- [Configuring QoS Traffic Policies Arad Platform Switches](#)
- [Configuring QoS Traffic Policies FM6000 Platform Switches](#)
- [Configuring QoS Traffic Policies Petra Platform Switches](#)
- [Configuring QoS Traffic Policies Trident Platform Switches](#)

9.2.1.3 Segment Routing Traffic Engineering Policy (SR-TE)

Segment Routing Traffic Engineering Policy (SR-TE) policy uses Segment Routing (SR) to enable a headend to steer traffic along any path without maintaining per flow state in every node based on the policy. Configuring SR policy for the MPLS dataplane (SR-MPLS) for Type-1 SR policy segments with BGP and locally configured policies as sources of SR policy is available on DCS-7500 and DCS-7280 family of switches.

SR Policy Overview

SR Policy Identification

The following identifies an SR policy.

- **Endpoint:** an IPv4 or IPv6 address which refers to the destination of the policy. (0/0, 0:: are allowed and called “null endpoints”)
- **Color:** an unsigned 32-bit opaque numerical quantity. The semantic of a color is up to the operator. It can refer to, for instance, an application or a type of traffic (low latency) or a geographical location, etc.

SR Policy Constituents

The SR policy consists of *candidate paths*. Each candidate path has the following.

- **SID-lists (SLs):** an ordered list of Segment Identifiers. (Each SID is a MPLS label in the MPLS instantiation of SR). An SL encodes one path from the headend to the destination. Each SL has an optional weight attached to it for the purpose of Unequal Cost Multipath (UCMP) traffic distribution. The default value for SL weight is 1.
- **Preference:** an optional, unsigned 32-bit integer used in the candidate path selection algorithm to select the “active” candidate path. The default value for preference is 100.

- **Binding SID (BSID):** an optional, SID.

 **Note:** In EOS, a BSID is mandatory for each candidate path.

SR Policy Sources

A headend learns SR policies using the following.

- **BGP**
 - Single agent routing model (Ribd)
 - Multi-agent routing model
- **Local configuration using CLI**
 - Single agent routing model (Ribd)
 - Multi-agent routing model
 - Openconfig YANG models

- **PCEP**

 **Note:** PCEP is not supported in EOS.

Identity of a Candidate Path

A candidate path *within* an SR policy is identified by a 3-tuple of {Protocol-Origin, Originator, Discriminator}. In EOS, for locally configured policies:

- the ASN in the Originator is set to 0.
- the node address in the Originator is set to 0.0.0.0.
- discriminator is set to the Preference configured.

 **Note:** EOS CLI allows configuring only one candidate path at a given preference and does not allow configuring the discriminator for a candidate path.

State of an SID List (SL)

The following describes the state of an SL.

- **Valid:** the top label of the SL is resolvable within the LFIB to outgoing next hop(s), interface(s) and a label action.
- **Invalid:** top label of the SL isn't resolvable to outgoing next hop(s), interface(s) and a label action. An SL is also marked as invalid when the SL is resolvable, but the resolved labeled stack exceeds the platform's maximum SID depth (SID), ie. exceeds the maximum number of labels the platform can push in to the outgoing packet.

 **Note:** The state is either valid or invalid.

State of a Candidate Path

The following describes the states of a candidate path.

- **Invalid:** not eligible to participate in the best/active candidate path selection algorithm because of one of the reasons below.
 - all constituent SLs are invalid
 - Binding SID is not present
 - Binding SID is present but outside SRLB range
- **Valid:** At least one SL is valid and has lost out to some other candidate path in the best / active candidate path selection algorithm.
- **Active:** The candidate path is valid and is the winner in the best / active candidate path selection algorithm. The active candidate path is installed in the switch hardware and used for forwarding traffic.

State of an SR Policy

An SR policy is “valid” when at least one of its candidate paths is valid as described above. Otherwise, the SR policy is said to be “invalid”.

Resolution of an SL

An SL is resolved if the top label (first SID) can be resolved in the system Labeled FIB (LFIB) to yield a nexthop and outgoing interface(s). The other labels in the SID-List do not play a part in resolution.

Best Candidate Path (Active Candidate Path) Selection Algorithm

EOS overrides selection based on discriminator by retaining the current active candidate path even when current active path has a lower discriminator value. This reduces the active path flap when a new path is learnt of the same significance. The following is a summary of valid candidate paths ordering for a given policy.

1. Candidate path with higher preference is chosen.
2. Locally configured candidate path is chosen over BGP learnt path
3. Lower originator is chosen. i.e.,
 - a. Lower AS number of Originator field is chosen
 - b. Lower Node address of Originator field is chosen
4. Current active candidate path is chosen

The following displays the reason for a path not getting selected as an active path for a specified policy.

```
switch#show traffic-engineering segment-routing policy endpoint  
<endpoint> color <color>
```

Binding SID

The use cases for Binding SID are the following.

- Stitch together multiple domains
- Stitch together different traffic tunnels
- Overcome label stack imposition limitation in hardware.

BSID Conflict Handling

Examples

1. **(Between Policies):** If the policy (E1, C1) becomes eligible to be active first then it would be installed in the LFIB and the policy (E2,C2) whose best path(CP1) is in conflict with the Policy(E1, C1) and will not become active.
 - Policy(E1, C1): CP1: Binding-SID 965536 (wins best path)
 - Policy(E2, C2): CP1: Binding-SID 965536 (wins best path)
 - CP2: Binding-SID 965537
2. **(with other Application):** The SR-TE policies have the lowest preference when there is a conflict with any other application in EOS using the SRLB range. The candidate paths which have the binding-SID as that of an LFIB entry by another application (for example, static adjacency segment) will be kept as “invalid”.

In both the cases, when the conflict no longer exists, the candidate paths are re-evaluated and may become active.

BGP as a Source of Policies

SR Policies from a BGP peer (a controller, route reflector) is received for installation at the headend by EOS. It does not propagate the received policies to BGP peers nor does it originate SR Policies for transmission to BGP peers.

The following are supported over IPv4 or IPv6 peers which can be single hop or multi-hop iBGP or eBGP peers.

1. **SAFI 73 for AFI 1 and AFI 2:** IPv4 and IPv6 policy endpoints, with the encoding defined in section-2.1 of [draft-ietf-idr-segment-routing-te-policy-02](#)

 **Note:** The nexthop address-family must match the AFI of the NLRI.

2. **Sub-TLVs of Tunnel Encapsulation TLV of type 15 (SR-TE Policy Type) of the Tunnel Encapsulation Path Attribute:**

- a. Preference (Sub-TLV Type 12)
- b. Binding SID (Sub-TLV Type 13) of length 2 or 6 bytes
- c. Segment List (Sub-TLV Type 128). The following Segment List sub-TLVs are supported:
 1. Type 1 Segment (Sub-TLV type 1)
 2. Weight (Sub-TLV type 9)
- d. Explicit NULL Label Policy (Sub-TLV Type 14)

 **Note:** All other sub-TLVs of the Tunnel Encapsulation TLV and Segment List sub-TLVs are ignored.

Route-Target and NO_ADVERTISE Community in SR-TE SAFI Updates

EOS implements the Acceptance and Usability checks as defined in sections 4.2.1, 4.2.2 of [draft-ietf-idr-segment-routing-te-policy-02](#). However EOS skips matching the Route-Target with the router-ID of the headend if the SR-TE NLRI is tagged with NO_ADVERTISE community.

ECMP is not supported for SR-TE SAFI Paths

EOS does not support ECMP for BGP SR-TE SAFI. Only one best candidate path is chosen by BGP path selection and published to SR-TE Policy Agent for candidate path selection.

 **Note:** ECMP of BGP next hops where each next hop resolves to an SR-TE policy is supported.

Path Selection within BGP

The BGP draft [draft-ietf-idr-segment-routing-te-policy-02](#) supports passing multiple candidate paths from a single protocol source for an SR-TE policy path selection. Hence it includes a field distinguisher in the NLRI which can be unique for each controller to make BGP pass through the policies. However when multiple sources use the same distinguisher, BGP performs a path selection for the tuple: Endpoint, Color and Distinguisher. The best path for that tuple is published to the SR-TE Policy Agent for selecting an Active path. The best bgp-best-path selection applies to SR-TE SAFI as well.

Error Handling / Edge Cases

- **Weight 0:** The BGP draft does not limit the range of SL weight to exclude weight 0. A SID-List with weight 0 is not used for forwarding so BGP module in EOS does not pass on SID-Lists with weight 0 to the SR-TE policy agent. Such SID-Lists will be visible in `show bgp sr-te` commands but not in `show traffic-engineering segment-routing policy` commands.
- **Empty SLs:** Given the TLV encoding used to propagate SR Policies in BGP, it is possible to receive SID-Lists that have no SIDs (SID-Lists are empty). The BGP module in EOS does not pass such empty SID-Lists to SR-TE policy agent. Such SID-Lists will be visible in `show bgp sr-te` commands but not in `show traffic-engineering segment-routing policy` commands.
- **Non Type 1 segments:** EOS supports only Type-1 segments. If a BGP update is received with a SID-List that has non Type-1 segments, the entire SID-List is ignored and `BGP-4-SRTE_IGNORED_SEGMENT_LIST_UNSUPPORTED_SEGMENTS` syslog is emitted. Such SID-Lists are not stored locally, and `show bgp sr-te` command does not display them.

 **Note:** The SID-Lists that are made up of all Type-1 segments are passed on to the SR-TE policy agent.

Steering Traffic into a Policy

Incoming label is BSID - "Labelled Steering"

At the headend when a packet is received with a label stack that has a BSID of an active CP of a valid SR Policy as the top label, the headend pops the label, and imposes the resolved label stack on the outgoing packet.

Example

Consider an SR Policy with an active candidate path with BSID 965536 and SL with label stack [965540, 900001, 900002]. Assume that 965540 is an IS-IS SR Adjacency SID. An incoming packet has label stack [965536, 100000] then the outgoing label stack is [900001, 900002, 100000]

Steering BGP learnt IP(v6) prefixes - “IP Steering”

Incoming label is BSID - “Labelled Steering”

At the headend, BGP IPv4 and IPv6 routes received with one or more extended color communities are recursively resolved through any active SR Policy that matches the BGP routes' nexthop and color. When an IPv4 or IPv6 packet is received that is forwarded using this policy, the SL's resolved label stack is imposed in the outgoing packet.

For BGP routes received with color community to be steered via an SR policy, the route's nexthop must already be resolvable through IGP. If there is no resolving route in IGP, the route is considered unresolvable and will not be programmed in hardware even if there is a matching SR policy for the corresponding nexthop and color.

If there is no matching SR policy for the received BGP nexthop and color, the route will be resolved through the IGP route in IP RIB. If an active SR policy that matches the BGP nexthop and color gets instantiated at a later time, the BGP route will change from resolving through IGP to the new active SR policy.



Note: The recursion through SR policy is only applicable for BGP routes that are active in RIB.

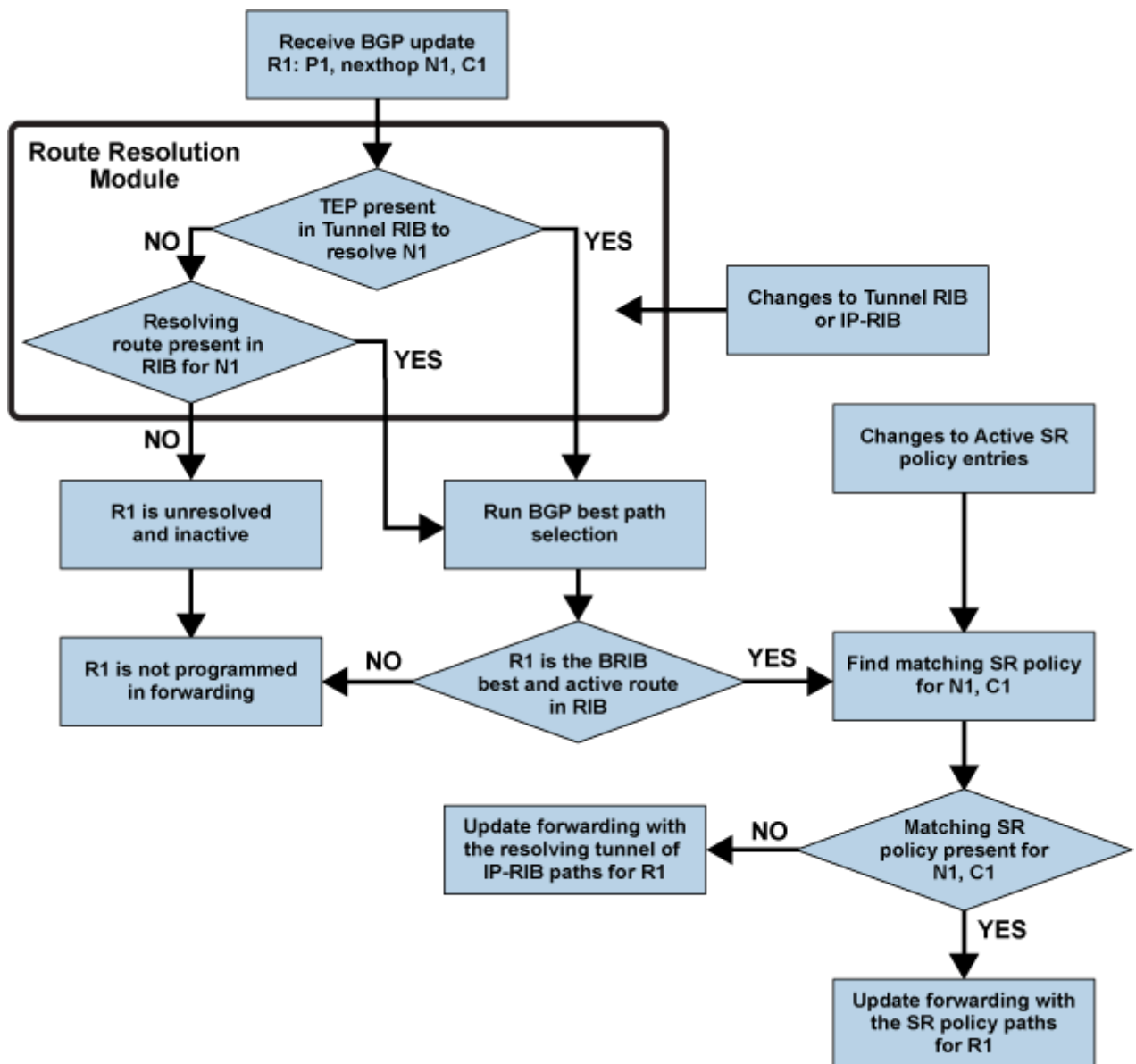

Color only IP steering using CO bits

It is possible to relax the requirement of an exact match of the BGP route's nexthop with the endpoint of the SR Policy using the "CO" (Color Only) bits in the color extended community. The "CO" bits are 2 reserved bits repurposed for color only steering as defined in [section 3 of draft-ietf-idr-segment-routing-policy-02](#). The exact match of the nexthop is done with the CO bits set to 00 or 11.

CO = 01 Steering: relaxes the nexthop to match the null endpoint of a policy. For a BGP route with nexthop N and color C, the following order is used for resolution. If there is no IGP route resolving the BGP nexthop, the route is not programmed in hardware.

1. Active SR policy with endpoint N and color C
2. Active SR policy with null endpoint (from the same AFI as the BGP route) and color C
3. Active SR policy with null endpoint from any AFI and color C
4. IGP route

CO = 10 Steering: in addition to the steps in CO = 01 steering, CO = 10 additionally relaxes the nexthop to match *any* endpoint. The following order is used for resolving a BGP route with nexthop N and color C. The behavior described is in accordance with section [8.8.1 of draft-filsfils-spring-segment-routing-policy-05](#)

1. Active SR policy with endpoint N and color C
2. Active SR policy with null endpoint (from the same AFI as the BGP route) and color C
3. Active SR policy with null endpoint from any AFI and color C
4. Active SR policy for any endpoint from the same AFI as the BGP route and color C
5. Active SR policy for any endpoint from any AFI and color C
6. IGP route

ECMP of IPv4/IPv6 Prefixes that Resolve over SR-TE Policies

When multiple BGP paths of BGP unicast prefixes resolve through active SR policies form ECMP, the resulting FIB entry for the BGP route has an ECMP of segment list paths which is a union of all the segments-list entries present in each of the resolving SR policies for the BGP paths.

Example

The following table displays four paths for prefix 192.1.0.0/31, and each of the four paths resolves via SR-TE policies.

Table 47: List of Paths Resolved via SR-TE Policies

Path	Nexthop	Color	Policy EP	Policy Color	Segment Lists	Per SL Traffic Distribution
1	1.0.0.2	CO(00):1000	1.0.0.2	1000	[2500 500], Weight: 1 [2501 500], Weight: 2	8.33% 16.66%
2	1.0.2.2	CO(00):2000	1.0.2.2	2000	[2502 500], Weight: 1 [2503 500], Weight: 1	12.5% 12.5%
3	1.0.4.2	CO(00):3000	1.0.4.2	3000	[2504 500], Weight: 1 [2505 500], Weight: 1	12.5% 12.5%
4	1.0.6.2	CO(00):4000	1.0.6.2	4000	[2506 500], Weight: 1 [2507 500], Weight: 1	12.5% 12.5%

```

B I    192.1.0.0/31 [200/0] via SR-TE Policy 1.0.4.2, color 3000
      via SR-TE tunnel index 6, weight 1
      via 1.0.4.2, Ethernet1, label 2505 500
      via SR-TE tunnel index 5, weight 1
      via 1.0.4.2, Ethernet1, label 2504 500
      via SR-TE Policy 1.0.0.2, color 1000
      via SR-TE tunnel index 2, weight 1
      via 1.0.0.2, Ethernet2, label 2501 500
      via SR-TE tunnel index 1, weight 1
      via 1.0.0.2, Ethernet2, label 2500 500
      via SR-TE Policy 1.0.2.2, color 2000
      via SR-TE tunnel index 4, weight 1

```



```

        via 1.0.2.2, Ethernet3, label 2503 500
        via SR-TE tunnel index 3, weight 1
        via 1.0.2.2, Ethernet3, label 2502 500
via SR-TE Policy 1.0.6.2, color 4000
        via SR-TE tunnel index 8, weight 1
        via 1.0.6.2, Ethernet6, label 2507 500
        via SR-TE tunnel index 7, weight 1
        via 1.0.6.2, Ethernet6, label 2506 500

```

The traffic distribution honors the weights of the SID-Lists. In the example, each of the four SR Policies will get 25% of the total traffic meant for prefix **192.1.0.0/31**. Within each policy, the distribution is based on the weights of the SID-Lists.

ECMP Group when some BGP unicast paths resolve over SR Policies and some via non SR Policy IGP paths

If some BGP paths resolve via SR Policy paths and some BGP paths resolve via non SR Policy IGP, then the ECMP group formed programmed as the active route in FIB, only considers the SR Policy paths. ECMP in the FIB is not formed between paths that resolve over SR Policy and paths that resolve via non SR Policy IGP routes. In the example above, if SR Policy with endpoint **1.0.6.2** and color **4000** becomes inactive or is removed, the FIB path for **192.1.0.0/31** resolves via 3 SR Policies as shown below.

```

B I    192.1.0.0/31 [200/0] via SR-TE Policy 1.0.4.2, color 3000
        via SR-TE tunnel index 6, weight 1
        via 1.0.4.2, Ethernet1, label 2505 500
        via SR-TE tunnel index 5, weight 1
        via 1.0.4.2, Ethernet1, label 2504 500
via SR-TE Policy 1.0.0.2, color 1000
        via SR-TE tunnel index 2, weight 1
        via 1.0.0.2, Ethernet2, label 2501 500
        via SR-TE tunnel index 1, weight 1
        via 1.0.0.2, Ethernet2, label 2500 500
via SR-TE Policy 1.0.2.2, color 2000
        via SR-TE tunnel index 4, weight 1
        via 1.0.2.2, Ethernet3, label 2503 500
        via SR-TE tunnel index 3, weight 1
        via 1.0.2.2, Ethernet3, label 2502 500

```



Note: `show ip bgp` still shows a 4-way ECMP. The FIB paths switch to resolving via the (non SR Policy) IGP paths when there are no BGP paths in the ECMP group that resolve via an SR Policy.

UCMP of IPv4/IPv6 prefixes using LinkBandwidth (LBW) Extended Community that resolve over SR-TE policies not supported

When multiple BGP paths of BGP unicast prefixes resolve through active SR policies form ECMP, and the unicast paths also contain the LBW extended community, EOS does not form UCMP amongst the unicast paths. Only ECMP is formed at the unicast prefix level. The LBW is ignored the behavior is identical to the behavior explained in the previous section.

Resolution of BGP unicast prefixes that resolve over other BGP unicast prefixes resolved via SR Policies

A BGP unicast prefix P1, that is recursively resolved via another BGP prefix P2, such that P2 resolves via an SR Policy, then in the FIB, P1 is programmed with the resolved nexthop pointing to the non SR Policy resolution of P2. P1 does not use P2's SR Policy for forwarding.

Explicit Null Label Imposition

When the address family of the BGP unicast prefix is not the same as the address family of the endpoint of the SR Policy that the unicast prefixes resolves via, an explicit null label is automatically imposed in the outgoing label stack.

Example

If an IPv4 unicast prefix P1 resolves over a policy whose endpoint EP1 is an IPv6 address (this can happen due to color only CO=01/10 steering with P1 having an IPv4 nexthop) and the SR Policy had a SID-List whose resolved label stack is [1001, 1002, 1003], the outgoing packet is imposed with [1001, 1002, 1003, 2] where 0 is the IPv4 explicit null label.

If an IPv6 prefix P2, resolves over a policy whose endpoint EP2 is an IPv4 address (this can happen with color only CO=01/10 steering with P2 having a IPv6 nexthop) and the SR Policy had a SID-List whose resolved label stack is [1001, 1002, 1003], the outgoing packet is imposed with [1001, 1002, 1003, 2] where 2 is the IPv6 explicit null label.

The following table lists the configurations which result in having explicit-null label in the resolved label stack.

Table 48: Configurations resulting in Explicit-Null Label in Resolved Label Stack

ENLP configuration for the resolving SR Policy	IPv4 Prefixes	IPv6 Prefixes
None	-	-
IPv4	IPv4 explicit null appended to the end of label stack	-
IPv6	-	IPv6 explicit null appended to the end of label stack
Both	IPv4 explicit null appended to the end of label stack	IPv6 explicit null appended to the end of label stack
No/Default config (incase of BGP learnt policies ENLP Sub-TLV is not received)	Resolving SR Policy has IPv4 Endpoint address: No explicit-null	Resolving SR Policy has IPv4 Endpoint address: IPv6 explicit null appended to the end of label stack
	Resolving SR Policy has IPv6 Endpoint address: IPv4 explicit null appended to the end of label stack	Resolving SR Policy has IPv6 Endpoint address: No explicit-null

Traffic Accounting

All egress tunnel counters (MPLS/GRE/MPLSoGRE using SR-TE/Nexthop-group/BGP-LU tunnel types) share the same hardware resource.

- **7280E/7500E systems:** Up to 16k tunnels
- **7280R/7500R systems:** Up to 8k tunnels

Tunnel counters are allocated on a first-come, first-served basis. Configurations using GRE/MPLSoGRE, GRE, and MPLS further limit a maximum of 4k countable egress MPLS tunnels on 7280R/7500R.

FEC optimizations

The hardware FEC usage could be reduced as the underlying FEC is shared among different routes.

- Programming of the active candidate path of an SR-TE policy in hardware is shared between the BSID route and IP steering route.

- If all of the following conditions are met, ISIS-SR MPLS routes and tunnel entries directly point to the next hop FEC generated by the routing agent (IGP FEC).
 - All the next hops of the MPLS route either point to pop or forward (i.e. swapping to the same label) label action.
 - The switch is either a 7280 or a 7500 platform.
- The corresponding SR-TE policy BSID routes (and corresponding Segment List tunnels) that resolve over ISIS-SR MPLS routes, will directly point to the IGP FEC.

Configuring SR-TE

The following commands start the SrTePolicy agent and enter the switch into the Traffic Engineering configuration sub-mode.

```
switch(config)#router traffic-engineering
switch(config-te)#segment-routing
```



Note: The agent must be running even if the only source of policies is BGP.

Static Policy Configuration

The following commands set the policy using endpoint and color value, and define the BSID for the policy.

```
switch(config-te-sr)# policy endpoint v4Address|v6Address color color-
value
switch(config-te-sr-policy)# binding-sid mpls-label
switch(config-te-sr-policy)# path-group preference value
```

The following commands enter the policy path configuration sub mode, and adds a segment list to the candidate path.

```
switch(config-te-sr-policy)# path-group preference value
switch(config-te-sr-policy-path)# segment-list label-stack label1 label2
... weight value
```



Note: The default weight value is 1. Adding weight is optional. Repeat the configuration statement for multiple segment lists per candidate path.

The following commands configures a null label policy.

```
switch(config-te-sr-policy-path)# explicit-null [none|ipv4|ipv6|both]
```



Note: The null label policy configuration is optional.

BGP configuration for SR-TE SAFI

The following commands configures a BGP router to activate a neighbor to negotiate and accept SR-TE address-family with this peer.

```
switch(config)#router bgp <as>
switch(config-router-bgp)#address-family ipv4|ipv6 sr-te
switch(config-router-bgp-af-srte)#neighbor neighbor activate
```

The following command configures an inbound route-map to filter or modify attributes on incoming SR-TE prefixes from the peer.

```
switch(config-router-bgp-af-srte)# neighbor neighbor route-
map routeMapName in
```

Configuring Egress SR-TE Traffic Accounting

The following command enables egress traffic accounting for SR policies (also known as MPLS tunnels).

```
switch(config)#hardware counter feature mpls tunnel
```

The following command displays current status of the MPLS counters.

```
switch#show hardware counter feature
Feature                Direction                Counter Resource (Engine)
-----
ACL-IPv4              out                      Jericho: 2, 3
ACL                   in                       Jericho: 4, 5, 6, 7
MPLS tunnel           out                      Jericho: 8, 9
```

The following command disables egress traffic accounting for SR policies.

```
switch(config)#no hardware counter feature mpls tunnel
```

The following command displays a summary information of SR-TE SAFI.

```
switch#show bgp sr-te summary
BGP summary information for VRF default
Router identifier 100.1.1.2, local AS number 100
Neighbor Status Codes: m - Under maintenance
Neighbor      V AS      MsgRcvd  MsgSent  InQ  OutQ  Up/Down
State PfxRcd PfxAcc
100.1.1.1    4 100      407      413     0    0 00:18:57
Estab 1      1
1000::1     4 100      407      413     0    0 00:18:57
Estab 1      1
```

The following command displays a summary information of candidate paths received from neighbors which have negotiated AFI=1 for SR-TE SAFI.

```
switch#show bgp sr-te ipv4 summary
BGP summary information for VRF default
Router identifier 100.1.1.2, local AS number 100
Neighbor Status Codes: m - Under maintenance
Neighbor      V AS      MsgRcvd  MsgSent  InQ  OutQ  Up/Down
State PfxRcd PfxAcc
100.1.1.1    4 100      407      413     0    0 00:18:57
Estab 0      0
```

The following command displays a summary information of candidate paths received from neighbors which have negotiated AFI=2 for SR-TE SAFI.

```
switch#show bgp sr-te ipv6 summary
BGP summary information for VRF default
Router identifier 100.1.1.2, local AS number 100
Neighbor Status Codes: m - Under maintenance
Neighbor      V AS      MsgRcvd  MsgSent  InQ  OutQ  Up/Down
State PfxRcd PfxAcc
1000::1     4 100      407      413     0    0 00:18:57
Estab 0      0
```

The following command displays all the SR-TE candidate paths.

```
switch#show bgp sr-te
BGP routing table information for VRF default
```

```
Router identifier 100.1.1.1, local AS number 100
Policy status codes: * - valid, > - active, E - ECMP head, e - ECMP
                    c - Contributing to ECMP
Origin codes: i - IGP, e - EGP, ? - incomplete
AS Path Attributes: Or-ID - Originator ID, C-LST - Cluster List, LL
Nexthop - Link Local Nexthop
```

	Endpoint	Color	Distinguisher	Next Hop	Metric
	LocPref	Weight	Path		
*>	133.1.1.1	0	1	130.1.1.3	
	0	100	0	?	
*>	133.1.1.1	0	2	130.1.1.3	
	0	100	0	?	
*>	1330::1	0	1	1300::3	
	0	100	0	?	
*>	1330::1	0	2	1300::3	
	0	100	0	?	

The following command displays all the SR-TE candidate paths with IPv4 endpoints.

```
switch#show bgp sr-te ipv4
BGP routing table information for VRF default
Router identifier 100.1.1.1, local AS number 100
Policy status codes: * - valid, > - active, E - ECMP head, e - ECMP
                    c - Contributing to ECMP
Origin codes: i - IGP, e - EGP, ? - incomplete
AS Path Attributes: Or-ID - Originator ID, C-LST - Cluster List, LL
Nexthop - Link Local Nexthop
```

	Endpoint	Color	Distinguisher	Next Hop	Metric
	LocPref	Weight	Path		
*>	133.1.1.1	0	1	130.1.1.3	
	0	100	0	?	
*>	133.1.1.1	0	2	130.1.1.3	
	0	100	0	?	

The following command displays all the SR-TE candidate paths with IPv6 endpoints.

```
switch#show bgp sr-te ipv6
BGP routing table information for VRF default
Router identifier 100.1.1.1, local AS number 100
Policy status codes: * - valid, > - active, E - ECMP head, e - ECMP
                    c - Contributing to ECMP
Origin codes: i - IGP, e - EGP, ? - incomplete
AS Path Attributes: Or-ID - Originator ID, C-LST - Cluster List, LL
Nexthop - Link Local Nexthop
```

	Endpoint	Color	Distinguisher	Next Hop	Metric
	LocPref	Weight	Path		
*>	1330::1	0	1	1300::3	
	0	100	0	?	
*>	1330::1	0	2	1300::3	
	0	100	0	?	

The following command displays information about a specific candidate path.

```
switch#show bgp sr-te endpoint 133.1.1.1 color 0 distinguisher 1
BGP routing table information for VRF default
Router identifier 100.1.1.1, local AS number 100
BGP routing table entry for Endpoint: 133.1.1.1 Color: 0 Distinguisher: 1
  Paths: 1 available
    Local
```

```

130.1.1.3 from 100.1.1.2 (100.1.1.2)
  Origin INCOMPLETE, metric 0, localpref 100, IGP metric 0, weight 0,
  received 00:01:29 ago, valid, internal, best
  Community: no-advertise
  Rx SAFI: SR TE Policy

```

The following command displays information about a specific candidate path including the contents of the Tunnel encapsulation path attribute TLV of type SR policy.

```

switch#show bgp sr-te endpoint 133.1.1.1 color 0 distinguisher 1 detail
BGP routing table information for VRF default
Router identifier 100.1.1.1, local AS number 100
BGP routing table entry for Endpoint: 133.1.1.1 Color: 0 Distinguisher: 1
  Paths: 1 available
  Local
    130.1.1.3 from 100.1.1.2 (100.1.1.2)
      Origin INCOMPLETE, metric 0, localpref 100, IGP metric 0, weight 0,
      received 00:01:29 ago, valid, internal, best
      Community: no-advertise
      Rx SAFI: SR TE Policy
      Tunnel encapsulation attribute: SR Policy
        Preference: 200
        Binding SID: 965536
        Explicit null label policy: IPv4
        Segment-List: Label Stack: [ 16004 16003 ], Weight: 10
        Segment-List: Label Stack: [ 2000 3000 ]

```

The following command displays information about SR candidate paths received from the specified neighbor. The “policies” keyword displays only the candidate paths that are accepted. “received-policies” additionally also displays the rejected candidate paths.

```

switch#show bgp neighbors 100.1.1.2 ipv4 sr-te policies
BGP routing table information for VRF default
Router identifier 100.1.1.1, local AS number 100
Policy status codes: * - valid, > - active
Origin codes: i - IGP, e - EGP, ? - incomplete
AS Path Attributes: Or-ID - Originator ID, C-LST - Cluster List, LL
  Nexthop - Link Local Nexthop

```

	Endpoint	Color	Distinguisher	Next Hop	Metric
	LocPref	Weight	Path		
*>	133.1.1.1	0	1	133.1.1.3	
	0	100	0	?	
*>	133.1.1.1	0	2	133.1.1.3	
	0	100	0	?	

The following command displays information about SR candidate paths received from the specified neighbor along with the contents of the Tunnel Encapsulation path attribute’s TLV of type SR Policy. The “policies” keyword displays only the candidate paths that are accepted. “received-policies” additionally also displays the rejected candidate paths..

```

switch#show bgp neighbors 100.1.1.2 ipv4 sr-te policies detail
BGP routing table information for VRF default
Router identifier 100.1.1.1, local AS number 100
BGP routing table entry for Endpoint: 133.1.1.1 Color: 0 Distinguisher: 2
  Paths: 1 available
  Local
    130.1.1.3 from 100.1.1.2 (100.1.1.2)
      Origin INCOMPLETE, metric 0, localpref 100, IGP metric 0, weight 0,
      received 00:01:29 ago, invalid, internal
      Rx SAFI: SR TE Policy

```

```
Tunnel encapsulation attribute: SR Policy
Preference: 200
Binding SID: 965536
Explicit null label policy: IPv4
Segment-List: Label Stack: [ 16004 16003 ], Weight: 10
Segment-List: Label Stack: [ 2000 3000 ]
```

9.2.1.4 PBR Policies

Policy-Based Routing (PBR) allows the operator to specify the next hop for selected incoming packets on an L3 interface, overriding the routing table. Incoming packets are filtered through a policy map referencing one or more ACLs, and matching packets are routed to the next hop specified.

A PBR policy map is composed of one or more classes and can include next-hop information for each class. It can also include single-line raw match statements, which have the appearance and function of a single line from an ACL. Each class contains an eponymous class map. Class maps are user-created, can be edited or deleted, filter traffic using IPv4 ACLs, and are listed in *running-config*.

These sections describe PBR policy configuration procedures:

- [Configuring PBR Policies Arad Platform Switches](#)
- [Configuring PBR Policies FM6000 Platform Switches](#)
- [Configuring PBR Policies Petra Platform Switches](#)
- [Configuring PBR Policies Trident Platform Switches](#)

9.2.2 Traffic Management Configuration Arad Platform Switches

Traffic policies are implemented by policy maps, which are applied to the control plane, or to L3 interfaces for Policy-Based Routing (PBR). Policy maps contain classes, which are composed of class maps and traffic resolution commands.

[Traffic Management Conceptual Overview](#) describes traffic policies.

9.2.2.1 Configuring Control Plane Traffic Policies Arad Platform Switches

Default control plane traffic policies are implemented automatically without user intervention. These policies are modified by associating traffic resolution commands with static classes that comprise the control plane policy map.

Static Class Maps

Control plane traffic policies utilize static class maps, which are provided by the switch, are not editable, and cannot be deleted.

Editing the Policy Map

The only control plane policy map is **copp-system-policy**, which cannot be deleted. In its default form, **copp-system-policy** consists of the classes listed in [copp-system-policy default classes: Arad Platform Switches](#). Although the underlying class map of each class cannot be edited, the traffic resolution commands can be adjusted. The default classes cannot be removed from the policy map and their sequence within the policy map is not editable.

Table 49: copp-system-policy default classes: Arad Platform Switches

Class Name	shape (kbps)	bandwidth (kbps)
copp-system-bgp	2500	250

Class Name	shape (kbps)	bandwidth (kbps)
copp-system-bpdu	2500	1250
copp-system-default	2500	250
copp-system-ipbroadcast	2000	200
copp-system-ipmc	2500	250
copp-system-ipmcmiss	2500	250
copp-system-ipunicast	250000	250
copp-system-l2broadcast	2500	250
copp-system-l2unicast	250000	250
copp-system-l3destmiss	2500	250
copp-system-l3lpmoverflow	1000	200
copp-system-l3slowpath	2500	250
copp-system-l3ttl1	2500	250
copp-system-lacp	2500	1250
copp-system-linklocal	100000	250
copp-system-ldp	10000	1000
copp-system-mlag	2500	250
copp-system-multicastsnoop	2500	250
copp-system-Ospfisis	2500	250
copp-system-sflow	1000000	250
copp-system-rsvp	250000	250
copp-system-ldp	250000	250
copp-system-mpls-arp-suppress	2500	250
copp-system-arp-inspect	2500	250
copp-system-dot1x-mba	2500	250
copp-system-cfm-snoop	2500	250

Class Name	shape (kbps)	bandwidth (kbps)
copp-system-cfm	1367	98
copp-system-ptp-snoop	2500	250
copp-system-mirroring	1000000	250
copp-system-cvx-heartbeat	2500	250
copp-system-cvx	40000	1250
copp-system-mpls-label-miss	2500	250
copp-system-mpls-ttl01	2500	250
copp-system-mtu	2500	250
copp-system-mvrp	2500	250
copp-system-ntp	2500	250
copp-system-vxlan-encapsulation	200000	250
copp-system-vxlan-vtep-learn	2500	250
copp-system-aclog	2500	250
copp-system-bfd	2500	250
copp-system-igmp	2500	250

Policy maps are modified in policy-map configuration mode. The `policy-map type copp` command enters policy-map configuration mode.

Example

This command enters policy-map configuration mode for editing copp-system-policy.

```
switch(config)#policy-map type copp copp-system-policy
switch(config-pmap-copp-system-policy)#
```

The `class (policy-map (control-plane) Arad)` command enters policy-map-class configuration mode, where traffic resolution commands are modified for the configuration mode class.

Example

This command enters policy-map-class configuration mode for the copp-system-lacp static class.

```
switch(config-pmap-copp-system-policy)#class copp-system-lacp  
switch(config-pmap-c-copp-system-policy-copp-system-lacp)#
```

Two traffic resolution commands determine bandwidth parameters for class traffic:

- **bandwidth (policy-map-class (control-plane) Arad)** specifies the minimum bandwidth.
- **shape (policy-map-class (control-plane) Arad)** specifies the maximum bandwidth.

Example

These commands configure a bandwidth range of 2000 to 4000 kilobits per seconds (kbps) for traffic filtered by the copp-system-lacp class map:

```
switch(config-pmap-c-copp-system-policy-copp-system-  
lacp)#bandwidth kbps 2000  
switch(config-pmap-c-copp-system-policy-copp-system-lacp)#shape  
kbps 4000  
switch(config-pmap-c-copp-system-policy-copp-system-lacp)#
```

Policy-map and policy-map-class configuration modes are group-change modes. Changes are saved with the **exit** command or discarded with the **abort** command. The **show active** command displays the saved version of policy map. The **show pending** command displays the modified policy map.

Example

These commands exit policy-map-class configuration mode, display the pending policy-map, then exit policy-map configuration mode, which saves the altered policy map to **running-config**.

```
switch(config-pmap-c-copp-system-policy-copp-system-lacp)#exit  
switch(config-pmap-copp-system-policy)#show pending  
policy-map type copp copp-system-policy  
  class copp-system-bpdu  
  
  class copp-system-lldp  
  
  class copp-system-lacp  
    shape kbps 4000  
    bandwidth kbps 2000  
  
  class copp-system-l3ttl1  
  
  class copp-system-l3slowpath  
  
switch(config-pmap-copp-system-policy)#exit  
switch(config)#
```

Applying Policy Maps to the Control Plane

The **copp-system-policy** policy map is always applied to the control plane. No commands are available to add or remove this assignment.

Displaying Policy Maps

The **show policy-map interface type qos** command displays the configured values of the policy maps classes and the number of packets filtered and dropped as a result of the class maps.

Example

These commands exit policy-map-class configuration mode, display the pending policy-map, then exit policy-map configuration mode, which saves the altered policy map to **running-config**.

```
switch(config)#show policy-map copp copp-system-policy
Service-policy input: copp-system-policy
  Hardware programming status: InProgress

  Class-map: copp-system-mlag (match-any)
    shape : 10000001 kbps
    bandwidth : 10000001 kbps
    Out Packets : 0
    Drop Packets : 0

  Class-map: copp-system-bpdu (match-any)
    shape : 2604 kbps
    bandwidth : 1302 kbps
    Out Packets : 0
    Drop Packets : 0

  Class-map: copp-system-lacp (match-any)
    shape : 4230 kbps
    bandwidth : 2115 kbps
    Out Packets : 0
    Drop Packets : 0

switch(config)#

switch(config-pmap-c-copp-system-policy-copp-system-lacp)#exit
```

9.2.2.2 Configuring QoS Traffic Policies Arad Platform Switches.

QoS traffic policies are implemented by creating class maps and policy maps, then applying the policy maps to Ethernet and port channel interfaces.

Creating Class Maps

QoS traffic policies utilize dynamic class maps that are created and modified in class-map configuration mode. The **class-map type qos** command enters class-map configuration mode.

Example

- This command enters class-map configuration mode to create QoS class map named **Q-CMap_1**.

```
switch(config)#class-map type qos match-any Q-CMap_1
switch(config-cmap-Q-CMap_1)#
```

A class map contains one IPv4 access control list (ACL). The **match ip access-group** command assigns an ACL to the class map. Subsequent **match** commands replace the existing **match** command. Class maps filter traffic only on ACL permit rules. Deny ACL rules are disregarded.

Example

- This command adds the IPv4 ACL named ACL_1 to the class map.

```
switch(config-cmap-Q-CMap_1)#match ip access-group ACL_1
switch(config-cmap-Q-CMap_1)#
```

Class-map configuration mode is a group-change mode. Changes made in a group-change mode are saved by exiting the mode. The **show active** command displays the saved version of class map. The **show pending** command displays the unsaved class map.

Example

- The **show active** command indicates that the configuration mode class map is not stored in **running-config**. The **show pending** command displays the class map to be stored upon exiting class-map configuration mode.

```
switch(config-cmap-Q-CMap_1)#show active
switch(config-cmap-Q-CMap_1)#show pending
class-map type qos match-any Q-CMap_1
  match ip access-group ACL_1
switch(config-cmap-Q-CMap_1)#
```

The **exit** command returns the switch to global configuration mode and saves pending class map changes. The **abort** command returns the switch to global configuration mode and discards pending changes.

Example

- This command exits class-map configuration mode and stores pending changes to **running-config**.

```
switch(config-cmap-CP-CMAP_1)#exit
switch(config)#show class-map type control-plane CP-CMAP_1
  Class-map: CP-CMAP_1 (match-any)
  Match: ip access-group name ACLv4_1
switch(config)#
```

Creating Policy Maps

Policy maps are created and modified in policy-map configuration mode. The `policy-map type quality-of-service` command enters policy-map configuration mode.

Example

- This command places the switch in policy-map configuration mode and creates a QoS policy map named **Q-PMAP_1**.

```
switch(config)#policy-map type quality-of-service Q-PMAP_1
switch(config-pmap-Q-PMAP_1)#
```

Policy map are edited by adding or removing classes. A class automatically contains its eponymous class map; traffic resolution commands are added or edited in policy-map-class configuration mode. The `below` command adds a class to the configuration mode policy map and places the switch in policy-map-class configuration mode, where traffic resolution commands are added to the class.

Example

- This command adds the **Q-CMap_1** class to the **Q-PMAP_1** policy map and places the switch in policy-map-class configuration mode.

```
switch(config-pmap-Q-PMAP_1)#class Q-CMap_1
switch(config-pmap-c-Q-PMAP_1-Q-CMap_1)#
```

The `set cos` commands configure traffic resolution methods for data that passes the class map:

- set cos** sets the layer 2 CoS field.
- set dscp** sets the DSCP value in the ToS byte.
- set traffic class** specifies a traffic class queue.

Example

- These commands configure the policy map to set the **CoS field 7** on packets filtered by the class map, then assigns those packets to **traffic class 4**.

```
switch(config-pmap-c-Q-PMAP_1-Q-CMap_1)#set cos 7
switch(config-pmap-c-Q-PMAP_1-Q-CMap_1)#set traffic-class 4
switch(config-pmap-c-Q-PMAP_1-Q-CMap_1)#
```

Policy-map and policy-map-class configuration modes are group-change modes. Changes are saved with the `exit` command or discarded with the `abort` command. The `show active` and `show pending` commands display the saved and modified policy map versions, respectively.

Example

- These commands exit policy-map-class configuration mode, display the pending policy-map, then exit policy-map configuration mode to save the altered policy map to **running-config**.

```
switch(config-pmap-c-Q-PMAP_1-Q-CMap_1)#exit
switch(config-pmap-Q-PMAP_1)#show pending
policy-map type quality-of-service Q-PMAP_1
  class Q-CMap_1
    set cos 7
    set traffic-class 4

  class class-default

switch(config-pmap-Q-PMAP_1)#exit
switch(config)#
```

The last class in all QoS policy maps is **class-default**. The **class-default** class map matches all traffic except IPv4 or IPv6 traffic and provides no traffic resolution commands. The **class-default** class map is not editable; traffic resolution commands can be added to the **class-default** class.

To modify traffic resolution commands for the **class-default** class, enter policy-map-class configuration mode for the class, then enter the desired **set** commands.

Example

- These commands enter policy-map-class configuration mode for **class-default**, configures the stream to enter **traffic class 2**, and saves the altered policy map to **running-config**.

```
switch(config)#policy-map type quality-of-service Q-PMap_1
switch(config-pmap-Q-PMap_1)#class class-default
switch(config-pmap-c-Q-PMap_1-class-default)#set traffic-class
2
switch(config-pmap-c-Q-PMap_1-class-default)#exit
switch(config-pmap-Q-PMap_1)#exit
switch(config)#show policy-map type qos Q-PMap_1
Service-policy Q-PMap_1

  Class-map: Q-CMap_1 (match-any)
    Match: ipv6 access-group name ACLv6_1
      set cos 7
      set traffic-class 4

  Class-map: class-default (match-any)
    set traffic-class 2

switch(config)#
```

Applying Policy Maps to an Interface

The **service-policy type qos (Interface mode)** command applies a specified policy map to the configuration mode interface.

- These commands apply **PMAP-1** policy map to **interface Ethernet 8**.

```
switch(config)#interface ethernet 8
```

```
switch(config-if-Et8)#show active
switch(config-if-Et8)#service-policy input PMAP-1
switch(config-if-Et8)#show active
interface Ethernet8
    service-policy type qos input PMAP-1
switch(config-if-Et8)#
```

9.2.2.3 Configuring PBR Policies Arad Platform Switches

Policy-Based Routing (PBR) is implemented by creating class maps and policy maps, then applying the policy maps to Ethernet interfaces, port channel interfaces or switch virtual interfaces (SVIs).

Creating PBR Class Maps

PBR policies utilize class maps that are created and modified in class-map configuration mode. The `class-map type pbr` command enters class-map configuration mode.

Example

This command enters class-map configuration mode to create a PBR class map named CMAP1.

```
switch(config)#class-map type pbr match-any CMAP1
switch(config-cmap-PBR-CMAP1)#
```

A class map contains one or more access control lists (ACLs). The `match (policy-map (pbr))` command assigns an ACL to the class map. Subsequent `match` commands add additional ACLs to the class map. Class maps filter traffic only on ACL permit rules. Deny ACL rules are disregarded; if a class map includes ACLs with deny rules, the configuration reverts to its previous state.

Example

- This command adds the ACL named ACL1 to the class map.

```
switch(config-cmap-PBR-CMAP1)#match ip access-group ACL1
switch(config-cmap-PBR-CMAP1)#
```

Class-map configuration mode is a group-change mode. Changes made in a group-change mode are saved by exiting the mode. The `show active` command displays the saved version of class map.

- The `show active` command indicates that the configuration mode class map is not stored in *running-config*.

```
switch(config-cmap-PBR-CMAP1)#show active
switch(config-cmap-PBR-CMAP1)#
```

The `exit` command returns the switch to global configuration mode and saves pending class map changes. The `abort` command returns the switch to global configuration mode and discards pending changes.

Example

This command exits class-map configuration mode and stores pending changes to *running-config*.

```
switch(config-cmap-PBR-CMAP1)#exit
switch(config)#show class-map type pbr CMAP1
class-map type pbr match-any CMAP1
    10 match ip access-group ACL1
switch(config)#
```

Creating PBR Policy Maps

Policy maps are created and modified in policy-map configuration mode. The [policy-map type pbr](#) command enters policy-map configuration mode.

Example

This command enters policy-map configuration mode for creating a PBR policy map named **PMAP1**.

```
switch(config)#policy-map type pbr PMAP1
switch(config-pmap-PMAP1)#
```

Policy map are edited by adding or removing classes. A class automatically contains its eponymous class map; next-hop commands are added or edited in policy-map-class configuration mode. The [class \(policy-map \(pbr\)\)](#) command adds a class to the configuration mode policy map and places the switch in policy-map-class configuration mode, where next-hop commands are added to the class.

Example

- This command adds the CMAP1 class to the policy map and places the switch in policy-map-class configuration mode.

```
switch(config-pmap-PMAP1)#class CMAP1
switch(config-pmap-c-PMAP1-CMAP1)#
```

The [set nexthop \(policy-map-class pbr\)](#) command configures the next hop for data that passes the class map.

- This command configures the policy map to set the next hop to **10.12.0.5** on packets filtered by the class map.

```
switch(config-pmap-c-PMAP1-CMAP1)#set nexthop 10.12.0.5
switch(config-pmap-c-PMAP1-CMAP1)#
```

The [set nexthop-group \(policy-map-class\(pbr\) Arad\)](#) command configures a nexthop group as the next hop for data that passes the class map.

- These commands configure the policy map **PMAP1** to set the next hop to a nexthop group named **GROUP1** for traffic defined by class map **CMAP1**.

```
switch(config)#policy-map type pbr PMAP1
switch(config-pmap-PMAP1)#class CMAP1
switch(config-pmap-c-PMAP1-CMAP1)#set nexthop-group GROUP1
```



```
switch(config-pmap-c-PMAP1-CMAP1) #
```

Policy-map and policy-map-class configuration modes are group-change modes. Changes are saved with the **exit** command or discarded with the **abort** command. The **show active** command displays the currently saved map version.

Example

These commands exit policy-map-class configuration mode, then exit policy-map configuration mode to save the altered policy map to **running-config**.

```
switch(config-pmap-c-PMAP1-CMAP1) #exit
switch(config-pmap-PMAP1) #exit
switch(config) #
```

Applying a PBR Policy Map to an Interface

The [service-policy type pbr \(Interface mode\)](#) command applies the specified PBR policy map to the configuration mode interface. Only one PBR service policy is supported per interface.

- These commands apply the PMAP1 PBR policy map to **interface Ethernet 8**.

```
switch(config) #interface ethernet 8
switch(config-if-Et8) #service-policy type pbr input PMAP1
switch(config-if-Et8) #
```

Hardware Decapsulation

When hardware decapsulation takes place, PBR policy maps on Arad platform switches match on outer packet headers (i.e., they match based on the attributes of the packet before it is decapsulated).

9.2.3 Traffic Management Configuration FM6000 Platform Switches

Traffic policies are implemented by policy maps, which are applied to the control plane or an interface. Policy maps contain classes, which are composed of class maps and traffic resolution commands. [Traffic Management Conceptual Overview](#) describes traffic policies.

FM6000 platform switches support the following traffic policies:

- Control plane policies manage control plane traffic.
- QoS traffic policies manage traffic on Ethernet and port channel interfaces.

These sections describe the construction and application of policy maps on FM6000 platform switches:

- [Configuring Control Plane Traffic Policies FM6000 Platform Switches](#)
- [Configuring QoS Traffic Policies FM6000 Platform Switches](#)
- [Configuring PBR Policies FM6000 Platform Switches](#)

9.2.3.1 Configuring Control Plane Traffic Policies FM6000 Platform Switches

Default control plane traffic policies are implemented automatically without user intervention. These policies are modified by associating traffic resolution commands with static classes that comprise the control plane policy map.

Static Class Maps

Control plane traffic policies utilize static class maps, which are provided by the switch, are not editable, and cannot be deleted.

Editing the Policy Map

The only control plane policy map is **copp-system-policy**, which cannot be deleted. In its default form, **copp-system-policy** consists of the classes listed in [copp-system-policy default classes: FM6000 Platform Switches](#). Although the underlying class map of each class cannot be edited, the traffic resolution commands can be adjusted. The default classes cannot be removed from the policy map and their sequence within the policy map is not editable.

Table 50: copp-system-policy default classes: FM6000 Platform Switches

Class Name	shape (pps)	bandwidth (pps)
copp-system-arp	10000	1000
copp-system-default	8000	1000
copp-system-ipmcrsvd	10000	1000
copp-system-ipmcmis	10000	1000
copp-system-igmp	10000	1000
copp-system-l2rsvd	10000	10000
copp-system-l3slowpath	10000	1000
copp-system-pim-ptp	10000	1000
copp-system-ospf-isis	10000	1000
copp-system-selfip	5000	5000
copp-system-selfip-tc6to7	5000	5000
copp-system-sflow	25000	1000

Policy maps are modified in policy-map configuration mode. The `policy-map type copp` command enters policy-map configuration mode.

Example

- This command enters policy-map configuration mode for editing **copp-system-policy**.

```
switch(config)#policy-map type copp copp-system-policy
switch(config-pmap-copp-system-policy)#
```

The `class (policy-map (control-plane) FM6000)` command enters policy-map-class configuration mode, where traffic resolution commands are modified for the configuration mode class.

Example

- This command enters policy-map-class configuration mode for the `copp-system-arp` static class.

```
switch(config-pmap-copp-system-policy)#class copp-system-arp
switch(config-pmap-c-copp-system-policy-copp-system-arp)#
```

Two traffic resolution commands determine bandwidth parameters for class traffic:

- `bandwidth (policy-map-class (control-plane) FM6000)` specifies the minimum bandwidth.
- `shape (policy-map-class (control-plane) FM6000)` specifies the maximum bandwidth.

Example

- These commands configure a bandwidth range of 2000 to 4000 packets per seconds (pps) for traffic filtered by the `copp-system-arp` class map:

```
switch(config-pmap-c-copp-system-policy-copp-system-arp)#bandwidth pps 2000
switch(config-pmap-c-copp-system-policy-copp-system-arp)#shape pps 4000
switch(config-pmap-c-copp-system-policy-copp-system-arp)#
```

Policy-map and policy-map-class configuration modes are group-change modes. Changes are saved with the `exit` command or discarded with the `abort` command. The `show active` command displays the saved version of policy map. The `show pending` command displays the modified policy map.

Example

- These commands exit policy-map-class configuration mode, display the pending policy-map, then exit policy-map configuration mode, which saves the altered policy map to *running-config*.

```
switch(config-pmap-c-copp-system-policy-CP-CMAP_1)#exit
switch(config-pmap-copp-system-policy)#show pending
policy-map type copp copp-system-policy
  class CP-CMAP_1
    shape pps 4000
    bandwidth pps 2000

  class copp-system-bpdu

  class copp-system-lldp

  class copp-system-lacp

  class copp-system-arp
```

```
class copp-system-arpresolver
class copp-system-default

switch(config-pmap-copp-system-policy) #exit
switch(config) #
```

Applying Policy Maps to the Control Plane

The **copp-system-policy** policy map is always applied to the control plane. No commands are available to add or remove this assignment.

9.2.3.2 Configuring QoS Traffic Policies FM6000 Platform Switches

QoS traffic policies are implemented by creating class maps and policy maps, then applying the policy maps to Ethernet and port channel interfaces.

Creating Class Maps

QoS traffic policies utilize dynamic class maps that are created and modified in class-map configuration mode. The **class-map type qos** command enters class-map configuration mode.

Example

This command enters class-map configuration mode to create QoS class map named Q-CMap_1.

```
switch(config) #class-map type qos match-any Q-CMap_1
switch(config-cmap-Q-CMap_1) #
```

A class map contains one IPv4 access control list (ACL). The **match (class-map (qos) FM6000)** command assigns an ACL to the class map. Subsequent **match** commands replace the existing **match** command. Class maps filter traffic only on ACL permit rules. Deny ACL rules are disregarded.

Example

This command adds the IPv4 ACL named **ACL_1** to the class map.

```
switch(config-cmap-Q-CMap_1) #match ip access-group ACL_1
switch(config-cmap-Q-CMap_1) #
```

Class-map configuration mode is a group-change mode. Changes made in a group-change mode are saved by exiting the mode. The **show active** command displays the saved version of class map. The **show pending** command displays the unsaved class map.

Example

The **show active** command indicates that the configuration mode class map is not stored in **running-config**. The **show pending** command displays the class map to be stored upon exiting class-map configuration mode.

```
switch(config-cmap-Q-CMap_1)#show active
switch(config-cmap-Q-CMap_1)#show pending
class-map type qos match-any Q-CMap_1
    match ip access-group ACL_1

switch(config-cmap-Q-CMap_1)#
```

The **exit** command returns the switch to global configuration mode and saves pending class map changes. The **abort** command returns the switch to global configuration mode and discards pending changes.

Example

This command exits class-map configuration mode and stores pending changes to **running-config**.

```
switch(config-cmap-CP-CMAP_1)#exit
switch(config)#show class-map type control-plane CP-CMAP_1
Class-map: CP-CMAP_1 (match-any)
Match: ip access-group name ACLv4_1
switch(config)#
```

Creating Policy Maps

Policy maps are created and modified in policy-map configuration mode. The **policy-map type quality-of-service** command enters policy-map configuration mode.

Example

This command places the switch in policy-map configuration mode and creates a QoS policy map named Q-PMAP_1.

```
switch(config)#policy-map type quality-of-service Q-PMAP_1
switch(config-pmap-Q-PMAP_1)#
```

Policy map are edited by adding or removing classes. A class automatically contains its eponymous class map; traffic resolution commands are added or edited in policy-map-class configuration mode. The **class (policy-map (qos) FM6000)** command adds a class to the configuration mode policy map and places the switch in policy-map-class configuration mode, where traffic resolution commands are added to the class.

Example

This command adds the **Q-CMap_1** class to the **Q-PMAP_1** policy map and places the switch in policy-map-class configuration mode.

```
switch(config-pmap-Q-PMAP_1)#class Q-CMap_1
```

```
switch(config-pmap-c-Q-PMAP_1-Q-CMap_1) #
```

set (policy-map-class (qos) FM6000) commands configure traffic resolution methods for data that passes the class map:

- **set cos** sets the Layer 2 CoS field.
- **set dscp** sets the DSCP value in the ToS byte.
- **set traffic class** specifies a traffic class queue.

Example

These commands configure the policy map to set the **CoS field 7** on packets filtered by the class map, then assigns those packets to **traffic class 4**.

```
switch(config-pmap-c-Q-PMAP_1-Q-CMap_1) #set cos 7
switch(config-pmap-c-Q-PMAP_1-Q-CMap_1) #set traffic-class 4
switch(config-pmap-c-Q-PMAP_1-Q-CMap_1) #
```

Policy-map and policy-map-class configuration modes are group-change modes. Changes are saved with the **exit** command or discarded with the **abort** command. The **show active** and **show pending** commands display the saved and modified policy map versions, respectively.

Example

These commands exit policy-map-class configuration mode, display the pending policy-map, then exit policy-map configuration mode to save the altered policy map to **running-config**.

```
switch(config-pmap-c-Q-PMAP_1-Q-CMap_1) #exit
switch(config-pmap-Q-PMAP_1) #show pending
policy-map type quality-of-service Q-PMAP_1
  class Q-CMap_1
    set cos 7
    set traffic-class 4

  class class-default

switch(config-pmap-Q-PMAP_1) #exit
switch(config) #
```

The last class in all QoS policy maps is **class-default**. The **class-default** class map matches all traffic except IPv4 or IPv6 traffic and provides no traffic resolution commands. The **class-default** class map is not editable; traffic resolution commands can be added to the **class-default** class.

To modify traffic resolution commands for the **class-default** class, enter policy-map-class configuration mode for the class, then enter the desired **set** commands.

Example

These commands enter policy-map-class configuration mode for **class-default**, configures the stream to enter **traffic class 2**, and saves the altered policy map to **running-config**.

```
switch(config)#policy-map type quality-of-service Q-PMap_1
switch(config-pmap-Q-PMap_1)#class class-default
switch(config-pmap-c-Q-PMap_1-class-default)#set traffic-class 2
switch(config-pmap-c-Q-PMap_1-class-default)#exit
switch(Q-PMap_1)#exit
switch(config)#show policy-map type qos Q-PMap_1
Service-policy Q-PMap_1

Class-map: Q-CMap_1 (match-any)
  Match: ipv6 access-group name ACLv6_1
    set cos 7
    set traffic-class 4

Class-map: class-default (match-any)
  set traffic-class 2

switch(config)#
```

Applying Policy Maps to an Interface

The [service-policy type qos \(Interface mode\)](#) command applies a specified policy map to the configuration mode interface.

These commands apply **PMAP-1** policy map to **interface Ethernet 8**.

```
switch(config)#interface ethernet 8
switch(config-if-Et8)#show active
switch(config-if-Et8)#service-policy input PMAP-1
switch(config-if-Et8)#show active
interface Ethernet8
  service-policy type qos input PMAP-1
switch(config-if-Et8)#
```

9.2.3.3 Configuring PBR Policies FM6000 Platform Switches

Policy-Based Routing (PBR) is implemented by creating class maps and policy maps, then applying the policy maps to Ethernet interfaces, port channel interfaces or switch virtual interfaces (SVIs).

Creating PBR Class Maps

PBR policies utilize class maps that are created and modified in class-map configuration mode. The [class-map type pbr](#) command enters class-map configuration mode.

Example

- This command enters class-map configuration mode to create a PBR class map named **CMAP1**.

```
switch(config)#class-map type pbr match-any CMAP1
switch(config-cmap-PBR-CMAP1)#
```

A class map contains one or more IPv4 access control lists (ACLs). The [match \(policy-map \(pbr\)\)](#) command assigns an ACL to the class map. Subsequent [match](#) commands add additional ACLs to the class map. Class maps filter traffic only on ACL

permit rules. Deny ACL rules are disregarded; if a class map includes ACLs with deny rules, the configuration reverts to its previous state.

On FM6000 platform switches, counters are not supported, so a `counters per-entry (ACL configuration modes)` command in an ACL is ignored.

Example

- This command adds the IPv4 ACL named ACL1 to the class map.

```
switch(config-cmap-PBR-CMAP1)#match ip access-group ACL1
switch(config-cmap-PBR-CMAP1)#
```

Class-map configuration mode is a group-change mode. Changes made in a group-change mode are saved by exiting the mode. The `show active` command displays the saved version of class map.

- The `show active` command indicates that the configuration mode class map is not stored in running-config.

```
switch(config-cmap-PBR-CMAP1)#show active
switch(config-cmap-PBR-CMAP1)#
```

The `exit` command returns the switch to global configuration mode and saves pending class map changes. The `abort` command returns the switch to global configuration mode and discards pending changes.

Example

- This command exits class-map configuration mode and stores pending changes to *running-config*.

```
switch(config-cmap-PBR-CMAP1)#exit
switch(config)#show class-map type pbr CMAP1
class-map type pbr match-any CMAP1
  10 match ip access-group ACL1
switch(config)#
```

Creating PBR Policy Maps

Policy maps are created and modified in policy-map configuration mode. The `policy-map type pbr` command enters policy-map configuration mode.

Example

- This command enters policy-map configuration mode for creating a PBR policy map named *PMAP1*.

```
switch(config)#policy-map type pbr PMAP1
switch(config-pmap-PMAP1)#
```

Policy map are edited by adding or removing classes. A class automatically contains its eponymous class map; next-hop commands are added or edited in policy-map-class

configuration mode. The `class (policy-map pbr)` command adds a class to the configuration mode policy map and places the switch in policy-map-class configuration mode, where next-hop commands are added to the class.

Example

- This command adds the **CMAP1** class to the policy map and places the switch in policy-map-class configuration mode.

```
switch(config-pmap-PMAP1)#class CMAP1
switch(config-pmap-c-PMAP1-CMAP1)#
```

The `set nexthop (policy-map-class pbr)` command configures the next hop for data that passes the class map.

- This command configures the policy map to set the next hop to **10.12.0.5** on packets filtered by the class map.

```
switch(config-pmap-c-PMAP1-CMAP1)#set nexthop 10.12.0.5
switch(config-pmap-c-PMAP1-CMAP1)#
```

Policy-map and policy-map-class configuration modes are group-change modes. Changes are saved with the `exit` command or discarded with the `abort` command. The `show active` command displays the currently saved map version.

Example

- These commands exit policy-map-class configuration mode, then exit policy-map configuration mode to save the altered policy map to **running-config**.

```
switch(config-pmap-c-PMAP1-CMAP1)#exit
switch(config-pmap-PMAP1)#exit
switch(config)#
```

Applying a PBR Policy Map to an Interface

The `service-policy type pbr (Interface mode)` command applies the specified PBR policy map to the configuration mode interface. Only one PBR service policy is supported per interface.

- These commands apply the **PMAP1** PBR policy map to **interface Ethernet 8**.

```
switch(config)#interface ethernet 8
switch(config-if-Et8)#service-policy type pbr input PMAP1
switch(config-if-Et8)#
```

Hardware Decapsulation

When hardware decapsulation takes place, PBR policy maps on FM6000 platform switches match on outer packet headers (i.e., they match based on the attributes of the packet before it is decapsulated).

9.2.4 Traffic Management Configuration Petra Platform Switches

Traffic policies are implemented by policy maps, which are applied to the control plane. Policy maps contain classes, which are composed of class maps and traffic resolution commands. QoS traffic policies are not supported on 7500 Series switches.

[Traffic Management Conceptual Overview](#) describes traffic policies.

9.2.4.1 Configuring Control Plane Traffic Policies Petra Platform Switches

Default control plane traffic policies are implemented automatically without user intervention. These policies are modified by associating traffic resolution commands with static classes that comprise the control plane policy map.

Static Class Maps

Control plane traffic policies utilize static class maps, which are provided by the switch, are not editable, and cannot be deleted.

Editing the Policy Map

The only control plane policy map is **copp-system-policy**, which cannot be deleted. In its default form, **copp-system-policy** consists of the classes listed in [copp-system-policy default classes: Petra Platform Switches](#). Although the underlying class map of each class cannot be edited, the traffic resolution commands can be adjusted. The default classes cannot be removed from the policy map and their sequence within the policy map is not editable.

Table 51: copp-system-policy default classes: Petra Platform Switches

Class Name	shape (kbps)	bandwidth (kbps)
copp-system-bpdu	2500	1250
copp-system-default	2500	250
copp-system-igmp	2500	250
copp-system-ipbroadcast	2500	250
copp-system-ipmc	2500	250
copp-system-ipmcmis	2500	250
copp-system-ipmcsvd	2500	250
copp-system-ipunicast	NO LIMIT	250
copp-system-l3destmiss	2500	250
copp-system-l3slowpath	2500	250
copp-system-l3ttl0	2500	250
copp-system-l3ttl1	2500	250

Class Name	shape (kbps)	bandwidth (kbps)
copp-system-lacp	2500	1250
copp-system-lldp	2500	250
copp-system-unicast-arp	2500	250

Policy maps are modified in policy-map configuration mode. The `policy-map type copp` command enters policy-map configuration mode.

Example

This command enters policy-map configuration mode for editing *copp-system-policy*.

```
switch(config)#policy-map type copp copp-system-policy
switch(config-pmap-copp-system-policy)#
```

The `class (policy-map (control-plane) Petra)` command enters policy-map-class configuration mode, where traffic resolution commands are modified for the configuration mode class.

Example

- This command enters policy-map-class configuration mode for the copp-system-lldp static class.

```
switch(config-pmap-copp-system-policy)#class copp-system-lldp
switch(config-pmap-c-copp-system-policy-copp-system-lldp)#
```

Two traffic resolution commands determine bandwidth parameters for class traffic:

- `bandwidth (policy-map-class (control-plane) Petra)` specifies the minimum bandwidth.
- `shape (policy-map-class (control-plane) Petra)` specifies the maximum bandwidth.

Example

These commands configure a bandwidth range of 2000 to 4000 kilobits per seconds (kbps) for traffic filtered by the copp-system-arp class map:

```
switch(config-pmap-c-copp-system-policy-copp-system-
lldp)#bandwidth kbps 2000
switch(config-pmap-c-copp-system-policy-copp-system-lldp)#shape
kbps 4000
switch(config-pmap-c-copp-system-policy-copp-system-lldp)#
```

Policy-map and policy-map-class configuration modes are group-change modes. Changes are saved with the `exit` command or discarded with the `abort` command. The `show`

active command displays the saved version of policy map. The **show pending** command displays the configured policy map.

Petra platform switches do not support all discrete rate values. When a **bandwidth** or **shape** command specifies a value that is not supported, the switch converts the rate to the next highest discrete value that it supports. The [show policy-map interface type qos](#) command displays the converted rate and not the user configured rate.

Example

These commands exit policy-map-class configuration mode, display the pending policy-map, then exit policy-map configuration mode, which saves the altered policy map to **running-config**.

```
switch(config-pmap-c-copp-system-policy-copp-system-lacp) #exit
switch(config-pmap-copp-system-policy) #show pending
policy-map type copp copp-system-policy
  class copp-system-bpdu

  class copp-system-lldp
    shape kbps 4000
    bandwidth kbps 2000

  class copp-system-lacp

switch(config-pmap-copp-system-policy) #exit
switch(config) #
```

Changes are saved with the **exit** command or discarded with the **abort** command. The **show active** command displays the saved version of policy map. The **show pending** command displays the modified policy map.

Displaying Policy Maps

The [show policy-map interface type qos](#) command displays the traffic resolution rates of the policy maps classes and the number of packets filtered and dropped as a result of the class maps. The shape and bandwidth rates may differ from configured values, because the switch does not support all discrete rate values.

Example

These commands exit policy-map-class configuration mode, display the pending policy-map, then exit policy-map configuration mode, which saves the altered policy map to **running-config**.

```
switch(config) #show policy-map copp copp-system-policy
Service-policy input: copp-system-policy
Hardware programming status: InProgress

Class-map: copp-system-mlag (match-any)
  shape : 10000001 kbps
  bandwidth : 10000001 kbps
  Out Packets : 0
  Drop Packets : 0

Class-map: copp-system-lacp (match-any)
```

```

    shape : 2604 kbps
    bandwidth : 1302 kbps
    Out Packets : 0
    Drop Packets : 0

switch(config)#

```

Applying Policy Maps to the Control Plane

The **copp-system-policy** policy map is always applied to the control plane. No commands are available to add or remove this assignment.

9.2.4.2 Configuring QoS Traffic Policies – Petra Platform Switches

QoS traffic policies are not supported on Petra platform switches.

9.2.4.3 Configuring PBR Policies – Petra Platform Switches

PBR policies are not supported on Petra platform switches.

9.2.5 Traffic Management Configuration Trident Platform Switches

Traffic policies are implemented by policy maps, which are applied to the control plane or an interface. Policy maps contain classes, which are composed of class maps and traffic resolution commands. [Traffic Management Conceptual Overview](#) describes traffic policies.

Trident platform switches support the following traffic policies:

- Control plane policies manage control plane traffic.
- QoS traffic policies manage traffic on Ethernet and port channel interfaces.

These sections describe the construction and application of policy maps:

- [Configuring Control Plane Traffic Policies Trident Platform Switches](#)
- [Configuring QoS Traffic Policies Trident Platform Switches](#)
- [Configuring PBR Policies Trident Platform Switches](#)

9.2.5.1 Configuring Control Plane Traffic Policies Trident Platform Switches

Default control plane traffic policies are implemented automatically without user intervention. These policies are modified by creating class maps and editing the policy map to include the new class maps.

Creating Class Maps

Control plane traffic policies utilize static and dynamic class maps. Static class maps are provided by the switch, are not editable, and cannot be deleted. Dynamic class maps are created and modified in class-map configuration mode. The **class-map type copp** command enters class-map configuration mode.

Example

This command enters class-map configuration mode for creating or editing a control plane dynamic class map named **CP-CMAP_1**.

```

switch(config)#class-map type copp match-any CP-CMAP_1
switch(config-cmap-CP-CMAP_1)#

```

Class maps contain one IPv4 or IPv6 access control list (ACL). The `match (class-map (control-plane) Trident)` command assigns an ACL to the class map. Subsequent `match` commands replace the existing `match` command. Class maps filter traffic only on ACL permit rules. Deny ACL rules are disregarded.

Example

This command assigns the IPv4 ACL named **ACLv4_1** to the class map.

```
switch(config-cmap-CP-CMAP_1)#match ip access-group ACLv4_1
switch(config-cmap-CP-CMAP_1)#
```

Class-map configuration mode is a group-change mode. Changes are saved by exiting the mode. The `show active` command displays the saved version of class map. The `show pending` command displays the unsaved class map.

Example

The `show active` command indicates that the configuration mode class map is not stored in **running-config**. The `show pending` command displays the class map to be stored upon exiting class-map configuration mode.

```
switch(config-cmap-CP-CMAP_1)#show active
switch(config-cmap-CP-CMAP_1)#show pending
class-map type copp match-any CP-CMAP_1
  match ip access-group ACLv4_1

switch(config-cmap-CP-CMAP_1)#
```

The `exit` command returns the switch to global configuration mode and saves pending class map changes. The `abort` command returns the switch to global configuration mode and discards pending class map changes.

Example

This command exits class-map configuration mode and stores pending changes to **running-config**.

```
switch(config-cmap-CP-CMAP_1)#exit
switch(config)#show class-map type control-plane CP-CMAP_1
Class-map: CP-CMAP_1 (match-any)
  Match: ip access-group name ACLv4_1
switch(config)#
```

Editing the Policy Map

The only control plane policy map is **copp-system-policy**, which cannot be deleted. In its default form, **copp-system-policy** consists of the classes listed in [copp-system-policy default classes: Trident Platform Switches](#). Although the underlying class map of each class cannot be edited, the traffic resolution commands can be adjusted. The default classes cannot be removed from the policy map and their sequence within the policy map is not editable.

Table 52: copp-system-policy default classes: Trident Platform Switches

Class Name	shape (pps)	bandwidth (pps)
copp-system-bpdu	5000	5000
copp-system-lacp	5000	5000
copp-system-selfip-tc6to7	5000	5000
copp-system-selfip	5000	5000
copp-system-tc6to7	10000	1000
copp-system-ldp	10000	1000
copp-system-ipmcrsvd	10000	1000
copp-system-igmp	10000	1000
copp-system-ipmcmis	10000	1000
copp-system-glean	10000	1000
copp-system-tc3to5	10000	1000
copp-system-arp	10000	1000
copp-system-arpresolver	10000	1000
copp-system-l3destmiss	10000	1000
copp-system-l3slowpath	10000	1000
copp-system-l3ttl1	10000	1000
copp-system-default	8000	1000
copp-system-aclog	10000	1000
copp-system-sflow	25000	0

Policy maps are modified in policy-map configuration mode. The `policy-map type copp` command enters policy-map configuration mode.

Example

This command enters policy-map configuration mode for editing *copp-system-policy*.

```
switch(config)#policy-map type copp copp-system-policy
switch(config-pmap-copp-system-policy)#
```

Dynamic classes are inserted in front of the static classes. Classes automatically contain their eponymous class map; traffic resolution commands are created or edited in policy-map-class configuration mode. The `class (policy-map (control-plane) Trident)` command adds a class to the policy map and places the switch in policy-map-class configuration mode, where traffic resolution commands are added to the class.

Example

This command adds the **CP-CMAP_1** class to the copp-system-policy policy map and places the switch in policy-map-class configuration mode.

```
switch(config-pmap-copp-system-policy)#class CP-CMAP_1
switch(config-pmap-c-copp-system-policy-CP-CMAP_1)#
```

Two traffic resolution commands determine bandwidth parameters for class traffic:

- `bandwidth (policy-map-class (control-plane) Trident)` specifies the minimum bandwidth.
- `shape (policy-map-class (control-plane) Trident)` specifies the maximum bandwidth.

Example

These commands configure a bandwidth range of 2000 to 4000 packets per seconds (pps) for traffic filtered by the **CP-CMAP_1** class map:

```
switch(config-pmap-c-copp-system-policy-CP-CMAP_1)#bandwidth pps
2000
switch(config-pmap-c-copp-system-policy-CP-CMAP_1)#shape pps 4000
switch(config-pmap-c-copp-system-policy-CP-CMAP_1)#
```

Example

Policy-map and policy-map-class configuration modes are group-change modes. Changes are saved with the `exit` command or discarded with the `abort` command. The `show active` command displays the saved version of policy map. The `show pending` command displays the modified policy map.

Example

These commands exit policy-map-class configuration mode, display the pending policy-map, then exit policy-map configuration mode, which saves the altered policy map to **running-config**.

```
switch(config-pmap-c-copp-system-policy-CP-CMAP_1)#exit
switch(config-pmap-copp-system-policy)#show pending
policy-map type copp copp-system-policy
  class CP-CMAP_1
    shape pps 4000
    bandwidth pps 2000

class copp-system-bpdu
```



```

class copp-system-lldp
class copp-system-lacp
class copp-system-arp
class copp-system-arpresolver
class copp-system-default

switch(config-pmap-copp-system-policy) #exit
switch(config) #

```

Example

To modify traffic resolution commands for a static class, enter policy-map-class configuration mode for the class, then enter the desired **bandwidth** and **shape** commands.

Example

These commands enter policy-map-class configuration mode for copp-system-bpdu class, change the bandwidth range for the class, then save the altered policy map to **running-config**.

```

switch(config) #policy-map type copp copp-system-policy
switch(config-pmap-copp-system-policy) #class copp-system-bpdu
switch(config-pmap-c-copp-system-policy-copp-system-bpdu) #shape
pps 200
switch(config-pmap-c-copp-system-policy-copp-system-
bpdu) #bandwidth pps 100
switch(config-pmap-c-copp-system-policy-copp-system-bpdu) #exit
switch(config-pmap-copp-system-policy) #show pending
policy-map type copp copp-system-policy
  class CP-CMAP_1
    shape pps 4000
    bandwidth pps 2000

  class copp-system-bpdu
    shape pps 200
    bandwidth pps 100

  class copp-system-lldp

switch(config-pmap-copp-system-policy) #exit
switch(config) #

```

Applying Policy Maps to the Control Plane

The **copp-system-policy** policy map is always applied to the control plane. No commands are available to add or remove this assignment.

9.2.5.2 Configuring QoS Traffic Policies Trident Platform Switches

QoS traffic policies are implemented by creating class maps and policy maps, then applying the policy maps to Ethernet and port channel interfaces.

Creating Class Maps

QoS traffic policies utilize dynamic class maps that are created and modified in class-map configuration mode. The `class-map type qos` command enters class-map configuration mode.

Example

- This command enters class-map configuration mode to create QoS class map named Q-CMap_1.

```
switch(config)#class-map type qos match-any Q-CMap_1
switch(config-cmap-Q-CMap_1)#
```

A class map contains one IPv4 or IPv6 access control list (ACL). The `match (class-map (qos) Trident)` command assigns an ACL to the class map. Subsequent `match` commands replace the existing `match` command. Class maps filter traffic only on ACL permit rules. Deny ACL rules are disregarded.

Example

- This command adds the IPv6 ACL named `ACLv6_1` to the class map.

```
switch(config-cmap-Q-CMap_1)#match ipv6 access-group ACLv6_1
switch(config-cmap-Q-CMap_1)#
```

Class-map configuration mode is a group-change mode. Changes made in a group-change mode are saved by exiting the mode. The `show active` command displays the saved version of class map. The `show pending` command displays the unsaved class map.

Example

- The `show active` command indicates that the configuration mode class map is not stored in *running-config*. The `show pending` command displays the class map to be stored upon exiting class-map configuration mode.

```
switch(config-cmap-Q-CMap_1)#show active
switch(config-cmap-Q-CMap_1)#show pending
class-map type qos match-any Q-CMap_1
  match ipv6 access-group ACLv6_1

switch(config-cmap-Q-CMap_1)#
```

The `exit` command returns the switch to global configuration mode and saves pending class map changes. The `abort` command returns the switch to global configuration mode and discards pending class map changes.

Example

- This command exits class-map configuration mode and stores pending changes to *running-config*.

```
switch(config-cmap-CP-CMAP_1)#exit
switch(config)#show class-map type control-plane CP-CMAP_1
  Class-map: CP-CMAP_1 (match-any)
    Match: ip access-group name ACLv4_1
switch(config)#
```

Creating Policy Maps

Policy maps are created and modified in policy-map configuration mode. The `policy-map type quality-of-service` command enters policy-map configuration mode.

Example

- This command enters policy-map configuration mode for creating a QoS policy map named **Q-PMAP_1**.

```
switch(config)#policy-map type quality-of-service Q-PMAP_1
switch(config-pmap-Q-PMAP_1)#
```

Policy maps are edited by adding or removing classes. A class automatically contains its eponymous class map; traffic resolution commands are added or edited in policy-map-class configuration mode. The `class (policy-map (qos) Trident)` command adds a class to the configuration mode policy map and places the switch in policy-map-class configuration mode, where traffic resolution commands are added to the class.

Example

- This command adds the **Q-CMap_1** class to the **Q-PMAP_1** policy map and places the switch in policy-map-class configuration mode.

```
switch(config-pmap-Q-PMAP_1)#class Q-CMap_1
switch(config-pmap-c-Q-PMAP_1-Q-CMap_1)#
```

The `set (policy-map-class (qos) Trident)` command configures traffic resolution methods for data that passes the class map:

- **set cos** sets the layer 2 CoS field.
- **set dscp** sets the DSCP value in the ToS byte.
- **set traffic class** specifies a traffic class queue.

Example

- These commands configure the policy map to set **CoS field 7** on packets filtered by the class map, then assigns those packets to **traffic class 4**.

```
switch(config-pmap-c-Q-PMAP_1-Q-CMap_1)#set cos 7
```

```
switch(config-pmap-c-Q-PMAP_1-Q-CMap_1)#set traffic-class 4
switch(config-pmap-c-Q-PMAP_1-Q-CMap_1)#
```

Policy-map and policy-map-class configuration modes are group-change modes. Changes are saved with the **exit** command or discarded with the **abort** command. The **show active** and **show pending** commands display the saved and modified policy map versions, respectively.

Example

- These commands exit policy-map-class configuration mode, display the pending policy-map, then exit policy-map configuration mode to save the altered policy map to **running-config**.

```
switch(config-pmap-c-Q-PMAP_1-Q-CMap_1)#exit
switch(config-pmap-Q-PMAP_1)#show pending
policy-map type quality-of-service Q-PMAP_1
  class Q-CMap_1
    set cos 7
    set traffic-class 4

  class class-default

switch(config-pmap-Q-PMAP_1)#exit
switch(config)#
```

The last class in all QoS policy maps is **class-default**. The **class-default** class map matches all traffic except IPv4 or IPv6 traffic and provides no traffic resolution commands. The **class-default** class map is not editable; traffic resolution commands can be added to the **class-default** class.

To modify traffic resolution commands for the **class-default** class, enter policy-map-class configuration mode for the class, then enter the desired **set** commands.

Example

- These commands enter policy-map-class configuration mode for **class-default**, configures the stream to enter **traffic class 2**, and saves the altered policy map to **running-config**.

```
switch(config)#policy-map type quality-of-service Q-PMap_1
switch(config-pmap-Q-PMap_1)#class class-default
switch(config-pmap-c-Q-PMap_1-class-default)#set traffic-class
2
switch(config-pmap-c-Q-PMap_1-class-default)#exit
switch(config-pmap-Q-PMap_1)#exit
switch(config)#show policy-map type qos Q-PMap_1
Service-policy Q-PMap_1

  Class-map: Q-CMap_1 (match-any)
    Match: ipv6 access-group name ACLv6_1
          set cos 7
          set traffic-class 4

  Class-map: class-default (match-any)
    set traffic-class 2
```

```
switch(config)#
```

Applying Policy Maps to an Interface

The `service-policy type qos (Interface mode)` command applies a specified policy map to the configuration mode interface.

Example

- These commands apply **PMAP-1** policy map to **interface Ethernet 8**.

```
switch(config)#interface ethernet 8
switch(config-if-Et8)#show active
switch(config-if-Et8)#service-policy input PMAP-1
switch(config-if-Et8)#show active
interface Ethernet8
  service-policy type qos input PMAP-1
switch(config-if-Et8)#
```

9.2.5.3 Configuring PBR Policies Trident Platform Switches

Policy-Based Routing (PBR) is implemented by creating class maps and policy maps, then applying the policy maps to Ethernet interfaces, port channel interfaces or switch virtual interfaces (SVIs).

Creating PBR Class Maps

PBR policies utilize class maps that are created and modified in class-map configuration mode. The `class-map type pbr` command enters class-map configuration mode.

Example

This command enters class-map configuration mode to create a PBR class map named **CMAP1**.

```
switch(config)#class-map type pbr match-any CMAP1
switch(config-cmap-PBR-CMAP1)#
```

A class map contains one or more access control lists (ACLs). The `match (policy-map (pbr))` command assigns an ACL to the class map. Subsequent `match` commands add additional ACLs to the class map. Class maps filter traffic only on ACL permit rules. Deny ACL rules are disregarded; if a class map includes ACLs with deny rules, the configuration reverts to its previous state.

Examples

- This command adds the ACL named **ACL1** to the class map.

```
switch(config-cmap-PBR-CMAP1)#match ip access-group ACL1
switch(config-cmap-PBR-CMAP1)#
```

Class-map configuration mode is a group-change mode. Changes made in a group-change mode are saved by exiting the mode. The **show active** command displays the saved version of class map.

- The **show active** command indicates that the configuration mode class map is not stored in **running-config**.

```
switch(config-cmap-PBR-CMAP1)#show active
switch(config-cmap-PBR-CMAP1)#
```

The **exit** command returns the switch to global configuration mode and saves pending class map changes. The **abort** command returns the switch to global configuration mode and discards pending changes.

Example

This command exits class-map configuration mode and stores pending changes to **running-config**.

```
switch(config-cmap-PBR-CMAP1)#exit
switch(config)#show class-map type pbr CMAP1
class-map type pbr match-any CMAP1
  10 match ip access-group ACL1
switch(config)#
```

Creating PBR Policy Maps

Policy maps are created and modified in policy-map configuration mode. The **policy-map type pbr** command enters policy-map configuration mode.

Example

- This command enters policy-map configuration mode for creating a PBR policy map named **PMAP1**.

```
switch(config)#policy-map type pbr PMAP1
switch(config-pmap-PMAP1)#
```

Policy map are edited by adding or removing classes. A class automatically contains its eponymous class map; next-hop commands are added or edited in policy-map-class configuration mode. The **class (policy-map (pbr))** command adds a class to the configuration mode policy map and places the switch in policy-map-class configuration mode, where next-hop commands are added to the class.

Example

- This command adds the **CMAP1** class to the policy map and places the switch in policy-map-class configuration mode.

```
switch(config-pmap-PMAP1)#class CMAP1
switch(config-pmap-c-PMAP1-CMAP1)#
```

The `set nexthop (policy-map-class pbr)` command configures the next hop for data that passes the class map.

- This command configures the policy map to set the next hop to **10.12.0.5** on packets filtered by the class map.

```
switch(config-pmap-c-PMAP1-CMAP1)#set nexthop 10.12.0.5
switch(config-pmap-c-PMAP1-CMAP1)#
```

Policy-map and policy-map-class configuration modes are group-change modes. Changes are saved with the `exit` command or discarded with the `abort` command. The `show active` command displays the currently saved map version.

- These commands exit policy-map-class configuration mode, then exit policy-map configuration mode to save the altered policy map to **running-config**.

```
switch(config-pmap-c-PMAP1-CMAP1)#exit
switch(config-pmap-PMAP1)#exit
switch(config)#
```

Applying a PBR Policy Map to an Interface

The `service-policy type pbr (Interface mode)` command applies the specified PBR policy map to the configuration mode interface. Only one PBR service policy is supported per interface.

- These commands apply the **PMAP1** PBR policy map to **Ethernet interface 8**.

```
switch(config)#interface ethernet 8
switch(config-if-Et8)#service-policy type pbr input PMAP1
switch(config-if-Et8)#
```

Hardware Decapsulation

When hardware decapsulation takes place, PBR policy maps on Trident platform switches match on inner packet headers (i.e., they match based on the attributes of the decapsulated packet).

9.2.6 Traffic Management Configuration Trident II Platform Switches

Traffic policies are implemented by policy maps, which are applied to the control plane or an interface. Policy maps contain classes, which are composed of class maps and traffic resolution commands. [Traffic Management Conceptual Overview](#) describes traffic policies.

Trident platform switches support the following traffic policies:

- Control plane policies manage control plane traffic.
- QoS traffic policies manage traffic on Ethernet and port channel interfaces.

9.2.6.1 Configuring Control Plane Traffic Policies Trident II Platform Switches

Default control plane traffic policies are implemented automatically without user intervention. These policies are modified by associating traffic resolution commands with static classes that comprise the control plane policy map.

Static Class Maps

Control plane traffic policies utilize static class maps, which are provided by the switch, are not editable, and cannot be deleted.

Editing the Policy Map

The only control plane policy map is **copp-system-policy**, which cannot be deleted. In its default form, **copp-system-policy** consists of the classes listed in [copp-system-policy default classes: Trident II Platform Switches](#). Although the underlying class map of each class cannot be edited, the traffic resolution commands can be adjusted. The default classes cannot be removed from the policy map and their sequence within the policy map is not editable.

Table 53: copp-system-policy default classes: Trident II Platform Switches

Class Name	shape (pps)	bandwidth (pps)
copp-system-aclog	1000	10000
copp-system-arp	1000	10000
copp-system-arpresolver	1000	10000
copp-system-bfd	5000	10000
copp-system-bgp	5000	5000
copp-system-bpdu	5000	5000
copp-system-default	1000	8000
copp-system-glean	1000	10000
copp-system-igmp	1000	10000
copp-system-ipmcmis	1000	10000
copp-system-ipmcsvd	1000	10000
copp-system-l3destmiss	1000	10000
copp-system-l3slowpath	1000	10000
copp-system-l3ttl1	1000	10000
copp-system-lacp	5000	5000
copp-system-lldp	1000	10000
copp-system-mlag	5000	5000
copp-system-selfip	5000	5000
copp-system-selfip-tc6to7	5000	5000
copp-system-sflow	0	25024
copp-system-tc3to5	1000	10000

Class Name	shape (pps)	bandwidth (pps)
copp-system-tc6to7	1000	10000
copp-system-urm	1000	10000

Policy maps are modified in policy-map configuration mode. The `policy-map type copp` command enters policy-map configuration mode.

Example

This command enters policy-map configuration mode for editing ***copp-system-policy***.

```
switch(config)#policy-map type copp copp-system-policy
switch(config-pmap-copp-system-policy)#
```

Example

The `class (policy-map (control-plane) Trident II)` command enters policy-map-class configuration mode, where traffic resolution commands are modified for the configuration mode class.

Example

This command enters policy-map-class configuration mode for the ***copp-system-lacp static*** class.

```
switch(config-pmap-copp-system-policy)#class copp-system-lacp
switch(config-pmap-c-copp-system-policy-copp-system-lacp)#
```

Two traffic resolution commands determine bandwidth parameters for class traffic:

- `bandwidth (policy-map-class (control-plane) Trident II)` specifies the minimum bandwidth.
- `shape (policy-map-class (control-plane) Trident II)` specifies the maximum bandwidth.

Example

These commands configure a bandwidth range of 2000 to 4000 packets per seconds (pps) for traffic filtered by the ***copp-system-lacp*** class map:

```
switch(config-pmap-c-copp-system-policy-copp-system-lacp)#bandwidth pps 2000
switch(config-pmap-c-copp-system-policy-copp-system-lacp)#shape
pps 4000
switch(config-pmap-c-copp-system-policy-copp-system-lacp)#
```

Example

Policy-map and **policy-map-class** configuration modes are group-change modes. Changes are saved with the **exit** command or discarded with the **abort** command. The **show active** command displays the saved version of policy map. The **show pending** command displays the modified policy map.

Example

These commands exit **policy-map-class** configuration mode, display the pending **policy-map**, then exit **policy-map** configuration mode, which saves the altered policy map to **running-config**.

```
switch(config-pmap-c-copp-system-policy-copp-system-lacp) #exit
switch(config-pmap-copp-system-policy) #show pending
policy-map type copp copp-system-policy
  class copp-system-bpdu

  class copp-system-lldp

  class copp-system-lacp
    shape pps 4000
    bandwidth pps 2000

  class copp-system-arp

switch(config-pmap-copp-system-policy) #exit
switch(config) #
```

Applying Policy Maps to the Control Plane

The **copp-system-policy** policy map is always applied to the control plane. No commands are available to add or remove this assignment.

9.2.7 Traffic Management Configuration Commands

Traffic Policy (Control Plane) Configuration Commands

- `bandwidth (policy-map-class (control-plane) Arad)`
- `bandwidth (policy-map-class (control-plane) FM6000)`
- `bandwidth (policy-map-class (control-plane) Helix)`
- `bandwidth (policy-map-class (control-plane) Petra)`
- `bandwidth (policy-map-class (control-plane) Trident)`
- `bandwidth (policy-map-class (control-plane) Trident II)`
- `class-map type copp`
- `class (policy-map (control-plane) Arad)`
- `class (policy-map (control-plane) FM6000)`
- `class (policy-map (control-plane) Helix)`
- `class (policy-map (control-plane) Trident)`
- `class (policy-map (control-plane) Trident II)`
- `match (class-map (control-plane) Helix)`
- `match (class-map (control-plane) Trident)`
- `match (class-map (control-plane) Trident II)`
- `policy-map type copp`
- `shape (policy-map-class (control-plane) Arad)`
- `shape (policy-map-class (control-plane) FM6000)`
- `shape (policy-map-class (control-plane) Helix)`
- `shape (policy-map-class (control-plane) Petra)`
- `shape (policy-map-class (control-plane) Trident)`
- `shape (policy-map-class (control-plane) Trident II)`

Traffic Policy (PBR) Configuration Commands

- `class (policy-map (pbr))`
- `class-map type pbr`
- `match (class-map (pbr))`
- `match (policy-map (pbr))`
- `platform arad tcam counters feature`
- `policy-map type pbr`
- `resequence (class-map (pbr))`
- `resequence (policy-map (pbr))`
- `service-policy type pbr (Interface mode)`
- `set nexthop (policy-map-class pbr)`

Traffic Policy (PDP) Configuration Commands

- `policy-map type pdp`
- `service-policy type pdp (Interface mode)`

CPU Traffic Policy Command

- `feature traffic-policy cpu (ipv4 | ipv6)`

Traffic Policy (QoS) Configuration Commands

- `class-map type qos`

-
- class (policy-map (qos) FM6000)
 - class (policy-map (qos) Helix)
 - class (policy-map (qos) Trident)
 - class (policy-map (qos) Trident II)
 - match (class-map (qos) FM6000)
 - match (class-map (qos) Helix)
 - match (class-map (qos) Trident)
 - match (class-map (qos) Trident II)
 - policy-map type quality-of-service
 - service-policy type qos (Interface mode)
 - set (policy-map-class (qos) FM6000)
 - set (policy-map-class (qos) Helix)
 - set (policy-map-class (qos) Trident)
 - set (policy-map-class (qos) Trident II)

Traffic Policy Display and Utility Commands

- clear policy-map counters
- show class-map type control-plane
- show class-map type pbr
- show class-map type qos
- show policy-map type copp
- show policy-map type pbr
- show policy-map type qos
- show policy-map type qos counters
- show policy-map copp
- show policy-map interface type qos
- show policy-map interface type qos counters

9.2.7.1 bandwidth (policy-map-class (control-plane) Arad)

The **bandwidth** command specifies the minimum bandwidth for traffic filtered by the configuration mode policy map class.

The **no bandwidth** and **default bandwidth** commands remove the minimum bandwidth guarantee for the configuration mode class by deleting the corresponding **bandwidth** command from **running-config**.

Command Mode

Policy-map-class (control plane) configuration

accessed through **class (policy-map (control-plane) Arad)**

Command Syntax

bandwidth *kbps kilobits*

no bandwidth

default bandwidth

Parameters

- **kilobits** Minimum data rate in kilobits per second. Value ranges from 1 to 10000000.

Related Commands

- **class (policy-map (control-plane) Arad)** places the switch in policy-map-class (control plane) configuration mode.
- **shape (policy-map-class (control-plane) Arad)** specifies the maximum bandwidth for traffic defined by the associated class map in its configuration mode policy map class.

Static Classes Default Bandwidth

Arad platform switches define these default bandwidths for control plane static classes:

- copp-system-bgp 250 copp-system-l3lpmoverflow 250
- copp-system-bpdu 1250 copp-system-l3slowpath 250
- copp-system-default 250 copp-system-l3ttl1 250
- copp-system-ipbroadcast 250 copp-system-lacp 1250
- copp-system-ipmc 250 copp-system-linklocal 250
- copp-system-ipmcmis 250 copp-system-lldp 250
- copp-system-ipunicast 250 copp-system-mlag 250
- copp-system-l2broadcast 250 copp-system-multicastsnoop 250
- copp-system-l2unicast 250 copp-system-Ospfisis 250
- copp-system-l3destmiss 250 copp-system-sflow 250

Example

- These commands configure the minimum bandwidth of **500** kbps for data traffic specified by the class map **copp-system-lldp** of the default **control-plane** policy map.

```
switch(config)#policy-map type copp copp-system-policy
switch(config-pmap-copp-system-policy)#class copp-system-lldp
switch(config-pmap-c-copp-system-policy-copp-system-lldp)#bandwidth
kbps 500
switch(config-pmap-c-copp-system-policy-copp-system-lldp)#exit
switch(config-pmap-copp-system-policy)#exit
switch(config)#show policy-map copp copp-system-policy
Service-policy input: copp-system-policy
Hardware programming status: InProgress

Class-map: copp-system-lldp (match-any)
```

```
shape : 2500 kbps  
bandwidth : 500 kbps  
Out Packets : 0  
Drop Packets : 0
```

```
switch(config)#
```

9.2.7.2 bandwidth (policy-map-class (control-plane) FM6000)

The **bandwidth** command specifies the minimum bandwidth for traffic filtered by the configuration mode policy map class.

The **no bandwidth** and **default bandwidth** commands remove the minimum bandwidth guarantee for the configuration mode class by deleting the corresponding **bandwidth** command from *running-config*.

Command Mode

Policy-map-class (control plane) configuration

accessed through **class (policy-map (control-plane) FM6000)**

Command Syntax

bandwidth pps *packets*

no bandwidth

default bandwidth

Parameters

- **packets** Minimum data rate in packets per second. Value ranges from 1 to 100000.

Related Commands

- **class (policy-map (control-plane) FM6000)** places the switch in policy-map-class (control plane) configuration mode.
- **shape (policy-map-class (control-plane) FM6000)** specifies the maximum bandwidth for traffic defined by the associated class map in its configuration mode policy map class.

Static Classes Default Bandwidth

FM6000 platform switches define these default bandwidths for control plane static classes:

- copp-system-arp 1000 copp-system-l3slowpath 1000
- copp-system-default 1000 copp-system-pim-ptp 1000
- copp-system-ipmcrsvd 1000 copp-system-ospf-isis 1000
- copp-system-ipmcmis 1000 copp-system-selfip 5000
- copp-system-igmp 1000 copp-system-selfip-tc6to7 5000
- copp-system-l2rsvd 10000 copp-system-sflow 1000

Example

- These commands configure the minimum bandwidth of **1000** packets per second for data traffic specified by the class map **PMAP-1** in the policy map named **copp-system-policy**.

```
switch(config)#policy-map type copp copp-system-policy
switch(config-pmap-copp-system-policy)#class PMAP-1
switch(config-pmap-c-copp-system-policy-PMAP-1)#bandwidth pps 1000
switch(config-pmap-c-copp-system-policy-PMAP-1)#
```

9.2.7.3 bandwidth (policy-map-class (control-plane) Helix)

The **bandwidth** command specifies the minimum bandwidth for traffic filtered by the configuration mode policy map class.

The **no bandwidth** and **default bandwidth** commands remove the minimum bandwidth guarantee for the configuration mode class by deleting the corresponding **bandwidth** command from *running-config*.

Command Mode

Policy-map-class (control plane) configuration

accessed through **class (policy-map (control-plane) Helix)**

Command Syntax

```
bandwidth pps packets
```

```
no bandwidth
```

```
default bandwidth
```

Parameters

- **pps** Minimum data rate in packets per second. Value ranges from 1 to 100000.

Related Commands

- **class (policy-map (control-plane) Helix)** places the switch in policy-map-class (control plane) configuration mode.
- **shape (policy-map-class (control-plane) Helix)** specifies the maximum bandwidth for traffic defined by the associated class map in its configuration mode policy map class.

Static Classes Default Bandwidth

Helix platform switches define these default bandwidths for control plane static classes:

- copp-system-aclog 1000 copp-system-l3ttl1 1000
- copp-system-arp 1000 copp-system-lacp 5000
- copp-system-arpresolver 1000 copp-system-lldp 1000
- copp-system-bfd 5000 copp-system-mlag 5000
- copp-system-bgp 5000 copp-system-Ospfisis 5000
- copp-system-bpdu 5000 copp-system-selfip 5000
- copp-system-default 1000 copp-system-selfip-tc6to7 5000
- copp-system-glean 1000 copp-system-sflow 0
- copp-system-igmp 1000 copp-system-tc3to5 1000
- copp-system-ipmcmis 1000 copp-system-tc6to7 1000
- copp-system-ipmcsvd 1000 copp-system-urm 1000
- copp-system-l3destmiss 1000 copp-system-vrrp 1000
- copp-system-l3slowpath 1000

Example

- These commands configure the minimum bandwidth of **500** packets per second for data traffic specified by the class map **copp-system-lldp**.

```
switch(config)#policy-map type copp copp-system-policy
switch(config-pmap-copp-system-policy)#class copp-system-lldp
switch(config-pmap-c-copp-system-policy-copp-system-lldp)#bandwidth pps
500
switch(config-pmap-c-copp-system-policy-copp-system-lldp)#exit
switch(config-pmap-copp-system-policy)#exit
```



```
switch(config)#show policy-map interface control-plan copp-system-p  
olicy  
Service-policy input: copp-system-policy  
  Number of units programmed: 4  
  Hardware programming status: Successful  
  
  Class-map: copp-system-lldp (match-any)  
    shape : 10000 pps  
    bandwidth : 500 pps  
    Out Packets : 304996  
    Drop Packets : 0  
  
switch(config)#
```

9.2.7.4 bandwidth (policy-map-class (control-plane) Petra)

The **bandwidth** command specifies the minimum bandwidth for traffic filtered by the configuration mode policy map class.

The **no bandwidth** and **default bandwidth** commands remove the minimum bandwidth guarantee for the configuration mode class by deleting the corresponding **bandwidth** command from *running-config*.

Command Mode

Policy-map-class (control plane) configuration

accessed through **class (policy-map (control-plane) Petra)**

Command Syntax

```
bandwidth kbps kilobits
```

```
no bandwidth
```

```
default bandwidth
```

Parameters

- **kbps** Minimum data rate in kilobits per second. Value ranges from 1 to 10000000.

Related Commands

- **class (policy-map (control-plane) Petra)** places the switch in policy-map-class (control plane) configuration mode.
- **shape (policy-map-class (control-plane) Petra)** specifies the maximum bandwidth for traffic defined by the associated class map in its configuration mode *policy map class*.

Static Classes Default Bandwidth

Petra platform switches define these default bandwidths for control plane static classes:

- copp-system-bpdu 1250 copp-system-l3destmiss 250
- copp-system-default 250 copp-system-l3slowpath 250
- copp-system-igmp 250 copp-system-l3ttl0 250
- copp-system-ipbroadcast 250 copp-system-l3ttl1 250
- copp-system-ipmc 250 copp-system-lacp 1250
- copp-system-ipmcmis 250 copp-system-lldp 250
- copp-system-ipmcrsvd 250 copp-system-unicast-arp 250
- copp-system-ipunicast 250

Guidelines

Petra does not support all discrete rate values. When a specified discrete value is not supported, the switch converts the rate to the next highest discrete value that it supports. The **show** command displays the converted rate and not the user-configured rate.

Example

- These commands configure a minimum bandwidth of **500** kbps for data traffic specified by the class map **copp-system-lldp** of the default **control-plane** policy map. Because the switch does not support the discrete value of **500** kbps, it converts the bandwidth up to **651** kbps.

```
switch(config) #policy-map type copp copp-system-policy
switch(config-pmap-copp-system-policy) #class copp-system-lldp
switch(config-pmap-c-copp-system-policy-copp-system-lldp) #bandwidth
kbps 500
switch(config-pmap-c-copp-system-policy-copp-system-lldp) #exit
switch(config-pmap-copp-system-policy) #exit
```

```
switch(config)#show policy-map copp copp-system-policy
Service-policy input: copp-system-policy
  Hardware programming status: InProgress

  Class-map: copp-system-lldp (match-any)
    shape : 2766 kbps
    bandwidth : 651 kbps
    Out Packets : 0
    Drop Packets : 0

switch(config)#
```

9.2.7.5 bandwidth (policy-map-class (control-plane) Trident II)

The **bandwidth** command specifies the minimum bandwidth for traffic filtered by the configuration mode policy map class.

The **no bandwidth** and **default bandwidth** commands remove the minimum bandwidth guarantee for the configuration mode class by deleting the corresponding **bandwidth** command from *running-config*.

Command Mode

Policy-map-class (control plane) configuration

accessed through **class (policy-map (control-plane) Trident II)**

Command Syntax

```
bandwidth pps packets
```

```
no bandwidth
```

```
default bandwidth
```

Parameters

- **pps** Minimum data rate in packets per second. Value ranges from 1 to 100000.

Related Commands

- **class (policy-map (control-plane) Trident II)** places the switch in policy-map-class (control plane) configuration mode.
- **shape (policy-map-class (control-plane) Trident II)** specifies the maximum bandwidth for traffic defined by the associated class map in its configuration mode policy map class.

Static Classes Default Bandwidth

Trident II platform switches define these default bandwidths for control plane static classes:

- copp-system-aclog 1000 copp-system-l3slowpath 1000
- copp-system-arp 1000 copp-system-l3ttl1 1000
- copp-system-arpresolver 1000 copp-system-lacp 5000
- copp-system-bfd 5000 copp-system-lldp 1000
- copp-system-bgp 5000 copp-system-mlag 5000
- copp-system-bpdu 5000 copp-system-selfip 5000
- copp-system-default 1000 copp-system-selfip-tc6to7 5000
- copp-system-glean 1000 copp-system-sflow 0
- copp-system-igmp 1000 copp-system-tc3to5 1000
- copp-system-ipmcmis 1000 copp-system-tc6to7 1000
- copp-system-ipmcsvd 1000 copp-system-urm 1000
- copp-system-l3destmiss 1000

Example

- These commands configure the minimum bandwidth of 500 packets per second for data traffic specified by the class map copp-system-lldp.

```
switch(config)#policy-map type copp copp-system-policy
switch(config-pmap-copp-system-policy)#class copp-system-lldp
switch(config-pmap-c-copp-system-policy-copp-system-lldp)#bandwidth pps
500
switch(config-pmap-c-copp-system-policy-copp-system-lldp)#exit
switch(config-pmap-copp-system-policy)#exit
switch(config)#show policy-map interface control-plan copp-system-p
olicy
```

```
Service-policy input: copp-system-policy
  Number of units programmed: 4
  Hardware programming status: Successful

  Class-map: copp-system-lldp (match-any)
    shape : 10000 pps
    bandwidth : 500 pps
    Out Packets : 304996
    Drop Packets : 0

switch(config)#
```

9.2.7.6 bandwidth (policy-map-class (control-plane) Trident)

The **bandwidth** command specifies the minimum bandwidth for traffic filtered by the configuration mode policy map class.

The **no bandwidth** and **default bandwidth** commands remove the minimum bandwidth guarantee for the configuration mode class by deleting the corresponding **bandwidth** command from *running-config*.

Command Mode

Policy-map-class (control plane) configuration

accessed through **class (policy-map (control-plane) Trident)**

Command Syntax

```
bandwidth pps packets
```

```
no bandwidth
```

```
default bandwidth
```

Parameters

- **pps** Minimum data rate in packets per second. Value ranges from 1 to 100000.

Related Commands

- **class (policy-map (control-plane) Trident)** places the switch in policy-map-class (control plane) configuration mode.
- **shape (policy-map-class (control-plane) Trident)** specifies the maximum bandwidth for traffic defined by the associated class map in its configuration mode policy map class.

Static Classes Default Bandwidth

Trident platform switches define these default bandwidths for control plane static classes:

- copp-system-arp 1000 copp-system-ldp 1000
- copp-system-arpresolver 1000 copp-system-l3destmiss 1000
- copp-system-bpdu 5000 copp-system-l3slowpath 1000
- copp-system-default 1000 copp-system-l3ttl1 1000
- copp-system-glean 1000 copp-system-selfip 5000
- copp-system-igmp 1000 copp-system-selfip-tc6to7 5000
- copp-system-ipmcmis 1000 copp-system-sflow 0
- copp-system-ipmcrsvd 1000 copp-system-tc6to7 1000
- copp-system-lacp 5000 copp-system-tc3to5 1000

Example

- These commands configure the minimum bandwidth of **1000** packets per second for data traffic specified by the class map **PMAP-1** in the policy map named **copp-system-policy**.

```
switch(config)#policy-map type copp copp-system-policy
switch(config-pmap-copp-system-policy)#class PMAP-1
switch(config-pmap-c-copp-system-policy-PMAP-1)#bandwidth pps 1000
switch(config-pmap-c-copp-system-policy-PMAP-1)#
```

9.2.7.7 class (policy-map (control-plane) Arad)

The **class** command places the switch in policy-map-class (control plane) configuration mode, which is a group change mode for changing bandwidth and shape parameters associated with a specified class. All changes in a group change mode edit session are pending until the end of the session.

A policy map is an ordered list of classes. The control plane policy map contains 20 static classes. Each class contains an eponymous class map and may contain **bandwidth** and **shape** commands.

- The class map identifies a data stream.
- **bandwidth** command defines the streams minimum transmission rate through the control plane.
- **shape** command defines the streams maximum transmission rate through the control plane.

Static class maps identify a data stream by definition. Each data packet is managed by commands of the first class whose map matches the packets content. Dynamic classes are not supported for control plane policing on Arad platform switches.

Each class corresponds to a transmission queue. Queue scheduling is round-robin until **bandwidth** rate for a queue is exceeded. Scheduling becomes strict-priority with CPU queue number determining priority until the **shape** rate is reached. Packets are dropped after the shape rate is exceeded.

The **exit** command returns the switch to policy-map configuration mode. Saving policy-map-class changes also require an exit from policy-map mode, which saves pending policy-map-class and policy-map changes to **running-config** and returns the switch to global configuration mode. The **abort** command discards pending changes, returning the switch to global configuration mode.

The **no class** and **default class** commands remove policy-map-class commands for the specified class assignment from the policy map.

Command Mode

Policy-Map (control plane) configuration

accessed through **policy-map type copp** command

Command Syntax

class *class_name*

no class *class_name*

default class *class_name*

Parameters

class_name name of the class.

Static Classes

Arad platform switches provide the following static control plane classes:

- copp-system-bgp copp-system-l2broadcast copp-system-linklocal
- copp-system-bpdu copp-system-l2unicast copp-system-ldp
- copp-system-default copp-system-l3destmiss copp-system-mlag
- copp-system-ipbroadcast copp-system-l3lpmoverflow copp-system-multicastsnoop
- copp-system-ipmc copp-system-l3slowpath copp-system-Ospfisis
- copp-system-ipmcmis copp-system-l3ttl1 copp-system-sflow
- copp-system-ipunicast copp-system-lacp

Commands Available in Policy-map-class (control plane) Configuration Mode

- **bandwidth** (policy-map-class (control-plane) Arad)
- **shape** (policy-map-class (control-plane) Arad)
- **exit** saves pending class map changes, then returns the switch to global configuration mode.
- **abort** discards pending class map changes, then returns the switch to global configuration mode.

Related Commands

`policy-map type copp` places switch in policy-map (control plane) configuration mode.

Example

These commands enters *policy-map-class* configuration mode to modify the shape, bandwidth parameters associated with the static class named *copp-system-lldp*.

```
switch(config) #policy-map type copp copp-system-policy
switch(config-pmap-copp-system-policy) #class copp-system-lldp
switch(config-pmap-c-copp-system-policy-copp-system-lldp) #
```

9.2.7.8 class (policy-map (control-plane) FM6000)

The **class** command places the switch in policy-map-class (control plane) configuration mode, which is a group change mode for changing bandwidth and shape parameters associated with a specified class. All changes in a group change mode edit session are pending until the end of the session.

A policy map is an ordered list of classes. The control plane policy map contains 12 static classes. Each class contains an eponymous class map and may contain **bandwidth** and **shape** commands.

- The class map identifies a data stream.
- **bandwidth** command defines the streams minimum transmission rate through the control plane.
- **shape** command defines the streams maximum transmission rate through the control plane.

Static class maps identify a data stream by definition. Each data packet is managed by commands of the first class whose map matches the packets content. Dynamic classes are not supported for control plane policing on FM6000 platform switches.

Each class corresponds to a transmission queue. Queue scheduling is round-robin until **bandwidth** rate for a queue is exceeded. Scheduling becomes strict-priority with CPU queue number determining priority until the **shape** rate is reached. Packets are dropped after the shape rate is exceeded.

The **exit** command returns the switch to policy-map configuration mode. Saving policy-map-class changes also require an exit from policy-map mode, which saves pending policy-map-class and policy-map changes to **running-config** and returns the switch to global configuration mode. The **abort** command discards pending changes, returning the switch to global configuration mode.

The **no class** and **default class** commands remove policy-map-class commands for the specified class assignment from the policy map. The class is removed from the policy map if it is a dynamic class.

Command Mode

Policy-Map (control plane) configuration

accessed through **policy-map type copp** command

Command Syntax

class *class_name*

no class *class_name*

default class *class_name*

Parameters

class_name name of the class.

Static Classes

FM6000 platform switches provide the following static control plane classes:

- copp-system-arp copp-system-igmp copp-system-PimPtp
- copp-system-default copp-system-l2rsvd copp-system-selfip
- copp-system-ipmcmis copp-system-l3slowpath copp-system-selfip-tc6to7
- copp-system-ipmcrsvd copp-system-OspfLsis copp-system-sflow

Commands Available in Policy-map-class (control plane) Configuration Mode

- **bandwidth** (policy-map-class (control-plane) FM6000)
- **shape** (policy-map-class (control-plane) FM6000)
- **exit** saves pending class map changes, then returns the switch to global configuration mode.
- **abort** discards pending class map changes, then returns the switch to global configuration mode.

Related Commands

`policy-map type copp` places switch in policy-map (control plane) configuration mode.

Example

These commands enters policy-map-class configuration mode to modify the shape, bandwidth parameters associated with the static class named ***copp-system-arp***.

```
switch(config) #policy-map type copp copp-system-policy  
switch(config-pmap-copp-system-policy) #class copp-system-arp  
switch(config-pmap-c-copp-system-policy-copp-system-arp) #
```

9.2.7.9 class (policy-map (control-plane) Helix)

The **class** command places the switch in policy-map-class (control plane) configuration mode, which is a group change mode for changing bandwidth and shape parameters associated with a specified class. All changes in a group change mode edit session are pending until the end of the session.

A policy map is an ordered list of classes. The **control plane** policy map contains 23 static classes. Each class contains an eponymous class map and may contain **bandwidth** and **shape** commands.

- The class map identifies a data stream.
- **bandwidth** command defines the streams minimum transmission rate through the control plane.
- **shape** command defines the streams maximum transmission rate through the control plane.

Static class maps identify a data stream by definition. Each data packet is managed by commands of the first class whose map matches the packets content. Dynamic classes are not supported for control plane policing on Helix platform switches.

Each class corresponds to a transmission queue. Queue scheduling is strict-priority; CPU queue number determines priority until the **shape** rate is reached. Packets are dropped after the shape rate is exceeded.

The **exit** command returns the switch to policy-map configuration mode. Saving policy-map-class changes also require an exit from policy-map mode, which saves pending policy-map-class and policy-map changes to **running-config** and returns the switch to global configuration mode. The **abort** command discards pending changes, returning the switch to global configuration mode.

The **no class** and **default class** commands remove policy-map-class commands for the specified class assignment from the policy map.

Command Mode

Policy-Map (control plane) configuration

accessed through **policy-map type copp** command

Command Syntax

class *class_name*

no class *class_name*

default class *class_name*

Parameters

class_name name of the class.

Static Classes

Helix platform switches provide the following static control plane classes:

- copp-system-aclog copp-system-ipmcmis copp-system-Ospfisis
- copp-system-arp copp-system-ipmcsvd copp-system-selfip
- copp-system-arpresolver copp-system-l3destmiss copp-system-selfip-tc6to7
- copp-system-bfd copp-system-l3slowpath copp-system-sflow
- copp-system-bgp copp-system-l3ttl1 copp-system-tc3to5
- copp-system-bpdu copp-system-lacp copp-system-tc6to7
- copp-system-default copp-system-lldp copp-system-urm
- copp-system-glean copp-system-lldp copp-system-vrrp
- copp-system-igmp copp-system-lldp

Commands Available in Policy-map-class (control plane) Configuration Mode

- [bandwidth \(policy-map-class \(control-plane\) Helix\)](#)
- [shape \(policy-map-class \(control-plane\) Helix\)](#)

-
- **exit** saves pending class map changes, then returns the switch to global configuration mode.
 - **abort** discards pending class map changes, then returns the switch to global configuration mode.

Related Commands

[policy-map type copp](#) places switch in policy-map (control plane) configuration mode.

Example

These commands enters policy-map-class configuration mode to modify the shape, bandwidth parameters associated with the static class named ***copp-system-arp***.

```
switch(config) #policy-map
switch(config) #policy-map type copp copp-system-policy
switch(config-pmap-copp-system-policy) #class copp-system-lldp
switch(config-pmap-c-copp-system-policy-copp-system-lldp) #
```

9.2.7.10 class (policy-map (control-plane) Petra)

The **class** command places the switch in policy-map-class (control plane) configuration mode, which is a group change mode for changing bandwidth and shape parameters associated with a specified class. All changes in a group change mode edit session are pending until the end of the session.

A policy map is an ordered list of classes. The control plane policy map contains 15 static classes. Each class contains an eponymous class map and may contain **bandwidth** and **shape** commands.

- The class map identifies a data stream.
- **bandwidth** command defines the streams minimum transmission rate through the control plane.
- **shape** command defines the streams maximum transmission rate through the control plane.

Static class maps identify a data stream by definition. Each data packet is managed by commands of the first class whose map matches the packets content. Dynamic classes are not supported for control plane policing on Petra platform switches.

Each class corresponds to a transmission queue. Queue scheduling is round-robin until **bandwidth** rate for a queue is exceeded. Scheduling becomes strict-priority with CPU queue number determining priority until the **shape** rate is reached. Packets are dropped after the shape rate is exceeded.

The **exit** command returns the switch to policy-map configuration mode. Saving policy-map-class changes also require an exit from policy-map mode, which saves pending policy-map-class and policy-map changes to **running-config** and returns the switch to global configuration mode. The **abort** command discards pending changes, returning the switch to global configuration mode.

The **no class** and **default class** commands remove policy-map-class commands for the specified class assignment from the policy map.

Command Mode

Policy-Map (control plane) configuration accessed through [policy-map type copp](#) command.

Command Syntax

```
class class_name
```

```
no class class_name
```

```
default class class_name
```

Parameters

class_name name of the class.

Static Classes

Petra platform switches provide the following static control plane classes:

- copp-system-bpdu copp-system-ipmcmisss copp-system-l3ttl0
- copp-system-default copp-system-ipmcsvd copp-system-l3ttl1
- copp-system-igmp copp-system-ipunicast copp-system-lacp
- copp-system-ipbroadcast copp-system-l3destmiss copp-system-lldp
- copp-system-ipmc copp-system-l3slowpath copp-system-unicast-arp

Commands Available in Policy-map-class (control plane) Configuration Mode

- [bandwidth \(policy-map-class \(control-plane\) Petra\)](#)
- [shape \(policy-map-class \(control-plane\) Petra\)](#)
- **exit** saves pending class map changes, then returns the switch to global configuration mode.
- **abort** discards pending class map changes, then returns the switch to global configuration mode.

Related Commands

[policy-map type copp](#) places switch in policy-map (control plane) configuration mode.

Example

These commands enter policy-map-class configuration mode to modify the shape, bandwidth parameters associated with the static class named ***copp-system-lldp***.

```
switch(config) #policy-map  
switch(config) #policy-map type copp copp-system-policy  
switch(config-pmap-copp-system-policy) #class copp-system-lldp  
switch(config-pmap-c-copp-system-policy-copp-system-lldp) #
```

9.2.7.11 class (policy-map (control-plane) Trident II)

The **class** command places the switch in policy-map-class (control plane) configuration mode, which is a group change mode for changing bandwidth and shape parameters associated with a specified class. All changes in a group change mode edit session are pending until the end of the session.

A policy map is an ordered list of classes. The control plane policy map contains 23 static classes. Each class contains an eponymous class map and may contain **bandwidth** and **shape** commands.

- The class map identifies a data stream.
- **bandwidth** command defines the streams minimum transmission rate through the control plane.
- **shape** command defines the streams maximum transmission rate through the control plane.

Static class maps identify a data stream by definition. Each data packet is managed by commands of the first class whose map matches the packets content. Dynamic classes are not supported for control plane policing on Trident II platform switches.

Each class corresponds to a transmission queue. Queue scheduling is strict-priority; CPU queue number determines priority until the **shape** rate is reached. Packets are dropped after the shape rate is exceeded.

The **exit** command returns the switch to policy-map configuration mode. Saving policy-map-class changes also require an exit from policy-map mode, which saves pending policy-map-class and policy-map changes to **running-config** and returns the switch to global configuration mode. The **abort** command discards pending changes, returning the switch to global configuration mode.

The **no class** and **default class** commands remove policy-map-class commands for the specified class assignment from the policy map.

Command Mode

Policy-Map (control plane) configuration accessed through **policy-map type copp** command.

Command Syntax

```
class class_name
```

```
no class class_name
```

```
default class class_name
```

Parameters

class_name name of the class.

Static Classes

Trident II platform switches provide the following static control plane classes:

- copp-system-aclog copp-system-igmp copp-system-mlag
- copp-system-arp copp-system-ipmcmis copp-system-selfip
- copp-system-arpresolver copp-system-ipmcrsvd copp-system-selfip-tc6to7
- copp-system-bfd copp-system-l3destmiss copp-system-sflow
- copp-system-bgp copp-system-l3slowpath copp-system-tc3to5
- copp-system-bpdu copp-system-l3ttl1 copp-system-tc6to7
- copp-system-default copp-system-lacp copp-system-urm
- copp-system-glean copp-system-lldp

Commands Available in Policy-map-class (control plane) Configuration Mode

- **bandwidth** (policy-map-class (control-plane) Trident II)
- **shape** (policy-map-class (control-plane) Trident II)
- **exit** saves pending class map changes, then returns the switch to global configuration mode.
- **abort** discards pending class map changes, then returns the switch to global configuration mode.

Related Commands

`policy-map type copp` places switch in *policy-map (control plane)* configuration mode.

Example

These commands enters policy-map-class configuration mode to modify the shape, bandwidth parameters associated with the static class named *copp-system-arp*.

```
switch(config) #policy-map  
switch(config) #policy-map type copp copp-system-policy  
switch(config-pmap-copp-system-policy) #class copp-system-lldp  
switch(config-pmap-c-copp-system-policy-copp-system-lldp) #
```

9.2.7.12 class (policy-map (control-plane) Trident)

The **class** command places the switch in policy-map-class (control plane) configuration mode, which is a group change mode for changing bandwidth and shape parameters associated with a specified class. The command adds the specified class to the policy map if it was not previously included. All changes in a group change mode edit session are pending until the end of the session.

A policy map is an ordered list of classes. The control plane policy map contains 18 static classes and up to 30 dynamic classes. Dynamic classes contain an eponymous class map. All classes may contain **bandwidth** and **shape** commands.

- The class map identifies a data stream.
- **bandwidth** command defines the streams minimum transmission rate through the control plane.
- **shape** command defines the streams maximum transmission rate through the control plane.

Dynamic class maps identify a data stream with an ACL assigned by **match (class-map (control-plane) Trident)**. Static class maps identify a data stream by definition. Each data packet is managed by commands of the first class whose map matches the packets content.

Static classes are provided with the switch and cannot be removed from the policy map or modified by the **class** command. Dynamic classes are user defined and added to the policy map by this command. Dynamic classes are always placed in front of the static classes. Bandwidth and shape parameters are editable for all classes.

Each class corresponds to a transmission queue. Queue scheduling is round-robin until **bandwidth** rate for a queue is exceeded. Scheduling becomes strict-priority with CPU queue number determining priority until the **shape** rate is reached. Packets are dropped after the shape rate is exceeded.

The **exit** command returns the switch to policy-map configuration mode. Saving policy-map-class changes also require an exit from policy-map mode, which saves pending policy-map-class and policy-map changes to **running-config** and returns the switch to global configuration mode. The **abort** command discards pending changes, returning the switch to global configuration mode.

The **no class** and **default class** commands remove policy-map-class commands for the specified class assignment from the policy map. The class is removed from the policy map if it is a dynamic class.

Command Mode

Policy-Map (control plane) configuration accessed through **policy-map type copp** command.

Command Syntax

```
class class_name [PLACEMENT]
no class class_name [PLACEMENT]
default class class_name [PLACEMENT]
```

Parameters

- **class_name** name of the class.
- **PLACEMENT** Specifies the classes map placement. Configurable only for dynamic classes.
 - **no parameter** New classes are placed between the dynamic and static classes. Previously defined classes retain their current policy map placement.
 - **insert-before dynamic_class** Class is inserted in front of the specified dynamic class.

Static Classes

Trident switches provide the following static control plane classes:

- copp-system-aclog copp-system-ipmcmisss copp-system-lldp
- copp-system-arp copp-system-ipmcsvd copp-system-selfip
- copp-system-arpresolver copp-system-l3destmiss copp-system-selfip-tc6to7

-
- `copp-system-bpdu` `copp-system-l3slowpath` `copp-system-sflow`
 - `copp-system-glean` `copp-system-l3ttl1` `copp-system-tc3to5`
 - `copp-system-igmp` `copp-system-lacp` `copp-system-tc6to7`

Commands Available in Policy-map-class (control plane) Configuration Mode

- [bandwidth \(policy-map-class \(control-plane\) Trident\)](#)
- [shape \(policy-map-class \(control-plane\) Trident\)](#)
- `exit` saves pending class map changes, then returns the switch to global configuration mode.
- `abort` discards pending class map changes, then returns the switch to global configuration mode.

Related Commands

- [class-map type copp](#) places switch in class-map (control-plane) configuration mode.
- [policy-map type copp](#) places switch in policy-map (control plane) configuration mode.

Example

These commands add **CM-1** class to the **copp-system-policy** policy map.

```
switch(config)#policy-map type copp copp-system-policy  
switch(config-pmap-copp-system-policy)#class CM-1  
switch(config-pmap-c-copp-system-policy-CM-1)#
```

9.2.7.13 class (policy-map (pbr))

The `class (policy-map (pbr))` command places the switch in *policy-map-class (pbr)* configuration mode, which is a group change mode that modifies the specified class of the configuration mode Policy-Based Routing (PBR) policy map. The command adds the class to the policy map if it was not previously included in the policy map. All changes in a group change mode edit session are pending until the mode is exited, and can be canceled by using the `abort` command.

A PBR policy map is an ordered list of classes. Each class contains an eponymous class map and can contain set commands to specify next hop. Classes without set commands translate to no action being performed on that class of packets.

- The class map identifies a data stream through ACLs. Class maps are configured in `class-map (pbr)` configuration mode.
- `set` commands can be used to specify the next hop for a given class. `set` commands are configured in `policy-map-class (pbr)` configuration mode.

PBR policy maps can also contain one or more raw match statements which filter incoming traffic without using ACLs. Data packets are managed by commands of the first class or raw match statement matching the packets contents.

The `exit` command returns the switch to `policy-map (pbr)` configuration mode. However, saving `policy-map-class` changes also requires an exit from `policy-map (pbr)` configuration mode. This saves all pending policy map and `policy-map-class` changes to *running-config* and returns the switch to global configuration mode. The `abort` command discards pending changes, returning the switch to global configuration mode.

The `no class` and `default class` commands remove the class assignment from the configuration mode policy map by deleting the corresponding `class` configuration from *running-config*.

Command Mode

Policy-Map (pbr) Configuration accessed through `policy-map type pbr`.

Command Syntax

```
[sequence_number] class class_name
no [sequence_number] class class_name
default [sequence_number] class class_name
no [sequence_number]
default [sequence_number]
```

Parameters

- **sequence_number** Sequence number (1 to 4294967295) assigned to the rule. If no number is entered, the number is derived by adding 10 to the number of the policy maps last numbered line. To increase the distance between existing entries, use the `resequence` command.
- **class_name** name of the class.

Commands Available in Policy-map-class (pbr) Configuration Mode

- `set nexthop (policy-map-class pbr)` sets next hop for the class.
- `exit` saves pending class changes and returns switch to *policy-map (pbr)* configuration mode.
- `abort` discards pending class changes and returns switch to *policy-map (pbr)* configuration mode.

Related Commands

- `class-map type pbr` places switch in `class-map (pbr)` configuration mode.
- `policy-map type pbr` places switch in *policy-map (pbr)* configuration mode

Example

These commands add the **CMAP1** class map to the **PMAP1** policy map, then place the switch in policy-map-class configuration mode where the next hops can be assigned to the class. Changes will not take effect until both modes are exited.

```
switch(config)#policy-map type pbr PMAP1
switch(config-pmap-PMAP1)#class CMAP1
switch(config-pmap-c-PMAP1-CMAP1)#
```

9.2.7.14 class (policy-map (qos) FM6000)

The **class** command places the switch in policy-map-class (qos) configuration mode, which is a group change mode that modifies the specified class of the configuration mode policy map. The command adds the class to the policy map if it was not previously included in the policy map. All changes in a group change mode edit session are pending until the end of the session.

A policy map is an ordered list of classes. Each class contains an eponymous class map and at least one set command:

- The class map identifies a data stream through an ACL. Class maps are configured in class-map (qos) configuration mode.
- **set** commands either modify a packets content (CoS or DSCP fields) or assigns it to a traffic class queue. **set** commands are configured in policy-map-class (qos) configuration mode.

Data packets are managed by commands of the first class whose map matches the packets content.

The **exit** command returns the switch to policy-map configuration mode. However, saving policy-map-class changes also require an exit from policy-map mode. This saves all pending policy map and policy-map-class changes to **running-config** and returns the switch to global configuration mode. The **abort** command discards pending changes, returning the switch to global configuration mode.

The **no class** and **default class** commands remove the class assignment from the configuration mode policy map by deleting the corresponding **class** configuration from **running-config**.

Command Mode

Policy-Map (qos) Configuration accessed through **policy-map type quality-of-service**.

Command Syntax

```
class class_name [PLACEMENT]
```

```
no class class_name [PLACEMENT]
```

```
default class class_name [PLACEMENT]
```

Parameters

- **class_name** name of the class.
- **PLACEMENT** Specifies the map placement within the list of class maps.
 - **no parameter** Class is placed at the top of the list.
 - **insert-before existing_class** Class is inserted in front of the specified class.

Commands Available in Policy-map-class (qos) Configuration Mode

- **set (policy-map-class (qos) FM6000)**
- **exit** saves pending class changes and returns switch to **policy-map (qos)** configuration mode.
- **abort** discards pending class changes and returns switch to **policy-map (qos)** configuration mode.

Related Commands

- **class-map type qos** places switch in class-map (qos) configuration mode.
- **policy-map type quality-of-service** places switch in policy-map (qos) configuration mode

Example

These commands add the **CMAP_1** class map to the **PMAP_1** policy map, then places the switch in policy-map-class configuration mode.

```
switch(config)#policy-map type quality-of-service PMAP-1
switch(config-pmap-PMAP-1)#class CMAP-1
```

```
switch(config-pmap-c-PMAP-1-CMAP-1) #
```

9.2.7.15 class (policy-map (qos) Helix)

The **class** command places the switch in policy-map-class (qos) configuration mode, which is a group change mode that modifies the specified class of the configuration mode policy map. The command adds the class to the policy map if it was not previously included in the policy map. All changes in a group change mode edit session are pending until the end of the session.

A policy map is an ordered list of classes. Each class contains an eponymous class map and at least one set command:

- The class map identifies a data stream through an ACL. Class maps are configured in class-map (qos) configuration mode.
- **set** commands either modify a packets content (CoS or DSCP fields) or assigns it to a traffic class queue. **set** commands are configured in policy-map-class (qos) configuration mode.

Data packets are managed by commands of the first class whose map matches the packets content.

The **exit** command returns the switch to policy-map configuration mode. However, saving policy-map-class changes also require an exit from policy-map mode. This saves all pending policy map and policy-map-class changes to **running-config** and returns the switch to global configuration mode. The **abort** command discards pending changes, returning the switch to global configuration mode.

The **no class** and **default class** commands remove the class assignment from the configuration mode policy map by deleting the corresponding **class** configuration from **running-config**.

Command Mode

Policy-Map (qos) Configuration accessed through **policy-map type quality-of-service** command.

Command Syntax

```
class class_name [PLACEMENT]
no class class_name [PLACEMENT]
default class class_name [PLACEMENT]
```

Parameters

- **class_name** name of the class.
- **PLACEMENT** Specifies the map placement within the list of class maps.
 - **no parameter** Class is placed at the top of the list.
 - **insert-before existing_class** Class is inserted in front of the specified class.

Commands Available in Policy-map-class (qos) Configuration Mode

- **set (policy-map-class (qos) Helix)**
- **exit** saves pending class changes and returns switch to **policy-map (qos)** configuration mode.
- **abort** discards pending class changes and returns switch to **policy-map (qos)** configuration mode.

Related Commands

- **class-map type qos** places switch in class-map (qos) configuration mode.
- **policy-map type quality-of-service** places switch in policy-map (qos) configuration mode

Example

These commands add the **CMAP_1** class map to the **PMAP_1** policy map, then places the switch in **policy-map-class** configuration mode.

```
switch(config) #policy-map type quality-of-service PMAP-1
switch(config-pmap-PMAP-1) #class CMAP-1
```

```
switch(config-pmap-c-PMAP-1-CMAP-1) #
```

9.2.7.16 class (policy-map (qos) Trident II)

The **class** command places the switch in policy-map-class (qos) configuration mode, which is a group change mode that modifies the specified class of the configuration mode policy map. The command adds the class to the policy map if it was not previously included in the policy map. All changes in a group change mode edit session are pending until the end of the session.

A policy map is an ordered list of classes. Each class contains an eponymous class map and at least one set command:

- The class map identifies a data stream through an ACL. Class maps are configured in **class-map (qos)** configuration mode.
- **set** commands either modify a packets content (CoS or DSCP fields) or assigns it to a traffic class queue. **set** commands are configured in **policy-map-class (qos)** configuration mode.

Data packets are managed by commands of the first class whose map matches the packets content.

The **exit** command returns the switch to policy-map configuration mode. However, saving policy-map-class changes also require an exit from policy-map mode. This saves all pending policy map and policy-map-class changes to **running-config** and returns the switch to global configuration mode. The **abort** command discards pending changes, returning the switch to global configuration mode.

The **no class** and **default class** commands remove the class assignment from the configuration mode policy map by deleting the corresponding **class** configuration from **running-config**.

Command Mode

Policy-Map (qos) Configuration accessed through **policy-map type quality-of-service** command.

Command Syntax

```
class class_name [PLACEMENT]
no class class_name [PLACEMENT]
default class class_name [PLACEMENT]
```

Parameters

- **class_name** name of the class.
- **PLACEMENT** Specifies the map placement within the list of class maps.
 - **no parameter** Class is placed at the top of the list.
 - **insert-before existing_class** Class is inserted in front of the specified class.

Commands Available in Policy-map-class (qos) Configuration Mode

- **set (policy-map-class (qos) Trident II)**
- **exit** saves pending class changes and returns switch to **policy-map (qos)** configuration mode.
- **abort** discards pending class changes and returns switch to **policy-map (qos)** configuration mode.

Related Commands

- **class-map type qos** places switch in **class-map (qos)** configuration mode.
- **policy-map type quality-of-service** places switch in **policy-map (qos)** configuration mode

Example

These commands add the **CMAP_1** class map to the **PMAP_1** policy map, then places the switch in **policy-map-class** configuration mode.

```
switch(config)#policy-map type quality-of-service PMAP-1
switch(config-pmap-PMAP-1)#class CMAP-1
```

```
switch(config-pmap-c-PMAP-1-CMAP-1) #
```

9.2.7.17 class (policy-map (qos) Trident)

The **class** command places the switch in **policy-map-class (qos)** configuration mode, which is a group change mode that modifies the specified class of the configuration mode policy map. The command adds the class to the policy map if it was not previously included in the policy map. All changes in a group change mode edit session are pending until the end of the session.

A policy map is an ordered list of classes. Each class contains an eponymous class map and at least one set command:

- The class map identifies a data stream through an ACL. Class maps are configured in **class-map (qos)** configuration mode.
- **set** commands either modify a packets content (CoS or DSCP fields) or assigns it to a traffic class queue. **set** commands are configured in **policy-map-class (qos)** configuration mode.

Data packets are managed by commands of the first class whose map matches the packets content.

The **exit** command returns the switch to **policy-map** configuration mode. However, saving policy-map-class changes also require an exit from **policy-map** mode. This saves all pending policy map and policy-map-class changes to **running-config** and returns the switch to global configuration mode. The **abort** command discards pending changes, returning the switch to global configuration mode.

The **no class** and **default class** commands remove the class assignment from the configuration mode policy map by deleting the corresponding **class** configuration from **running-config**.

Command Mode

Policy-Map (qos) Configuration accessed through **policy-map type quality-of-service** command.

Command Syntax

```
class class_name [PLACEMENT]
```

```
no class class_name [PLACEMENT]
```

```
default class class_name [PLACEMENT]
```

Parameters

- **class_name** name of the class.
- **PLACEMENT** Specifies the map placement within the list of class maps.
 - **no parameter** Class is placed at the top of the list.
 - **insert-before existing_class** Class is inserted in front of the specified class.

Commands Available in Policy-map-class (qos) Configuration Mode

- **set (policy-map-class (qos) Trident)**
- **exit** saves pending class changes and returns switch to **policy-map (qos)** configuration mode.
- **abort** discards pending class changes and returns switch to **policy-map (qos)** configuration mode.

Related Commands

- **class-map type qos** places switch in **class-map (qos)** configuration mode.
- **policy-map type quality-of-service** places switch in **policy-map (qos)** configuration mode

Example

These commands add the **CMAP_1** class map to the **PMAP_1** policy map, then places the switch in **policy-map-class** configuration mode.

```
switch(config)#policy-map type quality-of-service PMAP-1
switch(config-pmap-PMAP-1)#class CMAP-1
```

```
switch(config-pmap-c-PMAP-1-CMAP-1) #
```

9.2.7.18 class-map type copp

The `class-map type copp` command places the switch in Class-Map (control plane) configuration mode, which is a group change mode that modifies a control-plane dynamic class map. A dynamic class map is a data structure that uses access control lists (ACLs) to define a data stream by specifying characteristics of data packets that comprise that stream. Control-plane policy maps use class maps to specify which control plane traffic is controlled by policy map criteria.

The `exit` command saves pending class map changes to **running-config** and returns the switch to global configuration mode. Class map changes are also saved by entering a different configuration mode. The `abort` command discards pending changes and returns the switch to global configuration mode.

The `no class-map type copp` and `default class-map type copp` commands delete the specified class map by removing the corresponding `class-map type copp` command and its associated configuration.

Command Mode

Global Configuration

Command Syntax

```
class-map type copp match-any class_name
no class-map type copp [match-any] class_name
default class-map type copp [match-any] class_name
```

Parameters

class_name Name of class map.

Commands Available in Class-Map (Control Plane) Configuration Mode

- [match \(class-map \(control-plane\) Trident\)](#)

Related Commands

- [policy-map type copp](#)
- [class \(policy-map \(control-plane\) Trident\)](#)
- [class-map type qos](#)

Example

This command creates the control plane class map named **CP-MAP-1** and places the switch in **class-map** configuration mode.

```
switch(config)#class-map type copp match-any CP-CMAP-1
switch(config-cmap-CP-CMAP-1)#
```

9.2.7.19 class-map type pbr

The `class-map type pbr` command places the switch in class-map (pbr) configuration mode for the specified class map, and creates the class map if one does not already exist. Class-map (pbr) configuration mode is a group change mode that modifies a class map for Policy-Based Routing (PBR). PBR class maps contain one or more **match** statements which filter incoming traffic using ACLs. PBRs can then use these class maps to set next-hop IP addresses for the traffic that matches them. (Classes without set commands translate to no action being performed on that class of packets.)

The `exit` command saves pending class map changes to **running-config**, then returns the switch to global configuration mode. Class map changes are also saved by directly entering a different configuration mode. The `abort` command discards pending changes and returns the switch to global configuration mode.

The `no class-map type pbr` and `default class-map type pbr` commands delete the specified class map by removing the corresponding `class-map type pbr` command and its associated configuration.

Command Mode

Global Configuration

Command Syntax

```
class-map type pbr match-any map_name
no class-map type pbr match-any map_name
default class-map type pbr match-any map_name
```

Parameters

map_name Name of class map.

Commands Available in Class-Map (PBR) configuration mode

- [match \(class-map \(pbr\)\)](#)
- [resequence \(class-map \(pbr\)\)](#)

Related Commands

- [policy-map type pbr](#)
- [class \(policy-map \(pbr\)\)](#)

Example

This command creates the PBR class map named **MAP1** and places the switch in **class-map (pbr)** configuration mode where match criteria can be configured for the class.

```
switch(config)#class-map type pbrmatch-any MAP1
switch(config-cmap-MAP1)#
```

9.2.7.20 class-map type qos

The **class-map type qos** command places the switch in Class-Map (qos) configuration mode, which is a group change mode that modifies a QoS dynamic class map. A dynamic class map is a data structure that uses access control lists (ACLs) to define a data stream by specifying characteristics of data packets that comprise that stream. QoS policy maps use class maps to specify the traffic (to which the policy map is assigned) that is transformed by policy map criteria.

The **exit** command saves pending class map changes to **running-config**, then returns the switch to global configuration mode. Class map changes are also saved by entering a different configuration mode. The **abort** command discards pending changes and returns the switch to global configuration mode.

The **no class-map type qos** and **default class-map type qos** commands delete the specified class map by removing the corresponding **class-map type qos** command and its associated configuration. The **class-map** and **class-map type qos** commands are equivalent.

Command Mode

Global Configuration

Command Syntax

```
class-map [type qos] match-any class_name
```

```
no class-map [type qos] match-any class_name
```

```
default class-map [type qos] match-any class_name
```

Parameters

- **class_name** Name of class map.

Commands Available in Class-Map (QoS) Configuration Mode

- [match \(class-map \(qos\) FM6000\)](#)
- [match \(class-map \(qos\) Trident\)](#)

Conditions

class-map map_name and **class-map type qos map_name** are identical commands.

Related Commands

- [policy-map type quality-of-service](#)
- [class \(policy-map \(qos\) FM6000\)](#)
- [class \(policy-map \(qos\) Trident\)](#)

Example

This command creates the QoS class map named **MAP-1** and places the switch in **class-map** configuration mode.

```
switch(config)#class-map type qos match-any MAP-1
switch(config-cmap-MAP-1)#
```

9.2.7.21 clear policy-map counters

The `clear policy-map` command resets the specified policy map counters to zero. Policy map counters record the quantity of packets that are filtered by the ACLs that comprise a specified policy map.

Command Mode

Privileged EXEC

Command Syntax

```
clear policy-map INTERFACE_NAME counters MAP_NAME
```

Parameters

- **INTERFACE_NAME** Interface for which command clears table counters. Options include:
 - **interface control-plane** Control plane.
- **MAP_NAME** Policy map for which command clears counters. Options include:
 - **copp-system-policy** Name of only policy map supported for the control plane.

9.2.7.22 feature traffic-policy cpu (ipv4 | ipv6)

The **feature traffic-policy cpu** command configures the CPU traffic policy features for the IPv4 and IPv6 traffic in user-defined TCAM profile.

The **no feature traffic-policy cpu** and **default feature traffic-policy cpu** commands remove the CPU policy configurations from *running-config*.

Command Mode

Hardware TCAM

Command Syntax

```
feature traffic-policy cpu <ipv4 | ipv6>
```

```
no feature traffic-policy cpu <ipv4 | ipv6>
```

```
default feature traffic-policy cpu <ipv4 | ipv6>
```

Parameters

- **ipv4** CPU traffic policy for IPv4 traffic.
- **ipv6** CPU traffic policy for IPv6 traffic.

Example

These commands places the switch in the hardware TCAM profile mode and configures the CPU traffic policy features for IPv4 traffic in the TCAM profile test.

```
switch(config)#hardware tcam  
switch(config-hw-tcam)#profile test  
switch(config-hw-tcam-profile-test)#feature traffic-policy cpu ipv4
```

9.2.7.23 match (class-map (control-plane) Helix)

The **match** command assigns an ACL to the configuration mode class map. A class map can contain only one ACL. Class maps only use permit rules to filter data; deny rules are ignored. The command accepts IPv4 and IPv4 standard ACLs.

A class map is assigned to a policy map by the **class (policy-map (control-plane) Helix)** command.

Class map (control plane) configuration mode is a group change mode. **Match** statements are not saved to **running-config** until the edit session is completed by exiting the mode.

The **no match** and **default match** commands remove the **match** statement from the configuration mode class map by deleting the corresponding command from **running-config**.

Command Mode

Class-Map (control plane) configuration accessed through **class-map type copp** command.

Command Syntax

```
match ip access-group list_name
no match ip access-group list_name
default match ip access-group list_name
```

Parameters

list_name name of ACL assigned to class map.

Related Commands

- **class-map type copp** places the switch in Class-Map configuration mode.
- **exit** saves pending class map changes, then returns the switch to global configuration mode.
- **abort** discards pending class map changes, then returns the switch to global configuration mode.
- **class (policy-map (control-plane) Helix)** assigns a **class map** to a **policy map**.

Guidelines

Static class maps cannot be modified by this command.

Match statements are saved to **running-config** only upon exiting **Class-Map (control plane)** configuration mode.

Example

These commands add the IP ACL **list_1** to the **map_1** class map, then saves the command by exiting **class-map** mode.

```
switch(config)#class-map type copp map_1
switch(config-cmap-map_1)#match ip access-group list_1
switch(config-cmap-map_1)#exit
switch(config)#
```

9.2.7.24 match (class-map (control-plane) Trident II)

The **match** command assigns an ACL to the configuration mode class map. A class map can contain only one ACL. Class maps only use permit rules to filter data; deny rules are ignored. The command accepts IPv4 and IPv4 standard ACLs.

A class map is assigned to a policy map by the **class (policy-map (control-plane) Trident II)** command.

Class map (control plane) configuration mode is a group change mode. **Match** statements are not saved to **running-config** until the edit session is completed by exiting the mode.

The **no match** and **default match** commands remove the **match** statement from the configuration mode class map by deleting the corresponding command from **running-config**.

Command Mode

Class-Map (control plane) configuration accessed through **class-map type copp** command.

Command Syntax

list_name

list_name

list_name

Parameters

list_name name of ACL assigned to class map.

Related Commands

- **class-map type copp** places the switch in Class-Map configuration mode.
- **exit** saves pending class map changes, then returns the switch to global configuration mode.
- **abort** discards pending class map changes, then returns the switch to global configuration mode.
- **class (policy-map (control-plane) Trident II)** assigns a class map to a **policy map**.

Guidelines

Static class maps cannot be modified by this command.

Match statements are saved to **running-config** only upon exiting **Class-Map (control plane)** configuration mode.

Example

These commands add the IP ACL **list_1** to the **map_1** class map, then saves the command by exiting **class-map** mode.

```
switch(config)#class-map type copp map_1
switch(config-cmap-map_1)#match ip access-group list_1
switch(config-cmap-map_1)#exit
switch(config)#
```

9.2.7.25 match (class-map (control-plane) Trident)

The **match** command assigns an ACL to the configuration mode class map. A class map can contain only one ACL. Class maps only use permit rules to filter data; deny rules are ignored. The command accepts IPv4, IPv6, IPv4 standard, and IPv6 standard ACLs.

A class map is assigned to a policy map by the **class (policy-map (control-plane) Trident)** command.

Class map (control plane) configuration mode is a group change mode. **Match** statements are not saved to **running-config** until the edit session is completed by exiting the mode.

The **no match** and **default match** commands remove the **match** statement from the configuration mode class map by deleting the corresponding command from **running-config**.

Command Mode

Class-Map (control plane) configuration

accessed through **class-map type copp** command

Command Syntax

```
match IP_VERSION access-group list_name
```

```
no match IP_VERSION access-group list_name
```

```
default match IP_VERSION access-group list_name
```

Parameters

- **IP_VERSION** IP version of the specified ACL. Options include:
 - **ipv4** IPv4.
 - **ipv6** IPv6.
- **list_name** name of ACL assigned to class map.

Related Commands

- **class-map type copp** places the switch in **Class-Map** configuration mode.
- **exit** saves pending class map changes, then returns the switch to global configuration mode.
- **abort** discards pending class map changes, then returns the switch to global configuration mode.
- **class (policy-map (control-plane) Trident)** assigns a class map to a policy map.

Guidelines

Static class maps cannot be modified by this command.

Match statements are saved to **running-config** only upon exiting **Class-Map (control plane)** configuration mode.

Example

These commands add the IPv4 ACL names **list_1** to the **map_1** class map, then saves the command by exiting **class-map** mode.

```
switch(config)#class-map type copp map_1
switch(config-cmap-map_1)#match ip access-group list_1
switch(config-cmap-map_1)#exit
switch(config)#
```

9.2.7.26 match (class-map (pbr))

The **match** command assigns ACLs to the configuration mode Policy-Based Routing (PBR) class map. The command accepts IPv4, IPv4 standard, IPv6 and IPv6 standard ACLs.

Class map (pbr) configuration mode is a group change mode. **Match** statements are not saved to **running-config** until the edit session is completed by exiting the mode.

The **no match** and **default match** commands remove the **match** statement from the configuration mode class map by deleting the corresponding command from **running-config**.

 **Note:** PBR ACLs use only permit rules to filter data; if there are deny rules in an ACL used by PBR, the configuration will be reverted.

Command Mode

Class-map (pbr) configuration accessed through **class-map type pbr** command.

Command Syntax

```
[sequence_number] match {ip|ipv6} access-group list_name
no [sequence_number] match {ip|ipv6} access-group list_name
default [sequence_number] match {ip|ipv6} access-group list_name
no [sequence_number]
default [sequence_number]
```

Parameters

- **sequence_number** Sequence number (1 to 4294967295) assigned to the rule. If no number is entered, the number is derived by adding 10 to the number of the class maps last numbered line. To increase the distance between existing entries, use the **resequence** command.
- **list_name** name of ACL assigned to class map.

Related Commands

- **class-map type pbr** places the switch in class-map configuration mode.
- **exit** saves pending class map changes, then returns the switch to global configuration mode.
- **abort** discards pending class map changes, then returns the switch to global configuration mode.
- **class (policy-map (pbr))** assigns a class map to a policy map.

Example

These commands add the IPv4 ACL named **list1** to the **map1** class map, then save the change by exiting **class-map** mode.

```
switch(config)#class-map type pbr map1
switch(config-cmap-map1)#match ip access-group list1
switch(config-cmap-map1)#exit
switch(config)#
```

9.2.7.27 match (class-map (qos) FM6000)

The **match** command assigns an ACL to the configuration mode class map. A class map can contain only one ACL. Class maps only use permit rules to filter data; deny rules are ignored. The command accepts IPv4 and IPv4 standard ACLs.

Class map (qos) configuration mode is a group change mode. **Match** statements are not saved to **running-config** until the edit session is completed by exiting the mode.

The **no match** and **default match** commands remove the **match** statement from the configuration mode class map by deleting the corresponding command from **running-config**.

Command Mode

Class-map (qos) configuration accessed through **class-map type qos** command.

Command Syntax

```
match IP_VERSION access-group list_name
no match IP_VERSION access-group list_name
default match IP_VERSION access-group list_name
```

Parameters

- **IP_VERSION** IP version of the specified ACL. Options include:
 - **ipv4** IPv4.
- **list_name** name of ACL assigned to class map.

Related Commands

- **class-map type qos** places the switch in Class-Map configuration mode.
- **exit** saves pending class map changes, then returns the switch to global configuration mode.
- **abort** discards pending class map changes, then returns the switch to global configuration mode.
- **class (policy-map (qos) FM6000)** assigns a **class map** to a **policy map**.

Example

These commands add the IPv4 ACL named **list_1** to the **map_1** class map, then saves the command by exiting **class-map** mode.

```
switch(config)#class-map type qos map_1
switch(config-cmap-map_1)#match ip access-group list_1
switch(config-cmap-map_1)#exit
switch(config)#
```

9.2.7.28 match (class-map (qos) Helix)

The **match** command assigns an ACL to the configuration mode class map. A class map can contain only one ACL. Class maps only use permit rules to filter data; deny rules are ignored. The command accepts IPv4, IPv4 standard, IPv6, and IPv6 standard ACLs.

Class map (qos) configuration mode is a group change mode. **Match** statements are not saved to **running-config** until the edit session is completed by exiting the mode.

The **no match** and **default match** commands remove the **match** statement from the configuration mode class map by deleting the corresponding command from **running-config**.

Command Mode

Class-Map (qos) configuration accessed through **class-map type qos** command.

Command Syntax

```
match IP_VERSION access-group list_name
```

```
no match IP_VERSION access-group list_name
```

```
default match IP_VERSION access-group list_name
```

Parameters

- **IP_VERSION** IP version of the specified ACL. Options include:
 - **ipv4** IPv4.
 - **ipv6** IPv6.
- **list_name** name of ACL assigned to class map.

Related Commands

- **class-map type qos** places the switch in Class-Map configuration mode.
- **exit** saves pending class map changes, then returns the switch to global configuration mode.
- **abort** discards pending class map changes, then returns the switch to global configuration mode.
- **class (policy-map (qos) Helix)** assigns a class map to a policy map.

Example

These commands add the IPv4 ACL named **list_1** to the **map_1** class map, then saves the command by exiting **class-map** mode.

```
switch(config)#class-map type qos map_1
switch(config-cmap-map_1)#match ip access-group list_1
switch(config-cmap-map_1)#exit
switch(config)#
```

9.2.7.29 match (class-map (qos) Trident II)

The **match** command assigns an ACL to the configuration mode class map. A class map can contain only one ACL. Class maps only use permit rules to filter data; deny rules are ignored. The command accepts IPv4, IPv4 standard, IPv6, and IPv6 standard ACLs.

Class map (qos) configuration mode is a group change mode. **Match** statements are not saved to **running-config** until the edit session is completed by exiting the mode.

The **no match** and **default match** commands remove the **match** statement from the configuration mode class map by deleting the corresponding command from **running-config**.

Command Mode

Class-Map (qos) configuration accessed through **class-map type qos** command.

Command Syntax

IP_VERSION *list_name*

IP_VERSION *list_name*

IP_VERSION *list_name*

Parameters

- **IP_VERSION** IP version of the specified ACL. Options include:
 - **ipv4** IPv4.
 - **ipv6** IPv6.
- **list_name** name of ACL assigned to class map.

Related Commands

- **class-map type qos** places the switch in Class-Map configuration mode.
- **exit** saves pending class map changes, then returns the switch to global configuration mode.
- **abort** discards pending class map changes, then returns the switch to global configuration mode.
- **class (policy-map (qos) Trident)** assigns a class map to a policy map.

Example

These commands add the IPv4 ACL named **list_1** to the **map_1** class map, then saves the command by exiting **class-map** mode.

```
switch(config)#class-map type qos map_1
switch(config-cmap-map_1)#match ip access-group list_1
switch(config-cmap-map_1)#exit
switch(config)#
```

9.2.7.30 match (class-map (qos) Trident)

The **match** command assigns an ACL to the configuration mode class map. A class map can contain only one ACL. Class maps only use permit rules to filter data; deny rules are ignored. The command accepts IPv4, IPv4 standard, IPv6, and IPv6 standard ACLs.

Class map (qos) configuration mode is a group change mode. **Match** statements are not saved to **running-config** until the edit session is completed by exiting the mode.

The **no match** and **default match** commands remove the **match** statement from the configuration mode class map by deleting the corresponding command from **running-config**.

Command Mode

Class-Map (qos) configuration accessed through **class-map type qos** command.

Command Syntax

```
match IP_VERSION access-group list_name
```

```
no match IP_VERSION access-group list_name
```

```
default match IP_VERSION access-group list_name
```

Parameters

- **IP_VERSION** IP version of the specified ACL. Options include:
 - **ipv4** IPv4.
 - **ipv6** IPv6.
- **list_name** name of ACL assigned to class map.

Related Commands

- **class-map type qos** places the switch in Class-Map configuration mode.
- **exit** saves pending class map changes, then returns the switch to global configuration mode.
- **abort** discards pending class map changes, then returns the switch to global configuration mode.
- **class (policy-map (qos) Trident)** assigns a **class map** to a **policy map**.

Example

These commands add the IPv4 ACL named **list_1** to the **map_1** class map, then saves the command by exiting **class-map** mode.

```
switch(config)#class-map type qos map_1
switch(config-cmap-map_1)#match ip access-group list_1
switch(config-cmap-map_1)#exit
switch(config)#
```

9.2.7.31 match (policy-map (pbr))

The **match** command creates a policy map clause entry that specifies one filtering condition. When a packet matches the filtering criteria, its next hop is set as specified. When a packets properties do not equal the statement parameters, the packet is evaluated against the next clause or class map in the policy map, as determined by sequence number. If all clauses fail to set a next hop for the packet, the packet is routed according to the FIB.

The **no match** and **default match** commands remove the **match** statement from the configuration mode policy map by deleting the corresponding command from *running-config*.

Command Mode

Policy-Map (pbr) Configuration accessed through **policy-map type pbr** command.

Command Syntax

```
[sequence_number] match ip SOURCE_ADDR DEST_ADDR [set nexthop [recursive] NH-addr_1 [NH-addr_2] ... [NH-addr_n]]
```

```
no match ip SOURCE_ADDR DEST_ADDR [set nexthop [recursive] NH-addr_1 [NH-addr_2] ... [NH-addr_n]]
```

```
default match match ip SOURCE_ADDR DEST_ADDR [set nexthop [recursive] NH-addr_1 [NH-addr_2] ... [NH-addr_n]]
```

```
no SEQ_NUM
```

```
default SEQ_NUM
```

Parameters

- **sequence_number** Sequence number assigned to the rule. If no number is entered, the number is derived by adding 10 to the number of the policy maps last numbered line. To increase the distance between existing entries, use the **resequence** command.
- **SOURCE_ADDR** and **DEST_ADDR** source and destination address filters. Options include:
 - **network_addr** subnet address (CIDR or address-mask).
 - **any** packets from or to all addresses are matched.
 - **host ip_addr** IP address (dotted decimal notation).Source and destination subnet addresses support discontinuous masks.
- **recursive** enables recursive next hop resolution.
- **NH_addr** IP address of next hop. If multiple addresses are entered, they are treated as an ECMP group.

Related Commands

- **policy-map type pbr** enters policy-map (PBR) configuration mode.
- **show policy-map type pbr** displays PBR policy maps.

Example

These commands create a match rule in policy map **PMAP1** which sets the next hop to **192.168.3.5** for packets received from **172.16.0.0/12** regardless of their destination, then exit the mode to save the changes.

```
switch(config)#policy-map type pbr PMAP1
switch(config-pmap-PMAP1)#match ip 172.16.0.0/12 any set nexthop
192.163.3.5
switch(config-pmap-PMAP1)#exit
switch(config)#
```

9.2.7.32 platform arad tcam counters feature

The **platform arad tcam counters feature** command enables incrementing PBR hardware counters corresponding to ACL. If counters for PBR are enabled, then counters for ACL will be automatically disabled in all cases. If counters for ACL are enabled, then counters for PBR will be automatically disabled in all cases.

The **no platform arad tcam counters feature** command disables PBR/ACL counters selection. The **default platform arad tcam counters feature** commands resets the default behavior.

Command Mode

Global Configuration

Command Syntax

```
platform arad tcam counters feature [OPTIONS]
no platform arad tcam counters feature [OPTIONS]
default platform arad tcam counters feature [OPTIONS]
```

Parameters

- **OPTIONS** Assign the TCAM counters feature. Options include:
 - **pbr** assign the TCAM counters feature PBR hardware counters.
 - **acl** assign the TCAM counters feature ACL hardware counters.

Example

- This command enables incrementing ACL hardware counters selection.

```
switch(config)#platform arad tcam counters feature acl
switch(config)#
```

- This command disables incrementing ACL hardware counters selection.

```
switch(config)#no platform arad tcam counters feature acl
switch(config)#
```

9.2.7.33 policy-map type copp

The `policy-map type copp` command places the switch in Policy-Map (control plane) configuration mode, which is a group change mode that modifies a control-plane policy map. A policy map is a data structure that consists of class maps that identify a specific data stream and specify bandwidth and shaping parameters that controls its transmission. Control plane policy maps are applied to the control plane to manage traffic.

The `copp-system-policy` policy map is supplied with the switch and is always applied to the control plane. `Copp-system-policy` is the only valid control plane policy map.

The `exit` command saves pending policy map changes to `running-config` and returns the switch to global configuration mode. Policy map changes are also saved by entering a different configuration mode. The `abort` command discards pending changes, returning the switch to global configuration mode.

The `no policy-map type copp` and `default policy-map type copp` commands delete the specified policy map by removing the corresponding `policy-map type copp` command and its associated configuration.

Command Mode

Global Configuration

Command Syntax

```
policy-map type copp copp-system-policy
```

```
no policy-map type copp copp-system-policy
```

```
default policy-map type copp copp-system-policy
```

`copp-system-policy` is supplied with the switch and is the only valid control plane policy map.

Commands Available in Policy-Map Configuration Mode

- [class \(policy-map \(control-plane\) FM6000\)](#)
- [class \(policy-map \(control-plane\) Trident\)](#)

Related Commands

[class-map type copp](#) enters control-plane class-map configuration mode for modifying a control-plane dynamic class map.

Only Helix and Trident platform switches support dynamic classes for control plane policing.

Example

This command places the switch in policy-map configuration mode to edit the `copp-system-policy` policy map.

```
switch(config)#policy-map type copp copp-system-policy
switch(config-pmap-copp-system-policy)#
```

9.2.7.34 policy-map type pbr

The **policy-map type pbr** command places the switch in policy-map (pbr) configuration mode, which is a group change mode that modifies a Policy-Based Routing (PBR) policy map. The command also creates the specified policy map if it does not already exist. A PBR policy map is a data structure that consists of class maps that identify specific packets and the next hops for those packets. Policy maps are applied to Ethernet or port channel interfaces to manage traffic.

The **exit** command saves pending policy map changes to **running-config** and returns the switch to global configuration mode. Policy map changes are also saved by entering a different configuration mode. The **abort** command discards pending changes, returning the switch to global configuration mode.

The **no policy-map type pbr** and **default policy-map type pbr** commands delete the specified policy map by removing the corresponding **policy-map type pbr** command and its associated configuration.

Command Mode

Global Configuration

Command Syntax

```
policy-map type pbr map_name
```

```
no policy-map type pbr map_name
```

```
default policy-map type pbr map_name
```

Parameters

map_name Name of policy map.

Commands Available in Policy-Map configuration mode

- [class \(policy-map \(pbr\)\)](#)
- [match \(policy-map \(pbr\)\)](#)

Related Commands

- [class-map type pbr](#)
- [service-policy type pbr \(Interface mode\)](#)

Example

This command creates the PBR policy map named PMAP1 and places the switch in policy-map configuration mode.

```
switch(config)#policy-map type pbr PMAP1
switch(config-pmap-PMAP1)#
```

9.2.7.35 policy-map type pdp

The **policy-map type pdp** command places the switch in policy-map (pdp) configuration mode, which is a group change mode that modifies a Per-port Denial-of-service Protection (PDP) policy map. The command also creates the specified policy map if it does not already exist.

The **exit** command saves pending policy map changes to **running-config** and returns the switch to global configuration mode. Policy map changes are also saved by entering a different configuration mode. The **abort** command discards pending changes, returning the switch to global configuration mode.

The **no policy-map type pdp** and **default policy-map type pdp** commands delete the specified policy map by removing the corresponding **policy-map type pdp** command and its associated configuration.



Note:

PDP is available only in EOS versions 4.19.0F and above.

Command Mode

Global Configuration

Command Syntax

```
policy-map type pdp [shared] map_name
```

```
no policy-map type pdp [shared] map_name
```

```
default policy-map type pdp [shared] map_name
```

Parameters

- **shared** optional keyword designating a shared policy map.
- *map_name* name of policy map.

Example

- This command creates the unshared PDP policy map named PMAP1 and places the switch in policy-map configuration mode.

```
switch(config)#policy-map type pdp PMAP1  
switch(config-pmap-PMAP1)#
```

9.2.7.36 policy-map type quality-of-service

The **policy-map type quality-of-service** command places the switch in Policy-Map (qos) configuration mode, which is a group change mode that modifies a QoS policy map. A policy map is a data structure that consists of class maps that identify a specific data stream and shaping parameters that controls its transmission. Policy maps are applied to Ethernet or port channel interfaces to manage traffic.

The **exit** command saves pending policy map changes to **running-config** and returns the switch to global configuration mode. Policy map changes are also saved by entering a different configuration mode. The **abort** command discards pending changes, returning the switch to global configuration mode.

The **no policy-map type quality-of-service** and **default policy-map type quality-of-service** commands delete the specified policy map by removing the corresponding **policy-map type quality-of-service** command and its associated configuration. The **policy-map** and **policy-map type quality-of-service** commands are equivalent.

Command Mode

Global Configuration

Command Syntax

```
policy-map type quality-of-service map_name  
no policy-map type quality-of-service map_name  
default policy-map type quality-of-service map_name
```

Parameters

map_name Name of policy map.

Commands Available in Policy-Map Configuration Mode

- [class \(policy-map \(qos\) FM6000\)](#)
- [class \(policy-map \(qos\) Trident\)](#)

Conditions

policy-map map_name and **policy-map type quality-of-service map_name** are identical commands.

Related Commands

- [class-map type qos](#)
- [service-policy type qos \(Interface mode\)](#)

Example

This command creates the QoS policy map named **PMAP-1** and places the switch in **policy-map** configuration mode.

```
switch(config)#policy-map PMAP-1  
switch(config-pmap-PMAP-1)#
```

9.2.7.37 resequence (class-map (pbr))

The **resequence** command assigns sequence numbers to rules in the configuration mode class map. Command parameters specify the number of the first rule and the numeric interval between consecutive rules. Once changed, rule numbers persist unless changed again using the **resequence** command, but the interval used for numbering new rules reverts to 10 on exiting class-map (pbr) configuration mode.

Maximum rule sequence number is **4294967295**.

Command Mode

Class-Map (PBR) Configuration accessed through **class-map type pbr** command.

Command Syntax

```
resequence [start_num [inc_num]]
```

Parameters

- **start_num** sequence number assigned to the first rule. Default is 10.
- **inc_num** numeric interval between consecutive rules. Default is 10.

Example

The **resequence** command renumbers the rules in CMAP1, starting the first command at number 100 and incrementing subsequent lines by 20.

```
switch(config)#class-map type pbr match-any CMAP1
switch(config-cmap-CMAP1)#show active
class-map type pbr match-any CMAP1
10 match ip access-group group1
20 match ip access-group group2
30 match ip access-group group3
switch(config-cmap-CMAP1)#resequence 100 20
switch(config-cmap-CMAP1)#exit
switch(config)#class-map type pbr match-any CMAP1
switch(config-cmap-CMAP1)#show active
class-map type pbr match-any CMAP1
100 match ip access-group group1
120 match ip access-group group2
140 match ip access-group group3
```

9.2.7.38 resequence (policy-map (pbr))

The **resequence** command assigns sequence numbers to rules in the configuration mode policy map. Command parameters specify the number of the first rule and the numeric interval between consecutive rules. Once changed, rule numbers persist unless changed again using the **resequence** command, but the interval used for numbering new rules reverts to 10 on exiting policy-map (pbr) configuration mode.

Maximum rule sequence number is 4294967295.

Command Mode

Policy-Map (PBR) Configuration

accessed through **policy-map type pbr** command

Command Syntax

```
resequence [start_num [inc_num]]
```

Parameters

- *start_num* sequence number assigned to the first rule. Default is 10.
- *inc_num* numeric interval between consecutive rules. Default is 10.

Example

- The **resequence** command renumbers the rules in PMAP1, starting the first command at number 100 and incrementing subsequent lines by 20.

```
switch(config)#policy-map type pbr PMAP1
switch(config-pmap-PMAP1)#show active
policy-map type pbr PMAP1
10 class CMAP1
set nexthop 172.16.1.1
20 class CMAP2
set nexthop 172.16.2.2
30 class CMAP3
set nexthop 172.16.3.3
switch(config-pmap-PMAP1)#resequence 100 20
switch(config-pmap-PMAP1)#exit
switch(config)#policy-map type pbr PMAP1
switch(config-pmap-PMAP1)#show active
class-map type pbr PMAP1
100 class CMAP1
set nexthop 172.16.1.1
120 class CMAP2
set nexthop 172.16.2.2
140 class CMAP3
set nexthop 172.16.3.3
switch(config-pmap-PMAP1)#
```

9.2.7.39 service-policy type pbr (Interface mode)

The `service-policy pbr` command applies the specified Policy-Based Routing (PBR) policy map to the configuration mode interface. A PBR policy map is a data structure that consists of class maps that identify specific packets and the next hops for those packets. Policy maps are applied to Ethernet or port channel interfaces to manage traffic. Only one service policy is supported per interface.

The `no service-policy pbr` and `default service-policy pbr` commands remove the service policy assignment from the configuration mode interface by deleting the corresponding `service-policy pbr` command from *running-config*.

Command Mode

Interface-Ethernet Configuration

Interface-Port-Channel Configuration

Interface-VLAN Configuration

Command Syntax

```
service-policy type pbr TRAFFIC_DIRECTION map_name
```

```
no service-policy type pbr TRAFFIC_DIRECTION map_name
```

```
default service-policy type pbr TRAFFIC_DIRECTION map_name
```

Parameters

- **TRAFFIC_DIRECTION** IP address or peer group name. Values include:
 - **input** Policy map applies to inbound packet streams.
- **map_name** Name of policy map.

Guidelines

A policy map that is attached to a port channel interface takes precedence for member interfaces of the port channel over their individual interface Ethernet configuration. Members that are removed from a port channel revert to the policy map implementation specified by its interface Ethernet configuration.

Related Commands

[policy-map type pbr](#)

Example

This command applies the PBR policy map *PMAP1* to *interface Ethernet 8*.

```
switch#config
switch(config)#interface ethernet 8
switch(config-if-Et8)#service-policy type pbr input PMAP1
switch(config-if-Et8)#
```

9.2.7.40 service-policy type pdp (Interface mode)

The **service-policy pdp** command assigns the specified Per-port Denial-of-service (PDP) policy map to the configuration mode interface.

The **no service-policy pdp** and **default service-policy pdp** commands remove the service policy assignment from the configuration mode interface by deleting the corresponding **service-policy pdp** command from *running-config*.

**Note:**

PDP is available only in EOS versions 4.19.0F and above.

Command Mode

Interface-Ethernet Configuration

Command Syntax

```
service-policy type pdp input map_name
```

```
no service-policy pdp input map_name
```

```
default service-policy pdp input map_name
```

Parameters

- *map_name* name of policy map.

Example

- This command assigns the PDP policy map PMAP1 to Ethernet interface 8.

```
switch#config
switch(config)#interface ethernet 8
switch(config-if-Et8)#service-policy type pdp input PMAP1
switch(config-if-Et8)#
```

9.2.7.41 service-policy type qos (Interface mode)

The **service-policy** command applies a specified policy map to the configuration mode interface. A policy map is a data structure that identifies data traffic through class maps, then specifies actions to classify the traffic (by setting the traffic class), mark the traffic (by setting the cos and dscp values), and police the traffic (by setting the police rate) through data packet field modifications.

The **no service-policy** and **default service-policy** commands remove the service policy assignment from the configuration mode interface by deleting the corresponding **service-policy** command from *running-config*.

Command Mode

Interface-Ethernet Configuration

Interface-Port-Channel Configuration

Interface-VLAN Configuration

Command Syntax

```
service-policy [type qos] TRAFFIC_DIRECTION map_name
```

```
no service-policy [type qos] TRAFFIC_DIRECTION map_name
```

```
default service-policy [type qos] TRAFFIC_DIRECTION map_name
```

Parameters

- **type qos** Parameter has no functional effect.
- **TRAFFIC_DIRECTION** Direction of data stream to which command applies. Options include:
 - **input** Policy map applies to inbound packet streams.
- **map_name** Name of policy map.

Guidelines

A policy map that is attached to a port channel interface takes precedence for member interfaces of the port channel over their individual interface Ethernet configuration. Members that are removed from a port channel revert to the policy map implementation specified by its interface Ethernet configuration.

DCS-7500E and DCS-7280E limitations:

- A maximum of **31** QoS service policies per chip may be applied on L3 interfaces.
- Applying different QoS service policies to an SVI and its member interfaces causes unpredictable behavior.
- When an SVI on which QoS service policies are applied experiences partial failure due to limited hardware resources, a forwarding agent restart will cause unpredictable behavior.
- Policy-map programming may fail when QoS service policies are applied on two SVIs if an event causes a member interface to switch membership from one to the other. To change the VLAN membership of an interface in this case, remove the interface from one VLAN before adding it to the other.
- Outgoing COS rewrite is not supported.
- QoS policy-map counters are not supported.

DCS-7010, DCS-7050, DCS-7050X, DCS-7250X, and DCS-7300X limitations:

- When the same policy map is applied to multiple SVIs, TCAM resources are not shared.
- A policy map applied to an SVI results in TCAM allocation on all chips whether SVI members are present or not.
- Applying different QoS service policies to an SVI and its member interfaces causes unpredictable behavior.

Related Commands

[policy-map type quality-of-service](#)**Example**

This command applies the *PMAP-1* policy map to *interface Ethernet 8*.

```
switch#config
switch(config)#interface ethernet 8
switch(config-if-Et8)#show active
switch(config-if-Et8)#service-policy input PMAP-1
switch(config-if-Et8)#show active
interface Ethernet8
    service-policy type qos input PMAP-1
switch(config-if-Et8)#
```

9.2.7.42 set (policy-map-class (qos) FM6000)

The **set** command specifies traffic resolution methods for traffic defined by its associated class map in its configuration mode policy map class. Three set statements are available for each class:

- **cos** Sets the Layer 2 class of service field.
- **dscp** Sets the differentiated services code point value in the type of service (ToS) byte.
- **traffic-class** Sets the traffic class queue for data packets.

Each type of set command can be assigned to a class, allowing for the simultaneous modification of both (cos, dscp) fields and assignment to a traffic class.

The **no set** and **default set** commands remove the specified data action from the class map by deleting the associated **set** command from *running-config*.

Command Mode

Policy-map-class (qos) configuration

accessed through **class (policy-map (qos) FM6000)** command

Command Syntax

```
set QOS_TYPE value
```

```
no set QOS_TYPE
```

```
default set QOS_TYPE
```

Parameters

- **QOS_TYPE** Specifies the data stream resolution method. Valid options include:
 - **cos** Layer 2 class of service field of outbound packet is modified.
 - **dscp** Differentiated services code point value in the ToS byte is modified.
 - **traffic-class** Data stream is assigned to a traffic class queue.
- **value** Specifies the data field value or traffic class queue. Valid data range depends on **QOS_TYPE**.
 - **QOS_TYPE** is **cos** Value ranges from **0** to **7**.
 - **QOS_TYPE** is **dscp** Value ranges from **0** to **63**.
 - **QOS_TYPE** is **traffic-class** Value ranges from **0** to **7**.

Related Commands

- [policy-map type quality-of-service](#)
- [class \(policy-map \(qos\) FM6000\)](#)

Example

These commands configure the policy map to set **CoS field 7** to data traffic specified by the class map **CMAP-1**, then assigns that data to traffic class **queue 4**.

```
switch(config)#policy-map type quality-of-service PMAP-1
switch(config-pmap-PMAP-1)#class CMAP-1
switch(config-pmap-c-PMAP-1-CMAP-1)#set cos 7
switch(config-pmap-c-PMAP-1-CMAP-1)#set traffic-class 4
switch(config-pmap-c-PMAP-1-CMAP-1)#
```

9.2.7.43 set (policy-map-class (qos) Helix)

The **set** command specifies traffic resolution methods for traffic defined by its associated class map in its configuration mode policy map class. Three set statements are available for each class:

- **cos** Sets the layer 2 class of service field.
- **dscp** Sets the differentiated services code point value in the type of service (ToS) byte.
- **traffic-class** Sets the traffic class queue for data packets.

Each type of set command can be assigned to a class, allowing for the simultaneous modification of both (**cos**, **dscp**) fields and assignment to a traffic class.

The **no set** and **default set** commands remove the specified data action from the class map by deleting the associated **set** command from *running-config*.

Command Mode

Policy-map-class (qos) configuration accessed through **class (policy-map (qos) Helix)** command.

Command Syntax

```
set QOS_TYPE value
```

```
no set QOS_TYPE
```

```
default set QOS_TYPE
```

Parameters

- **QOS_TYPE** Specifies the data stream resolution method. Valid options include:
 - **cos** Layer 2 class of service field of outbound packet is modified.
 - **dscp** Differentiated services code point value in the ToS byte is modified.
 - **traffic-class** Data stream is assigned to a traffic class queue.
- **value** Specifies the data field value or traffic class queue. Valid data range depends on QOS type.
 - **QOS_TYPE** is **cos** Value ranges from **0** to **7**.
 - **QOS_TYPE** is **dscp** Value ranges from **0** to **63**.
 - **QOS_TYPE** is **traffic-class** Value ranges from **0** to **7**.

Related Commands

- [policy-map type quality-of-service](#)
- [class \(policy-map \(qos\) Helix\)](#)

Example

These commands configure the policy map to set **CoS field 7** to data traffic specified by the class map **CMAP-1**, then assigns that data to **traffic class queue 4**.

```
switch(config)#policy-map type quality-of-service PMAP-1
switch(config-pmap-PMAP-1)#class CMAP-1
switch(config-pmap-c-PMAP-1-CMAP-1)#set cos 7
switch(config-pmap-c-PMAP-1-CMAP-1)#set traffic-class 4
switch(config-pmap-c-PMAP-1-CMAP-1)#
```

9.2.7.44 set (policy-map-class (qos) Trident II)

The **set** command specifies traffic resolution methods for traffic defined by its associated class map in its configuration mode policy map class. Three set statements are available for each class:

- **cos** Sets the Layer 2 class of service field.
- **dscp** Sets the differentiated services code point value in the type of service (ToS) byte.
- **traffic-class** Sets the traffic class queue for data packets.

Each type of set command can be assigned to a class, allowing for the simultaneous modification of both (cos, dscp) fields and assignment to a traffic class.

The **no set** and **default set** commands remove the specified data action from the class map by deleting the associated **set** command from *running-config*.

Command Mode

Policy-map-class (qos) configuration accessed through **class (policy-map (qos) Trident)** command.

Command Syntax

```
set QOS_TYPE value
```

```
no set QOS_TYPE
```

```
default set QOS_TYPE
```

Parameters

- **QOS_TYPE** Specifies the data stream resolution method. Valid options include:
 - **cos** Layer 2 class of service field of outbound packet is modified.
 - **dscp** Differentiated services code point value in the ToS byte is modified.
 - **traffic-class** Data stream is assigned to a traffic class queue.
- **value** Specifies the data field value or traffic class queue. Valid data range depends on QOS type.
 - **QOS_TYPE** is **cos** Value ranges from **0** to **7**.
 - **QOS_TYPE** is **dscp** Value ranges from **0** to **63**.
 - **QOS_TYPE** is **traffic-class** Value ranges from **0** to **7**.

Related Commands

- [policy-map type quality-of-service](#)
- [class \(policy-map \(qos\) Trident\)](#)

Example

These commands configure the policy map to set **CoS field 7** to data traffic specified by the class map **CMAP-1**, then assigns that data to **traffic class queue 4**.

```
switch(config)#policy-map type quality-of-service PMAP-1
switch(config-pmap-PMAP-1)#class CMAP-1
switch(config-pmap-c-PMAP-1-CMAP-1)#set cos 7
switch(config-pmap-c-PMAP-1-CMAP-1)#set traffic-class 4
switch(config-pmap-c-PMAP-1-CMAP-1)#
```

9.2.7.45 set (policy-map-class (qos) Trident)

The **set** command specifies traffic resolution methods for traffic defined by its associated class map in its configuration mode policy map class. Three set statements are available for each class:

- **cos** Sets the Layer 2 class of service field.
- **dscp** Sets the differentiated services code point value in the type of service (ToS) byte.
- **traffic-class** Sets the traffic class queue for data packets.

Each type of set command can be assigned to a class, allowing for the simultaneous modification of both (cos, dscp) fields and assignment to a traffic class.

The **no set** and **default set** commands remove the specified data action from the class map by deleting the associated **set** command from *running-config*.

Command Mode

Policy-map-class (qos) configuration accessed through **class (policy-map (qos) Trident)** command.

Command Syntax

```
set QOS_TYPE value
```

```
no set QOS_TYPE
```

```
default set QOS_TYPE
```

Parameters

- **QOS_TYPE** Specifies the data stream resolution method. Valid options include:
 - **cos** Layer 2 class of service field of outbound packet is modified.
 - **dscp** Differentiated services code point value in the ToS byte is modified.
 - **traffic-class** Data stream is assigned to a traffic class queue.
- **value** Specifies the data field value or traffic class queue. Valid data range depends on QOS type.
 - **QOS_TYPE** is **cos** Value ranges from **0** to **7**.
 - **QOS_TYPE** is **dscp** Value ranges from **0** to **63**.
 - **QOS_TYPE** is **traffic-class** Value ranges from **0** to **7**.

Related Commands

- [policy-map type quality-of-service](#)
- [class \(policy-map \(qos\) Trident\)](#)

Example

These commands configure the policy map to set **CoS field 7** to data traffic specified by the **class map CMAP-1**, then assigns that data to **traffic class queue 4**.

```
switch(config)#policy-map type quality-of-service PMAP-1
switch(config-pmap-PMAP-1)#class CMAP-1
switch(config-pmap-c-PMAP-1-CMAP-1)#set cos 7
switch(config-pmap-c-PMAP-1-CMAP-1)#set traffic-class 4
switch(config-pmap-c-PMAP-1-CMAP-1)#
```

9.2.7.46 set nexthop (policy-map-class pbr)

The **set nexthop** command specifies the next hop for traffic defined by its associated class map in its configuration mode policy map class.

The **no set nexthop** and **default set nexthop** commands remove the specified action from the class map by deleting the associated **set nexthop** command from **running-config**.

Command Mode

Policy-map-class (pbr) configuration accessed through **class (policy-map (pbr))** command.

Command Syntax

```
set nexthop [recursive] NH-addr_1 [NH-addr_2] ... [NH-addr_n]
```

```
no set nexthop [recursive]
```

```
default set nexthop [recursive]
```

Parameters

- **recursive** enables recursive next hop resolution.
- **NH_addr** IP address of next hop. If multiple addresses are entered, they are treated as an ECMP group.

Related Commands

- [policy-map type pbr](#)
- [class \(policy-map \(pbr\)\)](#)

Example

These **192.168.5.3** commands configure the policy map **PMAP1** to set the next hop to for traffic defined by class map **CMAP1**.

```
switch(config)#policy-map type pbr PMAP1
switch(config-pmap-PMAP1)#class CMAP1
switch(config-pmap-c-PMAP1-CMAP1)#set nexthop 192.168.5.3
switch(config-pmap-c-PMAP1-CMAP1)#
```

9.2.7.47 set nexthop-group (policy-map-class(pbr) Arad)

The `set nexthop-group` command specifies a nexthop group as the next hop for traffic defined by its associated class map in its configuration mode policy map class.

The `no set nexthop-group` and `default set nexthop-group` commands remove the specified action from the class map by deleting the associated `set nexthop-group` command from *running-config*.

Command Mode

Policy-map-class (pbr) configuration accessed through `class (policy-map (pbr))` command.

Command Syntax

```
set nexthop-group group_name
```

```
no set nexthop-group group_name
```

```
default set nexthop-group group_name
```

Parameters

group_name name of ECMP group to use as next hop.

Related Commands

- [policy-map type pbr](#)
- [class \(policy-map \(pbr\)\)](#)

Example

These commands configure the policy map **PMAP1** to set the next hop to a nexthop group named **GROUP1** for traffic defined by class map **CMAP1**.

```
switch(config)#policy-map type pbr PMAP1
switch(config-pmap-PMAP1)#class CMAP1
switch(config-pmap-c-PMAP1-CMAP1)#set nexthop-group GROUP1
switch(config-pmap-c-PMAP1-CMAP1)#
```

9.2.7.48 shape (policy-map-class (control-plane) Arad)

The **shape** command specifies the maximum bandwidth for traffic filtered by the configuration mode policy map class.

The **no shape** and **default shape** commands remove the maximum bandwidth restriction for the configuration mode class by deleting the corresponding **bandwidth** command from *running-config*.

Command Mode

Policy-map-class (control plane) configuration accessed through **class (policy-map (control-plane) Arad)**

Command Syntax

```
shape kbps kilobits
```

```
no shape
```

```
default shape
```

Parameters

kilobits Maximum data rate in kilobits per second. Value ranges from 1 to 10000000.

Related Commands

- **class (policy-map (control-plane) Arad)** places the switch in policy-map-class (control plane) configuration mode.
- **bandwidth (policy-map-class (control-plane) Arad)** specifies the minimum bandwidth for traffic defined by its associated class map in its configuration mode policy map class.

Static Classes Default Shape

Arad platform switches define these default shapes for static classes:

- copp-system-bgp 2500 copp-system-l3lpmoverflow 2500
- copp-system-bpdu 2500 copp-system-l3slowpath 2500
- copp-system-default 2500 copp-system-l3ttl1 2500
- copp-system-ipbroadcast 2500 copp-system-lacp 2500
- copp-system-ipmc 2500 copp-system-linklocal 2500
- copp-system-ipmcmis 2500 copp-system-lldp 2500
- copp-system-ipunicast NO LIMIT copp-system-mlag 2500
- copp-system-l2broadcast 2500 copp-system-multicastsnoop 2500
- copp-system-l2unicast NO LIMIT copp-system-Ospfisis 2500
- copp-system-l3destmiss 2500 copp-system-sflow 2500

Example

These commands configure the maximum bandwidth of **2000** kbps for data traffic specified by the class map **copp-system-lldp** of the default **control-plane policy map**.

```
switch(config)#policy-map type copp copp-system-policy
switch(config-pmap-copp-system-policy)#class copp-system-lldp
switch(config-pmap-c-copp-system-policy-copp-system-lldp)#shape kbps 2000
switch(config-pmap-c-copp-system-policy-copp-system-lldp)#exit
switch(config-pmap-copp-system-policy)#exit
switch(config)#show policy-map copp copp-system-policy
Service-policy input: copp-system-policy

Class-map: copp-system-lldp (match-any)
  shape : 2000 kbps
  bandwidth : 250 kbps
  Out Packets : 0
```

```
Drop Packets : 0
```

```
switch(config)#
```

9.2.7.49 shape (policy-map-class (control-plane) FM6000)

The **shape** command specifies the maximum bandwidth for traffic filtered by the configuration mode policy map class.

The **no shape** and **default shape** commands remove the maximum bandwidth restriction for the configuration mode class by deleting the corresponding **bandwidth** command from *running-config*.

Command Mode

Policy-map-class (control plane) configuration accessed through **class (policy-map (control-plane) FM6000)**.

Command Syntax

```
shape pps packets
```

```
no shape
```

```
default shape
```

Parameters

packets Maximum data rate in packets per second. Value ranges from 1 to 100000.

Related Commands

- **class (policy-map (control-plane) FM6000)** places the switch in policy-map-class (control plane) configuration mode.
- **bandwidth (policy-map-class (control-plane) FM6000)** specifies the minimum bandwidth for traffic defined by its associated class map in its configuration mode policy map class.

Static Classes Default Shape

FM6000 platform switches define these default shapes for static classes:

- copp-system-arp 10000 copp-system-l3slowpath 10000
- copp-system-default 8000 copp-system-pim-ptp 10000
- copp-system-ipmcsvd 10000 copp-system-ospf-isis 10000
- copp-system-ipmcmis 10000 copp-system-selfip 5000
- copp-system-igmp 10000 copp-system-selfip-tc6to7 5000
- copp-system-l2rsvd 10000 copp-system-sflow 25000

Example

These commands configure a maximum bandwidth of **5000** packets per second for data traffic specified by the class map **PMAP-1** in the policy map named **copp-system-policy**.

```
switch(config)#policy-map type copp copp-system-policy
switch(config-pmap-copp-system-policy)#class PMAP-1
switch(config-pmap-c-copp-system-policy-PMAP-1)#shape pps 5000
switch(config-pmap-c-copp-system-policy-PMAP-1)#
```

9.2.7.50 **shape (policy-map-class (control-plane) Helix)**

The **shape** command specifies the maximum bandwidth for traffic filtered by the configuration mode policy map class.

The **no shape** and **default shape** commands remove the maximum bandwidth restriction for the configuration mode class by deleting the corresponding **bandwidth** command from **running-config**.

Command Mode

Policy-map-class (control plane) configuration accessed through **class (policy-map (control-plane) Helix)**.

Command Syntax

```
shape pps packets
```

```
no shape
```

```
default shape
```

Parameters

packets Maximum data rate in packets per second. Value ranges from 1 to 100000.

Static Classes Default Shape

Trident platform switches define these default shapes for static classes:

- copp-system-aclog 10000 copp-system-l3ttl1 10000
- copp-system-arp 10000 copp-system-lacp 5000
- copp-system-arpresolver 10000 copp-system-lldp 10000
- copp-system-bfd 10000 copp-system-mlag 5000
- copp-system-bgp 5000 copp-system-Ospfisis 10000
- copp-system-bpdu 5000 copp-system-selfip 5000
- copp-system-default 8000 copp-system-selfip-tc6to7 5000
- copp-system-glean 10000 copp-system-sflow 25024
- copp-system-igmp 10000 copp-system-tc3to5 10000
- copp-system-ipmcrmiss 10000 copp-system-tc6to7 10000
- copp-system-ipmcrsvd 10000 copp-system-urm 10000
- copp-system-l3destmiss 10000 copp-system-vrrp 5000
- copp-system-l3slowpath 10000

Related Commands

- **class (policy-map (control-plane) Helix)** places the switch in policy-map-class (control plane) configuration mode.
- **bandwidth (policy-map-class (control-plane) Helix)** specifies the minimum bandwidth for traffic defined by its associated class map in its configuration mode policy map class.

Example

These commands configure a maximum bandwidth of **5000** packets per second for data traffic specified by the **copp-system-lldp** of the default control-plane policy map.

```
switch(config)#policy-map type control-plan copp-system-policy
switch(config-pmap-copp-system-policy)#class copp-system-lldp
switch(config-pmap-c-copp-system-policy-copp-system-lldp)#shape pps 5000
switch(config-pmap-c-copp-system-policy-copp-system-lldp)#exit
switch(config-pmap-copp-system-policy)#exit
switch(config)#show policy-map copp copp-system-policy
Service-policy input: copp-system-policy

Class-map: copp-system-lldp (match-any)
```

```
shape : 5000 pps  
bandwidth : 500 pps  
Out Packets : 305961  
Drop Packets : 0
```

```
switch(config)#
```

9.2.7.51 shape (policy-map-class (control-plane) Petra)

The **shape** command specifies the maximum bandwidth for traffic filtered by the configuration mode policy map class.

The **no shape** and **default shape** commands remove the maximum bandwidth restriction for the configuration mode class by deleting the corresponding **bandwidth** command from *running-config*.

Command Mode

Policy-map-class (control plane) configuration accessed through **class (policy-map (control-plane) Petra)**

Command Syntax

```
shape kbps kilobits
```

```
no shape
```

```
default shape
```

Parameters

kilobits Maximum data rate in kilobits per second. Value ranges from 1 to 10000000.

Related Commands

- **class (policy-map (control-plane) Petra)** places the switch in policy-map-class (control plane) configuration mode.
- **bandwidth (policy-map-class (control-plane) Petra)** specifies the minimum bandwidth for traffic defined by its associated class map in its configuration mode policy map class.

Static Classes Default Shape

Petra platform switches define these default shapes for static classes:

- copp-system-bpdu 2500 copp-system-l3destmiss 2500
- copp-system-default 2500 copp-system-l3slowpath 2500
- copp-system-igmp 2500 copp-system-l3ttl0 2500
- copp-system-ipbroadcast 2500 copp-system-l3ttl1 2500
- copp-system-ipmc 2500 copp-system-lacp 2500
- copp-system-ipmcmis 2500 copp-system-lldp 2500
- copp-system-ipmcsvd 2500 copp-system-unicast-arp 2500
- copp-system-ipunicast No Limit

Guidelines

Petra does not support all discrete rate values. When a specified discrete value is not supported, the switch converts the rate to the next highest discrete value that it supports. The **show** command displays the converted rate and not the user-configured rate.

Example

These commands configure the maximum bandwidth of **2000** kbps for data traffic specified by the class map **copp-system-lldp** of the **default control-plane** policy map. Because the switch does not support the discrete value of **2000** kbps, it converts the bandwidth up to **2115** kbps.

```
switch(config)#policy-map type copp copp-system-policy
switch(config-pmap-copp-system-policy)#class copp-system-lldp
switch(config-pmap-c-copp-system-policy-copp-system-lldp)#shape kbps 2000
switch(config-pmap-c-copp-system-policy-copp-system-lldp)#exit
switch(config-pmap-copp-system-policy)#exit
switch(config)#show policy-map copp copp-system-policy
Service-policy input: copp-system-policy
```

```
Class-map: copp-system-lldp (match-any)
  shape : 2115 kbps
  bandwidth : 325 kbps
  Out Packets : 0
  Drop Packets : 0

switch(config)#
```

9.2.7.52 **shape (policy-map-class (control-plane) Trident II)**

The **shape** command specifies the maximum bandwidth for traffic filtered by the configuration mode policy map class.

The **no shape** and **default shape** commands remove the maximum bandwidth restriction for the configuration mode class by deleting the corresponding **bandwidth** command from **running-config**.

Command Mode

Policy-map-class (control plane) configuration accessed through **class (policy-map (control-plane) Trident II)**.

Command Syntax

```
shape pps packets
```

```
no shape
```

```
default shape
```

Parameters

packets Maximum data rate in packets per second. Value ranges from 1 to 100000.

Static Classes Default Shape

Trident II platform switches define these default shapes for static classes:

- copp-system-aclog 10000 copp-system-l3slowpath 10000
- copp-system-arp 10000 copp-system-l3ttl1 10000
- copp-system-arpresolver 10000 copp-system-lacp 5000
- copp-system-bfd 10000 copp-system-lldp 10000
- copp-system-bgp 5000 copp-system-mlag 5000
- copp-system-bpdu 5000 copp-system-selfip 5000
- copp-system-default 8000 copp-system-selfip-tc6to7 5000
- copp-system-glean 10000 copp-system-sflow 25024
- copp-system-igmp 10000 copp-system-tc3to5 10000
- copp-system-ipmcrmiss 10000 copp-system-tc6to7 10000
- copp-system-ipmcrsvd 10000 copp-system-urm 10000
- copp-system-l3destmiss 10000

Related Commands

- **class (policy-map (control-plane) Trident II)** places the switch in policy-map-class (control plane) configuration mode.
- **bandwidth (policy-map-class (control-plane) Trident II)** specifies the minimum bandwidth for traffic defined by its associated class map in its configuration mode policy map class.

Example

These commands configure a maximum bandwidth of **5000** packets per second for data traffic specified by the **copp-system-lldp** of the **default control-plane policy** map.

```
switch(config)#policy-map type control-plan copp-system-policy
switch(config-pmap-copp-system-policy)#class copp-system-lldp
switch(config-pmap-c-copp-system-policy-copp-system-lldp)#shape pps 5000
switch(config-pmap-c-copp-system-policy-copp-system-lldp)#exit
switch(config-pmap-copp-system-policy)#exit
switch(config)#show policy-map copp copp-system-policy
Service-policy input: copp-system-policy

Class-map: copp-system-lldp (match-any)
  shape : 5000 pps
```

```
bandwidth : 500 pps  
Out Packets : 305961  
Drop Packets : 0
```

```
switch(config)#
```

9.2.7.53 **shape (policy-map-class (control-plane) Trident)**

The **shape** command specifies the maximum bandwidth for traffic filtered by the configuration mode policy map class.

The **no shape** and **default shape** commands remove the maximum bandwidth restriction for the configuration mode class by deleting the corresponding **bandwidth** command from **running-config**.

Command Mode

Policy-map-class (control plane) configuration accessed through **class (policy-map (control-plane) Trident)**.

Command Syntax

```
shape pps packets
```

```
no shape
```

```
default shape
```

Parameters

packets Maximum data rate in packets per second. Value ranges from 1 to 100000.

Static Classes Default Shape

Trident platform switches define these default shapes for static classes:

- copp-system-arp 10000 copp-system-lldp 10000
- copp-system-arpresolver 10000 copp-system-l3destmiss 10000
- copp-system-bpdu 5000 copp-system-l3slowpath 10000
- copp-system-default 8000 copp-system-l3ttl1 10000
- copp-system-glean 10000 copp-system-selfip 5000
- copp-system-igmp 10000 copp-system-selfip-tc6to7 5000
- copp-system-ipmcmis 10000 copp-system-sflow 25000
- copp-system-ipmcsvd 10000 copp-system-tc3to5 10000
- copp-system-lacp 5000 copp-system-tc6to7 10000

Related Commands

- **class (policy-map (control-plane) Trident)** places the switch in policy-map-class (control plane) configuration mode.
- **bandwidth (policy-map-class (control-plane) Trident)** specifies the minimum bandwidth for traffic defined by its associated class map in its configuration mode policy map class.

Example

These commands configure a maximum bandwidth of **5000** packets per second for data traffic specified by the class map **PMAP-1** in the policy map named **copp-system-policy**.

```
switch(config)#policy-map type copp copp-system-policy
switch(config-pmap-copp-system-policy)#class PMAP-1
switch(config-pmap-c-copp-system-policy-PMAP-1)#shape pps 5000
switch(config-pmap-c-copp-system-policy-PMAP-1)
```

9.2.7.54 show class-map type control-plane

The **show class-map** command displays contents of available control-plane class maps. **Control-plane** class maps can be added to the **copp-system-policy** policy map. **Control-plane** class maps can be static class maps defined by the system or dynamic maps created in class-map-configuration mode.

Dynamic class maps are composed of statements that match IPv4 access control lists. Static class maps are defined by the switch and cannot be altered.

Command Mode

EXEC

Command Syntax

```
show class-map type control-plane [MAP_NAME]
```

Parameters

- MAP_NAME Name of class map displayed by the command. Options include:
 - **no parameter** Command displays all control plane class maps.
 - **name_text** Command displays specified control-plane class maps.

show class-map command displays QoS class maps.

Related Command

[show class-map type qos](#) displays control plane class maps.

Example

This command displays all control plane class maps.

This command displays the available control plane class maps.

```
switch#show class-map type control-plane
Class-map: CM-CP1 (match-any)
  Match: ip access-group name LIST-CP1
Class-map: copp-system-acllog (match-any)
Class-map: copp-system-arp (match-any)
Class-map: copp-system-arpresolver (match-any)
Class-map: copp-system-bpdu (match-any)
Class-map: copp-system-glean (match-any)
Class-map: copp-system-igmp (match-any)
Class-map: copp-system-ipmcmis (match-any)
Class-map: copp-system-ipmcrsvd (match-any)
Class-map: copp-system-l3destmiss (match-any)
Class-map: copp-system-l3slowpath (match-any)
Class-map: copp-system-l3ttl1 (match-any)
Class-map: copp-system-lacp (match-any)
Class-map: copp-system-lldp (match-any)
Class-map: copp-system-selfip (match-any)
Class-map: copp-system-selfip-tc6to7 (match-any)
Class-map: copp-system-sflow (match-any)
Class-map: copp-system-tc3to5 (match-any)
Class-map: copp-system-tc6to7 (match-any)
switch>
```

9.2.7.55 show class-map type pbr

The **show class-map** command displays contents of all available Policy-Based Routing (PBR) class maps, or of a specified PBR class map. PBR class maps are used by PBR policy maps. PBR class maps are dynamic maps that are created in class-map-configuration mode. Dynamic class maps are composed of statements that match IPv4 or IPv6 access control lists.

Command Mode

EXEC

Command Syntax

```
show class-map type pbr [map_name]
```

Parameters

map_name Name of class map displayed by the command. If no parameter is entered, command show all available PBR class maps.

Related Command

[show policy-map type pbr](#) displays PBR policy maps.

Example

This command displays the contents of the PBR class map **CMAPI**.

```
switch#show class-map type pbr CMAPI
Class-map: CMAPI (match-any)
  Match: 10 ip access-group PBRgroup1
  Match: 20 ip access-group PBRgroup2
  Match: 30 ip access-group PBRgroup3
switch>
```

9.2.7.56 show class-map type qos

The **show class-map** command displays contents of all available QoS class maps. QoS class maps are used by QoS policy maps. QoS class maps are dynamic maps that are created in class-map-configuration mode. Dynamic class maps are composed of statements that match IPv4 or IPv6 access control lists.

Command Mode

EXEC

Command Syntax

```
show class-map [type qos] [MAP_NAME]
```

Parameters

- **MAP_NAME** Name of class map displayed by the command.
 - **no parameter** Command displays all QoS class maps.
 - **name_text** Command displays specified QoS class maps.

show class-map and **show class-map type qos** are identical commands.

Related Command

[show class-map type control-plane](#) displays control plane class maps.

Example

This command displays the available QoS class maps.

```
switch#show class-map type qos
Class-map: CM-Q1 (match-any)
  Match: ipv6 access-group name LIST-1
Class-map: CM-Q2 (match-any)
  Match: ip access-group name LIST-2
switch>
```

9.2.7.57 show policy-map copp

The **show policy-map copp** command displays contents of the control-plane policy map. Control-plane policy maps are applied to the control plane, and copp-system-policy is the only supported policy map.

Command Mode

EXEC

Command Syntax

```
show policy-map copp copp-system-policy
```

Example

This command displays the contents and throughput of the policy map applied to the control plane.

```
switch#show policy-map copp copp-system-policy
Service-policy input: copp-system-policy
  Number of units programmed: 1
  Hardware programming status: Successful

  Class-map: copp-system-bpdu (match-any)
    shape : 5000 pps
    bandwidth : 5000 pps
    Out Packets : 2
    Drop Packets : 0

  Class-map: copp-system-lacp (match-any)
    shape : 5000 pps
    bandwidth : 5000 pps
    Out Packets : 0
    Drop Packets : 0

switch>
```

9.2.7.58 show policy-map interface type qos counters

The `show policy-map interface` command displays the quantity of packets that are filtered by ACLs applied to a interface.

Command Mode

EXEC

Command Syntax

```
show policy-map [INTERFACE_NAME][type qos][TRAFFIC] counters
```

Parameters

- **INTERFACE_NAME** Filters policy map list by interfaces. Options include:
 - **no parameter** Displays data for all configured interfaces.
 - **interface ethernet e_range** Ethernet ports for which command displays policy maps.
 - **interface port-channel p_range** Port channels for which command displays policy maps.
- **TRAFFIC** Filters policy maps by the traffic they manage. Options include:
 - **no parameter** Policy maps that manage interfaces ingress traffic (same as **input** option).
 - **input** Policy maps that manage interfaces ingress traffic.

Example

This command displays the policy maps applied to interfaces Ethernet **7** and **8**.

```
switch#show policy-map interface ethernet 7-8
Service-policy input: PMAP-1
  Hardware programming status: Successful

  Class-map: cmap-1 (match-any)
    Match: ip access-group name LIST-2
          set cos 6

  Class-map: class-default (match-any)

Service-policy input: PMAP-2
  Hardware programming status: Successful

  Class-map: cmap-2 (match-any)
    Match: ip access-group name LIST-2
          set dscp 10

  Class-map: class-default (match-any)

switch#
```

9.2.7.59 show policy-map interface type qos

The `show policy-map interface` command displays contents of the policy maps applied to specified interfaces or to the control plane.

Command Mode

EXEC

Command Syntax

```
show policy-map interface INTERFACE_NAME [type qos] [TRAFFIC]
```

Parameters

- **INTERFACE_NAME** Filters policy map list by interfaces. Options include:
 - **ethernet e_range** Ethernet ports for which command displays policy maps.
 - **port-channel p_range** Port channels for which command displays policy maps.
- **TRAFFIC** Filters policy maps by the traffic they manage. Options include:
 - **no parameter** Policy maps that manage interfaces ingress traffic (same as **input** option).
 - **input** Policy maps that manage interfaces ingress traffic.

Example

This command displays the policy maps applied to interfaces Ethernet **7** and **8**.

```
switch#show policy-map interface ethernet 7-8
Service-policy input: PMAP-1
  Hardware programming status: Successful

  Class-map: cmap-1 (match-any)
    Match: ip access-group name LIST-2
          set cos 6

  Class-map: class-default (match-any)

Service-policy input: PMAP-2
  Hardware programming status: Successful

  Class-map: cmap-2 (match-any)
    Match: ip access-group name LIST-2
          set dscp 10

  Class-map: class-default (match-any)

switch#
```

9.2.7.60 show policy-map type copp

The **show policy-map type copp** command displays contents of control plane policy maps. Control-plane policy maps are applied to the control plane; copp-system-policy is the only supported policy map.

Command options filter the output to display contents of all policy maps, contents of a specified policy map, or contents of a single class map within a specified policy map.

Command Mode

EXEC

Command Syntax

```
show policy-map type copp copp-system-policy [CMAP_NAME]
```

Parameters

- **CMAP_NAME** Name of class map displayed by the command.
 - *no parameter* Command displays all class maps in specified policy map.
 - *class_name* Command displays specified class map.

Example

This command displays the contents of the copp-system-bpdu class map in the copp-system-policy policy maps.

```
switch#show policy-map type copp copp-system-policy class copp-system-b
pdu
  Class-map: copp-system-bpdu (match-any)
    shape : 5000 pps
    bandwidth : 5000 pps

switch>
```

9.2.7.61 show policy-map type pbr

The `show policy-map pbr` command displays contents of Policy-Based Routing (PBR) policy maps. PBR policy maps are applied to Ethernet interfaces, port channel interfaces or switch virtual interfaces (SVIs).

Command options filter the output to either display contents of all policy maps, contents of a specified policy map, or summary contents of all or a specified policy map.

Command Mode

EXEC

Command Syntax

```
show policy-map type pbr [PMAP_NAME][DATA_LEVEL]
```

Parameters

- **PMAP_NAME** Name of policy map displayed by the command.
 - *no parameter* Command displays all policy maps.
 - *policy-map* Command displays specified policy map.
- **DATA_LEVEL** Type of information the command displays. Values include:
 - *no parameter* Command displays all class maps in specified policy map.
 - *summary* Command displays summary data for the specified policy map.

Example

This command displays the contents of all PBR policy maps in *running-config*.

```
switch#show policy-map type pbr
Service policy PMAP1
Configured on:
Applied on:
10: Class-map: CMAP1 (match-any)
Match: 10 ip access-group PBRgroup1
Match: 20 ip access-group PBRgroup2
Match: 30 ip access-group PBRgroup3
Configured actions: set nexthop 172.16.10.12
20: Class-map: CMAP2 (match-any)
Match: 10 ip access-group PBRgroup1
Match: 10 ip access-group PBRgroup4
Match: 20 ip access-group PBRgroup5
Configured actions: set nexthop 192.168.15.15
switch#
```

9.2.7.62 show policy-map type qos counters

The `show policy-map counters` command displays the quantity of packets that are filtered by the ACLs that comprise a specified QoS policy map.

Command Mode

EXEC

Command Syntax

```
show policy-map [type qos] pmap_name [TRAFFIC] counters [INFO_LEVEL]
```

Parameters

- **pmap_name** Name of policy map displayed by the command.
- **TRAFFIC** Filters policy maps by the traffic they manage. Options include:
 - **no parameter** Policy maps that manage interfaces ingress traffic (same as **input** option).
 - **input** Policy maps that manage interfaces ingress traffic.
- **INFO_LEVEL** amount of information that is displayed. Options include:
 - **no parameter** displays summarized information about the policy map.
 - **detail** displays detailed policy map information.

9.2.7.63 show policy-map type qos

The **show policy-map qos** command displays contents of QoS policy maps. QoS policy maps are applied to Ethernet or port channel interfaces.

Command options filter the output to either display contents of all policy maps, contents of a specified policy map, or contents of a single class map within a specified policy map.

Command Mode

EXEC

Command Syntax

```
show policy-map [type qos][PMAP_NAME [CMAP_NAME]]
```

Parameters

- **PMAP_NAME** Name of policy map displayed by the command.
 - **no parameter** Command displays all policy maps.
 - **policy_map** Command displays specified policy map.
- **CMAP_NAME** Name of class map displayed by the command. This option is available only when the command includes a policy map name.
 - **no parameter** Command displays all class maps in specified policy map.
 - **class_name** Command displays specified class map.

Example

This command displays the contents of all QoS policy maps in **running-config**.

```
switch#show policy-map type qos
Service-policy input: PMAP-1
  Hardware programming status: Successful

  Class-map: xeter (match-any)
    Match: ip access-group name LIST-1
    set cos 6

  Class-map: class-default (match-any)
Service-policy PMAP-2

  Class-map: class-default (match-any)
switch#
```

Interface Configuration

This chapter describes Ethernet ports supported by Arista switches as well as channel groups, port channels, port channel interfaces, Link Aggregation Control Protocol (LACP), and Multi-Chassis Link Aggregation. This chapter contains the following sections:

- [Ethernet Ports](#)
- [Port Channels and LACP](#)
- [Multi-Chassis Link Aggregation](#)
- [Data Transfer](#)

10.1 Ethernet Ports

This section describes Ethernet ports supported by Arista switches. Topics covered in this section include:

- [Ethernet Ports Introduction](#)
- [Ethernet Standards](#)
- [Ethernet Physical Layer](#)
- [Interfaces](#)
- [Ethernet Configuration Procedures](#)
- [Ethernet Configuration Commands](#)

10.1.1 Ethernet Ports Introduction

Arista switches support a variety of Ethernet network interfaces. This chapter describes the configuration and monitoring options available in Arista switching platforms.

10.1.2 Ethernet Standards

Ethernet, standardized in *IEEE 802.3*, is a group of technologies used for communication over local area networks. Ethernet communication divides data streams into frames containing addresses (source and destination), payload, and Cyclical Redundancy Check (CRC) information.

IEEE 802.3 also describes two types of optical fiber: Single-Mode Fiber (SMF) and Multi-Mode Fiber (MMF).

- SMF is more expensive, but can be used over longer distances (over 300 meters).
- MMF is less expensive, but can only be used over distances of less than 300 meters.

10.1.2.1 100 Gigabit Ethernet

The 100 Gigabit Ethernet (100GbE) standard defines an Ethernet implementation with a nominal data rate of 100 billion bits per second over multiple 10 gigabit lanes. 100 Gigabit Ethernet implements full duplex point to point links connected by network switches. Arista switches support 100GBASE-10SR through MXP ports.

10.1.2.2 40 Gigabit Ethernet

The 40 Gigabit Ethernet (40GbE) standard defines an Ethernet implementation with a nominal data rate of 40 billion bits per second over multiple 10 gigabit lanes. 40 Gigabit Ethernet implements full duplex point to point links connected by network switches. 40 gigabit Ethernet standards are named **40GBASE-xyz**, as interpreted by [40GBASE-xyz Interpretation](#).

Table 54: 40GBASE-xyz Interpretation

x	y	z
Non-fiber media type, or fiber wavelength	PHY encoding	Number of WWDM wavelengths or XAUI Lanes
C = Copper F = Serial SMF K = Backplane L = Long (1310 nm) S = Short (850 nm)	R = LAN PHY (64B/66B)	No value = 1 (serial) 4 = 4 WWDM wavelengths or XAUI Lanes

10.1.2.3 10 Gigabit Ethernet

The 10 Gigabit Ethernet (10GbE) standard defines an Ethernet implementation with a nominal data rate of 10 billion bits per second. 10 Gigabit Ethernet implements full duplex point to point links connected by network switches. Half duplex operation, hubs and CSMA/CD do not exist in 10GbE. The standard encompasses several PHY standards; a networking device may support different PHY types through pluggable PHY modules. 10GbE standards are named **10GBASE-xyz**, as interpreted by [10GBASE-xyz Interpretation](#).

Table 55: 10GBASE-xyz Interpretation

x	y	z
media type or wavelength, if media type is fiber	PHY encoding type	Number of WWDM wavelengths or XAUI Lanes
C = Copper (twin axial) T = Twisted Pair S = Short (850 nm) L = Long (1310 nm) E = Extended (1550 nm) Z = Ultra extended (1550 nm)	R = LAN PHY (64B/66B) X = LAN PHY (8B/10B) W = WAN PHY(*) (64B/66B)	If omitted, value = 1 (serial) 4 = 4 WWDM wavelengths or XAUI Lanes

10.1.2.4 Gigabit Ethernet

The Gigabit Ethernet (GbE), defined by IEEE 802.3-2008, describes an Ethernet version with a nominal data rate of one billion bits per second. GbE cables and equipment are similar to those used in previous standards. While full-duplex links in switches is the typical implementation, the specification permits half-duplex links connected through hubs.

Gigabit Ethernet physical layer standards that Arista switches support include 1000BASE-X (optical fiber), 1000BASE-T (twisted pair cable), and 1000BASE-CX (balanced copper cable).

- 1000BASE-SX is a fiber optic standard that utilizes multi-mode fiber supporting 770 to 860 nm, near infrared (NIR) light wavelength to transmit data over distances ranging from 220 to 550 meters. 1000BASE-SX is typically used for intra-building links in large office buildings, co-location facilities and carrier neutral Internet exchanges.
- 1000BASE-LX is a fiber standard that utilizes a long wavelength laser (1,2701,355 nm), with a RMS spectral width of 4 nm to transmit data up to 5 km. 1000BASE-LX can run on all common types of multi-mode fiber with a maximum segment length of 550 m.

- 1000BASE-T is a standard for gigabit Ethernet over copper wiring. Each 1000BASE-T network segment can be a maximum length of 100 meters.

10.1.2.5 10/100/1000 BASE-T

Arista switches provide 10/100/1000 BASE-T Mbps Ethernet out of band management ports. Auto-negotiation is enabled on these interfaces. Speed (10/100/1000), duplex (half/full), and flow control settings are available using the appropriate **speed** and **flowcontrol** commands.

10.1.2.6 Power over Ethernet (PoE)

Selected Arista switches provide power over Ethernet (PoE) to power connected devices. Aristas PoE implementation is compliant with IEEE standards 802.3af and 802.3at, and includes partial support for 802.3bt.

When a standards-compliant Powered Device (PD) is connected to a PoE-enabled Ethernet port, it is recognized by a specific resistor signature, and its power class is determined by hardware negotiation; more granular power adjustments can then be managed by Link Layer Discovery Protocol (LLDP).

10.1.2.7 Link Fault Signaling

Link Fault Signaling (LFS) is a mechanism by which remote link faults are transmitted to the peer over the link that is experiencing problems by configuring specific actions. LFS operates between the remote Reconciliation Sublayer (remote RS) and the local Reconciliation Sub-layer (local RS). Faults that are detected between the remote RS and the local RS are treated by the local RS as Local Faults.

LFS enables monitoring FCS and Symbol errors on an interface and if they exceed a configured threshold, one of the following three actions are enabled.

- Disable the error on the interface
- Generate system log messages
- Generate a link fault

10.1.3 Ethernet Physical Layer

The Ethernet Physical Layer (PHY) includes hardware components connecting a switch's MAC layer to the transceiver, cable, and ultimately a peer link partner.

Data exist in digital form at the MAC layer. On the line side of the PHY, data exist as analog signals: light blips on optical fiber or voltage pulses on copper cable. Signals may be distorted while in transit and recovery may require signal processing. Ethernet physical layer components include a PHY and a transceiver.

10.1.3.1 PHYs

The PHY provides translation services between the MAC layer and transceiver. It also helps to establish links between the local MAC layer and peer devices by detecting and signaling fault conditions. The PHY line-side interface receives Ethernet frames from the link partner as analog waveforms. The PHY uses signal processing to recover the encoded bits, then sends them to the MAC layer.

PHY line-side interface components and their functions include:

- Physical Medium Attachment (PMA): Framing, octet synchronization, scrambling / descrambling.
- Physical Medium Dependent (PMD): Consists of the transceiver.
- Physical Coding Sublayer (PCS): Performs auto-negotiation and coding (8B/10B or 64B/66B).

The MAC sublayer of the PHY provides a logical connection between the MAC layer and the peer device by initializing, controlling, and managing the connection with the peer.

Ethernet frames transmitted by the switch are received by the PHY system-side interface as a sequence of digital bits. The PHY encodes them into a media-specific waveform for transmission through the line-side interface and transceiver to the link peer. This encoding may include signal processing, such as signal pre-distortion and forward error correction.

PHY system-side interface components and their functions include:

- 10 Gigabit Attachment Unit Interface (XAUI): Connects an Ethernet MAC to a 10 G PHY.
- Serial Gigabit Media Independent Attachment (SGMII): Connects an Ethernet MAC to a 1G PHY.

10.1.3.2 Transceivers

A transceiver connects the PHY to an external cable (optical fiber or twisted-pair copper) and through a physical connector (LC jack for fiber or RJ-45 jack for copper).

- Optical transceivers convert the PHY signal into light pulses that are sent through optical fiber.
- Copper transceivers connect the PHY to twisted-pair copper cabling.

Arista Small Form-Factor Pluggable (SFP+) and Quad Small Form Factor Pluggable (QSFP+) modules and cables provide high-density, low-power Ethernet connectivity over fiber and copper media. Arista offers transceivers that span data rates, media types, and transmission distances.

Arista 10 Gigabit Ethernet SFP+ Modules:

- 10GBASE-SR (Short Reach)
 - Link length maximum 300 meters over multi-mode fiber.
 - Optical interoperability with 10GBASE-SRL.
- 10GBASE-SRL (Short Reach Lite)
 - Link length maximum 100 meters over multi-mode fiber.
 - Optical interoperability with 10GBASE-SR.
- 10GBASE-LRL (Long Reach Lite)
 - Link length maximum 1 km over single-mode fiber.
 - Optical interoperability with 10GBASE-LR (1 km maximum).
- 10GBASE-LR (Long Reach)
 - Link length maximum 10 km over single-mode fiber.
 - Optical interoperability with 10GBASE-LRL (1 km maximum).
- 10GBASE-LRM (Long Reach Multimode)
 - Link length maximum 220 meters over multi-mode fiber (50 um and 62.5 um).
- 10GBASE-ER (Extended Reach)
 - Link length maximum 40 km over single-mode fiber.
- 10GBASE-ZR (Ultra-Extended Reach)
 - Link length maximum 80 km over single-mode fiber.
- 10GBASE-DWDM (Dense Wavelength Division Multiplexing)
 - Link length maximum 80 km over single-mode fiber (40 color options).
 - Tunable SFP+ Optics Module, Full C-Band 50 GHz ITU Grid, up to 80km over duplex SMF.

Arista 10 Gigabit Ethernet CR Cable Modules:

- 10GBASE-CR SFP+ to SFP+ Cables
 - Link lengths of 0.5, 1, 1.5, 2, 2.5, 3, 5, and 7 meters over twinax copper cable
 - Includes SFP+ connectors on both ends

- 4 x 10GbE QSFP+ to 4 x SFP+ twinax copper cables
 - Link lengths of 0.5, 1, 2, 3, and 5 meters over twinax copper cable

Arista 25 Gigabit Ethernet Modules:

- 25GBASE-CR SFP28 Cable
 - Capable of 10G/25G with link length of 1 to 5 meters
- AOC-S-S-25G SFP28 to SFP28 25GbE Active Optical Cable
 - Link length of 3 to 30 meters
- SFP-25G-SR SFP28 Optics Module
 - Link length up to 70m over OM3 MMF or 100m over OM4 MMF
- SFP-25G-LR SFP28 Optics Module
 - Link length up to 10 kilometers over duplex SMF

Arista 40 Gigabit Ethernet QSFP+ Cables and Optics:

- 40GBASE-SR4 QSFP+ Transceiver
 - Link length maximum 100 meters over parallel OM3 or 150 meters over OM4 MMF
 - Optical interoperability with 40GBASE-XSR4 (100/150 meter maximum)
- 40GBASE-XSR4 QSFP+ Transceiver
 - Link length maximum 300 meters over parallel OM3 or 450 meters over OM4 MMF
 - Optical interoperability with 40GBASE-SR4 (100/150 meter maximum)
- 40GBASE-LR4 QSFP+
 - Link length maximum 10 km over duplex single-mode fiber
- 40GBASE-CR4 QSFP+ to QSFP+ twinax copper cables
 - Link lengths of 1, 2, 3, 5, and 7 meters over twinax copper cable
- 40G-SRBD Bidirectional QSFP+ Optic
 - Link length maximum up to 100 meters over parallel OM3 or 150 meters over OM4 MMF
- 40G Univ QSFP+ Optic
 - Link length maximum up to 150 meters over duplex OM3/OM4 and 500 meters over duplex SMF
- 40GBASE-LRL QSFP+ Optic
 - Link length maximum up to 1 kilometer over duplex SMF
- 40GBASE-PLRL4 QSFP+ Optic
 - Link length maximum up to 1 kilometer over parallel SMF (4x10G LR up to 1 km)
- 40GBASE-PLR4 QSFP+ Optic
 - Link length maximum up to 1 kilometer over parallel SMF (4x10G LR up to 1 km)
- 40GBASE-ER QSFP+ Optic
 - Link length maximum up to 40 kilometers duplex SMF

Arista Gigabit Ethernet SFP Options:

- 1000BASE-SX (Short Haul)
 - Multi-mode fiber
 - Link length maximum 550 meter

-
- 1000BASE-LX (Long Haul)
 - Single-mode fiber
 - Link length maximum 10 km (single mode)
 - 1000BASE-T (RJ-45 Copper)
 - Category 5 cabling
 - Full duplex 1000Mbps connectivity

Arista 100 Gigabit Ethernet QSFP Modules:

- 100GBASE-SR4 QSFP transceiver
 - Link length up to 70 meters over parallel OM3 or 100 meters over OM4 multi-mode fiber.
- 100GBASE-SWDM4 QSFP transceiver
 - Link length up to 70 meters over OM3 or 100 meters over OM4 duplex multi-mode fiber.
- 100GBASE-SRBD BIDI QSFP transceiver
 - Link length up to 70 meters over OM3 or 100 meters over OM4 duplex multi-mode fiber.
- 100GBASE-PSM4 40G/100G dual speed QSFP Optics Module
 - Link length up to 500 meters over parallel single-mode fiber.
- 100GBASE-CWDM4 40G/100G dual speed QSFP Optics Module
 - Link length up to 2 km over duplex single-mode fiber.
- 100GBASE-LRL4 QSFP Optics Module
 - Link length up to 2 km over duplex single-mode fiber.
- 100GBASE-LR4 QSFP Optics Module
 - Link length up to 10 km over duplex single-mode fiber.
- 100GBASE-ERL4 QSFP Optics Module
 - Link length up to 40 km over duplex single-mode fiber.
- 100G DWDM QSFP transceiver
 - Link length up to 80 km over single-mode fiber.
- 100GBASE-CR4 QSFP to QSFP Twinax Copper Cable
 - Link length of 1 to 5 meters
- 100GBASE-CR4 QSFP to 4 x 25GbE SFP Twinax Copper Cable
 - Link length of 1 to 5 meters

Internal ports

Several Arista switches include internal ports that connect directly to an external cable through an RJ-45 jack. Internal ports available on Arista switches include:

- 100/1000BASE-T (7048T-A)
- 100/1000/10GBASE-T (7050-T)

AOC cables

- AOC-Q-Q-100G QSFP 100GbE Active Optical Cable
 - Link length of 3 to 30 meters
- AOC-Q-Q-40G QSFP+ to QSFP+ 40GbE Active Optical Cable
 - Link length of 3 to 100 meters

- AOC-S-S-25G SFP28 to SFP28 25GbE Active Optical Cable
 - Link length of 3 to 30 meters

10.1.3.2.1 400GBASE-ZR Transceivers

400GBASE-ZR transceiver is the industry's first multi-vendor DWDM standard, a Digital Coherent Optical module with tunable laser, using DWDM multiplexing and 16QAM modulation and capable of delivering 400G per port over distances up to 120 km.

Key software features supported:

- Compliant with CMIS4.0/CMIS4.1 (CMIS5.0) and Coherent CMIS
- Frequency tuning (100GHz and 75GHz grids)
- DOM monitoring, including VDM (Versatile Diagnostics Monitoring) pages, defined in CMIS4.0
- Coherent alarms and faults, including pages, defined by Coherent CMIS
- Configurable Tx output power
- A separate command for shutting down Tx output path for unidirectional mode
- 1-sec update of pre-FEC BER, OSNR, ESNR

Platform Compatibility

The 400GBASE-ZR transceiver is a power class 8 module with power consumption up to 20W, the highest power consumption among 400G transceivers.

In theory, every 400GBASE OSFP or QSFP-DD switch is qualified to host 400GBASE-ZR transceivers. However, the actual number of 400GBASE-ZR modules that can be plugged in the switch simultaneously may vary, depending on platform (modular vs fixed) and ASIC type. It is always recommended to discuss installation of 400GBASE-ZR modules with Arista support.

Using 400GBASE-ZR in combination with OSFP-LS

Arista EOS allows using OSFP-LS (pluggable line system in the OSFP form factor), instead of traditional DCI line systems.

10.1.3.2.1.1 Configuring 400GBASE-ZR Transceivers

Laser Frequency Configuration

All coherent modules, including 400GBASE-ZR, require their laser frequency to be explicitly configured. To configure laser frequency in 400GBASE-ZR, use the `transceiver frequency` command under the defined interface, providing frequency in Gigahertz, in the range 191.3-196.1 THz. If laser frequency is not configured or is configured outside the valid range, all interfaces associated with the port are put into error disabled state.

```
switch#conf
switch(config)#
switch(config)#interface Ethernet12/1
switch(config-if-Et12/1)#transceiver frequency 193100
switch(config-if-Et12/1)#
```

Configured and Operational frequency settings can be verified using the `show interface [<intf>] transceiver hardware` command.

Note:

- It can take up to 90 sec for the 400GBASE-ZR module to fully complete frequency tuning.
- The frequency plan for 400GBASE-ZR modules support channel spacings of 100GHz or 75GHz. It is recommended to use operating frequency channel definitions in chapter 15 of [4].

Transmit Output Power Configuration

CMIS4.0 defines support of configurable transmit output power as an optional feature. Check the output of `show interface [<intf>] transceiver eeprom` command for page 04h, registers 196-201 to see if it is supported.

```
Programmable output power advertisement (04h:196-201):
  Lane programmable output power supported (04h:196): true
  Min programmable output power (04h:198-199): -14 dB
  Max programmable output power (04h:200-201): -10 dB
```

Transmit Output Power can be configured using `transceiver transmitter signal power` command.

```
switch#conf
switch(config)#interface Ethernet14/1
switch(config-if-Et14/1)#transceiver transmitter signal-power ?
switch(config-if-Et14/1)#transceiver transmitter signal-power -10
```

Configured Tx Power is verified using the `show interface [<intf>] transceiver hardware` command. Actual operational Tx Power can be verified using `show interface [<intf>] transceiver` command.

 **Note:**

- 400GBASE-ZR does not have a recommended level of transmit laser power. In most cases, it is OK to stay with default power.
- Some vendors may not populate the range of supported output power correctly. The range -10 to -14 dBm should be supported. Contact Arista Support if you are planning to configure output power outside of this range.

Transmit Output Disable and Unidirectional Mode

In the coherent optics, `shutdown` command impacts both transmit and receive path and can't be used to set up unidirectional mode. To shut down Tx output path, use the `transceiver transmitter disabled` command:

```
switch#conf
switch(config)#interface Ethernet14/1
switch(config-if-Et14/1)#transceiver transmitter DISABLED
```

To re-enable transmit output, use the **no** or **default** version of the above configuration command.

10.1.3.2.1.2 Show Commands

- **show interface transceiver eeprom**

The `show interface [<intf>] transceiver eeprom` command displays the parsed capabilities.

Example

For 400GBASE-ZR, parsing of frequency tuning, power tuning (page 04h) and VDM configuration pages (20h-23h) is added.

```
switch#show interface Ethernet15/1 transceiver eeprom
Ethernet15 EEPROM:
...
  Frequency tuning support (04h:128-129):
    Grid spacing capabilities (04h:128):
      100 GHz grid supported (04h:128): true
      12.5 GHz grid supported (04h:128): false
      25 GHz grid supported (04h:128): false
      3.125 GHz grid supported (04h:128): false
```



```

33 GHz grid supported (04h:128): false
50 GHz grid supported (04h:128): false
6.25 GHz grid supported (04h:128): false
75 GHz grid supported (04h:128): true
Tunable wavelength (04h:128): true
Fine tuning support (04h:129): false
Supported channel boundaries (04h:130-161):
100 GHz grid (04h:150-153):
  Lowest channel (04h:150-151): -18
  Lowest frequency (04h:150-151): 191300000 MHz
  Highest channel (04h:152-153): 30
  Highest frequency (04h:152-153): 196100000 MHz
75 GHz grid (04h:158-161):
  Lowest channel (04h:158-159): -72
  Lowest frequency (04h:158-159): 191300000 MHz
  Highest channel (04h:160-161): 120
  Highest frequency (04h:160-161): 196100000 MHz
Programmable output power advertisement (04h:196-201):
Lane programmable output power supported (04h:196): false
VDM configuration (20h:128-255;21h:128-255):
VDM group 1 (20h:128-255):
  Parameter 1 (20h:128-129):
    Lane (20h:128): 0
    Threshold ID (20h:128): 0
    Parameter type (20h:129): Laser temperature
  Parameter 3 (20h:132-133):
    Lane (20h:132): 0
    Threshold ID (20h:132): 2
    Parameter type (20h:133): eSNR host input
  Parameter 4 (20h:134-135):
    Lane (20h:134): 1
    Threshold ID (20h:134): 2
    Parameter type (20h:135): eSNR host input
  Parameter 5 (20h:136-137):
    Lane (20h:136): 2
    Threshold ID (20h:136): 2
    Parameter type (20h:137): eSNR host input
...
  Parameter 84 (21h:166-167):
    Lane (21h:166): 0
    Threshold ID (21h:166): 14
    Parameter type (21h:167): MER
Number of VDM groups supported (2Fh:128): 2

```

- **show interface transceiver dom**

The `show interface [<intf>] transceiver dom` command displays the most important current performance data on the media (line) side.

Example

```

switch#show interface Ethernet11/1 transceiver dom
Ch: Channel, N/A: not applicable, TX: transmit, RX: receive
mA: milliamperes, dBm: decibels (milliwatts), C: Celsius, V: Volts

Port 11
Last update: 0:00:05 ago

                                     Value
-----
Case temperature                       66.59 C
Voltage                                3.26 V
TX power                               -10.23 dBm
RX total power                         -11.61 dBm
RX channel power                       -11.94 dBm

```

```

Pre-FEC BER                1.82e-03
Post-FEC errored frames ratio 0.00e+00
Chromatic dispersion (short link) 0.00 ps/nm
Chromatic dispersion (long link) 0.00 ps/nm
Differential group delay      9.31 ps
SOPMD                       0.00 ps^2
Polarization dependent loss  0.40 dB
Received OSNR estimate       35.10 dB
Received ESNR estimate       17.50 dB
Carrier frequency offset     0.00 MHz
Error vector magnitude       100.00 %
SOP rate of change           0.00 krad/s
Laser temperature            59.54 C
Laser frequency              193100.00 GHz

```

- BER: Bit Error Rate
- FEC: Forward Error Correction
- OSNR: Optical Signal to Noise Ratio
- ESNR: Electrical Signal to Noise Ratio
- SOP: State of Polarization
- SOPMD: State of Polarization Mode Dispersion

- **show transceiver status interface**

The `show transceiver status interface [<intf>]` command displays the most important alarms, faults and interface status.

Example

For 400GBASE-ZR modules, media and host side coherent alarms, host-side pre-FEC BER, defined in the Coherent CMIS and post-FEC BER have been added to the command's output:

```

switch#show transceiver status interface Ethernet14/1
Change                               Current State      Changes           Last
-----
Port 14
Transceiver                        400GBASE-ZR      1
0:15:09 ago
  Transceiver SN                      200554050
  Presence                             present
  Adapters                             none
  Bad EEPROM checksums                 0
  never
  Resets                               0
  0:15:14 ago
  Interrupts                           0
  never
  Data path firmware fault             ok                 0
  never
  Module firmware fault                ok                 0
  never
  Temperature high alarm                ok                 0
  never
  Temperature high warn                 ok                 0
  never
  Temperature low alarm                 ok                 0
  never
  Temperature low warn                  ok                 0
  never
  Voltage high alarm                    ok                 0
  never

```

Voltage high warn	ok	0
never		
Voltage low alarm	ok	0
never		
Voltage low warn	ok	0
never		
Module state	ready	4
0:14:55 ago		
Data path 1 state	activated	4
0:07:21 ago		
Data path 2 state	activated	4
0:07:21 ago		
Data path 3 state	activated	4
0:07:21 ago		
Data path 4 state	activated	4
0:07:21 ago		
Data path 5 state	activated	4
0:07:21 ago		
Data path 6 state	activated	4
0:07:21 ago		
Data path 7 state	activated	4
0:07:21 ago		
Data path 8 state	activated	4
0:07:21 ago		
RX LOS	ok	2
0:05:54 ago		
TX fault	ok	0
never		
RX CDR LOL	ok	0
never		
TX power high alarm	ok	0
never		
TX power high warn	ok	2
0:07:39 ago		
TX power low alarm	ok	2
0:07:50 ago		
TX power low warn	ok	4
0:07:39 ago		
TX bias high alarm	ok	0
never		
TX bias high warn	ok	0
never		
TX bias low alarm	ok	0
never		
TX bias low warn	ok	0
never		
RX power high alarm	ok	0
never		
RX power high warn	ok	0
never		
RX power low alarm	ok	0
never		
RX power low warn	ok	0
never		
TX loss of alignment	ok	0
never		
TX out of alignment	ok	0
never		
TX clock monitor unit LOL	ok	0
never		
TX reference clock LOL	ok	0
never		

```

TX deskew LOL          ok          0
never
TX FIFO error         ok          0
never
RX demodulator LOL   ok          0
never
RX CD compensation LOL ok          0
never
RX loss of alignment ok          0
never
RX out of alignment  ok          0
never
RX deskew LOL        ok          0
never
RX FIFO error         ok          0
never
RX FEC excessive degrade ok        0
never
RX FEC detected degrade ok          0
never
Freq tuning in progress idle        0
never
Freq tuning busy      ok          0
never
Freq tuning invalid channel ok        0
never
Freq tuning completed no           2
0:07:34 ago
Ethernet14/1
Operational speed      400Gbps
Pre-FEC bit error rate 0.00e+00
Post-FEC errored frames ratio 0.00e+00
TX LOS
Host lane 1           ok          0
never
Host lane 2           ok          0
never
Host lane 3           ok          0
never
Host lane 4           ok          0
never
Host lane 5           ok          0
never
Host lane 6           ok          0
never
Host lane 7           ok          0
never
Host lane 8           ok          0
never
TX CDR LOL
Host lane 1           ok          0
never
Host lane 2           ok          0
never
Host lane 3           ok          0
never
Host lane 4           ok          0
never
Host lane 5           ok          0
never

```

Host lane 6	ok	0
never		
Host lane 7	ok	0
never		
Host lane 8	ok	0
never		
TX adaptive input EQ fault		
Host lane 1	ok	0
never		
Host lane 2	ok	0
never		
Host lane 3	ok	0
never		
Host lane 4	ok	0
never		
Host lane 5	ok	0
never		
Host lane 6	ok	0
never		
Host lane 7	ok	0
never		
Host lane 8	ok	0
never		



Note: In the operational state, module state is 'Ready' and datapath state for all 8 lanes is activated.

- **Wavelength/Frequency and Output Power Status**

The `show interface [<intf>] transceiver hardware` command displays the configured and programmed wavelength and output power. It takes a short time for the configured wavelength or output power to be programmed into the transceiver. The configured wavelength/output power and programmed wavelength/output power should not differ for extended periods of time.

```
switch#show interface Ethernet23/1 trans hardware
Name: Et23/1
Media type: 400GBASE-ZR
Maximum module power (W): 20.0
Maximum slot power (W): 20.0
Configured frequency (GHz): 193100.0
Computed wavelength (nm): 1552.52
Operational frequency (GHz): 193,100.0
Operational wavelength (nm): 1552.52
Configured TX power (dBm): -10.0
Operational TX power (dBm): -10.0
```



Note: Configured transmit output power and operational transmit output power are only displayed if configurable output power is supported by the module.

10.1.3.2.1.3 Troubleshooting

1. Check transceiver type – make sure it is 400GBASE-ZR
2. Check peer transceiver – make sure it is also 400GBASE-ZR.
3. Check that channel/frequency is configured and interfaces are not in errdisabled state
4. Check that the selected frequency is matching on both sides of the optical link
5. Check that transmit output is not disabled
6. If Tx power is not configured, check that it is in the range of -6 dB to -12 dB.
7. If Tx power is configured, check that matches its configured values on both sides of the optical link.

-
8. Check Rx power. The best performance of an optical link is achieved when the received power is -10dB.
 9. Collect the output of CLI commands listed in the “Show commands” section before making a request for support from the development team.
 10. Check that pre-FEC BER (‘show transceiver dom’ command) is in the correctable range (less than 1e-2).
 11. ‘show transceiver status interface’ - check that module state is ‘Ready’, datapath state is ‘Activated’. Check for possible alarms and faults

Link Issues

If a link has issues, the following commands and files are useful for debugging and Arista TAC.

- show interfaces <interfaceName> phy detail
- show interfaces <interfaceName> transceiver detail
- show idprom transceiver <interfaceName> ext
- files in /var/log/agents/*
- files in /var/log/qt/*
- /var/log/messages*

10.1.3.2.1.4 Limitations

400GBASE-ZR transceivers are relatively new. The modules could be Arista branded or 3rd party, from multiple vendors. For 3rd party optics, some optional properties (Tx output power, support of 75GHz grid) or DOM properties in the VDM pages, may not be implemented.

10.1.3.3 MXP Ports

MXP ports provide embedded optics that operate in one of three modes: 10GbE (12 ports), 40GbE (3 ports), and 100GbE (1 port). Each mode requires a specified cable is implemented through configuration commands. MXP ports utilize multi-mode fiber to provide support over 150 meters.

- 100GbE mode requires an MTP-24 to MTP-24 cable, which uses 20 of 24 fibers to carry 100Gbe across 10 send and 10 receive channels. When connecting two 100GbE MXP ports, the TX lanes must be crossed with the RX lanes.
- 40GbE mode requires an MTP cable that provides a split into three MTP-12 ends. The cable splits the MXP port into three MTP-12 ends, each compatible with standards based 40GBASE-SR4 ports over OM3 or OM4 fiber up to 100m or 150m.
- 10GbE mode requires an MTP cable that provides a split into 12x10G with LC connectors to adapt the MXP port into 12x10GbE. The cable splits the MXP port into twelve LC ends for using SR or SRL optics over multimode OM3/OM4 cables.

10.1.4 Interfaces

Arista switches provide two physical interface types that receive, process, and transmit Ethernet frames: Ethernet interfaces and Management interfaces.

Each Ethernet interface is assigned a 48-bit MAC address and communicates with other interfaces by exchanging data packets. Each packet contains the MAC address of its source and destination interface. Ethernet interfaces establish link level connections by exchanging packets. Interfaces do not typically accept packets with a destination address of a different interface.

Ethernet data packets are frames. A frame begins with preamble and start fields, followed by an Ethernet header that includes source and destination MAC addresses. The middle section contains payload data, including headers for other protocols carried in the frame. The frame ends with a 32-bit Cyclic Redundancy Check (CRC) field that interfaces use to detect data corrupted during transmission.

10.1.4.1 Ethernet Interfaces

Ethernet speed and duplex configuration options depend on the media type of the interface:

- 40G, OSFP, QSFP+, QSFP-DD, and QSFP200: Default operation is as four 10G ports. **speed** command options support configuration as a single 40G port.
- 1000BASE-T / 2.5GBASE-T / 5GBASE-T / 10GBASE-T (copper): Default configuration enables the **Clause 28 auto-negotiation** for the port to negotiate the speed based on peer capabilities. Depending on individual SKU capabilities, these ports support 10M/100M/1G/2.5G/5G and 10G rates and half / full-duplex mode of operation. The Speed auto SPEED command limits the port advertisements only to a specific speed. The **SPEED** commands disables the Clause 28 auto-negotiation and uses the specified speed as the forced speed setting. **sa** commands.
- 10GBASE-T (SFP+): Port operates as a single 10G port. **speed** commands do not affect configuration.
- 100G CFP2: Default operation is 100G. It cannot be split, and its speed cannot be changed.
- 100G MXP: Operates as three 40G ports on the 7050 platform. On the 7050 platforms, available speed/duplex settings are three 40G ports or twelve 10G ports. Adjustments are made with **speed** commands.
- 100G QSFP100: Available speeds are transceiver-dependent. The QSFP100 transceiver supports a single 100G port, four 25G ports, or two 50G ports; the QSFP+ transceiver supports one 40G port or four 10G ports; the CWDM transceiver supports all five configurations. Adjustments are made using **speed** commands.
- The **SFP1000BASE-T** transceivers advertise one speed at a time only. Hence, the desired speed and negotiation must be configured explicitly using the following commands:
 - **speed auto**: auto-negotiated 1Gbps (this is because no speed is specified and we are defaulting to advertise 1G).
 - **speed auto 1Gfull** / **speed auto**: auto-negotiated 1Gbps (note that per BASE-T standard, 1G must be negotiated)
 - **speed auto 100full**: auto-negotiated 100Mbps
 - **speed 100full**: non-negotiated / forced 100Mbps
- The **SFP10GBASE-Ts** transceivers advertise one speed at a time only, similar to SFP1000BASE-Ts, unlike native BASE-T ports. The **no and default speed** commands configure the PHY to advertise only 10G.

For information relating to transceivers, see [Transceivers](#).

10.1.4.2 Subinterfaces

Subinterfaces divide a single ethernet or port channel interface into multiple logical L3 interfaces based on the 802.1q tag (VLAN ID) of incoming traffic. Subinterfaces are commonly used in the L2/L3 boundary device, but they can also be used to isolate traffic with 802.1q tags between L3 peers by assigning each subinterface to a different VRF.

While subinterfaces can be configured on a port channel interface (the virtual interface associated with a port channel), the following restrictions apply:

- An L3 interface with subinterfaces configured on it should not be made a member of a port channel.
- An interface that is a member of a port channel should not have subinterfaces configured on it.
- A subinterface cannot be made a member of a port channel.

Subinterfaces on multiple ports can be assigned the same **VLAN ID**, but there is no bridging between subinterfaces (or between subinterfaces and SVIs), and each subinterface is considered to be in a separate bridge domain.

The following features are supported on subinterfaces:

- Unicast and multicast routing
- BGP, OSPF, ISIS, PIM

-
- ACL
 - VRF
 - VRRP
 - SNMP
 - Subinterface counters (on some platforms)
 - VXLAN (on some platforms)
 - MPLS (on some platforms)
 - GRE (on some platforms)
 - PBR (on some platforms)
 - QoS (on some platforms)
 - Inheriting QoS settings (trust mode and default DSCP) from the parent interface
 - Inheriting MTU setting from parent interface

The following are not supported on subinterfaces:

- Per-subinterface MTU setting
- Per-subinterface SFLOW settings
- Per-subinterface mirroring settings

10.1.4.3 Agile Ports

Agile Ports are a feature of the 7150S Series that allows the user to configure adjacent blocks of 4 x SFP+ interfaces as a single 40G link. The set of interfaces that can be combined to form a higher speed port is restricted by the hardware configuration. Only interfaces that pass through a common PHY component can be combined. One interface within a combinable set is designated as the primary port.

When the primary interface is configured as a higher speed port, all configuration statements are performed on that interface. All other interfaces in the set are subsumed and not individually configurable when the primary interface is configured as the higher speed port. This feature allows the 7150S-24 to behave as a 4x40G switch (using 16 SFP+) and the remaining SFP+ provide 8 x 10Gports. On the 7150S-52 this allows up to 13x 40G (all 52 ports grouped as 40G) and on the 7150S-64 Agile Ports allows the switch to be deployed with up to 16 native 40G interfaces - 4 are QSFP+ and the remaining 12 as 4xSFP+ groups.

10.1.4.4 Management Interfaces

The management interface is a Layer 3 host port that is typically connected to a PC for performing out of band switch management tasks. Each switch has one or two management interfaces. Only one port needs to manage the switch; the second port, when available, provides redundancy.

Management interfaces are 10/100/1000 BASE-T interfaces. By default, auto-negotiation is enabled on management interfaces. All combinations of speed 10/100/1000 and full or half duplex is enforceable on these interfaces through `speed` commands.

Management ports are enabled by default. The switch cannot route packets between management ports and network (Ethernet interface) ports because they are in separate routing domains. When the PC is multiple hops from the management port, packet exchanges through Layer 3 devices between the management port and PC may require the enabling of routing protocols.

The Ethernet management ports are accessed remotely over a common network or locally through a directly connected PC. An IP address and static route to the default gateway must be configured to access the switch through a remote connection.

10.1.4.5 Tunable SFP

Tuning of DWDM 10G SFP+ transceivers (10GBASE-DWDM) includes:

- Tuning transceiver wavelength/frequency by channel number
- Showing wavelengths/frequencies for specified channels supported by the transceiver
- Showing current wavelength/frequency settings of the transceiver interface

For information relating to tuning the transceiver wavelength/frequency by channel number, refer to the command `transceiver channel`. To show the current wavelength/frequency settings for specified channels, refer to the command `show interfaces transceiver channels`. To show the current wavelength/frequency settings of an interface, refer to the command `show interfaces transceiver hardware`.

10.1.5 Ethernet Configuration Procedures

These sections describe Ethernet and Management interface configuration procedures:

- [Physical Interface Configuration Modes](#)
- [Assigning a MAC Address to an Interface](#)
- [Port Groups \(QSFP+ and SFP+ Interface Selection\)](#)
- [Referencing Modular Ports](#)
- [Referencing Multi-lane Ports](#)
- [Hitless Speed Change with Dynamic Logical Ports](#)
- [QSFP+ Ethernet Port Configuration](#)
- [QSFP100 Ethernet Port Configuration](#)
- [CFP2 Ethernet Port Configuration](#)
- [MXP Ethernet Port Configuration](#)
- [Port Speed Capabilities](#)
- [Agile Ports](#)
- [Subinterface Configuration](#)
- [Maximum Latency Tail-drop Thresholds](#)
- [Autonegotiated Settings](#)
- [Displaying Ethernet Port Properties](#)
- [Ingress Counters](#)
- [Configuring Ingress Traffic-Class Counters](#)
- [Hardware Counter Support](#)
- [Configuring Power over Ethernet \(PoE\)](#)
- [Configuring Link Fault Signaling](#)
- [Configuring Hardware TCAM](#)
- [CPU Traffic Policy](#)
- [TCAM Profile for Configurable Port Qualifier Sizing](#)

10.1.5.1 Physical Interface Configuration Modes

The switch provides two configuration modes for modifying Ethernet parameters:

- Interface-Ethernet mode configures parameters for specified Ethernet interfaces.
- Interface-Management mode configures parameters for specified management Ethernet interfaces.

Physical interfaces cannot be created or removed.

Multiple interfaces can be simultaneously configured. Commands are available for configuring Ethernet specific, layer 2, Layer 3, and application layer parameters. Commands that modify protocol specific settings in Ethernet configuration mode are listed in the protocol chapters.

- The `interface ethernet` command places the switch in Ethernet-interface configuration mode.
- The `interface management` command places the switch in management configuration mode.

Examples

- This command places the switch in Ethernet-interface mode for Ethernet interfaces 5-7 and 10.

```
switch(config)#interface ethernet 5-7,10
switch(config-if-Et5-7,10)#
```

- This command places the switch in management-interface mode for management interface 1.

```
switch(config)#interface management 1
switch(config-if-Ma1)#
```

10.1.5.2 Assigning a MAC Address to an Interface

Ethernet and Management interfaces are assigned a MAC address when manufactured. This address is the burn-in address. The `mac-address` command assigns a MAC address to the configuration mode interface in place of the burn-in address. The `no mac-address` command reverts the interfaces current MAC address to its burn-in address.

Examples

- This command assigns the MAC address of `001c.2804.17e1` to **Ethernet interface 7**.

```
switch(config-if-Et7)#mac-address 001c.2804.17e1
```

- This command displays the MAC address of Ethernet interface 7. The active MAC address is `001c.2804.17e1`. The burn-in address is `001c.7312.02e2`.

```
switch(config-if-Et7)#show interface ethernet 7
Ethernet7 is up, line protocol is up (connected)
  Hardware is Ethernet, address is 001c.2804.17e1 (bia 001c.7312.02e2)
  Description: b.e45
switch(config-if-Et7)#
```

10.1.5.3 Port Groups (QSFP+ and SFP+ Interface Selection)

Several of Aristas fixed switches limit the number of 10G data lanes in operation through the use of port groups. A port group is a set of interfaces that can be configured as four SFP+ interfaces or a single QSFP+ interface. When configured in SFP+ mode, the port group enables four standalone 10GbE interfaces using SFP+ optics. When configured in QSFP+ mode, the port group enables a single QSFP+ interface (in addition to the dedicated QSFP+ ports), which can operate as a single 40GbE port, or as four 10GbE ports with the appropriate breakout cabling.

Hardware port groups are used on the following systems:

- DCS-7050Q-16
- DCS-7050QX-32S

Use the `hardware port-group` command to select the interface mode for the specified port group.



Note: The `hardware port-group` command restarts the forwarding agent, which disrupts traffic on all switch ports.

Example

These commands configure the DCS-7050-Q16 switch to enable four SFP+ interfaces and one extra QSFP+ interface by enabling the SFP+ interfaces in **port-group 1** and the QSFP+ interface in **port-group 2**.

```
switch(config)#hardware port-group 1 select Et17-20
switch(config)#hardware port-group 2 select Et16/1-4
```

The `show hardware port-group` command displays the status of ports in the port groups.

Example

This command displays the status of the flexible ports within the two port groups on a DCS-7050Q-16 switch.

```
switch#show hardware port-group

Portgroup: 1      Active Ports: Et17-20
Port              State
-----
Ethernet17       Active
Ethernet18       Active
Ethernet19       Active
Ethernet20       Active
Ethernet15/1     ErrDisabled
Ethernet15/2     ErrDisabled
Ethernet15/3     ErrDisabled
Ethernet15/4     ErrDisabled

Portgroup: 2      Active Ports: Et16/1-4
Port              State
-----
Ethernet16/1Active
Ethernet16/2Active
Ethernet16/3Active
Ethernet16/4Active
Ethernet21ErrDisabled
Ethernet22ErrDisabled
Ethernet23ErrDisabled
Ethernet24ErrDisabled
```

10.1.5.3.1 DCS-7050Q-16

The DCS-7050Q-16 has 14 dedicated QSFP+ ports, plus two port groups. The port groups support either two additional QSFP+ ports or eight SFP+ ports as shown in [DCS-7050Q-16 Port Groups](#).

Table 56: DCS-7050Q-16 Port Groups

Port Group 1		Port Group 2	
Active Interface(s)		Active Interface(s)	
In SFP+ Mode	In QSFP+ Mode (Default)	In SFP+ Mode	In QSFP+ Mode (Default)
Et17-20 (four SFP+ ports)	Et15/1-4 (one QSFP+ port)	Et21-24 (four SFP+ ports)	Et16/1-4 (one QSFP+ port)

10.1.5.3.2 DCS-7050QX-32S

The DCS-7050QX-32S has 31 dedicated QSFP+ ports, plus one port group. The port group supports either one additional QSFP+ port or four SFP+ ports as shown in [DCS-7050QX-32S Port Groups](#).

Table 57: DCS-7050QX-32S Port Groups

Port Group 1
Active Interface(s)

In SFP+ Mode	In QSFP+ Mode (Default)
Et1-4 (four SFP+ ports)	Et5/1-4 (one QSFP+ port)

10.1.5.4 Referencing Modular Ports

Arista modular switches provide port access through installed line cards. The maximum number of line cards on a modular switch varies with the switch series and model.

Several CLI commands modify modular parameters for all ports on a specified line card or controlled by a specified chip. This manual uses these conventions to reference modular components:

- *card_x* refers to a line card.
- *module_y* refers to a QSFP+ module.
- *port_z* refers to a line card or module port.

Commands that display Ethernet port status use the following conventions:

- SFP ports: : *card_x/port_z* to label the line card-port location of modular ports
- QSFP ports: *card_x/module_y/port_z* to label the line card-port location of modular ports

[QSFP+ Ethernet Port Configuration](#) describe QSFP+ module usage.

Example

This command displays the status of interfaces 1 to 9 on line card 4:

```
switch#show interface ethernet 4/1-9 status
Port      Name      Status      Vlan      Duplex  Speed Type
Et4/1     Et4/1     connected   1         full    10G Not Present
Et4/2     Et4/2     connected   1         full    10G Not Present
Et4/3     Et4/3     connected   1         full    10G Not Present
Et4/4     Et4/4     connected   1         full    10G Not Present
Et4/5     Et4/5     connected   1         full    10G Not Present
Et4/6     Et4/6     connected   1         full    10G Not Present
Et4/7     Et4/7     connected   1         full    10G Not Present
Et4/8     Et4/8     connected   1         full    10G Not Present
Et4/9     Et4/9     connected   1         full    10G Not Present
switch>
```

10.1.5.5 Referencing Multi-lane Ports

EOS supports two types of Ethernet ports:

- single-lane (also called fixed-lane)
- multi-lane (also called flexible-lane)

Single-lane (or fixed-lane) ports are always modeled as a single interface within EOS. While the speed of the interface may be configurable, the physical port can never be broken out into multiple lower-speed interfaces. Single-lane ports use the following naming scheme:

- Ethernet <port #> (for fixed switches)
- Ethernet <module #>/<port #> (for modular switches)

Multi-lane (or flexible lane) ports are made up of multiple parallel lanes, each served by its own laser. Multi-lane ports can be configured to combine the lanes and operate as a single native high-speed interface (a 40GbE or 100GbE interface), or to operate each lower-speed interface independently (four 10GbE or 25GbE interfaces). Multi-lane ports use the following naming scheme:

- Ethernet **port #lane #** (for fixed switches)
- Ethernet **module #port #lane #** (for modular switches)

The operational state displayed for each lane of a multi-lane port is determined by the configuration applied to the primary lane(s), as shown in [Lane States](#). When broken out into multiple lower-speed interfaces, all lanes will be active in parallel, and each will display its operational state as **connected** or **not connected**. In high-speed mode, only the primary lane(s) will be displayed as active, with the remaining lanes showing as **errdisabled**. The exception is the CFP2 module: when it is configured as a single 100GbE port, the primary lane is displayed as active in the CLI while the other lanes are hidden.

Table 58: Lane States

Parent Port Configured Mode	Primary Lane(s)	Secondary Lanes
single high-speed interface	active (connected/not connected)	inactive (errdisabled)
multi-interface breakout	active (connected/not connected)	active (connected/not connected)

A multi-lane port is configured as a single high-speed interface or multiple breakout interfaces by using the `speed` command on the primary lane(s) of the port. For specific configuration instructions and details regarding the primary lane(s) of a specific interface, refer to the configuration section for the appropriate interface type:

- [QSFP+ Ethernet Port Configuration](#)
- [QSFP100 Ethernet Port Configuration](#)
- [CFP2 Ethernet Port Configuration](#)
- [MXP Ethernet Port Configuration](#)



Note: Use of the `speed` command to configure a multi-lane port is hitless on the 7050X, 7060X, 7250X, 7260X, 7280SE, 7300X, 7320X and 7500E series platforms. On all other platforms, this command restarts the forwarding agent, which will result in traffic disruption. On 7160 series platforms, use of the `speed` command is hitless, but if the command changes the number of port lanes, packets may be dropped on unrelated ports.

10.1.5.6 Hitless Speed Change with Dynamic Logical Ports

Higher speed ports on several switches can be broken out into multiple interfaces that can be configured at lower speeds. Each of these interfaces is called a Logical Port (LP). Switches such as the DCS-7260CX3-64, allocate and deallocate the logical ports dynamically to optimize hardware resources. Care must be taken for hitless speed changes, therefore, as a change of speed on a Dynamic Logical Port (DLP) may impact the status of one or more related DLP(s).

Checking Status of DLPs

The following example is applicable to a switch that supports a breakout of a 100G physical port to 4x 25G DLPs.

The command displays the status of Et 45/1-4, when a 100G physical port is broken out to 4x 25G DLPs.

```
switch(config)#show interfaces ethernet 45/1-4 status
Port      Name      Status      Vlan  Duplex Speed  Type      Flags
Et45/1             notconnect  1      full   25G   Not Present
Et45/2             notconnect  1      full   25G   Not Present
Et45/3             notconnect  1      full   25G   Not Present
```

```
Et45/4          notconnect  1      full    25G Not Present
```

The following example displays the inactive interfaces (DLPs) when the 100G physical port is configured for the 100G speed.

```
switch(config)#show interfaces ethernet 45/1-4 status
Port   Name      Status      Vlan Duplex Speed  Type      Flags
Et45/1          notconnect  1      full  100G  Not Present
Et45/2          inactive    1      unconf unconf Not Present
Et45/3          inactive    1      unconf unconf Not Present
Et45/4          inactive    1      unconf unconf Not Present
```

By default, inactive interfaces will not be displayed by this command. To enable showing them, use the following command.

```
switch(config)#[no] service interface inactive expose
```

Only systems without DLP allocation have enough logical ports for every interface to be active simultaneously.

10.1.5.7 QSFP+ Ethernet Port Configuration

Each QSFP+ module contains four data lanes which can be used individually or combined to form a single, higher-speed interface. This allows a QSFP+ Ethernet port to be configured as a single 40GbE interface or as four 10GbE interfaces.

When the four lanes are combined to form a 40GbE interface, display commands will show lane /1 as **connected** or **not connected**, and will show lanes /2 through /4 as **errdisabled**.

The following sections describe the configuration of QSFP+ ports.

10.1.5.7.1 Configuring a QSFP+ Module as a Single 40GbE Interface

To configure the port as a single 40GbE interface, combine the modules four data lanes by using the [speed](#) command (**speed forced 40g full**) on the ports /1 lane (the primary lane).

 **Note:** Use of the **speed** command to configure a multi-lane port is hitless on the 7050X, 7060X, 7250X, 7260X, 7280SE, 7300X, 7320X and 7500E series platforms. On all other platforms, this command restarts the forwarding agent, which will result in traffic disruption. On 7160 series platforms, use of the **speed** command is hitless, but if the command changes the number of port lanes, packets may be dropped on unrelated ports.

1. Enter interface Ethernet configuration mode for lane /1 of the QSFP+ Ethernet interface.

```
switch(config)#interface ethernet 5/1/1
```

2. Enter the **speed 40gfull** command. Depending on the platform, this command may restart the forwarding agent, disrupting traffic on all ports for 60 seconds or more.

```
switch(config-if-Et5/1/1)#speed 40gfull
```

3. Use the [show interfaces status](#) command to confirm the change in configuration.

```
switch(config-if-Et5/1/1)#show interfaces status
Port Name Status Vlan Duplex Speed Type Flags
Et1 connected 2 full 1G 10GBASE-T
<-----OUTPUT OMITTED FROM EXAMPLE----->
Et5/1/1 connected 1 full 40G 40GBASE-SR4
Et5/1/2 errdisabled 1 unconf unconf 40GBASE-SR4
Et5/1/3 errdisabled 1 unconf unconf 40GBASE-SR4
Et5/1/4 errdisabled 1 unconf unconf 40GBASE-SR4
```

<-----OUTPUT OMITTED FROM EXAMPLE----->

10.1.5.7.2 Configuring a QSFP+ Module as Four 10GbE Interfaces

To configure the port as four 10GbE interfaces, use the `speed` command (**speed 10000full**) on the ports /1 lane (the primary lane).



Note: Use of the `speed` command to configure a multi-lane port is hitless on the 7050X, 7060X, 7250X, 7260X, 7280SE, 7300X, 7320X and 7500E series platforms. On all other platforms, this command restarts the forwarding agent, which will result in traffic disruption. On 7160 series platforms, use of the `speed` command is hitless, but if the command changes the number of port lanes, packets may be dropped on unrelated ports.

1. Enter interface Ethernet configuration mode for lane /1 of the QSFP+ Ethernet interface.

```
switch(config)#interface ethernet 5/1/1
```

2. Enter the `speed 10000full` command. Depending on the platform, this command may restart the forwarding agent, disrupting traffic on all ports for 60 seconds or more.

```
switch(config-if-Et5/1/1)#speed 10000full
```

3. Use the `show interfaces status` command to confirm the change in configuration.

```
switch(config-if-Et5/1/1)#show interfaces status
PortNameStatusVlanDuplexSpeedTypeFlags
Et1connected2full1G10GBASE-T
Et5/1/1connected1full10G40GBASE-SR4
Et5/1/2connected1full10G40GBASE-SR4
Et5/1/3connected1full10G40GBASE-SR4
Et5/1/4connected1full10G40GBASE-SR4
```

10.1.5.8 QSFP100 Ethernet Port Configuration

Each QSFP100 module contains four data lanes which can be used individually or combined to form a single, higher-speed interface. This allows a QSFP100 Ethernet port to be configured as a single 100GbE interface, a single 40GbE interface, or four 10GbE interfaces. The default mode is a single 100GbE interface.

The 7060X, 7260X and 7320X platforms also allow a QSFP100 port to be configured as two 50GbE interfaces or four 25GbE interfaces.

When the lanes are combined to form a higher-speed interface, display commands will show the primary lane(s) as **connected** or **not connected**, and will show the other lanes as **errdisabled**.

The following sections describe the configuration of QSFP+ ports.

10.1.5.8.1 Configuring a QSFP100 Module as a Single 100GbE Interface

By default, the QSFP100 module operates as a single 100GbE interface; using the **default speed** or **no speed** command on the primary lane restores the default behavior.

To explicitly configure the port as a single 100GbE interface, combine the modules four data lanes by using the `speed` command (**speed 100gfull**) on the ports /1 lane (the primary lane).



Note: Use of the `speed` command to configure a multi-lane port is hitless on the 7050X, 7060X, 7250X, 7260X, 7280SE, 7300X, 7320X and 7500E series platforms. On all other platforms, this command restarts the forwarding agent, which will result in traffic disruption. On 7160 series platforms, use of the `speed` command is hitless, but if the command changes the number of port lanes, packets may be dropped on unrelated ports.

1. Enter interface Ethernet configuration mode for lane /1 of the QSFP100 Ethernet interface.

```
switch(config)#interface ethernet 5/1/1
```

2. Enter the **speed 100gfull** command. Depending on the platform, this command may restart the forwarding agent, disrupting traffic on all ports for 60 seconds or more.

```
switch(config-if-Et5/1/1)#speed 100gfull
```

3. Use the **show interfaces status** command to confirm the change in configuration.

```
switch(config-if-Et5/1/1)#show interfaces status
Port      Name      Status      Vlan      Duplex      Speed      Type      Flags
Et1       Et1       connected   2         full        1G         10GBASE-T
<-----OUTPUT OMITTED FROM EXAMPLE----->
Et5/1/1   connected 1          full      100G       100GBASE-SR4
Et5/1/2   errdisabled 1         unconf    unconf     100GBASE-SR4
Et5/1/3   errdisabled 1         unconf    unconf     100GBASE-SR4
Et5/1/4   errdisabled 1         unconf    unconf     100GBASE-SR4
<-----OUTPUT OMITTED FROM EXAMPLE----->
```

10.1.5.8.2 Configuring a QSFP100 Module as Two 50GbE Interfaces

To configure the port as a two 50GbE interfaces, configure the modules four data lanes by using the **speed** command (**speed 50gfull**) on the ports /1 and /3 lanes. This configuration is available on 7060X, 7260X and 7320X platforms.



Note:

Use of the **speed** command to configure a multi-lane port is hitless on the 7050X, 7060X, 7250X, 7260X, 7280SE, 7300X, 7320X and 7500E series platforms. On all other platforms, this command restarts the forwarding agent, which will result in traffic disruption. On 7160 series platforms, use of the **speed** command is hitless, but if the command changes the number of port lanes, packets may be dropped on unrelated ports.

1. Enter interface Ethernet configuration mode for lane /1 of the QSFP100 Ethernet interface.

```
switch(config)#interface ethernet 5/1/1
```

2. Enter the **speed 50gfull** command. Depending on the platform, this command may restart the forwarding agent, disrupting traffic on all ports for 60 seconds or more.

```
switch(config-if-Et5/1/1)#speed 50gfull
```

3. Repeat the above steps for lane /3.

```
switch(config-if-Et5/1/1)#interface ethernet 5/1/3
switch(config-if-Et5/1/3)#speed 50gfull
```

4. Use the **show interfaces status** command to confirm the change in configuration.

```
switch(config-if-Et5/1/1)#show interfaces status
Port      Name      Status      Vlan      Duplex      Speed      Type
Flags
Et1       Et1       connected   2         full        1G         10GBASE-T
<-----OUTPUT OMITTED FROM EXAMPLE----->
Et5/1/1   connected 1          full      50G        100GBASE-SR4
Et5/1/2   errdisabled 1         unconf    unconf     100GBASE-SR4
Et5/1/3   connected 1          full      50G        100GBASE-SR4
```



```
Et5/1/4          errdisabled 1          unconf unconf 100GBASE-
SR4
<-----OUTPUT OMITTED FROM EXAMPLE----->
```

10.1.5.8.3 Configuring a QSFP100 Module as a Single 40GbE Interface

To configure the port as a single 40GbE interface, combine the modules four data lanes by using the **speed** command (**speed 40gfull**) on the ports /1 lane (the primary lane).

 **Note:**

Use of the **speed** command to configure a multi-lane port is hitless on the 7050X, 7060X, 7250X, 7260X, 7280SE, 7300X, 7320X and 7500E series platforms. On all other platforms, this command restarts the forwarding agent, which will result in traffic disruption. On 7160 series platforms, use of the **speed** command is hitless, but if the command changes the number of port lanes, packets may be dropped on unrelated ports.

1. Enter interface Ethernet configuration mode for lane /1 of the QSFP100 Ethernet interface.

```
switch(config)#interface ethernet 5/1/1
```

2. Enter the **speed 40gfull** command. Depending on the platform, this command may restart the forwarding agent, disrupting traffic on all ports for 60 seconds or more.

```
switch(config-if-Et5/1/1)#speed 40gfull
```

3. Use the **show interfaces status** command to confirm the change in configuration.

```
switch(config-if-Et5/1/1)#show interfaces status
Port      Name      Status      Vlan      Duplex      Speed      Type
Flags
Et1       Et1       connected   2         full        1G         10GBASE-T
<-----OUTPUT OMITTED FROM EXAMPLE----->
Et5/1/1   Et5/1/1   connected   1         full        40G        100GBASE-SR4
Et5/1/2   Et5/1/2   errdisabled 1         unconf     unconf     100GBASE-SR4
Et5/1/3   Et5/1/3   errdisabled 1         unconf     unconf     100GBASE-SR4
Et5/1/4   Et5/1/4   errdisabled 1         unconf     unconf     100GBASE-SR4
<-----OUTPUT OMITTED FROM EXAMPLE----->
```

10.1.5.8.4 Configuring a QSFP100 Module as Four 10GbE Interfaces

To configure the port as four 10GbE interfaces, use the **speed** command (**speed 10000full**) on the ports /1 lane (the primary lane).

 **Note:** Use of the **speed** command to configure a multi-lane port is hitless on the 7050X, 7060X, 7250X, 7260X, 7280SE, 7300X, 7320X and 7500E series platforms. On all other platforms, this command restarts the forwarding agent, which will result in traffic disruption. On 7160 series platforms, use of the **speed** command is hitless, but if the command changes the number of port lanes, packets may be dropped on unrelated ports.

1. Enter interface Ethernet configuration mode for lane /1 of the QSFP100 Ethernet interface.

```
switch(config)#interface ethernet 5/1/1
```

2. Enter the **speed 10000full** command. Depending on the platform, this command may restart the forwarding agent, disrupting traffic on all ports for 60 seconds or more.

```
switch(config-if-Et5/1/1)#speed 10000full
```

- Use the `show interfaces status` command to confirm the change in configuration.

```
switch(config-if-Et5/1/1)#show interfaces status
Port      Name      Status      Vlan      Duplex      Speed      Type
  Flags
Et1
<-----OUTPUT OMITTED FROM EXAMPLE----->
Et5/1/1   connected  2          full      1G          10GBASE-T
SR4
Et5/1/2   connected  1          full      10G         100GBASE-
SR4
Et5/1/3   connected  1          full      10G         100GBASE-
SR4
Et5/1/4   connected  1          full      10G         100GBASE-
SR4
<-----OUTPUT OMITTED FROM EXAMPLE----->
```

10.1.5.9 CFP2 Ethernet Port Configuration

Each CFP2 module contains ten data lanes. The configuration options available on the port depend on the optic inserted:

- CFP2-100G-LR4 optics operate only in 100GbE mode.
- CF2-100G-ER4 optics operate only 100GbE mode.
- CFP2-100G-XSR10 optics can be configured as a single 100GbE interface or as ten 10GbE interfaces.

When the port is configured as ten 10GbE interface, each lane is active and visible in CLI display commands. When the lanes are combined to form a single 100GbE interface, display commands will show the primary lane as **connected** or **not connected**; all other lanes will be hidden.

The following sections describe the configuration of CFP2 ports.

10.1.5.9.1 Configuring a CFP2 Module as a Single 100GbE Interface

To configure the port as a single 100GbE interface (the default configuration), combine the modules ten data lanes by using the `speed` command (**speed 100gfull**) on the ports /1 lane (the primary lane).

This configuration is available for all pluggable optics.

 **Note:** Use of the `speed` command to configure a multi-lane port is hitless on the 7050X, 7060X, 7250X, 7260X, 7280SE, 7300X, 7320X and 7500E series platforms. On all other platforms, this command restarts the forwarding agent, which will result in traffic disruption. On 7160 series platforms, use of the `speed` command is hitless, but if the command changes the number of port lanes, packets may be dropped on unrelated ports.

- Enter interface Ethernet configuration mode for *lane /1* of the **CFP2** Ethernet interface.

```
switch(config)#interface ethernet 5/1/1
```

- Enter the **speed 100gfull** command. Depending on the platform, this command may restart the forwarding agent, disrupting traffic on all ports for 60 seconds or more.

```
switch(config-if-Et5/1/1)#speed 100gfull
```

- Use the `show interfaces status` command to confirm the change in configuration.

```
switch(config-if-Et5/1/1)#show interfaces status
Port      Name      Status      Vlan      Duplex      Speed      Type
  Flags
Et1
connected  2          full      1G          10GBASE-T
```

```
<-----OUTPUT OMITTED FROM EXAMPLE----->
Et5/1/1      connected 1      full      100G      100GBASE-SR1
Et5/2/1      connected 1      full      100G      100GBASE-SR1
<-----OUTPUT OMITTED FROM EXAMPLE----->
```

10.1.5.9.2 Configuring a CFP2 Module as Ten 10GbE Interfaces

To configure the port as four 10GbE interfaces, use the `speed` command (**speed 10000full**) on the ports /1 lane (the primary lane).

This configuration is available only for CFP2-100G-XSR10 optics.



Note:

Use of the `speed` command to configure a multi-lane port is hitless on the 7050X, 7060X, 7250X, 7260X, 7280SE, 7300X, 7320X and 7500E series platforms. On all other platforms, this command restarts the forwarding agent, which will result in traffic disruption. On 7160 series platforms, use of the `speed` command is hitless, but if the command changes the number of port lanes, packets may be dropped on unrelated ports.

1. Enter interface Ethernet configuration mode for lane /1 of the CFP2 Ethernet interface.

```
switch(config)#interface ethernet 5/1/1
```

2. Enter the `speed 10000full` command. Depending on the platform, this command may restart the forwarding agent, disrupting traffic on all ports for 60 seconds or more.

```
switch(config-if-Et5/1/1)#speed 10000full
```

3. Use the `show interfaces status` command to confirm the change in configuration.

```
switch(config-if-Et5/1/1)#show interfaces status
Port      Name      Status      Vlan Duplex  Speed  Type      Flags
Et1       connected 2          full   1G     10GBASE-T
<-----OUTPUT OMITTED FROM EXAMPLE----->
Et5/1/1   connected 1          full   10G    100GBASE-SR1
Et5/1/2   connected 1          full   10G    100GBASE-SR1
Et5/1/3   connected 1          full   10G    100GBASE-SR1
Et5/1/4   connected 1          full   10G    100GBASE-SR1
Et5/1/5   connected 1          full   10G    100GBASE-SR1
Et5/1/6   connected 1          full   10G    100GBASE-SR1
Et5/1/7   connected 1          full   10G    100GBASE-SR1
Et5/1/8   connected 1          full   10G    100GBASE-SR1
Et5/1/9   connected 1          full   10G    100GBASE-SR1
Et5/1/10  connected 1          full   10G    100GBASE-SR1
<-----OUTPUT OMITTED FROM EXAMPLE----->
```

10.1.5.10 MXP Ethernet Port Configuration

Each MXP module contains twelve data lanes which can be used individually or combined to form one or more higher-speed interfaces. This allows an MXP Ethernet port to be configured as a single 100GbE interface, up to twelve 10GbE interfaces, or a mixture of 40GbE and 10GbE ports.

MXP ports do not use pluggable optics: instead, an MTP-24 ribbon is inserted directly into the port. The remote end of the MTP 24 ribbon must then be broken out using a splitter cable or cartridge based on the operational mode and speed of the MXP port.

When four lanes of an MXP interface are combined to form a 40GbE port, CLI commands will show the primary lane of that group as **connected or not connected** and the other three lanes as **errdisabled**.

The following sections describe the configuration of MXP interfaces.

10.1.5.10.1 Configuring an MXP Module as a Single 100GbE Interface

To configure the port as a single 100GbE interface (the default configuration), enter the [speed](#) command (**speed 100gfull**) on the ports /1 lane (the primary lane). This combines lanes 1-10 and disables lanes 11 and 12.

Under this configuration, CLI display commands will show lane /1 as **connected** or **not connected**, and show lanes /2-/12 as **errdisabled**.

 **Note:** Use of the **speed** command to configure a multi-lane port is hitless on the 7050X, 7060X, 7250X, 7260X, 7280SE, 7300X, 7320X and 7500E series platforms. On all other platforms, this command restarts the forwarding agent, which will result in traffic disruption. On 7160 series platforms, use of the **speed** command is hitless, but if the command changes the number of port lanes, packets may be dropped on unrelated ports.

1. Enter interface Ethernet configuration mode for lane /1 of the MXP Ethernet interface.

```
switch(config)#interface ethernet 5/49/1
```

2. Enter the **speed 100gfull** command. Depending on the platform, this command may restart the forwarding agent, disrupting traffic on all ports for 60 seconds or more.

```
switch(config-if-Et5/49/1)#speed 100gfull
```

3. Use the [show interfaces status](#) command to confirm the change in configuration.

```
switch(config-if-Et5/49/1)#show interfaces status
```

Port	Name	Status	Vlan	Duplex	Speed	Type
Et1		connected	2	full	1G	10GBASE-T
<-----OUTPUT OMITTED FROM EXAMPLE----->						
Et5/49/1		connected	1	full	100G	100GBASE-SR1
Et5/49/2		errdisabled	1	unconf	unconf	100GBASE-SR1
Et5/49/3		errdisabled	1	unconf	unconf	100GBASE-SR1
Et5/49/4		errdisabled	1	unconf	unconf	100GBASE-SR1
Et5/49/5		errdisabled	1	unconf	unconf	100GBASE-SR1
Et5/49/6		errdisabled	1	unconf	unconf	100GBASE-SR1
Et5/49/7		errdisabled	1	unconf	unconf	100GBASE-SR1
Et5/49/8		errdisabled	1	unconf	unconf	100GBASE-SR1
Et5/49/9		errdisabled	1	unconf	unconf	100GBASE-SR1
Et5/49/10		errdisabled	1	unconf	unconf	100GBASE-SR1
Et5/49/11		errdisabled	1	unconf	unconf	100GBASE-SR1
Et5/49/12		errdisabled	1	unconf	unconf	100GBASE-SR1

10.1.5.10.2 Configuring an MXP Module With 40GbE Interfaces

Each set of four lanes on the MXP module is independently configurable as a single 40GbE interface or four 10GbE interfaces. To configure four lanes as a single 40GbE interface, enter the [speed](#) command (**speed forced 40gfull**) on the groups primary lane (/1, /5, or /9). To revert a group of four lanes to functioning as four independent 10GbE interfaces, enter the **speed 10000full** command on the primary lane of the group.

When four lanes of an MXP interface are combined to form a 40GbE port, CLI commands will show the primary lane of that group as **connected** or **not connected** and the other three lanes as **errdisabled**. In groups of four lanes which are configured as four independent 10GbE interfaces, each lane will be displayed in the CLI as **connected** or **not connected**.

Note that a **speed forced 100gfull** command entered on the /1 lane takes precedence over **speed 40gfull** commands on the /5 and /9 lanes.

 **Note:** Use of the **speed** command to configure a multi-lane port is hitless on the 7050X, 7060X, 7250X, 7260X, 7280SE, 7300X, 7320X and 7500E series platforms. On all other platforms, this command restarts the forwarding agent, which will result in traffic disruption. On 7160 series platforms, use of the **speed** command is hitless, but if the command changes the number of port lanes, packets may be dropped on unrelated ports.

The example below shows the steps for configuring an MXP module as three 40GbE interfaces.

1. Enter interface Ethernet configuration mode for lane /1 of the MXP Ethernet interface.

```
switch(config)#interface ethernet 5/49/1
```

2. Enter the **speed 40gfull** command. Depending on the platform, this command may restart the forwarding agent, disrupting traffic on all ports for 60 seconds or more.

```
switch(config-if-Et5/49/1)#speed 40gfull
```

3. Repeat the above steps for **lanes /5 and /9**.

```
switch(config-if-Et5/49/1)#interface ethernet 5/49/5
switch(config-if-Et5/49/5)#speed 40gfull
switch(config-if-Et5/49/5)#interface ethernet 5/49/9
switch(config-if-Et5/49/9)#speed 40gfull
```

4. Use the **show interfaces status** command to confirm the change in configuration.

```
switch(config-if-Et5/49/9)#show interfaces status
Port Name Status Vlan Duplex Speed Type Flags
Et1      connected 2      full 1G      10GBASE-T
<-----OUTPUT OMITTED FROM EXAMPLE----->
Et5/49/1 connected 1      full 40G     100GBASE-SR1
Et5/49/2 errdisabled 1      unconf unconf 100GBASE-SR1
Et5/49/3 errdisabled 1      unconf unconf 100GBASE-SR1
Et5/49/4 errdisabled 1      unconf unconf 100GBASE-SR1
Et5/49/5 connected 1      full 40G     100GBASE-SR1
Et5/49/6 errdisabled 1      unconf unconf 100GBASE-SR1
Et5/49/7 errdisabled 1      unconf unconf 100GBASE-SR1
Et5/49/8 errdisabled 1      unconf unconf 100GBASE-SR1
Et5/49/9 connected 1      full 40G     100GBASE-SR1
Et5/49/10 errdisabled 1      unconf unconf 100GBASE-SR1
Et5/49/11 errdisabled 1      unconf unconf 100GBASE-SR1
Et5/49/12 errdisabled 1      unconf unconf 100GBASE-SR1
```

10.1.5.10.3 Configuring an MXP Module as Twelve 10GbE Interfaces

Each lane of an MXP port functions as a 10GbE interface when it is not included in a higher-speed interface configuration (either actively or as an **errdisabled** port).

To explicitly configure the port as twelve 10GbE interfaces, use the **speed** command (**speed 10000full**) on all twelve lanes of the port.

When each lane is configured as an independent 10GbE interface, CLI display commands show each lane as **connected** or **not connected**.



Note: Use of the **speed** command to configure a multi-lane port is hitless on the 7050X, 7060X, 7250X, 7260X, 7280SE, 7300X, 7320X and 7500E series platforms. On all other platforms, this command restarts the forwarding agent, which will result in traffic disruption. On 7160 series platforms, use of the **speed** command is hitless, but if the command changes the number of port lanes, packets may be dropped on unrelated ports.

1. Enter interface Ethernet configuration mode for all twelve lanes of the MXP Ethernet interface.

```
switch(config)#interface ethernet 5/49/1-12
```

2. Enter the **speed 10000full** command. Depending on the platform, this command may restart the forwarding agent, disrupting traffic on all ports for 60 seconds or more.

```
switch(config-if-Et5/49/1-12)#speed 10000full
```

- Use the `show interfaces status` command to confirm the change in configuration.

```
switch(config-if-Et5/49/1-12)#show interfaces status
Port      Name      Status      Vlan      Duplex      Speed      Type      Flags
Et1       Et1       connected   2         full        1G        10GBASE-T
<-----OUTPUT OMITTED FROM EXAMPLE----->
Et5/1/1   Et5/1/1   connected   1         full        10G       100GBASE-SR1
Et5/1/2   Et5/1/2   connected   1         full        10G       100GBASE-SR1
Et5/1/3   Et5/1/3   connected   1         full        10G       100GBASE-SR1
Et5/1/4   Et5/1/4   connected   1         full        10G       100GBASE-SR1
Et5/1/5   Et5/1/5   connected   1         full        10G       100GBASE-SR1
Et5/1/6   Et5/1/6   connected   1         full        10G       100GBASE-SR1
Et5/1/7   Et5/1/7   connected   1         full        10G       100GBASE-SR1
Et5/1/8   Et5/1/8   connected   1         full        10G       100GBASE-SR1
Et5/1/9   Et5/1/9   connected   1         full        10G       100GBASE-SR1
Et5/1/10  Et5/1/10  connected   1         full        10G       100GBASE-SR1
<-----OUTPUT OMITTED FROM EXAMPLE----->
```

10.1.5.11 Port Speed Capabilities

The supported speeds supported on each Arista platform per interface type are described in [Supported Speeds \(GbE\)](#).

Table 59: Supported Speeds (GbE)

Platform	SFP+	SFP28	QSFP+	QSFP100	MXP	CFP2
7050	100M, 1, 10	N/A	1, 10, 40	N/A	N/A	N/A
7050X	100M, 1, 10	N/A	1, 10, 40	N/A	10, 40	N/A
7050X2	100M, 1, 10	N/A	1, 10, 40	N/A	N/A	N/A
7050X3	100M, 1, 10	1, 10, 25	N/A	10, 25, 40, 50, 100	N/A	N/A
7250X	N/A	N/A	1, 10, 40	N/A	N/A	N/A
7060X	100M, 1, 10	N/A	N/A	10, 25, 40, 50, 100	N/A	N/A
7060X2	100M, 1, 10	1, 10, 25	N/A	10, 25, 40, 50, 100	N/A	N/A
7260X3	100M, 1, 10	N/A	N/A	10, 25, 40, 50, 100	N/A	N/A
7300X	100M, 1, 10	N/A	1, 10, 40	N/A	N/A	N/A
7300X3	N/A	1, 10, 25	N/A	10, 25, 40, 50, 100	N/A	N/A
7320X	N/A	N/A	N/A	10, 25, 40, 50, 100	N/A	N/A
7150S	1, 10	N/A	1, 10, 40	N/A	N/A	N/A

7048T	1, 10	N/A	N/A	N/A	N/A	N/A
7500	1, 10	N/A	1, 10, 40	N/A	N/A	N/A
7500E	1, 10	N/A	1, 10, 40	10, 40, 100	10, 40, 100	100
7500R	1, 10	1, 10, 25	1, 10, 40	10, 25, 40, 50, 100	N/A	N/A
7280SE	1, 10	N/A	1, 10, 40	10, 40, 100	10, 40, 100	N/A
7280QR	N/A	N/A	1, 10, 40	10, 25, 40, 50, 100	N/A	N/A
7280SR (R2)	1, 10	1, 10, 25	N/A	10, 25, 40, 50, 100	N/A	100, 200
7280CR	N/A	N/A	N/A	10, 25, 40, 50, 100	N/A	N/A
7010T	100M, 1, 10	N/A	N/A	N/A	N/A	N/A

10.1.5.12 Agile Ports

An agile port is an interface that can function as a 10G port or can subsume a predefined set of 10G interfaces to form an interface with higher speed capabilities.

The set of interfaces that can be combined to form a higher speed port is restricted by the hardware configuration. Only interfaces that pass through a common PHY component can be combined. One interface within a combinable set is designated as the primary port.

- To view the set of available agile ports and the subsumable interfaces that comprise them, enter `show platform fm6000 agileport map`.
- To configure the primary port as a higher speed port, enter `speed 40gfull` or `speed auto 40gfull`.
- To revert the primary port and its subsumed ports to 10G interfaces, enter `no speed`.

10.1.5.13 Subinterface Configuration

For a subinterface to be operational on an Ethernet or port channel interface, the parent interface must be configured as a routed port and be administratively up, and a VLAN must be configured on the subinterface. If the parent interface goes down, all subinterfaces automatically go down as well, but will come back up with the same configuration once the parent interface is up.

Note that a port channel should not contain Ethernet interfaces with subinterfaces configured on them, and that subinterfaces cannot be members of a port channel.

Subinterfaces are named by adding a period followed by a unique subinterface number to the name of the parent interface. Note that the subinterface number has no relation to the ID of the VLAN corresponding to the subinterface.

Subinterfaces are available on the following platforms:

- DCS-7050X
- DCS-7060X
- DCS-7250X

- DCS-7260X
- DCS-7280E
- DCS-7300X
- DCS-7320X
- DCS-7500E

10.1.5.13.1 Creating a Subinterface

To create a subinterface on an Ethernet or port channel interface:

1. Bring up the parent interface and ensure that it is configured as a routed port.

```
switch(config)#interface Ethernet1/1
switch(config-if-Et1/1)#no switchport
switch(config-if-Et1/1)#no shutdown
```

2. Configure a VLAN on the subinterface. The `encapsulation dot1q vlan` command is also used for VLAN translation, but in this context it associates a VLAN with the subinterface.

```
switch(config-if-Et1/1)#interface Ethernet1/1.1
switch(config-if-Et1/1.1)#encapsulation dot1q vlan 100
```

3. Configure an IP address on the subinterface (optional) and ensure that it is up.

```
switch(config-if-Et1/1)#ip address 10.0.0.1/24
switch(config-if-Et1/1)#no shutdown
switch(config-if-Et1/1)#
```

10.1.5.13.2 Creating a Range of Subinterfaces

A range of subinterfaces can also be configured simultaneously. The following example configures subinterfaces 1 to 100 on Ethernet interface 1/1, and assigns VLANs 501 through 600 to them. Note that the range of interfaces must be the same size as the range of VLAN IDs.

Example

```
switch(config)#interface eth1/1.1-100
switch(config-if-Et1/1.1-100)#no shutdown
switch(config-if-Et1/1.1-100)#encapsulation dot1q vlan {501,600}
switch(config-if-Et1/1.1-100)#exit
switch(config)#
```

10.1.5.13.3 Parent Interface Configuration

For subinterfaces to function, the parent interface must be administratively up and configured as a routed port.

Some settings are inherited by subinterfaces from the parent interface. These include QoS (trust mode and default DSCP) and MTU.

Additionally, on the DCS-7050X, DCS-7250X, and DCS-7300X platforms, the parent interface may be configured with an IP address. In this case, untagged packets are treated as incoming traffic on the parent interface

10.1.5.13.4 Configuring Routing Features on a Subinterface

Once a subinterface is created, the following features can be configured on it:

- Unicast and multicast routing
- BGP, OSPF, ISIS, PIM
- VRF
- VRRP
- SNMP
- Inheritance of QoS (trust mode and default DSCP) and MTU settings from the parent interface

Additionally, these features can be configured on subinterfaces on Arad (DCS-7500E and DCS-7280E) platforms:

- Subinterface counters on ingress
- VXLAN
- MPLS
- GRE
- PBR
- QoS

10.1.5.13.5 Displaying Subinterface Information

Subinterface information is displayed using the same show commands as for other interfaces.

Examples

- This command displays summary information for all IP interfaces on the switch, including subinterfaces.

```
switch#show ip interfaces brief
Interface          IP Address      Status   Protocol   MTU
Ethernet1/1        10.1.1.1/24up   up       1500
Ethernet1/1.1      10.0.0.1/24up   up       1500
Ethernet1/2        unassigned      up       up         1500
```

- This command displays information for subinterface Ethernet 1/1.1.

```
switch#show interface ethernet 1/1.1
Ethernet1/1.1 is down, line protocol is lowerlayerdown (notconnect)
Hardware is Subinterface, address is 001c.735d.65dc
Internet address is 10.0.0.1/24
Broadcast address is 255.255.255.255
Address determined by manual configuration
IP MTU 1500 bytes , BW 10000000 kbit
Down 59 seconds
switch>
```

- This command displays status information for all subinterfaces configured on the switch.

```
switch#show interfaces status sub-interfaces
Port      Name      Status   Vlan    Duplex   Speed   Type              Flags
Et1.1     connect  101     full    10G     dot1q-encapsulation
Et1.2     connect  102     full    10G     dot1q-encapsulation
Et1.3     connect  103     full    10G     dot1q-encapsulation
Et1.4     connect  103     full    10G     dot1q-encapsulation
```

10.1.5.14 Maximum Latency Tail-drop Thresholds

The maximum latency for Tail-drop thresholds can be configured in interface configuration mode or in the QoS profile. **QoS profile** configuration mode is a group change mode.

Example

These commands configure the maximum latency value for VOQ tail-drop threshold on transmit queue 3 on Ethernet1 interface. The latency value can be specified to a maximum of 50 ms. Both milliseconds and microseconds may be used.

```
switch(config)#interface Ethernet1
switch(config-if-Et1)#tx-queue 3
switch(config-if-Et1-txq-3)#latency maximum <1-50000> microseconds
switch(config-if-Et1-txq-3)#latency maximum <1-50> milliseconds
switch(config)#
```

10.1.5.15 Autonegotiated Settings

In autonegotiation, the transmission speed, duplex setting, and flow control parameters used for Ethernet-based communication can be automatically negotiated between connected devices to establish optimized common settings.

10.1.5.15.1 Speed and Duplex

The **speed** command affects the transmission speed and duplex setting for the configuration mode interface. When a **speed** command is in effect on an interface, autonegotiation of speed and duplex settings is disabled for the interface; to enable autonegotiation, use the **speed auto** command.

The scope and effect of the **speed** command depends on the interface type; see [Ethernet Interfaces](#) and [Ethernet Configuration Procedures](#) for detailed information on the speed settings for different interfaces.

10.1.5.15.2 Flow Control

Flow control is a data transmission option that temporarily stops a device from sending data because of a peer data overflow condition. If a device sends data faster than the receiver can accept it, the receiver's buffer can overflow. The receiving device then sends a PAUSE frame, instructing the sending device to halt transmission for a specified period.

Flow control commands configure administrative settings for flow control packets.

- The **flowcontrol receive** command configures the port's ability to receive flow control pause frames.
 - **off**: port does not process pause frames that it receives.
 - **on**: port processes pause frames that it receives.
 - **desired**: port autonegotiates; processes pause frames if peer is set to **send** or **desired**.
- The **flowcontrol send** command configures the port's ability to transmit flow control pause frames.
 - **off**: port does not send pause frames.
 - **on**: port sends pause frames.
 - **desired**: port autonegotiates; sends pause frames if peer is set to **receive** or **desired**.

Desired is not an available parameter option. Ethernet data ports cannot be set to **desired**. Management ports are set to **desired** by default and with the **no flowcontrol receive** command.

The port linking process includes flow control negotiation. Ports must have compatible flow control settings to create a link. [Compatible Settings for Flow Control Negotiation](#) lists the compatible flow control settings.

Table 60: Compatible Settings for Flow Control Negotiation

local port	peer port
receive on	send on or send desired
receive off	send off or send desired

receive desired	send on , send off, or send desired
send on	receive on or receive desired
send off	receive off or receive desired
send desired	receive on , receive off, or receive desired

Example

These commands set the flow control receive and send to **on** on *Ethernet interface 5*.

```
switch(config)#interface ethernet 5
switch(config-if-Et5)#flowcontrol receive on
switch(config-if-Et5)#flowcontrol send on
switch(config-if-Et5)#
```

10.1.5.16 Displaying Ethernet Port Properties

Show commands are available to display various Ethernet configuration and operational status on each interface. Ethernet settings that are viewable include:

- Port Type
- PHY Status
- Negotiated Settings
- Flow Control
- Capabilities

Port Type

The port type is viewable from the output of [show interfaces status](#), [show interfaces hardware](#), and [show interfaces transceiver properties](#) commands.

Examples

- This **show interfaces status** command displays the status of Ethernet interfaces 1-5.

```
switch#show interfaces status
Port      Name      Status      Vlan      Duplex  Speed  Type
Et1       Et1       connected   1         full    10G    10GBASE-SRL
Et2       Et2       connected   1         full    10G    10GBASE-SRL
Et3       Et3       connected   1         full    10G    10GBASE-SRL
Et4       Et4       connected   1         full    10G    10GBASE-SRL
Et5       Et5       notconnect  1         full    10G    Not Present
switch>
```

- This **show interfaces hardware** command displays the speed, duplex, and flow control capabilities of Ethernet interfaces 2 and 18.

```
switch#show interfaces ethernet 2,18 hardware
Ethernet2
  Model:          DCS-7150S-64-CL
  Type:           10GBASE-CR
  Speed/Duplex:  10G/full, 40G/full, auto
  Flowcontrol:   rx-(off,on,desired), tx-(off,on,desired)
Ethernet18
  Model:          DCS-7150S-64-CL
  Type:           10GBASE-SR
  Speed/Duplex:  10G/full
  Flowcontrol:   rx-(off,on), tx-(off,on)
switch>
```

- This command displays the media type, speed, and duplex properties for Ethernet interfaces 1.

```
switch#show interfaces ethernet 1 transceiver properties
Name : Et1
Administrative Speed: 10G
Administrative Duplex: full
Operational Speed: 10G (forced)
Operational Duplex: full (forced)
Media Type: 10GBASE-SRL
```

PHY

PHY information for each Ethernet interface is viewed by entering the [show interfaces phy](#) command.

Example

This command summarizes PHY information for Ethernet interfaces 1-3.

```
switch#show interfaces ethernet 1-3 phy
Key:
U   = Link up
D   = Link down
R   = RX Fault
T   = TX Fault
B   = High BER
L   = No Block Lock
A   = No XAUI Lane Alignment
0123 = No XAUI lane sync in lane N

Port          PHY state      State      Reset
              Changes      Count     PMA/PMD  PCS      XAUI
-----
Ethernet1     linkUp         14518     1750    U..      U....  U.....
Ethernet2     linkUp         13944     1704    U..      U....  U.....
Ethernet3detectingXcvr  3           1         D..A0123
switch>
```

Negotiated Settings

Speed, duplex, and flow control settings are displayed through the [show interfaces hardware](#), [show interfaces phy](#), [show interfaces flow-control](#), and [show interfaces status](#) commands.

Examples

- This command displays speed/duplex and flow control settings for Ethernet interface 1.

```
switch#show interfaces ethernet 1 hardware
Ethernet1
  Model:          DCS-7150S-64-CL
  Type:           10GBASE-SR
  Speed/Duplex:  10G/full
  Flowcontrol:    rx-(off,on),tx-(off,on)
switch>
```

- This command shows the flow control settings for Ethernet interfaces 1-2.

```
switch#show flow-control interface ethernet 1-2
Port          Send FlowControl  Receive FlowControl  RxPause  TxPause
              admin   oper    admin   oper
-----
Et1           off    off     off     off     0       0
Et2           off    off     off     off     0       0
switch>
```

- This command displays the speed type and duplex settings for management interfaces 1-2.

```
switch#show interfaces management 1-2 status
Port          Name          Status          Vlan          Duplex  Speed Type
```

```

Ma1          connected    routed    a-full  a-100M 10/100/1000
Ma2          connected    routed    a-full  a-1G 10/100/1000
switch>

```

10.1.5.17 Ingress Counters

The Ingress counters enables the switch to count the ingress traffic on the Layer 3 ports of the switch.

Any ingress traffic on Layer 3 sub-interfaces and VLAN interface with IPv4 and IPv6 addresses are accounted irrespective of the routing decision. The VLAN counters are supported on DCS- 7050x, DCS-7250x, and DCS-7300x series switches and not supported on any routed ports.

10.1.5.17.1 Configuring Ingress Counters

The hardware counter feature in command enables the switch to count the ingress traffic on the Layer 3 port of the switch. Any traffic on Layer 3 sub-interfaces and VLAN interface with IPv4 and IPv6 addresses are accounted irrespective of the routing decision.

Examples

- This command configures the ingress traffic count on the sub-interfaces. The no form of the command disable the counter configuration from the switch ports.

```
switch#hardware counter feature subinterface in
```

- This command configures the ingress traffic count on the VLAN interface. The no form of the command disable the counter configuration from the VLAN configured switch ports.

```
switch#hardware counter feature vlan-interface in
```

10.1.5.17.2 Displaying the Ingress Counter Information

The show interface counters command displays the Layer 3 ingress traffic count information. Run this command to view the traffic counts on a sub-interface or VLAN interface of the switch. The clear counters command resets the counters to zero.

Example

- This command displays the ingress traffic count on a VLAN interface vl12.

```

switch#show interface vl12 counters incoming
L3 Interface InOctets InUcastPkts InMcastPkts
Vl12          3136          47          2

```

10.1.5.18 Configuring Ingress Traffic-Class Counters

Ingress traffic class counter support is enabled in order to display per traffic-class counters on ingress interfaces, and supported on routed-ports and subinterfaces. Both packet and octet counts are displayed.

Examples

- This command enables traffic-class counter support.

```
switch(config)#hardware counter feature traffic-class in
```

- This command enables TCAM profile tc-counters if this profile is configured.

```
switch(config)#hardware tcam profile tc-counters
```

10.1.5.19 Hardware Counter Support

Hardware counter support allows enabling counters for features using programmable hardware counter resources.

Hardware counter support can be used to count the following feature specific counters:

- Ingress VLAN-interface counters count the packets/octets ingressing through a VLAN interface.
- Egress VLAN-interface counters count the packets/octets egressing a VLAN interface.
- Ingress subinterface counters count the packets/octets ingressing through a subinterface.
- Egress subinterface counters count the packets/octets egressing a subinterface.
- VXLAN VNI counters count the packets/octets encapsulated/decapsulated per VNI.
- VXLAN VTEP counters count the packets/octets encapsulated/decapsulated per VTEP.
- Route counter for IPv4/IPv6 routes count the packets/octets routed using the route entry.
- Ingress GRE Tunnel Interface counters count the packets/octets ingressing through the GRE Tunnel Interface.
- Egress GRE Tunnel Interface counters count the packets/octets egressing through the GRE Tunnel Interface.

10.1.5.19.1 Hardware Counter Support Platform Compatibility

Hardware counter support is compatible with the following platforms:

- 7050X3 Series (beginning in *EOS-Release 4.22.1F*)
- 7050X Series
- 7050QX Series
- 7060X Series (beginning in *EOS-Release 4.22.1F*)
- 7260X Series (beginning in *EOS-Release 4.22.1F*)
- 7060X4 Series (beginning in *EOS-Release 4.24.1F*)
- 7300X Series
- 7320X Series (beginning in *EOS-Release 4.22.1F*)
- 7368 Series (beginning in *EOS-Release 4.24.1F*)
- 720 Series (beginning in *EOS-Release 4.23.2F*)

10.1.5.19.2 Hardware Counter Support Configuration

You can enable the Hardware Counter feature on a per-feature basis using the **hardware counter feature** command. The **no hardware counter feature** disables the feature. Multiple ingress and egress hardware counter features can work concurrently. Review [Limitations](#) for details.

 **Note:** Enabling the hardware counter features may impact the transit traffic.

10.1.5.19.2. Ingress VLAN Interface Counters

The **hardware counter feature vlan-interface in** command enables the counting of ingress VLAN interface counters. When configured, the switch counts the number of unicast packets, multicast packets, and total octets ingressing through the VLAN interface for every VLAN interface configured in the system.

Example

```
switch#[no]hardware counter feature vlan-interface in
```

10.1.5.19.2. Egress VLAN Interface Counters

The **hardware counter feature vlan-interface out** command enables the counting of egress VLAN interface counters. When configured, the switch counts the number of unicast packets, multicast packets, and total octets egressing the VLAN interface for every VLAN interface configured in the system.

Example

```
switch#[no]hardware counter feature vlan-interface out
```

10.1.5.19.2. Ingress SubInterface Counters

The **hardware counter feature subinterface in** command enables the counting of ingress subinterface counters. When configured, the switch counts the number of unicast packets, multicast packets, and total octets ingressing through the subinterface for every L3 subinterface configured in the system.

Example

```
switch#[no]hardware counter feature subinterface in
```

10.1.5.19.2. Egress SubInterface Counters

The **hardware counter feature subinterface out** command enables the counting of egress subinterface counters. When configured, the switch counts the number of unicast packets, multicast packets, and total octets egressing the subinterface for every L3 subinterface configured in the system.

Example

```
switch#[no]hardware counter feature subinterface out
```

10.1.5.19.2. VXLAN VNI Encapsulation Counters

The **hardware counter feature vni encap** command enables the counting of per VNI encap counters. When enabled, the switch counts the number of packets and bytes egressing a VNI through VTI, encap BUM packets, and the number of encap packets dropped due to any reason.

Example

```
switch(config)# [no]hardware counter feature vni encap
```

10.1.5.19.2. VXLAN VNI Decapsulation Counters

The **hardware counter feature vni decap** command enables the per VNI decap counters. When enabled, the switch counts the number of packets/octets received from VTEP and decapsulated for each VNI.

Example

```
switch(config)#[no]hardware counter feature vni decap
```

10.1.5.19.2.Route Counters

The **hardware counter feature route** command configures the route counters for the specified IP version and ip-address/ip-prefix. When enabled, the switch counts the number of packets/bytes hitting a route. The VRF name is optional and default VRF is assumed if no VRF is specified.

Example

```
switch(config)#[no]hardware counter feature route[ipv4|ipv6]vrf  
<name>] [ip-address|ip-address-prefix]
```

10.1.5.19.2.GRE Tunnel Interface Encapsulation Counters

The **hardware counter feature gre tunnel interface out** command enables GRE Tunnel Interface encap counters. When enabled, the switch counts the number of unicast GRE packets and total octets getting encapsulated on the Tunnel Interface.

Example

```
switch(config)#[no]hardware counter feature gre tunnel interface  
out
```

10.1.5.19.2.GRE Tunnel Interface Decapsulation Counters

The **hardware counter feature gre tunnel interface in** command enables GRE Tunnel Interface decap counters. When enabled, the switch counts the number of unicast GRE packets and total octets getting decapsulated on the Tunnel Interface.

Example

```
switch(config)#[no]hardware counter feature gre tunnel interface  
in
```

10.1.5.19.3 Show Commands

Use the **show interface counters** command to display the VLAN interface, subinterface, GRE tunnel interface Ingress and Egress counters. The command display output includes the L3 interfaces when the corresponding hardware counter feature is enabled.

Example

```
switch#show interface counters  
L3 Interface      InOctets      InUcastPkts    InMcastPkts  
Vl12              0              0              0
```

Et1.1	0	0	0
Tun1	0	0	0
	InOctets	InPkts	
L3 Interface	OutOctets	OutUcastPkts	OutMcastPkts
Vl12	0	0	0
Et1.1	0	0	0
Tun1	0	0	0
	OutOctets	OutPkts	

The VLAN interface, subinterface, and GRE Tunnel Interface ingress counters can be obtained from the `show interface counters` command.

Platform Commands

Use the `show platform trident flexcounters l3intf in summary` platform command to display the details of the hardware resources allocated to the ingress subinterface, SVI, and GRE Tunnel Interface features.

Example

```
switch#show platform trident flexcounters l3intf in summary
```

Use the `show platform trident flexcounters l3intf out summary` platform command to display the details of the hardware resources allocated to the egress subinterface, SVI, and GRE Tunnel Interface features.

Example

```
switch#show platform trident flexcounters l3intf out summary
```

Use the `show platform trident flexcounters l3intf out values` platform command to display the counters in the counter and snapshot table for the ingress subinterface SVI and GRE Tunnel Interface features.

Example

```
switch#show platform trident flexcounters l3intf in values
```

Use the `show platform trident flexcounters l3intf out values` platform command to display the counters in the counter and snapshot table for the egress subinterface, SVI features, and GRE Tunnel Interface.

Example

```
switch#show platform trident flexcounters l3intf out values
```



Note: The counter values in this show command output are not reset by the `clear counters` command.

Use the `clear counters` command to clear the VLAN interface, subinterface ingress, and egress counters.

Example

```
switch#clear counters[vlan<vlanId>]
```

Use the `tunnel` command to clear GRE tunnel interface ingress and egress counters.

```
switch#tunnel<TunnelId>
```

The `clear counters` command in the **Privileged EXEC** mode resets the counters to zero for the specified interfaces including VLAN interfaces, subInterfaces, and GRE tunnel interface.

The optional `vlan <vlanid>` argument allows you to use the command for clearing counters only for the specified VLAN interface.

Displaying VXLAN VNI/VTEP Counters

Use the `show vxlan counters vni` to display the encapsulation and decapsulation counters at the VNI.

The following command displays the encapsulation related commands at the VNI.

Example

```
switch#show vxlan counters vni encap
```

VNI	Encap Bytes	Encap Packets	Encap BUM Packets	Encap Drop Packets
2824963	0	0	0	0
7023745	0	0	0	0

Encap packets display the total count of L2 packets that have been successfully encapsulated by the VNI towards the VTEP.

Encap drop or exception packets display the total count of L2 packets that have been encapsulated and dropped for any reason.

Use the `show vxlan counters vni decap` command to display the decapsulation related counters at the VNI.

Example

```
switch#show vxlan counters vni decap
```

VNI	Decap Bytes	Decap Known Unicast Packets	Decap BUM Packets	Decap Drop Or Exception Packets
2824963	0	0	0	0
7023745	0	0	0	0

Decap Known UnicastPkts display the total count of L2 known unicast packets coming into the VTI hitting the VTEP and getting decapsulated.

Decap BUM packets display the total count of L2 BUM packets coming into the VTI hitting the VTEP and getting decapsulated.

Decap drop or exception packets display the count of L2 packets coming into the VTI and getting dropped for any reason.

Platform Commands

Use the following show platform commands to display the details of the hardware resources allocated to the respective feature.

```
switch#show platform trident flexcounters vni egress summary
switch#show platform trident flexcounters vni ingress summary
switch#show platform trident flexcounters vtep decap summary
switch#show platform trident flexcounters vtep encap summary
```

Use the following show platform commands to display the counters in the counter and snapshot table for the respective feature. Note that the counter values in these show command outputs are not reset by the `clear` command.

```
switch#show platform trident flexcounters vni egress values
switch#show platform trident flexcounters vni ingress values
switch#show platform trident flexcounters vtep decap values
switch#show platform trident flexcounters vtep encap values
```

Use the `clear vxlan counters vni` to clear VXLAN counters. Use the optional VNI argument to clear the counters for the specified VNI.

```
switch#clear vxlan counters vni[vnis]
```

Use the optional `[vtep-ip-address|unlearned]` VTEP argument can to clear the counters for the specified VTEP. Use the `unlearned` option to clear the counters for unlearned VTEPs. Unlearned VTEPs track the counts of packets received by the switch before the VTEP is learned.

Route Counters

Use the `show route counters` command to display the prefix, packet count, and byte count of the IPv4 or IPv6 VRF.

```
show route[ipv6|ipv4] counters
```

Example

```
switch#show route ipv4 counters
Vrf Name          Prefix          Packet Count    Byte Count
-----
default          22.0.0.0/8      0               0
default          32.0.0.0/8      0               0
```

Clearing Route Counters

The `clear counters` command also clears the route counters. The optional `route` keyword allows the `clear` command to only clear the route counters. The optional `ipv4` and `ipv6` keywords allows \ the command to target the clearing of ipv4 or ipv6 route counters. The optional `vrf` keyword allows specifying the VRF to only clear the route counters for the VRF.

```
clear counters[route][ipv4|ipv6][vrf]
```

10.1.5.19.4 Limitations

- The number of features for which the hardware counters can be enabled simultaneously is limited by the availability of counter hardware resources in the system. When the configured hardware features exceed the available counter resources, not all counters for all features are available.
- At lower scales of the feature key (for example, the number of interfaces in the case of subinterface/SVI counters), you can typically concurrently support up to six (6) ingress features

and three (3) egress features. As scales grow beyond table sizes, single features use multiple tables.

- On the CCS-720 series, you can support up to three (3) ingress features and three (3) egress features.
- Route counters do not support the counting of host routes or ALPM routes.
- The 7060X4 and 7368 platforms do not support route counters.
- Packets sent from the CPU are not included in egress counters.

10.1.5.20 Configuring Power over Ethernet (PoE)

Power over Ethernet (PoE) is enabled by default on all Ethernet ports of PoE-capable switches, and the switch will detect IEEE-compliant powered devices (PDs) when they are plugged into a port and supply power appropriately.

Limitations

- Ethernet ports will not detect non IEEE-compliant devices by default, and may not be able to detect or power them even if configured to do so.
- If attached PDs overload the switch, it will power off. This can occur when an attached PD increases its power demand via LLDP, when too many PDs are connected to the switch, or when a power supply fails on a heavily loaded dual-supply switch.
- Power-cycling the switch will cause temporary loss of power to attached PDs.
- PoE is not available on management interfaces.

Disabling PoE on an Interface

On switches which support PoE, it is enabled by default on all Ethernet ports but can be disabled per-port with the [poe disabled](#) command.

Example

- These commands disable PoE on Ethernet interface 5.

```
switch(config)#interface ethernet 5
switch(config-if-Et5)#poe disabled
switch(config-if-Et5)#
```

PoE Power Settings

When an IEEE-compliant powered device (PD) is connected to a PoE-enabled Ethernet port, it is recognized by a specific resistor signature, and its initial power needs are determined by hardware negotiation, after which further negotiation is managed through the Link Layer Discovery Protocol (LLDP). For details, see [Configuring LLDP for Power over Ethernet](#).

PoE power output can be limited on a port using the [poe limit](#) command. The power limit represents the power output at the Ethernet port; actual power delivered to the PD will be lower due to power loss along the Ethernet cable.

 **Note:** LLDP uses Power Via MDI type-length-value elements (TLVs) to allow the switch to dynamically negotiate power needs with PDs. LLDP will not include Power Via MDI TLVs for the interface if a power limit has been configured on it.

Examples

- These commands limit nominal PoE power output on Ethernet interface 5 to 10 W.

```
switch(config)#interface ethernet 5
switch(config-if-Et5)#poe limit 10 watts
switch(config-if-Et5)#
```

- These commands limit nominal PoE power output on Ethernet interface 7 to 4 W.

```
switch(config)#interface ethernet 7
switch(config-if-Et7)#poe limit class 1
switch(config-if-Et7)#
```

Detecting Legacy PDs

IEEE-compliant powered devices (PDs) are recognized by a specific resistance signature to a test signal sent by the switch, but non-compliant (legacy or proprietary) PDs may use a capacitive signature instead. By default, legacy PD detection is disabled, and legacy devices are not powered.

To configure an interface to use hardware detection for these non-compliant PoE devices and attempt to power them, use the [poe legacy detect](#) command.



Note: Non IEEE-compliant PDs are not officially supported. Arista cannot guarantee compatibility with such devices, and they may not be detected even when legacy detection is enabled on the port they are connected to.

Example

These commands configure *Ethernet interface 5* to attempt to detect and power non-compliant PDs.

```
switch(config)#interface ethernet 5
switch(config-if-Et5)#poe legacy detect
switch(config-if-Et5)#
```

Displaying PoE Information

To display PoE information for a specific interface range or for all Ethernet interfaces, use the [show poe](#) command.

Example

This command displays PoE information for *Ethernet interface 46*.

```
switch(config)#show poe interface ethernet 46
show poe interface ethernet 46
PSELLDPowerGrantedPort
Port Enabled EnabledLimitPowerStateClass Power Current Voltage Temperature
-----
46      True      True 15.40W 15.40W powered class0 1.40W 27.00mA 55.04V 41.25C
switch(config-if-Et7)#
```

10.1.5.21 Configuring Link Fault Signaling

As part of the Link Fault Signaling (LFS) configuration, a new configuration mode called the EOAM (Ethernet operations administration & management) mode is introduced. The EOAM profile has a link-error sub-mode wherein the threshold, action, and the period is configured for both FCS and Symbol errors. The period can be in seconds or in number of frames. The default values are threshold 0, action syslog, and period 0 seconds. If the errors exceed the threshold within the given period, the configured action is executed. The recovery time configures the recovery timeout value for link fault signaling. Only one EOAM profile is associated with a port.

The following steps enable configuring the LFS parameters:

1. Enable the EOAM mode.

```
switch(config)#monitor ethernet oam
```

2. Create an EOAM profile named as profile1.

```
switch(config-eoam) #profile profile1
```

3. Enter the EOAM link-error sub-mode.

```
switch(config-eoam-profile-profile1) #link-error
```

4. Enter the commands in the profile link-error submode to configure a specific LFS parameter.

```
switch(config-eoam-profile-profile1-link-error) #symbol action  
errdisable  
switch(config-eoam-profile-profile1-link-error) #symbol period 300  
frames  
switch(config-eoam-profile-profile1-link-error) #symbol threshold 20  
switch(config-eoam-profile-profile1-link-error) #recovery-time 40
```

5. Apply the EOAM profile profile1 to the Ethernet interface 1/1.

```
switch(config) #interface ethernet 1/1  
switch(config-if-Et1/1) #monitor ethernet oam profile profile1
```

Platform Compatibility

LFS parameter configuration is supported on the following platforms:

- DCS-7020
- DCS-7050X
- DCS-7060X
- DCS-7250X
- DCS-7260X
- DCS-7280R
- DCS-7300
- DCS-7320
- DCS-7500R



Note:

The link fault action is not supported on the DCS-7050X, DCS-7250X, DCS-7060X, DCS-7260X, DCS-7300, DCS-7320 platforms.

10.1.5.22 Configuring Hardware TCAM

TCAM (ternary content-addressable memory) is a specialized type of high-speed memory that increase the speed of route look-up, packet classification, packet forwarding and access control list-based commands. The hardware tcam command is used to configure and place the switch in the TCAM mode. In this mode the user can configure few TCAM related commands such as feature, profile and system.

In the TCAM mode the feature command is used to configure the reservation of TCAM banks for the features like ACL, IPsec, flow-spec, I2-protocol, PBR, QoS, TCP-MSS-ceiling, traffic-policy. The profile command configures a new TCAM profile, or just copy the TCAM profile which is already created using the hardware tcam profile command such as default, mirroring-acl, pbr-match-next-hop-group, qos, tap-aggregation-default, tap-aggregation-extended, tc-counters, test, vxlan-routing. Similarly, the system command configures the system-wide TCAM profiles.

Example

- This command places the switch in Hardware TCAM configuration mode.

```
switch(config) #hardware tcam
```

```
switch(config-hw-tcam) #
```

These are the commands allowed to configure in Hardware TCAM mode.

Examples

- This command allow the switch to configure the TCAM feature.

```
switch(config) #hardware tcam
switch(config-hw-tcam) #feature
```

- This command allow the switch to configure TCAM profile.

```
switch(config) #hardware tcam
switch(config-hw-tcam) #profile
```

- This command allow the switch to configure TCAM system profile.

```
switch(config) #hardware tcam
switch(config-hw-tcam) #system
```

10.1.5.23 CPU Traffic Policy

Create a TCAM profile to enable actions such as permit, deny, and police in hardware before the traffic gets to the kernel for processing. The action is taken based on IP packet header information such as DSCP, L4 port values, fragmentation bits, etc.

TCAM Profile Example

The following file extract displays an example of a TCAM profile, `cpu-traffic-policy`, with features configured to enable CPU traffic policy.

```
hardware tcam
  profile cpu-traffic-policy
    feature acl port ip
      sequence 45
      key size limit 160
      key field dscp dst-ip ip-frag ip-protocol l4-dst-port l4-ops l4-
src-port src-ip tcp-control ttl
      action count drop
      packet ipv4 forwarding bridged
      packet ipv4 forwarding routed
      packet ipv4 forwarding routed multicast
      packet ipv4 mpls ipv4 forwarding mpls decap
      packet ipv4 mpls ipv6 forwarding mpls decap
      packet ipv4 non-vxlan forwarding routed decap
      packet ipv4 vxlan eth ipv4 forwarding routed decap
      packet ipv4 vxlan forwarding bridged decap
    feature acl port ipv6
      sequence 25
      key field dst-ipv6 ipv6-next-header ipv6-traffic-class l4-dst-
port l4-ops-3b l4-src-port src-ipv6-high src-ipv6-low tcp-control
      action count drop mirror
      packet ipv6 forwarding bridged
      packet ipv6 forwarding routed
      packet ipv6 forwarding routed multicast
      packet ipv6 ipv6 forwarding routed decap
    feature acl subintf ip
      sequence 40
      key size limit 160
      key field dscp dst-ip ip-frag ip-protocol l4-dst-port l4-ops-18b
l4-src-port src-ip tcp-control ttl
```

```

        action count drop mirror
        packet ipv4 forwarding routed
feature acl subintf ipv6
    sequence 15
    key field dst-ipv6 ipv6-next-header l4-dst-port l4-src-port src-
ipv6-high src-ipv6-low tcp-control
    action count drop mirror redirect
    packet ipv6 forwarding routed
feature counter lfib
    sequence 85
feature mpls
    sequence 5
    key size limit 160
    action drop redirect set-ecn
    packet ipv4 mpls ipv4 forwarding mpls decap
    packet ipv4 mpls ipv6 forwarding mpls decap
    packet mpls ipv4 forwarding mpls
    packet mpls ipv6 forwarding mpls
    packet mpls non-ip forwarding mpls
feature mpls pop ingress
    sequence 90
feature pbr mpls
    sequence 65
    key size limit 160
    key field mpls-inner-ip-tos
    action count drop redirect
    packet mpls ipv4 forwarding mpls
    packet mpls ipv6 forwarding mpls
    packet mpls non-ip forwarding mpls
feature qos ip
    sequence 75
    key size limit 160
    key field dscp dst-ip ip-frag ip-protocol l4-dst-port l4-ops l4-
src-port src-ip
    action set-dscp set-policer set-tc
    packet ipv4 forwarding routed
    packet ipv4 forwarding routed multicast
    packet ipv4 mpls ipv4 forwarding mpls decap
    packet ipv4 mpls ipv6 forwarding mpls decap
    packet ipv4 non-vxlan forwarding routed decap
feature qos ipv6
    sequence 70
    key field dst-ipv6 ipv6-next-header ipv6-traffic-class l4-dst-
port l4-src-port src-ipv6-high src-ipv6-low
    action set-dscp set-policer set-tct
    packet ipv6 forwarding routed
feature traffic-policy cpu ipv4
    sequence 1
    key size limit 160
    key field dst-ip ip-frag ip-protocol l4-dst-port l4-src-port
src-ip
    action count set-drop-precedence set-policer
feature traffic-policy cpu ipv6
    sequence 2
    key field dst-ipv6 ipv6-next-header l4-dst-port l4-src-port src-
ipv6-high src-ipv6-low
    action count set-drop-precedence set-policer
system profile cpu-traffic-policy

```

Configuring the Policy

The following configures `cpu-traffic-policy` under the `traffic-policies` global configuration mode.

```
traffic-policies
  cpu traffic-policy <name> vrf <vrf-list>
  traffic-policy <name>
    match <rule-name> <ipv4 | ipv6> [ <after | before> <rule-name> ]

    source prefix      A.B.C.D/E [ A.B.C.D/E ]
    destination prefix A.B.C.D/E [ A.B.C.D/E ]
    protocol <protocol-list> | {tcp,udp}
      [ source port <port-list> |
        field-set <port-set-name> ] |
      [ destination port <port-list> |
        field-set <port-set-name> ]

    actions
      drop
      police rate <rate> <unit>
      count
```

The following applies the policies to the VRFs. The policy is applied to all interfaces belonging to the VRF.

```
traffic-policies
  cpu traffic-policy <name> vrf all
```

Default Rules

`ipv4-all-default` and `ipv6-all-default` are programmed by default and cannot be reordered, or removed. Only the associated action can be changed. The `permit` rule is never installed and is the default action for packet processing.

Examples

L3 Protocol Match Criteria (protocol neighbors bgp)

The following displays the configuration of a profile to match on a set of configured protocol peers which allows only TCP traffic from those BGP peers.

```
traffic-policies
  cpu traffic-policy <name> vrf <vrf-list>
  traffic-policy <name>
    match <rule-name> <ipv4 | ipv6> [ <after | before> <rule-name> ]

    source prefix      A.B.C.D/E [ A.B.C.D/E ]
    destination prefix A.B.C.D/E [ A.B.C.D/E ]
    protocol <protocol-list> | {tcp,udp}
      [ source port <port-list> |
        field-set <port-set-name> ] |
      [ destination port <port-list> |
        field-set <port-set-name> ]

    actions
      drop
      police rate <rate> <unit>
      count

traffic-policies
  cpu traffic-policy <traffic-policy-name> vrf all
  match <rule-name> <ipv4 | ipv6> [ <after | before> <rule-name> ]

  protocol neighbors bgp
  actions
```

```

        drop

traffic-policies
  cpu traffic-policy foo vrf all
    traffic-policy foo
      match BGP ipv4
        protocol neighbors bgp

```

The following policy permits dynamic peers from the listen-range 2.0.0.0/24 and all IPv6 BGP LL peers.

```

traffic-policies
  traffic-policy cpuPolicy
    match BGP ipv4
      protocol neighbors bgp
    match BGP-DYN ipv4
      source prefix 2.0.0.0/24
    match BGP-LL ipv6
      source prefix fe80::/64

```



Note: Configuring any match criteria will result in a CLI error when combined with the `protocol neighbor bgp match` criteria as these will conflict with the expanded BGP rules.

The following displays error messages with conflicting configurations.

```

traffic-policies
  traffic-policy cpuPolicy
    match BGP ipv4
      protocol neighbors bgp
      source prefix 1.0.0.1/32
! The 'source prefix' subcommand is not supported when the 'protocol
neighbors' subcommand is configured.

traffic-policies
  traffic-policy cpuPolicy
    match BGP ipv4
      source prefix 1.0.0.1/32
      protocol neighbors bgp
! The 'protocol neighbors' subcommand is not supported when any other
match subcommands are configured.

```

Deny other BGP Traffic

The following displays a policy to whitelist some BGP sessions and other management IPs or IP protocol. The policy is inadequate as attempts to create BGP sessions from 1.0.0.0/24 (for example) will pass through this policy unfiltered.

```

traffic-policies
  cpu traffic-policy CPU vrf all
  traffic-policy CPU
    match BGP ipv4
      protocol neighbors bgp
    match BFD ipv4
      source address 1.0.0.0/24 1.0.1.0/24 1.0.4.0/24
    match ipv4-all-default ipv4
      actions
        drop
    match ipv6-all-default ipv6
      actions
        drop

```

The following displays a policy to whitelist some BGP sessions and other management IPs or IP protocol. The policy is effective and easier to implement for administrators.

```
traffic-policies
cpu traffic-policy CPU
traffic-policy CPU
  match BGP ipv4
    protocol neighbors bgp
  match BGP-REST ipv4
    protocol tcp udp destination port 179
  actions
    drop
  match BFD ipv4
    source address 1.0.0.0/24 1.0.1.0/24 1.0.4.0/24
  match ipv4-all-default ipv4
  actions
    drop
  match ipv6-all-default ipv6
  actions
    drop
```

The following displays a policy to whitelist some BGP sessions and other management IPs or IP protocol. The policy is effective and easier to implement for administrators. The clause matches on any inbound traffic destined for the configured BGP port(s).

```
traffic-policies
cpu traffic-policy CPU
traffic-policy CPU
  match BGP ipv4
    protocol neighbors bgp
  match BGP-REST ipv4
    protocol bgp
  actions
    drop
  match BFD ipv4
    source address 1.0.0.0/24 1.0.1.0/24 1.0.4.0/24
  match ipv4-all-default ipv4
  actions
    drop
  match ipv6-all-default ipv6
  actions
    drop
```

Actions

Drop: packet is discarded on a match

Police: tracks the usage for each BGP neighbor, and holds it to a maximum rate.

The `police rate <rate-value> [rate-unit]` command sets the policing rate. The optional rate-unit are bps, kbps (default), mbps, and gbps. The following configures a policing rate of 15 kbps for each BGP neighbor.

```
traffic-policies
cpu traffic-policy CPU vrf all
traffic-policy CPU
  match BGP ipv4
    protocol neighbors bgp
  actions
    police rate 15 kbps
```

Count

The following enables counters for the CPU traffic policy to count all packets matching the rule in which the count action is configured.

```
no hardware counter feature acl out <address-family>

hardware counter feature traffic-policy cpu

traffic-policies
  cpu traffic-policy CPU vrf all
  traffic-policy CPU
    match BGP ipv4
      protocol neighbors bgp
      actions
        count
```

Use-case Scenarios

Securing BGP Neighbors

The following implements a policy to secure BGP neighbors.

```
traffic-policies
  cpu traffic-policy CPU-DEFAULT vrf all
  traffic-policy CPU-DEFAULT
    match ICMPV6 ipv6
      protocol icmpv6
    match BGP ipv4
      protocol neighbors bgp
    match BGP-OTHER ipv4
      protocol bgp
      actions
        drop
    match BGP6 ipv6
      protocol neighbors bgp
    match BGP-OTHER6 ipv6
      protocol bgp
      actions
        drop
    match OSPF ipv4
      protocol ospf
    match ipv4-all-default ipv4
      actions
        drop
    match ipv6-all-default ipv6
      actions
        drop
```

Whitelist BFD Neighbors (not neighbor-specific)

Add the following rule to Whitelist BFD Neighbors.

```
traffic-policies
  traffic-policy CPU-DEFAULT
    match BFD-DPORT ipv4
      protocol udp destination port 3784-3785
    match BFD-SPORT ipv4
      protocol udp source port 49152
    match BFD-DPORT6 ipv6
      protocol udp destination port 3784-3785
    match BFD-SPORT6 ipv6
      protocol udp source port 49152
    match ipv4-all-default ipv4
      actions
        drop
```

```

match ipv6-all-default ipv6
  actions
  drop

```

Whitelist a few Common Control-plane Protocols and Deny others

Add the following rule to Whitelist protocols such as ICMPv6 while denying others.

```

traffic-policies
cpu traffic-policy CPU-DEFAULT vrf all
traffic-policy CPU-DEFAULT
  match ICMPV6 ipv6
    protocol icmpv6
  match BGP ipv4
    protocol neighbors bgp
  match BGP-OTHER ipv4
    protocol bgp
  actions
  drop
  match BGP6 ipv6
    protocol neighbors bgp
  match BGP-OTHER6 ipv6
    protocol bgp
  actions
  drop
  match OSPF ipv4
    protocol ospf
  match PIM4 ipv4
    protocol pim
  match PIM6 ipv6
    protocol pim
  match ipv4-all-default ipv4
    actions
    drop
  match ipv6-all-default ipv6
    actions
    drop

```

Scale Numbers

The maximum number of match statements supported is platform-dependent. Other features that use TCAM also impact the number available on a switch.

The following displays the TCAM features consuming resources.

```

switch(config-traffic-policies)#show hardware capacity
Forwarding Resources Usage

```

Table	Feature	Chip	Used	Used
Free	Committed	Best Case	High	Used
Entries	Entries	Max	Watermark	Entries
Entries				

...				
TCAM	CpuPolicy	Jericho0		0
24576	0	24576	356	0%
TCAM	CpuPolicy	Jerichol		0
24576	0	24576	0	0%
...				

The following displays the TCAM with default deny rules.

```
switch(config-traffic-policies)#show hardware capacity | grep CpuPolicy |
grep Jericho0
TCAM                CpuPolicy                Jericho0                3                0%
24573                6144                24576                356
```

The following displays the number of TCAM entries with default deny rules.

```
switch(config-traffic-policies)#show plat jericho acl tcam hw bank 0
=====
Jericho0 Bank 0 Type: dbIpCpuTrafficPolicy
=====
-----
|Ofs|DPRT|SPRT|V4_DIP  |PR|PP|F|V4_SIP  |KCP  |V|ACT  |H|
-----
|0  |   |   |   |   |   |   |   |   |00001|3|000005|0|
|   |   |   |   |   |   |   |   |   |fffff|3|000000|0|
-----
```

The following displays the TCAM with a policy with 255 IPV4 and IPV6 BGP peers admitted via *protocol neighbors bgp* in each VRF.

```
switch(config-traffic-policies)#show hardware capacity | grep CpuPolicy |
grep Jericho0
TCAM                CpuPolicy                Jericho0                3551                14%
21025                6144                24576                3551
```

10.1.5.24 TCAM Profile for Configurable Port Qualifier Sizing

A TCAM profile can be created from scratch, or the feature can be added to a copy of the default TCAM profile. When creating a profile from scratch, care must be taken to ensure that all needed TCAM features are included in the profile.

Modifying a Default TCAM Profile to allow Dynamic Sizing for ACL Labels

The following commands create a copy of the default TCAM profile, name it **port-qualifier-size**, and configure it to support a 6-bit dynamic sizing for ACL labels for IPKGV. Once the profile has been created, it can be applied to the system.

```
switch(config)#hardware tcam
switch(config-hw-tcam)#profile port-qualifier-size copy default
switch(config-hw-tcam-profile-port-qualifier-size)#feature port-qualifie
r-size ip copy
system-feature-source-profile
switch(config-hw-tcam-profile-port-qualifier-size-feature-port-qualifier-
size)#port-qualifier-size 6
switch(config-hw-tcam-profile-port-qualifier-size-feature-port-qualifier-
size)#exit

switch(config-hw-tcam-profile-port-qualifier-size)#feature acl port ip

switch(config-hw-tcam-profile-port-qualifier-size)#exit

switch(config-hw-tcam)#exit

switch(config)#
```

Verifying the Configuration of Dynamic Qualifier Size

The following command verifies the configuration.

```
switch#show running-config
hardware tcam
  profile port-qualifier-size
    feature acl port ip
    port qualifier size 6 bits
```

Verifying the Configuration of System Profile

The following command verifies the system profile was configured and applied successfully. The profile name appears in both the Configuration and Status columns.

```
switch#show hardware tcam profile
Configuration      Status
Linecard1          port-qualifier-   port-qualifier-
size               size
Linecard2          port-qualifier-   port-qualifier-
size               size
Linecard3          port-qualifier-   port-qualifier-
size               size
```

When the profile does not get applied correctly, the Status column shows Error.

```
switch#show hardware tcam profile
Configuration      Status
Linecard1          port-qualifier-   ERROR
size               size
Linecard2          port-qualifier-   ERROR
size               size
Linecard3          port-qualifier-   ERROR
size               size
```



Note: The packet type, the key field must be set. The dynamic qualifier size can be set for ACL. Not all hardware platforms support this feature. Modular systems require all linecards to support this feature for the profile to be applicable.

10.1.6 Ethernet Configuration Commands

Global Configuration Commands

- [clear counters](#)
- [clear vxlan counters](#)
- [hardware port-group](#)
- [hardware counter feature](#)
- [hardware counter feature in \(DCS-7050x, 7350x, 7300x\)](#)
- [hardware tcam](#)
- [interface ethernet](#)
- [interface ethernet create](#)
- [interface management](#)
- [monitor ethernet oam](#)
- [transceiver qsfp default-mode](#)
- [transceiver channel](#)

Hardware TCAM Commands

- [feature](#)
- [profile](#)
- [system](#)

Interface Configuration Commands Ethernet and Management Interfaces

- [flowcontrol receive](#)
- [flowcontrol send](#)
- [link-debounce](#)
- [mac-address](#)
- [poe disabled](#)
- [poe legacy detect](#)
- [poe limit](#)
- [power budget](#)
- [power budget exceed action \(warning | hold-down\)](#)
- [speed](#)

EOAM Configuration Commands

- [link-error](#)
- [monitor ethernet oam profile](#)
- [profile](#)

Link-error Configuration Commands

- [action](#)
- [period](#)
- [phy link detection aggressive](#)
- [recovery-time](#)
- [threshold](#)

Interface Display Commands

- [show hardware counter](#)

- `show hardware port-group`
- `show interfaces counters`
- `show interfaces counters bins`
- `show interfaces counters errors`
- `show interfaces counters queue`
- `show interfaces counters rates`
- `show interfaces flow-control`
- `show interfaces hardware`
- `show interfaces hardware default`
- `show interfaces interactions`
- `show interfaces negotiation`
- `show interfaces phy`
- `show interfaces status`
- `show interfaces status errdisabled`
- `show interfaces transceiver`
- `show interfaces transceiver channels`
- `show interfaces transceiver hardware`
- `show interfaces transceiver properties`
- `show monitor ethernet oam profile`
- `show platform fm6000 agileport map`
- `show platform trident flexcounters`
- `show platform trident flexcounters l3intf`
- `show poe`
- `show route counters`
- `show vxlan counters vni`

400GBASE-ZR Transceivers Display Commands

- `show interface transceiver dom`
- `show interface transceiver eeprom`
- `show transceiver status interface`

10.1.6.1 action

The **action** command configures the link monitoring action that is specified for the link fault signaling event.

The **no action** command removes the action type specified for the chosen link fault signaling. The **default action** command configures the link monitoring action as system log type.

Command Mode

Link-error Configuration

Command Syntax

```
{fcs | symbol} action [linkfault | errdisable | log]
```

```
no {fcs | symbol} action [linkfault | errdisable | log]
```

```
default {fcs | symbol} action [linkfault | errdisable | log]
```

Parameters

- **fcs** Inbound packets with frame check sequence (FCS) error.
- **symbol** Inbound packets with symbol error.
- **linkfault** The link fault action type.
- **errdisable** The errdisable action type.
- **log** The system log action type.

Related Commands

- [period](#)
- [threshold](#)

Example

- These commands set the errdisable action type for the profile profile1 in the Link-error configuration mode for symbol error.

```
switch(config)#monitor ethernet oam
switch(config-eoam)#profile profile1
switch(config-eoam-profile-profile1)#link-error
switch(config-eoam-profile-profile1-link-error)#symbol action
errdisable
```

10.1.6.2 clear counters

The **clear counters** command in **privileged EXEC** mode resets the counters to zero for the specified interfaces including VLAN interfaces, Sub-Interfaces, and GRE Tunnel Interfaces.

Command Mode

Privileged EXEC

Command Syntax

```
clear counters [vlan vlanId | Tunnel tunnelID][[route][ipv4 | ipv6][vrf]]
```

Parameters

- **vlan *vlanId*** Clears the VLAN Interface and subinterface Ingress and Egress counters.
- **Tunnel *tunnelID*** Allows the command to be used for clearing counters only for the specified VLAN interface.
- **route** Clears the route counters.
 - **ipv4** Allows targeting the clearing of IPv4 route counters.
 - **ipv6** Allows targeting the clearing of IPv6 route counters.
- **vrf** Allows specifying the VRF to only clear the route counters for the VRF.

Examples

- Clears the VLAN Interface and subinterface ingress and egress counters.

```
switch#clear counters [vlan vlanId]
```

- Clears the GRE Tunnel Interface Ingress and Egress counters.

```
switch#clear counters [tunnel TunnelId]
```

10.1.6.3 clear vxlan counters

Use the `clear vxlan counters` command to clear the VXLAN encap and decap counters.

Command Mode

EXEC

Command Syntax

```
clear vxlan counters [[vni | [vtep [vtep-ip-address | unlearn]]]
```

Parameters

- **vni** Clears the VXLAN counters.
- **vtep** Clears the VTEP counters.
 - **vtep-ip-address** Clears the counters for the specified VTEP.
 - **unlearn** Clears the counters for unlearned VTEPs. Unlearned VTEPs track the counts of packets received by the switch before the VTEP is learned.

10.1.6.4 feature

The **feature** command allows the user to reserve the number of TCAM banks for the following features such as ACL, flow-spec, IPsec, I2-protocol, PBR, QoS, TCP-MSS-ceiling, traffic-policy.

The **exit** command returns the switch to global configuration mode.

Command Mode

Hardware TCAM

Command Syntax

feature

Example

- This commands allows the switch to configure the TCAM flow-spec feature for IPv4 ports.

```
switch(config-hw-tcam) #feature flow-spec port ipv4 bank maximum count  
12
```

10.1.6.5 flowcontrol receive

The **flowcontrol receive** command configures administrative settings for inbound flowcontrol packets. Ethernet ports use flow control to delay packet transmission when port buffers run out of space. Ports transmit a pause frame when their buffers are full, signaling their peer ports to delay sending packets for a specified period.

The flowcontrol receive command configures the configuration mode port's ability to receive flowcontrol pause frames.

- **off**: port does not process pause frames that it receives.
- **on**: port processes pause frames that it receives.
- **desired**: port autonegotiates flow control; processes pause frames if the peer is set to send **desired**.

Desired is not an available parameter option. Ethernet data ports cannot be set to desired. Management ports are set to desired by default and with the **no flowcontrol receive** command.

The port linking process includes flow control negotiation. Ports must have compatible flow control settings to create a link. The table below lists the compatible flow control settings.

Table 61: Compatible Settings for Flow Control Negotiation – Local Port Receiving

local port	peer port
receive on	send on or send desired
receive off	send off or send desired
receive desired	send on , send off, or send desired

The **no flowcontrol receive** and **default flowcontrol receive** commands restore the default flowcontrol setting for the configuration mode interface by removing the corresponding **flowcontrol receive** command from **running-config**. The default setting is **off** for Ethernet data ports and **desired** for Management ports.

Command Mode

Interface-Ethernet Configuration

Interface-Management Configuration

Command Syntax

```
flowcontrol receive STATE
```

```
no flowcontrol receive
```

```
default flowcontrol receive
```

Parameters

- STATE flow control pause frame processing setting. Options include:
 - On
 - Off

Example

These commands set the flow control received on Ethernet interface 5.

```
switch(config)#interface ethernet 5
switch(config-if-Et5)#flowcontrol receive on
switch(config-if-Et5)#
```

10.1.6.6 flowcontrol send

The **flowcontrol send** command configures administrative settings for outbound flow control packets. Ethernet ports use flow control to delay packet transmission when port buffers run out of space. Ports transmit a pause frame when their buffers are full, signaling their peer ports to delay sending packets for a specified period.

The **flowcontrol send** command configures the configuration mode port's ability to transmit flow control pause frames.

- **off**: port does not send pause frames.
- **on**: port sends pause frames.
- **desired**: port autonegotiates flow control; sends pause frames if the peer is set to **receive desired**.

Desired is not an available parameter option. Ethernet data ports cannot be set to **desired**. Management ports are set to **desired** by default and with the **no flowcontrol send** command.

The port linking process includes flow control negotiation. Ports must have compatible flow control settings to create a link. [Compatible Settings for Flow Control Negotiation Local Port Transmitting](#) lists the compatible flow control settings.

Table 62: Compatible Settings for Flow Control Negotiation Local Port Transmitting

local port	peer port
send on	receive on or receive desired
send off	receive off or receive desired
send desired	receive on , receive off, or receive desired

The **no flowcontrol send** and **default flowcontrol send** commands restore the default flow control setting for the configuration mode interface by removing the corresponding **flowcontrol send** command from **running-config**. The default setting is **off** for Ethernet data ports and **desired** for Management ports.

Command Mode

Interface-Ethernet Configuration

Interface-Management Configuration

Command Syntax

```
flowcontrol send STATE
```

```
no flowcontrol send
```

```
default flowcontrol send
```

Parameters

- **STATE** Flow control send setting. Options include:
 - **on**
 - **off**

Example

These commands set the flow control sent on *Ethernet interface 5*.

```
switch(config)#interface ethernet 5
switch(config-if-Et5)#flowcontrol send on
switch(config-if-Et5)#
```

10.1.6.7 hardware counter feature

You can enable on a per feature basis the **hardware counter feature** command from the global configuration mode. The **no hardware counter feature** disables the feature. Multiple ingress and egress hardware counter features can work concurrently.

Command Mode

Global configuration mode

Command Syntax

```
hardware counter feature [[vlan-interface | subinterface] [ in | out]][vni [encap | decap]][[route [ ipv4 | ipv6 ][ vrf name][ ip-address | ip-address-prefix]][[gre tunnel interface][ in | out]]
```

```
no hardware counter feature [[vlan-interface | subinterface] [ in | out]][vni [encap | decap]][[route [ ipv4 | ipv6 ][ vrf name][ ip-address | ip-address-prefix]][[gre tunnel interface][ in | out]]
```

Parameters

- **vlan-interface** Enables VLAN interface counters
 - **in** Enables the counting of ingress VLAN interface counters. When configured, the switch counts the number of unicast packets, multicast packets and total octets ingressing through the VLAN interface for every VLAN interface configured in the system.
 - **out** Enables the counting of egress VLAN interface counters. When configured, the switch counts the number of unicast packets, multicast packets and total octets egressing the vlan interface for every vlan interface configured in the system.
- **subinterface** Enables the counting subinterface counters.
 - **in** Enables the counting of ingress subinterface counters. When configured, the switch counts the number of unicast packets, multicast packets and total octets ingressing through the subinterface for every L3 subinterface configured in the system.
 - **out** Enables the counting of egress subinterface counters. When configured, the switch counts the number of unicast packets, multicast packets and total octets egressing the subinterface for every L3 subinterface configured in the system.
- **vni** Enables the counting of per VNI counters.
 - **encap** Enables the per encap counters. When enabled, the switch counts the number of packets/octets coming from the edge, encapsulated on the device and directed towards the core.
 - **decap** Enables the per VTEP decap counters. When enabled, the switch counts the number of packets/octets coming from the core, decapsulated on the device and heading towards the edge per each VTEP.
- **route** Configures the route counters for the specified ip version and ip-address/ip-prefix. When enabled, the switch counts the number of packets/bytes hitting a route.
 - **ipv4** Identifies the IPv4 route.
 - **ipv6** Identifies the IPv6 route.
- **vrf *name*** The VRF name is optional and default VRF is assumed if no VRF is specified.
- **ip-address** Specifies the target IP address.
- **ip-address-prefix** Specifies the target IP address prefix.
- **gre tunnel interface** Enables GRE tunnel interface counters.
 - **in** Enables GRE tunnel interface decap counters. When enabled, the switch counts the number of unicast GRE packets and total octets getting decapsulated on the tunnel interface.
 - **out** Enables GRE Tunnel Interface encap counters. When enabled, the switch counts the number of unicast GRE packets and total octets getting encapsulated on the Tunnel Interface.

Examples

```
switch#hardware counters feature vlan-interface in
```

```
switch#hardware counter feature vlan-interface out
```

```
switch#hardware counter feature subinterface in
```

```
switch#hardware counter feature subinterface out
```

```
switch(config)#hardware counter feature vni encap
```

```
switch(config)#hardware counter feature vni decap
```

```
switch(config)#hardware counter feature vtep encap
```

```
switch(config)#hardware counter feature vtep decap
```

```
switch(config)#hardware counter feature gre tunnel interface in
```

```
switch(config)#hardware counter feature gre tunnel interface out
```

10.1.6.8 hardware counter feature in (DCS-7050x, 7350x, 7300x)

The **hardware counter feature** command enables the switch to count the ingress traffic on the Layer 3 port of the switch. Any traffic on Layer 3 sub-interfaces and VLAN interface with IPv4 and IPv6 addresses are accounted irrespective of the routing decision.

The **no hardware counter feature in** command disable the counter configuration from the switch ports. By default the ingress counter is disabled on the switch.

Command Mode

Global Configuration

Command Syntax

```
hardware counter feature [INTERFACE] in
```

```
no hardware counter feature [INTERFACE] in
```

Parameters

- *INTERFACE* Layer 3 interface on the switch.
 - **subinterface** Displays the subinterface traffic count.
 - **vlan-interface** Displays the VLAN-interface traffic count.

Examples

- This command configures the ingress traffic count on the sub-interfaces.

```
switch#hardware counter feature subinterface in
```

- This command configures the ingress traffic count on the VLAN interface.

```
switch#hardware counter feature vlan-interface in
```

- These commands enable the QSFP+ interface in port group 1 and SFP+ interfaces in port group 2 on a DCS-7050Q-16 switch, display the port group status, and display interface status.

```
switch(config)#hardware port-group 1 select Et15/1-4
switch(config)#hardware port-group 2 select Et21-24
switch(config)#show hardware port-group

Portgroup: 1      Active Ports: Et17-20
Port             State
-----
Ethernet17      ErrDisabled
Ethernet18      ErrDisabled
Ethernet19      ErrDisabled
Ethernet20      ErrDisabled
Ethernet15/1    Active
Ethernet15/2    Active
Ethernet15/3    Active
Ethernet15/4    Active

Portgroup: 2      Active Ports: Et16/1-4
Port             State
-----
Ethernet16/1    Active
Ethernet16/2    Active
Ethernet16/3    Active
Ethernet16/4    Active
Ethernet21      ErrDisabled
Ethernet22      ErrDisabled
Ethernet23      ErrDisabled
Ethernet24      ErrDisabled
switch(config)#show interfaces status
Port      Name      Status      Vlan      Duplex  Speed  Type
Et1/1     connected in Po621   full     40G     40GBASE-CR4
Et1/2     errdisabled inactive    unconf  unconf  40GBASE-CR4
<-----OUTPUT OMITTED FROM EXAMPLE----->
Et15/1    connected in Po711   full     40G     40GBASE-CR4
```

```

Et15/2      errdisabled  inactive  unconf unconf Not Present
Et15/3      errdisabled  inactive  unconf unconf Not Present
Et15/4      errdisabled  inactive  unconf unconf Not Present
Et16/1      errdisabled  inactive  unconf unconf Not Present
Et16/2      errdisabled  inactive  unconf unconf Not Present
Et16/3      errdisabled  inactive  unconf unconf Not Present
Et16/4      errdisabled  inactive  unconf unconf Not Present
Et17        errdisabled  inactive  unconf unconf Not Present
Et18        errdisabled  inactive  unconf unconf Not Present
Et19        errdisabled  inactive  unconf unconf Not Present
Et20        errdisabled  inactive  unconf unconf Not Present
Et21        connected   425      full    10G 10GBASE-SRL
Et22        connected   611      full    10G 10GBASE-SRL
Et23        connected   in Po998 full    10G 10GBASE-SLR
Et24        connected   in Po998 full    10G 10GBASE-SLR
switch(config)#

```

- These commands enable the QSFP+ interface in port group 1 and SFP+ interfaces in port group 2 on a DCS-7050Q-16 switch, display the port group status, and display interface status.

```

switch(config)#hardware port-group 1 select Et15/1-4
switch(config)#hardware port-group 2 select Et21-24

switch(config)#show hardware port-group

Portgroup: 1      Active Ports: Et17-20
Port              State
-----
Ethernet17        ErrDisabled
Ethernet18        ErrDisabled
Ethernet19        ErrDisabled
Ethernet20        ErrDisabled
Ethernet15/1      Active
Ethernet15/2      Active
Ethernet15/3      Active
Ethernet15/4      Active

Portgroup: 2      Active Ports: Et16/1-4
Port              State
-----
Ethernet16/1      Active
Ethernet16/2      Active
Ethernet16/3      Active
Ethernet16/4      Active
Ethernet21        ErrDisabled
Ethernet22        ErrDisabled
Ethernet23        ErrDisabled
Ethernet24        ErrDisabled
switch(config)#show interfaces status
Port      Name      Status      Vlan      Duplex  Speed  Type
Et1/1     Et1/1     connected   in Po621  full    40G    40GBASE-CR4
Et1/2     Et1/2     errdisabled inactive   unconf unconf 40GBASE-CR4
<-----OUTPUT OMITTED FROM EXAMPLE----->
Et15/1    Et15/1    connected   in Po711  full    40G    40GBASE-CR4
Et15/2    Et15/2    errdisabled inactive   unconf unconf Not Present
Et15/3    Et15/3    errdisabled inactive   unconf unconf Not Present
Et15/4    Et15/4    errdisabled inactive   unconf unconf Not Present
Et16/1    Et16/1    errdisabled inactive   unconf unconf Not Present
Et16/2    Et16/2    errdisabled inactive   unconf unconf Not Present
Et16/3    Et16/3    errdisabled inactive   unconf unconf Not Present
Et16/4    Et16/4    errdisabled inactive   unconf unconf Not Present
Et17      Et17      errdisabled inactive   unconf unconf Not Present
Et18      Et18      errdisabled inactive   unconf unconf Not Present
Et19      Et19      errdisabled inactive   unconf unconf Not Present
Et20      Et20      errdisabled inactive   unconf unconf Not Present
Et21      Et21      connected   425      full    10G    10GBASE-SRL
Et22      Et22      connected   611      full    10G    10GBASE-SRL
Et23      Et23      connected   in Po998 full    10G    10GBASE-SLR
Et24      Et24      connected   in Po998 full    10G    10GBASE-SLR
switch(config)#

```

10.1.6.9 hardware port-group

The **hardware port-group** command configures a port group to activate a 40GBASE (QSFP+) interface or four 10GBASE (SFP+) interfaces, affecting QSFP+ and SFP+ availability.

The **no hardware port-group** and **default hardware port-group** commands restore a port groups default setting by removing the corresponding **hardware port-group** command from **running-config**. The QSFP+ interface is active by default in each port group.

The **hardware port-group** command is available on DCS-7050Q-16 and DCS-7050QX-32S switches, and has different parameters on each platform.

Command Mode

Global Configuration

Command Syntax

```
hardware port-group group_number select PORT_LIST
```

```
no hardware port-group group_number select PORT_LIST
```

```
default hardware port-group group_number select PORT_LIST
```

Parameters

- *group_number* Label of the port group. Valid options are **1** and **2** on the 7050Q-16; only **1** is available on the 7050QX-32S.
- **PORT_LIST** Ports activated by command. Options vary by platform and depend on *group_number* value.
 - DCS-7050Q-16
 - **Et15/1-4** activates QSFP+ port on port group 1. Available when *group_number* is 1.
 - **Et16/1-4** activates QSFP+ port on port group 2. Available when *group_number* is 2.
 - **Et17-20** activates SFP+ ports on port group 1. Available when *group_number* is 1.
 - **Et21-23** activates SFP+ ports on port group 2. Available when *group_number* is 2.
 - DCS-7050QX-32S
 - **Et1-4** activates SFP+ ports on port group 1. Available when *group_number* is 1.
 - **Et5/1-4** activates QSFP+ port on port group 1. Available when *group_number* is 1.

10.1.6.10 hardware tcam

The **hardware tcam** command places the switch in Hardware TCAM configuration mode.

The **exit** command returns the switch to global configuration mode.

Command Mode

Global Configuration

Command Syntax

```
hardware tcam
```

Example

- This command places the switch in Hardware TCAM configuration mode.

```
switch(config)#hardware tcam
switch(config-hw-tcam)#
```

Related commands

- [profile](#)
- [interface ethernet](#)

10.1.6.11 interface ethernet create

The **interface ethernet create** command is used to configure a range of Ethernet subinterfaces. The command places the switch in Ethernet-interface configuration mode for the specified range of subinterfaces.

Command Mode

Global Configuration

Command Syntax

```
interface ethernet create sub_range
```

Parameters

- **sub_range** Range of subinterfaces to be configured. Subinterfaces are named by adding a period followed by a unique subinterface number to the name of the parent interface.

Example

- This command enters interface configuration mode for Ethernet subinterfaces 1/1.1-100:

```
switch(config)#interface ethernet create 1/1.100  
switch(config-if-Et1/1.1-100)#
```

10.1.6.12 interface ethernet

The **interface ethernet** command places the switch in Ethernet-interface configuration mode for the specified interfaces. The command can specify a single interface or multiple interfaces.

Ethernet interfaces are physical interfaces and are not created or removed.

Interface management commands include:

- description
- exit
- load-interval
- mtu
- shutdown (Interfaces)

Ethernet management commands include:

- flowcontrol
- mac-address
- speed

Chapters describing supported protocols and other features list additional configuration commands available from Ethernet interface configuration mode.

Command Mode

Global Configuration

Command Syntax

```
interface ethernet e_range
```

Parameters

- ***e_range*** Ethernet interfaces (number, range, or comma-delimited list of numbers and ranges). Valid Ethernet numbers depend on the switches available Ethernet interfaces.

Examples

- This command enters interface configuration mode for Ethernet interfaces 1 and 2:

```
switch(config)#interface ethernet 1-2  
switch(config-if-Et1-2)#
```

- This command enters interface configuration mode for Ethernet interface 1:

```
switch(config)#interface ethernet 1  
switch(config-if-Et1)#
```

10.1.6.13 interface management

The **interface management** command places the switch in management-interface configuration mode for the specified interfaces. The list can specify a single interface or multiple interfaces if the switch contains more than one management interface.

Management interfaces are physical interfaces and are not created or removed.

Interface management commands include:

- description
- exit
- load-interval
- mtu
- shutdown (Interfaces)

Ethernet management commands include:

- flowcontrol
- mac-address
- speed

Chapters describing supported protocols and other features list additional configuration commands available from management-interface configuration mode.

Command Mode

Global Configuration

Command Syntax

```
interface management m_range
```

Parameter

- ***m_range*** Management interfaces (number, range, or comma-delimited list of numbers and ranges).
Valid management numbers depend on the switches available management interfaces. A value of 0, where available, configures the virtual management interface on a dual-supervisor modular switch. Management interface 0 accesses management port 1 on the active supervisor of a dual-supervisor modular switch.

Examples

- This command enters interface configuration mode for management interfaces 1 and 2.

```
switch(config)#interface management 1-2  
switch(config-if-Ma1-2)#
```

- This command enters interface configuration mode for management interface 1:

```
switch(config)#interface management 1  
switch(config-if-Ma1)#
```

10.1.6.14 link-debounce

The **link-debounce** command configures the link debounce time for the configuration mode interface. Link debounce time is the time that advertisements for new link states are delayed after the link state is established. By default, debounce time is set to zero, disabling link debounce.

Debounce times for link-up and link-down transitions can be independently configured.

- Link-up debounce time: the delay before an interface advertises link down to link up transitions.
- Link-down debounce time: the delay before an interface advertises link up to link down transitions.

The **no link-debounce** and **default link-debounce** commands restore the default debounce setting for the configuration mode interface by removing the corresponding **link-debounce** command from **running-config**.

Command Mode

Interface-Ethernet Configuration

Interface-Management Configuration

Command Syntax

```
link-debounce time WAIT_TIME
```

```
no link-debounce time WAIT_TIME
```

```
default link-debounce time WAIT_TIME
```

Parameters

- **WAIT_TIME** Link debounce period (milliseconds). All debounce values range from 0 (disabled) to 30000 (30 seconds). Options include
 - < 0 - 30000 > One debounce value assigned as both link up and link down.
 - < 0 - 30000 > < 0 - 30000 > Two debounce values: link up is first, link down is second.

Examples

- These commands set the link-up and link-down debounce period to 10 seconds on Ethernet interface 5.

```
switch(config)#interface ethernet 5
switch(config-if-Et5)#link-debounce time 10000
switch(config-if-Et5)#
```

- These commands set the link-up debounce to 10 seconds and the link-down debounce period to zero on Ethernet interface 5.

```
switch(config)#interface ethernet 5
switch(config-if-Et5)#link-debounce time 10000 0
switch(config-if-Et5)#
```

- These commands set the link-up debounce to zero and the link-down debounce period to 12.5 seconds on Ethernet interface 5.

```
switch(config)#interface ethernet 5
switch(config-if-Et5)#link-debounce time 0 12500
switch(config-if-Et5)#
```

10.1.6.15 link-error

The **link-error** command places the Ethernet operations, administration, and management (EOAM) profile in the EOAM link-error sub-mode.

The **no link-error** and **default link-error** commands exit from the EOAM link-error sub-mode.

Command Mode

EOAM Configuration

Command Syntax

link-error

no link-error

default link-error

Related Commands

- [monitor ethernet oam profile](#)
- [show monitor ethernet oam profile](#)

Example

- These commands place the EOAM profile profile1 in the link-error sub-mode.

```
switch(config)#monitor ethernet oam  
switch(config-eoam)#profile profile1  
switch(config-eoam-profile-profile1)#link-error  
switch(config-eoam-profile-profile1-link-error)#
```

10.1.6.16 mac-address

The **mac-address** command assigns a MAC address to the configuration mode interface. An interfaces default MAC address is its burn-in address.

The **no mac-address** and **default mac-address** commands revert the interface to its default MAC address by removing the corresponding **mac-address** command from **running-config**.

Command Mode

Interface-Ethernet Configuration

Interface-Management Configuration

Command Syntax

mac-address *address*

no mac-address

default mac-address

Parameter

- *address* MAC address assigned to the interface. Format is dotted hex notation (H.H.H). Disallowed addresses are 0.0.0 and FFFF.FFFF.FFFF.

Example

- This command assigns the MAC address of 001c.2804.17e1 to Ethernet interface 7, then displays interface parameters, including the assigned address.

```
switch(config)#interface ethernet 7
switch(config-if-Et7)#mac-address 001c.2804.17e1
switch(config-if-Et7)#show interface ethernet 7
Ethernet3 is up, line protocol is up (connected)
  Hardware is Ethernet, address is 001c.2804.17e1 (bia 001c.7312.02e2)
  Description: b.e45
  MTU 9212 bytes, BW 10000000 Kbit
  Full-duplex, 10Gb/s, auto negotiation: off
  Last clearing of "show interface" counters never
  5 seconds input rate 7.84 kbps (0.0% with framing), 10 packets/sec
  5 seconds output rate 270 kbps (0.0% with framing), 24 packets/sec
    1363799 packets input, 222736140 bytes
      Received 0 broadcasts, 290904 multicast
      0 runts, 0 giants
      0 input errors, 0 CRC, 0 alignment, 0 symbol
      0 PAUSE input
    2264927 packets output, 2348747214 bytes
      Sent 0 broadcasts, 28573 multicast
      0 output errors, 0 collisions
      0 late collision, 0 deferred
      0 PAUSE output
switch(config-if-Et7)#
```

10.1.6.17 monitor ethernet oam profile

The `monitor ethernet oam profile` command applies the EOAM profile to the specific interface in interface configuration mode.

The `no monitor ethernet oam profile` and `default monitor ethernet oam profile` commands remove the EOAM profile from the interface.

Command Mode

Interface Configuration

Command Syntax

```
monitor ethernet oam profile name
```

```
no monitor ethernet oam profile
```

```
default monitor ethernet oam profile
```

Parameters

- *name* The EOAM profile name. An EOAM profile cannot be named as summary.

Related Commands

- [link-error](#)
- [show monitor ethernet oam profile](#)

Example

- These commands apply the EOAM profile profile1 to the Ethernet interface 1/1.

```
switch(config)#interface ethernet 1/1  
switch(config-if-Et1/1)#monitor ethernet oam profile profile1
```

10.1.6.18 monitor ethernet oam

The `monitor ethernet oam` command places the switch in the Ethernet operations, administration, and management (EOAM) configuration mode.

The `no monitor ethernet oam` and `default monitor ethernet oam` commands exit from the EOAM configuration mode.

Command Mode

Global Configuration

Command Syntax

```
monitor ethernet oam
```

```
no monitor ethernet oam
```

```
default monitor ethernet oam
```

Example

- This command places the switch in the EOAM configuration mode.

```
switch(config)#monitor ethernet oam
switch(config-eoam)#
```

10.1.6.19 period

The **period** command configures the link monitoring period that is specified for a link error in terms of number of frames or seconds.

The **no period** command removes the period type specified on the chosen link error. The **default period** command configures the link monitoring period as zero seconds.

Command Mode

Link-error Configuration

Command Syntax

```
{fcs | symbol} period num {seconds | frames}
no {fcs | symbol} period num {seconds | frames}
default {fcs | symbol} period num {seconds | frames}
```

Parameters

- **fcs** Inbound packets with frame check sequence (FCS) error.
- **symbol** Inbound packets with symbol error.
- **num** The link monitoring period in frames or seconds. The frames value ranges from 1 to 4000000000. The seconds value ranges from 2 to 200 seconds. The default value is 2 seconds.
- **seconds** The monitor errors per num seconds.
- **frames** The monitor errors per num frames.

Related Commands

- [action](#)
- [threshold](#)

Example

These commands set the frames period type for the profile profile1 in the Link-error configuration mode for 300 frames.

```
switch(config)#monitor ethernet oam
switch(config-eoam)#profile profile1
switch(config-eoam-profile-profile1)#link-error
switch(config-eoam-profile-profile1-link-error)#symbol period 300 frames
```

10.1.6.20 phy link detection aggressive

The **phy link detection aggressive** command allows configuration of interfaces for aggressive link-up declaration (~50 ms) on those interfaces. **no/default phy link detection aggressive** configuration reverts to a more reliable link-up with at least a two-second delay. When the aggressive mode is not supported, the system generates an advisory message.

Command Mode

Global Configuration

Command Syntax

```
[no | default] phy link detection aggressive
```

Examples

- This command configures aggressive link detection.

```
switch(config-if-Et1)#phy link detection aggressive  
switch(config-if-Et1)#
```

- This command configures aggressive link detection but fails on a platform that does not support the feature.

```
switch(config-if-Et1)#phy link detection aggressive  
detection      detection not supported on this hardware platform  
switch(config-if-Et1)#
```

10.1.6.21 poe disabled

Power over Ethernet (PoE) is enabled on all Ethernet ports by default on switches that support PoE. The `poe disabled` command disables PoE on the configuration-mode interface.

The `no poe disabled` and `default poe disabled` commands restore PoE on the interface by removing the corresponding `poe disabled` command from **running-config**.

Command Mode

Interface-Ethernet Configuration

Command Syntax

`poe disabled`

`no poe disabled`

`default poe disabled`

Example

These commands disable PoE on ***Ethernet interface 7***.

```
switch(config)#interface ethernet 7
switch(config-if-Et7)#poe disabled
switch(config-if-Et7)#
```

10.1.6.22 poe legacy detect

IEEE-compliant powered devices (PDs) are recognized by a specific resistance signature to a test signal sent by the switch, but non-compliant (legacy or proprietary) PDs may use a capacitive signature instead. The `poe legacy detect` command causes the configuration-mode interface to attempt to use hardware detection for these non-compliant PoE devices and power them. By default, legacy PD detection is disabled, and legacy devices are not powered.



Note: Non IEEE-compliant PDs are not officially supported. Arista cannot guarantee compatibility with such devices, and they may not be detected even when legacy detection is enabled on the port they are connected to.

The `no poe legacy detect` and `default poe legacy detect` commands restore the default behavior by removing the corresponding `poe legacy detect` command from **running-config**.

Command Mode

Interface-Ethernet Configuration

Command Syntax

```
poe legacy detect
```

```
no poe legacy detect
```

```
default poe legacy detect
```

Example

These commands configure **Ethernet interface 7** to attempt to detect and power capacitive PDs.

```
switch(config)#interface ethernet 7
switch(config-if-Et7)#poe legacy detect
switch(config-if-Et7)#
```

10.1.6.23 poe limit

Power over Ethernet (PoE) power output is limited by the hardware-negotiated power level and by the total power capacity of the switch. The `poe limit` command sets an additional maximum power output for the configuration-mode interface. The power limit represents the power output at the Ethernet port; actual power delivered to the PD will be lower due to power loss along the Ethernet cable.



Note: If a power limit is set by this command, Power Via MDI TLVs will not be sent from the interface. See [Configuring LLDP for Power over Ethernet](#) for details.

The `no poe limit` and `default poe limit` commands restore the default power limitation by removing the corresponding `poe limit` command from **running-config**.

Command Mode

Interface-Ethernet Configuration

Command Syntax

```
poe limit {class class_num | watt_num watts}
```

```
no poe limit
```

```
default poe limit
```

Parameters

- **class_num** Specifies the power output limit by power class. Values range from 0-6 as follows:
 - Class 0 = 15.4 W
 - Class 1 = 4 W
 - Class 2 = 7 W
 - Class 3 = 15.4 W
 - Class 4 = 30 W
 - Class 5 = 45 W
 - Class 6 = 60 W
- **watt_num** Specifies the power output limit in watts. Values range from 0-60. A value of **0** watts prevents the port from providing PoE power.

Examples

- These commands limit nominal PoE power output on **Ethernet interface 7** to **10 W**.

```
switch(config)#interface ethernet 7
switch(config-if-Et7)#poe limit 10 watts
switch(config-if-Et7)#
```

- These commands limit nominal PoE power output on **Ethernet interface 7** to **4 W**.

```
switch(config)#interface ethernet 7
switch(config-if-Et7)#poe limit class 1
switch(config-if-Et7)#
```

10.1.6.24 power budget

Power over Ethernet (PoE) budget is not set on all Ethernet ports by default on switches that support PoE. The `power budget [n] watts` command sets a limit of 'n' watts available for use by the ports on the switch. Otherwise, available power for PoE is limited to the sum of all power provided by the PSUs minus the power reserved for the chassis.

The `no power budget` restores the default state.

Command Mode

Interface-Ethernet Configuration

Command Syntax

```
power budget [n] watts
```

```
no power budget
```

Example

The following command sets the PoE power budget to 600W.

```
switch(config)#power budget 600 watts
```

10.1.6.25 power budget exceed action (warning | hold-down)

When the power over Ethernet (PoE) ports exceeds the budgeted amount, the switch issues a warning and continues to provide additional power above the budgeted limit. The `power budget exceed action hold-down` command causes the switch to issue a warning and limit the power to the configured limit.

The `no power budget` restores the default state.

Command Mode

Interface-Ethernet Configuration

Command Syntax

`power budget exceed action hold-down`

`no power budget`

Example

The following commands set the PoE power budget to 600W and configure the switch to not exceed the limit.

```
switch(config)#power budget 600 watts
switch(config)#power budget exceed action hold-down
```

10.1.6.26 profile

The **profile** command creates an Ethernet operations, administration, and management (EOAM) profile in the EOAM configuration mode.

The **no profile** and **default profile** commands exit from the EOAM configuration mode.

Command Mode

EOAM Configuration

Command Syntax

profile *profile_name*

no profile *profile_name*

default profile *profile_name*

Parameter

- **profile_name** The profile name that is specified.

Related Commands

- [monitor ethernet oam profile](#)
- [show monitor ethernet oam profile](#)

Guidelines

Run the **shutdown** or **no shutdown** command to bring the port back to the normal state.

Example

These commands create an EOAM profile profile1 in the EOAM configuration mode.

```
switch(config)#monitor ethernet oam
switch(config-eoam)#profile profile1
switch(config-eoam-profile-profile1)#
```

10.1.6.27 recovery-time

The **recovery-time** command configures the recovery timeout value for link fault signaling.

The **no recovery-time** command and the **default recovery-time** command removes the recovery timeout value specified for the chosen link error.

Command Mode

Link-error Configuration

Command Syntax

recovery-time *value*

no recovery-time *value*

default recovery-time *value*

Parameters

value Specifies the recovery timeout value for LFS. The value ranges from **20** to **200**.

Related Commands

- [action](#)
- [period](#)
- [threshold](#)

Example

These commands set the recovery time value of **40** for the *profile profile1* in the Link-error configuration mode.

```
switch(config)#monitor ethernet oam
switch(config-eoam)#profile profile1
switch(config-eoam-profile-profile1)#link-error
switch(config-eoam-profile-profile1-link-error)#recovery-time 40
```

10.1.6.28 show hardware counter

The **show hardware counter** command displays counter events across time intervals.

Command Mode

EXEC

Command Syntax

show hardware counter

Example

This command displays counter events across all time intervals, which are currently more than one standard deviation apart from a given time interval.

```
switch(config-handler-eventHandler1-counters)#show hardware counter events
-----
Interval | Event Name | Chip | First | Last | Count | Z-Score
| | Name | Occurrence | Occurrence | |
-----
5 Min | MacCounters | All | 2017-01-31 09:31:35 | 2017-01-31 09:44:32 | 5 | -6.9430
10 Min | MacCounters | All | 2017-01-31 09:39:43 | 2017-01-31 09:44:32 | 3 | -4.8123
-----
switch(config-handler-eventHandler1-counters)#
```

10.1.6.29 show hardware port-group

The **show hardware port-group** command displays the status of DCS-7050Q-16 port-groups. Port groups contain one QSFP+ interface and a set of four SFP+ interfaces. In each port group, either the QSFP+ interface or the SFP+ interface set is enabled. The port groups are configured independent of each other.

- **Port group 1** contains **interface 15** (QSFP+) and **interfaces 17-20** (SFP+).
- **Port group 2** contains **interface 16** (QSFP+) and **interfaces 21-24** (SFP+).

Command Mode

EXEC

Command Syntax

```
show hardware port-group
```

Guidelines

The **hardware port-group** command is available on on DCS-7050Q-16 switches.

Example

This command displays the status of ports in the two port groups on a DCS-7050Q-16 switch.

```
switch#show hardware port-group

Portgroup: 1      Active Ports: Et15/1-4
Port              State
-----
Ethernet17        ErrDisabled
Ethernet18        ErrDisabled
Ethernet19        ErrDisabled
Ethernet20        ErrDisabled
Ethernet15/1      Active
Ethernet15/2      Active
Ethernet15/3      Active
Ethernet15/4      Active

Portgroup: 2      Active Ports: Et16/1-4
Port              State
-----
Ethernet16/1      Active
Ethernet16/2      Active
Ethernet16/3      Active
Ethernet16/4      Active
Ethernet21        ErrDisabled
Ethernet22        ErrDisabled
Ethernet23        ErrDisabled
Ethernet24        ErrDisabled
switch>
```

10.1.6.30 show interfaces counters bins

The **show interfaces counters bins** command displays packet counters, categorized by packet length, for the specified interfaces. Packet length counters that the command displays include:

- 64 bytes
- 65-127 bytes
- 128-255 bytes
- 256-511 bytes
- 512-1023 bytes
- 1024-1522 bytes
- larger than 1522 bytes

Command Mode

EXEC

Command Syntax

```
show interfaces [INTERFACE] counters bins
```

Parameters

- **INTERFACE** Interface type and numbers. Options include:
 - **no parameter** All interfaces.
 - **ethernet e_range** Ethernet interface range specified by **e_range**.
 - **management m_range** Management interface range specified by **m_range**.
 - **port-channel p_range** Port-Channel Interface range specified by **p_range**.

Related Commands

- [show interfaces counters](#)
- [show interfaces counters errors](#)
- [show interfaces counters queue](#)
- [show interfaces counters rates](#)

Example

This command displays packet counter results for **Ethernet interfaces 1** and **Ethernet interfaces 2**.

```
switch#show interfaces ethernet 1-2 counters bins
Input
Port          64 Byte          65-127 Byte      128-255 Byte      256-511 Byte
-----
Et1             2503             56681135         1045154           1029152
Et2              8             50216275         1518179           1086297

Port          512-1023 Byte    1024-1522 Byte    1523-MAX Byte
-----
Et1             625825           17157823         8246822
Et2             631173           27059077         5755101
switch>
```

10.1.6.31 show interfaces counters errors

The `show interfaces counters errors` command displays the error counters for the specified interfaces.

Command Mode

EXEC

Command Syntax

```
show interfaces [INTERFACE] counters errors
```

Parameters

- INTERFACE Interface type and numbers. Options include:
 - **no parameter** All interfaces.
 - **ethernet e_range** Ethernet interface range specified by **e_range**.
 - **management m_range** Management interface range specified by **m_range**.
 - **port-channel p_range** Port-Channel Interface range specified by **p_range**.

Display Values

- The table displays the following counters for each listed interface:
 - **FCS**: Inbound packets with CRC error and proper size.
 - **Align**: Inbound packets with improper size (undersized or oversized).
 - **Symbol**: Inbound packets with symbol error and proper size.
 - **Rx**: Total inbound error packets.
 - **Runts**: Outbound packets that terminated early or dropped because of underflow.
 - **Giants**: Outbound packets that overflowed the receiver and were dropped.
 - **Tx**: Total outbound error packets.

Related Commands

- [show interfaces counters](#)
- [show interfaces counters bins](#)
- [show interfaces counters queue](#)
- [show interfaces counters rates](#)

Examples

This command displays the error packet counters on **Ethernet interface 1** and **Ethernet interface 2**.

```
switch#show interfaces ethernet 1-2 counters errors
Port          FCS    Align  Symbol    Rx    Runts  Giants
Tx
Et1           0      0      0         0     0      0
0
Et2           0      0      0         0     0      0
0
switch>
```

10.1.6.32 show interfaces counters queue

The `show interfaces counters queue` command displays the queue drop counters for the specified interfaces.

Command Mode

EXEC

Command Syntax

```
show interfaces [INTERFACE] counters queue
```

Parameters

- INTERFACE Interface type and numbers. Options include:
 - **no parameter** All interfaces.
 - **ethernet e_range** Ethernet interface range specified by **e_range**.
 - **management m_range** Management interface range specified by **m_range**.
 - **port-channel p_range** Port-Channel Interface range specified by **p_range**.

Related Commands

- [show interfaces counters](#)
- [show interfaces counters bins](#)
- [show interfaces counters errors](#)
- [show interfaces counters rates](#)

Example

This command displays the queue drop counters for **Ethernet interfaces 1** and **Ethernet interfaces 2**.

```
switch#show interfaces ethernet 1-2 counters queue
Port                InDrops
Et1                  180
Et2                  169
switch>
```

10.1.6.33 show interfaces counters rates

The **show interfaces counters rates** command displays the received and transmitted packet rate counters for the specified interfaces. Counter rates provided include megabits per second (Mbps), kilopackets per second (Kpps) and utilization percentage.

All port rates are approximately calculated. Note that, when displaying the rate information of a port channel, the rate value of the port channel differs from the sum of the rates for the member ports. The discrepancy is likely to be larger for port channels with fewer ports except for port channels with single ports. The rate values of individual member ports are less inaccurate than the rate values of the port channel as a whole.

Command Mode

EXEC

Command Syntax

```
show interfaces [INTERFACE] counters rates
```

Parameters

- INTERFACE Interface type and numbers. Options include:
 - **no parameter** All interfaces.
 - **ethernet e_range** Ethernet interface range specified by **e_range**.
 - **management m_range** Management interface range specified by **m_range**.
 - **port-channel p_range** Port-Channel Interface range specified by **p_range**.

Related Commands

- [show interfaces counters](#)
- [show interfaces counters bins](#)
- [show interfaces counters errors](#)
- [show interfaces counters queue](#)

Example

This command displays rate counters for **Ethernet interfaces 1** and **Ethernet interfaces 2**.

```
switch#show interfaces ethernet 1-2 counters rates
Port      Intvl   In Mbps   %      In Kpps  Out Mbps   %      Out Kpps
Et1       0:05   53.3     0.5%   5        31.2     0.3%   2
Et2       0:05   43.3     0.4%   4         0.1     0.0%   0
switch#
```

10.1.6.34 show interfaces counters

The **show interface counters** command displays the Layer 3 ingress traffic count information. Run this command to view the traffic counts on a sub-interface or VLAN interface. The clear counters command resets the counters to zero. Counters displayed by the command include:

- inbound bytes
- inbound unicast packets
- inbound multicast packets
- inbound broadcast packets
- outbound bytes
- outbound unicast packets
- outbound multicast packets
- outbound broadcast packets

Command Mode

EXEC

Command Syntax

```
show interfaces [INTERFACE] counters [ incoming]
```

Parameters

- **INTERFACE** Interface type and numbers. Options include:
 - **no parameter** All interfaces.
 - **ethernet *e_range*** Ethernet interface range specified by ***e_range***.
 - **management *m_range*** Management interface range specified by ***m_range***.
 - **port-channel *p_range*** Port-Channel Interface range specified by ***p_range***.
 - **subinterface** Displays the subinterface traffic counts.
 - **vlan-interface** Displays the VLAN-interface traffic counts.
- ***incoming*** Displays the traffic count for the ingress port.



Note: When no interface is specified, the output starts with ingress and egress counters section for regular interfaces, followed by section for the ingress L3 Interface counters.

Related Commands

- [show interfaces counters bins](#)
- [show interfaces counters errors](#)
- [show interfaces counters queue](#)
- [show interfaces counters rates](#)

Examples

- This command displays byte and packet counters for **Ethernet interfaces 1** and **Ethernet interfaces 2**.

```
switch#show interfaces ethernet 1-2 counters
Port          InOctets      InUcastPkts    InMcastPkts    InBcastPkts
Et1           99002845169   79116358       75557           2275
Et2           81289180585   76278345       86422           11

Port          OutOctets      OutUcastPkts    OutMcastPkts    OutBcastPkts
Et1           4347928323    6085482         356173          2276
Et2           4512762190    5791718         110498          15
switch>
```

- This command displays the ingress traffic count on a **VLAN interface vl12**.

```
switch#show interface vl12 counters incoming
L3 Interface InOctets InUcastPkts InMcastPkts
```

V112

3136

47

2

10.1.6.35 show interfaces flow-control

The **show interfaces flow-control** command displays administrative and operational flow control data for the specified interfaces. Administrative data is the parameter settings stored in **running-config** for the specified interface; the switch uses these settings to negotiate flow control with the peer switch. Operational data is the resolved flow control setting that controls the ports behavior.

Command Mode

EXEC

Command Syntax

```
show [INTERFACE] flow-control
```

Parameters

- **INTERFACE** Interface type and number for which flow control data is displayed.
 - **no parameter** All interfaces.
 - **ethernet e_range** Ethernet interfaces in the specified range.
 - **management m_range** Management interfaces in the specified range.

Valid **e_range** and **m_range** formats include number, number range, or comma-delimited list of numbers and ranges.

Example This command shows the settings for Ethernet interfaces 1-10.

```
switch#show flow-control interface ethernet 1-10
Port          Send FlowControl  Receive FlowControl  RxPause  TxPause
             admin    oper    admin    oper
-----
Et1           off     off     off     off     0       0
Et2           off     off     off     off     0       0
Et3           off     off     off     off     0       0
Et4           off     off     off     off     0       0
Et5           off     off     off     off     0       0
Et6           off     off     off     off     0       0
Et7           off     off     off     off     0       0
Et8           off     off     off     off     0       0
Et9           off     off     off     off     0       0
Et10          off     off     off     off     0       0
switch#
```

10.1.6.36 show interfaces hardware default

The **show interfaces hardware default** command displays the static interface capability information of the specified interfaces. This command displays information related to the speed, auto-negotiation, error correction, and modulation capabilities (when applicable) of a system's ports. The command also provides information displayed by the show interfaces hardware command, such as model number, interface type, duplex mode, and flow control settings of the specific interface. Compared to the show interfaces hardware command, this command accounts for the capabilities of the system architecture only, and does not consider the capabilities of a transceiver.

Command Mode

EXEC

Command Syntax

```
show interfaces [INTERFACE] hardware default
```

Parameters

- INTERFACE Interface type and numbers. Options include:
 - **no parameter** all interfaces.
 - **ethernet e_range** Ethernet interface range specified by **e_range**.
 - **management m_range** Management interface range specified by **m_range**.

Valid **e_range** and **m_range** formats include number, number range, or comma-delimited list of numbers and ranges.

Examples

- This command displays the static interface capability information at the default level.

```
switch>show interfaces hardware default
Ethernet1
  Model:      DCS-7020TR-48
  Type:       1000BASE-T
  Speed/Duplex: 100M/full,1G/full
  Flowcontrol: rx-(off,on,desired),tx-(off)
  Autoneg CL28: 100M/full,1G/full
  Autoneg CL37: 1G/full
switch>
```

- This command displays the static interface capability information for **Ethernet interface 4/1/1**.

```
switch>show interfaces ethernet 4/1/1 hardware default
Ethernet4/1/1
  Model:      7500R2AK-36CQ-LC
  Type:       40GBASE-CR4
  Speed/Duplex: 1G/full,10G/full,25G/full,40G/full,50G/full,100G/full
  Flowcontrol: rx-(off,on,desired),tx-(off)
  Autoneg CL28: 1G/full,10G/full
  Autoneg CL73:
  IEEE:      25G/full,40G/full,100G/full
  Consortium: 25G/full,50G/full
  Error Correction:
  Reed-Solomon: 25G,50G,100G
  Fire-code: 25G,50G
```

10.1.6.37 show interfaces hardware

The **show interfaces hardware** command displays the model number, interface type, duplex mode, and flow control settings of the specified interfaces. The capabilities command is available on Ethernet and management interfaces.

Command Mode

EXEC

Command Syntax

```
show interfaces [INTERFACE] hardware
```

Parameters

- INTERFACE Interface type and numbers. Options include:
 - **no parameter** All interfaces.
 - **ethernet e_range** Ethernet interface range specified by **e_range**.
 - **management m_range** Management interface range specified by **m_range**.

Valid **e_range** and **m_range** formats include number, number range, or comma-delimited list of numbers and ranges.

Example

This command displays the model number, interface type, duplex mode and flow control settings for **Ethernet interface 2** and **Ethernet interface 18**.

```
switch#show interfaces ethernet 2,18 hardware
Ethernet2
  Model:          DCS-7150S-64-CL
  Type:           10GBASE-CR
  Speed/Duplex:  10G/full,40G/full,auto
  Flowcontrol:    rx-(off,on,desired),tx-(off,on,desired)
Ethernet18
  Model:          DCS-7150S-64-CL
  Type:           10GBASE-SR
  Speed/Duplex:  10G/full
  Flowcontrol:    rx-(off,on),tx-(off,on)
switch#
```

10.1.6.38 show interfaces interactions

The **show interfaces interactions** command aims to provide users a resource that explains various relationships between ethernet interfaces. It describes interactions in which a configuration on an interface causes another set of interfaces to become inactive or have reduced capabilities. Examples include a primary interface consuming subordinate interfaces to service a four-lane speed or platform restrictions that require four interfaces of a port to operate at the same speed.

Command Mode

EXEC

Command Syntax

```
show interfaces [intf] interactions
```

Parameters

intf Hardware Ethernet interface. You can restrict the output by interface name.

Examples

The information is displayed as a text dump. Each section of information appears on a separate indentation level. The first indent level is the interface, the second is the desired configuration, and the third is the list of interactions. For example, the output below describes the following:

1. If the user wants to configure **Ethernet2/1** for 40G, **Ethernet2/2-4** becomes inactive.
2. If the user wants to configure **Ethernet2/1** for 10G, it does not affect other interfaces.

```
switch#show interface et2/1 interactions
* = includes less than 10G speeds that the interface is capable of

Ethernet2/1:
  For speed 40G
    Ethernet2/2-4 become inactive
  For speed 10G*
    No interactions with other interfaces
```

The asterisk next to the 10G entry indicates that these same interactions apply for speeds lower than 10G that the interface supports. In other words, if this interface also supported 1G or 100M, the configuration does not affect other interfaces.

Types of Interactions

No Interactions

If there are no interactions for the given interfaces, the display shows **No interfaces interactions**. Depending on what configurations actually have interactions, the line could appear at a number of different indentation levels. The rules are:

1. If all specified interfaces have no interactions, print at the first indentation level.
2. If only some specified interfaces have no interactions and those interfaces have no interactions at any speeds, print at the second indentation level for those interfaces.
3. If only some specified interfaces have no interactions and those interfaces only have interactions at some speeds, print at the third indentation level for those speeds.

```
switch#show int et1,2 interactions
No interfaces interactions
switch#show int et1,2,5/1 interactions
* = includes less than 10G speeds that the interface is capable of

Ethernet1
  No interactions with other interfaces
```

```

Ethernet2
  No interactions with other interfaces
Ethernet5/1
  For speed 40G
    Ethernet5/2-4 become inactive
  For speed 10G*
    No interactions with other interfaces

```

Inactive Interfaces

If a configuration on an interface causes other interfaces to become inactive, a message similar to the ones bolded below appear. A common example of this is configuring a QSFP28 port for 100G, which results in the /2,3, and /4 interfaces becoming inactive. Note that display information for inactive interfaces are included in the specified range, ignoring whether or not inactive interfaces are exposed.

```

switch#show interfaces et11/1,11/3 interactions
* = includes less than 10G speeds that the interface is capable of

Ethernet11/1:
  For speed 100G-4
    Ethernet11/2-4 become inactive
  For speed 50G-2
    Ethernet11/2,11/4 become inactive
    Ethernet11/3 is limited to 50G-2
  For speed 40G
    Ethernet11/2-4 become inactive
  For speed 25G
    Ethernet11/2-4 are limited to 25G
  For speed 10G*
    Ethernet11/2-4 are limited to 10G*
Ethernet11/3:
  For speed 50G-2
    Ethernet11/4 becomes inactive
    Primary interface Ethernet11/1 must be operating at 50G-2
  For speed 25G
    Primary interface Ethernet11/1 must be operating at 25G
  For speed 10G*
    Primary interface Ethernet11/1 must be operating at 10G*

```

Required Primary Interface Configuration

Some interface configurations require a particular primary interface configuration to function. These interactions are captured with messages similar to the ones bolded below.

```

switch#show interfaces et11/1,11/3 interactions
* = includes less than 10G speeds that the interface is capable of

Ethernet11/1:
  For speed 100G-4
    Ethernet11/2-4 become inactive
  For speed 50G-2
    Ethernet11/2,11/4 become inactive
    Ethernet11/3 is limited to 50G-2
  For speed 40G
    Ethernet11/2-4 become inactive
  For speed 25G
    Ethernet11/2-4 are limited to 25G
  For speed 10G*
    Ethernet11/2-4 are limited to 10G*
Ethernet11/3:
  For speed 50G-2

```

```

Ethernet11/4 becomes inactive
Primary interface Ethernet11/1 must be operating at 50G-2
For speed 25G
Primary interface Ethernet11/1 must be operating at 25G
For speed 10G*
Primary interface Ethernet11/1 must be operating at 10G*

```

Hardware Speed-Group Requirements

Some interface configurations require an additional speed-group configuration in order to operate correctly. If speed-group configurations are required, there will be a message displayed similar to the ones bolded below.

 **Note:** A single speed-group may include more than one compatibility setting. Using the example below as reference, **Ethernet1/1** at 100G-4 and **Ethernet2/1** at 40G are compatible configurations as long as hardware speed-group 1 can include 50g and 10g rates simultaneously.

```

switch#show interfaces et1/1,2/1 interactions
* = includes less than 10G speeds that the interface is capable of

Ethernet1/1:
  For speed 100G-4
    Ethernet1/2-4 become inactive
    Hardware speed-group 1 must include 50g
  For speed 40G
    Ethernet1/2-4 become inactive
    Hardware speed-group 1 must include 10g
  For speed 25G
    Ethernet2/1,2/3 become inactive
    Ethernet1/3 is limited to 25G/10G
    Hardware speed-group 1 must include 25g
  For speed 10G
    Ethernet2/1,2/3 become inactive
    Ethernet1/3 is limited to 25G/10G
    Hardware speed-group 1 must include 10g
Ethernet2/1:
  For speed 100G-4
    Ethernet2/3 becomes inactive
    Ethernet1/1 must be operating at 100G-4/50G-2/40G
    Hardware speed-group 1 must include 50g
  For speed 40G
    Ethernet2/3 becomes inactive
    Ethernet1/1 must be operating at 100G-4/50G-2/40G
    Hardware speed-group 1 must include 10g

```

Compatible Parent Interface Configuration

The parent interface may be configured for any one of the list of compatible rates. Additionally, more than one interface may be required to be configured at a compatible rate. These interactions are captured with messages similar to the ones bolded below

 **Note:** Using the example below as a reference, suppose that **Ethernet1/1** is configured for 100G-4 and that the goal is to configure **Ethernet1/8** to 50G-1. According to the display, **Ethernet1/1** is configured for a compatible rate. That said, in order for **Ethernet1/1** to operate at 100G-4, **hardware speed-group 1** must be configured to include the 25g compatibility setting. Additionally, hardware speed-group 1 must also include the 50g compatibility setting to

enable **Ethernet1/8** to operate at 50G-1. Interactions on **Ethernet1/5** and **Ethernet1/7** must be considered as well (omitted from the example for brevity).

```
switch#show interfaces et1/1,1/8 interactions
* = includes less than 10G speeds that the interface is capable of

Ethernet1/1:
Ethernet1/1-4/8 share 18 interface hardware resources
For speed 400G-8
  Ethernet1/2-8 become inactive
  Hardware speed-group 1 must include 50g
For speed 200G-4
  Ethernet1/2-4 become inactive
  Hardware speed-group 1 must include 50g
For speed 100G-2
  Ethernet1/2 becomes inactive
  Hardware speed-group 1 must include 50g
For speed 100G-4
  Ethernet1/2-4 become inactive
  Hardware speed-group 1 must include 25g
For speed 50G-1
  Hardware speed-group 1 must include 50g
For speed 50G-2
  Ethernet1/2 becomes inactive
  Hardware speed-group 1 must include 25g
For speed 40G
  Ethernet1/2-4 become inactive
  Hardware speed-group 1 must include 10g
For speed 25G
  Hardware speed-group 1 must include 25g
For speed 10G
  Hardware speed-group 1 must include 10g
Ethernet1/8:
For speed 50G-1
  Ethernet1/1 must be operating at 200G-4/100G-2/100G-4/50G-1
/50G-2/40G/25G/10G
  Ethernet1/5 must be operating at 100G-2/50G-1/50G-2/25G/10G
  Ethernet1/7 must be operating at 50G-1/25G/10G
  Hardware speed-group 1 must include 50g
```

Speed-limited Interfaces

Some interface configurations limit at what other interfaces can operate. If such limitations occur, a message displays similar to the ones bolded below.

```
switch#show interfaces et11/1,11/3 interactions
* = includes less than 10G speeds that the interface is capable of

Ethernet11/1:
For speed 100G-4
  Ethernet11/2-4 become inactive
For speed 50G-2
  Ethernet11/2,11/4 become inactive
  Ethernet11/3 is limited to 50G-2
For speed 40G
  Ethernet11/2-4 become inactive
For speed 25G
  Ethernet11/2-4 are limited to 25G
For speed 10G*
  Ethernet11/2-4 are limited to 10G*
Ethernet11/3:
For speed 50G-2
```

```
Ethernet11/4 becomes inactive
Primary interface Ethernet11/1 must be operating at 50G-2
For speed 25G
Primary interface Ethernet11/1 must be operating at 25G
For speed 10G*
Primary interface Ethernet11/1 must be operating at 10G*
```

Interfaces Sharing Logical Ports

Some interface ranges share logical port resources. If an interface shares logical ports with other interfaces, a message displays similar to the ones bolded below.

 **Note:** There must be logical ports available for an interface to become operational. Not all interfaces sharing logical ports can be operational simultaneously. Inactive interfaces do not consume a resource.

```
switch#show interfaces et1/1,4/1 interactions
* = includes less than 10G speeds that the interface is capable of

Ethernet1/1:
  Ethernet1/1-4/8 share 18 interface hardware resources
  For speed 400G-8
  ...
Ethernet4/1:
  Ethernet1/1-4/8 share 18 interface hardware resources
  For speed 400G-8
  ...
```

10.1.6.39 show interfaces negotiation

The **show interfaces negotiation** command displays the speed, duplex, and flow control auto-negotiation status for the specified interfaces.

Command Mode

EXEC

Command Syntax

```
show interfaces [INTERFACE] negotiation [INFO_LEVEL]
```

Parameters

- **INTERFACE** Interface type and numbers. Options include:
 - **no parameter** Display information for all interfaces.
 - **ethernet e_range** Ethernet interface range specified by **e_range**.
 - **management m_range** Management interface range specified by **m_range**.

Valid **e_range** and **m_range** formats include number, number range, or comma-delimited list of numbers and ranges.

- **INFO_LEVEL** Amount of information that is displayed. Options include:
 - **no parameter** Displays status and negotiated setting of local ports.
 - **detail** Displays status and negotiated settings of local ports and their peers.

Examples

- This command displays the negotiated status of **management 1** and **management 2** interfaces.

```
switch#show interface management 1-2 negotiation
Port          Autoneg      Negotiated Settings
  Status      Speed        Duplex      Rx Pause    Tx Pause
-----
Ma1           success     100M        full         off         off
Ma2           success     auto         auto         off         off
switch>
```

- This command displays the negotiated status of **management 1** interface and its peer interface.

```
switch#show interface management 1 negotiation detail
Management1 :

Auto-Negotiation Mode      10/100/1000 BASE-T (IEEE Clause 28)
Auto-Negotiation Status    Success

  Advertisements      Speed          Duplex          Pause
-----
    Local              10M/100M/1G   half/full      Disabled
    Link Partner       None           None           None

  Resolution          100Mb/s       full           Rx=off,Tx=off
switch>
```

10.1.6.40 show interfaces phy

The `show interfaces phy` command displays physical layer characteristics for the specified interfaces.

Command Mode

EXEC

Command Syntax

```
show interfaces [INTERFACE] phy [INFO_LEVEL]
```

Parameters

- **INTERFACE** Interface type and numbers. Options include:
 - *no parameter* All interfaces.
 - *ethernet e_range* Ethernet interfaces in specified range.

Valid *e_range* formats include number, number range, or comma-delimited list of numbers and ranges.

- **INFO_LEVEL** Amount of information that is displayed. Options include:
 - *no parameter* Command displays table that summarizes PHY data.
 - *detail* Command displays data block for each specified interface.

Examples

- This command summarizes PHY information for Ethernet interfaces 1-5.

```
switch#show interfaces ethernet 1-5 phy
Key:
U   = Link up
D   = Link down
R   = RX Fault
T   = TX Fault
B   = High BER
L   = No Block Lock
A   = No XAUI Lane Alignment
0123 = No XAUI lane sync in lane N

Port          PHY state      State Changes  Reset Count  PMA/PMD  PCS  XAUI
-----
Ethernet1    linkUp        14518        1750 U..      U.... U.....
Ethernet2    linkUp        13944        1704 U..      U.... U.....
Ethernet3    linkUp        13994        1694 U..      U.... U.....
Ethernet4    linkUp        13721        1604 U..      U.... U.....
Ethernet5    detectingXcvr 3             1         D..A0123
switch#
```

- This command displays detailed PHY information for **Ethernet interface 1**.

```
switch#show interfaces ethernet 1 phy detail
Current System Time: Mon Dec 5 11:32:57 2011
Ethernet1

PHY state          Current State      Changes      Last Change
HW resets          linkUp            14523        0:02:01 ago
Transceiver        10GBASE-SRL       1751         0:02:07 ago
Transceiver SN     C743UCZUD         1704         0:02:06 ago
Oper speed         10Gbps
Interrupt Count    71142
Diags mode         normalOperation
Model              ael2005c
Active uC image    microInit_mdio_SR_AEL2005C_28
Loopback           none
PMA/PMD RX signal detect ok                11497        0:37:24 ago
PMA/PMD RX link status up                11756        0:37:24 ago
PMA/PMD RX fault   ok                11756        0:37:24 ago
PMA/PMD TX fault   ok                0            never
PCS RX link status up                9859         0:02:03 ago
PCS RX fault       ok                9832         0:02:03 ago
PCS TX fault       ok                330          0:27:44 ago
```



```

PCS block lock          ok          9827          0:02:03 ago
PCS high BER           ok          8455          0:02:05 ago
PCS err blocks         255          0:02:03 ago
PCS BER                16          50092         0:02:05 ago
XFI/XAUI TX link status up          1282         0:27:44 ago
XFI/XAUI RX fault     ok          585          0:27:44 ago
XFI/XAUI TX fault     ok          2142         0:02:05 ago
XFI/XAUI alignment status ok          2929         0:02:05 ago
XAUI lane 0-3 sync    (0123) = 1111 2932         0:02:05 ago
XAUI sync w/o align HWM 0          never
XAUI sync w/o align max OK 5
XAUI excess sync w/o align 0          never
Xcvr EEPROM read timeout 46      4 days, 6:33:45 ago
Spurious xcvr detection 0          never
DOM control/status fail 0
I2C snoop reset       0
I2C snoop reset (xcvr) 0
Margin count          5          last > 0      0:00:00 ago
EDC resets            1          0:02:03 ago
EDC FFE0 - FFE11     -4 -5 57 -6 -6 -2 1 0 -2 -1 1 -1
EDC FBE1 - FBE4      6 -1 5 -1
EDC TFBE1 - TFBE4    1 2 1 2
EDC VGA1, VGA3       12 115
TX path attenuation   3.0 dB
TX preemphasis        (0,63,4) (pre,main,post)
switch#

```

10.1.6.41 show interfaces status errdisabled

The `show interfaces status errdisabled` command displays interfaces that are in errdisabled state, including their link status and errdisable cause.

Command Mode

EXEC

Command Syntax

```
show interfaces [INTERFACE] status errdisabled
```

Parameters

- **INTERFACE** Interface type and numbers. Options include:
 - **no parameter** Display information for all interfaces.
 - **ethernet e_range** Ethernet interface range specified by **e_range**.
 - **management m_range** Management interface range specified by **m_range**.
 - **port-channel p_range** Port-Channel Interface range specified by **p_range**.
- Valid **e_range** and **m_range** formats include number, number range, or comma-delimited list of numbers and ranges.

Example

- This command displays the error-disabled ports.

```
switch#show interfaces status errdisabled

Port      Name          Status          Reason
-----
Et49/2    multi-lane-intf  errdisabled    multi-lane-intf
Et49/3    multi-lane-intf  errdisabled    multi-lane-intf
Et49/4    multi-lane-intf  errdisabled    multi-lane-intf
switch>
```

10.1.6.42 show interfaces status

The **show interfaces status** command displays the interface name, link status, vlan, duplex, speed, and type of the specified interfaces. When the command includes a link status, the results are filtered to display only interfaces whose link status match the specified type.

Command Mode

EXEC

Command Syntax

```
show interfaces [INTERFACE]status [STATUS_TYPE]
```

Parameters

- **INTERFACE** Interface type and numbers. Options include:
 - **no parameter** All existing interfaces.
 - **ethernet e_range** Ethernet interfaces in the specified range.
 - **management m_range** Management interfaces in the specified range.
 - **port-channel p_range** All existing port-channel interfaces in the specified range.

Valid **e_range**, **m_range**, and **p_range** formats include number, number range, or comma-delimited list of numbers and ranges.

- **STATUS_TYP** Einterface status upon which the command filters output. Options include:
 - **no parameter** Command does not filter on interface status.
 - **connected** Interfaces connected to another port.
 - **notconnect** Unconnected interfaces that are capable of connecting to another port.
 - **disabled** Interfaces that have been powered down or disabled.
 - **sub-interfaces** L3 subinterfaces configured on the switch.

Command may include multiple status types (**connected**, **notconnect**, **disabled**), which can be placed in any order.

Examples

- This command displays the status of Ethernet interfaces 1-5.

```
switch#show interfaces ethernet 1-5 status
Port      Name              Status      Vlan      Duplex  Speed  Type
Et1       10GBASE-SRL      connected   1         full    10G
Et2       10GBASE-SRL      connected   1         full    10G
Et3       10GBASE-SRL      connected   1         full    10G
Et4       10GBASE-SRL      connected   1         full    10G
Et5       10GBASE-SRL      notconnect  1         full    10G Not
Present
```

- This command displays status information for all subinterfaces configured on the switch.

```
switch#show interfaces status sub-interfaces
Port      Name              Status      Vlan      Duplex  Speed  Type
Flags
Et1.1     connect          101        full     10G     dot1q-encapsu
lacion
Et1.2     connect          102        full     10G     dot1q-encapsu
lacion
```

```
Et1.3          connect      103      full    10G    dot1q-encapsu
lation
Et1.4          connect      103      full    10G    dot1q-encapsu
lation
switch>
```

10.1.6.43 show interface transceiver dom

The **show interface [<intf>] transceiver dom** command displays the most important current performance data on the media (line) side.

Example

```
switch#show interface Ethernet11/1 transceiver dom
Ch: Channel, N/A: not applicable, TX: transmit, RX: receive
mA: milliamperes, dBm: decibels (milliwatts), C: Celsius, V: Volts

Port 11
Last update: 0:00:05 ago
```

	Value

Case temperature	66.59 C
Voltage	3.26 V
TX power	-10.23 dBm
RX total power	-11.61 dBm
RX channel power	-11.94 dBm
Pre-FEC BER	1.82e-03
Post-FEC errored frames ratio	0.00e+00
Chromatic dispersion (short link)	0.00 ps/nm
Chromatic dispersion (long link)	0.00 ps/nm
Differential group delay	9.31 ps
SOPMD	0.00 ps^2
Polarization dependent loss	0.40 dB
Received OSNR estimate	35.10 dB
Received ESNR estimate	17.50 dB
Carrier frequency offset	0.00 MHz
Error vector magnitude	100.00 %
SOP rate of change	0.00 krad/s
Laser temperature	59.54 C
Laser frequency	193100.00 GHz

- BER: Bit Error Rate
- FEC: Forward Error Correction
- OSNR: Optical Signal to Noise Ratio
- ESNR: Electrical Signal to Noise Ratio
- SOP: State of Polarization
- SOPMD: State of Polarization Mode Dispersion

10.1.6.44 show interface transceiver eeprom

The **show interface [<intf>] transceiver eeprom** command displays the parsed capabilities.

Example

For 400GBASE-ZR, parsing of frequency tuning, power tuning (page 04h) and VDM configuration pages (20h-23h) is added.

```
switch#show interface Ethernet15/1 transceiver eeprom
Ethernet15 EEPROM:
...
Frequency tuning support (04h:128-129):
  Grid spacing capabilities (04h:128):
    100 GHz grid supported (04h:128): true
    12.5 GHz grid supported (04h:128): false
    25 GHz grid supported (04h:128): false
    3.125 GHz grid supported (04h:128): false
    33 GHz grid supported (04h:128): false
    50 GHz grid supported (04h:128): false
    6.25 GHz grid supported (04h:128): false
    75 GHz grid supported (04h:128): true
  Tunable wavelength (04h:128): true
  Fine tuning support (04h:129): false
Supported channel boundaries (04h:130-161):
  100 GHz grid (04h:150-153):
    Lowest channel (04h:150-151): -18
    Lowest frequency (04h:150-151): 191300000 MHz
    Highest channel (04h:152-153): 30
    Highest frequency (04h:152-153): 196100000 MHz
  75 GHz grid (04h:158-161):
    Lowest channel (04h:158-159): -72
    Lowest frequency (04h:158-159): 191300000 MHz
    Highest channel (04h:160-161): 120
    Highest frequency (04h:160-161): 196100000 MHz
Programmable output power advertisement (04h:196-201):
  Lane programmable output power supported (04h:196): false
VDM configuration (20h:128-255;21h:128-255):
  VDM group 1 (20h:128-255):
    Parameter 1 (20h:128-129):
      Lane (20h:128): 0
      Threshold ID (20h:128): 0
      Parameter type (20h:129): Laser temperature
    Parameter 3 (20h:132-133):
      Lane (20h:132): 0
      Threshold ID (20h:132): 2
      Parameter type (20h:133): eSNR host input
    Parameter 4 (20h:134-135):
      Lane (20h:134): 1
      Threshold ID (20h:134): 2
      Parameter type (20h:135): eSNR host input
    Parameter 5 (20h:136-137):
      Lane (20h:136): 2
      Threshold ID (20h:136): 2
      Parameter type (20h:137): eSNR host input
  ...
    Parameter 84 (21h:166-167):
      Lane (21h:166): 0
      Threshold ID (21h:166): 14
      Parameter type (21h:167): MER
  Number of VDM groups supported (2Fh:128): 2
```

10.1.6.45 show interfaces transceiver channels

The **show interfaces transceiver channels** command displays current wavelength/frequency settings for the specified channels.

Command Mode

EXEC

Command Syntax

```
show interfaces [INTERFACE e_range] transceiver channels
```

Parameters

- **INTERFACE** Interface type and port numbers.
 - **ethernet e_range** Ethernet interface range specified by **e_range**.

Related Commands

- [transceiver channel](#)
- [show interfaces transceiver hardware](#)

Example

This command displays the supported wave lengths/frequencies and their corresponding channel numbers on **Ethernet interface 4 to slot 3 through 4**.

```
switch(config-as-if-Et4/1/3)#show interfaces ethernet 4/3/4 transceiver
channels
Name: Et4/3/4
100GHz- 50GHz-
Wavelength Frequency spacing spacing
(nm) (GHz) Channel Channel
-----
1567.95 191,200 1 1
1567.54 191,250 2
1567.13 191,300 2 3
1566.72 191,350 4
....
1529.16 196,050 98
1528.77 196,100 50 99
1528.38 196,150 100
switch(config-as-if-Et4/1/3)#
```

10.1.6.46 show interfaces transceiver hardware

The **show interfaces transceiver hardware** command displays current wavelength/frequency settings for the specified transceiver interfaces.

Command Mode

EXEC

Command Syntax

```
show interfaces [INTERFACE] ethernet e_range transceiver hardware
```

Parameters

- **INTERFACE** Interface type and port numbers.
 - **ethernet *e_range*** Ethernet interface range specified by *e_range*.

Related Commands

- [transceiver channel](#)
- [show interfaces transceiver channels](#)

Example

This command displays the current wavelength/frequency settings on **Ethernet interface 4** to **slot 3** through **4**.

```
switch(config-as-if-Et4/1/3)#show interfaces ethernet 4 / 3 / 4
transceiver hardware
Name: Et4/3/4
Media Type: 10GBASE-DWDM
Configured Channel : 39
Configured Grid (GHz) : 50
Computed Frequency (GHz) : 193,100
Computed Wavelength (nm) : 1552.52
Operational Channel : 39 (Default)
Operational Grid (GHz) : 50 (Default)
Operational Frequency (GHz): 193,100
Operational Wavelength (nm): 1552.52
switch(config-as-if-Et4/1/3)#
```

10.1.6.47 show interfaces transceiver properties

The **show interfaces transceiver properties** command displays configuration information for the specified interfaces. Information provided by the command includes the media type, interface speed-duplex settings, speed-duplex operating state.

Command Mode

EXEC

Command Syntax

```
show interfaces [INTERFACE] transceiver properties
```

Parameters

- INTERFACE Interface type and numbers. Options include:
 - **no parameter** Display information for all interfaces.
 - **ethernet e_range** Ethernet interface range specified by **e_range**.
 - **management m_range** Management interface range specified by **m_range**.

Valid **e_range** and **m_range** formats include number, number range, or comma-delimited list of numbers and ranges.

Related Commands

- [show interfaces transceiver](#)

Example

This command displays the media type, speed, and duplex properties for Ethernet interfaces 1-3.

```
switch#show interfaces ethernet 1-3 transceiver properties
Name : Et1
Administrative Speed: 10G
Administrative Duplex: full
Operational Speed: 10G (forced)
Operational Duplex: full (forced)
Media Type: 10GBASE-SRL

Name : Et2
Administrative Speed: 10G
Administrative Duplex: full
Operational Speed: 10G (forced)
Operational Duplex: full (forced)
Media Type: 10GBASE-SRL

Name : Et3
Administrative Speed: 10G
Administrative Duplex: full
Operational Speed: 10G (forced)
Operational Duplex: full (forced)
Media Type: 10GBASE-SRL

switch>
```

10.1.6.48 show interfaces transceiver

The `show interfaces transceiver` command displays operational transceiver data for the specified interfaces.

Command Mode

EXEC

Command Syntax

```
show interfaces [INTERFACE] transceiver [DATA_FORMAT]
```

Parameters

- **INTERFACE** Interface type and numbers. Options include:
 - *no parameter* All interfaces.
 - **ethernet e_range** Ethernet interface range specified by *e_range*.
 - **management m_range** Management interface range specified by *m_range*.

Valid *e_range*, and *m_range* formats include number, number range, or comma-delimited list of numbers and ranges.

- **DATA_FORMAT** format used to display the data. Options include:
 - *no parameter* table entries separated by tabs.
 - **csv** table entries separated by commas.

Related Commands

[show interfaces transceiver properties](#)

Example

This command displays transceiver data on *Ethernet interfaces 1* through *Ethernet interfaces 4*.

```
switch#show interfaces ethernet 1-4 transceiver
If device is externally calibrated, only calibrated values are printed.
N/A: not applicable, Tx: transmit, Rx: receive.
mA: milliamperes, dBm: decibels (milliwatts).

```

Port	Temp (Celsius)	Voltage (Volts)	Bias Current (mA)	Optical Tx Power (dBm)	Optical Rx Power (dBm)	Last Update (Date Time)
Et1	34.17	3.30	6.75	-2.41	-2.83	2011-12-02 16:18:48
Et2	35.08	3.30	6.75	-2.23	-2.06	2011-12-02 16:18:42
Et3	36.72	3.30	7.20	-2.02	-2.14	2011-12-02 16:18:49
Et4	35.91	3.30	6.92	-2.20	-2.23	2011-12-02 16:18:45

```
switch#
```

10.1.6.49 show monitor ethernet oam profile

The **show monitor ethernet oam profile** command displays configuration information for the specified ethernet OAM profile name or the summary information of all configured profile names.

Command Mode

EXEC

Command Syntax

```
show monitor ethernet oam profile [name | summary]
```

Parameters

- **name** The EOAM profile name.
- **summary** The EOAM summary of all profiles that are configured.

Related Commands

- [link-error](#)
- [monitor ethernet oam profile](#)

Examples

- This command displays the OAM profile configuration information for the specific profile name.

```
switch#show monitor ethernet oam profile[name]

Ethernet OAM Profile : p

Error Type : symbol

                Threshold :    20 frames
                Action    :      log
                Period    :    20 seconds

Error Type : fcs

                Threshold :    10 frames
                Action    : linkfault
                Period    :   100 frame

Recovery Timeout : 20
```

- This command displays the OAM profile configuration summary for all profiles configured.

```
switch#show monitor ethernet oam profile [name] summary

Eoam Profile : p
Configured on: Et3/1-4,5
```

10.1.6.50 show platform fm6000 agileport map

The `show platform fm6000 agileport map` command displays the list of Ethernet interfaces that are combinable to form a higher speed port.

Command Mode

Privileged EXEC

Command Syntax

```
show platform fm6000 agileport map
```

Example

These commands displays the agile port map for the switch, then configures Ethernet interface 13 as a 40G port, subsuming Ethernet interfaces 15, 17 and 19.

```
switch#show platform fm6000 agileport map
-----
Agile Ports          |          Interfaces subsumed in 40G link
-----
Ethernet1           | Ethernet3      Ethernet5      Ethernet7
Ethernet2           | Ethernet4      Ethernet6      Ethernet8
Ethernet13          | Ethernet15     Ethernet17     Ethernet19
Ethernet14          | Ethernet16     Ethernet18     Ethernet20

switch#config
switch(config)#interface ethernet 13
switch(config-if-Et13)#speed 40gfull

WARNING! Executing this command will cause the forwarding agent
          to be restarted. All interfaces will briefly drop links
          and forwarding on all interfaces will momentarily stop.

          Do you wish to proceed with this command? [y/N]

Ethernet13 configured for 40G.
Ethernet15, Ethernet17 and Ethernet19 are now subsumed.
switch(config-if-Et13)#
```

10.1.6.51 show platform trident flexcounters

Use the **show platform trident flexcounters** command to display the L3 interfaces when the corresponding hardware counter feature is enabled.

Command Mode

Privileged EXEC

Command Syntax

```
show platform trident flexcounters [vni [egress summary | ingress summary]][[vtep [decap summary | encap summary]]]
```

Parameters

- **vni** Displays the VNI feature state.
 - **egress summary** Displays the egress direction flexcounters summary.
 - **ingress summary** Displays the ingress direction flexcounters summary.
- **vtep** Displays the VTEP feature state
 - **decap summary** Displays the decap direction flexcounter summary.
 - **encap summary** Displays the encap direction flexcounter summary.

Examples

- The following example displays the headings for the **show platform trident flexcounters vni egress summary** show command.

```
switch#show platform trident flexcounters vni egress summary
VNI      EgrVfiIndex  PoolId  OffsetMode  BaseCounterIndex
-----
```

- The following example displays the headings for the **show platform trident flexcounters vni ingress summary** show command.

```
switch#show platform trident flexcounters vni ingress summary
VNI      VfiIndex  PoolId  OffsetMode  BaseCounterIndex
-----
```

- The following example displays the headings for the **show platform trident flexcounters vtep decap summary** show command.

```
switch#show platform trident flexcounters vtep decap summary
VTEP     SvpIndex  PoolId  OffsetMode  BaseCounterIndex
-----
```

- The following example displays the headings for the **show platform trident flexcounters vtep encap summary** show command.

```
switch#show platform trident flexcounters vtep encap summary
VTEP     DvpIndex  PoolId  OffsetMode  BaseCounterIndex
-----
```

10.1.6.52 show platform trident flexcounters l3intf

Use the `show platform trident flexcounters l3intf` command to display the subinterface, SVI, and GRE tunnel interface features.

Command Mode

EXEC

Command Syntax

```
show platform trident flexcounters l3intf [[in | out] [summary | values]]
```

Parameters

- **in summary** Displays the details of the hardware resources allocated to the ingress subinterface, SVI, and GRE Tunnel Interface features.
- **out summary** Displays the details of the hardware resources allocated to the egress subinterface, SVI, and GRE Tunnel Interface features.
- **in values** Displays the counters in the counter and snapshot table for the ingress subinterface, SVI, and GRE Tunnel Interface features.
- **out values** Displays the counters in the counter and snapshot table for the egress subinterface, SVI, and GRE Tunnel Interface features.

 **Note:** The counter values in this show command output are not reset by the `clear counters` command.

Examples

- Use the `show platform trident flexcounters l3intf in summary` command to display the details of the hardware resources allocated to the ingress subinterface, SVI, and GRE Tunnel Interface features.

```
switch#show platform trident flexcounters l3intf in summary
L3intf          CounterIndex  PoolId  OffsetMode  BaseCounterIn
dex
-----
-----
```

- Use the `show platform trident flexcounters l3intf out summary` command to display the details of the hardware resources allocated to the egress subinterface, SVI, and GRE Tunnel Interface features.

```
switch#show platform trident flexcounters l3intf out summary
L3intf          CounterIndex  PoolId  OffsetMode  BaseCounterIn
dex
-----
-----
```

- Use the `show platform trident flexcounters l3intf in values` command to display the counters in the counter and snapshot table for the ingress subinterface, SVI, and GRE Tunnel Interface features.

```
switch#show platform trident flexcounters l3intf in values
L3intf          Offser Bytes(cntTbl)  Bytes(snapTbl)  Pkts(cntTbl)
Pkts(snapTbl)
-----
-----
```

- Use the `show platform trident flexcounters l3intf out values` command to display the counters in the counter and snapshot table for the egress subinterface, SVI, and GRE Tunnel Interface features.

```
switch#show platform trident flexcounters l3intf out values

L3intf          Offser Bytes (cntTbl)    Bytes (snapTbl)    Pkts (cntTbl)
  Pkts (snapTbl)
-----
-----
```

10.1.6.53 show poe

The `show poe` command displays PoE information for a specified port range or for all ports.

Command Mode

Privileged EXEC

Command Syntax

```
show poe [INTERFACE]
```

Parameters

- INTERFACE Interface type and numbers. Options include:
 - **no parameter** Display information for all interfaces.
 - **ethernet e_range** Ethernet interface range specified by **e_range**.

Example

- This command displays PoE information for **Ethernet interface 46**.

```
switch(config)#show poe interface ethernet 46
```

Port	Enabled	Enabled	Limit	Power	State	Class	Power	Current	Voltage	Temperature
-----	-----	-----	-----	-----	-----	-----	-----	-----	-----	-----
46	True	True	15.40W	15.40W	powered	class0	1.40W	27.00mA	55.04V	41.25C

```
switch(config-if-Et7)#
```

10.1.6.54 show route counters

Use the `show route [ipv4 | ipv6] counters` to display the IPv4 or IPv6 pack and byte counts.

Command Mode

EXEC

Command Syntax

```
show route [ipv4 | ipv6]
```

Parameters

- **ipv4** Displays IPv4 route counters.
- **ipv6** Displays IPv6 route counters.

Example

The following example displays the IPv4 packet and byte count.

```
switch#show route ipv4 counters
Vrf Name      Prefix          Packet Count    Byte Count
-----
default       22.0.0.0/8      0               0
default       32.0.0.0/8      0               0
```

10.1.6.55 show transceiver status interface

The **show transceiver status interface** [<intf>] command displays the most important alarms, faults and interface status.

Example

For 400GBASE-ZR modules, media and host side coherent alarms, host-side pre-FEC BER, defined in the Coherent CMIS and post-FEC BER have been added to the command's output:

```
switch#show transceiver status interface Ethernet14/1
Change                               Current State           Changes                 Last
-----                               -
Port 14
Transceiver                        400GBASE-ZR          1
0:15:09 ago
  Transceiver SN                      200554050
  Presence                             present
  Adapters                             none
  Bad EEPROM checksums                 0                     never
  Resets                               0
0:15:14 ago
  Interrupts                           0                     never
  Data path firmware fault             ok                    0                     never
  Module firmware fault                ok                    0                     never
  Temperature high alarm                ok                    0                     never
  Temperature high warn                 ok                    0                     never
  Temperature low alarm                 ok                    0                     never
  Temperature low warn                  ok                    0                     never
  Voltage high alarm                    ok                    0                     never
  Voltage high warn                     ok                    0                     never
  Voltage low alarm                     ok                    0                     never
  Voltage low warn                      ok                    0                     never
Module state                        ready                4
0:14:55 ago
  Data path 1 state                  activated            4
0:07:21 ago
  Data path 2 state                  activated            4
0:07:21 ago
  Data path 3 state                  activated            4
0:07:21 ago
  Data path 4 state                  activated            4
0:07:21 ago
  Data path 5 state                  activated            4
0:07:21 ago
  Data path 6 state                  activated            4
0:07:21 ago
  Data path 7 state                  activated            4
0:07:21 ago
  Data path 8 state                  activated            4
0:07:21 ago
  RX LOS                               ok                    2
0:05:54 ago
  TX fault                             ok                    0                     never
  RX CDR LOL                           ok                    0                     never
  TX power high alarm                   ok                    0                     never
  TX power high warn                     ok                    2
0:07:39 ago
  TX power low alarm                     ok                    2
0:07:50 ago
```

TX power low warn	ok	4	
0:07:39 ago			
TX bias high alarm	ok	0	never
TX bias high warn	ok	0	never
TX bias low alarm	ok	0	never
TX bias low warn	ok	0	never
RX power high alarm	ok	0	never
RX power high warn	ok	0	never
RX power low alarm	ok	0	never
RX power low warn	ok	0	never
TX loss of alignment	ok	0	never
TX out of alignment	ok	0	never
TX clock monitor unit LOL	ok	0	never
TX reference clock LOL	ok	0	never
TX deskew LOL	ok	0	never
TX FIFO error	ok	0	never
RX demodulator LOL	ok	0	never
RX CD compensation LOL	ok	0	never
RX loss of alignment	ok	0	never
RX out of alignment	ok	0	never
RX deskew LOL	ok	0	never
RX FIFO error	ok	0	never
RX FEC excessive degrade	ok	0	never
RX FEC detected degrade	ok	0	never
Freq tuning in progress	idle	0	never
Freq tuning busy	ok	0	never
Freq tuning invalid channel	ok	0	never
Freq tuning completed	no	2	
0:07:34 ago			
Ethernet14/1			
Operational speed		400Gbps	
Pre-FEC bit error rate		0.00e+00	
Post-FEC errored frames ratio		0.00e+00	
TX LOS			
Host lane 1	ok	0	never
Host lane 2	ok	0	never
Host lane 3	ok	0	never
Host lane 4	ok	0	never
Host lane 5	ok	0	never
Host lane 6	ok	0	never
Host lane 7	ok	0	never
Host lane 8	ok	0	never
TX CDR LOL			
Host lane 1	ok	0	never
Host lane 2	ok	0	never
Host lane 3	ok	0	never
Host lane 4	ok	0	never
Host lane 5	ok	0	never
Host lane 6	ok	0	never
Host lane 7	ok	0	never
Host lane 8	ok	0	never
TX adaptive input EQ fault			
Host lane 1	ok	0	never
Host lane 2	ok	0	never
Host lane 3	ok	0	never
Host lane 4	ok	0	never
Host lane 5	ok	0	never
Host lane 6	ok	0	never
Host lane 7	ok	0	never
Host lane 8	ok	0	never



Note: In the operational state, module state is 'Ready' and datapath state for all 8 lanes is activated.

10.1.6.56 show vxlan counters vni

Use the `show vxlan counters vni` command to display the encapsulation and decapsulation counters at the VNI.

Command Mode

Privileged EXEC

Command Syntax

```
show vxlan counters vni [encap | decap]
```

Parameters

- **encap** Displays the encapsulation related counters at the VNI.
- **decap** Displays the decapsulation related counters at the VNI.

Examples

- The following `show vxlan counters vni encap` command displays the encapsulation related commands at the VNI.

```
switch#show vxlan counters vni encap
```

VNI	Encap Bytes	Encap Packets	Encap BUM Packets	Encap Drop Packets
2824963	0	0	0	0
7023745	0	0	0	0

Encap Packets displays the total count of L2 packets that have been successfully encapsulated by the VNI towards the VTEP.

Encap Drop Or Exception Packets display the total count of L2 packets that have been encapsulated and dropped for any reason.

- The following `show vxlan counters vni decap` command displays the decapsulation related counters at the VNI.

```
switch#show vxlan counters vni decap
```

VNI	Decap Bytes	Decap Known Unicast Packets	Decap BUM Packets	Decap Drop Or Exception Packets
2824963	0	0	0	0
7023745	0	0	0	0

Decap Known UnicastPkts displays the total count of L2 known unicast packets coming into the VTI hitting the VTEP and getting decapsulated.

Decap BUM Packets displays the total count of L2 BUM packets coming into the VTI hitting the VTEP and getting decapsulated.

Decap Drop or Exception Packets displays the count of L2 packets coming into the VTI and getting dropped for any reason.

10.1.6.57 speed

The **speed** command configures the transmission speed and duplex setting for the configuration mode interface. The scope and effect of this command depends on the interface type. Interface types include:

- **40GBASE (QSFP+)**: Default is 4x10G-full. **Speed forced 40gfull** and **Speed auto 40gfull** configure interface as a 40G port.
- **10GBASE-T**: Default is 10G-full. **Speed** command affects interface.
- **10GBASE (SFP+)**: Default is 10G-full. **Speed** command does not affect interface.
- **1000BASE (copper)**: Default is 1G-full. **speed auto 100full** affects interface.
- **1000BASE (fiber)**: Default is 1G-full. **Speed** command does not affect interface.
- **10/100/1000**: Default is auto-negotiation. **Speed** command (10/100/1000 options) affects interface.

The **speed 40gfull** and **auto 40gfull** commands configure a QSFP+ Ethernet interface as a 40G port. The **no speed** and **no auto 40gfull** commands configure a QSFP+ Ethernet interface as four 10G ports. These commands must be applied to the /1 port. These commands are hitless on the 7050X, 7060X, 7250X, 7260X, 7280SE, 7300X, 7320X and 7500E series platforms. On all other platforms, these commands restart the forwarding agent, which will result in traffic disruption.

The **no speed** and **default speed** commands restore the default setting for the configuration mode interface by removing the corresponding **speed** command from **running-config**.

Command Mode

Interface-Ethernet Configuration

Interface-Management Configuration

Command Syntax

speed MODE

no speed

default speed

Parameters

- **MODE** Transmission speed and duplex setting. Options include:
 - **speed auto** auto negotiation mode. (For SFP-1G-T, auto-negotiates 1Gbps, this is because no speed is specified, and we are defaulting to advertise 1G)
 - **speed auto 40gfull** auto negotiation mode with clause 73 auto negotiation.
 - **speed auto 1G full/ speed 1G** auto-negotiated 1Gbps (note that per BASE-T standard, 1G must be negotiated)
 - **speed auto 100full** auto-negotiated 100Mbps.
 - **speed 100full** non-negotiated and true-forced 100Mbps.
-  **Note:** Interfaces using clause 73 auto negotiation must connect to a device that runs clause 73 auto negotiation.
- **sfp-1000basel auto** auto-negotiation mode (1000BASE-T interfaces only).
- **10000full** 10G full duplex.
- **1000full** 1G full duplex.
- **1000half** 1G half duplex.
- **100full** 100M full duplex.
- **100gfull** 100G full duplex.
- **100half** 100M half duplex.
- **10full** 10M full duplex.
- **10half** 10M half duplex.
- **40gfull** 40G full duplex.

On 40GBASE and 100GBASE interfaces, options that change the SFP+ and MXP interfaces (the **auto 40gfull**, the **40gfull**, and the **no speed** options) may restart the forwarding agent on some switch platforms, disrupting traffic on all ports for more than a minute.

Guidelines

-  **Note:** The **SFP-1G-T** transceivers advertise one speed at a time only. Hence, the desired speed and negotiation must be configured explicitly using the **speed auto**, **speed auto 1G full/**, **speed 1G**, **speed auto 100full**, and **speed 100full** commands.

Examples

- This command configures a 40GBASE interface as a 40G port.

```
switch(config)#interface ethernet 49/1
switch(config-if-Et49/1)#speed 40gfull
switch(config-if-Et49/1)#show interface ethernet 49/1 - 49/4 status
Port      Name      Status      Vlan      Duplex  Speed Type
Et49/1    CR4       connected   in Po999  full    40G  40GBASE-
Et49/2    CR4       errdisabled inactive   unconf unconf 40GBASE-
Et49/3    CR4       errdisabled inactive   unconf unconf 40GBASE-
Et49/4    CR4       errdisabled inactive   unconf unconf 40GBASE-
switch(config-if-Et49/1)#
```

- This command configures a 40GBASE interface as four 10G ports (default configuration).

```
switch(config-if-Et49/1)#no speed
switch(config-if-Et49/1)#show interface ethernet 49/1 - 49/4 status
Port      Name      Status      Vlan      Duplex  Speed Type
Et49/1    SR4       connected   routed    full    10G  40GBASE-
Et49/2    SR4       connected   routed    full    10G  40GBASE-
Et49/3    SR4       connected   routed    full    10G  40GBASE-
Et49/4    SR4       notconnect  inactive  full    10G  40GBASE-
switch(config-if-Et49/1)#
```

10.1.6.58 system

The **system** command allows the user to configure the system-wide TCAM profiles such as default, mirroring-acl, mpls-evpn, pbr-match-nexthop-group, qos, tap-aggregation-default, tap-aggregation-extended, tc-counters, test, and vxlan-routing.

The **exit** command returns the switch to global configuration mode.

Command Mode

Hardware TCAM

Command Syntax

system profile *name*

Parameter

name TCAM profile name.

Reference

[hardware tcam](#)

Example

This commands allow the switch to configure the TCAM profile qos.

```
switch(config-hw-tcam) #system profile qos
```

10.1.6.59 threshold

The **threshold** command configures the link monitoring threshold value that is specified for a link error.

The **no threshold** and the **default threshold** commands remove the threshold value specified for the chosen link error.

Command Mode

Link-error Configuration

Command Syntax

```
[fcs | symbol] threshold threshold_value
```

```
no [fcs | symbol] threshold threshold_value
```

```
default [fcs | symbol] threshold threshold_value
```

Parameters

- **fcs** Inbound packets with Frame check sequence (FCS) error.
- **symbol** Inbound packets with symbol error.
- **threshold_value** Specifies the threshold value in number of errors. The value ranges from 1 to 100.

Related Commands

- [action](#)
- [period](#)

Example

These commands set the threshold value of **20** for the **profile profile1** in the Link-error configuration mode.

```
switch(config)#monitor ethernet oam  
switch(config-eoam)#profile profile1  
switch(config-eoam-profile-profile1)#link-error  
switch(config-eoam-profile-profile1-link-error)#symbol threshold 20
```

10.1.6.60 transceiver channel

The **transceiver channel** command displays transceiver wavelength/frequency by channel number. The channel numbering depends on the selected grid-spacing mode. The default grid-spacing mode is 50GHz-spacing.

- If the startup configuration does not specify the channel number for the interface, the transceiver will automatically tune to the default channel (i.e. channel-39 of 50GHz-spacing grid) when it is inserted.
- If the configured wavelength/frequency is not supported by the transceiver, the transceiver is tuned to the default channel (i.e. channel-39 of 50GHz-spacing grid).

The interface is shutdown before the channel number is configured.

Command Mode

Global Configuration

Command Syntax

```
transceiver channel CHANNEL_NUMBER grid-spacing SPACING_GRID
```

```
no transceiver channel CHANNEL_NUMBER grid-spacing SPACING_GRID
```

```
default transceiver channel CHANNEL_NUMBER grid-spacing SPACING_GRID
```

Parameters

- **CHANNEL-NUMBER** The default channel is 39 (50GHz-spacing grid) which corresponds to a frequency of 193,100 GHz and a wavelength of 1552.52 nm.
- **GRID_SPACING** Grid-spacing mode (optional) depends on the selected grid-spacing mode. The default grid-spacing mode is 50GHz-spacing. For example, channel 39 of 50GHz-spacing grid is equivalent to channel 20 of 100GHz-spacing grid, which corresponds to a frequency of 193,100 GHz and a wavelength of 1552.52 nm.
 - **SPACING_GRID** default grid-spacing mode in GHz.

Related Commands

- [show interfaces transceiver channels](#)
- [show interfaces transceiver hardware](#)

Example

This command tunes the transceiver on slot number 4 to slot 1 through 3 of 50GHz-spacing grid.

```
switch(config-as) #interface ethernet 4/1/3
switch(config-if-Et4/1/3) #transceiver channel 1 grid-spacing 50
switch(config-if-Et4/1/3) #
```

10.1.6.61 transceiver qsfp default-mode

The `transceiver qsfp default-mode` command specifies the transmission mode of all QSFP transceiver modules that are not explicitly configured.

Each QSFP+ module Ethernet interface is configurable as a single 40G port or as four 10G ports. The switch displays four ports for each interface. Each ports status depends on the interface configuration:

- The /1 port is active (**connected** or not connected), regardless of the interface configuration.
- The /2, /3, and /4 ports are **error-disabled** when the interface is configured as a single 40G port.
- all ports are active (**connected** or not connected), when the interface is configured as four 10G ports.

QSFP modules that are not configured through a `speed` command are operated as four 10G ports.

The `no transceiver qsfp default-mode` and `default transceiver qsfp default-mode` commands restore the default-mode transceiver setting from 40G to 4x10G.

Command Mode

Global Configuration

Command Syntax

```
transceiver qsfp default-mode 4x10G
```

```
no transceiver qsfp default-mode
```

```
default transceiver qsfp default-mode
```

 **Note:** QSFP100 ports with external PHY always have 40G as the default QSFP mode.

Guidelines

The `transceiver qsfp default-mode 4x10g` statement is always in *running-config* and cannot be modified or removed in the current release.

Example

- When default QSFP mode is configured as 4x10G, the `show running-config` contains `transceiver qsfp default-mode 4x10G`. `show interfaces hardware` shows 10G as the default speed.

```
switch(config)#transceiver qsfp default-mode 4x10G
switch(config)#show running-config | grep 4x10G
transceiver qsfp default-mode 4x10G
switch(config)#show interfaces ethernet 35/1 hardware
* = Requires speed group setting change
Ethernet35/1
  Model:          DCS-7280CR3-32P4
  Type:           40GBASE-CR4
  Speed/Duplex:  10G/full (default), 40G/full, auto
  Flowcontrol:   rx-(off,on,desired),tx-(off)
```

- When QSFP mode configuration is reverted to the default, `show running-config` does not contain `transceiver qsfp default-mode 4x10G`. `show interfaces hardware` shows 40G as the default speed.

```
switch(config)#no transceiver qsfp default-mode
switch(config)#show running-config | grep 4x10G
switch(config)#show interfaces ethernet 35/1 hardware
* = Requires speed group setting change
Ethernet35/1
  Model:          DCS-7280CR3-32P4
  Type:           40GBASE-CR4
```

```
Speed/Duplex: 10G/full, 40G/full (default), auto
Flowcontrol:  rx-(off,on,desired),tx-(off)
```

10.2 Port Channels and LACP

This chapter describes channel groups, port channels, port channel interfaces, and the Link Aggregation Control Protocol (LACP). This chapter contains the following sections:

- [Port Channel Introduction](#)
- [Port Channel Conceptual Overview](#)
- [Port Channel Configuration Procedures](#)
- [Load Balancing Hash Algorithms](#)
- [Port Channel and LACP Configuration Commands](#)

10.2.1 Port Channel Introduction

Arista's switching platforms support industry-standard link aggregation protocols. Arista switches optimize traffic throughput by using MAC addressing, IP addressing, and services fields to effectively load share traffic across aggregated links. Managers can configure multiple ports into a logical port channel, either statically or dynamically through the IEEE Link Aggregation Control Protocol (LACP). Various negotiation modes are supported to accommodate different configurations and peripheral requirements, including LACP fallback to support devices that need simple network connectivity to retrieve images or configurations prior to engaging port channel aggregation modes.

Arista's Multi-chassis Link Aggregation protocol (MLAG) supports LAGs across paired Arista switches to provide both link aggregation and active/active redundancy.

10.2.2 Port Channel Conceptual Overview

10.2.2.1 Channel Groups and Port Channels

A port channel is a communication link between two switches supported by matching channel group interfaces on each switch. A port channel is also referred to as a Link Aggregation Group (LAG). Port channels combine the bandwidth of multiple Ethernet ports into a single logical link.

A channel group is a collection of Ethernet interfaces on a single switch. A port channel interface is a virtual interface that serves a corresponding channel group and connects to a compatible interface on another switch to form a port channel. Port channel interfaces can be configured and used in a manner similar to Ethernet interfaces. Port channel interfaces are configurable as Layer 2 interfaces, Layer 3 (routable) interfaces, and VLAN members. Most Ethernet interface configuration options are also available to port channel interfaces.

10.2.2.2 Port Channel Subinterfaces

Port channel subinterfaces divide a single port channel interface into multiple logical L3 interfaces based on the 802.1q tag (VLAN ID) of incoming traffic. Subinterfaces are commonly used in the L2/L3 boundary device, but they can also be used to isolate traffic with 802.1q tags between L3 peers by assigning each subinterface to a different VRF.

For further details about subinterfaces, see [Subinterfaces](#).

10.2.2.3 Link Aggregation Control Protocol (LACP)

The Link Aggregation Control Protocol (LACP), described by IEEE 802.3ad, defines a method for two switches to automatically establish and maintain link aggregation groups (LAGs, also called channel groups or port channels). Using LACP, a switch can configure LACP-compatible ports into a dynamic LAG. The ports try to complete LACP negotiation automatically with the linked ports (also configured as a dynamic LAG) on the partner switch. The maximum number of ports per LAG varies by platform;

numbers for each platform in the latest EOS release are available here: <https://www.arista.com/en/support/product-documentation/supported-features>.

Static LAGs

In static mode (with the channel-group mode configured as **on** on the member interfaces), the switch aggregates links without an awareness of LAGs on the partner switch and without LACP negotiation. The member ports do not send LACP packets or process inbound LACP packets on static LAGs. Packets may drop when static LAG configurations differ between switches.

Dynamic LAGs

Dynamic LAGs are aware of their partners' port-channel states. Interfaces configured as dynamic LAGs are designated as **active** or **passive**.

- **Active interfaces** send LACP Protocol Data Units (LACP PDUs) at a rate of one per second when forming a channel with an interface on the peer switch. An aggregate forms if the peer runs LACP in active or passive mode.
- **Passive interfaces** only send LACP PDUs in response to PDUs received from the partner. The partner switch must be in active mode and initiates negotiation by sending a LACP packet. The passive mode switch receives and responds to the packet to form a LAG.

An active interface can form port channels with passive or active partner interfaces, but port channels are not formed when the interface on each switch is passive.

[Table 63: LACP Mode Combinations](#) summarizes the effect of different LACP mode combinations:

Table 63: LACP Mode Combinations

Switch 1	Switch 2	Comments
active	active	Links aggregate when LACP negotiation is successful.
active	passive	Links aggregate when LACP negotiation is successful.
passive	passive	Links do not aggregate because LACP negotiation is not initiated.
on (static)	on (static)	Links aggregate without LACP.
on (static)	active or passive	Links aggregate on the static switch without LACP; links do not aggregate on the other switch, and no port-channel connection is established with the partner.

During synchronization, interfaces in dynamic LAGs transmit one LACP PDU per second. After synchronization is complete, interfaces exchange one PDU every thirty seconds, facilitated by a default timeout of 30 seconds and a failure tolerance of three. Under these parameters, when the switch does not receive a LACP PDU for an interface during a ninety-second period, it records the partner interface as **failed** and removes the interface from the port channel.

Fallback Mode

An active interface that is not in fallback mode does not form a LAG until it receives PDUs from, and negotiates with its peer. Fallback mode allows an active LACP interface to maintain a LAG without receiving PDUs from its peer. The fallback timer specifies the period the LAG waits to receive a peer PDU. Upon timer expiry, the port channel reverts to its configured fallback mode if one is configured.

Static fallback: the port channel maintains one active port while in fallback mode; all its other member ports are in standby mode until a LACP PDU is received by the port channel. All member ports send (and can receive) LACP PDUs, but only the active port sends or receives data.

Individual fallback: all member ports act as individual switch ports while in fallback mode. Individual port configuration (rather than port channel configuration) is active while the port channel is in fallback mode, with the exception of ACLs. This includes VLAN membership. All member ports send and receive data, and continue to send LACP PDUs. As soon as a LACP PDU is received by a member of the port channel, all ports revert to normal port-channel operation.

The switch uses a link aggregation hash algorithm to determine the forwarding path within a link aggregation group. The IP and MAC header fields can be selected as components of the hash algorithm.

10.2.3 Port Channel Configuration Procedures

These sections describe channel group and port channel configuration procedures:

- [Configuring a Channel Group](#)
- [Configuring a Port Channel Interface](#)
- [Configuring Port Channel Subinterfaces](#)
- [Configuring LACP](#)
- [Displaying Port Channel Information](#)

10.2.3.1 Configuring a Channel Group

Creating a Channel Group

The `channel-group` command assigns the configuration-mode Ethernet interfaces to a channel group, creates the channel group if it does not already exist, and specifies LACP attributes for the channel.

Channel groups are associated with a port channel interface immediately upon their creation. A command that creates a new channel group also creates a port channel with a matching ID. The port channel is configured in port-channel configuration mode. Configuration changes to a port channel interface propagate to all Ethernet interfaces in the corresponding channel group.

LACP is enabled on the member interfaces by setting the channel-group mode to **active** or **passive**. Setting the mode to **on** disabled LACP on the member interfaces and creates a static channel group.

Example:

These commands assign Ethernet interfaces **1** and **2** to channel group **10** (creating the channel group if it does not already exist), enable LACP on those interfaces, and place the channel group in a negotiating state.

```
switch(config) #interface ethernet 1-2
switch(config-if-Et1-2) #channel-group 10 mode active
switch(config-if-Et1-2) #
```

Adding an Interface to a Channel Group

The `channel-group` command is also used to add the configuration mode interface to an existing channel group. When adding channels to a previously created channel group, the channel-group mode for the new channel must match the mode for the existing group.

Example:

These commands add Ethernet interfaces **7** through **10** to previously created channel group **10**, using the channel-group mode (**active**) under which it was created.

```
switch(config)#interface ethernet 7-10
switch(config-if-Et7-10)#channel-group 10 mode active
switch(config-if-Et7-10)#
```

Removing an Interface from a Channel Group

The **no channel-group** command removes the configuration mode interface from the specified channel group. Deleting all members of a channel group does not remove the associated port channel interface from *running-config*.

Example:

These commands removes *Ethernet interface 8* from previously created channel group **10**.

```
switch(config)#interface ethernet 8
switch(config-if-Et8)#no channel-group
switch(config-if-Et8)#
```

Configuring a Port-Channel as Mixed-Speed

By default, only configured members of the same speed become active. The [port-channel speed mixed](#) command configures a port channel with the ability to have active members of multiple speeds.



Note: Available on the 7020, 7280, 7500, and 7800 platforms. Minimum links is not available on mixed-speed port channels.

Example

```
switch(config)#interface port-channel 1
switch(config-if-Po1)#port-channel speed mixed
```

Configuring Minimum Links



Note: Minimum links is not available on Mixed-Speed Port-Channels. If a minimum requirement is desired for a Mixed-Speed Port-Channel, consider Minimum Speed instead. On Port-Channels that are not mixed-speed, if both Minimum Links and Minimum Speed are configured, then Minimum Speed will take precedence.

Configuring Minimum Speed

The [port-channel speed minimum](#) command specifies the cumulative minimum speed of all active members in order for a port channel to become active. If there is less than the specified by this command, the port channel interface does not become active.



Note: If both minimum speed and minimum links are configured, minimum speed will take precedence.

Example

These command sets 100 Gbps as the minimum speed needed for port channel 1 to become active.

```
switch(config)#interface port-channel 1
switch(config-if-Po1)#port-channel speed minimum 100 gbps
```

Deleting a Channel Group

A channel group is deleted by removing all Ethernet interfaces from the channel group. A channel group's LACP mode can be changed only by deleting the channel group and then creating an

equivalent group with a different LACP mode. Deleting a channel group by removing all Ethernet interfaces from the group preserves the port channel interface and its configuration settings.

View *running-config* to verify the deletion of all Ethernet interfaces from a channel group.

10.2.3.2 Configuring a Port Channel Interface

Creating a Port Channel Interface

The switch provides two methods for creating port channel interfaces:

- creating a channel group simultaneously creates an associated port channel.
- the `interface port-channel` command creates a port channel without assigning Ethernet channels to the new interface.

The `interface port-channel` command places the switch in *interface-port channel configuration mode*.

Example:

This command creates *port channel interface 8* and places the switch in *port channel interface configuration mode*.

```
switch(config)#interface port-channel 8
switch(config-if-Po8)#
```

Deleting a Port Channel Interface

The `no interface port-channel` command deletes the configuration mode port channel interface and removes the channel group assignment for each Ethernet interface assigned to the group associated with the port channel interface. Removing all Ethernet interfaces from a channel group does not remove the associated port channel interface from *running-config*.

10.2.3.3 Configuring Port Channel Subinterfaces

When configuring subinterfaces on a port channel interface (the virtual interface associated with a port channel), the following restrictions apply:

- An L3 interface with subinterfaces configured on it should not be made a member of a port channel.
 - An interface that is a member of a port channel should not have subinterfaces configured on it.
 - A subinterface cannot be made a member of a port channel.

Port channel subinterfaces are otherwise configured similarly to Ethernet subinterfaces. For additional information, see [Subinterfaces](#).

10.2.3.4 Configuring LACP

Configuring the Channel-group Mode

The channel-group mode is configured when a channel group is created using the `channel-group` command. A channel group's mode cannot be modified without deleting the entire channel group, but it can be modified without deleting the port channel interface associated with the channel group. The mode setting defines whether the port channel is static or dynamic, and whether a dynamic port channel is active or passive.

Examples

- These commands create a dynamic channel group and place it in LACP **active** mode.

```
switch(config)#interface ethernet 1-2
switch(config-if-Et1-2)#channel-group 10 mode active
switch(config-if-Et1-2)#
```

- These commands create a static channel group.

```
switch(config)#interface ethernet 4-5
switch(config-if-Et4-5)#channel-group 11 mode on
switch(config-if-Et4-5)#
```

Configuring the System Priority

Each switch is assigned a globally unique system identifier by concatenating the system priority (16 bits) to the MAC address of one of its physical ports (48 bits). The system identifier is used by peer devices when forming an aggregation to verify that all links are from the same switch. The system identifier is also used when dynamically changing aggregation capabilities in response to LACP information; the system with the numerically lower system identifier is permitted to dynamically change advertised aggregation capabilities.

The [lACP system-priority](#) command configures the switch's LACP system priority.

Example

This command assigns the system priority of **8192** to the switch.

```
switch(config)#lACP system-priority 8192
switch(config)#
```

Configuring Port Priority

LACP port priority determines the port that is active in a LAG in fallback mode. Numerically lower values have higher priority. Port priority is supported on port channels that are enabled with LACP physical interfaces.

The [lACP port-priority](#) command sets the aggregating port priority for the configuration mode interface.

Example

This command assigns the port priority of **4096** to **Ethernet interface 1**.

```
switch(config-if-Et1)#lACP port-priority 4096
switch(config-if-Et1)#
```

Configuring the LACP Packet Reception Rate

The [lACP timer](#) command sets the reception rate of LACP packets on the local device for the interface being configured. This command supports the following reception rates:

- **normal:** LACP packets are received at the following rates:
 - 30 seconds for synchronized interfaces.
 - One second for interfaces that are being synchronized.
- **fast:** LACP packets are received every second.

Example

This command sets the LACP reception rate to one second on the *Ethernet interface 4*.

```
switch(config-if-Et4)#lACP timer fast
switch(config-if-Et4)#
```

Configuring LACP Fallback

Fallback mode (static or individual) is configured on a port channel interface with the [port-channel lacp fallback](#) command. The fallback timeout interval is configured with the [port-channel lacp fallback timeout](#) command. Fallback timeout settings persist in *running-config* without taking effect for interfaces that are not configured into fallback mode. The default fallback timeout period is 90 seconds.

Examples

- These commands enable LACP static fallback mode, then configure an LACP fallback timeout of **100** seconds on *port channel interface 13*. If LACP negotiation fails, only the member port with the lowest LACP priority will remain active until an LACP PDU is received by one of the member ports.

```
switch(config)#interface port-channel 13
switch(config-if-Po13)#port-channel lacp fallback static
switch(config-if-Po13)#port-channel lacp fallback timeout 100
switch(config-if-Po13)#show active
interface Port-Channel13
    port-channel lacp fallback static
    port-channel lacp fallback timeout 100
switch(config-if-Po13)#
```

- These commands enable LACP individual fallback mode, then configure an LACP fallback timeout of **50** seconds on *port channel interface 17*. If LACP negotiation fails, all member ports will act as individual switch ports, using port-specific configuration, until a LACP PDU is received by one of the member ports.

```
switch(config)#interface port-channel 17
switch(config-if-Po17)#port-channel lacp fallback individual
switch(config-if-Po17)#port-channel lacp fallback timeout 50
switch(config-if-Po17)#show active
interface Port-Channel17
    port-channel lacp fallback individual
    port-channel lacp fallback timeout 50
switch(config-if-Po17)#
```

Configuring Minimum Links

The [port-channel min-links](#) command specifies the minimum number of interfaces that the configuration mode LAG requires to be active. If there are fewer ports than specified by this command, the port channel interface does not become active.



Note: In static LAGs, the min-links value must be met for the LAG to be active. The LAG will not become active until it has at least the min-links number of functioning links in the channel group. If failed links cause the number to drop below the minimum, the LAG will go down and administrator action will be required to bring it back up. In dynamic LAGs, the LACP protocol must determine that at least min-links physical ports are aggregable (they are physically compatible and have the same keys both remotely and locally) before it begins negotiating to make any ports active members of the port-channel. However once negotiation begins, an error on the partner's side or an error in programming of member interfaces can cause the LAG to become active with fewer than the minimum number of links. EOS evaluates min-links after min-links-review-timeout (linearly proportional to configured min-links) when LACP protocol collecting and/or distributing state changes. If the number of active member interfaces in a port-channel is less than configured min-links, it brings the corresponding port-channel Link Down and syslogs LAG-4-MINLINK_INTF_INSUFFICIENT message. If additional interfaces get programmed as collecting and distributing, EOS re-evaluates min-links on the port-channel. If sufficient number of interfaces are available to be a part of port-channel, then all interfaces of the corresponding port-channel are re-enabled for LACP negotiation and the port-channel becomes Link Up. LAG-4-MINLINK_INTF_NORMAL is syslogged after min-links-review-timeout if the min-links condition is satisfied; otherwise LAG-4-MINLINK_INTF_INSUFFICIENT is syslogged and the port-channel goes Link Down. If an interface remains in collecting state but not in distributing state for min-links-review-timeout, it is moved out of collecting state. It is periodically re-enabled after min-links-retry-timeout (which is 200 seconds) till it progresses to collecting and distributing. Meanwhile, if a port-channel becomes Link Up because sufficient number of interfaces progressed to collecting and distributing states, then this interface is enabled for LACP negotiation.

Example

This command sets four as the minimum number of ports required for **port channel 5** to become active.

```
switch(config-if-Po5)#port-channel min-links 4
switch(config-if-Po5)#
```

Configuring Minimum Links Review Interval

The `port-channel min-links review interval` command enables or disables timer based min-links review feature for all port-channels. The timer based min-links feature is enabled when all of the following conditions are true. It is disabled otherwise:

- The min-links configured is greater than 1.
- LACP fallback is disabled.
- The number of interfaces configured in the port-channel is more than min-links.
- The number of active member interfaces in the port-channel is less than min-links.
- The default timer values are:
 - min-links-review-timeout = min-links-timeout-base + f (configured min-links)
 - min-links-timeout-base = 180 seconds
 - min-links-retry-timeout = 360 seconds

10.2.3.5 Displaying Port Channel Information

Port channel information is accessed using some of the **show** commands listed under Interface Display Commands. Ensure that while using the `show interfaces counters rates` command to view the rate information of a port channel, rate values for the individual member ports are less inaccurate than rate values of the port channel.

Both the port channel rate and the individual port rates are calculated approximations; the rate value of a port channel might vary from the total of the rates for the member ports. The discrepancy is likely to be larger for port channels with fewer ports, and will be most obvious in single-port port channels.

10.2.4 Load Balancing Hash Algorithms

The switch balances packet load across multiple links in a port channel by calculating a hash value based on packet header fields. The hash value determines the active member link through which the packet is transmitted. This method, in addition to balancing the load in the LAG, ensures that all packets in a data stream follow the same network path.

In network topologies that include MLAGs or multiple paths with equal cost (ECMP), programming all switches to perform the same hash calculation increases the risk of hash polarization, which leads to uneven load distribution among LAG and MLAG member links. This uneven distribution is avoided by performing different hash calculations on each switch routing the paths.

The `port-channel load-balance` command specifies the seed for hashing algorithms that balance the load across ports comprising a port channel. Available seed values vary by switch platform.

Example

This command configures the hash seed of **10** on 7150 Series (FM6000 platform) switches.

```
switch(config)#port-channel load-balance fm6000 10
switch(config)#
```

Hashing algorithm inputs varies by switch platform. These sections describe hashing algorithm inputs for each platform.

- [Load Balance Hash Algorithms on 7048 and 7500 Series Switches](#)
- [Load Balance Hash Algorithms on 7500E Series Switches](#)
- [Load Balance Hash Algorithms on 7050 Series Switches](#)
- [Load Balance Hash Algorithms on 7150 Series Switches](#)

10.2.4.1 Load Balance Hash Algorithms on 7048 and 7500 Series Switches

One command configures the load balance hash algorithm on 7048 and 7500 Series switches:

- `port-channel load-balance petraA fields ip`: controls the hash algorithm for IP packets by specifying the algorithm's use of IP and MAC header fields. Fields that the command can specify include source and destination IP addresses, source and destination port fields (for TCP and UDP packets), and the entire MAC address header.

The hash algorithm for non-IP packets is not configurable and always includes the entire MAC header.

Example

These commands configure the load balance algorithm for IP packets by using the entire MAC header.

```
switch(config)#port-channel load-balance petraA fields ip mac-
header
switch(config)#
```

10.2.4.2 Load Balance Hash Algorithms on 7500E Series Switches

One command configures the load balance hash algorithm on 7500E Series switches:

- `port-channel load-balance arad fields ip`: controls the hash algorithm for IP packets by specifying the algorithm's use of IP and MAC header fields. Fields that the command can specify include source and destination IP addresses, source and destination port fields (for TCP and UDP packets), and the entire MAC address header.

The hash algorithm for non-IP packets is not configurable and always includes the entire MAC header.

Example

These commands configure the load balance algorithm for IP packets by using the entire MAC header.

```
switch(config)#port-channel load-balance arad fields ip mac-  
header  
switch(config)#
```

10.2.4.2.1 Dynamic and Symmetric LAG Hashing

Dynamic LAG hashing enables high link utilization and highly even distribution among LAG members by employing a randomized hashing algorithm. Symmetric LAG hashing allows the two flows of a bidirectional communication link, even when the two flows enter the switch on different ingress ports, to be hashed to the same member of a LAG on egress.

Dynamic and symmetric LAG hashing policies are enabled via named port-channel load-balancing profiles. LAG load-balancing policies can be provisioned on per line-card basis using these profiles. Load-balancing profiles can be used to provision all LAG load-balance attributes, including hash polynomials, hash seeds, and hash fields.

When no specific LAG hashing profile is assigned to a line card, then a global LAG hashing profile can be defined and applied to all the line cards with no LAG hashing defined on them.

Note, if no profile is selected as global profile then the default profile takes the precedence and set as a global profile. The default profile is reserved and if it is set as a global profile it cannot be deleted, if the profile is deleted then the following warning message is displayed.



Note: When a global profile is already set and if some other profile is tried to configured as a default profile the following warning message is displayed “! A global load balancing profile myProfile is currently active. This setting will not take effect.”

Examples

- These commands configure a load balance profile for symmetric hashing.

```
switch(config)#load-balance policies  
switch(config-load-balance-policies)#load-balance arad profile  
switch(config-sand-load-balance-profile-symmetric-p  
rofile-1)#hash symmetric  
switch(config-sand-load-balance-profile-symmetric-p  
rofile-1)#show active  
load-balance policies  
load-balance arad profile symmetric-profile-1  
hash symmetric
```

- These commands configure a load balance profile for dynamic hashing.

```
switch(config)#load-balance policies
switch(config-load-balance-policies)#load-balance arad profile
switch(config-sand-load-balance-profile-dynamic-hash-profile-1)#distribution
clock
switch(config-sand-load-balance-profile-dynamic-hash-profile-1)#show active
load-balance policies
    load-balance arad profile dynamic-hash-profile-1
    distribution clock
```

- This command assigns a named load-balancing profile to a linecard.

```
switch(config)#port-channel load-balance module 3-7 sand
profile Linecard5
switch(config)#
```

- This command unassigns a named load-balancing profile to a linecard.

```
switch(config)#no port-channel load-balance module 3-7 sand
profile Linecard5
switch(config)#
```

- This command configures a global profile on all line cards on which LAG hashing is not defined.

```
switch(config)#port-channel load-balance sand profile
myGlobalProfile
```

- These commands designates a default profile as a global profile, if no other profile is set as a global profile.

```
switch(config)#load-balance policies
switch(config-load-balance-policies)#load-balance sand profile
default
```

- These commands configure a hash seed in a profile and assigns it as a global profile.

```
switch(config)#load-balance policies
switch(config-load-balance-policies)#load-balance sand profile
myGlobalProfile
switch(config-sand-load-balance-profile-myGlobalProfile)#hash
seed 20
switch(config)#port-channel load-balance sand profile
myGlobalProfile
```

- This command assigns a named load-balancing profile to a linecard.

```
switch(config)#port-channel load-balance module 3-7 sand
profile Linecard5
switch(config)#
```

- This command unassigns a named load-balancing profile to a linecard.

```
switch(config)#no port-channel load-balance module 3-7 sand
profile Linecard5
switch(config)#
```

10.2.4.3 Load Balance Hash Algorithms on 7050 Series Switches

Three commands configure the load balance hash algorithm on 7050 Series switches:

- [port-channel load-balance trident fields ip](#) controls the hash algorithm for IP packets by specifying the algorithm's use of IP and MAC header fields. Fields that the command can specify include source and destination IP addresses, source and destination port fields (for TCP and UDP packets), and fields specified by the `port-channel load-balance trident fields mac` command.
- [port-channel load-balance trident fields ipv6](#) controls the hash algorithm for IPv6 packets by specifying the algorithm's use of IP and MAC header fields. Fields that the command can specify include source and destination IP addresses, source and destination port fields (for TCP and UDP packets), and fields specified by the `port-channel load-balance trident fields mac` command.
- [port-channel load-balance trident fields mac](#) controls the hash algorithm for non-IP packets by specifying the algorithm's use of MAC header fields. Fields that the command can specify include the MAC source address, MAC destination address, and Ethernet type fields.

Example

These commands configure the switch's port channel load balance for non IP packets by using the MAC destination and Ethernet type fields in the hashing algorithm.

```
switch(config)#port-channel load-balance trident fields mac dst-  
mac eth-type  
switch(config)#
```

10.2.4.4 Load Balance Hash Algorithms on 7150 Series Switches

Load balance profiles specify parameters used by hashing algorithms that distribute traffic across ports comprising a port channel or among component ECMP routes. The switch supports 16 load balance profiles, including the default profile. The default load balance profile is configured through [port-channel load-balance fm6000 fields ip](#) and [port-channel load-balance fm6000 fields mac](#) commands.

10.2.4.4.1 Load Balance Profiles

Load balance profiles are managed in ***load-balance-policies configuration mode***. ***load-balance-policies configuration mode*** provides commands that display the contents of all configured profiles and place the switch in `load-balance-profile` command. Load balance profiles are created by entering ***load-balance-profile mode*** and edited while in that mode.

The [load-balance policies](#) command places the switch in ***load-balance-policies configuration mode***. Load balance profiles specify the inputs used by the hashing algorithms that distribute traffic across ports comprising a port channel or among ECMP routes.

Examples

- This command places the switch in ***load-balance-policies configuration mode***.

```
switch(config)#load-balance policies  
switch(config-load-balance-policies)#
```

- This command displays the contents of the four load balance profiles configured on the switch.

```
switch(config-load-balance-policies)#show active
```



```

load-balance policies
  load-balance fm6000 profile F-01
  port-channel hash-seed 22
  fields ip dscp
  distribution random port-channel
!
load-balance fm6000 profile F-02
  fields ip protocol dst-ip
  distribution random port-channel
!
load-balance fm6000 profile F-03
  fields ip protocol dst-ip
  fields mac dst-mac eth-type
  distribution random ecmp port-channel
!
load-balance fm6000 profile F-04

switch(config-load-balance-policies)#

```

Creating a Load Balance Profile

The `load-balance fm6000 profile` command places the switch in load-balance-profile configuration mode to configure a specified load balance profile. The command specifies the name of the profile that subsequent commands modify. It creates a profile if the profile it references does not exist.

Example

These commands enter *load-balance-profile configuration mode*, creates the **LB-5** profile, and lists the default settings for the profile.

```

switch(config)#load-balance policies
switch(config-load-balance-policies)#load-balance fm6000 profile
LB-5
switch(config-load-balance-profile-LB-5)#show active all

load-balance policies
  load-balance fm6000 profile LB-5
  port-channel hash-seed 0
  fields mac dst-mac src-mac eth-type vlan-priority vlan-id
  fields ip protocol dst-ip dst-port src-ip src-port dscp
  no distribution symmetric-hash
  no distribution random

switch(config-load-balance-profile-LB-5)#

```

Configuring a Load Balance Profile

These commands are available in load-balance-profile configuration mode to specify the parameters that comprise a profile.

- The `fields ip` command specifies the L3/L4 data fields used by the hash algorithm defined by the configuration mode load balance profile.
- The `fields mac` command specifies the L2 data fields used by the hash algorithm defined by the configuration mode load balance profile.
- The `distribution symmetric-hash` command enforces traffic symmetry on data distributed by the hash algorithm defined by the configuration mode load balance profile. Symmetric traffic is the flow of both directions of a data stream across the same physical link.

- The `distribution random` command specifies the random distribution of data packets handled by the hash algorithm defined by the configuration mode load balance profile.

Example

These commands configure the following components of the hash algorithm defined by the LB-7 load balance profile:

- L2 header fields: MAC destination address, VLAN priority.
- L3/L4 header fields: Source IP address, protocol field.
- Symmetric hash distribution of IP and non-IP packets.

```
switch(config)#load-balance policies
switch(config-load-balance-policies)#load-balance fm6000
profile LB-7
switch(config-load-balance-profile-LB-7)#fields ip src-ip
protocol
switch(config-load-balance-profile-LB-7)#fields mac dst-mac
vlan-priority
switch(config-load-balance-profile-LB-7)#distribution
symmetric-hash mac-ip
switch(config-load-balance-profile-LB-7)#show active
load-balance policies
    load-balance fm6000 profile LB-7
        fields mac dst-mac vlan-priority
        fields ip protocol src-ip
        distribution symmetric-hash mac-ip
switch(config-load-balance-profile-LB-7)#exit
switch(config-load-balance-policies)#exit
switch(config)#exit
```

Assigning a Load Balance Profile to an Interface

The `ingress load-balance profile` command applies a specified load-balance profile to the configuration mode interface. Load balance profiles specify parameters used by hashing algorithms that distribute traffic across ports comprising a port channel or among ECMP routes. The switch supports 16 load balance profiles, including the default profile.

Example

This command applies the **LB-1** load balance profile to **port channel interface 100**.

```
switch(config)#interface port-channel 100
switch(config-if-Po100)#ingress load-balance profile LB-1
switch(config-if-Po100)#show active
interface Port-Channel100
    ingress load-balance profile LB-1
switch(config-if-Po100)#
```

10.2.4.4.2 Default Load Balance Profile

Two commands configure the load balance default profile on 7150 Series switches:

- `port-channel load-balance fm6000 fields ip` controls the hash algorithm for IP packets by specifying the algorithm's use of IP and MAC header fields. Fields that the command can specify include source and destination IP addresses, source and destination port fields (for TCP and UDP packets).

- `port-channel load-balance fm6000 fields mac` controls the hash algorithm for non-IP packets by specifying the algorithm's use of MAC header fields. Fields that the command can specify include the MAC source address, MAC destination address, and Ethernet type, VLAN-ID, and VLAN-priority fields.

Examples

- These commands configure the load balance default profile for IP packets by using source and destination IP address fields, along with source and destination port fields for TCP, and UDP packets.

```
switch(config)#port-channel load-balance fm6000 fields ip ip-  
tcp-udp-header  
switch(config)#
```

- This command applies the default load balance profile to *port channel interface 100*.

```
switch(config)#interface port-channel 100  
switch(config-if-Po100)#no ingress load-balance profile  
switch(config-if-Po100)#show active  
interface Port-Channel100  
switch(config-if-Po100)#
```

10.2.5 Port Channel and LACP Configuration Commands

Global Port Channel and LACP Configuration Commands

- `interface port-channel`
- `lacp system-priority`

Interface Configuration Commands – Ethernet Interface

- `channel-group`
- `lacp port-priority`
- `lacp timer`
- `port-channel lacp fallback`
- `port-channel lacp fallback timeout`
- `port-channel min-links`
- `port-channel min-links review interval`
- `port-channel speed minimum`
- `port-channel speed mixed`

Load Balance (Default) Commands

- `port-channel load-balance`
- `port-channel load-balance arad fields ip`
- `port-channel load-balance fm6000 fields ip`
- `port-channel load-balance fm6000 fields mac`
- `port-channel load-balance module`
- `port-channel load-balance petraA fields ip`
- `port-channel load-balance sand profile (7500E/7500R)`
- `port-channel load-balance trident fields ip`
- `port-channel load-balance trident fields ipv6`
- `port-channel load-balance trident fields mac`

Load Balance Policies Commands

- `distribution random`
- `distribution symmetric-hash`
- `fields ip`
- `fields mac`
- `hash-seed`
- `ingress load-balance profile`
- `load-balance fm6000 profile`
- `load-balance policies`
- `load-balance sand profile (7500E/7500R)`
- `port-channel hash-seed`

EXEC Commands

- `show lacp aggregates`
- `show lacp counters`
- `show lacp interface`
- `show lacp internal`
- `show lacp peer`

- `show lacp sys-id`
- `show load-balance profile`
- `show port-channel`
- `show port-channel dense`
- `show port-channel limits`
- `show port-channel load-balance`
- `show port-channel load-balance fields`

10.2.5.1 channel-group

The **channel-group** command assigns the configuration mode Ethernet interfaces to a channel group, creates the group if it does not already exist, and sets the port-channel mode for the group. When adding interfaces to a previously created channel group, the port-channel mode for the newly added interfaces must match the mode for the existing group.

Channel groups are associated with a port channel interface immediately upon their creation. A command that creates a new channel group also creates a port channel with a matching ID. The port channel is configured in Port-channel Configuration Mode. Configuration changes to a port channel interface propagate to all Ethernet interfaces in the corresponding channel group. The [interface port-channel](#) command places the switch in Interface-port-channel Configuration Mode.

The **no channel-group** and **default channel group** commands remove the configuration-mode interface from the specified channel group.

Command Mode

Interface-Ethernet Configuration

Command Syntax

```
channel-group number mode group_mode
```

```
no channel-group
```

```
default channel-group
```

Parameters

- **number** Specifies a channel group ID. Values range from 1 through 2000.
- **group_mode** Specifies the channel-group mode for the channel group. Values include:
 - **on** Port channel is static and LACP is disabled on member interfaces. Port neither verifies nor negotiates port channel membership.
 - **active** Port channel is dynamic and member interfaces are active LACP ports that transmit and receive LACP negotiation packets.
 - **passive** Port channel is dynamic and member interfaces are passive LACP ports that respond to LACP negotiation packets but do not generate them.

Guidelines: Port Channels

You can configure a port channel to contain many ports, but only a subset may be active at a time. All active ports in a port channel must be compatible. Compatibility includes many factors and is platform-specific. For example, compatibility may require identical operating parameters such as speed and maximum transmission unit (MTU). Compatibility may only be possible between specific ports because of the internal organization of the switch.

Guidelines: MLAG Configurations

Static LAG is not recommended in MLAG configurations. However, these considerations apply when the channel group mode is **on** while configuring static MLAG:

- When configuring multiple interfaces on the same static port channel:
 - all interfaces must physically connect to the same neighboring switch.
 - the neighboring switch must configure all interfaces into the same port channel.

The switches are misconfigured when these conditions are not met.

Disable the static port channel membership before moving any cables connected to these interfaces or changing a static port channel membership on the remote switch.

Examples

- These commands assign Ethernet interfaces 8 and 9 to channel group 10, and enable LACP in negotiating mode.

```
switch(config)#interface ethernet 8-9
switch(config-if-Et8-9)#channel-group 10 mode active
switch(config-if-Et8-9)#show active
interface Ethernet8
    channel-group 10 mode active
interface Ethernet9
    channel-group 10 mode active
switch(config-if-Et8-9)#
```

- These commands assign Ethernet interfaces 12 and 13 to static channel group 11. LACP is disabled on these interfaces.

```
switch(config)#interface ethernet 12-13
switch(config-if-Et12-13)#channel-group 11 mode on
switch(config-if-Et12-13)#show active
interface Ethernet12
    channel-group 11 mode on
interface Ethernet13
    channel-group 11 mode on
switch(config-if-Et12-13)#
```

10.2.5.2 distribution random

The **distribution random** command specifies the random distribution of data packets handled by the hash algorithm defined by the configuration mode load balance profile. All data fields and hash seeds that are configured for the profile are used as seeds for the random number generator that defines the distribution of individual packets.

Command options allow for the random distribution of traffic across port channel links and ECMP routes. Random distribution can be enabled for either, both, or neither.

The **no distribution random** and **default distribution random** commands remove random distribution on the configuration mode load balance profile by deleting the corresponding **distribution random** command from the configuration.

Command Mode

Load-balance-profile Configuration

Command Syntax

```
distribution random BALANCE_TYPE
```

```
no distribution random
```

```
default distribution random
```

Parameters

- **SCOPE** Specifies use of random distribution for port channels and ECMP routes. Options include:
 - **no parameter** Random distribution is enabled for ECMP routes and port channel links.
 - **ecmp** Random distribution is enabled for ECMP routes.
 - **port-channel** Random distribution is enabled for port channel links.
 - **ecmp port-channel** Random distribution is enabled for ECMP routes and port channel links.
 - **port-channel ecmp** Random distribution is enabled for ECMP routes and port channel links.

Guidelines

The **distribution random** command takes precedence over the [distribution symmetric-hash](#) command when both methods are simultaneously enabled.

Related Commands

- [load-balance fm6000 profile](#) places the switch in **load-balance-profile configuration mode**.

Example

These commands configure symmetric hashing on all traffic distributed through the algorithm defined by the **LB-1** load balance profile.

```
switch(config)#load-balance policies
switch(config-load-balance-policies)#load-balance fm6000 profile
LB-1
switch(config-load-balance-profile-LB-1)#distribution random ecmp
port-channel
switch(config-load-balance-profile-LB-1)#show active
load-balance policies
    load-balance fm6000 profile LB-1
        distribution random ecmp port-channel
switch(config-load-balance-profile-LB-1)#
```

10.2.5.3 distribution symmetric-hash

The `distribution symmetric-hash` command enforces traffic symmetry on data distributed by the hash algorithm defined by the configuration mode load balance profile. Symmetric traffic is the flow of both directions of a data stream across the same physical link.

Two symmetric-hash options specify the traffic upon which symmetry is enforced:

- `distribution symmetric-hash mac` specifies that only non-IP traffic is hashed symmetrically. IP traffic is hashed normally without regard to symmetry.
- `distribution symmetric-hash mac-ip` specifies that all traffic is hashed symmetrically.

The `no distribution symmetric-hash` and `default distribution symmetric-hash` commands remove the specified hashing symmetry restriction on the configuration mode load balance profile by deleting the corresponding `distribution symmetric-hash` command from *running-config*.

Command Mode

Load-balance-profile Configuration

Command Syntax

```
distribution symmetric-hash FIELD_TYPE
no distribution symmetric-hash
default distribution symmetric-hash
```

Parameters

- **FIELD_TYPE** Fields the hashing algorithm uses for Layer 3 routing. Options include:
 - **mac** Non-IP traffic is hashed symmetrically.
 - **mac-ip** All traffic is hashed symmetrically.

Guidelines

The `distribution random` command takes precedence over the `distribution symmetric-hash` command when both methods are simultaneously enabled.

Related Commands

- `load-balance fm6000 profile` places the switch in load-balance-profile configuration mode.

Example

These commands configure symmetric hashing on all traffic distributed through the algorithm defined by the **LB-1** load balance profile.

```
switch(config)#load-balance policies
switch(config-load-balance-policies)#load-balance fm6000 profile
  LB-1
switch(config-load-balance-profile-LB-1)#distribution symmetric-
hash mac-ip
switch(config-load-balance-profile-LB-1)#show active
load-balance policies
  load-balance fm6000 profile LB-1
    distribution symmetric-hash mac-ip
switch(config-load-balance-profile-LB-1)#
```

10.2.5.4 fields ip

The **fields ip** command specifies the L3/L4 data fields used by the hash algorithm defined by the configuration mode load balance profile. When a load balance profile is assigned to a port channel or Ethernet interface, its associated hash algorithm determines the distribution of packets that ingress the interface. Profile algorithms can load balance packets across port channel links or ECMP routes.

The switch calculates a hash value by using the packet header fields to balance packets across links. The hash value determines the link through which the packet is transmitted. This method also ensures that all packets in a flow follow the same network path. Packet flow is modified by changing the inputs to the port channel hash algorithm.

In network topologies that include MLAGs, programming all switches to perform the same hash calculation increases the risk of hash polarization, which leads to uneven load distribution among LAG and MLAG member links in MLAG switches. This problem is avoided by performing different hash calculations between the MLAG switch, and a non-peer switch connected to it.

The **no fields ip** configures the algorithm not to use L3/L4 data fields. The **default fields ip** command restores the default data L3/L4 fields to the load balancing algorithm defined by the configuration mode profile by removing the corresponding **fields ip** or **no fields ip** command from *running-config*.

Command Mode

Load-balance-profile Configuration

Command Syntax

```
fields ip IP_FIELD
```

```
no fields ip
```

```
default fields ip
```

Parameters

- **IP_FIELD** Specifies the L3/L4 fields the hashing algorithm uses. Options include:
 - **dscp** Algorithm uses dscp field.
 - **dst-ip** Algorithm uses destination IP address field.
 - **dst-port** Algorithm uses destination TCP/UDP port field.
 - **protocol** Algorithm uses protocol field.
 - **src-ip** Algorithm uses source IP address field.
 - **src-port** Algorithm uses source TCP/UDP port field.

Command may include from one to six fields, in any combination and listed in any order. The default setting is the selection of all fields.

Related Commands

- [load-balance fm6000 profile](#) places the switch in *load-balance-profile configuration mode*.

Example

These commands specify the IP source and protocol fields as components of the hash algorithm defined by the **LB-1** load balance profile.

```
switch(config)#load-balance policies
switch(config-load-balance-policies)#load-balance fm6000 profile
LB-1
switch(config-load-balance-profile-LB-1)#fields ip src-ip
protocol
switch(config-load-balance-profile-LB-1)#show active
load-balance policies
```

```
load-balance fm6000 profile LB-1
  fields ip protocol src-ip
switch(config-load-balance-profile-LB-1) #
```

10.2.5.5 fields mac

The **fields mac** command specifies the L2 data fields used by the hash algorithm defined by the configuration mode load balance profile. When a load balance profile is assigned to a port channel or Ethernet interface, its associated hash algorithm determines the distribution of packets that ingress the interface. Profile algorithms can load balance packets across port channel links or ECMP routes.

The switch calculates a hash value using the packet header fields to balance packets across links. The hash value determines the link through which the packet is transmitted. This method also ensures that all packets in a flow follow the same network path. Packet flow is modified by changing the inputs to the port channel hash algorithm.

In network topologies that include MLAGs, programming all switches to perform the same hash calculation increases the risk of hash polarization, which leads to uneven load distribution among LAG and MLAG member links in MLAG switches. This problem is avoided by performing different hash calculations between the MLAG switch, and a non-peer switch connected to it.

The **no fields mac** configures the algorithm not to use L2 data fields. The **default fields mac** command restores the default data L2 fields to the load balancing algorithm defined by the configuration mode profile by removing the corresponding **fields mac** or **no fields mac** command from *running-config*.

Command Mode

Load-balance-profile Configuration

Command Syntax

```
fields mac MAC_FIELD
```

```
no fields mac
```

```
default fields mac
```

Parameters

- **MAC_FIELD** Specifies the L2 fields the hashing algorithm uses. Options include:
 - **dst-mac** Algorithm uses MAC destination field.
 - **eth-type** Algorithm uses MAC destination field.
 - **src-mac** Algorithm uses MAC source field.
 - **vlan-id** Algorithm uses VLAN ID field.
 - **vlan-priority** Algorithm uses VLAN priority field.

Related Commands

[load-balance fm6000 profile](#) places the switch in load-balance-profile configuration mode.

Example

These commands specify the MAC destination and VLAN priority fields as components of the hash algorithm defined by the **LB-1** load balance profile.

```
switch(config)#load-balance policies
switch(config-load-balance-policies)#load-balance fm6000 profile
  LB-1
switch(config-load-balance-profile-LB-1)#fields mac dst-mac vlan-
priority
switch(config-load-balance-profile-LB-1)#show active
load-balance policies
  load-balance fm6000 profile LB-1
    fields mac dst-mac vlan-priority
```

```
switch(config-load-balance-profile-LB-1) #
```

10.2.5.6 hash-seed

The **hash-seed** command specifies the seed used by the hash algorithm defined by the configuration mode load balance profile. Profile algorithms can load balance packets across port channel links or ECMP routes.

The **no hash-seed** and **default hash-seed** commands restore the default hash seed value of 0 to the load balancing algorithm defined by the configuration mode profile by removing the corresponding **hash-seed** command from *running-config*.

Command Mode

Load-balance-profile Configuration

Command Syntax

hash-seed *number*

no hash-seed *number*

default hash-seed *number*

Parameters

- **number** Specifies the value of the hash seed. Value ranges from **0** to **39**.

Example:

These commands configure the **hash seed 20** in a profile and assign it as the global profile.

```
switch(config)#load-balance policies
switch(config-load-balance-policies)#load-balance sand profile
myGlobalProfile
switch(config-sand-load-balance-profile-myGlobalProfile)#hash-
seed 20
switch(config)#port-channel load-balance sand profile
myGlobalProfile
```

10.2.5.7 ingress load-balance profile

The **ingress load-balance profile** command applies the specified load-balance profile to the configuration mode interface. Load balance profiles specify parameters used by hashing algorithms that distribute traffic across ports comprising a port channel or among ECMP routes. The switch supports 16 load balance profiles, including the default profile.

Load balance profiles can be assigned to Ethernet and port channel interfaces. Profiles define the distribution method of traffic that ingresses the interface among the ports comprising a port channel or routes comprising an ECMP.

The default load balance profile is configured through [port-channel load-balance fm6000 fields ip](#) and [port-channel load-balance fm6000 fields mac](#) commands.

The **no ingress load-balance profile** and **default ingress load-balance profile** commands restore the default load balance profile for the configuration mode interface by removing the corresponding **ingress load-balance profile** command from **running-config**.

Command Mode

Interface-Ethernet Configuration

Interface-Port-Channel Configuration

Command Syntax

```
ingress load-balance profile profile_name
```

```
no ingress load-balance profile
```

```
default ingress load-balance profile
```

Parameters

- **profile_name** Name of profile assigned to interface.

Example

This command applies the **LB-1** load balance profile to port channel interface 100.

```
switch(config)#interface port-channel 100
switch(config-if-Po100)#show active
interface Port-Channel100

switch(config-if-Po100)#ingress load-balance profile LB-1
switch(config-if-Po100)#
interface Port-Channel100
    ingress load-balance profile LB-1

switch(config-if-Po100)#
```

10.2.5.8 interface port-channel

The **interface port-channel** command places the switch in port-channel interface configuration mode for modifying parameters of specified link aggregation (LAG) interfaces. When entering configuration mode to modify existing port channel interfaces, the command can specify multiple interfaces.

The command creates a port channel interface if the specified interface does not exist prior to issuing the command. When creating an interface, the command can only specify a single interface.

The **no interface port-channel** and **default interface port-channel** commands delete the specified LAG interfaces from *running-config*.

Command Mode

Global Configuration

Command Syntax

```
interface port-channel p_range
no interface port-channel p_range
default interface port-channel p_range
```

Parameter

- ***p_range*** Port channel interfaces (number, range, or comma-delimited list of numbers and ranges).

Port channel numbers range from **1** to **2000**.

Guidelines

When configuring a port channel, you do not need to issue the **interface port-channel** command before assigning a port to the port channel (see the [channel-group](#) command). The port channel number is implicitly created when a port is added to the specified port channel with the **channel-group number** command.

To display ports that are members of a port channel, enter [show port-channel](#). To view information about hardware limitations for a port channel, enter [show port-channel limits](#).

All active ports in a port channel must be compatible. Compatibility comprises many factors and is specific to a given platform. For example, compatibility may require identical operating parameters such as speed and/or maximum transmission unit (MTU). Compatibility may only be possible between specific ports because of internal organization of the switch.

You can configure a port channel with a set of ports such that more than one subset of the member ports are mutually compatible. Port channels in EOS are designed to activate the compatible subset of ports with the largest aggregate capacity. A subset with two 40 Gbps ports (aggregate capacity 80 Gbps) has preference to a subset with five active 10 Gbps ports (aggregate capacity 50 Gbps).

Example

This example creates **port channel interface 3**:

```
switch(config)#interface port-channel 3
switch(config-if-Po3)#
```

10.2.5.9 lacp port-priority

The **lacp port-priority** command sets the aggregating port priority for the configuration mode interface. Priority is supported on port channels with LACP-enabled physical interfaces. LACP port priority determines the port that is active in a LAG in fallback mode. Numerically lower values have higher priority.

Each port in an aggregation is assigned a 32-bit port identifier by prepending the port priority (16 bits) to the port number (16 bits). Port priority determines the ports that are placed in standby mode when hardware limitations prevent a single aggregation of all compatible ports.

Priority numbers range from **0** to **65535**. The default is **32768**. Interfaces with higher priority numbers are placed in standby mode before interfaces with lower priority numbers.

The **no lacp port-priority** and **default lacp port-priority** commands restore the default port-priority to the configuration mode interface by removing the corresponding **lacp port-priority** command from **running-config**.

Command Mode

Interface-Ethernet Configuration

Command Syntax

```
lacp port-priority priority_value
```

```
no lacp port-priority
```

```
default lacp port-priority
```

Parameters

- **priority_level** Port priority. Values range from **0** to **65535**. Default is **32768**

Example

These commands assign the port priority of **4096** to **Ethernet interface 8**.

```
switch(config)#interface ethernet 8
switch(config-if-Et8)#lacp port-priority 4096
switch(config-if-Et8)#show active
interface Ethernet8
    lacp port-priority 4096
switch(config-if-Et8)#
```

10.2.5.10 lacp system-priority

The **lacp system-priority** command configures the switch's LACP system priority. Values range between **0** and **65535**. Default value is **32768**.

Each switch is assigned a globally unique 64-bit system identifier by prepending the system priority (16 bits) to the MAC address of one of its physical ports (48 bits). Peer devices use the system identifier when forming an aggregation to verify that all links are from the same switch. The system identifier is also used when dynamically changing aggregation capabilities resulting from LACP data; the system with the numerically lower system identifier can dynamically change advertised aggregation parameters.

The **no lacp system-priority** and **default lacp system-priority** commands restore the default system priority by removing the **lacp system-priority** command from **running-config**.

Command Mode

Global Configuration

Command Syntax

```
lacp system-priority priority_value
```

```
no lacp system-priority
```

```
default lacp system-priority
```

Parameters

- **priority_value** System priority number. Values range from **0** to **65535**. Default is **32768**.

Example

This command assigns the system priority of **8192** to the switch.

```
switch(config)#lacp system-priority 8192  
switch(config)#
```

10.2.5.11 lacp timer

The `lacp timer` command configures the LACP reception interval on the configuration mode interface. The LACP timeout specifies the reception rate of LACP packets at interfaces supporting LACP. Supported rates include:

- **normal**: 30 seconds with synchronized interfaces; one second while interfaces are synchronizing.
- **fast**: one second.

This command is supported on LACP-enabled interfaces. The default value is **normal**.

The `no lacp timer` and `default lacp timer` commands restore the default value of **normal** on the configuration mode interface by deleting the corresponding `lacp timer` command from *running-config*.

Command Mode

Interface-Ethernet Configuration

Command Syntax

```
lacp timer RATE_LEVEL
```

```
no lacp timer
```

```
default lacp timer
```

Parameters

- **RATE_LEVEL** LACP reception interval. Options include:
 - **fast** One second.
 - **normal** 30 seconds for synchronized interfaces; one second while interfaces synchronize.

Example

This command sets the LACP timer to one second on *Ethernet interface 4*.

```
switch(config-if-Et4)#lacp timer fast  
switch(config-if-Et4)#
```

10.2.5.12 load-balance fm6000 profile

The `load-balance fm6000 profile` command places the switch in load-balance-profile configuration mode to configure a specified load balance profile. The command specifies the name of the profile that subsequent commands modify. It creates a profile if the profile it references does not exist.

Load balance profiles specify parameters used by hashing algorithms that distribute traffic across ports comprising a port channel or among component ECMP routes. The switch supports 16 load balance profiles, including the default profile. The default load balance profile is configured through `port-channel load-balance fm6000 fields ip` and `port-channel load-balance fm6000 fields mac` commands.

The load balance profile name is referenced when it is applied to an interface. The default profile is not associated with a name and is applied to an interface in the absence of a named profile assignment.

The `no load-balance fm6000 profile` and `default load-balance fm6000 profile` commands delete the specified load balance profile from *running-config*. Profiles that are assigned to an interface cannot be deleted. Attempts to delete an assigned profile generate a `profile in use` error messages.

The `load-balance fm6000 profile` command is accessible from *load-balance-policies configuration mode*. *Load-balance-profile configuration mode* is not a group change mode; *running-config* is changed immediately upon entering commands. Exiting *load-balance-policies configuration mode* does not affect the configuration. The `exit` command returns the switch to *load-balance-policies configuration mode*.

Command Mode

Load-balance-policies Configuration

Command Syntax

```
load-balance fm6000 profile profile_name
no load-balance fm6000 profile profile_name
default load-balance fm6000 profile profile_name
```

Parameters

- ***profile_name*** Name of the load-balance profile.

Commands Available in Load-balance-profile Configuration Mode

- `fields ip`
- `fields mac`
- `distribution random`
- `distribution symmetric-hash`
- `port-channel hash-seed`
- `show active` displays the contents of the configuration mode profile.

Related Commands

- `load-balance policies` places the switch in *load-balance-policies configuration mode*.
- `ingress load-balance profile` applies a load-balance profile to an Ethernet or port channel interface.
- `show load-balance profile` displays the contents of load balance profiles.

Example

These commands enter *load-balance-profile configuration mode*, creates the `LB-1` profile, and lists the default settings for the profile.

```
switch(config)#load-balance policies
```

```
switch(config-load-balance-policies)#load-balance fm6000 profile  
LB-1  
switch(config-load-balance-profile-LB-1)#show active all  
load-balance policies  
    load-balance fm6000 profile LB-1  
        port-channel hash-seed 0  
        fields mac dst-mac src-mac eth-type vlan-priority vlan-id  
        fields ip protocol dst-ip dst-port src-ip src-port dscp  
        no distribution symmetric-hash  
        no distribution random  
switch(config-load-balance-profile-LB-1)#
```

10.2.5.13 load-balance policies

The **load-balance policies** command places the switch in load-balance-policies configuration mode. Load-balance-policies configuration mode provides commands for managing load-balance profiles. Load balance profiles specify the inputs used by the hashing algorithms that distribute traffic across ports comprising a port channel or among ECMP routes.

The **no load-balance policies** and **default load-balance policies** commands delete all load balance profiles from **running-config**. The command generates an error message when at least one profile is assigned to an interface.

Load-balance-policies configuration mode is not a group change mode; **running-config** is changed immediately upon entering commands. Exiting **load-balance-policies configuration mode** does not affect **running-config**. The **exit** command returns the switch to global configuration mode.

Command Mode

Global Configuration

Command Syntax

```
load-balance policies
```

```
no load-balance policies
```

```
default load-balance policies
```

Commands Available in Load-balance-policies Configuration Mode

- [load-balance fm6000 profile](#) places the switch in **load-balance-profile configuration mode**.
- **show active** displays contents of all load balance profiles.

Related Commands

- [ingress load-balance profile](#) applies a load-balance profile to an Ethernet or port channel interface.
- [show load-balance profile](#) displays the contents of load balance profiles.

Examples

- This command places the switch in **load-balance-policies configuration mode**.

```
switch(config)#load-balance policies
switch(config-load-balance-policies)#
```

- This command displays the contents of the three configured load balance profiles.

```
switch(config-load-balance-policies)#show active

load-balance policies
  load-balance fm6000 profile F-01
    port-channel hash-seed 22
    fields ip dscp
    distribution random port-channel
  !
  load-balance fm6000 profile F-02
    fields ip protocol dst-ip
    fields mac dst-mac eth-type
    distribution random ecmp port-channel
  !
  load-balance fm6000 profile F-03

switch(config-load-balance-policies)#
```

10.2.5.14 load-balance sand profile (7500E/7500R)

The **load-balance sand profile** command configures a load-balance profile on a sand module switch. A default profile is designated as a global profile when no other profile is set as global profile. Note, a warning message is displayed when a profile is entered or deleted.

If **no load-balance sand profile** command is executed when the profile set is default then the following warning message is displayed:

```
! profile default is a reserved profile and cannot be deleted
```

Command Mode

Global Configuration

Command Syntax

```
load-balance sand profile profile_name
```

```
no load-balance sand profile profile_name
```

Parameter

profile_name Name of the profile assigned to the selected module.

Examples

- These commands designate a default profile as a global profile on sand module platform switch. Note, a warning message is displayed when a profile is entered or deleted.

```
switch(config)#load-balance policies
switch(config-load-balance-policies)#load-balance sand profile
default
! profile default is a reserved profile
! profile default is the current global profile
```

- When no form of the command is executed it displays the following warning message.

```
switch(config)#load-balance policies
switch(config-load-balance-policies)#no load-balance sand
profile default
! profile default is a reserved profile and cannot be deleted
```

10.2.5.15 port-channel hash-seed

The **port-channel hash-seed** command specifies the seed used by the hash algorithm defined by the configuration mode load balance profile when distributing the load across ports comprising a port channel. When a load balance profile is assigned to a port channel or Ethernet interface, its associated hash algorithm determines the distribution of packets that ingress the interface. Profile algorithms can load balance packets across port channel links or ECMP routes.

The hash seed that the algorithm uses to select port channel links or ECMP routes is configured by the [ip load-sharing](#) command.

The **no port-channel hash-seed** and **default port-channel hash-seed** commands restore the default hash seed value of **0** to the load balancing algorithm defined by the configuration mode profile by removing the corresponding **port-channel hash-seed** command from **running-config**.

Command Mode

Load-balance-profile Configuration

Command Syntax

```
port-channel hash-seed number
no port-channel hash-seed
default port-channel hash-seed
```

Parameters

- **number** The hash seed. Value ranges from **0** to **39**.

Related Commands

- [load-balance fm6000 profile](#) places the switch in load-balance-profile configuration mode.

Example

These commands configure the port-channel hash seed of **22** for the hash algorithm defined by the **LB-1** load balance profile.

```
switch(config)#load-balance policies
switch(config-load-balance-policies)#load-balance fm6000 profile
  LB-1
switch(config-load-balance-profile-LB-1)#port-channel hash-seed
  22
switch(config-load-balance-profile-LB-1)#show active
load-balance policies
  load-balance fm6000 profile LB-1
  port-channel hash-seed 22
switch(config-load-balance-profile-LB-1)#
```

10.2.5.16 port-channel lacp fallback timeout

The `port-channel lacp fallback timeout` command specifies the fallback timeout period for the configuration mode interface.

Fallback timeout settings persist in *running-config* without taking effect for interfaces that are not configured into fallback mode. The default fallback timeout period is **90** seconds.

The `no port-channel lacp fallback timeout` and `default port-channel lacp fallback timeout` commands restore the default fallback timeout of **90** seconds for the configuration mode interface by removing the corresponding `port-channel lacp fallback timeout` command from *running-config*.

Command Mode

Interface-Port-Channel Configuration

Command Syntax

```
port-channel lacp fallback timeout period
no port-channel lacp fallback timeout
default port-channel lacp fallback timeout
```

Parameters

- ***period*** Maximum interval between receipt of LACP PDU packets (seconds). Value ranges from **1** to **300** seconds. Default value is **90**.

Related Commands

[port-channel lacp fallback](#) configures fallback mode for a port channel interface.

Guidelines

The fallback timeout period should not be shorter than the LACP reception interval ([lacp timer](#)). The default LACP reception interval is **30** seconds.

Example

This command enables LACP fallback mode, then configures an LACP fallback timeout of **100** seconds on **port channel interface 13**.

```
switch(config)#interface port-channel 13
switch(config-if-Po13)#port-channel lacp fallback
switch(config-if-Po13)#port-channel lacp fallback timeout 100
switch(config-if-Po13)#show active
interface Port-Channel13
  port-channel lacp fallback
  port-channel lacp fallback timeout 100
switch(config-if-Po13)#
```

10.2.5.17 port-channel lacp fallback

The `port-channel lacp fallback` command enables the LACP fallback mode on the interface.

LACP fallback is unconfigured and disabled by default. An LACP interface without fallback enabled does not form a LAG until it receives PDUs from its peer.

LACP fallback can be configured on an interface in static or individual mode:

- **static mode** The port channel member with the lowest LACP port priority is active and maintains contact with the peer (sending and receiving data) while other port channel members remain in standby mode until a LACP PDU is received. All members continue to send (and can receive) LACP PDUs.
- **individual mode** All port channel members act as individual ports, reverting to their port-specific configuration while the channel is in fallback mode, and continue to send and receive data. All members continue to send LACP PDUs until a LACP PDU is received by one of the member ports.

The `no port-channel lacp fallback` and `default port-channel lacp fallback` commands disable LACP fallback mode on the configuration mode interface by removing the corresponding `port-channel lacp fallback` command from *running-config*.

Command Mode

Interface-Port-Channel Configuration

Command Syntax

```
port-channel lacp fallback [MODE]
no port-channel lacp fallback
default port-channel lacp fallback
```

Parameters

- **MODE** LACP fallback mode. Options include:
 - **no parameter** Enables static LACP fallback mode.
 - **static** Enables static LACP fallback mode.
 - **individual** Enables individual LACP fallback mode.

Related Commands

- [port-channel lacp fallback timeout](#) configures the fallback timeout period for a port channel interface. The default LACP fallback timeout period is **90** seconds.
- [lacp port-priority](#) configures the port priority for an individual interface.

Examples

- These commands enable LACP static fallback mode, then configure an LACP fallback timeout of 100 seconds on **port channel interface 13**. If LACP negotiation fails, only the member port with the lowest LACP priority will remain active until an LACP PDU is received by one of the member ports.

```
switch(config)#interface port-channel 13
switch(config-if-Po13)#port-channel lacp fallback static
switch(config-if-Po13)#port-channel lacp fallback timeout 100
switch(config-if-Po13)#show active
interface Port-Channel13
    port-channel lacp fallback static
    port-channel lacp fallback timeout 100
switch(config-if-Po13)#
```

- These commands enable LACP individual fallback mode, then configure an LACP fallback timeout of **50** seconds on **port channel interface 17**. If LACP negotiation fails, all member ports will act as individual switch ports, using port-specific configuration, until a LACP PDU is received by one of the member ports.

```
switch(config)#interface port-channel 17
switch(config-if-Po17)#port-channel lacp fallback individual
switch(config-if-Po17)#port-channel lacp fallback timeout 50
switch(config-if-Po17)#show active
interface Port-Channel17
    port-channel lacp fallback individual
    port-channel lacp fallback timeout 50
switch(config-if-Po17)#
```

10.2.5.18 port-channel load-balance arad fields ip

The `port-channel load-balance arad fields ip` command specifies the data fields that the port channel load balance hash algorithm uses for distributing IP packets on Arad platform switches. The hashing algorithm fields used for IP packets differ from the fields used for non-IP packets.

The switch calculates a hash value using the packet header fields to load balance packets across links in a port channel. The hash value determines the link through which the packet is transmitted. This method also ensures that all packets in a flow follow the same network path. Packet flow is modified by changing the inputs to the port channel hash algorithm.

In network topologies that include MLAGs, programming all switches to perform the same hash calculation increases the risk of hash polarization, which leads to uneven load distribution among LAG and MLAG member links in MLAG switches. This problem is avoided by performing different hash calculations between the MLAG switch, and a non-peer switch connected to it.

The `no port-channel load-balance arad fields ip` and `default port-channel load-balance arad fields ip` commands restore the default data fields for the IP packet load balancing algorithm by removing the `port-channel load-balance arad A fields ip` command from *running-config*.

Command Mode

Global Configuration

Command Syntax

```
port-channel load-balance arad fields ip IP_FIELD_NAME
```

```
no port-channel load-balance arad fields ip
```

```
default port-channel load-balance arad fields ip
```

Parameters

- **IP_FIELD_NAME** Fields the hashing algorithm uses for Layer 3 routing. Options include:
 - **ip-tcp-udp-header** Algorithm uses source and destination IP address fields. Source and destination port fields are included for TCP and UDP packets.
 - **mac-header** Algorithm uses entire MAC header.

A command can only specify one option. The default setting is **ip-tcp-udp-header**.

Guidelines

The port channel hash algorithm for non-IP packets is not configurable and always includes the entire MAC header.

Related Commands

- [port-channel load-balance](#) configures the hash seed for the algorithm.

Example

These commands configure the switch's port channel load balance hash algorithm for IP packets to use source and destination IP address (and port) fields.

```
switch(config)#port-channel load-balance fm6000 fields ip ip-tcp-  
udp-header  
switch(config)#
```

10.2.5.19 port-channel load-balance fm6000 fields ip

The **port-channel load-balance fm6000 fields ip** command specifies the data fields that the port channel load balance hash algorithm uses for distributing IP packets on FM6000 platform switches. The hashing algorithm fields used for IP packets differ from the fields used for non-IP packets.

The switch calculates a hash value using the packet header fields to load balance packets across links in a port channel. The hash value determines the link through which the packet is transmitted. This method also ensures that all packets in a flow follow the same network path. Packet flow is modified by changing the inputs to the port channel hash algorithm.

In network topologies that include MLAGs, programming all switches to perform the same hash calculation increases the risk of hash polarization, which leads to uneven load distribution among LAG and MLAG member links in MLAG switches. This problem is avoided by performing different hash calculations between the MLAG switch, and a non-peer switch connected to it.

The **no port-channel load-balance fm6000 fields ip** and **default port-channel load-balance fm6000 fields ip** commands restore the default data fields for the IP packet load balancing algorithm by removing the **port-channel load-balance fm6000 fields ip** command from *running-config*.

Command Mode

Global Configuration

Command Syntax

```
port-channel load-balance fm6000 fields ip IP_FIELD_NAME
```

```
no port-channel load-balance fm6000 fields ip
```

```
default port-channel load-balance fm6000 fields ip
```

Parameters

- **IP_FIELD_NAME** Specifies fields the hashing algorithm uses for layer 3 routing. Options include:
 - **ip-tcp-udp-header** Algorithm uses source and destination IP address fields. Source and destination port fields are included for TCP and UDP packets.

A command can only specify one option. The default setting is **ip-tcp-udp-header**.

Related Commands

- [port-channel load-balance](#) configures the hash seed for the algorithm.
- [port-channel load-balance fm6000 fields mac](#) controls the hash algorithm for non-IP packets.

Example

These commands configure the switch's port channel load balance for IP packets by source and destination IP address and port fields.

```
switch(config)#port-channel load-balance fm6000 fields ip ip-tcp-
udp-header
switch(config)#
```

10.2.5.20 port-channel load-balance fm6000 fields mac

The `port-channel load-balance fm6000 fields mac` command specifies data fields that configure the port channel load balance hash algorithm for non-IP packets on FM6000 platform switches. The hashing algorithm fields used for balancing non-IP packets differ from the fields used for IP packets.

The switch calculates a hash value using the packet header fields to load balance packets across links in a port channel. The hash value determines the link through which the packet is transmitted. This method also ensures that all packets in a flow follow the same network path. Packet flow is modified by changing the inputs to the port channel hash algorithm.

In network topologies that include MLAGs, programming all switches to perform the same hash calculation increases the risk of hash polarization, which leads to uneven load distribution among LAG and MLAG member links in MLAG switches. This problem is avoided by performing different hash calculations between the MLAG switch, and a non-peer switch connected to it.

The `no port-channel load-balance fm6000 fields mac` and `default port-channel load-balance fm6000 fields mac` commands restore the default data fields for the non-IP packet load balancing algorithm by removing the `port-channel load-balance fm6000 fields mac` command from *running-config*.

Command Mode

Global Configuration

Command Syntax

```
port-channel load-balance fm6000 fields mac MAC_FIELD_NAME
```

```
no port-channel load-balance fm6000 fields mac
```

```
default port-channel load-balance fm6000 fields mac
```

Parameters

- **MAC_FIELD_NAME** Fields the hashing algorithm uses for Layer 2 routing. Options include:
 - **dst-mac** MAC destination field.
 - **eth-type** EtherType field.
 - **src-mac** MAC source field.
 - **vlan-id** VLAN ID field.
 - **vlan-priority** VLAN priority field.

Command may include from one to five fields, in any combination and listed in any order. The default setting is the selection of all fields.

Related Commands

- [port-channel load-balance](#) configures the hash seed for the algorithm.
- [port-channel load-balance fm6000 fields ip](#) controls the hash algorithm for IP packets.

Example

These commands configure the switch's port channel load balance for non-IP packets by using the MAC destination and Ethernet type fields in the hashing algorithm.

```
switch(config)#port-channel load-balance fm6000 fields mac dst-  
mac eth-type  
switch(config)#
```

10.2.5.21 port-channel load-balance module

The `port-channel load-balance module` command assigns a named load-balancing profile to a linecard.



Note: Available on the 7500E platform.

The `no port-channel load-balance module` and `default port-channel load-balance module` commands unassigns the load balancing module, or restores the default data fields for the load balancing module.

Command Mode

Global Configuration

Command Syntax

```
port-channel load-balance module LINECARD_RANGE sand profile PROFILE_NAME
```

```
no port-channel load-balance module LINECARD_RANGE sand profile PROFILE_NAME
```

```
default port-channel load-balance module LINECARD_RANGE sand profile  
PROFILE_NAME
```

Parameters

- **LINECARD_RANGE** Linecard number range includes:
 - **3-10** Linecard number range.
- **PROFILE_NAME** Load-balance profile name.

Examples

- This command assigns a named load-balancing profile to a linecard.

```
switch(config)#port-channel load-balance module 3-7 sand  
profile Linecard5  
switch(config)#
```

- This command unassigns a named load-balancing profile to a linecard.

```
switch(config)#no port-channel load-balance module 3-7 sand  
profile Linecard5  
switch(config)#
```

10.2.5.22 port-channel load-balance petraA fields ip

The `port-channel load-balance petraA fields ip` command specifies the data fields that the port channel load balance hash algorithm uses for distributing IP packets on Petra platform switches. The hashing algorithm fields used for IP packets differ from the fields used for non-IP packets.

The switch calculates a hash value using the packet header fields to load balance packets across links in a port channel. The hash value determines the link through which the packet is transmitted. This method also ensures that all packets in a flow follow the same network path. Packet flow is modified by changing the inputs to the port channel hash algorithm.

In network topologies that include MLAGs, programming all switches to perform the same hash calculation increases the risk of hash polarization, which leads to uneven load distribution among LAG and MLAG member links in MLAG switches. This problem is avoided by performing different hash calculations between the MLAG switch, and a non-peer switch connected to it.

The `no port-channel load-balance petraA fields ip` and `default port-channel load-balance petraA fields ip` commands restore the default data fields for the IP packet load balancing algorithm by removing the `port-channel load-balance petraA fields ip` command from *running-config*.

Command Mode

Global Configuration

Command Syntax

```
port-channel load-balance petraA fields ip IP_FIELD_NAME
```

```
no port-channel load-balance petraA fields ip
```

```
default port-channel load-balance petraA fields ip
```

Parameters

- **IP_FIELD_NAME** Fields the hashing algorithm uses for Layer 3 routing. Options include:
 - **ip-tcp-udp-header** Algorithm uses source and destination IP address fields. Source and destination port fields are included for TCP and UDP packets.
 - **mac-header** Algorithm uses entire MAC header.

A command can only specify one option. The default setting is **ip-tcp-udp-header**.

Guidelines

The port channel hash algorithm for non-IP packets is not configurable and always includes the entire MAC header.

Related Commands

- [port-channel load-balance](#) configures the hash seed for the algorithm.

Example

These commands configure the switch's port channel load balance hash algorithm for IP packets to use source and destination IP address (and port) fields.

```
switch(config)#port-channel load-balance fm6000 fields ip ip-tcp-  
udp-header  
switch(config)#
```

10.2.5.23 port-channel load-balance sand profile (7500E/7500R)

The **port-channel load-balance sand profile** command configures a global LAG hashing profile on the port channel interface. A default profile is set as a global profile when no other profile is set as global.

The **no port-channel load-balance sand profile** command removes the active profile from the **port-channel load-balance** command from **running-config**, restoring the default profile.

Command Mode

Global Configuration

Command Syntax

```
port-channel load-balance sand profile profile_name
```

```
no port-channel load-balance sand profile profile_name
```

Parameter

profile_name Name of the profile assigned to the selected module.

Example

This command configures a global LAG hashing profile on 7500 series platform switch.

```
switch(config)#port-channel load-balance sand profile  
myGlobalProfile  
switch(config)#
```

10.2.5.24 port-channel load-balance trident fields ip

The `port-channel load-balance trident fields ip` command specifies the data fields that the port channel load balance hash algorithm uses for distributing IP packets on Trident platform switches. The hashing algorithm fields used for IP packets differ from the fields used for non-IP packets.

The switch calculates a hash value using the packet header fields to load balance packets across links in a port channel. The hash value determines the link through which the packet is transmitted. This method also ensures that all packets in a flow follow the same network path. Packet flow is modified by changing the inputs to the port channel hash algorithm.

In network topologies that include MLAGs, programming all switches to perform the same hash calculation increases the risk of hash polarization, which leads to uneven load distribution among LAG and MLAG member links in MLAG switches. This problem is avoided by performing different hash calculations between the MLAG switch, and a non-peer switch connected to it.

The `no port-channel load-balance trident fields ip` and `default port-channel load-balance trident fields ip` commands restore the default data fields for the IP packet load balancing algorithm by removing the `port-channel load-balance trident fields ip` command from *running-config*.

Command Mode

Global Configuration

Command Syntax

```
port-channel load-balance trident fields ip IP_FIELD_NAME
no port-channel load-balance trident fields ip
default port-channel load-balance trident fields ip
default port-channel load-balance trident fields ip ingress-interface disabled
```

Parameters

- **IP_FIELD_NAME** Specifies fields the hashing algorithm uses for Layer 3 routing. Options include:
- Command may include from one to four of the following four options, in any combination and listed in any order.
 - **destination-ip** Algorithm uses destination IP address field.
 - **source-ip** Algorithm uses source IP address field.
 - **destination-port** Algorithm uses destination TCP/UDP port field.
 - **source-port** Algorithm uses source TCP/UDP port field.
 - **ip-tcp-udp-header** Algorithm uses source and destination IP address fields. Source and destination port fields are included for TCP and UDP packets.
 - 📄 **Note:** This option can't be used in combination with any other option.
 - **mac-header** Algorithm uses fields specified by [port-channel load-balance trident fields mac](#).
 - 📄 **Note:** This option can't be used in combination with any other option.
 - **ingress-interface** Disable from LAG hashing.

Default setting is **ip-tcp-udp-header**

Related Commands

- [port-channel load-balance](#) configures the hash seed for the algorithm.
- [port-channel load-balance trident fields ipv6](#) controls the hash algorithm for IPv6 packets.
- [port-channel load-balance trident fields mac](#) controls the hash algorithm for non-IP/IPv6 packets.

Example

These commands configure the switch's port channel load balance for IP packets by using the IPv6 destination field in the hashing algorithm.

```
switch(config)#port-channel load-balance trident fields ip  
destination-ip  
switch(config)#
```

This command disables the ingress interface for IPv4 traffic.

```
switch(config)#port-channel load-balance trident fields ip  
ingress-interface disabled  
switch(config)#
```

10.2.5.25 port-channel load-balance trident fields ipv6

The `port-channel load-balance trident fields ipv6` command specifies the data fields that the port channel load balance hash algorithm uses for distributing IPv6 packets on Trident platform switches. The hashing algorithm fields used for IPv6 packets differ from the fields used for non-IPv6 packets.

The switch calculates a hash value using the packet header fields to load balance packets across links in a port channel. The hash value determines the link through which the packet is transmitted. This method also ensures that all packets in a flow follow the same network path. Packet flow is modified by changing the inputs to the port channel hash algorithm.

In network topologies that include MLAGs, programming all switches to perform the same hash calculation increases the risk of hash polarization, which leads to uneven load distribution among LAG and MLAG member links in MLAG switches. This problem is avoided by performing different hash calculations between the MLAG switch, and a non-peer switch connected to it.

The `no port-channel load-balance trident fields ipv6` and `default port-channel load-balance trident fields ipv6` commands restore the default data fields for the IPv6 packet load balancing algorithm by removing the `port-channel load-balance trident fields ipv6` command from *running-config*.

Command Mode

Global Configuration

Command Syntax

```
port-channel load-balance trident fields ipv6 IP_FIELD_NAME
```

```
no port-channel load-balance trident fields ipv6
```

```
default port-channel load-balance trident fields ipv6
```

```
default port-channel load-balance trident fields ipv6 ingress-interface disabled
```

Parameters

- **IP_FIELD_NAME** Specifies fields the hashing algorithm uses for Layer 3 routing. Options include:
Command may include from one to four of the following four options, in any combination and listed in any order.
 - **destination-ip** Algorithm uses destination IPv6 address field.
 - **source-ip** Algorithm uses source IPv6 address field.
 - **destination-port** Algorithm uses destination TCP/UDP port field.
 - **source-port** Algorithm uses source TCP/UDP port field.
 - **ip-tcp-udp-header** Algorithm uses source and destination IPv6 address fields. Source and destination port fields are included for TCP and UDP packets.
 - 📌 **Note:** This option can't be used in combination with any other option.
 - **mac-header** Algorithm uses fields specified by [port-channel load-balance trident fields mac](#).
 - 📌 **Note:** This option can't be used in combination with any other option.
 - **ingress-interface** Disable from LAG hashing.

Default setting is **ip-tcp-udp-header**

Related Commands

- [port-channel load-balance](#) configures the hash seed for the algorithm.
- [port-channel load-balance trident fields ipv6](#) controls the hash algorithm for non-IP packets.
- [port-channel load-balance trident fields mac](#) controls the hash algorithm for non-IP packets.

Example

These commands configure the switch's port channel load balance for IP packets by using the IPv6 source field in the hashing algorithm.

```
switch(config)#port-channel load-balance trident fields ipv6  
source-ip  
switch(config)#
```

This command disables the ingress interface for IPv6 traffic.

```
switch(config)#port-channel load-balance trident fields ipv6  
ingress-interface disabled  
switch(config)#
```

10.2.5.26 port-channel load-balance trident fields mac

The `port-channel load-balance trident fields mac` command specifies data fields that the port channel load balance hash algorithm uses for distributing non-IP packets on Trident platform switches. The hashing algorithm fields used for non-IP packets differ from the fields used for IP packets.

The switch calculates a hash value using the packet header fields to load balance packets across links in a port channel. The hash value determines the link through which the packet is transmitted. This method also ensures that all packets in a flow follow the same network path. Packet flow is modified by changing the inputs to the port channel hash algorithm.

In network topologies that include MLAGs, programming all switches to perform the same hash calculation increases the risk of hash polarization, which leads to uneven load distribution among LAG and MLAG member links in MLAG switches. This problem is avoided by performing different hash calculations between the MLAG switch, and a non-peer switch connected to it.

The `no port-channel load-balance trident fields mac` and `default port-channel load-balance trident fields mac` commands restore the default data fields for the non-IP packet load balancing algorithm by removing the `port-channel load-balance trident fields mac` command from *running-config*.

Command Mode

Global Configuration

Command Syntax

```
port-channel load-balance trident fields mac MAC_FIELD_NAME
no port-channel load-balance trident fields mac
default port-channel load-balance trident fields mac
default port-channel load-balance trident fields mac ingress-interface disabled
```

Parameters

- **MAC_FIELD_NAME** Fields the hashing algorithm uses for Layer 2 routing. Options include:
 - **dst-mac** MAC destination field.
 - **eth-type** EtherType field.
 - **src-mac** MAC source field.
 - **ingress-interface** Disable from LAG hashing.

Command may include from one to three fields, in any combination and listed in any order. The default setting is the selection of all fields.

Related Commands

- [port-channel load-balance](#) configures the hash seed for the algorithm.
- [port-channel load-balance trident fields ip](#) controls the hash algorithm for IP packets.
- [port-channel load-balance trident fields ipv6](#) controls the hash algorithm for IP packets.

Example

These commands configure the switch's port channel load balance for non-IP packets by using the MAC destination and Ethernet type fields in the hashing algorithm.

```
switch(config)#port-channel load-balance trident fields mac dst-
mac eth-type
switch(config)#
```

This command disables the ingress interface for IPv4 traffic.

```
switch(config)#port-channel load-balance trident fields mac  
ingress-interface disabled  
switch(config)#
```

10.2.5.27 port-channel load-balance

The `port-channel load-balance` command specifies the seed in the hashing algorithm that balances the load across ports comprising a port channel. Available seed values vary by switch platform.

The `no port-channel load-balance` and `default port-channel load-balance` commands remove the `port-channel load-balance` command from *running-config*, restoring the default hash seed value of `0`.

Command Mode

Global Configuration

Command Syntax

```
port-channel load-balance platform {hash_seed | fields ip fields | hash hash_function }
```

```
no port-channel load-balance platform [hash_seed]
```

```
default port-channel load-balance platform [hash_seed]
```

Parameters

 **Note:** Parameter options vary by switch model. Verify available options with the ? command.

- ***platform*** ASIC switching device. Value depends on the switch model.
- ***hash_seed*** The numerical seed for the hash function. Value range varies by switch platform:
 - **arad** `0` to **65535**.
 - **fm6000** `0` to **39**.
 - **petraA** Uses field inputs only.
 - **trident** `0` to **47**.

For trident platform switches, algorithms using hash seeds between `0` and `15` typically result in more effective distribution of data streams across the port channels.

- **fields** Which fields will be used as inputs to the port channel hash.
 - **gre** Configure which GRE fields are inputs to the hash.
 - **ip** Configure which fields are inputs to the hash for IPv4 packets.
 - **ipv6** Configure which fields are inputs to the hash for IPv6 packets.
 - **mac** Configure which MAC fields are inputs to the hash.
 - **mac-in-mac** Configure which MAC-in-MAC fields are inputs to the hash.
 - **mpls** Configure which MPLS fields are inputs to the hash.
 - **destination-ip** Use the Layer 3 IP destination address in the hash.
 - **destination-port** Use the Layer 4 TCP/UDP destination port in the hash.
 - **dst-ip** Use the destination IP address in the hash.
 - **dst-mac** Use the destination Payload MAC in the hash (or the destination MAC address in the MAC hash).
 - **eth-type** Use the Ethernet type in the MAC hash.
 - **ip-in-ip** Use the outer IP header in the hash for IPv4 over IPv4 GRE tunnel.
 - **ip-in-ipv6** Use the outer IP header in the hash for IPv4 over IPv6 GRE tunnel.
 - **ipv6-in-ip** Use the outer IP header in the hash for IPv6 over IPv4 GRE tunnel.
 - **ipv6-in-ipv6** Use the outer IP header in the hash for IPv6 over IPv6 GRE tunnel.
 - **ip-tcp-udp-header** Use the Layer 3 and Layer 4 hashes.
 - **isid** Use the MAC-in-MAC ISID in the hash.
 - **label** Use the MPLS label in the hash.
 - **mac-header** Use the MAC hash.
 - **outer-mac** Use the outer MAC of source and destination in the hash.
 - **source-ip** Use the Layer 3 IP source address in the hash.
 - **src-ip** Use the source IP address in the hash.
 - **source-port** Use the Layer 4 TCP/UDP source port in the hash.
 - **src-mac** Use the source payload MAC in the hash (or the source MAC address in the MAC hash).
- **hash_function** Specifies the hash polynomial function. Values range from **0-2**.

Example

This command configures a hash seed of **10** on an FM6000 platform switch.

```
switch(config)#port-channel load-balance fm6000 10
switch(config)#
```

10.2.5.28 port-channel min-links review interval

The `port-channel min-links review interval` command enables or disables timer based min-links review feature for all port-channels.

The `no port-channel min-links review interval` and `default port-channel min-links review interval` commands restore the default min-links-timeout-base to 180 seconds by removing the corresponding `port-channel min-links review interval` command from *running-config*.

Command Mode

Global Configuration

Command Syntax

```
port-channel min-links review interval timeout(seconds)
```

```
no port-channel min-links review interval
```

```
default port-channel min-links review interval
```

Guidelines

The min-links-timeout-base interval for port-channels can be set within the range of **0** to **600** seconds. When setting the review interval to zero, the command has the following effect:

- Disables the timer-based min-links review feature for all port-channels.
 - For LACP port-channels, it prevents the port-channel from bringing link up (even after one or more member ports were negotiated to collect or distribute (rx or tx)) until there are sufficient member interfaces ready to join the port-channel. Meanwhile, the partner can enable the port-channel link with fewer than required member interfaces. This configuration does not impact port-channels without min-links configuration.

Related Commands

- [port-channel min-links](#)

Example

This command sets the port-channel min-links interval to **200** seconds.

```
switch(config)#port-channel min-links review interval 200
```

10.2.5.29 port-channel min-links

The `port-channel min-links` command specifies the minimum number of interfaces that the configuration mode LAG requires to become active. If there are fewer ports than specified by this command, the port channel interface does not become active. The default min-links value is `0`.

The `no port-channel min-links` and `default port-channel min-links` commands restore the default min-links setting for the configuration mode LAG by removing the corresponding `port-channel min-links` command from the configuration.



Note: In static LAGs, the min-links value must be met for the LAG to be active. The LAG will not become active until it has at least the min-links number of functioning links in the channel group. If failed links cause the number to drop below the minimum, the LAG will go down and administrator action will be required to bring it back up. In dynamic LAGs, the LACP protocol must determine that at least min-links physical ports are aggregable (they are physically compatible and have the same keys both remotely and locally) before it begins negotiating to make any ports active members of the port-channel. However once negotiation begins, an error on the partner's side or an error in programming of member interfaces can cause the LAG to become active with fewer than the minimum number of links. EOS evaluates min-links after min-links-review-timeout (linearly proportional to configured min-links) when LACP protocol collecting and/or distributing state changes. If the number of active member interfaces in a port-channel is less than configured min-links, it brings the corresponding port-channel Link Down and syslogs LAG-4-MINLINK_INTF_INSUFFICIENT message. If additional interfaces get programmed as collecting and distributing, EOS re-evaluates min-links on the port-channel. If sufficient number of interfaces are available to be a part of port-channel, then all interfaces of the corresponding port-channel are re-enabled for LACP negotiation and the port-channel becomes Link Up. LAG-4-MINLINK_INTF_NORMAL is syslogged after min-links-review-timeout if the min-links condition is satisfied; otherwise LAG-4-MINLINK_INTF_INSUFFICIENT is syslogged and the port-channel goes Link Down. If an interface remains in collecting state but not in distributing state for min-links-review-timeout, it is moved out of collecting state. It is periodically re-enabled after min-links-retry-timeout (which is 200 seconds) till it progresses to collecting and distributing. Meanwhile, if a port-channel becomes Link Up because sufficient number of interfaces progressed to collecting and distributing states, then this interface is enabled for LACP negotiation.

Command Mode

Interface-Port-Channel Configuration

Command Syntax

```
port-channel min-links quantity
no port-channel min-links
default port-channel min-links
```

Parameters

- ***quantity*** Minimum number of interfaces. Value range varies by platform. Default value is `0`.

Example

These commands set `4` as the minimum number of ports required for **port channel 13** to become active.

```
switch(config)#interface port-channel 13
switch(config-if-Po13)#port-channel min-links 4
switch(config-if-Po13)#show active
interface Port-Channel13
    port-channel min-links 4
```

```
switch(config-if-Po13) #
```

10.2.5.30 port-channel speed mixed

The **port-channel speed mixed** command configures a port channel with the ability to have active members of multiple speeds.

 **Note:** Available on the 7020, 7280, 7500, and 7800 platforms. Minimum links is not available on mixed-speed port channels.

Command Mode

Interface-Port-Channel Configuration

Command Syntax

```
port-channel speed mixed
```

Related Commands

- [interface port-channel](#) places the switch in interface-port-channel configuration mode.

Example

These commands places the switch in the interface port-channel mode and configures the mixed speed port-channel.

```
switch(config)#interface port-channel 1  
switch(config-if-Po1)#port-channel speed mixed
```

10.2.5.31 port-channel speed minimum

The **port-channel speed minimum** command specifies the cumulative minimum speed of all active members in order for a port channel to become active. If there is less than the specified by this command, the port channel interface does not become active.



Note: If both minimum speed and minimum links are configured, minimum speed will take precedence.

Command Mode

Interface-Port-Channel Configuration

Command Syntax

```
port-channel speed minimum speed-value
```

Parameter

speed-value Minimum speed value. The value ranges from 1 to 65535.

Related Commands

- [interface port-channel](#) places the switch in interface-port-channel configuration mode.

Example

These command sets 100 Gbps as the minimum speed needed for port channel 1 to become active.

```
switch(config)#interface port-channel 1
switch(config-if-Po1)#port-channel speed minimum 100 gbps
```

10.2.5.32 show lacp aggregates

The **show lacp aggregates** command displays aggregate IDs and the list of bundled ports for all specified port channels.

Command Mode

EXEC

Command Syntax

```
show lacp [PORT_LIST] aggregates [PORT_LEVEL] [INFO_LEVEL]
```

 **Note:** **PORT_LEVEL** and **INFO_LEVEL** parameters can be placed in any order.

Parameters

- **PORT_LIST** Port channels for which aggregate information is displayed. Options include:
 - **<no parameter>** All configured port channels.
 - **c_range** Channel list (number, range, or comma-delimited list of numbers and ranges).
- **PORT_LEVEL** Ports displayed, in terms of aggregation status. Options include:
 - **no parameter** Ports bundled by LACP into the port channel.
 - **all-ports** All channel group ports, including channel group members not bundled into the port channel interface.
- **INFO_LEVEL** Amount of information that is displayed. Options include:
 - **no parameter** Aggregate ID and bundled ports for each channel.
 - **brief** Aggregate ID and bundled ports for each channel.
 - **detailed** Aggregate ID and bundled ports for each channel.

Example

This command lists aggregate information for all configured port channels.

```
switch>show lacp aggregates

Port Channel Port-Channel1:
Aggregate ID:
[(8000,00-1c-73-04-36-d7,0001,0000,0000), (8000,00-1c-73-09-a0-f3,0001,0000,0000)]
Bundled Ports: Ethernet43 Ethernet44 Ethernet45 Ethernet46
Port Channel Port-Channel2:
Aggregate ID:
[(8000,00-1c-73-01-02-1e,0002,0000,0000), (8000,00-1c-73-04-36-d7,0002,0000,0000)]
Bundled Ports: Ethernet47 Ethernet48
Port Channel Port-Channel3:
Aggregate ID:
[(8000,00-1c-73-04-36-d7,0003,0000,0000), (8000,00-1c-73-0c-02-7d,0001,0000,0000)]
Bundled Ports: Ethernet3 Ethernet4
Port Channel Port-Channel4:
Aggregate ID:
[(0001,00-22-b0-57-23-be,0031,0000,0000), (8000,00-1c-73-04-36-d7,0004,0000,0000)]
Bundled Ports: Ethernet1 Ethernet2
Port Channel Port-Channel5:
Aggregate ID:
[(0001,00-22-b0-5a-0c-51,0033,0000,0000), (8000,00-1c-73-04-36-d7,0005,0000,0000)]
Bundled Ports: Ethernet41
switch>
```

10.2.5.33 show lacp counters

The `show lacp counters` command displays LACP traffic statistics.

Command Mode

EXEC

Command Syntax

```
show lacp [PORT_LIST] counters [PORT_LEVEL] [INFO_LEVEL]
```

 **Note:** `PORT_LEVEL` and `INFO_LEVEL` parameters can be placed in any order.

Parameters

- **PORT_LIST** Ports for which port information is displayed. Options include:
 - **no parameter** All configured port channels.
 - **c_range** Ports in specified channel list (number, number range, or list of numbers and ranges).
 - **interface** Ports on all interfaces.
 - **interface ethernet e_num** Port on Ethernet interface specified by **e_num**.
 - **interface port-channel p_num** Port on port channel interface specified by **p_num**.
- **PORT_LEVEL** Ports displayed, in terms of aggregation status. Options include:
 - **no parameter** Only ports bundled by LACP into an aggregate.
 - **all-ports** All ports, including LACP candidates that are not bundled.
- **INFO_LEVEL** Amount of information that is displayed. Options include:
 - **no parameter** Displays packet transmission (TX and RX) statistics.
 - **brief** Displays packet transmission (TX and RX) statistics.
 - **detailed** Displays packet transmission (TX and RX) statistics and actor-partner statistics.

Example

This command displays transmission statistics for all configured port channels.

```
switch>show lacp counters brief
```

Port	Status	LACPDUs		Markers		Marker Response		
		RX	TX	RX	TX	RX	TX	

Port Channel Port-Channel1:								
Et43	Bundled	396979	396959	0	0	0	0	0
Et44	Bundled	396979	396959	0	0	0	0	0
Et45	Bundled	396979	396959	0	0	0	0	0
Et46	Bundled	396979	396959	0	0	0	0	0
Port Channel Port-Channel2:								
Et47	Bundled	396836	396883	0	0	0	0	0
Et48	Bundled	396838	396883	0	0	0	0	0

```
switch>
```

10.2.5.34 show lacp interface

The **show lacp interface** command displays port status for all port channels that include the specified interfaces. Within the displays for each listed port channel, the output displays sys-id, partner port, state, actor port, and port priority for each interface in the channel.

Command Mode

EXEC

Command Syntax

```
show lacp interface [INTERFACE_PORT] [PORT_LEVEL] [INFO_LEVEL]
```

 **Note:** **INTERFACE_PORT** is listed first when present. Other parameters can be listed in any order.

Parameters

- **INTERFACE_PORT** Interfaces for which information is displayed. Options include:
 - **no parameter** All interfaces in channel groups.
 - **ethernet e_num** Ethernet interface specified by **e_num**.
 - **port-channel p_num** Port channel interface specified by **p_num**.
- **PORT_LEVEL** Ports displayed, in terms of aggregation status. Options include:
 - **no parameter** Command lists data for ports bundled by LACP into the aggregate.
 - **all-ports** Command lists data for all ports, including LACP candidates that are not bundled.
- **INFO_LEVEL** Amount of information that is displayed. Options include:
 - **no parameter** Displays same information as **brief** option.
 - **brief** Displays LACP configuration data, including sys-id, actor, priorities, and keys.
 - **detailed** Includes **brief** option information plus state machine data.

Example

This command displays LACP configuration information for all ethernet interfaces.

```
switch>show lacp interface
State: A = Active, P = Passive; S=ShortTimeout, L=LongTimeout;
       G = Aggregable, I = Individual; s+=InSync, s-=OutOfSync;
       C = Collecting, X = state machine expired,
       D = Distributing, d = default neighbor state
```

Port	Status	Sys-id	Partner Port#	State	OperKey	PortPri	Actor Port#

Port Channel	Port-Channel1:						
Et43	Bundled	8000,00-1c-73-09-a0-f3	43	ALGs+CD	0x0001	32768	43
Et44	Bundled	8000,00-1c-73-09-a0-f3	44	ALGs+CD	0x0001	32768	44
Et45	Bundled	8000,00-1c-73-09-a0-f3	45	ALGs+CD	0x0001	32768	45
Et46	Bundled	8000,00-1c-73-09-a0-f3	46	ALGs+CD	0x0001	32768	46
Port Channel	Port-Channel2:						
Et47	Bundled	8000,00-1c-73-01-02-1e	23	ALGs+CD	0x0002	32768	47
Et48	Bundled	8000,00-1c-73-01-02-1e	24	ALGs+CD	0x0002	32768	48

Port	Status	State	Actor OperKey	PortPriority

Port Channel	Port-Channel1:			
Et43	Bundled	ALGs+CD	0x0001	32768
Et44	Bundled	ALGs+CD	0x0001	32768
Et45	Bundled	ALGs+CD	0x0001	32768
Et46	Bundled	ALGs+CD	0x0001	32768
Port Channel	Port-Channel2:			
Et47	Bundled	ALGs+CD	0x0002	32768
Et48	Bundled	ALGs+CD	0x0002	32768

```
switch>
```

10.2.5.35 show lacp internal

The **show lacp internal** command displays the local LACP state for all specified channels. Local state data includes the state machines and LACP protocol information.

Command Mode

EXEC

Command Syntax

```
show lacp [PORT_LIST] internal [PORT_LEVEL] [INFO_LEVEL]
```

Parameters

- **PORT_LIST** Interface for which port information is displayed. Options include:
 - **no parameter** All configured port channels.
 - **c_range** Ports in specified channel list (number, number range, or list of numbers and ranges).
 - **interface** Ports on all interfaces.
 - **interface ethernet e_num** Ethernet interface specified by **e_num**.
 - **interface port-channel p_num** Port channel interface specified by **p_num**.
- **PORT_LEVEL** Ports displayed, in terms of aggregation status. Options include:
 - **no parameter** Command lists data for ports bundled by LACP into an aggregate.
 - **all-ports** Command lists data for all ports, including LACP candidates that are not bundled.
- **INFO_LEVEL** Amount of information that is displayed. Options include:
 - **no parameter** Displays same information as **brief** option.
 - **brief** Displays LACP configuration data, including sys-id, actor, priorities, and keys.
 - **detailed** Includes **brief** option information plus state machine data.



Note: **PORT_LEVEL** and **INFO_LEVEL** parameters can be placed in any order.

Example

This command displays internal data for all configured port channels.

```
switch>show lacp internal

LACP System-identifier: 8000,00-1c-73-04-36-d7
State: A = Active, P = Passive; S=ShortTimeout, L=LongTimeout;
      G = Aggregable, I = Individual; s+=InSync, s-=OutOfSync;
      C = Collecting, X = state machine expired,
      D = Distributing, d = default neighbor state
      |Partner
Port Status | Sys-id          Port#  State   Actor
-----|-----|-----|-----|-----|-----
Port Channel Port-Channell:
Et43 Bundled | 8000,00-1c-73-09-a0-f3  43  ALGs+CD  0x0001  32768
Et44 Bundled | 8000,00-1c-73-09-a0-f3  44  ALGs+CD  0x0001  32768
Et45 Bundled | 8000,00-1c-73-09-a0-f3  45  ALGs+CD  0x0001  32768
Et46 Bundled | 8000,00-1c-73-09-a0-f3  46  ALGs+CD  0x0001  32768
```

10.2.5.36 show lacp peer

The `show lacp peer` command displays the LACP protocol state of the remote neighbor for all specified port channels.

Command Mode

EXEC

Command Syntax

```
show lacp [PORT_LIST] peer [PORT_LEVEL] [INFO_LEVEL]
```

 **Note:** `PORT_LEVEL` and `INFO_LEVEL` parameters can be placed in any order.

Parameters

- **PORT_LIST** Interface for which port information is displayed. Options include:
 - **no parameter** Displays information for all configured port channels.
 - **c_range** Ports in specified channel list (number, number range, or list of numbers and ranges).
 - **interface** Ports on all interfaces.
 - **interface ethernet e_num** Ethernet interface specified by **e_num**.
 - **interface port-channel p_num** Port channel interface specified by **p_num**.
- **PORT_LEVEL** Ports displayed, in terms of aggregation status. Options include:
 - **no parameter** Command lists data for ports bundled by LACP into an aggregate.
 - **all-ports** Command lists data for all ports, including LACP candidates that are not bundled.
- **INFO_LEVEL** Amount of information that is displayed. Options include:
 - **no parameter** Displays same information as **brief** option.
 - **brief** Displays LACP configuration data, including sys-id, actor, priorities, and keys.
 - **detailed** Includes **brief** option information plus state machine data.

Example

This command displays the LACP protocol state of the remote neighbor for all port channels.

```
switch>show lacp peer

State: A = Active, P = Passive; S=ShortTimeout, L=LongTimeout;
       G = Aggregable, I = Individual; s+=InSync, s-=OutOfSync;
       C = Collecting, X = state machine expired,
       D = Distributing, d = default neighbor state

Port   Status | Sys-id                               Partner
      |                               Port#   State   OperKey  PortPri
-----|-----
Port Channel Port-Channel1:
Et1    Bundled | 8000,00-1c-73-00-13-19             1     ALGs+CD  0x0001   32768
Et2    Bundled | 8000,00-1c-73-00-13-19             2     ALGs+CD  0x0001   32768
Port Channel Port-Channel2:
Et23   Bundled | 8000,00-1c-73-04-36-d7             47    ALGs+CD  0x0002   32768
Et24   Bundled | 8000,00-1c-73-04-36-d7             48    ALGs+CD  0x0002   32768
Port Channel Port-Channel4*:
Et3    Bundled | 8000,00-1c-73-0b-a8-0e             45    ALGs+CD  0x0001   32768
Et4    Bundled | 8000,00-1c-73-0b-a8-0e             46    ALGs+CD  0x0001   32768
Port Channel Port-Channel5*:
Et19   Bundled | 8000,00-1c-73-0c-30-09             49    ALGs+CD  0x0005   32768
Et20   Bundled | 8000,00-1c-73-0c-30-09             50    ALGs+CD  0x0005   32768
Port Channel Port-Channel6*:
Et6    Bundled | 8000,00-1c-73-01-07-b9             49    ALGs+CD  0x0001   32768
Port Channel Port-Channel7*:
Et5    Bundled | 8000,00-1c-73-0f-6b-22             51    ALGs+CD  0x0001   32768
Port Channel Port-Channel8*:
Et10   Bundled | 8000,00-1c-73-10-40-fa             51    ALGs+CD  0x0001   32768

* - Only local interfaces for MLAGs are displayed. Connect to the peer to
   see the state for peer interfaces.
```

```
switch>
```

10.2.5.37 show lacp sys-id

The **show lacp sys-id** command displays the System Identifier the switch uses when negotiating remote LACP implementations.

Command Mode

EXEC

Command Syntax

```
show lacp sys-id [INFO_LEVEL]
```

Parameters

- **INFO_LEVEL** Amount of information that is displayed. Options include:
 - **no parameter** Displays system identifier.
 - **brief** Displays system identifier.
 - **detailed** Displays system identifier and system priority, including the MAC address.

Examples

- This command displays the system identifier.

```
switch>show lacp sys-id brief
8000,00-1c-73-04-36-d7
```

- This command displays the system identifier and system priority.

```
switch>show lacp sys-id detailed
System Identifier used by LACP:
System priority: 32768 Switch MAC Address: 00:1c:73:04:36:d7
802.11.43 representation: 8000,00-1c-73-04-36-d7
```

10.2.5.38 show load-balance profile

The **show load-balance profile** command displays the contents of the specified load balance profiles. Load balance profiles specify parameters used by hashing algorithms that distribute traffic across ports comprising a port channel or among component ECMP routes.

Command Mode

EXEC

Command Syntax

```
show load-balance profile [PROFILES]
```

Parameters

- **PROFILES** Load balance profiles for which command displays contents. Options include:
 - **no parameter** Displays all load balance profiles.
 - **profile_name** Displays specified profile.

Related Commands

- [load-balance policies](#) places the switch in **load-balance-policies configuration mode**.
- [ingress load-balance profile](#) applies a load-balance profile to an Ethernet or port channel interface.

Example

This command displays the contents of the **LB-1** load balance profile.

```
switch>show load-balance profile LB-1

----- LB-1 -----

Source MAC address hashing           ON
Destination MAC address hashing      ON
Ethernet type hashing                 ON
VLAN ID hashing                       ON
IP protocol field hashing             ON
DSCP field hashing is                 ON
Symmetric hashing for non-IP packets  OFF
Symmetric hashing for IP packets      OFF
Random distribution for port-channel  ON
Random distribution for ecmp          ON

Profile LB-1 is applied on the following
  Port-Channel100

----- myGlobalProfile (global) -----
L3 hashing is ON
Symmetric hashing is OFF
Hashing mode is flow-based
Hash polynomial is 3
Hash seed is 0
Profile myGlobalProfile (global) is applied on the following
Linecard3
Linecard4
Linecard5
Linecard6

switch>
```

10.2.5.39 show port-channel dense

The **show port-channel dense** command displays the port-channels on the switch and lists their component interfaces, LACP status, and set flags.

Command Mode

EXEC

Command Syntax

```
show port-channel dense
```

Example

This command displays **show port-channel dense** output:

```
switch>show port-channel dense

      Flags
-----
a - LACP Active          p - LACP Passive
U - In Use              D - Down
+ - In-Sync             - - Out-of-Sync      i - incompatible with agg
P - bundled in Po      s - suspended          G - Aggregable
I - Individual         S - ShortTimeout      w - wait for agg

Number of channels in use: 2
Number of aggregators:2

      Port-Channel      Protocol      Ports
-----
Po1 (U)                LACP (a)     Et47 (PG+) Et48 (PG+)
Po2 (U)                LACP (a)     Et39 (PG+) Et40 (PG+)
```

10.2.5.40 show port-channel limits

The **show port-channel limits** command displays groups of ports that are compatible and may be joined into port channels. Each group of compatible ports is called a LAG group. For each LAG group, the command also displays **Max interfaces** and **Max ports per interface**.

- **Max interfaces** defines the maximum number of active port channels that may be formed out of these ports.
- **Max ports per interface** defines the maximum number of active ports allowed in a port channel from the compatibility group.

All active ports in a port channel must be compatible. Compatibility comprises many factors and is specific to a given platform. For example, compatibility may require identical operating parameters such as speed and/or maximum transmission unit (MTU). Compatibility may only be possible between specific ports because of internal organization of the switch.

Command Mode

EXEC

Command Syntax

```
show port-channel limits
```

Example

This command displays **show port-channel list** output:

```
switch>show port-channel limits
LAG Group: focalpoint
-----
Max port-channels per group: 24, Max ports per port-channel: 16
24 compatible ports: Ethernet1 Ethernet2 Ethernet3 Ethernet4
                    Ethernet5 Ethernet6 Ethernet7 Ethernet8
                    Ethernet9 Ethernet10 Ethernet11 Ethernet12
                    Ethernet13 Ethernet14 Ethernet15 Ethernet16
                    Ethernet17 Ethernet18 Ethernet19 Ethernet20
                    Ethernet21 Ethernet22 Ethernet23 Ethernet24
-----
```

10.2.5.41 show port-channel load-balance fields

The **show port-channel load-balance fields** command displays the fields that the hashing algorithm uses to distribute traffic across the interfaces that comprise the port channels.

Command Mode

EXEC

Command Syntax

```
show port-channel load-balance HARDWARE fields
```

Parameters

- **HARDWARE** ASIC switching device. Selection options depend on the switch model and include:
 - **arad**
 - **fm6000**
 - **petraA**
 - **trident**

Example

This command displays the hashing fields used for balancing port channel traffic.

```
switch>show port-channel load-balance fm6000 fields

Source MAC address hashing for non-IP packets is ON
Destination MAC address hashing for non-IP packets is ON
Ethernet type hashing for non-IP packets is ON
VLAN ID hashing for non-IP packets is ON
VLAN priority hashing for non-IP packets is ON
Source MAC address hashing for IP packets is ON
Destination MAC address hashing for IP packets is ON
Ethernet type hashing for IP packets is ON
VLAN ID hashing for IP packets is ON
VLAN priority hashing for IP packets is ON
IP source address hashing is ON
IP destination address hashing is ON
IP protocol field hashing is ON
TCP/UDP source port hashing is ON
TCP/UDP destination port hashing is ON

switch>
```

10.2.5.42 show port-channel load-balance

The **show port-channel load-balance** command displays the traffic distribution between the member ports of the specified port channels. The command displays distribution for unicast, multicast, and broadcast streams.

The distribution values displayed are based on the total interface counters which start from zero at boot time or when the counters are cleared. For more current traffic distribution values, clear the interface counters of the member interfaces using the [clear counters](#) command.

Command Mode

EXEC

Command Syntax

```
show port-channel load-balance [MEMBERS]
```

Parameters

- **MEMBERS** list of port channels for which information is displayed. Options include:
 - *no parameter* all configured port channels.
 - *c_range* ports in specified channel list (number, number range, or list of numbers and ranges).

Example

This command displays traffic distribution for all configured port channels.

```
switch>show port-channel load-balance
ChanId  Port  Rx-Ucst  Tx-Ucst  Rx-Mcst  Tx-Mcst  Rx-Bcst  Tx-Bcst
-----  ----  -
      8   Et10  100.00%  100.00%  100.00%  100.00%    0.00%  100.00%
-----  ----  -
      1   Et1   13.97%   42.37%   47.71%   30.94%    0.43%  99.84%
      1   Et2   86.03%   57.63%   52.29%   69.06%   99.57%   0.16%
-----  ----  -
      2   Et23  48.27%   50.71%   26.79%   73.22%    0.00%  100.00%
      2   Et24  51.73%   49.29%   73.21%   26.78%    0.00%   0.00%
-----  ----  -
      4   Et3   55.97%   63.29%   51.32%   73.49%    0.00%   0.00%
      4   Et4   44.03%   36.71%   48.68%   26.51%    0.00%   0.00%
-----  ----  -
      5   Et19  39.64%   37.71%   50.00%   90.71%    0.00%   0.00%
      5   Et20  60.36%   62.29%   50.00%    9.29%    0.00%  100.00%
-----  ----  -
      6   Et6   100.00%  100.00%  100.00%  100.00%    0.00%  100.00%
-----  ----  -
      7   Et5   100.00%   0.00%  100.00%  100.00%    0.00%   0.00%
switch>
```

10.2.5.43 show port-channel

The `show port-channel` command displays information about members the specified port channels.

Command Mode

EXEC

Command Syntax

```
show port-channel [MEMBERS] [PORT_LIST] [INFO_LEVEL]
```

Parameters

- **MEMBERS** List of port channels for which information is displayed. Options include:
 - *no parameter* All configured port channels.
 - *p_range* Ports in specified channel list (number, number range, or list of numbers and ranges).
- **PORT_LEVEL** Ports displayed, in terms of aggregation status. Options include:
 - *no parameter* Displays information on ports that are active members of the LAG.
 - **active-ports** Displays information on ports that are active members of the LAG.
 - **all-ports** Displays information on all ports (active or inactive) configured for LAG.
- **INFO_LEVEL** Amount of information that is displayed. Options include:
 - *no parameter* Displays information at the brief level.
 - **brief** Displays information at the brief level.
 - **detailed** Displays information at the detail level.

Display Values

- **Port Channel** Type and name of the port channel.
- **Time became active** Time when the port channel came up.
- **Protocol** Protocol operating on the port channel.
- **Mode** Status of the Ethernet interface on the port. The status value is Active or Inactive.
- **No active ports** Number of active ports on the port channel.
- **Configured but inactive ports** Ports configured but that are not actively up.
- **Reason unconfigured** Reason why the port is not part of the LAG.

Guidelines

You can configure a port channel to contain many ports, but only a subset may be active at a time. All active ports in a port channel must be compatible. Compatibility includes many factors and is platform specific. For example, compatibility may require identical operating parameters such as speed and maximum transmission unit (MTU). Compatibility may only be possible between specific ports because of the internal organization of the switch.

Examples

- This command displays output from the `show port-channel` command.

```
switch>show port-channel 3
Port Channel Port-Channel3:
  Active Ports:
    Port                               Time became active   Protocol   Mode
    -----
    Ethernet3                          15:33:41             LACP      Active
    PeerEthernet3                      15:33:41             LACP      Active
```

- This command displays output from the `show port-channel active-ports` command.

```
switch>show port-channel active-ports
```

```
Port Channel Port-Channel3:  
  No Active Ports  
Port Channel Port-Channel11:  
  No Active Ports  
switch>
```

- This command displays output from the **show port-channel all-ports** command.

```
switch>show port-channel all-ports  
Port Channel Port-Channel3:  
  No Active Ports  
  Configured, but inactive ports:  
    Port                Time became inactive    Reason unconfigured  
-----  
-----  
    Ethernet3           Always                    not compatible with aggregate  
  
Port Channel Port-Channel11:  
  No Active Ports  
  Configured, but inactive ports:  
    Port                Time became inactive    Reason unconfigured  
-----  
-----  
    Ethernet25           Always                    not compatible with aggregate  
    Ethernet26           Always                    not compatible with aggregate
```

10.3 Multi-Chassis Link Aggregation

Arista switches support Multi-Chassis Link Aggregation (MLAG) to logically aggregate ports across two switches. For example, two 10-gigabit Ethernet ports, one each from two MLAG configured switches, can connect to two 10-gigabit ports on a host, switch, or network device to create a link that appears as a single 20-gigabit port. MLAG-configured ports provide Layer 2 multipathing, increased bandwidth, higher availability, and other improvements on traditional active-passive or Spanning Tree governed infrastructures.

The Multi-Chassis Link Aggregation section contains these topics:

- [MLAG Introduction](#)
- [MLAG Conceptual Overview](#)
- [MLAG Maintenance](#)
- [MLAG Dual Primary Detection and Release](#)
- [Configuring MLAG](#)
- [EVPN - MLAG Single-homed Hosts](#)
- [MLAG Implementation Example](#)
- [MLAG Commands](#)

10.3.1 MLAG Introduction

High availability data center topologies typically provide redundancy protection at the expense of over-subscription by connecting top-of-rack (TOR) switches and servers to dual aggregation switches. In these topologies, Spanning Tree Protocol prevents network loops by blocking half of the links to the aggregation switches. This reduces the available bandwidth by 50%.

Deploying MLAG removes over-subscription by configuring an MLAG link between two aggregation switches to create a single logical switching instance that utilizes all connections to the switches. Interfaces on both devices participate in a distributed port channel, enabling all active paths to carry data traffic while maintaining the integrity of the Spanning Tree topology.

MLAG provides these benefits:

- Aggregates multiple Ethernet ports across two switches.
- Provides higher bandwidth links as network traffic increases.
- Utilizes bandwidth more efficiently with fewer links blocked by STP.
- Connects to other switches and servers by static LAG or LACP without other proprietary protocols.
- Supports normal STP operation to prevent loops.
- Supports active-active Layer-2 redundancy.



Note: PTP (precision timing protocol) is not supported with MLAG.



Note: The global STP configuration is derived from the primary peer device while the secondary device parameters are ignored. When STP is disabled on the primary device, the secondary device will not contain any STP configuration information from the primary device. As a result, the secondary device will not be able to decide on the port roles or states, and will remain in the default state which is the discarding state. This is an expected behavior.



Note: It is highly recommended that both MLAG peer switches are identical platforms and run identical EOS images. Running different images/platform may result in a failure to form an association with the MLAG peer or see discrepancy in behavior.

10.3.2 MLAG Conceptual Overview

10.3.2.1 MLAG Operation Process

A multi-chassis link aggregation group (MLAG) is a pair of links that terminate on two cooperating switches and appear as an ordinary link aggregation group (LAG). The cooperating switches are MLAG peer switches and communicate through an interface called a peer link. While the peer link's primary purpose is exchanging MLAG control information between peer switches, it also carries data traffic from devices that are attached to only one MLAG peer and have no alternative path. An MLAG domain consists of the peer switches and the control links that connect the switches.

In the figure below, Switch A and Switch B are peer switches in the MLAG domain and connect to each other through the peer link. Each peer switch uses the peer address to form and maintain the peer link.

The MLAG domain ID is a text string configured in each peer switch. MLAG switches use this string to identify their peers. The MLAG System ID (MSI) is the MLAG domain's MAC address. The MSI is automatically derived when the MLAG forms and does not match the bridge MAC address of either peer. Each peer uses the MSI in STP and LACP PDUs.

The topology shown below contains four MLAGs: one MLAG connects each device to the MLAG domain. Each peer switch connects to the four servers through MLAG link interfaces.

In a conventional topology, with dually-attaching devices to multiple switches for redundancy, Spanning Tree Protocol (STP) blocks half of the switch-device links. In the MLAG topology, STP does not block any portion because it views the MLAG Domain as a single switch and each MLAG as a single port. The MLAG protocol facilitates the balancing of device traffic between the peer switches.

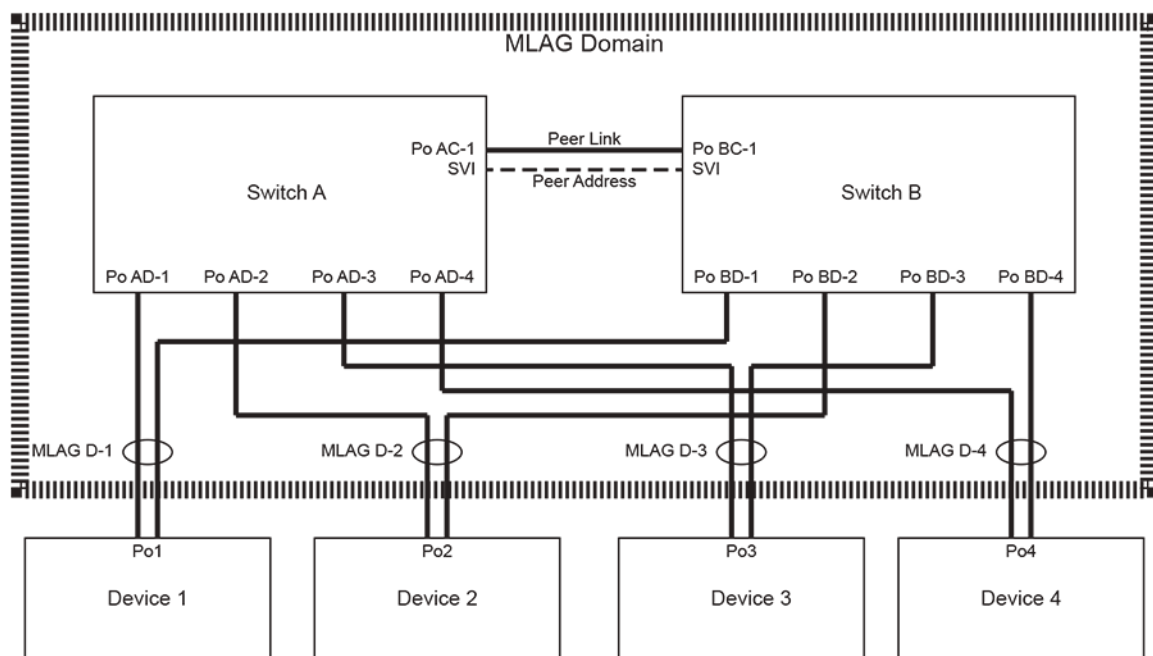

Figure 21: MLAG Domain Topology

When MLAG is disabled, peer switches revert to their independent state. MLAG is disabled by any of the following:

- MLAG configuration changes.
- The TCP connection breaks.
- The peer-link or local-interface goes down.
- A switch does not receive a response to a keep alive message from its peer within a specified period.

10.3.2.2 MLAG Interoperability with Other Features

The following sections describe MLAG interaction with other switch features.

10.3.2.2.1 VLANs

VLAN parameters must be configured identically on each peer for the LAGs comprising the peer link and MLAGs. These parameters include the switchport access VLAN, switchport mode, trunk-allowed VLANs, the trunk native VLAN, and switchport trunk groups.

Configuration discrepancies may result in traffic loss in certain failure scenarios. Port-specific bridging configuration originates on the switch where the port is physically located.

10.3.2.2.2 LACP

Link Aggregation Control Protocol (LACP) should be used on all MLAG interfaces, including the peer-link. LACP control packets reference the MLAG system ID.

10.3.2.2.3 Static MAC Addresses

A static MAC address configured on an MLAG interface is automatically configured on the peer's corresponding interface. Configuring static MAC addresses on both peers prevents undesired flooding if an MLAG peer relationship fails.

If the MLAG peering relationship is disabled, the static MAC previously learned from peer is removed.

10.3.2.2.4 STP

When implementing MLAG in a spanning tree network, spanning tree must be configured globally and on port-channels configured with an MLAG ID. Port specific spanning tree configuration comes from the switch where the port physically resides. This includes spanning-tree PortFast BPDU Guard and BPDU filter.

10.3.2.2.5 Port Mirroring

A port channel which is a member of an MLAG *must not* be used as the destination port for a port mirroring (port monitoring) session.

10.3.2.3 IPv6 Flow Label Hashing

Arista switches use the hashing algorithm to load-balance traffic among LAG members and Layer 3 ECMP (equal cost multipath) paths. For IP and IPv6 traffic, the hashing algorithm includes (if so configured for LAG) the IP packet fields such as source and destination IP addresses as well as source and destination ports for UDP and TCP traffic.

To improve traffic distribution for IPv6 traffic, IPv6 Flow Label field has been added to the hashing algorithm for both LAG and ECMP.

 **Note:** IPv6 Flow Label is included in the LAG hashing algorithm only when the MAC header hashing is not enabled for IPv6 traffic.

10.3.3 MLAG Maintenance

These sections describe tasks required for MLAG to operate on the switch:

- [Ensuring Control Plane ACL Compatibility](#)
- [MLAG Availability through a Single Functional Peer](#)
- [Upgrading MLAG Peers](#)

10.3.3.1 Ensuring Control Plane ACL Compatibility

The control plane access control list (ACL) on any interface participating in the MLAG must be configured to allow only the peer link neighbor to generate MLAG control traffic. The required rules are included in the default control plane ACL for Ethernet ports.

Any custom control plane ACL applied to a participating port must include these three rules:

```
permit tcp any any eq mlag ttl eq 255
permit udp any any eq mlag ttl eq 255
permit tcp any eq mlag any ttl eq 255
```

MLAG peers that function as routers must each have routing enabled.

10.3.3.2 MLAG Availability through a Single Functional Peer

MLAG high availability advantages are fully realized when all devices that connect to one MLAG switch also connect to the peer switch. A switch can continue supporting MLAG when its peer is offline if the STP agent is restartable. When one peer is offline, data traffic flows from the devices through the MLAG component link that connects to the functioning switch. When a switch is offline, its interfaces and ports do not appear in `show mlag` and `show spanning tree protocol` commands of the functioning peer.

To view the restartability status of the STP agent, use the **detail** option of the `show spanning-tree instance` command:

```
switch-1#show spanning-tree instance detail | grep agent
Stp agent restartable           :                True
```

STP agent restartability requires consistent configuration between the peers of STP, LACP, MLAG, and switchport parameters. Events triggering an STP state machine change may also briefly prevent the STP agent from being restartable.

10.3.3.2.1 Reload Delay

If an MLAG peer reboots, all ports except those in the peer-link port-channel remain in **errdisabled** state for a specified time, called the reload-delay period. This period allows all topology states to stabilize before the switch begins forwarding traffic. Each Arista switch defaults to the recommended reload-delay value, which varies by switch platform:

- **Fixed configuration switches:** 300 seconds
- **Trident II modular switches:** 1200 seconds
 - 7304
 - 7308
 - 7316
 - 7300X series
- **Sand platform fixed configuration switches:** 600 seconds
 - 7280 series
- **Sand platform modular switches:** 1800 seconds
 - 7504
 - 7508
 - 7500E series
 - 7548S

In those cases where network topology requires additional time to stabilize or where a shorter delay can be tolerated, the reload-delay period can be configured using the `reload-delay mlag` command.

Severing the physical connection (cable) that establishes the peer-link between MLAG peers may result in a **split brain** state where each peer independently enters spanning tree state to prevent topology loops. Sessions established through one interface of a dual attached device may fail if its path is disrupted by the STP reconvergence, possibly resulting in temporarily lost connectivity. Sessions can be reestablished if permitted by the resulting topology.

10.3.3.3 Upgrading MLAG Peers

MLAG ISSU (In-Service Software Upgrade) upgrades EOS software on one MLAG peer with minimal traffic disruptions on active MLAG interfaces and without changing the network topology.

10.3.3.3.1 Verifying Configuration Compatibility

A seamless EOS upgrade on an MLAG peer requires that the following features are configured consistently on each switch:

- VLANs
- Switchport configuration on port channel interfaces that are configured with an MLAG ID
- STP configuration (global)

10.3.3.3.2 Version Compatibility

A switch running MLAG can be upgraded without disrupting MLAG traffic when the upgrade EOS version is compatible with the version on the peer switch. Refer to the Release Notes for a list of compatible EOS versions.

10.3.3.3.3 Reload Warning Conditions

Entering an EOS reload command while MLAG is active generates warning messages if conditions that can result in packet loss during the upgrade are present. All warnings should be resolved before confirming the reload request. The following table displays the reload conditions and a common resolution method for each condition.

Table 64: Reload Warning Resolutions

Reload Condition	Resolution Method
Compatibility check	Refer to the Release Notes to verify that the new version is compatible with the currently installed version.
Active-partial MLAG warning	Bring up the remote port-channel. If the MLAG is not actively used, then this warning can be ignored.
STP is not restartable	Wait for STP to be restartable: typically 30 seconds, up to 120 seconds for a newly started STP agent. Refer to MLAG Availability through a Single Functional Peer for information on checking restartability.
Reload delay too low	Configure a reload delay value greater than or equal to the default. Recommend delay is 300 seconds for TOR switches, 900 seconds for modular switches, and 600 seconds for Sand platform fixed configuration switches (7280 series).
Peer has error-disabled interfaces	Wait for reload-delay to expire on the peer.

Example

- The following `reload` command generates MLAG warning conditions that should be addressed before confirming the *proceed with reload* prompt.

```
switch(config)#reload
If you are performing an upgrade, and the Release Notes for the
new version of EOS indicate that MLAG is not backwards-compatible
with the currently installed version (4.9.2), the upgrade will
result in packet loss.

The following MLAGs are not in Active mode. Traffic to or from these ports will
be lost during the upgrade process.
```

mlag	desc	state	local	remote	local/remote status
14		active-partial	Po14	Po14	up/down
15		active-partial	Po15	Po15	up/down

```
Stp is not restartable. Topology changes will occur during the upgrade process.

The configured reload delay of 100 seconds is below the default
value of 300 seconds. A longer reload delay allows more time to
rollback an unsuccessful upgrade due to incompatibility.

The other MLAG peer has errdisabled interfaces. Traffic loss will occur during
the upgrade process.

Proceed with reload? [confirm]
```

10.3.3.3.4 Performing an MLAG ISSU Upgrade

The following procedure performs an MLAG ISSU upgrade:

1. Verify configuration consistency on each peer ([Verifying Configuration Compatibility](#)).
2. Verify version compatibility between the new and existing images ([Version Compatibility](#)).
3. Configure `reload-delay mlag` ([MLAG Availability through a Single Functional Peer](#)) if needed. Recommended delay period varies by switch type, and each switch defaults to its recommended delay period.
4. Install the new image onto one of the peers:
 - a. Upload the new image to the switch.
 - b. Set the boot path to the new image.
 - c. Enter the `reload` command.
5. Resolve all reload warnings.
6. Confirm the reload.
7. Wait for MLAG peers to renegotiate to the active state and reload-delay expiry on rebooted peer; until reload-delay period has expired, ports on the rebooted peer (except the peer-link) will be in **errdisabled** state with err-disabled reason being **mlag-issu**.

Avoid configuration changes on both peers until after this step.

8. Repeat the upgrade process for the other peer.

When upgrading modular switches with dual supervisors, upgrade the standby supervisors first, then upgrade the active supervisors.

10.3.4 MLAG Dual Primary Detection and Release

When the MLAG peer-link goes down, the secondary peer assumes the primary peer is down or dead, and takes over the primary role. It is possible that when peer-link is down, the primary is not actually down or dead, and both MLAG peers think they are the primary. This is called **dual-primary** condition or state. In this state, each peer runs Layer-2 protocols such as Spanning Tree Protocol independently. Depending on the topology, this can cause loops in the network. This can also impact the IGMP snooping feature.

The Dual Primary Detection feature uses the management interface as an out-of-band connection between the two peers along with the peer-link. Once configured, the MLAG peers send UDP heartbeat packets on the management interface. When the peer-link goes down and the heartbeat is still active on out-of-band connection, both MLAG peers detect **dual-primary** condition. The switch can take optional action to shutdown all links except the peer-link on the original secondary MLAG peer.

Beginning with the **EOS Release 4.23.1F**, there is support for dual primary recovery delay.

Recovery delay is an improvement to the current dual-primary detection feature. Use only when MLAG peers recover from dual-primary detection with configured `errdisable all-interfaces`. When recovery delay is configured, the old secondary MLAG peer expects to unerrdisable MLAG interfaces later than non-MLAG to allow more time for L3 interfaces to converge.

Beginning with the **EOS Release 4.25.0F**, when dual-primary-detection is enabled, there will be heartbeats transferred on both the peer-link and the management link at the same time. This improves dual-primary-detection because both the management link and the peer-link need to fail before the detection fails.

10.3.4.1 Supported EOS Versions

MLAG dual primary detection is supported beginning with **EOS Release 4.20.0F** and onwards.

10.3.4.2 Platform Compatibility

All Arista platforms support MLAG.

10.3.4.3 Limitations

The following limitations apply to the MLAG Dual Primary Detection feature.

1. UDP port 4432 is used to exchange control information between the peers, and must not be blocked on the management interfaces on both of the MLAG peers.
2. At least one MLAG port-channel must be configured on the MLAG peers to perform dual primary detection and the corresponding `errdisable` action.
3. `Errdisable` action brings down all physical Ethernet interfaces excluding the MLAG peer-link and management port. However, Layer-2 port-channels go down and VLAN SVIs may go down (i.e. autostate taking down VLAN SVIs).
4. When the `errdisable` action is configured with the non-MLAG interfaces recovery delay the `errdisable` action must always be less than the MLAG interfaces recovery delay. Otherwise, MLAG interfaces will come up sooner and cause northbound traffic loss.
5. Do not configure this feature if there can be consecutive peer-link flaps. There is an issue that if there are consecutive peer-link flaps during which MLAG peers also happen to switch roles, you can have unexpired recovery timers on the new primary and the secondary can not go dual primary detected until the MLAG recovery timer expires. This can open a small window for L3 traffic blackholing on the primary depending on the delta between recovery delay for MLAG and non-MLAG interfaces.
6. Changing the recovery delay configurations during active recovery delay may cause interfaces to stay `errdisabled`.

10.3.4.4 MLAG Dual Primary Detection and Release Configuration

To enable MLAG dual primary detection feature, you must configure the following commands on both MLAG peers in the **MLAG configuration mode**.

```
switch(config-mlag) #peer-address heartbeat Peer-IP [vrf VRF-NAME ]
```

Parameters:

- **Peer-IP** The Management IP address of the MLAG peer reachable in the targeted VRF.
- **VRF-NAME** The MLAG peer reachable in VRF (or default VRF if no VRF is configured).

The `peer-address heartbeat` command causes the MLAG agent to start using **Peer-IP** address in the given VRF for UDP-based heartbeat control messages.

The `dual-primary detection delay` command configures dual primary detection delay with an optional action to errdisable all interfaces on secondary MLAG peer after detecting the dual primary condition.

```
switch(config-mlag) #dual-primary detection delay SECONDS [action
errdisable all-interfaces]
```

Parameters:

- **delay** Specifies the number of seconds to wait after MLAG failover to listen for MLAG heartbeats to determine dual primary condition.
- **action errdisable all-interfaces** Errdisables all local physical interfaces on the secondary MLAG peer after detecting the dual primary condition.

 **Note:** This feature must be configured on both MLAG peers.

Use both the `peer-address heartbeat` command and the `dual-primary detection` command on each peer to disable the Dual Primary Detection feature.

The `peer-address heartbeat` command triggers MLAG to revert using the peer-link for heartbeat control messages instead of the management IP address of the MLAG peer.

```
switch(config-mlag) # (no|default) peer-address heartbeat
```

The `dual-primary detection` command removes the detection delay time as well as detection action.

Examples

- This example specifies the MLAG Peer's Management IP address **172.30.118.190** in default VRF for heartbeats.

```
switch(config) #mlog
switch(config-mlag) #peer-address heartbeat 172.30.118.190
```

- In this example, the command errdisables all physical interfaces on secondary MLAG peer when dual primary condition is detected.

```
switch(config-mlag) #dual-primary detection delay 5 action errdisable
all-interfaces
```

Both MLAG peers must have equivalent configurations.

The following commands remove the Dual Primary Detection feature. You must unconfigure both MLAG peers.

```
switch(config-mlag) #no peer-address heartbeat
switch(config-mlag) #no dual-primary detection
```

The `dual-primary recovery delay` command configures the dual-primary detection recovery-delay for MLAG interfaces and non-MPLG interfaces. Negating the configurations or configuring default values makes both recovery delay values reset back to 0. The non-MLAG delay must always be less than the MLAG delay so that you have more time for L3 convergence before you enable the

MLAG interfaces. A suggested value for MLAG is 60 seconds, and non-MLAG is 0 seconds. These values can be adjusted depending on the network scale.

```
switch(config-mlag) #dual-primary recovery delay mlag <0-1000> non-  
mlag <0-1000>  
switch(config-mlag) #[no|default] dual-primary recovery delay
```

10.3.4.4.1 ISSU Implications

When upgrading from an EOS release that does not support the Dual Primary Detection feature, you must configure this feature only after both MLAG peers are upgraded to the release that has support. When downgrading to a release without Dual Primary Detection support, the configuration must be removed from both the peers before the downgrade process is initiated on either peer. Otherwise, MLAG fails configuration sanity.

10.3.4.5 Viewing the MLAG Dual Primary Detection and Release Status

Use the **show running-config** command to display the MLAG dual primary detection configuration.

Example

```
switch#show running-config  
...  
mlag configuration  
  domain-id test_domain_1  
  local-interface Vlan4094  
  peer-address 10.0.0.2  
  peer-address heartbeat 172.30.118.190  
  primary-priority 11  
  peer-link Port-Channel1  
  dual-primary detection delay 5 action errdisable all-interfaces  
  ...
```

Use the **show mlag detail** command to display MLAG dual primary interface errdisabled status, recovery delay status, and the heartbeat counts sent and received. You can infer that the status of recovery delay is active if the dual-primary detection is Configured (dual primary resolved) and dual-primary interface errdisabled is True.

Example

```
switch(config-mlag) #show mlag detail  
MLAG Configuration:  
  domain-id : test_domain_1  
  local-interface : Vlan4094  
  peer-address : 10.0.0.1  
  peer-link : Port-Channel1  
  hb-peer-address : 172.30.117.28  
  peer-config : consistent  
  
MLAG Status:  
  state : Active  
  negotiation status : Connecting  
  peer-link status : Down  
  local-int status : Up  
  system-id : 46:4c:a8:c6:42:dd  
  dual-primary detection : Detected  
  
MLAG Ports:  
  Disabled : 0  
  Configured : 0
```

```

Inactive : 0
Active-partial : 0
Active-full : 0

MLAG Detailed Status:
State : primary
State changes : 5
Last state change time : 1:06:19 ago
Hardware ready : True
Failover : True
Last failover change time : 1:06:19 ago
Secondary from failover : False
primary-priority : 12
Peer primary-priority : 11
Peer MAC address : 44:4c:a8:c6:42:dd
Peer MAC routing supported : True
Reload delay : 0 seconds
Non-MLAG reload delay : 0 seconds
Peer ports errdisabled : False
Lacp standby : False
Configured heartbeat interval : 4000 ms
Effective heartbeat interval : 4000 ms
Heartbeat timeout : 60000 ms
Last heartbeat timeout : never
Heartbeat timeouts since reboot : 0
UDP heartbeat alive : True
Heartbeats sent/received : 3189/3189
Peer monotonic clock offset : unknown
Agent should be running : True
P2p mount state changes : 4
Fast MAC redirection enabled : False
Dual-primary detection delay : 5
Dual-primary action : errdisable-all

```

When the dual-primary action is errdisable and detects the **dual-primary** condition, all the ethernet interfaces on the secondary MLAG peer are errdisabled with a **mlagdualprimary** reason.

Example

```

switch#show interfaces status errdisabled
Port Name Status Reason
-----
Et1 errdisabled mlagdualprimary
Et2 errdisabled mlagdualprimary
Et14 errdisabled mlagdualprimary
...

```

10.3.5 Configuring MLAG

These sections describe the basic MLAG configuration steps:

- [Configuring the MLAG Peers](#)
- [Configuring MLAG Services](#)

10.3.5.1 Configuring the MLAG Peers

Connecting two switches as MLAG peers requires the establishment of the peer link and an SVI that defines local and peer IP addresses on each switch.

The peer link is composed of a LAG between the switches. When all devices that connect to the MLAG domain are dually connected to the switches through an MLAG, a peer link of two Ethernet interfaces

is sufficient to handle MLAG control data and provide N+1 redundancy. When the domain connects to devices through only one MLAG peer, the peer link may require additional Ethernet interfaces to manage data traffic.

Disruptions to peer link connectivity due to forwarding agent restarts may cause an extended MLAG outage. Forwarding agent restart event include some configuration changes, such as port speed change or UFT mode change). The following precautions can reduce the risk of losing peer-link connectivity:

- all switches: constructing peer-links from port-channels in preference to a single Ethernet interface.
- modular systems: peer-link port-channel members should span multiple line cards.
- multi-chip systems: peer-link port-channel member should span multiple chips.

[Managing Switch Configuration Settings](#) describes modular systems.

The steps that configure two switches as MLAG peers include:

- [Configuring the Port Channels, VLAN Interfaces, and IP addresses](#)
- [Configuring Peer Parameters](#)
- [Configuring MLAG Peer Gateway](#)

10.3.5.1.1 Configuring the Port Channels, VLAN Interfaces, and IP addresses

The peer link is a normal port channel. The local address is the SVI that maps to the peer link port channel. The port channel and SVI must be configured on each peer switch. The port channel should be an active LACP port. The local and peer addresses must be located on the same IP address subnet. Autostate should be disabled on the SVI configured as the local interface.

Examples

- These commands create an active mode LACP port channel interface from two Ethernet interfaces and configure it as part of a trunk group on each switch.

The **switchport mode trunk** command permits all VLANs on the interface by default, so all VLANs are permitted on port channel 10 in the following example. The configuration of a trunk group for a VLAN restricts only that specific VLAN to the associated ports: VLAN 4094 is only permitted on port channel 10, and not on any other ports on the switch. It is important to remember that all VLANs must be permitted between the peers on the peer link for correct operation.

Switch 1

```
switch1#config
switch1(config)#vlan 4094
switch1(config-vlan-4094)#trunk group mlpeer
switch1#config
switch1(config)#interface ethernet 1-2
switch1(config-if-et1-2)#channel-group 10 mode active
switch1(config-if-et1-2)#interface port-channel 10
switch1(config-if-po10)#switchport mode trunk
switch1(config-if-po10)#switchport trunk group mlpeer
switch1(config-if-po10)#exit
switch1(config)#
```

Switch 2

```
switch2#config
switch2(config)#vlan 4094
switch2(config-vlan-4094)#trunk group mlpeer
switch2(config-vlan-4094)#exit
switch2(config)#interface ethernet 1-2
switch2(config-if-et1-2)#channel-group 10 mode active
```



```
switch2(config-if-et1-2) #interface port-channel 10
switch2(config-if-po10) #switchport mode trunk
switch2(config-if-po10) #switchport trunk group mlpeer
switch2(config-if-po10) #exit
switch2(config) #
```

- These commands create an SVI for the local interface and associate it to the trunk group assigned to the peer link port channel.

The SVI creates a Layer 3 endpoint in the switch and enables MLAG processes to communicate via TCP. The IP address can be any unicast address that does not conflict with other SVIs. STP is disabled for the peer link **VLAN 4094** to prevent any potential STP disruption of inter peer communications. Recall that the VLAN has been restricted to port-channel 10 by the earlier trunk group configuration thus preventing potential Layer 2 loop conditions within **VLAN 4094**.

Switch 1

```
switch1#config
switch1(config) #interface vlan 4094
switch1(config-if-vl4094) #ip address 10.0.0.1/30
switch1(config-if-vl4094) #no autostate
switch1(config-if-vl4094) #exit
switch1(config) #no spanning-tree vlan-id 4094
switch1(config) #
```

Switch 2

```
switch2#config
switch2(config) #interface vlan 4094
switch2(config-if-vl4094) #ip address 10.0.0.2/30
switch2(config-if-vl4094) #no autostate
switch2(config-if-vl4094) #exit
switch2(config) #no spanning-tree vlan-id 4094
switch2(config) #
```

10.3.5.1.2 Configuring Peer Parameters

Peer connection parameters configure the connection between the MLAG peer switches. This section describes the following peer configuration parameters.

- [MLAG Configuration Mode](#)
- [Local VLAN Interface](#)
- [Peer Address](#)
- [Peer Link](#)
- [Domain ID](#)
- [Heartbeat Interval and Timeout](#)
- [Reload Delay Period](#)
- [Shutdown](#)

10.3.5.1.2.1 MLAG Configuration Mode

Peer connection parameters are configured in MLAG-configuration mode. The [mlog configuration \(global configuration\)](#) command places the switch in MLAG configuration mode.

Example

This command places the switch in MLAG configuration mode.

```
switch(config) #mlog configuration
```

```
switch(config-mlag) #
```

10.3.5.1.2.2 Local VLAN Interface

The local interface specifies the SVI upon which the switch sends MLAG control traffic. The local IP address is specified within the definition of the VLAN associated with the local interface. The Peer Address configures the control traffic destination on the peer switch.

The `local-interface` command specifies a VLAN interface as the peer link SVI.

Example

This command configures VLAN 4094 as the local interface.

```
switch(config-mlag) #local-interface vlan 4094
switch(config-mlag) #
```

10.3.5.1.2.3 Peer Address

The peer address is the destination address on the peer switch for MLAG control traffic. If the peer IP address is unreachable, MLAG peering fails and both peer switches revert to their independent state.

The `peer-address` command specifies the peer address.

Example

This command configures a peer address of 10.0.0.2.

```
switch(config-mlag) #peer-address 10.0.0.2
switch(config-mlag) #
```

10.3.5.1.2.4 Peer Link

An MLAG is formed by connecting two switches through an interface called a peer link. The peer link carries MLAG advertisements, keepalive messages, and data traffic between the switches. This information keeps the two switches working together as one. While interfaces comprising the peer links on each switch must be compatible, they need not use the same interface number. Ethernet and Port-channel interfaces can be configured as peer links.

The `peer-link` command specifies the interface the switch uses to communicate MLAG control traffic.

Example

- This command configures port-channel 10 as the peer link.

```
switch(config-mlag) #peer-link port-channel 10
switch(config-mlag) #
```

10.3.5.1.2.5 Domain ID

The MLAG domain ID is a unique identifier for an MLAG domain. The MLAG domain ID must be the identical on each switch to facilitate MLAG communication.

The `domain-id` command configures the MLAG domain ID.

Example

This command configures *mlagDomain* as the domain ID:

```
switch(config-mlag) #domain-id mlagDomain
```

```
switch(config-mlag) #
```

10.3.5.1.2.6 Heartbeat Interval and Timeout

The heartbeat interval specifies the period between the transmission of successive keepalive messages. Each MLAG switch transmits keepalive messages and monitors message reception from its peer. The heartbeat timeout is reset when the switch receives a keepalive message. If the heartbeat timeout expires, the switch disables MLAG under the premise that the peer switch is not functioning.

The [heartbeat-interval \(MLAG\)](#) command configures the heartbeat interval between 1 and 30 seconds, with a default value of 2 seconds. The heartbeat timeout expiry is 30 seconds.



Note: On 7500 and 7500E Series Switches, Arista recommends setting the heartbeat interval to 10 seconds.

Example

This command configures the heartbeat interval as 2.5 seconds (2500 ms).

```
switch(config-mlag) #heartbeat-interval 2500
switch(config-mlag) #
```

10.3.5.1.2.7 Reload Delay Period

The reload delay period specifies the interval that non-peer links are disabled after an MLAG peer reboots. This interval allows non-peer links to learn multicast and OSPF states and synchronize ARP caches before the ports start handling traffic. Each Arista switch defaults to the recommended reload-delay value, which varies by switch platform.

- Fixed configuration switches: 300 seconds (five minutes)
- Trident II platform modular switches: 1200 seconds (twenty minutes)
- Sand platform fixed configuration switches (7280 series): 600 seconds (ten minutes)
- Sand platform modular switches: 1800 seconds (thirty minutes)

In those cases where network topology requires additional time to stabilize or where a shorter delay can be tolerated, the reload-delay period can be configured using the [reload-delay mlag](#) command.

Example

This command configures the reload delay interval as 2.5 minutes (150 seconds).

```
switch(config-mlag) #reload-delay 150
switch(config-mlag) #
```

10.3.5.1.2.8 Shutdown

The [shutdown \(MLAG\)](#) command disables MLAG operations without disrupting the MLAG configuration. The `no mlag configuration` command (global configuration mode) disables MLAG and removes the MLAG configuration. The `no shutdown` command resumes MLAG activity.

Examples

- This command disables MLAG activity on the switch.

```
switch(config-mlag) #shutdown
switch(config-mlag) #
```

- This command resumes MLAG activity on the switch.

```
switch(config-mlag) #no shutdown
```

```
switch(config-mlag) #
```

10.3.5.1.3 Configuring MLAG Peer Gateway

In an MLAG setup, routing on a MLAG peer switch is possible using its own bridge system MAC, VARP MAC, or VRRP MAC. On a peer receiving an IP packet with destination MAC set to one of these MACs, a packet gets routed if its hardware has enough information to route the packet. Configuring sending traffic to a cached MAC involves routing the session table and MLAG peer traffic if packets are received with the MAC peer.

Examples

- This command enables the MLAG peer gateway.

```
switch(config) #ip virtual-router mac-address mlag-peer  
switch1(config) #
```

- This command disables the MLAG peer gateway.

```
switch(config) #no ip virtual-router mac-address mlag-peer  
switch1(config) #
```

10.3.5.1.4 Configuring Ingress Replication to LAGs

Hardware support for ingress replication to LAGs is enabled by default when the user configures ingress replication. When multicast traffic is sent over the LAG, the hardware uses its built-in algorithm, based on the L2/L3/L4 headers, to load balance traffic over ports in the LAG. When a port goes down in a LAG, the hardware quickly hashes the multicast traffic over the remaining ports in the LAG, resulting in fewer drops than software based LAG support.

Examples

- This command enables ingress replication.

```
switch(config) #platform sand multicast replication default ingress  
switch(config) #
```

- This command configures the maximum members (within a range of 1 through 64) for ingress only replication in a multicast group.

```
switch(config) #platform sand multicast replication ingress maximum 32  
switch(config) #
```

10.3.5.2 Configuring MLAG Services

An MLAG is a pair of links that originate on a network attached device and terminate on the two MLAG peer switches. The MLAG switches coordinate traffic to the device through a common [mlag \(port-channel interface configuration\)](#) command on the interfaces that connect to the device.

The MLAG ID differs from the MLAG domain ID. The MLAG domain ID is assigned globally per switch in MLAG configuration mode, and the same MLAG domain ID must be on both switches.

It is not recommended that MLAGs are used with static LAGs. Configure the downstream switch or router connected to the MLAG peers to negotiate a LAG with LACP. For Arista Networks switches, this is in respect to a configuration such as `channel-group group-number mode on`.

Port channels configured as an MLAG must have identical port channel numbers. Although the MLAG ID is a distinct parameter from the port channel number, best practices recommend assigning the MLAG ID to match the port channel number.

The following example does not follow this convention to emphasize the parameters that are distinct. The example in [MLAG Implementation Example](#) follows the best practices convention.

Examples

- These Switch1 commands bundle Ethernet interfaces 3 and 4 in port channel 20, then associate that port channel with MLAG 12.

```
switch1(config)#interface ethernet 3-4
switch1(config-if-et3-4)#channel-group 20 mode active
switch1(config-if-et3-4)#interface port-channel 20
switch1(config-if-po20)#mlag 12
switch1(config-if-po20)#exit
switch1(config)#
```

- These Switch2 commands bundle Ethernet interfaces 9 and 10 in port channel 20, then associate that port channel with MLAG 12.

```
switch2(config)#interface ethernet 9-10
switch2(config-if-et9-10)#channel-group 20 mode active
switch2(config-if-et9-10)#interface port-channel 20
switch2(config-if-po20)#mlag 12
switch2(config-if-po20)#exit
switch2(config)#
```

- These commands configure the port channels that attach to the MLAG on network attached device:

```
NAD(config)#interface ethernet 1-4
NAD(config-if-Et1-4)#channel-group 1 mode active
NAD(config-if-Et1-4)#exit
NAD(config)#
```

The following figure displays the result of the interface MLAG configuration.

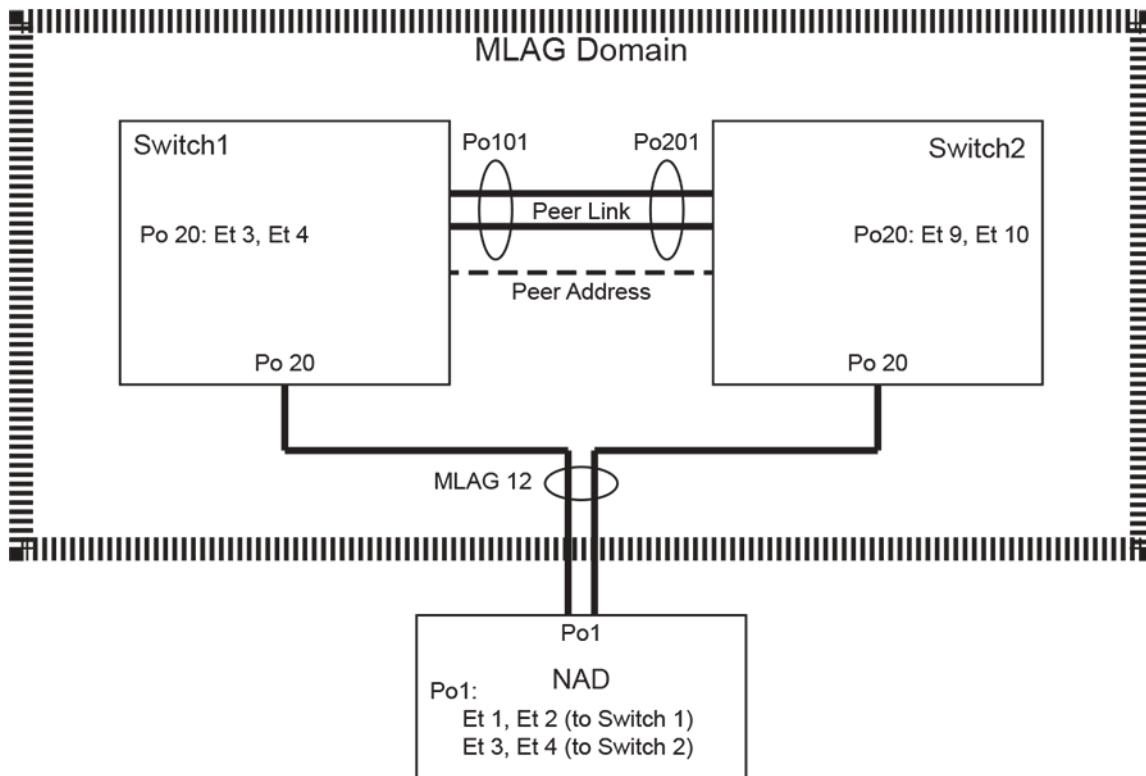

Figure 22: MLAG Interface Configuration

10.3.6 EVPN - MLAG Single-homed Hosts

Add a local VTEP to each MLAG peer for the control plane to advertise singly connected hosts as being directly behind a specific local VTEP-MLAG peer. Outgoing EVPN route advertisements contain nexthop and router MAC extended community when multi-VTEP MLAG mode is enabled. The following table summarizes the information. For symmetric IRB support, MLAG shared router MAC must be enabled.

Table 65: Route Advertisement

Routes	Single-homed host	Multi-homed host
MAC/IP routes (Type-2)	Local VTEP IP / Bridge MAC	MLAG VTEP IP / Shared MLAG Router MAC
IMET routes (Type-3)	MLAG VTEP IP	
IP Prefix routes (Type-5)	Local VTEP IP / Bridge MAC	

In multi-VTEP MLAG mode, IP prefix routes are advertised independently by each MLAG peer with its own local VTEP IP as nexthop, even when both peers are connected to that route. Additionally, egress VXLAN packets use the appropriate source IP to match what is advertised by the EVPN control plane.

Show commands

The following displays the nexthop of locally generated EVPN Type-2 and Type-3 routes. The real IP address helps identify the VTEP being used. The nexthop of locally generated EVPN Type-5 routes

are displayed as "-". The shared MLAG VTEP IP is 1.1.1.1 and the local VTEP IPs of the two MLAG peers are 1.0.1.1 and 1.0.2.2.

```
switch#show bgp evpn
BGP routing table information for VRF default
Router identifier 0.0.0.1, local AS number 300
Route status codes: s - suppressed, * - valid, > - active, # - not
                    installed, E - ECMP head, e - ECMP
                    S - Stale, c - Contributing to ECMP, b - backup
                    % - Pending BGP convergence
Origin codes: i - IGP, e - EGP, ? - incomplete
AS Path Attributes: Or-ID - Originator ID, C-LST - Cluster List, LL
                    Nexthop - Link Local Nexthop

Network Next Hop Metric LocPref Weight Path
* > RD: 1.0.1.1:200 mac-ip 52de.3c26.a0b0 10.2.0.2
    1.0.1.1 - - 0 i
* > RD: 1.0.1.1:100 mac-ip 822c.0630.7ef4 10.1.0.2
    1.1.1.1 - - 0 i
    RD: 1.0.2.2:100 mac-ip 822c.0630.7ef4 10.1.0.2
    1.1.1.1 - 100 0 i
* > RD: 1.0.2.2:200 mac-ip 8650.1ecc.3595 10.2.0.3
    1.0.2.2 - 100 0 i
* > RD: 1.0.1.1:100 imet 1.1.1.1
    1.1.1.1 - - 0 i
* > RD: 1.0.1.1:200 imet 1.1.1.1
    1.1.1.1 - - 0 i
* > RD: 31000:300 ip-prefix 10.1.0.0/16
    - - - 0 i
* RD: 31000:300 ip-prefix 10.1.0.0/16
    1.0.2.2 - 100 0 i
```

Limitations

- BUM traffic is advertised on the MLAG VTEP IP. VXLAN flooded packets may be seen on the peer-link.
- The singly connected interfaces or non-MLAG interfaces have to be placed in an exclusive vlan that does not have any MLAG interface as a member.
- MLAG shared router MAC needs to be enabled to support symmetric IRB.
- For EVPN Type-5 setup, the VRF to VNI mapping must be configured on both VTEPs of the MLAG pair.
- For EVPN Type-5 setup as well as EVPN symmetric IRB setup, the VRF to VNI mapping must be configured to be the same across all the VTEPs in the network. That is, the same VRF must be mapped to the same value of VNI on all the VTEPs which participate in the EVPN network.

10.3.7 MLAG Implementation Example

This example creates an MLAG Domain, then configures MLAG connections between the peer switches and four Network Attached Devices (NADs). The MLAG switches connect through a LAG and communicate with the NADs through MLAGs. Although the NADs can be any device that supports LACP LAGs, the devices in this example are Arista switches.

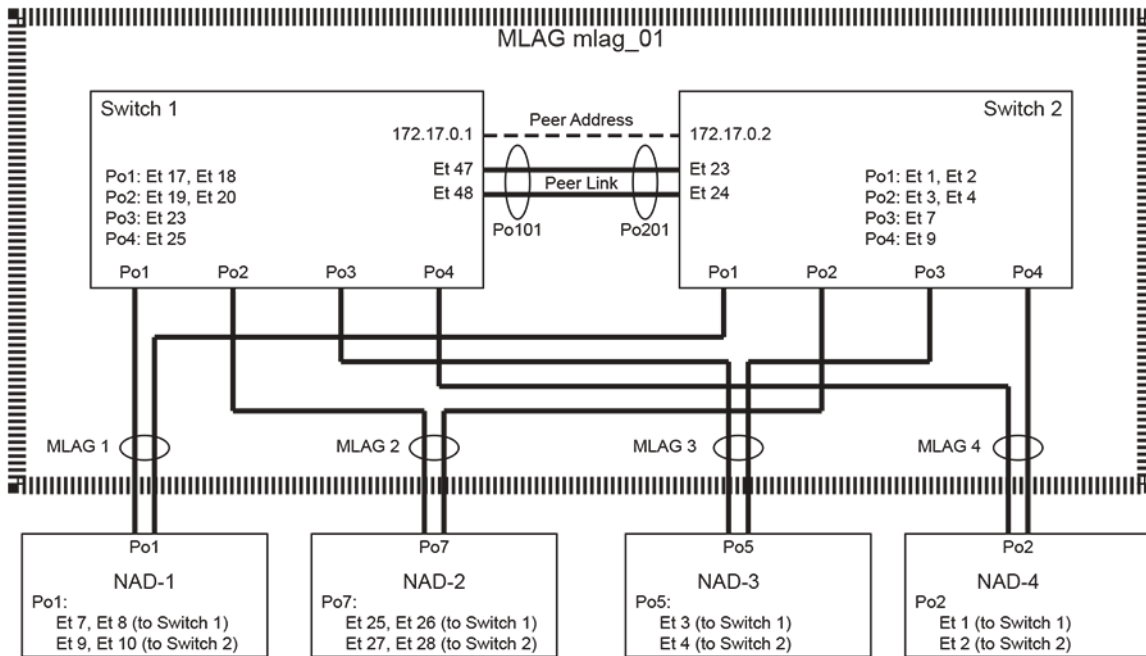

Figure 23: MLAG Implementation Example

10.3.7.1 Topology

Figure 23: MLAG Implementation Example displays the MLAG topology. Switch 1 and Switch 2 are MLAG peers that logically represent a single Layer 2 switch. The peer link between the switches contains the following interfaces:

- Switch 1: Ethernet 47, Ethernet 48
- Switch 2: Ethernet 23, Ethernet 24

The example configures MLAGs from the MLAG Domain to four network attached devices (NAD-1, NAD-2, NAD-3, NAD-4).

10.3.7.2 Configuring the Peer Switch Connections

To configure the switches in the described topology, perform the tasks in these sections:

- [Configuring the Peer Switch Port Channels](#)
- [Configuring the Peer Switch SVIs](#)
- [Configuring the Peer Links](#)

10.3.7.2.1 Configuring the Peer Switch Port Channels

These commands create the port channels the switches use to establish the peer link.

These commands create port channels on Switch1

```
switch1 (config) #interface ethernet 47-48
switch1 (config-if-et47-48) #channel-group 101 mode active
switch1 (config-if-et47-48) #interface port-channel 101
switch1 (config-if-po101) #switchport mode trunk
switch1 (config-if-po101) #switchport trunk group peertrunk
switch1 (config-if-po101) #exit
switch1 (config) #
```

These commands create port channels on Switch2

```
switch2(config)#interface ethernet 23-24
switch2(config-if-et23-24)#channel-group 201 mode active
switch2(config-if-et23-24)#interface port-channel 201
switch2(config-if-po201)#switchport mode trunk
switch2(config-if-po201)#switchport trunk group trunkpeer
switch2(config-if-po201)#exit
switch2(config)#
```

10.3.7.2.2 Configuring the Peer Switch SVIs

For each peer switch, these commands create an SVI and associate it to the trunk group assigned to the peer link port channel. STP is disabled on the VLAN.

These commands configure the SVI on Switch1

```
switch1(config)#vlan 4094
switch1(config-vlan-4094)#trunk group peertrunk
switch1(config-vlan-4094)#interface vlan 4094
switch1(config-if-vl4094)#ip address 172.17.0.1/30
switch1(config-if-vl4094)#no autostate
switch1(config-if-vl4094)#exit
switch1(config)#no spanning-tree vlan-id 4094
switch1(config)#
```

These commands configure the SVI on Switch2

```
switch2(config)#vlan 4094
switch2(config-vlan-4094)#trunk group trunkpeer
switch2(config-vlan-4094)#interface vlan 4094
switch2(config-if-vl4094)#ip address 172.17.0.2/30
switch2(config-if-vl4094)#no autostate
switch2(config-if-vl4094)#exit
switch2(config)#no spanning-tree vlan-id 4094
switch2(config)#
```

10.3.7.2.3 Configuring the Peer Links

These commands create the peer links on each MLAG switch.

These commands create peer links on Switch1

```
switch1(config)#mlog configuration
switch1(config-mlog)#local-interface vlan 4094
switch1(config-mlog)#peer-address 172.17.0.2
switch1(config-mlog)#peer-link port-channel 101
switch1(config-mlog)#domain-id mlag_01
switch1(config-mlog)#heartbeat-interval 2500
switch1(config-mlog)#reload-delay 150
switch1(config-mlog)#exit
switch2(config)#
```

These commands create peer links on Switch2

```
switch2(config)#mlog configuration
```

```
switch2(config-mlag) #local-interface vlan 4094
switch2(config-mlag) #peer-address 172.17.0.1
switch2(config-mlag) #peer-link port-channel 201
switch2(config-mlag) #domain-id mlag_01
switch2(config-mlag) #heartbeat-interval 2500
switch2(config-mlag) #reload-delay 150
switch2(config-mlag) #exit
switch2(config) #
```

10.3.7.3 Configuring the Network Attached Devices

These commands create the LAGs on the Network Attached Devices that connect to the MLAG domain.

These commands configure the port channels on NAD-1

```
NAD-1(config) #interface ethernet 7-10
NAD-1(config-if-Et7-10) #channel-group 1 mode active
NAD-1(config-if-Et7-10) #exit
NAD-1(config) #
```

These commands configure the port channels on NAD-2

```
NAD-2(config) #interface ethernet 25-28
NAD-2(config-if-Et25-28) #channel-group 7 mode active
NAD-2(config-if-Et25-28) #exit
NAD-2(config) #
```

These commands configure the port channels on NAD-3

```
NAD-3(config) #interface ethernet 3-4
NAD-3(config-if-Et3-4) #channel-group 5 mode active
NAD-3(config-if-Et3-4) #exit
NAD-3(config) #
```

These commands configure the port channels on NAD-4

```
NAD-4(config) #interface ethernet 1-2
NAD-4(config-if-Et1-2) #channel-group 2 mode active
NAD-4(config-if-Et1-2) #exit
NAD-4(config) #
```

10.3.7.4 Verification

The following tasks verify the MLAG peer and connection configuration:

- [Verify the Peer Switch Connection](#)
- [Verify the MLAGs](#)
- [Verify Spanning Tree Protocol \(STP\)](#)
- [Verify the MLAG Port Channel](#)
- [Verify the VLAN Membership](#)

10.3.7.4.1 Verify the Peer Switch Connection

To display the MLAG configuration and the MLAG status on Switch 1, use the [show mlag](#) command:

```
Switch1#show mlag
MLAG Configuration:
domain-id       :           mlag_01
local-interface :           Vlan4094
peer-address    :           172.17.0.2
peer-link       :           Port-Channel101

MLAG Status:
state           :           Active
peer-link status :           Up
local-int status :           Up
system-id      :           02:1c:FF:00:15:38

MLAG Ports:
Disabled        :           0
Configured      :           0
Inactive        :           0
Active-partial  :           0
Active-full     :           4
```

To display the MLAG configuration and the MLAG status on Switch 2, use the [show mlag](#) command:

```
Switch2#show mlag
MLAG Configuration:
domain-id       :           mlag_01
local-interface :           Vlan4094
peer-address    :           172.17.0.1
peer-link       :           Port-Channel102

MLAG Status:
state           :           Active
peer-link status :           Up
local-int status :           Up
system-id      :           02:1c:FF:00:15:41

MLAG Ports:
Disabled        :           0
Configured      :           0
Inactive        :           0
Active-partial  :           0
Active-full     :           4
```

10.3.7.4.2 Verify the MLAGs

The [show mlag interfaces](#) command displays MLAG connections between the MLAG switches and the Network Attached Devices.

- This [show mlag interfaces](#) command displays MLAG connections between the MLAG peer Switch 1 and the network attached devices:

```
switch1#show mlag interfaces
```

mlag	desc	state	local	remote	local/remote status
1	sw1.po1	active-full	Po1	Po1	up/up
2	sw1.po2	active-full	Po2	Po2	up/up
3	sw1.po3	active-full	Po3	Po3	up/up
4	sw1.po4	active-full	Po4	Po4	up/up

- The following `show mlag interfaces` command, with the detail option, displays MLAG connections between the MLAG peer Switch 1 and the network attached devices

```
Switch2#show mlag interfaces detail
      local/remote
mlag      state local remote   oper   config      last change  changes
-----
  1 active-full  Po1    Po1  up/up  ena/ena  6 days, 2:08:28 ago  5
  2 active-full  Po2    Po2  up/up  ena/ena  6 days, 2:08:30 ago  5
  3 active-full  Po3    Po3  up/up  ena/ena  6 days, 2:08:33 ago  5
  4 active-full  Po4    Po4  up/up  ena/ena  6 days, 2:08:41 ago  5
Switch2#
```

10.3.7.4.3 Verify Spanning Tree Protocol (STP)

STP functions can be displayed from each peer switch. MLAG interfaces are displayed as a single entry. Configured interfaces on each switch that are not included in an MLAG are displayed. Local interfaces have the normal notation; remote interfaces are preceded by **P** or **Peer**.

VLAN Output 1: Assume VLAN 3903 includes MLAG 1

```
switch1#show spanning-tree vlan-id 3903
Spanning tree instance for vlan 3903
VL3903
Spanning tree enabled protocol rapid-pvst
Root ID      Priority      36671
            Address      001c.730c.3009
            Cost        1999 (Ext) 0 (Int)
            Port        105 (Port-Channel5)
            Hello Time  2.000 sec  Max Age 20 sec  Forward Delay 15 sec

Bridge ID    Priority      36671 (priority 32768 sys-id-ext 3903)
            Address      021c.7300.1319
            Hello Time  2.000 sec  Max Age 20 sec  Forward Delay 15 sec

Interface    Role          State          Cost          Prio.Nbr Type
-----
Po1          root         forwarding    1999          128.105 P2p
switch1#
```

The output displays MLAG 1 under its local interface name (Po1). A peer interface is not displayed because spanning tree considers the local and remote Port Channels as a single MLAG interface.

VLAN Output 2: Assume VLAN 3908 does not include any MLAGs

```
switch1#show spanning-tree vlan-id 3908
Spanning tree instance for vlan 3908
VL3908
Spanning tree enabled protocol rapid-pvst
Root ID      Priority      36676
            Address      021c.7300.1319
            This bridge is the root

Bridge ID    Priority      36676 (priority 32768 sys-id-ext 3908)
            Address      021c.7300.1319
            Hello Time  2.000 sec  Max Age 20 sec  Forward Delay 15 sec

Interface    Role          State          Cost          Prio.Nbr Type
-----
Et17         designated forwarding 2000          128.217 P2p
Et18         designated forwarding 2000          128.218 P2p
PEt17        designated forwarding 2000          128.17  P2p
PEt18        designated forwarding 2000          128.18  P2p
```

The output displays all interfaces from both switches. Each interface is explicitly displayed because they are individual units that STP must consider when selecting ports to block.

- Et17 and Et18 are located on the switch where the `show spanning-tree` command is issued.
- PEt17 and PEt18 are located on the remote switch from where the command was issued

An identical command issued on the peer switch displays similar information.

Verify the MLAG does not create topology loops (show spanning-tree blocked)

```
switch1#show spanning-tree blocked
Name          Blocked Interfaces List
-----
Number of blocked ports (segments) in the system : 0
switch1#
```

10.3.7.4.4 Verify the MLAG Port Channel

Issue the command **show port-channel** for channels 1-4 from Switch 1:

```
Switch#show port-channel 1-4
Port Channel Port-Channel1:
  Active Ports: Ethernet17      Ethernet18      PeerEthernet1 PeerEthernet2
Port Channel Port-Channel2:
  Active Ports: Ethernet19      Ethernet20      Ethernet21      Ethernet22
                  PeerEthernet3 PeerEthernet4 PeerEthernet5 PeerEthernet6
Port Channel Port-Channel3:
  Active Ports: Ethernet23      Ethernet24      PeerEthernet7 PeerEthernet8
Port Channel Port-Channel4:
  Active Ports: Ethernet25      Ethernet26      PeerEthernet9 PeerEthernet1
0
```

Issue the command **show port-channel load-balance fields detailed** command for channel 1 from Switch 2:

```
Switch#show port-channel 1 detailed
Port Channel Port-Channel1:
  Active Ports:
    Port                                Time became active          Protocol    Mode
    -----
    Ethernet17                          7/7/11 15:27:36             LACP       Active
    Ethernet18                          7/7/11 15:27:36             LACP       Active
    PeerEthernet1                        7/7/11 15:27:36             LACP       Active
    PeerEthernet2                        7/7/11 15:27:36             LACP       Active
```

10.3.7.4.5 Verify the VLAN Membership

The **show vlan** command displays VLAN member ports, including MLAG ports and ports on each peer not bundled in an MLAG.

```
Switch1#show vlan 3903, 3908
VLAN  Name                               Status  Ports
-----
3903  ar.mg.rn.172.17.254.16/29             active  Cpu, Po1
3908  po.ra.ar.mg.172.17.254.64/29          active  Cpu, Et17, Et18, PEt17, PEt18
```

10.3.8 MLAG Commands

MLAG and Port Channel Commands – Global Configuration Mode

- [mlag configuration \(global configuration\)](#)

Interface Configuration Commands – Interface Configuration Mode

- [mlag \(port-channel interface configuration\)](#)

MLAG Configuration Commands

- [domain-id](#)
- [dual-primary detection delay](#)
- [dual-primary recovery delay](#)
- [heartbeat-interval \(MLAG\)](#)
- [local-interface](#)
- [peer-address](#)
- [peer-address heartbeat](#)
- [peer-link](#)
- [reload-delay mlag](#)
- [reload-delay mode](#)
- [reload-delay non-mlag](#)
- [shutdown \(MLAG\)](#)

Display Commands

- [show mlag](#)
- [show mlag interfaces](#)
- [show mlag interfaces members](#)
- [show mlag interfaces states](#)
- [show mlag issu warnings](#)

10.3.8.1 domain-id

The **domain-id** command specifies a name for the multi-chassis link aggregation (MLAG) domain.

The **no domain-id** and **default domain-id** commands remove the MLAG domain name by deleting the **domain-id** statement from *running-config*.

Command Mode

MLAG Configuration

Command Syntax

```
domain-id identifier
```

```
no domain-id
```

```
default domain-id
```

Parameters

identifier alphanumeric string that names the MLAG domain.

Example

This command names the MLAG domain *mlag1*.

```
switch(config) #mlag  
switch(config-mlag) #domain-id mlag1  
switch(config-mlag) #
```

10.3.8.2 dual-primary detection delay

Use the **dual-primary detection delay** command to configure a dual primary detection delay with an optional action to errdisable all interfaces on secondary MLAG peer after a dual primary condition is detected.

Command Mode

MLAG configuration mode

Command Syntax

```
dual-primary detection delay seconds [action errdisable all-interfaces]
no dual-primary detection delay seconds [action errdisable all-interfaces]
default dual-primary detection delay seconds [action errdisable all-interfaces]
```

Parameters

- **seconds** Dual primary detection delay in seconds.
- **action** Specifies the action when dual-primary is detected.
- **errdisable** Errdisable interfaces.
- **all-interfaces** Disables all Ethernet interfaces except the peer-link.

Examples

- In this example, the command errdisables all physical interfaces on secondary MLAG peer when dual primary condition is detected.

```
switch(config-mlag)#dual-primary detection delay 5 action errdisable
all-interfaces
```

Both MLAG peers must have equivalent configurations.

- The following command removes the Dual Primary Detection feature. You must unconfigure both MLAG peers.

```
switch(config-mlag)#no dual-primary detection
```

10.3.8.3 dual-primary recovery delay

Use the **dual-primary recovery delay** command to configure dual-primary detection recovery-delay for MLAG interfaces and non-MLAG interfaces. Negating the configurations or configuring default values makes both recovery delay values reset back to 0. The non-MLAG delay must always be less than the MLAG delay so you have more time for L3 convergence before enabling MLAG interfaces.

Command Mode

MLAG configuration mode

Command Syntax

```
dual-primary recovery delay mlag seconds non-mlag seconds
```

```
no dual-primary recovery delay mlag seconds non-mlag seconds
```

```
default dual-primary recovery delay mlag seconds non-mlag seconds
```

Parameters

- **mlag *seconds*** Delay in seconds after dual-primary detection resolves until non peer-link ports that are part of an MLAG are enabled. Range 0 - 1000 seconds. A suggested value for MLAG is 60 seconds. These values can be adjusted depending on the network scale.
- **non-mlag *seconds*** Delay in seconds after dual-primary detection resolves until ports that are not part of an MLAG are enabled. Range 0 - 1000 seconds. A suggested value for non-MLAG is 0 seconds. These values can be adjusted depending on the network scale.

Example

```
switch(config)#mlag  
switch(config0mlag)#dual-primary recovery delay mlag 60 non-mlag 0
```

10.3.8.4 heartbeat-interval (MLAG)

The `heartbeat-interval` command configures the interval at which heartbeat messages are issued in a multi-chassis link aggregation (MLAG) configuration.

The `no heartbeat-interval` and `default heartbeat-interval` commands revert the heartbeat interval to the default setting by removing the `heartbeat-interval` command from *running-config*.

Command Mode

MLAG Configuration

Command Syntax

```
heartbeat-interval period
no heartbeat-interval
default heartbeat-interval
```

Parameters

period Interval duration (ms). Value ranges from 1000 through 30000 milliseconds. Default interval is 2000 milliseconds.

Guidelines

Heartbeat messages flow independently in both directions between the MLAG peers. If a peer stops receiving heartbeat messages within the expected time frame (30 seconds), the other peer can assume it no longer functions and without intervention or repair, the MLAG becomes disabled. Both switches revert to their independent state.

 **Note:** On 7500 and 7500E Series Switches, Arista recommends setting the heartbeat interval to 10 seconds.

Example

This command configures the heartbeat interval to 15000 milliseconds:

```
switch(config) #mlag
switch(config-mlag) #heartbeat-interval 15000
switch(config-mlag) #
```

10.3.8.5 local-interface

The **local-interface** command assigns a VLAN interface for use in multi-chassis link aggregation (MLAG) configurations. The VLAN interface is used for both directions of communication between the MLAG peers.

The **no local-interface** and **default local-interface** commands delete the VLAN interface assignment by removing the **local-interface** command from **running-config**.

Command Mode

MLAG Configuration

Command Syntax

```
local-interface vlan vlan_number
```

```
no local-interface
```

```
default local-interface
```

Parameters

vlan_number VLAN number, in the range from 1 through 4094.

Guidelines

When configuring the local interface, the VLAN interface must exist already. To configure a VLAN interface, issue the command **interface vlan**.

Example

This command assigns **VLAN 4094** as the local interface.

```
switch(config)#mlag
switch(config-mlag)#local-interface vlan 4094
switch(config-mlag)#
```

10.3.8.6 mlag (port-channel interface configuration)

The **mlag** command assigns an MLAG ID to a port-channel. MLAG peer switches form an MLAG when each switch configures the same MLAG ID to a port-channel interface. Only one MLAG ID can be assigned to an interface. An individual MLAG number cannot be assigned to more than one interface.

The **no mlag** and **default mlag** commands remove the MLAG ID assignment from the configuration mode interface by deleting the corresponding **mlag** command from **running-config**.

Command Mode

Interface-Port Channel Configuration

Command Syntax

mlag *number*

no mlag

default mlag

Parameters

number Number used as MLAG ID. Value ranges from 1 to 2000.

Example

These commands configure a port channel and assign it MLAG 4.

```
switch(config)#interface ethernet 5-10
switch(config-if-Et5-10)#channel-group 1 mode active
switch(config-if-Et5-10)#interface port-channel 4
switch(config-if-Po4)#switchport trunk group group4
switch(config-if-Po4)#mlag 4
switch(config-if-Po4)#exit
switch(config)#
```

10.3.8.7 peer-address

The **peer-address** command specifies the peer IPv4 address for a multi-chassis link aggregation (MLAG) domain. MLAG control traffic, including keepalive messages, is sent to the peer IPv4 address. If the peer IPv4 address is unreachable, then MLAG peering fails and both peer switches revert to their independent state.

The **no peer-address** and **default peer-address** commands remove the MLAG peer's IPv4 address assignment by deleting the peer-address command from **running-config**.

Command Mode

MLAG Configuration

Command Syntax

```
peer-address ipv4_addr
```

```
no peer-address
```

```
default peer-address
```

Parameters

ipv4_addr MLAG peer IPv4 address.

Example

These commands configure the MLAG peer address.

```
switch(config)#m1ag
switch(config-m1ag)#peer-address 10.0.0.2
switch(config-m1ag)#
```

10.3.8.8 peer-address heartbeat

The peer-address heartbeat command causes the MLAG agent to start using **Peer-IP** address in the given VRF for UDP-based heartbeat control messages.

To enable MLAG dual primary detection feature, the command must be configured on both MLAG peers in the MLAG config mode.

Command Mode

MLAG configuration mode

Command Syntax

```
peer-address heartbeat Peer-IP [vrf vrf_name]
```

```
no peer-address heartbeat Peer-IP [vrf vrf_name]
```

```
default peer-address heartbeat Peer-IP [vrf vrf_name]
```

Parameters

- **Peer-IP** The Management IP address of the MLAG peer reachable in the VRF **VRF-NAME** (or default VRF if there is no VRF configured).
- **vrf vrf_name** Named VRF.

Examples

- ```
switch(config)#mlag
switch(config-mlag)#peer-address heartbeat 172.30.118.190
```

- This example removes the feature.

```
switch(config-mlag)#no peer-address heartbeat
```

### 10.3.8.9 peer-link

The **peer-link** command specifies the interface that connects multi-chassis link aggregation (MLAG) peers. To form an MLAG, two switches are connected through an interface called a peer link. The peer link carries control and data traffic between the two switches. Control traffic includes MLAG-related advertisements and keepalive messages. This information keeps the two switches working as one.

The **no peer-link** and **default peer-link** command remove the peer link by deleting the **peer-link** command from *running-config*.

#### Command Mode

MLAG Configuration

#### Command Syntax

```
peer-link INT_NAME
```

```
no peer-link
```

```
default peer-link
```

#### Parameters

**INT\_NAME** denotes the interface type and number of the interface. Values include:

- **ethernet e\_num** Ethernet interface range specified by **e\_num**.
- **port-channel p\_num** Channel group interface range specified by **p\_num**.

#### Example

These commands creates a peer link.

```
switch(config)#mlag configuration
switch(config-mlag)#peer-link port-channel 10
switch(config-mlag)
```

---

### 10.3.8.10 mlag configuration (global configuration)

The **mlag configuration** command enters MLAG configuration mode to configure multi-chassis link aggregation (MLAG) features. MLAG configuration mode is not a group change mode; **running-config** is changed immediately after commands are executed. The **exit** command does not affect the configuration.

The **no mlag configuration** and **default mlag configuration** commands remove all MLAG configuration commands from **running-config**.

The **exit** command returns the switch to global configuration mode.

#### Command Mode

Global Configuration

#### Command Syntax

```
mlag configuration
```

```
no mlag configuration
```

```
default mlag configuration
```

**mlag** and **mlag configuration** are identical commands.

#### Guidelines

An MLAG is formed by connecting two switches through an interface called a peer link. The peer link carries control and data traffic between the switches, including advertisements and keepalive messages. This information coordinates the switches. Functioning peers are in the **active** state.

Each peer switch uses IP-level connectivity between their local addresses and the MLAG peer IP address to form and maintain the peer link.

#### Commands Available in MLAG Configuration Mode

- [domain-id](#)
- [heartbeat-interval \(MLAG\)](#)
- [local-interface](#)
- [peer-address](#)
- [peer-link](#)
- [reload-delay mlag](#)
- [shutdown \(MLAG\)](#)

#### Example

These commands enter MLAG configuration mode and configure MLAG parameters:

- ```
switch(config)#mlag
switch(config-mlag)#local-interface vlan 4094
switch(config-mlag)#peer-address 10.0.0.2
switch(config-mlag)#peer-link port-channel 10
switch(config-mlag)#domain-id mlagDomain
switch(config-mlag)#heartbeat-interval 2500
switch(config-mlag)#reload-delay 2000
switch(config-mlag)#exit
switch(config)#
```

10.3.8.11 reload-delay mlag

The `reload-delay mlag` command configures the reload delay period for MLAG links. The command also specifies the reload delay period for non-MLAG links when the `reload-delay non-mlag` command is not configured.

Each Arista switch defaults to the recommended reload-delay value, which varies by switch platform:

- **Fixed configuration switches:** 300 seconds
- **Trident II modular switches:** 1200 seconds
 - 7304
 - 7308
 - 7316
 - 7300X series
- **Sand platform fixed configuration switches:** 600 seconds
 - 7280 series
- **Sand platform modular switches:** 1800 seconds
 - 7504
 - 7508
 - 7500E series
 - 7548S

The `no reload-delay mlag` and `default reload-delay mlag` commands restore the default value by deleting the `reload-delay mlag` statement from *running-config*.

Command Mode

MLAG Configuration

Command Syntax

```
reload-delay [mlag] PERIOD
no reload-delay [mlag]
default reload-delay [mlag]
```

Parameters

- **PERIOD** Period that non-peer links are disabled after an MLAG peer reboots. Options include:
 - `infinity` link is not enabled after reboot.
 - `0` to **86400** disabled link interval (seconds). Default varies by switch platform as described above.

Guidelines

The `reload-delay` and `reload-delay mlag` commands are equivalent.

Example

These commands configure the reload-delay interval to 15 minutes.

```
switch(config)#mlag configuration
switch(config-mlag)#reload-delay mlag 900
switch(config-mlag)#
```

10.3.8.12 reload-delay mode

The **reload-delay mode** command specifies the state of LACP LAG ports during the MLAG reload delay period. By default, MLAG ports remain in the errdisabled state during reload delay. This command configures MLAG ports to come up to standby mode before the expiration of the reload delay period.

The **no reload-delay mode** and **default reload-delay mode** commands restore the default behavior of MLAG ports by deleting the **reload-delay mode** statement from *running-config*. The default behavior is for the MLAG ports to remain in the errdisabled state until the expiration of the reload delay period

Command Mode

MLAG Configuration

Command Syntax

```
reload-delay mode lacp standby
```

```
no reload-delay mode
```

```
default reload-delay mode
```

Related Commands

reload-delay mlag configures the MLAG reload delay period.

Example

These commands configure the MLAG port to come up to standby state before the end of the reload delay period.

```
switch(config)#mlag configuration  
switch(config-mlag)#reload-delay mode lacp standby  
switch(config-mlag)#
```

10.3.8.13 reload-delay non-mlag

The **reload-delay non-mlag** command specifies the period that non-MLAG links are disabled after an MLAG peer reboots. This interval allows non-peer links to learn multicast and OSPF states before the ports start handling traffic. The recommended minimum value required to ensure the forwarding hardware is initialized with the topology state depends on the switch platform:

- Fixed configuration switches: 300 seconds (five minutes)
- Sand platform fixed configuration switches (7280 series): 600 seconds (ten minutes)
- Modular switches: 1200 seconds (twenty minutes)

When the **reload-delay non-mlag** command is not configured, the **reload-delay mlag** command specifies the reload delay time for non-MLAG and MLAG links.

The **no reload-delay non-mlag** and **default reload-delay non-mlag** command restores the default behavior by deleting the **reload-delay non-mlag** statement from *running-config*.

Command Mode

MLAG Configuration

Command Syntax

```
reload-delay non-mlag PERIOD
no reload-delay non-mlag
default reload-delay non-mlag
```

Parameters

- **PERIOD** Period that non-MLAG links are disabled after an MLAG peer reboots. Options include:
 - **infinity** links are not enabled after reboot.
 - **0 to 86400** disabled link interval (seconds). Values range from 0 to 86400 (24 hours).

Example

These commands configure the reload-delay interval of non-MLAG links to 20 minutes.

```
switch(config)#mlag configuration
switch(config-mlag)#reload-delay non-mlag 1200
switch(config-mlag)#
```

10.3.8.14 show mlag interfaces members

The **show mlag interfaces members** command displays information about the multi-chassis link aggregation (MLAG) members on bridged Ethernet interfaces.

Command Mode

EXEC

Command Syntax

```
show mlag interfaces members
```

Example

This command displays the MLAG interface members.

```
switch#show mlag interface members
Mlag4 is Port-Channel4
  Active Ports: Ethernet3 PeerEthernet3
Mlag5 is Port-Channel5
  Active Ports: Ethernet14
Mlag7 is Port-Channel7
  Active Ports: Ethernet5 PeerEthernet5
Mlag8 is Port-Channel8
  Active Ports: Ethernet10 PeerEthernet10
Mlag9 is Port-Channel9
  Active Ports: Ethernet15 Ethernet21 PeerEthernet19 PeerEthernet20
Mlag10 is Port-Channel10
  Active Ports: Ethernet19 Ethernet20 PeerEthernet21 PeerEthernet22
switch#
```

10.3.8.15 show mlag interfaces states

The **show mlag interfaces states** command displays information about the multi-chassis link aggregation (MLAG) states on bridged Ethernet interfaces.

Command Mode

EXEC

Command Syntax

```
show mlag interfaces [MLAGS] states [ STATE_NAMES][INFO_LEVEL]
```

Parameters

- **MLAGS** MLAG channels for which command displays data. Options include:
 - **no parameter** command displays data for all MLAGs.
 - **mlag_id** specifies MLAG for which command displays data. Value ranges from 1 to 2000.
- **STATE_NAMES** MLAG channels for which command displays data. Parameter may specify more than one name, which can be listed in any order. Valid state names include:
 - **active-full** includes active-full interfaces.
 - **active-partial** includes active-partial interfaces.
 - **configured** includes configured interfaces.
 - **disabled** includes disabled interfaces.
 - **inactive** includes inactive interfaces.
- **INFO_LEVEL** specifies information displayed by command. Options include:
 - **no parameter** command displays basic MLAG interface parameters
 - **detail** command displays detailed MLAG interface state parameters.

Example

This command displays the MLAG interface states that are active-full.

```
switch#show mlag interfaces states active-full
```

mlag	desc	state	local	remote	local/remote status
4	b.po1	active-full	Po4	Po4	up/up
7	ar.mg.au.po1	active-full	Po7	Po7	up/up
8	co.po1	active-full	Po8	Po8	up/up
9	k.po5	active-full	Po9	Po9	up/up
10	ar.mg.pt.ir.po10	active-full	Po10	Po10	up/up

```
switch#
```

10.3.8.16 show mlag interfaces

The **show mlag interfaces** command displays information about the multi-chassis link aggregation (MLAG) configuration on bridged Ethernet interfaces.

Command Mode

EXEC

Command Syntax

```
show mlag interfaces [MLAGS][INFO_LEVEL]
```

Parameters

- **MLAGS** MLAG channels for which command displays data. Options include:
 - **no parameter** command displays data for all MLAGs.
 - **mlag_id** specifies MLAG for which command displays data. Value ranges from 1 to 2000.
- **INFO_LEVEL** specifies information displayed by command. Options include:
 - **no parameter** command displays basic MLAG interface parameters
 - **detail** command displays detailed MLAG interface parameters.

Example

This command displays output from the **show mlag interfaces detail** command:

```
switch>show mlag interfaces detail
```

mlag	state	local	remote	local/remote oper	config	last change	changes
4	active-full	Po4	Po4	up/up	ena/ena	6 days, 1:19:26 ago	5
5	active-full	Po5	Po5	up/up	ena/ena	6 days, 1:19:24 ago	5
6	active-full	Po6	Po6	up/up	ena/ena	6 days, 1:19:23 ago	5
7	active-full	Po7	Po7	up/up	ena/ena	6 days, 1:19:23 ago	5

10.3.8.17 show mlag issu warnings

The **show mlag issu warnings** command displays a warning message regarding the backward-compatibility of this feature before you upgrade.

Command Mode

EXEC

Command Syntax

```
show mlag issu warnings
```

Example

This command displays the MLAG backward-compatibility warning message. Refer to the latest version of the release notes for additional information before you upgrade.

```
switch##show mlag issu warnings  
If you are performing an upgrade, and the Release Notes for the new  
version of EOS indicate that MLAG is not backwards-compatible with the  
currently installed version, the upgrade will result in packet loss.  
  
Stp is not restartable. Topology changes will occur during the upgrade  
process.  
  
switch#
```

10.3.8.18 show mlag

The **show mlag** command displays information about the multi-chassis link aggregation (MLAG) configuration on bridged Ethernet interfaces.

Command Mode

EXEC

Command Syntax

```
show mlag [INFO_LEVEL]
```

Parameters

INFO_LEVEL specifies information displayed by command. Options include:

- **no parameter** command displays MLAG configuration, status, and ports.
- **detail** command displays MLAG configuration, status, ports, and detailed status.

Example

This command displays output from the **show mlag** command:

```
switch>show mlag
MLAG Configuration:
domain-id       :          ar.mg.mlag
local-interface :          Vlan3901
peer-address    :          172.17.254.2
peer-link       :          Port-Channell

MLAG Status:
state           :          Active
peer-link status :          Up
local-int status :          Up
system-id      :          02:1c:73:00:13:19

MLAG Ports:
Disabled       :          0
Configured     :          0
Inactive       :          0
Active-partial :          0
Active-full    :          5
switch>
```

10.3.8.19 shutdown (MLAG)

The **shutdown** command disables MLAG on the switch without modifying the MLAG configuration.

The **no shutdown** and **default shutdown** commands re-enable MLAG by removing the **shutdown** command from *running-config*.

Command Mode

MLAG Configuration

Command Syntax

```
shutdown
```

```
no shutdown
```

```
default shutdown
```

Example

These commands disable MLAG on the switch.

```
switch(config)#mlag configuration  
switch(config-mlag)#shutdown  
switch(config-mlag)#
```

10.4 Data Transfer

Arista switches support the transfer of packets (network layer) and frames (data link layer). This chapter describes concepts and processes that are referenced by routing and switching protocols that Arista switches support.

Sections in this chapter include:

- [Data Transfer Introduction](#)
- [Data Transfer Methods](#)
- [MAC Address Table](#)
- [Configuring Ports](#)
- [Monitoring Links](#)
- [PHY test pattern CLI](#)
- [Data Transfer Commands](#)

10.4.1 Data Transfer Introduction

Arista switches transfer data through switching, routing, and Layer 3 switching. This chapter provides an introduction to these transfer methods.

Data structures and processes that support data transfer methods and referenced in specific protocol chapters are also described, including:

- routed ports
- switched ports
- MAC address table
- port mirroring
- storm control
- loopback interfaces
- route redistribution
- null0 interfaces
- MTUs

10.4.2 Data Transfer Methods

This section describes these data transfer methods:

- [Switching and Bridging](#)
- [Routing](#)
- [Layer 3 Switching](#)

10.4.2.1 Switching and Bridging

Switching and bridging operations transmit data link layer frames between devices within a single subnet. Each port is assigned a 48 bit Media Access Control (MAC) address. Frames arriving at a hub are bridged, or sent to all other ports on the subnet. Switches can associate ports with their MAC addresses, obviating the need to flood the subnet when sending a frame.

Subnets in the switch are defined by VLANs. A virtual local area network (VLAN) is a group of devices that are configured to communicate as if they are attached to the same network regardless of their physical location. **VLANs** describes VLANs.

Four MAC address types identify the scope of LAN interfaces that an address represents:

- unicast: represents a single interface.
- broadcast: represents all interfaces.

- multicast: represents a subset of all interfaces.
- reserved: assigned to nodes that have no configured MAC address.

The Individual/Group (I/G) bit distinguishes unicast MAC addresses from multicast addresses. As shown in [Figure 24: MAC Address Format](#), the I/G bit is the least significant bit of the most significant byte in a MAC address.

10.4.2.1.1 MAC Address Format

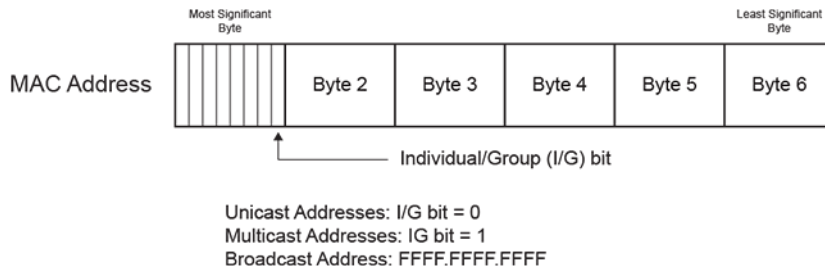

Figure 24: MAC Address Format

- Unicast address: the I/G bit is **0**: **1234.1111.1111** is a unicast MAC address (the most significant byte is an even number).
 - Reserved address: all bits set to **0 (0000.0000.0000)**.
- Multicast address: the I/G bit is **1**: **1134.1111.1111** is a multicast MAC address (the most significant byte is an odd number).
- Broadcast address: all bits set to **1 (FFFF.FFFF.FFFF)**.

Example

- The following are unicast MAC addresses:

```
0200.0000.0000
1400.0000.0000
```

- The following are multicast MAC addresses:

```
0300.0000.0000
2500.0000.0000
```

The following sections describe MAC address functions and data structures:

- [Assigning a MAC Address to an Interface](#)
- [MAC Address Table](#)

10.4.2.2 Routing

Routing transmits network layer packets over connected independent subnets. Each subnet is assigned an IP address range and each device on the subnet is assigned an IP address from that range. Connected subnets have IP address ranges that do not overlap. A router connects multiple subnets. Routers forward inbound packets to the subnet whose address range includes the packets' destination address.

IPv4 and IPv6 are internet layer protocols that facilitate packet-switched networking, including transmissions across multiple networks.

These chapters describe available IP features:

- [IPv4](#)

-
- [IPv6](#)

10.4.2.2.1 Static Routing

Static routes are entered through the CLI and are typically used when dynamic protocols are unable to establish routes to a specified destination prefix. Static routes are also useful when dynamic routing protocols are not available or appropriate.

Creating a static route associates a destination IP address with a local interface. The routing table refers to these routes as **connected** routes that are available for redistribution into routing domains defined by dynamic routing protocols.

These sections describe static route configuration commands:

- [IPv4 Address Configuration](#)
- [Configuring Default and Static IPv6 Routes](#)

10.4.2.2.2 Dynamic Routing

Dynamic routes are established by dynamic routing protocols. These protocols also maintain the routing table and modify routes to adjust for topology or traffic changes. Routing protocols assist the switch in communicating with other devices to exchange network information, maintaining routing tables, and establishing data paths.

The switch supports these dynamic routing protocols:

- [Open Shortest Path First – Version 2](#)
- [Open Shortest Path First – Version 3](#)
- [Border Gateway Protocol \(BGP\)](#)
- [Routing Information Protocol](#)
- [IS-IS](#)

10.4.2.3 Layer 3 Switching

Layer 3 switches establish data paths through routing processes (Layer 3) and transfer data as a switch (Layer 2) through speed-optimized hardware. Layer 3 switches use a control plane (routing) and data plane (switching) to manage these processes.

10.4.2.3.1 Control plane

The control plane builds and maintains the IP routing table, which identifies IP packet routes in terms of destination addresses. The routing table defines a route by its next hop address and the egress interface that accesses the next hop.

The control plane derives routing information from three sources:

- Status of physical and virtual interfaces on the switch.
- Static routes entered through the CLI.
- Routes established through dynamic routing protocols.

Applying an ACL to the Control Plane

The control plane supports routing and management functions, handling packets that are addressed to the switch without regard to any switch interface.

To apply an IP ACL to the control plane, enter [ip access-group \(Control Plane mode\)](#) in control-plane mode. The [system control-plane](#) command places the switch in control-plane mode.

[ACLs and Route Maps](#) describes access control lists.

Example

These commands place the switch in control-plane mode and assigns **CP-Test1** to the control plane.

```
switch(config)#system control-plane
switch(config-system-cp)#ip access-group CP-Test1 in
switch(config-system-cp)#
```

10.4.2.3.2 Data plane

The data plane routes IP packets based on information derived by the control plane. Each packet's path includes Layer 2 addresses that reach its next hop destination. The data plane also performs other operations required by IP routing, such as recalculating IP header checksums and decrementing the time-to-live (TTL) field.

Arista data planes support these packet forwarding modes:

- Store and forward: the switch accumulates entire packets before forwarding them.
- Cut through: the switch begins forwarding frames before their reception is complete.

Cut through mode reduces switch latency at the risk of decreased reliability. Packet transmissions can begin immediately after the destination address is processed. Corrupted frames may be forwarded because packet transmissions begin before CRC bytes are received.

Packet forwarding mode availability varies by switch platform:

- **Arad**: store and forward mode only
- **FM6000**: both modes are available.
- **Petra**: store and forward mode only
- **Trident**: both modes are available.
- **Trident II**: both modes are available.

The data plane is also referred to as the forwarding plane.

Data Plane Forwarding Mode Configuration

The [switch forwarding-mode](#) command specifies the forwarding mode of the switch's data plane. This command is available on Trident, Trident II, and FM6000 platform switches. The forwarding mode is **store-and-forward** on Arad and Petra platform switches.

Example

This command changes the forwarding mode to **store-and-forward**.

```
switch(config)#switch forwarding-mode store-and-forward
switch(config)#
```

The [show switch forwarding-mode](#) command displays the switch's forwarding mode.

Example

This command displays the switch's forwarding mode.

```
switch(config)#show switch forwarding-mode
Current switching mode:    store and forward
Available switching modes: cut through, store and forward
```

10.4.3 MAC Address Table

The switch maintains a MAC address table for switching frames efficiently between ports. The MAC address table contains static and dynamic MAC addresses.

- Static MAC addresses are entered into the table through a CLI command.
- Dynamic MAC addresses are entered into the table when the switch receives a frame whose source address is not listed in the MAC address table. The switch builds the table dynamically by referencing the source address of frames it receives.

10.4.3.1 MAC Address Table Configuration

These sections describe MAC address table configuration tasks.

- [Static MAC Address Table Entries](#)
- [Dynamic MAC Address Table Entries](#)

10.4.3.1.1 Static MAC Address Table Entries

The MAC address table accepts static MAC addresses, including multicast entries. Each table entry references a MAC address, a VLAN, and a list of layer 2 (Ethernet or port channel) ports. The table supports three entry types: unicast drop, unicast, and multicast.

- A drop entry does not include a port.
- A unicast entry includes one port.
- A multicast entry includes at least one port.

Packets with a MAC address (source or destination) and VLAN specified by a drop entry are dropped. Drop entries are valid for only unicast MAC addresses.

The `mac address-table static` command adds a static entry to the MAC address table.

Examples

- This command adds a static entry for unicast MAC address 0012.3694.03ec to the MAC address table.

```
switch(config)#mac address-table static 0012.3694.03ec vlan 3 interface
Ethernet
7
switch(config)#show mac address-table static
      Mac Address Table
-----
Vlan    Mac Address      Type      Ports      Moves      Last Move
----    -
3       0012.3694.03ec  STATIC    Et7
Total Mac Addresses for this criterion: 1

      Multicast Mac Address Table
-----
Vlan    Mac Address      Type      Ports
----    -
Total Mac Addresses for this criterion: 0

switch(config)#
```

- This command adds the static entry for the multicast MAC address 0112.3057.8423 to the MAC address table.

```
switch(config)#mac address-table static 0112.3057.8423 vlan 4
interface
port-channel 10 port-channel 12
switch(config)#show mac address-table
Mac Address Table
-----
Vlan      Mac Address      Type      Ports      Moves      Last Move
----      -
Total Mac Addresses for this criterion: 0

Multicast Mac Address Table
-----
Vlan      Mac Address      Type      Ports
----      -
4         0112.3057.8423   STATIC    Po10 Po12
Total Mac Addresses for this criterion: 1
switch(config)#
```

10.4.3.1.2 Dynamic MAC Address Table Entries

Learning Mode

The switch maintains a MAC address table for switching frames efficiently between VLAN ports. When the switch receives a frame, it associates the MAC address of the transmitting interface with the recipient VLAN and port. When MAC address learning is enabled for the recipient port, the entry is added to the MAC address table. When MAC address learning is not enabled, the entry is not added to the table.

The [switchport mac address learning](#) command enables MAC address learning for the configuration mode interface. MAC address learning is enabled by default on all Ethernet and port channel interfaces.

Example

These commands disables MAC address learning for Ethernet interface 8, then displays the active configuration for the interface.

```
switch(config)#interface ethernet 8
switch(config-if-Et8)#no switchport mac address learning
switch(config-if-Et8)#show active
interface Ethernet8
no switchport mac address learning
switch(config-if-Et8)#
```

Aging Time

Aging time defines the period an entry is in the table, as measured from the most recent reception of a frame on the entry's VLAN from the specified MAC address. The switch removes entries when their presence in the MAC address table exceeds the aging time.

Aging time ranges from 10 to 1,000,000 seconds with a default of 300 seconds (five minutes).

Example

This command sets the MAC address table aging time to two minutes (120 seconds).

```
switch(config)#mac address-table aging-time 120
switch(config)#
```

The `mac address-table aging-time` command configures the aging time for MAC address table dynamic entries. Aging time defines the period an entry is in the table, as measured from the most recent reception of a frame on the entry's VLAN from the specified MAC address. The switch removes entries when their presence in the MAC address table exceeds the aging time.

Mac Moves

Secure MAC addresses is allowed to move when they appear on another interface, when configured. By default, secure MAC addresses does not move.

```
switch(config)# default switchport port-security mac address moveable
switch(config)#
```

Persistent Port Security

When the persistent PortSec-Protect is enabled, secure MAC addresses persist across device reboots and interface flaps. These MAC addresses can still be aged or moved when configured using the commands `mac address-table aging-time` and `default switchport port-security mac address moveable`. Persistent port security is enabled by default, and can be disabled.

```
switch(config)# default switchport port-security persistence disabled
```

Example

`show port-security` command displays the settings for the new global port security configurations, including MAC aging, MAC moves, and persistent port security.

```
switch(config)#show port-security
Secure address moves: disabled
Secure address aging: disabled
Secure address reboot persistence: enabled
Secure address link down persistence: enabled
Secure Port MaxSecureAddr CurrentAddr SecurityViolation Security
Action
                (Count)          (Count)          (Count)
-----
-----
-----
-----
Total Addresses in System: 0
```

Clearing Dynamic Addresses

The `clear mac address-table dynamic` command removes specified dynamic entries from the MAC address table. Entries are identified by their VLAN and layer 2 (Ethernet or port channel) interface.

Example

This command clears all dynamic mac address table entries for port channel 5 on VLAN 34.

```
switch(config) #clear mac address-table dynamic vlan 34 interface port-
channel 5
switch(config)
```

10.4.3.2 Displaying the MAC Address Table

The `show mac address-table` command displays the specified MAC address table entries.

Example

This command displays the MAC address table.

```
switch#show mac address-table
      Mac Address Table
-----
Vlan    Mac Address      Type      Ports      Moves      Last Move
----    -
101     001c.8224.36d7   DYNAMIC   Po2         1          9 days, 15:57:28 ago
102     001c.8220.1319   STATIC    Po1
102     001c.8229.a0f3   DYNAMIC   Po1         1          0:05:05 ago
661     001c.8220.1319   STATIC    Po1
661     001c.822f.6b22   DYNAMIC   Po7         1          0:20:10 ago
3000    001c.8220.1319   STATIC    Po1
3000    0050.56a8.0016   DYNAMIC   Po1         1          0:07:38 ago
3909    001c.8220.1319   STATIC    Po1
3909    001c.822f.6a80   DYNAMIC   Po1         1          0:07:08 ago
3911    001c.8220.1319   STATIC    Po1
3911    001c.8220.40fa   DYNAMIC   Po8         1          1:19:58 ago
3912    001c.822b.033e   DYNAMIC   Et11        1          9 days, 15:57:23 ago
3913    001c.8220.1319   STATIC    Po1
3913    001c.822b.033e   DYNAMIC   Po1         1          0:04:35 ago
3984    001c.8220.178f   DYNAMIC   Et8         1          4 days, 15:07:29 ago
3992    001c.8220.1319   STATIC    Po1
3992    001c.8221.07b9   DYNAMIC   Po6         1          4 days, 15:13:15 ago
Total Mac Addresses for this criterion: 24

      Multicast Mac Address Table
-----
Vlan    Mac Address      Type      Ports
----    -
Total Mac Addresses for this criterion: 0
```

Beginning with **EOS Release 4.26.0F**, **PortSec-Protect** enforces a limit on the number of MAC addresses, that can be learn. For example, **PortSec-Protect** is configured with a maximum of 1, `show mac address-table` shows a single address installed.

```
switch#show mac address-table
      Mac Address Table
-----
Vlan    Mac Address      Type      Ports      Moves      Last Move
----    -
101     001c.8224.36d7   DYNAMIC   Po2         1          9 days, 15:57:28 ago
Total Mac Addresses for this criterion: 1
```

10.4.3.3 MAC Address Learning Per-VLAN

MAC address learning per-VLAN enables or disables MAC address learning per-VLAN instead of per-port. When MAC address learning is enabled for the recipient port, the entry is added to the MAC address table. When MAC address learning is disabled, the entry is not added to the table.

10.4.3.3.1 Platform Compatibility

- DCS-7500E
- DCS-7280

10.4.3.3.2 MAC Address Learning Configuration

The [mac address learning](#) command enables MAC address learning on a VLAN interface. By default, MAC address learning on a VLAN is enabled.

The switch maintains a MAC address table for switching frames between VLAN ports. When the switch receives a frame, it associates the MAC address of the transmitting interface with the recipient VLAN and port. When MAC address learning is enabled for the recipient port, the entry is added to the MAC address table. When MAC address learning is not enabled, the entry is not added to the table.

To disable MAC learning on a particular VLAN, use `no mac address learning` command on a VLAN configuration.

Examples

- These commands enable MAC address learning on *VLAN 10* configuration.

```
switch(config)#vlan 10
switch(config-vlan-10)#mac address learning
```

- These commands disable MAC address learning on *VLAN 10* configuration.

```
switch(config)#vlan 10
switch(config-vlan-10)#no mac address learning
```

10.4.4 Configuring Ports

This section describes these port properties:

- [Port Mirroring](#)
- [Storm Control](#)
- [Switched and Routed Ports](#)
- [Loopback Ports](#)
- [MAC Security](#)
- [Null0 Interface](#)
- [Maximum Transmission Units \(MTU\)](#)

10.4.4.1 Port Mirroring

Port mirroring, also known as port monitoring, is the duplication of traffic from a collection of source ports to a destination port. A mirror session correlates a set of source ports to a destination port.

Valid mirror sources are Ethernet or port channel interfaces, including port channels which are part of an MLAG. Mirror destination ports are usually Ethernet interfaces; port channel destination ports are also supported on some platforms.

 **Note:** On platforms which support the use of port channels as mirror destinations, a port channel *must not* be used as a mirror destination if it is a member of an MLAG.

Layer 2 control protocols do not run on destination ports. An interface cannot be in more than one mirror session and cannot simultaneously be a source and destination. By default, mirror sessions duplicate ingress and egress traffic but are configurable to mirror traffic from only one direction.

- **Ingress Mirroring:** Packets received by a source port are duplicated, including all valid data frames and L2 control PDUs. Ports mirror data before forwarding logic is applied. Packets subsequently dropped because of forwarding decisions are mirrored.
- **Egress Mirroring:** Packets transmitted by a source port are duplicated, with these exceptions:
 - **Flooded/Multicast Packets:** Packets sent to multiple mirror ports generate one copy, except in multi-chip devices when the mirror source and destination ports are on different chips; in this case, an extra copy is generated.
 - **Dropped Packets:** Packets dropped by forwarding decisions (such as output STP state checks) on egress sources are not duplicated. Packets dropped because of congestion may be duplicated.
- **Filtered Mirroring:** Specific packets are selected for mirroring based on PERMIT and DENY configurations.
- **Mirroring to GRE Tunnel:** Mirrored packets are encapsulated with GRE protocols for transiting Layer 3 network.

VLAN tags on duplicate packets from an egress source are identical to tags on inbound source packets.

When a packet's path through the switch includes multiple mirror source ports in different mirror sessions, the traffic is duplicated once and sent to the destination of the highest numbered session.

10.4.4.1.1 Port Mirroring Capacity

Port mirroring capacity varies by platform. This section describes session limits for each platform.

FM6000 Platform Switches

- **Maximum Number of Sessions:** 4
- **Session Sources:** Ethernet interfaces (any number), Port channel interfaces (any number)
- **Session Destinations:** Ethernet interfaces (any number), Port channel interfaces (any number), CPU
- Egress IP ACL on destination port is not supported

Sessions can mirror Rx, Tx, or both ways without impacting the number of available sessions.

Enabling each of the following features reduces the number of available sessions by one: ACL Logging, MLAG Peer Link, sFlow, VTEP Learning (VXLAN), LANZ Sampling

Arad Platform Switches

- **Maximum Number of Sessions:** 14
- **Session Sources:** Ethernet interfaces (any number), Port channel interfaces (any number)
- **Session Destinations:** Ethernet interfaces (one)
- Egress IP ACL on destination port is not supported

Sessions can mirror Rx, Tx, or both ways without impacting number of available sessions.

Although the number of configured source interfaces is unlimited, the number of interfaces that can be effectively mirrored is restricted by the destination port speed.

Petra Platform Switches

- **Maximum Number of Sessions:** 16
- **Session Sources:** Ethernet interfaces (eight for Rx or Tx sessions; four for both ways)
- **Session Destinations:** Ethernet interfaces (eight for Rx or Tx sessions; four for both ways)
- Egress IP ACL on destination port is not supported

Sessions can mirror Rx, Tx, or both ways without impacting number of available sessions.

Trident Platform Switches

- **Maximum Number of Sessions:** 2
- **Session Sources:** Ethernet interfaces (any number), Port channel interfaces (any number)
- **Session Destinations:** Ethernet interfaces (one)
- Egress IP ACL on destination port is supported

Mirroring Rx or Tx requires one session. Mirroring both ways requires two sessions.

Trident II Platform Switches

- **Maximum Number of Sessions:** 2 per chip
- **Session Sources:** Ethernet interfaces (any number), Port channel interfaces (any number)
- **Session Destinations:** Ethernet interfaces (one)
- Egress IP ACL on Destination Port is supported

Mirroring Rx or Tx requires one session. Mirroring both ways requires two sessions.

10.4.4.1.2 Configuring Mirror Ports

Mirror sessions associate a set of source ports to a destination port using the [monitor session source](#) and [monitor session destination](#) commands. An interface cannot be used in more than one mirror session and cannot be simultaneously a source and a destination. By default, mirror sessions duplicate ingress and egress traffic but are configurable to mirror traffic from one direction. On Trident and Trident II platform switches (DCS-7050, DCS-7050X, DCS-7250X, and DCS-7300X series), all frames mirrored on egress are prefixed with an 802.1Q VLAN tag, even when the egress port is configured as an access port. If the capture device cannot process VLAN tags properly, mirroring should be configured exclusively for ingress traffic by specifying **rx** in the [monitor session source](#) command.

Filtering on TX traffic in a mirror session is not supported.

Example

These commands configure **Ethernet interface 7** as the source port and **Ethernet interface 8** as the destination port for the **redirect_1** mirroring session. The session mirrors ingress and egress traffic.

```
switch(config)#monitor session redirect_1 source ethernet 7
switch(config)#monitor session redirect_1 destination ethernet 8
```

The [show monitor session](#) command displays the configuration of the specified port mirroring session.

Example

This command shows the configuration of the **redirect_1** mirroring session.

```
switch(config)#show monitor session

Session redirect_1
-----

Source Ports

  Both:          Et7

Destination Port: Et8

switch(config)#
```

The [monitor session ip access-group](#) command configures an ACL to filter the traffic being mirrored to the destination port.

Example

These commands create an ACL and apply it to filter the traffic mirrored to the destination port by session *redirect_1*.

```
switch(config)#ip access-list allow-host
switch(config-acl-allow-host)#10 permit ip host 192.168.11.24 host
10.0.215.23
switch(config-acl-allow-host)#20 deny ip any any
switch(config-acl-allow-host)#exit
switch(config)#monitor session redirect_1 ip access-group allow-host
switch(config)#
```

10.4.4.1.3 Configuring Filtered Mirroring

Filtered mirroring allows for configuring IPv4, IPv6, and MAC access lists and then updating a monitor session with corresponding configuration changes. EOS mirrors the packets that match permit statements. EOS does not select those packets for mirroring that match deny statements.

 **Note:** EOS supports all standard IPv4, IPv6, and MAC qualifiers.

On Strata series platforms, packets from a single monitor source can be mirrored in multiple sessions that use the same access-list. You can attach multiple monitor sources with various access-lists to a monitor session. Each monitor session should contain one access-list type only. Hence, IPv4, IPv6, and MAC access-lists from the same monitor source must appear in different monitor sessions.

When multiple IPv6 monitor sessions share the same monitor source, only one of the monitor sessions remains active and others are automatically inactivated. When the active monitor session is removed from the monitor source, the system automatically activates the inactive monitor sessions.

Packets matching both IP and MAC access lists behave differently on various platforms.

Platform Series	Behavior of Filtered Mirroring
DCS-7050/7050X, DCS-7250X, and DCS-7300X	When entry packets match both IPv4 and MAC access-lists, mirrored copies are created for both IPv4 and MAC access-lists; and forwarded to configured destinations.
DCS-7280SE and DCS-7500E	When entry packets match both IPv4 and MAC access-lists, a mirrored copy is created only for IPv4 access-list. The behavior of filtered mirroring varies in the following ways when a packet matches an entry in both access-list types: <ul style="list-style-type: none"> • Mirroring is permitted when a packet contradicts with permit and deny configurations. • Mirroring is denied when an entry packet matches deny configurations in both. • IP access-list is prioritized over MAC access-list when an entry packet matches permit configurations in both.

 **Note:** User-Defined Field (UDF) qualifiers in filtered mirroring access-lists allow matching packets using arbitrary user-defined patterns.

Use the **system profile** command to enable the Mirroring ACL profile that supports matching on IPv6, MAC and UDFs.

The following table provides the matching types supported in default and Mirroring ACL profiles.

Profiles	IPv4	IPv6	MAC	UDF

Default	Yes	No	No	No
Mirroring ACL	Yes	Yes	Yes	Yes

 **Note:** MAC mirroring-ACLs do not accept routed IPv4/IPv6 packets and bridged IPv6 packets.

Examples

- These commands create an IPv4 access-list and then attach the access-list to monitor sessions.

```
switch(config)#ip access-list acl1
switch(config-acl-acl1)#10 permit tcp any any rst
switch(config-acl-acl1)#20 permit tcp any any syn
switch(config-acl-acl1)#30 permit tcp any any ack

switch(config)#monitor session 1 source Ethernet1 rx ip access-group
acl1
switch(config)#monitor session 1 source Ethernet2 rx ip access-group
acl1
switch(config)#monitor session 1 destination <destination>
```

- These commands create an IPv6 access-list and then attach the access-list to monitor sessions.

```
Arista(config)#ipv6 access-list acl2
Arista(config-ipv6-acl-acl2)#10 permit ipv6 any any

Arista(config)#monitor session 2 source Ethernet4 rx ipv6 access-group
acl2
Arista(config)#monitor session 2 destination Ethernet5
```

- These commands configure the same monitor source in multiple monitor sessions.

```
switch(config)#monitor session 1 source Ethernet1 rx ip access-group
acl1
switch(config)#monitor session 1 destination <destination 1>

switch(config)#monitor session 2 source Ethernet1 rx ip access-group
acl2
switch(config)#monitor session 2 destination <destination 2>
```

- This command configures access-list priorities for dictating the matching order across multiple access-lists that are attached to the same monitor source.

```
switch(config)#monitor session 1 source Ethernet1 rx ip access-group
acl1
priority 1
switch(config)#monitor session 1 destination <destination 1>

switch(config)#monitor session 2 source Ethernet1 rx ip access-group
acl2
priority 2
switch(config)#monitor session 2 destination <destination 2>
```

- This command enables the Mirroring ACL profile.

```
switch(config)#hardware tcam
switch(config-hw-tcam)#system profile mirroring-acl
switch(config-hw-tcam)#show hardware tcam profile
Configuration          Status
FixedSystem            mirroring-acl         mirroring-acl
switch(config-hw-tcam)#
```

10.4.4.1.4 Filtered Mirroring to CPU

Filtered mirroring to CPU adds a special destination to port mirroring that allows mirrored traffic to be sent to the switch supervisor. The traffic can then be monitored and analyzed locally without the need of a remote port analyzer. Filtered mirroring to CPU can also be used for debugging and troubleshooting configured to mirror RX traffic, TX traffic or both, with up to 14 mirroring profiles used simultaneously. In addition, mirroring to CPU uses control plane protection to limit the rate of the traffic sent to the CPU.

Examples

- These commands configure the source for normal mirroring and the destination to CPU.

```
switch(config)#monitor session mySession source ethernet 3/1 both
switch(config)#monitor session mySession destination cpu
switch(config)#
```

- These commands configure reserved bandwidth and shape rate of mirrored traffic.

```
switch(config)#policy-map type copp copp-system-policy
switch(config-pmap-control-plane-copp-system-policy)#class
copp-system-mirroring
switch(config-pmap-c-copp-system-policy-copp-system-
mirroring)#bandwidth kbps
2000
switch(config-pmap-c-copp-system-policy-copp-system-mirroring)#shape
kbps 4000
switch(config-pmap-c-copp-system-policy-copp-system-mirroring)#
```

- These commands show the current status of mirroring to CPU from the CLI, and display the control plane protection configuration for mirroring to CPU.

```
switch(config)#show monitor session

                Session mySession
                -----
                Source Ports:

                Both : Et3/1

                Destination Ports:

                Cpu : active (mirror0)

switch(config)#
```

- These commands show the current status of mirroring to CPU from the CLI, and display the control plane protection configuration for mirroring to CPU.

```
switch(config)#show policy-map type copp copp-system-policy class
copp-system-mirroring

                Class-map: copp-system-mirroring (match-any)

                shape : None

                bandwidth : None

switch(config)#
```

10.4.4.1.5 Configuring Filtered Mirroring to GRE Tunnel

The `monitor session source` and `monitor session destination` commands configure source and destination ports to the specified port mirroring session in a GRE tunnel.

Selected platforms support forwarding-drop destination, a special GRE tunnel destination for mirroring ingress packets that are dropped during ASIC forwarding. The `monitor session forwarding-drop` command configures forwarding-drop sessions.

 **Note:** Forwarding-drop sessions are the sessions corresponding to forwarding-drop destinations.

 **Note:** From release 4.25.2F onwards platforms DCS-7050X, DCS-7060X, DCS-7250X, DCS-7260X, CCS-720X started supporting the `tx` keyword, which specifies that outgoing packets should be mirrored.

Examples

- These commands configure ingress filtered mirroring to a GRE tunnel.

```
switch(config)#monitor session abc source Ethernet1 rx ip access-group
acl1
switch(config)#monitor session abc destination tunnel mode gre source
1.1.1.1
destination 2.2.2.2 ttl 128 dscp 0 protocol 0x88be
```

- These commands configure egress filtered mirroring to a GRE tunnel.

```
switch(config)#monitor session abc source Ethernet1 tx ip access-group
acl1
switch(config)#monitor session abc destination tunnel mode gre source
2.2.2.2
destination 2.2.2.2 ttl 128 dscp 0 protocol 0x88be
```

- This command configures forwarding-drop sessions.

```
switch(config)#monitor session 1 forwarding-drop destination tunnel
mode gre source 1.1.1.1 destination 2.2.2.2
```

10.4.4.1.6 Security ACL Filtered Mirroring

Security ACL Filtered Mirroring is configured using port security ACLs.

Configuring Security ACL Filtered Mirroring

The following configures Ethernet interface 8 as the destination port for the `redirect_1` mirroring session, and Ethernet interface 9 as the destination port for the `redirect_2` mirroring session. A source port is not needed to create a mirror session. Other destination options for monitor sessions such as GRE or CPU are also configurable.

```
switch (config)# monitor session redirect_1 destination ethernet 8
switch (config)# monitor session redirect_2 destination ethernet 9
```

Examples

Egress IPv4 ACL

The following commands create an IPv4 access-list, and then attach the access-list to Ethernet interface 7 in the out direction with the following rules.

- matching Rule 10 will be mirrored to ***Ethernet interface 8***.

- matching Rule 20 will not be mirrored.
- matching Rule 30 will be mirrored to **Ethernet interface 9**.
- matching Rule 40 will be dropped and not mirrored.

Specifying a mirror session in a deny rule for egress ACL has no effect.

```
switch(config)#ip access-list acl1
switch(config-acl-acl1)#10 permit ip host 10.0.0.4 any mirror session
redirect_1
switch(config-acl-acl1)#20 permit ip host 10.0.0.5 any
switch(config-acl-acl1)#30 permit ip host 10.0.0.6 any mirror session
redirect_2
switch(config-acl-acl1)#40 deny ip any any

switch(config)#interface ethernet 7
switch(config-if-Et7)#ip access-group acl1 out
```

 **Note:** Security ACL Filtered Mirroring has higher priority over standard Port Mirroring.

Using the same configuration as above with **Ethernet interface 7** as the source port of **redirect_1**, the following configuration displays the impact on packets egressing from **Ethernet interface 7**.

```
switch(config)#monitor session redirect_1 source ethernet 7
```

- matching Rule 10 and Rule 20 will be mirrored to **Ethernet interface 8**.
- matching Rule 30 will be mirrored to **Ethernet interface 9**.
- matching Rule 40 will be dropped and not mirrored.

Egress IPv6 ACL

The following commands create an IPv6 access-list, and then attach the access-list to interface ethernet 7 in the egress direction.

```
switch(config)#ipv6 access-list acl1
switch(config-ipv6-acl-acl1)#10 permit ipv6 host 10:10:10:10:10:10:10:1
any mirror session redirect1
switch(config-ipv6-acl-acl1)#20 permit ipv6 host 10:10:10:10:10:10:10:5
any
switch(config-ipv6-acl-acl1)#30 permit ipv6 host 10:10:10:10:10:10:10:6
any mirror session redirect2
switch(config-ipv6-acl-acl1)#40 deny ipv6 any any

switch(config)#interface ethernet 7
switch(config-if-Et7)#ipv6 access-group acl1 out
```

 **Note:** The mirroring behavior of egress IPv6 ACL is identical to egress IPv4 ACL. The egress IPv6 ACL is supported only on R3 Series and forward.

Egress MAC ACL

The following commands create a MAC access-list, and then attach the access-list to **Ethernet interface 7** in the out direction. The mirroring behavior of egress MAC ACL is identical to egress IPv4 ACL.

```
switch(config)#mac access-list acl1
switch(config-mac-acl-acl1)#10 permit 0000.1111.4444 0000.0000.0000 any
mirror session redirect_1
switch(config-mac-acl-acl1)#20 permit 0000.1111.5555 0000.0000.0000 any
switch(config-mac-acl-acl1)#30 permit 0000.1111.6666 0000.0000.0000 any
mirror session redirect_2
switch(config-mac-acl-acl1)#40 deny any any
```

```
switch(config)#interface ethernet 7
switch(config-if-Et7)#mac access-group acl1 out
```

Ingress IPv4 ACL

The following commands create an IPv4 access-list, and then attach the access-list to **Ethernet interface 7** in the in direction with the following rules.

- matching Rule 10 and Rule 20 will be mirrored to **Ethernet interface 8**.
- matching Rule 30 will be mirrored to **Ethernet interface 9** since Security ACL Filtered Mirroring has higher priority.
- matching Rule 40 will be dropped and mirrored to **Ethernet interface 8**.

```
switch(config)#ip access-list acl2
switch(config-acl-acl2)#10 permit ip host 10.0.0.4 any mirror session
  redirect_1
switch(config-acl-acl2)#20 permit ip host 10.0.0.5 any
switch(config-acl-acl2)#30 permit ip host 10.0.0.6 any mirror session
  redirect_2
switch(config-acl-acl2)#40 deny ip host 10.0.0.7 any mirror session
  redirect_1

switch(config)#interface ethernet 7
switch(config-if-Et7)#ip access-group acl2 in

switch(config)#monitor session redirect_1 source ethernet 7
```

 **Note:** Unlike egress ACL, mirror session specified in a deny rule for ingress ACL will take effect.

The mirroring behavior of ingress IPv6 and MAC ACLs are identical to ingress IPv4 ACL.

Limitations

- The feature is not supported in AlgoMatch mode.
- Egress Security ACL Filtered Mirroring works on IPv4 - permit rules, and MAC - permit rules.
- By default, egress MAC ACL is disabled. Egress MAC ACL is required to be enabled.
- By default, bridged traffic is not subject to Egress IP ACLs, therefore, the bridged packets will not be mirrored.
- RACL and subinterface ACL are not supported for filtering mirroring.
- If a packet is dropped by an ingress ACL and the destination is GRE, the metadata of the GRE packet cannot be computed as expected.

10.4.4.2 Storm Control

A traffic storm is a flood of packets entering a network, resulting in excessive traffic and degraded performance. Storm control prevents network disruptions by limiting traffic beyond specified thresholds on individual physical LAN interfaces.

Storm control monitors inbound traffic levels over one-second intervals and compares the traffic level with a specified benchmark.

Storm control has three modes:

- **Storm control all:** When inbound traffic exceeds the specified threshold within a one-second control interval, all traffic is dropped until the end of the interval.
- **Storm control broadcast:** When inbound broadcast traffic exceeds the specified threshold within a one-second control interval, broadcast traffic is dropped until the end of the interval.

- **Storm control multicast:** When inbound multicast traffic exceeds the specified threshold within a one-second control interval, multicast traffic is dropped until the end of the interval.

Broadcast and multicast storm control are independent features and can be enabled simultaneously. The `storm control all` threshold overrides broadcast and multicast thresholds.

Storm Control Configuration

The `storm-control` command configures and enables broadcast or multicast storm control on the configuration mode interface. The command provides three mode options:

- **storm-control all** unicast, multicast, and broadcast inbound packet control.
- **storm-control broadcast** broadcast inbound packet control.
- **storm-control multicast** multicast inbound packet control.

An interface configuration can contain three storm-control statements, one with each mode setting. The `storm-control all` threshold overrides broadcast and multicast thresholds.

When storm control is enabled, the switch monitors inbound traffic levels over one second intervals and compares the traffic level with a specified threshold. The threshold is a percentage of the total available port bandwidth and is configurable on each interface for each transmission mode.

Examples

- These commands enable multicast storm control on Ethernet interfaces 2 through 4 and set a threshold of 65%. During each one second interval, the interface drops inbound multicast traffic in excess of 65% of capacity.

```
switch(config)#interface ethernet 2 / 3 / 4
switch(config-if-Et4/4/4)#storm-control multicast level 65
switch(config-if-Et4/4/4)#
```

- These commands clear multicast storm control on Ethernet interfaces 2 through 4.

```
switch(config)#interface ethernet 2 / 3 / 4
switch(config-if-Et2/3/4)#no storm-control multicast
switch(config-if-Et2/3/4)#
```

- These commands enable broadcast storm control on Ethernet interfaces 2 through 4 and set broadcast traffic to 50%. During each one second interval, the interface drops inbound multicast traffic in excess of 50% of capacity.

```
switch(config)#interface ethernet 2 / 3 / 4
switch(config-if-Et2/3/4)#storm-control broadcast level 50
switch(config-if-Et2/3/4)#
```

- These commands enable broadcast storm control on Ethernet interfaces 2 through 4 and set a threshold of 5000 packets per second (pps).

```
switch(config)#interface ethernet 2 / 3 / 4
switch(config-if-Et2/3/4)#storm-control broadcast level pps 5000
switch(config-if-Et2/3/4)#
```

- These commands clear broadcast storm control on Ethernet interfaces 2 through 4.

```
switch(config)#interface ethernet 2 / 3 / 4
switch(config-if-Et2/3/4)#no storm-control broadcast
switch(config-if-Et2/3/4)#
```

The `show storm-control` command displays the storm-control level and interface inbound packet capacity for the specified interface.

Example

This command displays the storm control configuration for Ethernet ports 2 through 4.

```
switch(config-if-Et2/3/4) #show storm-control
Port          Type          Level  Units  Rate (Mbps)  Status  Drops  Reason
Et2/3/4       all           75.00  %      7500         active  0
              multicast     55.00  %      5500         active  0
              broadcast     50.00  %      5000         active  0
switch(config-if-Et2/3/4) #
```

10.4.4.3 Switched and Routed Ports

A switched port is an Ethernet or port channel interface that is configured as a Layer 2 interface. Switched ports bridge frames and are assigned to at least one VLAN. Switched ports are not associated with any IP addresses. By default, Ethernet and port channel interfaces are in switched port mode.

A routed port is an Ethernet or port channel interface that is configured as a Layer 3 interface. Routed ports do not bridge frames and are not members of any VLANs. Routed ports can have IP addresses assigned to them and packets are routed directly to and from the port.

Configuring an interface as a routed port is similar to creating a VLAN with spanning-tree disabled, making the port the only member of that VLAN and configuring the IP address on the switch virtual interface (SVI) associated with the VLAN.

All IP-level interface configuration commands, except **autostate** and **ip virtual-router**, can be used to configure a routed interface. If the interface is reverted to switched port mode, **running-config** maintains IP level interface configuration statements. These changes become active again if the interface is configured back to routed port mode.

A LAG that is created with the **channel-group** command inherits the mode of the member port. A LAG created from a routed port becomes a routed LAG. IP-level configuration is not propagated to the LAG from its component members.

The broadcast queue towards the CPU is shared among all interfaces of the forwarding chip. Broadcast storm on a single port adversely impacts other interfaces of the same chip by potentially dropping even low rate broadcast frames. Routed port storm control attempts to mitigate this effect by performing storm control on the broadcast frames for routed ports.

Routed Port Configuration

The switching-routing configuration of Ethernet and port channel interfaces is specified by the **switchport** and **no switchport** commands. These commands only toggle the interface between switched and routed modes. They have no effect on other configuration states.

The no switchport command places the configuration mode interface in **routed port** mode. Routed ports behave as Layer 3 interfaces. They do not bridge packets and are not VLAN members. An IP address can be assigned to a routed port for the direct routing of packets to and from the interface.

When an interface is configured as a routed port, the switch transparently allocates an internal VLAN whose only member is the routed interface. Internal VLANs are created in the range from 1006 to 4094. VLANs that are allocated internally for a routed interface cannot be directly created or configured. [Allocating Internal VLANs](#) describes VLAN allocation configuration procedures.

Example

This command places **Ethernet interface 5** in routed port mode.

```
switch(config) #interface ethernet 5
```

```
switch(config-if-Et5) #no switchport
```

Switched Port Configuration

The switchport command places the configuration mode interface in **switched port (Layer 2)** mode. Switched ports are configurable as members of one or more VLANs through other switchport commands. Switched ports ignore all IP level configuration commands, including IP address assignments. By default, Ethernet and port channel interfaces are switched ports.

Example

This command places **Ethernet interface 5** in switched port mode.

```
switch(config) #interface ethernet 5
switch(config-if-Et5) #switchport
```

The switchport default mode routed command places the configuration mode interface for a switch with all ports in **switched port (Layer 3) routed** mode, changing the switch with all ports from **switchport default mode access**.

Examples

- This command places a switch with all ports in routed mode.

```
switch(config) #switchport default mode routed
```

- This command places a switch with all ports in access mode.

```
switch(config) #switchport default mode access
```

10.4.4.4 Loopback Ports

A loopback interface is a virtual network interface implemented in software and does not connect to any hardware. Traffic sent to the loopback interface is immediately received on the sending interface. The switch provides loopback configuration mode for creating loopback interfaces and modifying their operating parameters.

Internet protocols reserve specific addresses for loopback network segments:

- IPv4 designates 127/8 as loopback subnet, which includes **127.0.0.0** through **127.255.255.255**.
- IPv6 designates ::1/128 as the loopback address, which includes **0:0:0:0:0:0:0:1** (also written as ::1).

Arista switches support the configuration of 1001 loopback interfaces, numbered from **0** to **1000**.

Loopback Interface Configuration

Loopback ports are instantiated by entering loopback interface mode for the desired port number. Loopback interface mode also provides access to loopback configuration commands. Previously instantiated ports are edited by entering loopback interface mode for the specified port.

The [interface loopback](#) command places the switch in interface-loopback configuration mode for the specified interfaces, creating loopback interfaces for each specified port not previously created.

Example

These commands instantiate **loopback interface 2** and assigns it IP address **10.1.1.42/24**.

```
switch(config) #interface loopback 2
```

```
switch(config-if-Lo2) #ip address 10.1.1.42
switch(config-if-Lo2) #show active
interface Loopback2
    ip address 10.1.1.42/24
switch(config-if-Lo2) #
```

10.4.4.5 MAC Security

MAC security restricts input to a switched port by limiting the number of MAC addresses that can access the port. Ports with MAC security enabled restrict traffic to a limited number of hosts, as determined by their MAC addresses. When the limit is exceeded, the port becomes errdisabled.

Port Security Configuration

MAC address security is enabled by `switchport port-security`. The default MAC address limit on an interface where port security is enabled is one; to change that default limit, use the `switchport port-security mac-address maximum` command.

Example

These commands enable MAC security on **Ethernet interface 7**, set the maximum number of assigned MAC addresses to 2, assign two static MAC addresses to the interface, and clear the dynamic MAC addresses for the interface.

```
switch(config) #interface ethernet 7
switch(config-if-Et7) #switchport port-security
switch(config-if-Et7) #switchport port-security mac-address maximum 2
switch(config-if-Et7) #exit
switch(config) #mac address-table static 0034.24c2.8f11 vlan 10 interface ethernet
7
switch(config) #mac address-table static 4464.842d.17ce vlan 10 interface ethernet
7
switch(config) #clear mac address-table dynamic interface ethernet 7
switch(config) #show port-security
Secure Port          MaxSecureAddr  CurrentAddr  SecurityViolation  Security Action
                   (Count)         (Count)         (Count)
-----
    Et7                2                2                0                Shutdown
-----
Total Addresses in System: 1
switch(config) #show port-security mac-address
Secure Mac Address Table
-----
Vlan    Mac Address          Type                Ports    Remaining Age
-----
    10    0034.24c2.8f11      SecureConfigured    Et7      N/A
    10    4464.842d.17ce      SecureConfigured    Et7      N/A
-----
Total Mac Addresses for this criterion: 2
switch(config) #
```

10.4.4.6 Null0 Interface

The **null0 interface** is a virtual interface that drops all inbound packets. A null0 route is a network route whose destination is **null0 interface**. Inbound packets to a null0 interface are not forwarded to any valid address. Many interface configuration commands provide **null0** as an interface option.

10.4.4.7 Maximum Transmission Units (MTU)

The MTU of a communications protocol refers to the size in bytes of the largest frame (Ethernet) or packet (IP) that can be sent on the network.

Different protocols support a variety of MTU sizes. Most IP over Ethernet implementations use the Ethernet V2 frame format, which specifies an MTU of 1500 bytes. Jumbo frames are Ethernet frames containing more than 1500 bytes.

10.4.4.7.1 Switching interface MTU size

On Arista devices, layer two interfaces (either trunk or access ports) are set with a default ethernet MTU of 9236 bytes. This value cannot be changed and is derived as follows: 9214 + 6 (source MAC) + 6 (dst MAC) + 4 (VLAN tag) + 2 (ether type) + 4 (crc) totals 9236 bytes.

The output of a `show interfaces` command for a layer two interface displays the following:

Trunk

```
Ethernet1 is up, line protocol is up (connected)
  Hardware is Ethernet, address is 001c.731c.5073 (bia 001c.731c.5073)
Ethernet MTU 9214 bytes , BW 1000000 kbit
```

Access

```
Ethernet3 is up, line protocol is up (connected)
  Hardware is Ethernet, address is 001c.731c.5075 (bia 001c.731c.5075)
Ethernet MTU 9214 bytes , BW 1000000 kbit
```

10.4.4.7.2 Routing Interface MTU Size

The MTU size on Layer 3 interfaces varies between a minimum of 68 to the maximum 9214 bytes. The default size is 1500 bytes. The `show interface` output for a Layer 3 interface displays the following:

VLAN routed interface

```
Vlan100 is up, line protocol is up (connected)
  Hardware is Vlan, address is 001c.731c.5072 (bia 001c.731c.5072)
  Internet address is 10.1.1.2/24
  Broadcast address is 255.255.255.255
  Address determined by manual configuration
IP MTU 9214 bytes
```

Physical routed interface

```
Ethernet4 is down, line protocol is down (connect)
  Hardware is Ethernet, address is 001c.731c.5072
  Internet address is 10.10.10.10/24
  Broadcast address is 255.255.255.255
  Address determined by manual configuration
IP MTU 9214 bytes
```

A routed interface fragments packets that exceed the configured IP MTU on the interface. For example, if a 2000 byte packet is received on routed interface 1 and is forwarded from routed interface 2 then routed interface 2 fragments the packet into a 1500 byte packet plus an additional packet containing the remaining data. This fragmentation should be avoided by configuring a consistent IP MTU across all systems within the operational domain.

The IP MTU set on a routed interface is valid for both IPv4 and IPv6 packets.

MTU Configuration

The `mtu` command configures the IPv4 and IPv6 Maximum Transmission Unit (MTU) size for the configuration mode interface. An interface's MTU value is displayed with the `show interface` command. The command is valid for all routable interfaces.

Examples

- This command sets the MTU size of **1492** bytes on **VLAN interface 20**.

```
switch(config-if-Vl20)#mtu 1492
switch(config-if-Vl20)#
```

- This command displays status for a routed interface.

```
switch(config-if-Et3)#show interface e3
Ethernet3 is up, line protocol is up (connected)
  Hardware is Ethernet, address is 001c.731c.5072
  Internet address is 10.1.1.2/24
  Broadcast address is 255.255.255.255
  Address determined by manual configuration
  IP MTU 1500 bytes , BW 1000000 kbit
  Full-duplex, 1Gb/s, auto negotiation: on, uni-link: unknown
  Up 22 days, 7 hours, 47 minutes, 58 seconds
switch(config)#
```

- Using ping on a Linux host, you can test the maximum transmission through the interface.

```
[user@linux ~]$ ping -M do -s 1472 10.1.1.2
PING 10.1.1.2 (10.1.1.2) 1472(1500) bytes of data.
1480 bytes from 10.1.1.2: icmp_seq=1 ttl=64 time=0.206 ms
1480 bytes from 10.1.1.2: icmp_seq=2 ttl=64 time=0.191 ms
--- 10.1.1.2 ping statistics ---
2 packets transmitted, 2 received, 0% packet loss, time 999ms
rtt min/avg/max/mdev = 0.191/0.198/0.206/0.015 ms
```

The size 1472 has 8 bytes of ICMP information added and 20 bytes of IP headers added, generating a total packet size of 1500 bytes.

- The option '-M do' specifies that fragmentation is prohibited for this test.
- The option '-s' specifies the size of the packet being generated.
- A capture of the frame displays total length of 1514 bytes on the wire which includes the Ethernet headers and type field.

10.4.5 Monitoring Links

This section describes link monitoring and object tracking processes:

- [Object Tracking](#)
- [Errdisabled Ports](#)
- [Error Disable Detect Cause for ACL](#)
- [Configuring Error Disable Recovery Interval for each Cause](#)
- [Link Flap Monitoring](#)
- [Fabric Link Monitoring](#)
- [Rapid Automated Indication of Link-Loss](#)

10.4.5.1 Object Tracking

Object tracking makes it possible for the switch to take action in response to changes in specific switch properties by creating an object to track those properties. When the tracked property changes, the object then changes state, allowing configured agents to react accordingly.

Object Tracking Configuration

The `track` command creates an object that changes state to reflect changes in a specific switch property. Agents configured to track that object are then able to react to the change.

Example

These commands create an object that tracks the line protocol state on **Ethernet interface 8**, then configures **Ethernet interface 5** to disable VRRP when that tracked object changes state to **down**.

```
switch(config)#track ETH8 interface ethernet 8 line-protocol
switch(config)#interface ethernet 5
switch(config-if-Et5)#vrrp 1 tracked-object ETH8 shutdown
switch(config-if-Et5)#
```

These commands use object tracking:

- [link tracking group](#)
- [vrrp tracked-object](#)

10.4.5.2 Errdisabled Ports

The switch places an Ethernet or management interface in **error-disabled** state when it detects an error on the interface. **Error-disabled** is an operational state that is similar to link-down state. Conditions that error-disable an interface include:

- bpduguard
- link-flap
- no-internal-vlan
- portchannelguard
- portsec
- tapagg
- uplink-failure-detection
- xcvr_unsupported

Most conditions are programmed by the configuration of other features, such as Spanning Tree protocol (bpduguard). Link flap error-disabling is configured through errdisable commands or link flap monitor commands ([Link Flap Monitoring](#)).

Error-disabled interfaces are recovered either through manual or automated methods.

To manually recover an interface, enter its configuration mode and execute `shutdown` and `no shutdown` commands.

Example

These commands manually recover Ethernet interface 30 from the errdisable state.

```
switch(config)#interface ethernet 30
switch(config-if-Et30)#shutdown
switch(config-if-Et30)#no shutdown
switch(config-if-Et30)#
```

Automated recovery of Ethernet interfaces that are error-disabled by a specified condition is enabled by `errdisable recovery cause`. The `errdisable recovery interval` specifies the period that an interface remains disabled until it is enabled and begins operating normally. When the disabling condition persists, recovered interfaces eventually return to the error-disabled state.

Example

These commands configure automated recovery for all interfaces that are error-disabled from link flap and bpduguard conditions. Automated recovery begins five minutes after the port is disabled.

```
switch(config)#errdisable recovery cause link-flap
switch(config)#errdisable recovery cause bpduguard
switch(config)#errdisable recovery interval 300
switch(config)#
```

10.4.5.3 Error Disable Detect Cause for ACL

The `no errdisable detect cause acl` command configures routed ports, subinterfaces, and physical ports to not get into the `errdisabled` state on ACL failure, the default behavior. To reestablish the default behavior, use the `errdisable detect cause acl` command.

The following displays the output when *errdisabling* is enabled for ACLs.

```
switch(config)#show errdisable detect
Errdisable Reason      Detection Status
-----
acl                    Enabled
```

The following displays the output when *errdisabling* is disabled for ACLs.

```
switch(config)#show errdisable detect
Errdisable Reason      Detection Status
-----
acl                    Disabled
```

10.4.5.4 Configuring Error Disable Recovery Interval for each Cause

The duration after which an interface tries to recover from being error disabled is programmable for each trigger which causes the interface to be error disabled using the `errdisable recovery cause NAME_OF_CAUSE interval DURATION` command. The command applies only to interfaces that are enabled for error recovery after being error disabled.

Example

This command configures interfaces to recover in **30** seconds when the cause is **bpduguard**.

```
switch(config)#errdisable recovery cause bpduguard interval 30
```

Example

Either of these commands revert the interval to the global value when the cause is **bpduguard**.

```
switch(config)#no errdisable recovery cause bpduguard interval
```

```
switch(config)#default errdisable recovery cause bpduguard interval
```

This command displays the status of the interfaces.

```
switch#show errdisable recovery
Errdisable Reason          Timer Status   Timer Interval
-----
bpduguard                  Disabled      30
hitless-reload-down       Disabled      300
lacp-no-portid            Disabled      N/A
lacp-rate-limit           Disabled      300
license-enforce           Disabled      N/A
link-flap                  Disabled      300
no-internal-vlan          Disabled      300
uplink-failure-detection  Disabled      300
```

10.4.5.5 Link Flap Monitoring

Link flap frequency is the quantity of link flaps (connection state changes) over a specified period. Excessive link flaps result in network stability issues, including spanning tree and routing recalculations. Link flaps are often caused by Layer 1 issues, such as a bad cable or duplex mismatch. Link flap monitoring specifies link flap thresholds and disables a port when a threshold is exceeded.

Link flap monitoring can be enabled on all interfaces through errdisable link flap commands or on individual interfaces with the link flap monitor.

10.4.5.5.1 Global Link Flap Monitor

Global link flap detection is configured through two global configuration mode commands:

- [errdisable flap-setting cause link-flap](#) configures the link-flap frequency that defines link-flap errors on an Ethernet interface.
- [errdisable detect cause link-change](#) enables the error-disabling of Ethernet interfaces that exceed the threshold link flap frequency.

Link-flap detection is enabled by default.

Example

These commands sets the link flap error criteria of 15 connection state changes over a **30** second period, then enables error detection on all interfaces.

```
switch(config)#errdisable flap-setting cause link-flap max-flaps 15 time 30
switch(config)#errdisable detect cause link-change
switch(config)#
```

10.4.5.5.2 Interface Link Flap Monitor

An interface is monitored for link flap errors with link flap profiles. A link flap profile specifies conditions that define a link-flap error. Profiles are assigned to Ethernet interfaces. Multiple profiles can be assigned to an interface to monitor a set of error conditions.

The global link flap monitor is used by interfaces that are not individually monitored for link flap errors.

Configuring Link Flap Profiles

Link flap profiles are configuration statements that define a link flap error in terms of these criteria:

- **flaps** Threshold number of interface state changes.
- **period** Interval when link flaps accumulate to trigger an error condition.
- **violations** Number of link flap errors (threshold exceeded over specified period).
- **intervals** Quantity of periods.

The `monitor link-flap policy` command places the switch in link-flap configuration mode for configuring link flap profiles and compiling a default-profile set. The `profile max-flaps (Link Flap Configuration)` command configures link flap profiles.

The default-profile set is a list of link-flap profiles that define error-disable criteria for interfaces where link flap monitoring is enabled but link-flap profiles are not assigned. The default-profile set may contain zero, one, or multiple profiles. When the default-profile set is empty, `errdisable flap-setting cause link-flap` specifies default error-disable criteria. When the default-profile set contains multiple profiles, the criteria is satisfied when conditions match any profile.

Example

These commands enter link flap configuration mode and create four link flap profiles.

```
switch(config)#monitor link-flap policy
switch(config-link-flap)#profile LF01 max-flaps 15 time 60
switch(config-link-flap)#profile LF02 max-flaps 10 time 30 violations 5
intervals 10
switch(config-link-flap)#profile LF03 max-flaps 20 time 75 violations 2
intervals 6
switch(config-link-flap)#profile LF04 max-flaps 30 time 100 violations 4
intervals 7
switch(config-link-flap)#show active
monitor link-flap policy
  profile LF01 max-flaps 15 time 60 violations 1 intervals 1
  profile LF02 max-flaps 10 time 30 violations 5 intervals 10
  profile LF02 max-flaps 20 time 75 violations 2 intervals 6
  profile LF02 max-flaps 30 time 100 violations 4 intervals 7
switch(config-link-flap)#
```

The `default-profiles` command specifies the set of link-flap profiles that define error-disable criteria for interfaces where link flap monitoring is enabled without a link flap profile assignment. Entering a `default-profile` command replaces the current default-profile statement in *running-config*.

The default-profile set may contain zero, one, or multiple profiles. When the default-profile set is empty, `errdisable flap-setting cause link-flap` specifies default error-disable criteria. When the default-profile set contains multiple profiles, error-disable criteria is satisfied when conditions match any profile. Multiple profiles are assigned to the default-profile set through a single `default-profiles` command.

Example

This command assigns configures LF01 and LF02 as the default-profile set.

```
switch(config)#monitor link-flap policy
```

```
switch(config-link-flap) #default-profiles LF01 LF02
switch(config-link-flap) #show active
monitor link-flap policy
  profile LF01 max-flaps 15 time 60 violations 1 intervals 1
  profile LF02 max-flaps 10 time 30 violations 5 intervals 10
  profile LF02 max-flaps 20 time 75 violations 2 intervals 6
  profile LF02 max-flaps 30 time 100 violations 4 intervals 7
  default-profiles LF01 LF02
switch(config-link-flap) #
```

Interface Link Flap Profile Assignments

Link flap monitoring is enabled on individual Ethernet interfaces and can optionally specify one or more profiles to define link-flap error-disabling criteria. When link flap monitoring is enabled on an interface, the link-flap conditions determine when the interface is error-disabled. Multiple profiles can be assigned to an interface to monitor a set of error conditions; a port is disabled when conditions match any of the profiles assigned to an interface.

The [monitor link-flap profiles](#) command controls link-flap monitoring on a configuration mode interface. The command provides these link flap detection options:

- **monitor link-flap (no profiles listed):** Interface detects link flaps using default-profile set criteria.
- **monitor link-flap (at least one profile listed):** Interface detects link flaps using listed profile criteria.
- **default monitor link-flap:** The interface uses global link flap monitor commands ([Global Link Flap Monitor](#)).
- **no monitor link-flap:** The interface does not detect link flaps.

Examples

- This command assigns **LF03** and **LF04** link flap profiles to **Ethernet interface 33**.

```
switch(config) #interface ethernet 33
switch(config-if-Et33) #monitor link-flap profiles LF03 LF04
switch(config-if-Et33) #show active
interface Ethernet33
  monitor link-flap profiles LF04 LF03
switch(config-if-Et33) #
```

- This command disables link-flap monitoring on **Ethernet interface 34**.

```
switch(config) #interface ethernet 34
switch(config-if-Et34) #no monitor link-flap
switch(config-if-Et34) #show active
interface Ethernet34
  no monitor link-flap
switch(config-if-Et34) #
```

- This command assigns the default-profile set to **Ethernet interface 35**.

```
switch(config) #interface ethernet 35
switch(config-if-Et35) #monitor link-flap
switch(config-if-Et35) #show active
interface Ethernet35
  monitor link-flap
switch(config-if-Et35) #
```

- This command configures **Ethernet interface 36** to use the global link flap monitoring commands

```
switch(config) #interface ethernet 36
switch(config-if-Et36) #default monitor link-flap
```

```
switch(config-if-Et36) #show active
interface Ethernet36
switch(config-if-Et36) #
```

10.4.5.6 Fabric Link Monitoring

Fabric link monitoring enables EOS to monitor low error rate errors on all fabric links for long durations, and automatically isolates fabric links on consistent error detection over an extended time interval. Isolated fabric links are restored when the error rate drops below a configured threshold.

The error rate over each configurable polling interval is derived by comparing the number of cells with CRC errors against the total number of received cells. Links are automatically isolated when the error rate is above the configured threshold for the configured consecutive number of polling intervals.

On an isolated fabric link, control cells (but not data cells) are sent. Once the error rate drops below a set threshold for the configured consecutive number of polling intervals, EOS revives the fabric link to continue sending data traffic.

10.4.5.6.1 Configuring Fabric Link Monitoring

Configuration mode commands globally enable and disable fabric link monitoring and syslog messages for the settings described below.

The `no platform sand monitor` command disables fabric link monitoring.

Generate Serdes Error Syslog

The `platform sand monitor serdes error log` command generates syslog fabric link monitoring for serdes error logging.

Example

This command enables the serdes error log for fabric link monitoring.

```
switch(config) #platform sand monitor serdes error log
switch(config) #
```

The following syslog messages are not enabled by default. Fabric link monitoring syslog is enabled by configuring the `platform sand monitor serdes error log` command.

Examples

- The following Syslog message is generated when a fabric link for serdes is automatically withdrawn:

```
%SAND-4-SERDES_WITHDRAWN_FROM_FABRIC: Serdes withdrawn from the switch
fabric.
```

- Here is another instance where a Syslog message is generated when a fabric link is automatically withdrawn:

```
%SAND-4-SERDES_WITHDRAWN_FROM_FABRIC: Serdes Arad10/5-FabricSerdes-11
withdrawn from the switch fabric.
```

- The following Syslog message is generated when a fabric link is restored:

```
%SAND-4-SERDES_RESTORED_TO_FABRIC: Serdes restored to the switch
fabric.
```

- Here is another instance where a Syslog message is generated when a fabric link is restored:

```
%SAND-4-SERDES_RESTORED_TO_FABRIC: Serdes Arad10/5-FabricSerdes-11
restored to the switch fabric.
```

Generate Serdes Error Threshold

The [platform sand monitor serdes error threshold](#) command generates a fabric link monitoring serdes error threshold.

Example

This command monitors serdes error thresholds over the specified number of received cells, resulting in the isolation of a fabric link between 200 and 30,000 received cells.

```
switch(config)#platform sand monitor serdes error threshold 200 30000
switch(config)#
```

Enable Serdes Poll Period

The [platform sand monitor serdes poll period](#) command sets the serdes poll period.

Example

This command changes the serdes polling period for fabric link monitoring to 6 seconds.

```
switch(config)#platform sand monitor serdes poll period 6
switch(config)#
```

Monitor Serdes Poll Threshold Isolation

The [platform sand monitor serdes poll threshold isolation](#) command sets and enables fabric link monitoring for serdes poll threshold isolation.

Example

This command changes the number of consecutive polls in which the threshold needs to be detected to isolate a link. In this case the number is **5** consecutive polls.

```
switch(config)#platform sand monitor serdes poll threshold isolation 5
switch(config)#
```

Monitor Serdes Poll Threshold Recovery

The [platform sand monitor serdes poll threshold recovery](#) command sets and enables fabric link monitoring for serdes poll threshold recovery.

Example

This command changes the number of consecutive serdes polls used for threshold recovery to **6** seconds.

```
switch(config)#platform sand monitor serdes poll threshold recovery 6
switch(config)#
```

Show Fabric Monitoring Health

The `show fabric monitoring health` command displays the fabric monitoring connected state status with isolated links.

Example

When fabric links are isolated, their connected state status is shown with isolated links.

```
switch(config)#show platform sand health
Fabric serdes isolated by fabric monitoring: (36 total)

Arad5/0 serdes [0-1, 10-19, 2, 20-29, 3, 30-35, 4-9]

Top fabric serdes list by number of times isolated by monitoring:
Arad5/0 serdes 0: 1 (last occurred: 0:01:04 ago)
Arad5/0 serdes 1: 1 (last occurred: 0:01:04 ago)
Arad5/0 serdes 10: 1 (last occurred: 0:01:04 ago)
Arad5/0 serdes 11: 1 (last occurred: 0:01:04 ago)
Arad5/0 serdes 12: 1 (last occurred: 0:01:04 ago)
Arad5/0 serdes 13: 1 (last occurred: 0:01:04 ago)
Arad5/0 serdes 14: 1 (last occurred: 0:01:04 ago)
Arad5/0 serdes 15: 1 (last occurred: 0:01:04 ago)
Arad5/0 serdes 16: 1 (last occurred: 0:01:04 ago)
Arad5/0 serdes 17: 1 (last occurred: 0:01:04 ago)

switch(config)#
```

10.4.5.7 Rapid Automated Indication of Link-Loss

Rapid Automated Indication of Link-Loss (RAIL) is a software feature that reduces the wait time of applications on hosts that are blocked due to a failed link. When a link goes down because of link-flapping or the unavailability of a directly connected server, the switch drops all traffic to servers whose next-hop destination was learned on the port connected to the link. Applications that drive the traffic (clients on source hosts) are blocked because of the dropped edge-switch traffic. Connection timeout varies by application and is usually measured in seconds or minutes.

RAIL is functional on a switch if it is routing-enabled and available for servers that set the switch as the default router.

10.4.5.7.1 RAIL Method

When a link monitored by RAIL goes down, the switch performs these steps for servers that the switch proxies:

1. IP addresses of servers on the failed link are extracted from ARP cache. The interface that accesses the server is determined by searching for the MAC address in the hardware MAC address tables.
2. Upon link shutdown, a dynamic MAC entry is added in the MAC address table for each server that was learned on the failed interface. Each new entry lists its interface as **CPU**.

The figure below titled **RAIL Scenarios** depicts three switch-server scenarios: link is up, link is down with RAIL disabled, and link is down with RAIL enabled. A failed link with RAIL enabled results in these behaviors:

1. All ingress packets whose destination MAC address matches an address added to the MAC address table are sent to the CPU.

2. For packets scheduled to be forwarded to the source address, the switch sends one of the following, based on the type of received segment:
 - **TCP**: TCP RST segment to the source IP address and port.
 - **UDP**: ICMP unreachable segment to the source IP address and port.
3. The client closes the socket associated with the transmitted segment and notifies the application. The application reacts immediately instead of maintaining the block until connection timeout expiry.

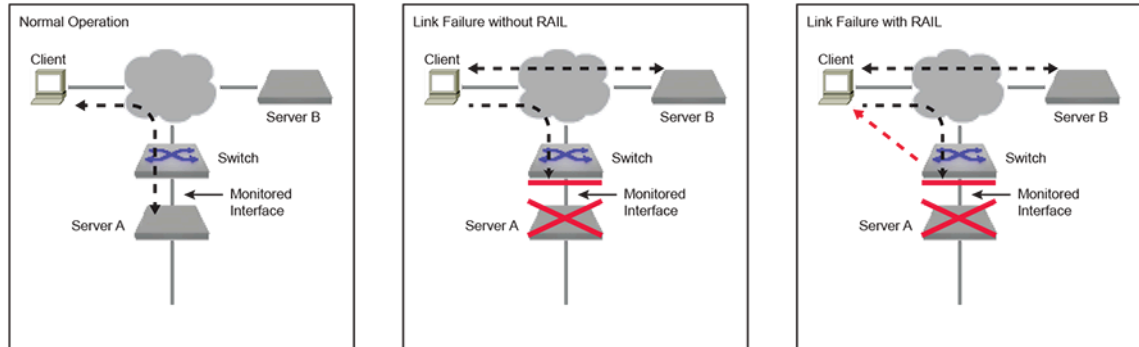

Figure 25: RAIL Scenarios

10.4.5.7.2 RAIL Implementation

RAIL defines a state machine that manages the RAIL activity level relative to a specified server. The state machine consists of four states:

- **Up**: Transitions to this state from **Inactive** when ARP and MAC entries are added for the server.
- **Proxying**: Transitions to this state from **Up** when Link Down is detected and RAIL proxying is enabled. The switch is a proxy for messages to the server.
- **Down**: Transitions to this state from **Up** when Link Down is detected and RAIL proxying is not enabled. Messages from the client remain unanswered and the application recovers only after timeout expiry.
- **Inactive**: Transitions to this state upon any of the following conditions:
 - Server's MAC address or ARP entry is deleted (from any state).
 - Proxy timeout expiry (from **Proxying** state)
 - Link down timeout expiry (from **Down** state).

10.4.5.7.3 RAIL Configuration

Server-failure configuration mode commands globally enable RAIL and configure RAIL parameters. RAIL is functional on individual interfaces only when it is globally enabled and enabled on the interface. RAIL monitors an interface for link errors when RAIL is globally enabled and enabled on the interface.

Entering Server-failure Configuration Mode

The `monitor server-failure` command places the switch in server-failure configuration mode. The `exit` command returns the switch to global configuration mode. Server-failure mode is not a group change mode; `running-config` is changed when commands are entered and not affected by exiting the mode.

The `no monitor server-failure` deletes all server-failure mode commands from `running-config`.

Examples

- These commands place the switch in server-failure configuration mode.

```
switch(config)#monitor server-failure
switch(config-server-failure)#
```

- This command deletes all server-failure configuration mode commands from *running-config*.

```
switch(config)#no monitor server-failure
switch(config)#
```

Enabling RAIL on the Switch

RAIL is disabled by default and is enabled by `no shutdown (server-failure configuration mode)`. The `shutdown` command disables RAIL without removing RAIL commands from *running-config*.

Examples

- These commands enable RAIL globally.

```
switch(config)#monitor server
switch(config-server-failure)#no shutdown
switch(config-server-failure)#show active
monitor server-failure
    no shutdown
switch(config-server-failure)#
```

- This command disables RAIL globally.

```
switch(config-server-failure)#shutdown
switch(config-server-failure)#
```

Enabling Proxy Mode

The `proxy (server-failure configuration mode)` command sets the RAIL proxy setting to *enabled* and specifies the interval that RAIL responds to messages sent to servers on failed links. The proxy timeout is measured individually for each server whose link has failed. The switch enters RAIL proxy state only when the proxy setting is enabled.

When RAIL is enabled but the proxy setting is disabled, the switch maintains a list of unavailable servers without responding to messages sent to the servers. The RAIL proxy setting is *disabled* by default. When RAIL proxy is enabled, the default period is three minutes.

The `no proxy` and `default proxy` commands return the RAIL proxy setting to *disabled*. The `no proxy lifetime` and `default proxy lifetime` commands set the proxy timeout to its default of three minutes if the RAIL proxy setting is *enabled*. The lifetime commands have no effect if RAIL proxy is *disabled*.

Examples

- These commands enable the RAIL proxy and sets the proxy timeout period of *10* minutes.

```
switch(config)#monitor server
switch(config-server-failure)#proxy lifetime 10
switch(config-server-failure)#show active
monitor server-failure
    proxy lifetime 10
switch(config-server-failure)#
```

- This command sets the proxy timeout period to its default value of **3** minutes.

```
switch(config-server-failure) #no proxy lifetime
switch(config-server-failure) #show active
monitor server-failure
    proxy
switch(config-server-failure) #
```

- This command disables the RAIL proxy.

```
switch(config-server-failure) #no proxy
switch(config-server-failure) #show active
switch(config-server-failure) #
```

Selecting Networks to Monitor

The [network \(server-failure configuration mode\)](#) command specifies the IPv4 network space that Rapid Automated Indication of Link-Loss (RAIL) monitors for failed links to connected servers. **Running-config** can contain multiple **network** statements, allowing RAIL to monitor multiple disjoint network spaces.

When a server on the specified network is blocked because of a failed Ethernet or port channel link, the switch becomes a proxy for the unavailable server and responds with **TCP RST** or **ICMP Unreachable** segments to devices sending packets to the unavailable server.

Example

These commands specify two IPv4 network spaces that RAIL monitors for server failures.

```
switch(config) #monitor server
switch(config-server-failure) #network 10.1.1.0/24
switch(config-server-failure) #network 10.2.1.96/28
switch(config-server-failure) #show active
monitor server-failure
    network 10.2.1.96/28
    network 10.1.1.0/24
switch(config-server-failure) #
```

Enabling RAIL on an Interface

RAIL monitors an interface for link errors only when RAIL is globally enabled and enabled for the interface. The [monitor server-failure link](#) command enables RAIL on the configuration mode interface. Configuration settings are effective for all Ethernet and port channel interfaces that enable RAIL.

Example

These commands enable RAIL on **port channel interface 100**.

```
switch(config) #interface port-channel 100
switch(config-if-Po100) #monitor server-failure link
switch(config-if-Po100) #show active
interface Port-Channel100
    monitor server-failure link
switch(config-if-Po100) #
```

10.4.5.7.4 Displaying RAIL Status

The switch provides commands to display RAIL configuration and status information:

Displaying RAIL Configuration settings

The `show monitor server-failure` command displays Rapid Automated Indication of Link-Loss (RAIL) configuration settings and the number of servers on each monitored network.

Example

This command displays RAIL configuration status and lists the number of servers that are on each monitored network.

```
switch>show monitor server-failure
Server-failure monitor is enabled
Proxy service: disabled
Networks being monitored: 3
 10.2.1.96/28      : 0 servers
 10.1.1.0/24      : 0 servers
 10.3.0.0/16      : 3 servers
switch>
```

Displaying RAIL History for All Connected Servers

The `show monitor server-failure history` command displays the time of all link failures detected by Rapid Automated Indication of Link-Loss (RAIL) and includes the interface name for each failure.

Example

This command displays the link failure history from the time RAIL is instantiated on the switch.

```
switch>show monitor server-failure history
Total server failures: 4

Server IP      Server MAC          Interface          Last Failed
-----
10.1.67.92    01:22:ab:cd:ee:ff   Ethernet17        2013-02-02
 11:26:22
44.11.11.7    ad:3e:5f:dd:64:cf   Ethernet23        2013-02-10
 00:07:56
10.1.1.1      01:22:df:42:78:cd   Port-Channel6     2013-02-09
 19:36:09
10.1.8.13     01:33:df:ee:39:91   Port-Channel5     2013-02-10
 00:03:39

switch>
```

Displaying Server Configuration and Status

The `show monitor server-failure servers` command displays status and configuration data about each server that RAIL monitors. The display format depends on the parameter specified by the command:

Examples

This command displays RAIL information for the server at IP address **10.11.11.7**.

- ```
switch>show monitor server-failure servers 10.11.11.7
Server information:
Server Ip Address : 10.11.11.7
MAC Address : ad:3e:5f:dd:64:cf
Current state : down
Interface : Ethernet23
Last Discovered : 2013-01-06 06:47:39
Last Failed : 2013-02-10 00:07:56
```

```

Last Proxied : 2013-02-10 00:08:33
Last Inactive : 2013-02-09 23:52:21
Number of times failed : 3
Number of times proxied : 1
Number of times inactive : 18

switch>

```

- This command displays RAIL information for the all servers on configured interfaces.

```

switch>show monitor server-failure servers all
Total servers monitored: 5

Server IP Server MAC Interface State Last Failed

10.1.67.92 01:22:ab:cd:ee:ff Ethernet17 inactive 7 days, 12:47:48 ago
44.11.11.7 ad:3e:5f:dd:64:cf Ethernet23 down 0:06:14 ago
10.1.1.1 01:22:df:42:78:cd Port-Channel6 up 4:38:01 ago
10.1.8.13 01:33:df:ee:39:91 Port-Channel5 proxying 0:10:31 ago
132.23.23.1 00:11:aa:bb:32:ad Ethernet1 up never

switch>

```

## 10.4.6 PHY test pattern CLI

Use the Ethernet Physical Layer (PHY) test pattern CLI to check the quality of the physical layer for an Ethernet interface. You can do this by generating a specific test pattern to a peer, and having the peer check the test pattern that is received, and vice versa. Because the test pattern is a well-known sequence of bits, the peer can check that the pattern received matches this well-known sequence; any difference is a bit error introduced by the peculiarities of the physical layer. The quality of the link is determined based on the acceptable bit errors, as published by the hardware vendors.

To enable the test pattern generator, configure a specific test pattern on the transmitter side of an interface. The test pattern checker is enabled by configuring the test pattern to be checked on the receiver side of the interface. PRBS is the test pattern supported by EOS.



**Note:** Physical links are bidirectional; to test both directions, the generator and checker both need to be enabled on both sides of the link. Both directions can be tested simultaneously or separately. The order of testing does not matter.

### 10.4.6.1 Platform Compatibility

The following platforms support the PHY test pattern CLI:

- DCS-7500R
- DCS-7280R
- DCS-7500R2
- DCS-7280R2
- DCS-7060DX4 (beginning with ***EOS Release 4.23.1F***)
- DCS-7060PX4 (beginning with ***EOS Release 4.23.1F***)

### 10.4.6.2 Configuration

You can configure a test pattern is configured using the **phy diag** interface configuration mode command.

1. Enter interface configuration mode, entering the targeted interface name.

```
switch(config)#interface interfaceName
```

2. Enable a test pattern on an interface using the **phy diag** command. You can select the transmitter or the receiver. To display the available interfaces, select **test pattern ?**.

```
switch(config-if)#phy diag [transmitter | receiver] test pattern ?
PRBS11 Configure the PRBS11 test pattern
PRBS15 Configure the PRBS15 test pattern
PRBS23 Configure the PRBS23 test pattern
PRBS31 Configure the PRBS31 test pattern
PRBS49 Configure the PRBS49 test pattern
PRBS58 Configure the PRBS58 test pattern
PRBS7 Configure the PRBS7 test pattern
PRBS9 Configure the PRBS9 test pattern
```

3. To disable a test pattern on an interface, enter the following command. You can select the transmitter or the receiver, as well as the selected named test pattern.

```
switch(config-if)#no phy diag [transmitter|receiver] test pattern TestPattern
```

4. By default, a test pattern is disabled.

```
switch(config-if)#default phy diag [transmitter|receiver] test pattern
```

5. The following command clears the recorded test pattern status data for all the interfaces. Upon running the command, all the counter values are set to **0** and link states are marked as **not locked**.

```
switch#clear phy diag test pattern
```

### 10.4.6.3 Show Commands

To display the configured and operational test pattern, as well as the test patterns available for an interface, use the **show interfaces** command.

In the following example, interfaces **ethernet 36/1** and **ethernet 31/1** are selected for display. The user-configured test pattern is displayed under the **Configured** column, which is divided based on transmitter and receiver configuration. The currently operational test pattern is displayed under the **Operational** column. The **Available** column lists the test patterns available for the interface.

```
switch#show interfaces ethernet 26/1,31/1 phy diag test pattern
Interface Configured Operational
 Transmit Receive Transmit Receive Available

Ethernet26/1 PRBS15 PRBS15 PRBS15 PRBS15 PRBS
7,9,11,15,23,31,58
Ethernet31/1 PRBS7 PRBS31 PRBS7 PRBS31 PRBS
7,9,11,15,23,31,58
```

Use the **show interfaces [<interface range>] phy detail** command to display the operational test pattern for an interface. In the example below, the **Test pattern** field will not be available, on disabling the test pattern.



**Note:** This command is not available on DCS-7060PX4 and DCS-7060DX4.

```
switch#show interfaces ethernet 26/1 phy detail | i Test pattern
Test pattern enabled
switch#show interfaces ethernet 31/1 phy detail | i Test pattern
Test pattern enabled
```

Use the **show interfaces [<interface range>] phy diag test pattern counters** to display test pattern link state and error information.

Available error information:

- **Link state:** whether or not the checker locked on to the configured test pattern.
- **Bit Errors:** the accumulated number of bit errors.
- **Largest Burst:** the largest burst of errors that occurred.
- **Burst Count:** the number of occurrences of errors.
- **Last Error Time:** the last time an error has occurred, 'never' if no errors have occurred.

```
switch#show interfaces ethernet 26/1,31/1 phy diag test pattern
counters
Current System Time: Wed May 30 22:24:32 2018
Interface Lane Link State Bit Errors Largest Burst
Last Error Time Burst Count

Ethernet26/1 0 locked 409266 409266 1
0:21:27 ago
Ethernet26/1 1 locked 347084 347084 1
0:21:27 ago
Ethernet26/1 2 locked 420681 420681 1
0:21:27 ago
Ethernet26/1 3 locked 392969 392969 1
0:21:27 ago
Ethernet31/1 0 not locked 1417655 651822 3
0:03:20 ago
Ethernet31/1 1 not locked 1782238 736819 3
0:03:20 ago
Ethernet31/1 2 not locked 1760538 866185 3
0:03:20 ago
Ethernet31/1 3 not locked 1817413 923941 3
0:03:20 ago
```

Use the **show interfaces [<interface range>] phy diag test pattern counters** to display the lock state of an interface along with a detailed information on the recorded bit errors.

Available detailed information:

- **Last clear:** the time when the test pattern results were last cleared.
- **Operational test pattern:** the test pattern operational at the receiver side.
- **Bit rate:** the transmission bit rate.

- **Lock state:** the current lock status, number of times it changed and the last time the lock status got changed.
  - **locked:** receiver is able to lock on to the incoming test pattern.
  - **not locked:** receiver is not able to lock on to the incoming test pattern.
- **Largest burst:** the largest burst of errors that occurred.
- **Bit errors\*:** the accumulated number of errors, number of occurrences of errors, and last time errors were captured. The \* suffix, indicating that data may not be accurate due to loss of lock, is applied if the current lock status is not locked or if the lock status has changed more than once. This suffix is cleared when the test pattern status data is cleared via the CLI listed above.
- **Total Bits:** the total bits received.
- **Bit error rate (BER)\*:** the ratio of captured bit errors to the total bit received. The \* suffix, indicating that data may not be accurate due to loss of lock, is applied if the current lock status is not locked or if the lock status has changed more than once. This suffix is cleared when the test pattern status data is cleared via the CLI listed above.
- **Bit errors since last lock:** the accumulated number of errors since last time lock was gained.
- **Total bits since last lock:** the total bits received since last lock.
- **BER since last lock:** the ratio of captured bit errors to the total bit received since last lock.

```

switch#show interfaces ethernet 26/1,31/1 phy diag test pattern
counters detail
*: Data may not be accurate due to loss of lock.

Current System Time: Wed May 30 23:36:34 2018
Ethernet26/1
 Last clear 1:33:29 ago
 Operational test pattern PRBS15
 Current State Changes
 Last Change -----

 Lane 0
 Bit rate 25.781 Gbps
 Lock state locked 1
 1:33:28 ago
 Largest burst 409266
 Bit errors 409266 1
 1:33:28 ago
 Total bits 144,607.648 Gb
 Bit error rate 2.83E-09
 Bit errors since last lock 409266
 Total bits since last lock 161,542.986 Gb
 BER since last lock 2.53E-09
 Lane 1
 Bit rate 25.781 Gbps
 Lock state locked 1
 1:33:28 ago
 Largest burst 347084
 Bit errors 347084 1
 1:33:28 ago
 Total bits 144,607.668 Gb
 Bit error rate 2.40E-09
 Bit errors since last lock 347084
 Total bits since last lock 161,543.006 Gb
 BER since last lock 2.15E-09
 Lane 2
 Bit rate 25.781 Gbps
 Lock state locked 1
 1:33:28 ago

```



|                            |                |         |
|----------------------------|----------------|---------|
| Largest burst              | 420681         |         |
| Bit errors                 | 420681         | 1       |
| 1:33:28 ago                |                |         |
| Total bits                 | 144,607.658 Gb |         |
| Bit error rate             | 2.91E-09       |         |
| Bit errors since last lock | 420681         |         |
| Total bits since last lock | 161,542.996 Gb |         |
| BER since last lock        | 2.60E-09       |         |
| Lane 3                     |                |         |
| Bit rate                   | 25.781 Gbps    |         |
| Lock state                 | locked         | 1       |
| 1:33:28 ago                |                |         |
| Largest burst              | 392969         |         |
| Bit errors                 | 392969         | 1       |
| 1:33:28 ago                |                |         |
| Total bits                 | 144,607.678 Gb |         |
| Bit error rate             | 2.72E-09       |         |
| Bit errors since last lock | 392969         |         |
| Total bits since last lock | 161,543.016 Gb |         |
| BER since last lock        | 2.43E-09       |         |
| Ethernet31/1               |                |         |
| Last clear                 | 1:33:29 ago    |         |
| Operational test pattern   | PRBS31         |         |
|                            | Current State  | Changes |
| Last Change                | -----          | -----   |
| -----                      |                |         |
| Lane 0                     |                |         |
| Bit rate                   | 25.781 Gbps    |         |
| Lock state                 | not locked     | 3       |
| 1:15:22 ago                |                |         |
| Largest burst              | 651822         |         |
| Bit errors                 | 1417655*       | 3       |
| 1:15:22 ago                |                |         |
| Total bits                 | 144,626.220 Gb |         |
| Bit error rate             | > 9.80E-09*    |         |
| Bit errors since last lock | 765833*        |         |
| Total bits since last lock | 144,471.763 Gb |         |
| BER since last lock        | > 5.30E-09*    |         |
| Lane 1                     |                |         |
| Bit rate                   | 25.781 Gbps    |         |
| Lock state                 | not locked     | 3       |
| 1:15:22 ago                |                |         |
| Largest burst              | 736819         |         |
| Bit errors                 | 1782238*       | 3       |
| 1:15:22 ago                |                |         |
| Total bits                 | 144,626.240 Gb |         |
| Bit error rate             | > 1.23E-08*    |         |
| Bit errors since last lock | 1147126*       |         |
| Total bits since last lock | 144,471.783 Gb |         |
| BER since last lock        | > 7.94E-09*    |         |
| Lane 2                     |                |         |
| Bit rate                   | 25.781 Gbps    |         |
| Lock state                 | not locked     | 3       |
| 1:15:22 ago                |                |         |
| Largest burst              | 866185         |         |
| Bit errors                 | 1760538*       | 3       |
| 1:15:22 ago                |                |         |
| Total bits                 | 144,626.230 Gb |         |
| Bit error rate             | > 1.22E-08*    |         |
| Bit errors since last lock | 894353*        |         |
| Total bits since last lock | 144,471.773 Gb |         |
| BER since last lock        | > 6.19E-09*    |         |

```

Lane 3
 Bit rate 25.781 Gbps
 Lock state not locked 3
1:15:22 ago
 Largest burst 923941
 Bit errors 1817413* 3
1:15:22 ago
 Total bits 144,626.250 Gb
 Bit error rate > 1.26E-08*
 Bit errors since last lock 893472*
 Total bits since last lock 144,471.793 Gb
 BER since last lock > 6.18E-09*

```

#### 10.4.6.4 Bit Error Rate (BER)

Bit error rate is the ratio of the recorded bit errors to the total bits received for the duration of the test run. To achieve a reliable transmission, BER should be relatively small. As per IEEE 802.3 standard, the minimum BER requirement for Ethernet links is 1E-12. Therefore, links with BER lower than 1E-12 are to be considered reliable.

The BER reported by the **test pattern** CLI is the pre-FEC (Forward Error Correction) BER. For links that have FEC enabled, it is expected to see a higher BER, in the range of **1E-4** to **1E-8**, because they are calculated before FEC is applied on the link. Based on the type of FEC applied on the link, these errors could get corrected to achieve the minimum BER requirement of 1E-12 or less.

#### 10.4.6.5 Limitations

The configuration of test patterns is supported only on a few types of ports. The available test patterns that may be configured on an interface are found in the **Available** field of the **show interfaces phy diag test pattern** CLI command.

The test pattern CLI calculates only pre-FEC BER.

If one end of the system is from another vendor, consult the vendor's documentation for the equivalent command(s) to achieve the appropriate behavior.

## 10.4.7 Data Transfer Commands

### Control Plane and Data Plane Commands

- `ip access-group` (Control Plane mode)
- `show switch forwarding-mode`
- `switch forwarding-mode`
- `system control-plane`

### Errdisable Commands

- `errdisable detect cause link-change`
- `errdisable flap-setting cause link-flap`
- `errdisable recovery cause`
- `errdisable recovery interval`
- `show errdisable recovery`

### Fabric Link Monitoring Commands

- `platform sand monitor serdes error log`
- `platform sand monitor serdes error threshold`
- `platform sand monitor serdes poll period`
- `platform sand monitor serdes poll threshold isolation`
- `platform sand monitor serdes poll threshold recovery`
- `show fabric monitoring health`
- `show platform trident mirroring`

### RAIL Commands

- `clear server-failure servers inactive`
- `monitor server-failure`
- `monitor server-failure link`
- `network` (server-failure configuration mode)
- `proxy` (server-failure configuration mode)
- `show monitor server-failure`
- `show monitor server-failure history`
- `show monitor server-failure servers`
- `shutdown` (server-failure configuration mode)

### Link Flap Monitor Commands

- `default-profiles`
- `monitor link-flap policy`
- `monitor link-flap profiles`
- `profile max-flaps` (Link Flap Configuration)

### MAC Address Table Commands

- `clear mac address-table dynamic`
- `mac address-table aging-time`
- `mac address-table static`
- `show bridge mac-address-table aging timeout`
- `show mac address-table`

- 
- show mac address-table count
  - show mac address-table mlag-peer
  - show mac address-table multicast
  - show mac address-table multicast brief
  - switchport mac address learning

### **Port Configuration Commands**

- clear counters
- description
- interface loopback
- load interval
- mtu
- phy diag
- show interfaces
- show interfaces description
- show interfaces phy diag
- switchport
- switchport default mode access
- switchport default mode routed

### **Port Mirroring Commands**

- monitor session destination
- monitor session destination cpu
- monitor session forwarding-drop
- monitor session ip access-group
- monitor session source
- monitor session source ip access-group
- monitor session truncate
- no monitor session
- show monitor session

### **Port Security Commands**

- show port-security
- show port-security interface
- show port-security mac-address
- switchport port-security
- switchport port-security mac-address maximum
- switchport port-security violation

### **Storm Control Commands**

- show storm-control
- storm-control

### **Tracking Commands**

- interface loopback
- links minimum
- link tracking group
- link tracking group (interface)

- `show link tracking group`
- `show track`
- `track`
- `traffic-loopback`

### 10.4.7.1 clear counters

The `clear counters` command resets the counters to zero for the specified interfaces. The command provides the following options:

- **No parameter:** When no option is selected, the counters are reset on the switch.
- **Session parameter:** The command resets the counters in software for the current CLI session, establishing a baseline upon which subsequent `show interfaces` or `show interfaces counters` commands are relative. Counters are not affected for other CLI sessions.

 **Note:** The `clear counters` command (and other commands that reset counters to zero) do not reset SNMP counters (such as IF-MIB::ifInOctets). As specified in RFC 2578, sections 7.1.6 and 7.1.10, a single value of a counter in SNMP has no information content. Instead, meaningful information is given by the difference between two separate fetches of a particular counter. SNMP counters automatically reset to zero when they reach their maximum values.

#### Command Mode

Privileged EXEC

#### Command Syntax

```
clear counters [INTERFACE][SCOPE]
```

#### Parameters

- **INTERFACE** Interface type and number. Options include:
  - **no parameter** Display information for all interfaces.
  - **ethernet e\_range** Ethernet interface range specified by **e\_range**.
  - **loopback l\_range** Loopback interface specified by **l\_range**.
  - **management m\_range** Management interface range specified by **m\_range**.
  - **port-channel p\_range** Port-Channel Interface range specified by **p\_range**.
  - **vlan v\_range** VLAN interface range specified by **v\_range**.
  - **vxlan vx\_range** VXLAN interface range specified by **vx\_range**.

Valid **e\_range**, **l\_range**, **m\_range**, **p\_range**, **v\_range**, and **vx\_range** formats include number, number range, or comma-delimited list of numbers and ranges.

- **SCOPE** Duration of the reset results. Options include:
  - **no parameter** counters are cleared on the switch.
  - **session** counters are reset only for the current session.

#### Example

These commands display interface counters, clear the counters, then display the counters again.

```
switch#show interfaces ethernet 1
Ethernet1 is up, line protocol is up (connected)
Hardware is Ethernet, address is 001c.7302.2fff (bia 001c.7302.2fff)
MTU 9212 bytes, BW 10000000 Kbit
Full-duplex, 10Gb/s, auto negotiation: off
Last clearing of "show interface" counters never
5 minutes input rate 301 bps (0.0% with framing), 0 packets/sec
5 minutes output rate 0 bps (0.0% with framing), 0 packets/sec
2285370854005 packets input, 225028582832583 bytes
Received 29769609741 broadcasts, 3073437605 multicast
113 runts, 1 giants
118 input errors, 117 CRC, 0 alignment, 18 symbol
27511409 PAUSE input
335031607678 packets output, 27845413138330 bytes
Sent 14282316688 broadcasts, 54045824072 multicast
108 output errors, 0 collisions
0 late collision, 0 deferred
0 PAUSE output

switch#show interfaces ethernet 1-5 counters
Port InOctets InUcastPkts InMcastPkts InBcastPkts
```

```

Et1 225028582833321 2252527806659 3073437611 29769609741
Et2 20706544058626 121703943738 7619026884 43349412335
Et3 17473231954010 84335312119 18987530444 25136247381
Et4 21909861242537 119410161405 3792251718 48470646199
Et5 0 0 0 0

Port OutOctets OutUcastPkts OutMcastPkts OutBcastPkts
Et1 27845413138330 266703466918 54045824072 14282316688
Et2 39581155181762 384838173282 34879250675 15500233246
Et3 25684397682539 256695349801 25193361878 16244203611
Et4 428040746505736 2285287022532 44408620604 19503612572
Et5 0 0 0 0

switch#clear counters session

switch#show interfaces ethernet 1
Ethernet1 is up, line protocol is up (connected)
Hardware is Ethernet, address is 001c.7302.2fff (bia 001c.7302.2fff)
MTU 9212 bytes, BW 10000000 Kbit
Full-duplex, 10Gb/s, auto negotiation: off
Last clearing of "show interface" counters 0:00:10 ago
5 minutes input rate 322 bps (0.0% with framing), 0 packets/sec
5 minutes output rate 0 bps (0.0% with framing), 0 packets/sec
 6 packets input, 835 bytes
 Received 0 broadcasts, 6 multicast
 0 runts, 0 giants
 0 input errors, 0 CRC, 0 alignment, 0 symbol
 0 PAUSE input
 0 packets output, 0 bytes
 Sent 0 broadcasts, 0 multicast
 0 output errors, 0 collisions
 0 late collision, 0 deferred
 0 PAUSE output

switch#show interfaces ethernet 1-5 counters
Port InOctets InUcastPkts InMcastPkts InBcastPkts
Et1 1204 0 9 0
Et2 1204 0 9 0
Et3 1204 0 9 0
Et4 1204 0 9 0
Et5 0 0 0 0

Port OutOctets OutUcastPkts OutMcastPkts OutBcastPkts
Et1 0 0 0 0
Et2 0 0 0 0
Et3 0 0 0 0
Et4 0 0 0 0
Et5 0 0 0 0
switch#

```

---

### 10.4.7.2 clear mac address-table dynamic

The **clear mac address-table dynamic** command removes specified dynamic entries from the MAC address table. Entries are identified by their VLAN and layer 2 (Ethernet or port channel) interface.

- To remove a specific entry, include its VLAN and interface in the command.
- To remove all dynamic entries for a VLAN, do not specify an interface.
- To remove all dynamic entries for an interface, do not specify a VLAN.
- To remove all dynamic entries, do not specify a VLAN or an interface.

#### Command Mode

Privileged EXEC

#### Command Syntax

```
clear mac address-table dynamic [VLANS][INTERFACE]
```

#### Parameters

- **VLANS** Table entries are cleared for specified VLANs. Options include:
  - **no parameter** all VLANs.
  - **vlan v\_num** VLAN specified by **v\_num**.
- **INTERFACE** Table entries are cleared for specified interfaces. Options include:
  - **no parameter** all Ethernet and port channel interfaces.
  - **interface ethernet e\_range** Ethernet interfaces specified by **e\_range**.
  - **interface port-channel p\_range** port channel interfaces specified by **p\_range**.
  - **vxlan vx\_range** VXLAN interfaces specified by **vx\_range**.

Valid **range** formats include number, range, or comma-delimited list of numbers and ranges.

#### Example

This command clears all dynamic mac address table entries for **port channel 5** on **VLAN 34**.

```
switch#clear mac address-table dynamic vlan 34 interface port-channel 5
switch#
```



### 10.4.7.3 clear server-failure servers inactive

The **clear server-failure servers inactive** command removes all inactive server entries from the server failed history list. The switch maintains this list, even after a server's ARP entry is removed, to maintain a list of servers that are connected to the switch and log the most recent time of the failure of the link that connects the switch to the server.

#### Command Mode

Privileged EXEC

#### Command Syntax

```
clear server-failure servers inactive
```

#### Related Command

[show monitor server-failure history](#)

#### Example

This command clears the inactive servers from the server failed history list.

```
switch#clear server-failure servers inactive
switch#
```

#### 10.4.7.4 default-profiles

The **default-profiles** command specifies the set of link-flap profiles that define error-disable criteria for interfaces where link flap monitoring is enabled without a link flap profile assignment. Entering a **default-profile** command replaces the current default-profile statement in **running-config**.

The default-profile set may contain zero, one, or multiple profiles. When the default-profile set is empty, [errdisable flap-setting cause link-flap](#) specifies default error-disable criteria. When the default-profile set contains multiple profiles, error-disable criteria is satisfied when conditions match any profile. Multiple profiles are assigned to the default-profile set through a single **default-profiles** command.

The **no default-profiles** and **default default-profiles** commands restore the empty default-profile set by deleting the **default-profiles** command from **running-config**.

##### Command Mode

Link-flap Configuration

##### Command Syntax

```
default-profiles [LF_PROFILES]
```

```
no default-profiles
```

```
default default-profiles
```

##### Parameters

- **LF\_PROFILES** Name of link-flap profiles assigned to default profile set. Parameter may contain zero, one, or multiple link-flap profile names:
  - **no parameter** default-profile set is empty.
  - **profile** name of single link-flap profile.
  - **profile\_1 profile\_2 ... profile\_N** list of link-flap profile names.

##### Related Commands

- [monitor link-flap policy](#) places the switch in link-flap-profiles configuration mode.
- [profile max-flaps \(Link Flap Configuration\)](#) configures link flap profiles.

##### Guidelines

The [errdisable flap-setting cause link-flap](#) statement is also configurable through the [profile max-flaps \(Link Flap Configuration\)](#) command.

##### Example

This command assigns configures **LF01** and **LF02** as the default-profile set.

```
switch(config)#monitor link-flap policy
switch(config-link-flap)#default-profiles LF01 LF02
switch(config-link-flap)#show active
monitor link-flap policy
 profile LF01 max-flaps 15 time 60 violations 1 intervals 1
 profile LF02 max-flaps 10 time 30 violations 5 intervals 10
 profile LF03 max-flaps 25 time 100 violations 2 intervals 12
 profile LF04 max-flaps 5 time 15 violations 1 intervals 3
 default-profiles LF01 LF02
switch(config-link-flap)#
```

### 10.4.7.5 description

The **description** command adds comment text for the configuration mode interface. The text provides information about the interface and has no effect on interface functions. The [show interfaces description](#) command displays interface description text.

The **no description** command removes the description text for the configuration mode interface from **running-config**.

#### Command Mode

Interface-Ethernet Configuration

Interface-Loopback Configuration

Interface-Management Configuration

Interface-Port-channel Configuration

Interface-VLAN Configuration

Interface-VXLAN Configuration

#### Command Syntax

```
description label_text
```

```
no description
```

```
default description
```

#### Parameters

**label\_text** character string assigned to description attribute.

#### Example

These commands add description text to Ethernet interface 23, then displays the text through a [show interfaces description](#) command.

```
switch(config)#interface ethernet 23
switch(config-if-Et23)#description external line
switch(config-if-Et23)#show interfaces ethernet 23 description
Interface Status Protocol Description
Et23 up up external line
```

---

### 10.4.7.6 errdisable detect cause link-change

The **errdisable detect cause link-change** command enables the error-disabling of Ethernet interfaces when the switch detects a link flap error on the interface. The [errdisable flap-setting cause link-flap](#) command defines a link flap error in terms of the frequency of connection state changes.

The switch places an interface in **error-disabled** state when it detects an error on the interface. **Error-disabled** is an operational state that is similar to link-down state. To re-enable an error-disabled interface, enter **shutdown** and **no shutdown** command in the configuration mode for the interface.

By default, link flap detection is enabled. The **no errdisable detect cause link-change** command disables the triggering of error-disable actions. The **errdisable detect cause link-change** and **default errdisable detect cause link-change** commands enable the triggering of error-disable actions by removing the **no errdisable detect cause link-change** command from *running-config*.

#### Command Mode

Global Configuration

#### Command Syntax

```
errdisable detect cause link-change
no errdisable detect cause link-change
default errdisable detect cause link-change
```

#### Examples

- This command disables error detection on the switch.

```
switch(config)#no errdisable detect cause link-change
switch(config)#
```

- These commands sets the link flap error criteria of 15 connection state changes over a 30 second period, then enables error detection on the switch.

```
switch(config)#errdisable flap-setting cause link-flap max-flaps 15
time 30
switch(config)#errdisable detect cause link-change
switch(config)#
```

### 10.4.7.7 errdisable flap-setting cause link-flap

The **errdisable flap-setting cause link-flap** command configures the link-flap frequency that defines a link-flap error on an Ethernet interface. The [errdisable detect cause link-change](#) command uses this criteria to trigger an error-disable action.

The link-flap frequency is defined by the quantity of link flaps (connection state changes) over a specified period. The default settings are five link flaps and ten seconds.

The **no errdisable flap-setting cause link-flap** and **default errdisable flap-setting cause link-flap** commands restore the default link flap cause settings by removing the **errdisable flap-setting cause link-flap** command from *running-config*.

#### Command Mode

Global Configuration

#### Command Syntax

```
errdisable flap-setting cause link-flap max-flaps quantity time period
```

```
no errdisable flap-setting cause link-flap
```

```
default errdisable flap-setting cause link-flap
```

#### Parameters

- **quantity** Number of link flaps. Value ranges from 1 to 100. Default value is 5.
- **period** Interval over which link flaps accumulate to trigger an error condition (seconds). Value ranges from 1 to 1800. Default value is 10.

#### Example

This command sets the link flap error criteria of 15 connection state changes over **30** second periods.

```
switch(config)#errdisable flap-setting cause link-flap max-flaps 15 time
30
switch(config)#
```

---

### 10.4.7.8 errdisable recovery cause

The **errdisable recovery cause** command enables the automated recovery of error-disabled Ethernet interfaces. An interface that is disabled as a result of a specified condition attempts normal operation after a specified interval. When the disabling condition persists, recovered interfaces eventually return to the error-disabled state.

When automated recovery is not enabled, interfaces are recovered manually by entering **shutdown** and **no shutdown** from the interface's configuration mode.

**Running-config** can simultaneously store **errdisable recovery cause** statements for each error-disable condition. By default, error-disable recovery is disabled for all conditions.

The **no errdisable recovery cause** and **default errdisable recovery cause** commands disable automated recovery for interfaces disabled by the specified condition by removing the corresponding **errdisable recovery cause** command from **running-config**.

#### Command Mode

Global Configuration

#### Command Syntax

```
errdisable recovery cause CONDITION
no errdisable recovery cause CONDITION
default errdisable recovery cause CONDITION
```

#### Parameters

- **CONDITION** Disabling condition for which command automates recovery. Options include:
  - **arp-inspection**
  - **bpduguard**
  - **link-flap**
  - **no-internal-vlan**
  - **portchannelguard**
  - **portsec**
  - **tapagg**
  - **uplink-failure-detection**
  - **xcvr\_unsupported**

#### Related Command

[errdisable recovery interval](#) configures the period that an ethernet interface remains disabled before automated recovery begins.

#### Example

This command enables error-disable recovery for interfaces that are disabled by link-flap and bpduguard conditions and sets the errdisable recovery period at 10 minutes.

```
switch(config)#errdisable recovery cause bpduguard
switch(config)#errdisable recovery cause link-flap
switch(config)#errdisable recovery interval 600
switch(config)#show running-config
! Command: show running-config

errdisable recovery cause bpduguard
errdisable recovery cause link-flap
errdisable recovery interval 600
!
```

```
switch(config)#
```

---

### 10.4.7.9 errdisable recovery interval

The **errdisable recovery interval** command specifies the period that an error-disabled Ethernet interface remains disabled before automated errdisable recovery begins. This command affects only interfaces whose automated recovery is enabled for the disabling condition ([errdisable recovery cause](#)). When automated recovery is not enabled, interfaces are recovered manually by entering **shutdown** and **no shutdown** from the interface's configuration mode.

The **no errdisable recovery interval** and **default errdisable recovery interval** commands restore the default error recovery period of **300** seconds by removing the **errdisable recovery interval** command from *running-config*.

#### Command Mode

Global Configuration

#### Command Syntax

```
errdisable recovery interval period
no errdisable recovery interval
default errdisable recovery interval
```

#### Parameters

**period** Error disable recovery period (seconds). Value ranges from 30 to 86400. Default value is 300

#### Related Command

[errdisable recovery cause](#) enables the automated recovery of error-disabled Ethernet interfaces.

#### Example

This command enables error-disable recovery for interfaces that are disabled by link-flap conditions and sets the errdisable recovery period at **10** minutes.

```
switch(config)#errdisable recovery cause link-flap
switch(config)#errdisable recovery interval 600
switch(config)#show running-config
! Command: show running-config

!
errdisable recovery cause link-flap
errdisable recovery interval 600
!

!
i
switch(config)#
```



### 10.4.7.10 interface loopback

The **interface loopback** command places the switch in loopback-interface configuration mode for the specified interfaces. The command creates loopback interfaces for previously unconfigured interfaces.

The command can specify a single interface or multiple interfaces:

- **Single interface:** Command creates an interface if it specifies one that was not previously created.
- **Multiple interfaces:** Command is valid only if all specified interfaces were previously created.

The **no interface loopback** command removes the specified interfaces from **running-config**, including all interface configuration statements. The **default interface loopback** command removes all configuration statements for the specified loopback interface without deleting the loopback interface from **running-config**.

The following commands are available in loopback configuration mode:

- **description**
- **exit**
- **ip address**
- **ip proxy-arp**
- **ipv6 address**
- **ipv6 enable**
- **load interval**
- **logging event**
- **mtu**
- **shutdown (Interfaces)**
- **snmp trap**

#### Command Mode

Global Configuration

#### Command Syntax

```
interface loopback l_range
```

```
no interface loopback l_range
```

```
default interface loopback l_range
```

#### Parameters

***l\_range*** Loopback interfaces (number, range, or comma-delimited list of numbers and ranges).

Loopback number ranges from 0 to 1000.

#### Examples

- This command enters interface configuration mode for loopback interfaces **1** through **5**.

```
switch(config)#interface loopback 1-5
switch(config-if-Lo1-5)#
```

- This command creates **interface 23** and enters interface configuration mode:

```
switch(config)#interface loopback 23
switch(config-if-Lo23)#
```

- This command removes loopback interfaces **5** through **7** from **running-config**.

```
switch(config)#no interface loopback 5-7
switch(config)#
```



### 10.4.7.11 ip access-group (Control Plane mode)

The `ip access-group` command applies an IPv4 or standard IPv4 access control list (ACL) to the control plane.

The `no ip access-group` and `default ip access-group` commands remove the corresponding `ip access-group` command from *running-config*.

#### Command Mode

Control-plane Configuration

#### Command Syntax

```
ip access-group list_name [VRF_INSTANCE] DIRECTION
```

```
no ip access-group [list_name][VRF_INSTANCE] DIRECTION
```

```
default ip access-group [list_name][VRF_INSTANCE] DIRECTION
```

#### Parameters

- ***list\_name*** name of ACL assigned to interface.
- **VRF\_INSTANCE** specifies the VRF instance being modified.
  - ***no parameter*** changes are made to the default VRF.
  - ***vrf vrf\_name*** changes are made to the specified user-defined VRF.
- **DIRECTION** transmission direction of packets, relative to interface. Valid options include:
  - **in** inbound packets.

#### Example

These commands apply the IPv4 ACL named **test2** to the control plane.

```
switch(config)#system control-plane
switch(config-system-cp)#ip access-group test2 in
switch(config-system-cp)#
```

---

### 10.4.7.12 link tracking group (interface)

The **link tracking group** command adds the configuration mode interface to a link-state group and specifies whether it is upstream or downstream.

The **no link tracking group** and **default link tracking group** commands remove the specified link-state group assignment for the configuration mode interface.

#### Command Mode

Interface-Ethernet Configuration

Interface-Loopback Configuration

Interface-Management Configuration

Interface-Port-channel Configuration

Interface-VLAN Configuration

Interface-VXLAN Configuration

#### Command Syntax

```
link tracking group group_name DIRECTION
```

```
no link tracking group [group_name]
```

```
default link tracking group [group_name]
```

#### Parameters

- **group\_name** link tracking group name.
- **DIRECTION** position of the interface in the link-state group. Valid options include:
  - **upstream**
  - **downstream**

#### Example

These commands create link-state group “xyz” and add **VLAN interface 100** to the group as an upstream interface.

```
switch(config)#link tracking group xyz
switch(config-link-state-xyz)#show active
link tracking group xyz
switch(config-link-state-xyz)#exit
switch(config)#interface vlan 100
switch(config-if-Vl100)#link tracking group xyz upstream
switch(config-if-Vl100)#show active
interface Vlan100
 link state group xyz upstream
switch(config-if-Vl100)#
```

### 10.4.7.13 link tracking group

The **link tracking group** command creates and enables a link-state group and places the switch in link-state-group configuration mode. A link-state group consists of “upstream” interfaces (connections to servers) and “downstream” interfaces (connections to switches and clients). In the event of a failure of all upstream interfaces in the link-state group, the downstream interfaces are shut down.

The **no link tracking group** and **default link tracking group** commands delete the link tracking group from *running-config*.

#### Command Mode

Global Configuration

#### Command Syntax

```
link tracking group group_name
no link tracking group group_name
default link tracking group group_name
```

#### Parameters

***group\_name*** link-state group name.

#### Commands available in link-state Configuration Mode

[links minimum](#) configures the minimum number of links that the link-state group requires.

#### Example

This command creates and enables ***link-state group 1***.

```
switch(config)#link tracking group 1
switch(config-link-state-1)#
```

---

#### 10.4.7.14 links minimum

The **links minimum** command specifies the minimum number of links the configuration mode link-state group requires.

The **no links minimum** and **default links minimum** commands restore the default minimum value of 1 by deleting the corresponding **links minimum** statement from *running-config*.

##### Command Mode

Link-State Configuration

##### Command Syntax

```
links minimum quantity
no links minimum
default links minimum
```

##### Parameters

**quantity** Minimum number of links. Value ranges from 1 to 100000. Default value is 1.

##### Related Commands

- [link tracking group](#) creates and enables a link-state group and places the switch in link-state configuration mode.
- [link tracking group \(interface\)](#) adds the configuration mode interface to the specified link-state group.

##### Example

These commands configure link-state tracking group *link-a* to have at least **60** links.

```
switch(config)#link tracking group link-a
switch(config-link-state-link-a)links minimum 60
switch(config-link-state-link-a)
```

### 10.4.7.15 load interval

The **load-interval** command changes the load interval for the configuration mode interface. Load interval is the time period over which data is used to compute interface rate counters. Interface rates are exponentially weighted moving averages; recent data samples have greater influence than older samples. Statistics calculated with shorter load intervals are usually more sensitive to short traffic bursts.

The **no load-interval** and **default load-interval** commands restore the default value of 300 seconds by removing the corresponding **load-interval** statement from **running-config**.

#### Command Mode

Interface-Ethernet Configuration

Interface-Loopback Configuration

Interface-Management Configuration

Interface-Port-channel Configuration

Interface-VLAN Configuration

Interface-VXLAN Configuration

#### Command Syntax

```
load-interval delay
```

```
no load-interval
```

```
default load-interval
```

#### Parameters

**delay** Load interval delay. Values range from 5 to 600 (seconds). Default value is 300 (five minutes).

#### Example

These commands set the load interval for **Ethernet interface 7** at **60** seconds.

```
switch(config)#interface ethernet 7
switch(config-if-Et7)#load-interval 60
switch(config-if-Et7)#
```

---

### 10.4.7.16 mac address learning

The **mac address learning** command enables MAC address learning on a VLAN configuration mode. By default, MAC address learning is enabled by on a VLAN.

The **no mac address learning** command disables MAC address learning for the VLAN configuration mode. The **mac address learning** and **default mac address learning** commands enable MAC address learning for the VLAN configuration mode by deleting the corresponding **no mac address learning** command from the *running-config*.

#### Command Mode

Interface-VLAN Configuration

#### Command Syntax

```
mac address learning
```

```
no mac address learning
```

```
default mac address learning
```

#### Examples

- These commands enable MAC address learning on **VLAN 10** configuration.

```
switch(config)#vlan 10
switch(config-vlan-10)#mac address learning
```

- These commands disable MAC address learning on **VLAN 10** configuration.

```
switch(config)#vlan 10
switch(config-vlan-10)#no mac address learning
```



### 10.4.7.17 mac address-table aging-time

The **mac address-table aging-time** command configures the aging time for MAC address table dynamic entries. Aging time defines the period an entry is in the table, as measured from the most recent reception of a frame on the entry's VLAN from the specified MAC address. The switch removes entries when their presence in the MAC address table exceeds the aging time.

Aging time ranges from 10 to 1,000,000 seconds with a default of 300 seconds (five minutes).

The **no mac address-table aging-time** and **default mac address-table aging-time** commands reset the aging time to its default by removing the **mac address-table aging-time** command from *running-config*.

#### Command Mode

Global Configuration

#### Command Syntax

```
mac-address-table aging-time period
no mac-address-table aging-time
default mac-address-table aging-time
```

#### Parameters

- ***period*** MAC address table aging time. Default is 300 seconds. Options include:
  - **0** disables deletion of table entries on the basis of aging time.
  - **10** through **1000000** (one million) aging period (seconds).

#### Example

This command sets the MAC address table aging time to two minutes (**120** seconds).

```
switch(config)#mac address-table aging-time 120
switch(config)#
```

### 10.4.7.18 mac address-table static

The **mac address-table static** command adds a static entry to the MAC address table. Each table entry references a MAC address, a VLAN, and a list of Layer 2 (Ethernet or port channel) ports. The table supports three entry types: unicast drop, unicast, and multicast.

- A drop entry does not include a port.
- A unicast entry includes one port.
- A multicast entry includes at least one port.

Packets with a MAC address (source or destination) and VLAN specified by a drop entry are dropped. Drop entries are valid for only unicast MAC addresses.

The command replaces existing dynamic or static table entries with the same VLAN-MAC address. Static entries are not removed by aging ([mac address-table aging-time](#)). Static MAC entries for mirror destinations or LAG members are typically avoided.

The most important byte of a MAC address distinguishes it as a unicast or multicast address:

- **Unicast:** most significant byte is an even number. Examples: 0200.0000.0000 1400.0000.0000
- **Multicast:** most significant byte is an odd number. Examples: 0300.0000.0000 2500.0000.0000

The **no mac address-table static** and **default mac address-table static** commands remove corresponding **mac address-table static** commands from **running-config** and MAC address table entries.

#### Command Mode

Global Configuration

#### Command Syntax

```
mac address-table static mac_address vlan v_num [DESTINATION]
```

```
no mac address-table static mac_address vlan v_num [DESTINATION]
```

```
default mac address-table static mac_address vlan v_num [DESTINATION]
```

#### Parameters

- **mac\_address** Table entry's MAC address (dotted hex notation – H.H.H).
- **v\_num** Table entry's VLAN.
- **DESTINATION** Table entry's port list.

For multicast MAC address entries, the command may contain multiple ports, listed in any order. The CLI accepts only one interface for unicast entries.

- **drop** creates drop entry in table. Valid only for unicast addresses.
  - **interface ethernet e\_range** Ethernet interfaces specified by **e\_range**.
  - **interface port-channel p\_range** Port channel interfaces specified by **p\_range**.
  - **no parameter** Valid for **no** and **default** commands that remove multiple table entries.

**e\_range** and **p\_range** formats include number, range, comma-delimited list of numbers and ranges.

#### Examples

- This command adds a static entry for unicast MAC address **0012.3694.03ec** to the MAC address table.

```
switch(config)#mac address-table static 0012.3694.03ec vlan 3
interface
Ethernet 7
switch(config)#show mac address-table static
Mac Address Table

```

```

Vlan Mac Address Type Ports Moves Last Move

 3 0012.3694.03ec STATIC Et7
Total Mac Addresses for this criterion: 1

 Multicast Mac Address Table

Vlan Mac Address Type Ports

Total Mac Addresses for this criterion: 0

switch(config)#

```

- These commands adds a static drop entry for MAC address **0012.3694.03ec** to the MAC address table, then displays the entry in the MAC address table.

```

switch(config)#mac address-table static 0012.3694.03ec vlan 3 drop
switch(config)#show mac address-table static
 Mac Address Table

Vlan Mac Address Type Ports Moves Last Move

 1 0012.3694.03ec STATIC
Total Mac Addresses for this criterion: 1

 Multicast Mac Address Table

Vlan Mac Address Type Ports

Total Mac Addresses for this criterion: 0

switch(config)#

```

- This command adds a static entry for the multicast MAC address **0112.3057.8423** to the MAC address table.

```

switch(config)#mac address-table static 0112.3057.8423 vlan 4
interface
port-channel 10 port-channel 12
switch(config)#show mac address-table
 Mac Address Table

Vlan Mac Address Type Ports Moves Last Move

Total Mac Addresses for this criterion: 0

 Multicast Mac Address Table

Vlan Mac Address Type Ports

 4 0112.3057.8423 STATIC Po10 Po12
Total Mac Addresses for this criterion: 1
switch(config)#

```

---

### 10.4.7.19 monitor link-flap policy

The **monitor link-flap policy** command places the switch in link-flap configuration mode for configuring link flap profiles and compiling a default-profile set. Link-flap configuration mode is not a group change mode; **running-config** is changed immediately after commands are executed. The **exit** command does not affect the configuration.

Link flap profiles are assigned to Ethernet interfaces and specify conditions that define a link-flap error. When link flap monitoring is enabled on an interface, the link-flap conditions determine when the interface is error-disabled. Multiple profiles can be assigned to an interface to monitor a set of error conditions.

#### Command Mode

Global Configuration

#### Command Syntax

```
monitor link-flap policy
```

#### Commands Available in link-flap Configuration Mode

- [default-profiles](#) configures the set of profiles that define the default-profile set.
- [profile max-flaps \(Link Flap Configuration\)](#) configures a link-flap profile

#### Examples

- These commands place the switch in link-flap configuration mode.

```
switch(config) #monitor link-flap policy
switch(config-link-flap) #
```

- This command returns the switch to global configuration mode.

```
switch(config-link-flap) #exit
switch(config) #
```

### 10.4.7.20 monitor link-flap profiles

The **monitor link-flap profiles** command enables link-flap monitoring on the configuration mode interface and specifies the error-disable criteria for the interface. Entering a **monitor link-flap profiles** command replaces the corresponding statement in *running-config*.

The command enables the following link flap detection options:

- **monitor link-flap (no profiles listed)**: The interface detects link flaps using the criteria defined by the default-profile set ( **default-profiles**).
- **monitor link-flap profiles (at least one profile listed)**: The interface detects link flaps using the criteria of the listed profiles. Error-disable criteria require conditions that match at least one profile.
- **default monitor link-flap**: The interface detects link flaps using the **errdisable flap-setting cause link-flap** and **errdisable recovery cause** commands.
- **no monitor link-flap**: The interface does not detect link flaps.

**Default monitor link flap** is the default setting.

#### Command Mode

Interface-Ethernet Configuration

Interface-Management Configuration

#### Command Syntax

```
monitor link-flap [LF_PROFILES]
```

```
no monitor link-flap
```

```
default monitor link-flap
```

#### Parameters

- **LF\_PROFILES** Name of link-flap profiles assigned to interface. Parameter may contain zero, one, or multiple link-flap profile names:
  - **no parameter** Link flap criteria determined by default-profile set.
  - **profiles profile\_name** Name of single link-flap profile.
  - **profiles profile\_name\_1 profile\_name\_2 ... profile\_name\_N** List of link-flap profile names.

#### Examples

- This command applies the **LF03** and **LF04** link flap profiles to **Ethernet interface 33**.

```
switch(config)#interface ethernet 33
switch(config-if-Et33)#monitor link-flap profiles LF03 LF04
switch(config-if-Et33)#show active
interface Ethernet33
 monitor link-flap profiles LF04 LF03
switch(config-if-Et33)#
```

- This command disables link-flap monitoring on **Ethernet interface 34**.

```
switch(config)#interface ethernet 34
switch(config-if-Et34)#no monitor link-flap
switch(config-if-Et34)#show active
interface Ethernet34
 no monitor link-flap
switch(config-if-Et34)#
```

---

### 10.4.7.21 monitor server-failure link

The **monitor server-failure link** command enables Rapid Automated Indication of Link-Loss (RAIL) on the configuration mode interface. RAIL must be properly configured globally or this command has no effect on switch operation.

When an interface monitored by RAIL goes down, the switch performs these steps for servers that the switch accesses from the interface:

1. IP addresses of the servers are removed from ARP cache.
2. A dynamic MAC entry is added to the MAC address table for each server. The port for each entry is listed as CPU.

The **no monitor server-failure link** and **default monitor server-failure link** commands disable RAIL on the configuration mode interface by deleting the corresponding **monitor server-failure link** command from *running-config*.

#### Command Mode

Interface-Ethernet Configuration

Interface-Port-Channel Configuration

#### Command Syntax

```
monitor server-failure link
no monitor server-failure link
default monitor server-failure link
```

#### Related Commands

[monitor server-failure](#) places the switch in server-failure configuration mode for configuring RAIL.

#### Example

These commands enable RAIL on port channel interface 100.

```
switch(config)#interface port-channel 100
switch(config-if-Po100)#monitor server-failure link
switch(config-if-Po100)#show active
interface Port-Channel100
 monitor server-failure link
switch(config-if-Po100)#
```

### 10.4.7.22 monitor server-failure

The **monitor server-failure** command places the switch in server-failure configuration mode. Rapid Automated Indication of Link-Loss (RAIL) settings are configured in server-failure configuration mode. RAIL is disabled by default and is enabled by the **no shutdown** command in server-failure configuration mode.

The **no monitor server-failure** and **default monitor server-failure** commands disable RAIL and restore all settings to their default state by removing all server-failure configuration mode statements from *running-config*.

Server-failure configuration mode is not a group change mode; *running-config* is changed immediately upon entering commands. Exiting server-failure configuration mode does not affect *running-config*. The **exit** command returns the switch to global configuration mode.

#### Command Mode

Global Configuration

#### Command Syntax

```
monitor server-failure
no monitor server-failure
default monitor server-failure
```

#### Commands Available in server-failure Configuration Mode

- [network \(server-failure configuration mode\)](#)
- [proxy \(server-failure configuration mode\)](#)
- [shutdown \(server-failure configuration mode\)](#)

#### Examples

- These commands place the switch in server-failure configuration mode and enables RAIL.

```
switch(config)#monitor server-failure
switch(config-server-failure)#show active
switch(config-server-failure)#no shutdown
switch(config-server-failure)#show active
monitor server-failure
 no shutdown
switch(config-server-failure)#
```

- This command deletes all server-failure configuration mode commands from *running-config*.

```
switch(config)#no monitor server-failure
switch(config)#
```

### 10.4.7.23 monitor session destination cpu

The `monitor session destination cpu` command configures the CPU as the destination port of a specified port mirroring session. The `monitor session source` command configures the source port of the mirroring session. By default, mirror sessions duplicate ingress and egress traffic but are configurable to mirror traffic from one direction.

The CPU can only be configured as a destination for a mirroring session, not as a source. However, the CPU can serve as the destination for multiple mirroring sessions. Traffic mirrored to the CPU can be viewed using `tcpdump`.

The `no monitor session destination cpu` and `default monitor session destination cpu` commands remove the mirror session destination assignment by deleting the corresponding `monitor session destination cpu` command from *running-config*. The `no monitor session` command removes the entire mirror session.

#### Command Mode

Global Configuration

#### Command Syntax

```
monitor session session_name destination cpu
no monitor session session_name destination cpu
default monitor session session_name destination cpu
```

#### Parameters

***session\_name*** Label assigned to port mirroring session.

#### Guidelines

To view the traffic mirrored to the CPU from a source port, use `tcpdump` from the Bash shell, with the source interface as an argument. This causes `tcpdump` to capture packets from the kernel interface of the source port.

#### Examples

- These commands configure **Ethernet interface 35** as the source and the CPU as the destination port for the **redirect\_1** mirroring session, then display the mirror interface.

```
switch(config)#monitor session redirect_1 destination cpu
switch(config)#monitor session redirect_1 source ethernet 35
switch(config)#show monitor session

Session redirect_1

Source Ports:

 Both: Et35

Destination Ports:

 Cpu : active (mirror0)

switch(config)#
```

- This command uses `tcpdump` to view the traffic mirrored by the **redirect\_1** mirroring session. The CPU mirror interface specified in the previous output must be used in the `tcpdump` expression (in this case, **mirror0**).

```
switch#bash tcpdump -i mirror0
tcpdump: WARNING: mirror0: no IPv4 address assigned
```



```
tcpdump: verbose output suppressed, use -v or -vv for full protocol
decode
listening on mirror0, link-type EN10MB (Ethernet), capture size 65535
bytes
09:51:12.478363 00:1c:73:27:a6:d3 (oui Arista Networks) > 01:80:c2:00:0
0:00 (oui
Unknown), 802.3, length 119: LLC, dsap STP (0x42) Individual, ssap STP
(0x42)
Command, ctrl 0x03: STP 802.1s, Rapid STP, CIST Flags [Proposal, Learn,
Forward,
Agreement], length 102
09:51:14.478235 00:1c:73:27:a6:d3 (oui Arista Networks) > 01:80:c2:00:0
0:00 (oui
Unknown), 802.3, length 119: LLC, dsap STP (0x42) Individual, ssap STP
(0x42)
Command, ctrl 0x03: STP 802.1s, Rapid STP, CIST Flags [Proposal, Learn,
Forward,
Agreement], length 102
switch#
```

## 10.4.7.24 monitor session destination

The **monitor session destination** command configures an interface as the destination port of a specified port mirroring session. The destination is usually an Ethernet interface, but other options are available on certain platforms (see **Guidelines**). The **monitor session source** command configures the source port of the mirroring session.

An interface cannot be used in more than one mirror session and cannot be simultaneously used as both source and destination. By default, mirror sessions duplicate ingress and egress traffic but are configurable to mirror traffic only from one direction.

 **Note:** On platforms which support the use of port channels as mirror destinations, a port channel *must not* be used as a mirror destination if it is a member of an MLAG.

The **no monitor session destination** and **default monitor session destination** commands remove the mirroring session destination assignment by deleting the corresponding **monitor session destination** command from *running-config*. The **no monitor session** removes the entire mirroring session.

### Command Mode

Global Configuration

### Command Syntax

```
monitor session session_name destination{cpu | ethernet e_range | port-channel p_range | tunnel mode}
```

```
no monitor session session_name destination
```

```
default monitor session session_name destination
```

### Parameters

- **session\_name** label assigned to the port mirroring session.
- **cpu** configures a CPU as the destination interface.
- **ethernet e\_range** configures Ethernet interfaces specified by **e\_range** as the destination interface. The ethernet interface value ranges from 1 to 50.
- **port-channel p\_range** configures port channel interfaces specified by **p\_range** as the destination interface. The port-channel value ranges from 1 to 2000.
- **tunnel mode** configures a tunnel as the destination interface. Option includes:
  - **gre** configures GRE-tunnel as the destination interface.

### Guidelines

Tunnel mode is supported on select platforms only.

Port mirroring capacity varies by platforms. The session destination capacity of switches on each platform is listed below:

- **Arad Platform:** Ethernet interfaces (one)
- **FM6000 Platform:** Ethernet interfaces (any count), Port channel interfaces (any count), CPU
- **Petra Platform:** Ethernet interfaces (eight for Rx or Tx sessions; four for both ways)
- **Trident Platform:** Ethernet interfaces (one)
- **Trident II Platform:** Ethernet interfaces (one)

When there are multiple transmit (Tx) sources in a monitor session, mirrored frames use Tx properties of the lowest numbered Tx mirror source configured. Packets are modified based on properties.

### Example

Allowed VLANs on the **ethernet8** source interface are **10**, **20** and **30**. Allowed VLANs on **ethernet9** source interface are **30**, **40**, and **50**. The frames going out of **ethernet9** tagged with **10**, **20**, and **30** appears at the mirrored destination as tagged frames. The tagged frames with **40** or **50** on **ethernet9**

appears at the mirrored destination as untagged frames. Since **ethernet8** is the lowest numbered source interface, all Tx frames on ethernet8 are tagged in the mirrored destination.

### Examples

- This command configures **Ethernet interface 8** as the destination port for the **redirect\_1** mirroring session.

```
switch(config)#monitor session redirect_1 destination ethernet 2
switch(config)#show monitor session

Session redirect_1

Source Ports:

Destination Ports:

 Et2 : active

switch(config)#
```

- This command configures a GRE tunnel with source and destination addresses as **1.1.1.1** and **2.2.2.2** respectively as the destination interface for the **redirect\_2** mirroring.

```
switch(config)#monitor session redirect_2 destination tunnel mode gre source
1.1.1.1 destination 2.2.2.2
switch(config)#show monitor session

Session redirect_2

Source Ports:

Destination Ports:

 status source dest TTL DSCP proto VRF fwd-drop
Grel : active 1.1.1.1 2.2.2.2 128 0 0x88be default no

switch(config)#
```

### 10.4.7.25 monitor session forwarding-drop

The **monitor session forwarding-drop** command configures a forwarding-drop session for mirroring ingress packets that are dropped during ASIC forwarding.

The **no monitor session forwarding-drop** and **default monitor session forwarding-drop** commands delete the current forwarding-drop configuration.

#### Command Mode

Global Configuration

#### Command Syntax

```
monitor session session_name forwarding-drop destination tunnel mode
no monitor session session_name forwarding-drop destination tunnel mode
default monitor session session_name forwarding-drop destination tunnel mode
```

#### Parameters

- **destination** specifies to mirror packets at destination
- **tunnel mode** specifies to mirror packets that pass through a tunnel. Options include:
  - **gre** configures GRE-tunnel as the destination interface.

#### Related Commands

- [monitor session destination](#)
- [monitor session destination cpu](#)
- [show monitor session](#)

#### Guidelines

The forwarding-drop configuration is supported on select platforms only.

#### Example

This command configures a forwarding-drop session to **1.1.1.1** as the destination.

```
switch(config)#monitor session 1 forwarding-drop destination tunnel mode
gre source 1.1.1.1 destination
2.2.2.2
switch(config)#show monitor session

Session 1

Programmed in HW: No

Source Ports:

Destination Ports:

 status source dest TTL DSCP proto VRF

fwd-drop
 Gre1 : active 1.1.1.1 2.2.2.2 128 0 0x88be default
yes

switch(config)#
```

### 10.4.7.26 monitor session ip access-group

The **monitor session ip access-group** command configures an ACL to filter the traffic being mirrored to the destination port. ACLs applied to a source port affect the RX side of the interface, and do not impact the TX side of the interface. TX mirrored packets cannot be filtered, and will continue to be sent to the mirror destination.

The **no monitor session ip access-group** and **default monitor session ip access-group** commands remove the filter from the specified mirror session by deleting the corresponding **monitor session ip access-group** command from *running-config*. The **no monitor session** command removes the entire mirror session.

#### Command Mode

Global Configuration

#### Command Syntax

```
monitor session session_name ip access-group acl_name
```

```
no monitor session session_name ip access-group
```

```
default monitor session session_name ip access-group
```

#### Parameters

- **session\_name** Label assigned to port mirroring session.
- **acl\_name** The ACL to be applied to filter traffic for the specified session.

#### Examples

- These commands create an ACL and apply it to filter the traffic mirrored to the destination port by session **redirect\_1**.

```
switch(config)#ip access-list allow-host
switch(config-acl-allow-host)#10 permit ip host 192.168.11.24 host
10.0.215.23
switch(config-acl-allow-host)#20 deny ip any any
switch(config-acl-allow-host)#exit
switch(config)#
switch(config)#monitor session redirect_1 ip access-group allow-host
switch(config)#
```

- Use the **show monitor session** command to verify the configuration.

```
switch#show monitor session
Session redirect_1

Source Ports:
Both: Et35(Acl:allow-host)
Destination Ports:
Cpu : active (mirror0)
ip access-group: allow-host
switch#
```

### 10.4.7.27 monitor session source ip access-group

The `monitor session source ip access-group` command configures an ACL to filter the traffic being mirrored from a specific source port. This enables the ability to filter traffic using a different ACL on each source port and have the combined matched traffic sent to the destination port.

The `no monitor session source ip access-group` and `default monitor session source ip access-group` commands remove the filter from the specified mirror session by deleting the corresponding `monitor session source ip access-group` command from *running-config*. The `no monitor session` command removes the entire mirror session.

#### Command Mode

Global Configuration

#### Command Syntax

```
monitor session s_name source INT_NAME [DIRECT] ip access-group acl_name
```

```
no monitor session s_name source INT_NAME [DIRECT] ip access-group acl_name
```

```
default monitor session s_name source INT_NAME [DIRECT] ip access-group acl_name
```

#### Parameters

- **s\_name** Label assigned to port mirroring session.
- **INT\_NAME** Source interface for the mirroring session.
  - **ethernet e\_range** Ethernet interfaces specified by *e\_range*.
  - **port-channel p\_range** Port channel interfaces specified by *p\_range*.
- **DIRECT** transmission direction of traffic to be mirrored. Options include:
  - **no parameter** mirrors received traffic only.
  - **rx** mirrors received traffic only.
- **acl\_name** The ACL to be applied to filter traffic for the specified session.

#### Example

These commands create ACLs and apply them to filter the traffic mirrored from two source ports by session *redir\_1*.

```
switch(config)#ip access-list allow-host-x
switch(config-acl-allow-host-x)#10 permit ip host 192.168.11.24 host
10.0.215.23
switch(config-acl-allow-host-x)#20 deny ip any any
switch(config-acl-allow-host-x)#exit
switch(config)#ip access-list allow-host-y
switch(config-acl-allow-host-y)#10 permit ip host 172.16.233.80 host
10.0.215.23
switch(config-acl-allow-host-y)#20 deny ip any any
switch(config-acl-allow-host-y)#exit
switch(config)#monitor session redir_1 source ethernet 5,9 rx
switch(config)#monitor session redir_1 source ethernet 5 ip access-group
allow-host-x
switch(config)#monitor session redir_1 source ethernet 9 ip access-group
allow-host-y
switch(config)#
```

### 10.4.7.28 monitor session source

The **monitor session source** command configures the source port of a specified port mirroring session. The **monitor session destination** or **monitor session destination cpu** command configures the destination port of the mirroring session.

An interface cannot be used in more than one mirror session and cannot be simultaneously a source and a destination. An interface which is part of a port channel cannot be used as a source, but a port channel which is a member of an MLAG can be used. By default, mirror sessions duplicate ingress and egress traffic but are configurable to mirror traffic from only one direction.

The **no monitor session source** and **default monitor session source** commands remove the mirroring session source assignment by deleting the corresponding **monitor session source** command from *running-config*. The **no monitor session** removes entire the mirroring session.

#### Command Mode

Global Configuration

#### Command Syntax

```
monitor session session_name source INT_NAME DIRECTION
no monitor session session_name source INT_NAME DIRECTION
default monitor session session_name source INT_NAME DIRECTION
```

#### Parameters

- **session\_name** Label assigned to port mirroring session.
- **INT\_NAME** Source interface for the mirroring session.
  - **ethernet e\_range** Ethernet interfaces specified by **e\_range**.
  - **port-channel p\_range** Port channel interfaces specified by **p\_range**.
- **DIRECTION** transmission direction of traffic to be mirrored.
  - **no parameter** mirrors transmitted and received traffic.
  - **both** mirrors transmitted and received traffic.
  - **rx** mirrors received traffic only.
  - **tx** mirrors transmitted traffic only.

#### Guidelines

On DCS-7050, DCS-7050X, DCS-7250X, and DCS-7300X series, due to limitations of the switch ASIC, all frames mirrored on egress are prefixed with an 802.1Q VLAN tag, even when the egress port is configured as an access port. If the capture device is unable to process VLAN tags in a desirable manner mirroring should be configured exclusively for ingress traffic by specifying **rx**.

#### Restrictions

Port mirroring capacity varies by platform. Session source capacity for each platform is listed below:

- **FM6000 Platform:** Ethernet interfaces (any number), port channel interfaces (any number)
- **Arad Platform:** Ethernet interfaces (any number), port channel interfaces (any number).
- **Petra Platform:** Ethernet interfaces (eight for Rx or Tx sessions; four for both ways)
- **Trident Platform:** Ethernet interfaces (any number), port channel interfaces (any number)
- **Trident II Platform:** Ethernet interfaces (any number), port channel interfaces (any number)

The number of interfaces that can be effectively mirrored is restricted by the destination port speed.

#### Example

---

This command configures **Ethernet interface 7** as the source port for **redirect\_1** mirroring session.

```
switch(config)#monitor session redirect_1 source ethernet 7
switch(config)#
```



### 10.4.7.29 monitor session truncate

The **monitor session truncate** command configures a port mirroring session to truncate mirrored packets, retaining only the first 160 bytes. Packet truncation can be used to prevent oversubscription of the session's destination port.

Packet truncation applies to the mirroring session as a whole, and cannot be applied to individual source ports.

The **no monitor session truncate** and **default monitor session truncate** commands restores mirroring of full packets by deleting the corresponding **monitor session truncate** command from *running-config*. The **no monitor session** removes the entire mirroring session.

#### Command Mode

Global Configuration

#### Command Syntax

```
monitor session session_name truncate
no monitor session session_name truncate
default monitor session session_name truncate
```

#### Parameters

***session\_name*** Label assigned to port mirroring session.

#### Example

This command configures mirroring session ***redirect\_1*** to truncate mirrored packets.

```
switch(config)#monitor session redirect_1 truncate
switch(config)#
```

---

### 10.4.7.30 mtu

The **mtu** command configures the IPv4 and IPv6 Maximum Transmission Unit (MTU) size for the configuration mode interface. The switch fragments IP packets that are larger than the MTU value for the outbound interface. An interface's MTU value is displayed with the [show interfaces](#) command.

MTU is independently configurable on all routable interfaces. The switch supports MTU sizes ranging from 68 to 9214 bytes. The default MTU size is 1500 bytes.

The **no mtu** and **default mtu** commands restore the interface's MTU to the default value by removing the corresponding mtu command from *running-config*.

#### Command Mode

Interface-Ethernet Configuration

Interface-Loopback Configuration

Interface-Management Configuration

Interface-Port-channel Configuration

Interface-VLAN Configuration

#### Command Syntax

```
mtu bytes
```

```
no mtu
```

```
default mtu
```

#### Parameters

**bytes** MTU size (bytes). Values range from 68 to 9214.

#### Example

This command sets the MTU size of **1492** bytes on **VLAN interface 20**.

```
switch(config)#interface vlan 20
switch(config-if-Vl20)#mtu 1492
switch(config-if-Vl20)#
```

### 10.4.7.31 network (server-failure configuration mode)

The **network** command specifies the IPv4 network space that Rapid Automated Indication of Link-Loss (RAIL) monitors for failed links to connected servers. RAIL reduces the wait time for applications on directly connected servers that are blocked due to a failed link. **Running-config** supports simultaneous network command, allowing RAIL to monitor multiple disjoint network spaces.

When a server on the specified network is blocked because of a failed Ethernet or port channel link, the switch becomes a proxy for the unavailable server and responds with **TCP RST** or **ICMP Unreachable** segments to devices sending packets to the unavailable server.

The **no network** and **default network** commands terminate the RAIL monitoring of the specified IPv4 address space by deleting the corresponding **network** command from **running-config**.

#### Command Mode

Server-failure Configuration

#### Command Syntax

```
network netv4_address
```

```
no network netv4_address
```

```
default network netv4_address
```

#### Parameters

- **netv4\_addr** IPv4 subnet address to be monitored (CIDR or address-mask notation).

#### Related Command

[monitor server-failure](#) places the switch in server-failure configuration mode.

#### Example

This command specifies two IPv4 network spaces that RAIL monitors for server failures.

```
switch(config)#monitor server
switch(config-server-failure)#network 10.1.1.0/24
switch(config-server-failure)#network 10.2.1.96/28
switch(config-server-failure)#show active
monitor server-failure
 network 10.2.1.96/28
 network 10.1.1.0/24
switch(config-server-failure)#
```

---

### 10.4.7.32 no monitor session

The **no monitor session** and default monitor session commands remove the specified monitor session from the switch by deleting all corresponding monitor commands from **running-config**. Commands that remove or alter individual commands within a session configuration are described in the [monitor session destination](#) and [monitor session source](#) commands.

#### Command Mode

Global Configuration

#### Command Syntax

```
no monitor session session_name
```

```
default monitor session session_name
```

#### Parameters

**session\_name** Label assigned to port mirroring session.

#### Example

This command displays the configuration of the **redirect\_1** mirroring session, deletes the session, then confirms that the session was removed.

```
switch(config)#show monitor session redirect_1

Session redirect_1

Source Ports

 Both: Et7

Destination Port: Et8
switch(config)#no monitor session redirect_1
switch(config)#show monitor session redirect_1
Session not created

switch(config)#
```

### 10.4.7.33 phy diag

Use the **phy diag** command to configure a test pattern in the interface configuration mode. The **no** and **default** forms of the command disables the test pattern.

#### Command Mode

Interface configuration mode

#### Command Syntax

```
phy diag [transmitter | receiver] test pattern TestPattern
```

```
no phy diag [transmitter | receiver] test pattern TestPattern
```

```
default phy diag [transmitter | receiver] test pattern TestPattern
```

#### Parameters

- **transmitter** Configures the physical transmitter.
- **receiver** Configures the physical receiver.
- **test pattern *TestPattern*** Configures the named test pattern.

#### Examples

- Enable a test pattern on an interface using the **phy diag** command. You can select the transmitter or the receiver. To display the available interfaces, select **test pattern ?**.

```
switch(config-if)#phy diag [transmitter | receiver] test pattern ?
PRBS11 Configure the PRBS11 test pattern
PRBS15 Configure the PRBS15 test pattern
PRBS23 Configure the PRBS23 test pattern
PRBS31 Configure the PRBS31 test pattern
PRBS49 Configure the PRBS49 test pattern
PRBS58 Configure the PRBS58 test pattern
PRBS7 Configure the PRBS7 test pattern
PRBS9 Configure the PRBS9 test pattern
```

- To disable a test pattern on an interface, enter the following command. You can select the transmitter or the receiver, as well as the selected named test pattern.

```
switch(config-if)#no phy diag [transmitter | receiver] test pattern TestPattern
```

- By default, a test pattern is disabled.

```
switch(config-if)#default phy diag [transmitter | receiver] test pattern
```

- The following command clears the recorded test pattern status data for all the interfaces. Upon running the command, all the counter values are set to **0** and link states are marked as **not locked**.

```
switch#clear phy diag test pattern
```

---

### 10.4.7.34 platform sand monitor serdes error log

The `platform sand monitor serdes error log` command is used for enabling the serdes error log for fabric link monitoring.

#### Command Mode

Global Configuration

#### Command Syntax

```
platform sand monitor serdes error log
```

#### Example

This command enables the serdes error log for fabric link monitoring.

```
switch(config)#platform sand monitor serdes error log
switch(config)#
```

### 10.4.7.35 platform sand monitor serdes error threshold

The **platform sand monitor serdes error threshold** command is used for generating a fabric link monitoring serdes error threshold.

#### Command Mode

Global Configuration

#### Command Syntax

```
platform sand monitor serdes error threshold
```

#### Example

This command monitors serdes error thresholds over the specified number of received cells, resulting in the isolation of a fabric link between 200 and 30,000 received cells.

```
switch(config)#platform sand monitor serdes error threshold 200 30000
switch(config)#
```

---

### 10.4.7.36 platform sand monitor serdes poll period

The `platform sand monitor serdes poll period` command is used to enable the serdes poll period.

#### Command Mode

Global Configuration

#### Command Syntax

```
platform sand monitor serdes poll period
```

#### Example

This command changes the serdes polling period for fabric link monitoring to 6 seconds.

```
switch(config)#platform sand monitor serdes poll period 6
switch(config)#
```



### 10.4.7.37 platform sand monitor serdes poll threshold isolation

The **platform sand monitor serdes poll threshold isolation** command is used to set and enables fabric link monitoring for serdes poll threshold isolation.

#### Command Mode

Global Configuration

#### Command Syntax

```
platform sand monitor serdes poll threshold isolation
```

#### Example

This command changes the number of consecutive polls in which the threshold needs to be detected to isolate a link. In this case the number is **5** consecutive polls.

```
switch(config)#platform sand monitor serdes poll threshold isolation 5
switch(config)#
```

---

### 10.4.7.38 platform sand monitor serdes poll threshold recovery

The **platform sand monitor serdes poll threshold recovery** command is used to set and enable fabric link monitoring for serdes poll threshold recovery.

#### Command Mode

Global Configuration

#### Command Syntax

```
platform sand monitor serdes poll threshold recovery
```

#### Example

This command changes the number of consecutive serdes polls used for threshold recovery to 6 seconds.

```
switch(config)#platform sand monitor serdes poll threshold recovery 6
switch(config)#
```

### 10.4.7.39 profile max-flaps (Link Flap Configuration)

The **profile max-flaps** command creates a link flap profile that, when assigned to an Ethernet interface, specifies the conditions that result in an error-disable action. Link flap profile parameters include:

- **flaps** Threshold number of interface state changes.
- **period** Interval when link flaps accumulate to trigger an error condition.
- **violations** Number of link flap errors (threshold exceeded over specified period).
- **intervals** Quantity of periods.

By default, **violations** and **intervals** are each set to one, resulting in a profile that triggers a link-flap error when the specified frequency is exceeded once. By configuring violations and intervals, link-flap errors are defined when the frequency is exceeded multiple times over a specified set of intervals.

**Default** is a reserved profile name that modifies the [errdisable flap-setting cause link-flap](#) statement in *running-config*. When configuring the **default** profile, **violations** and **intervals** are disregarded.

The **no profile max-flaps** command removes the specified profile by deleting the corresponding **profile max-flaps** command from *running-config*. The **no profile max-flaps default** command restores default [errdisable flap-setting cause link-flap](#) values by removing that command from *running-config*.

#### Command Mode

Link-flap Configuration

#### Command Syntax

```
profile PROFILE_NAME max-flaps flap_max time period [EXTENTIONS]
```

```
no profile LF_PROFILE
```

#### Parameters

- **PROFILE\_NAME** Name of link flap profile. Options include:
  - **default** command modifies default values ([errdisable flap-setting cause link-flap](#)).
  - **profile\_name** command modifies specified link-flap profile.
- **flap\_max** Threshold number of interface state changes. Value ranges from 1 to 100.
- **period** Interval when flaps accumulate toward threshold (seconds). Value ranges from 1 to 1800.
- **EXTENSIONS** Configures multi-flap triggers. Options include:
  - **no parameter** Sets errors and episodes to default values (one).
  - **violations errors intervals episodes** Link flap errors (**errors**) and number of periods (**episodes**).

**Errors** range is 1 to 1000. Default value is one.

**Episodes** range is 1 to 1000. Default value is one.

#### Related Command

[monitor link-flap policy](#) places the switch in link-flap configuration mode.

#### Example

These commands create two link flap profiles with various trigger settings.

```
switch(config)#monitor link-flap policy
switch(config-link-flap)#profile LF01 max-flaps 15 time 60
switch(config-link-flap)#profile LF02 max-flaps 10 time 30 violations 5
intervals
10
```

---

```
switch(config-link-flap)#show active
monitor link-flap policy
 profile LF01 max-flaps 15 time 60 violations 1 intervals 1
 profile LF02 max-flaps 10 time 30 violations 5 intervals 10
switch(config-link-flap)#
```

### 10.4.7.40 proxy (server-failure configuration mode)

The **proxy** command enables the Rapid Automated Indication of Link-Loss (RAIL) proxy setting and specifies the interval that RAIL responds to messages sent to servers on failed links, starting from when the switch detects the failed link. The RAIL state machine is in the proxying state during the timeout interval this command specifies. When RAIL proxy is not enabled, the switch maintains a list of unavailable servers without responding to messages sent the servers. The switch can enter RAIL proxy state only when this command is enabled.

The RAIL proxy setting is **disabled** by default. When RAIL proxy is enabled, the default period is three minutes.

The **no proxy** and **default proxy** commands return the RAIL proxy setting to disabled by removing the proxy statement from *running-config*.

The **no proxy lifetime** and **default proxy lifetime** command sets the proxy time setting to its default value of three minutes if the RAIL proxy setting is **enabled**. These commands have no effect if the RAIL proxy setting is **disabled**.

#### Command Mode

Server-failure Configuration

#### Command Syntax

```
proxy [lifetime time_span]
```

```
no proxy [lifetime]
```

```
default proxy [lifetime]
```

#### Parameters

**timespan** proxy timeout period (minutes). Value ranges from 1 to 10080. Default value is 3.

#### Related Command

[monitor server-failure](#) places the switch in server-failure configuration mode.

#### Examples

- These commands enable the RAIL proxy and sets the proxy timeout period of 10 minutes.

```
switch(config)#monitor server
switch(config-server-failure)#proxy lifetime 10
switch(config-server-failure)#show active
monitor server-failure
 proxy lifetime 10
switch(config-server-failure)#
```

- This command sets the proxy timeout period to its default value of 3 minutes.

```
switch(config-server-failure)#no proxy lifetime
switch(config-server-failure)#show active
monitor server-failure
 proxy
switch(config-server-failure)#
```

- This command disables the RAIL proxy.

```
switch(config-server-failure)#no proxy
switch(config-server-failure)#show active
monitor server-failure
switch(config-server-failure)#
```

---

#### 10.4.7.41 show bridge mac-address-table aging timeout

The **show bridge mac-address-table aging timeout** command displays the aging time for MAC address table dynamic entries. Aging time defines the period an entry is in the table, as measured from the most recent reception of a frame on the entry's VLAN from the specified MAC address. The switch removes entries that exceed the aging time.

Aging time ranges from 10 seconds to 1,000,000 seconds with a default of 300 seconds (five minutes).

##### Command Mode

EXEC

##### Command Syntax

```
show bridge mac-address-table aging timeout
```

##### Example

This command shows the MAC address table aging time.

```
switch>show bridge mac-address-table aging timeout
Global Aging Time: 120
switch>
```

#### 10.4.7.42 show errdisable recovery

The `show errdisable recovery` command displays information about the recovery intervals and error disable causes.

##### Command Mode

EXEC

##### Command Syntax

```
show errdisable recovery
```

`show errdisable recovery` command displays the information for the current state of the system.

##### Parameters

- *no parameter* state of the system.

The following output is for a system where the causes are listed and interval timer for each cause is identified along with the timer status.

```
switch#show errdisable recovery
Errdisable Reason Timer Status Timer Interval

 bpduguard Disabled 30
 hitless-reload-down Disabled 300
 lacp-no-portid Disabled N/A
 lacp-rate-limit Disabled 300
 license-enforce Disabled N/A
 link-flap Disabled 300
 no-internal-vlan Disabled 300
 uplink-failure-detection Disabled 300
```

---

### 10.4.7.43 show fabric monitoring health

The `platform sand monitor health` command is used to display the fabric monitoring connected state status with isolated links.

#### Command Mode

Global Configuration

#### Command Syntax

```
platform sand monitor health
```

#### Example

This command displays the connected state status with isolated links.

```
switch(config)#show platform sand health
Fabric serdes isolated by fabric monitoring: (36 total)

Arad5/0 serdes [0-1, 10-19, 2, 20-29, 3, 30-35, 4-9]

Top fabric serdes list by number of times isolated by monitoring:
Arad5/0 serdes 0: 1 (last occurred: 0:01:04 ago)
Arad5/0 serdes 1: 1 (last occurred: 0:01:04 ago)
Arad5/0 serdes 10: 1 (last occurred: 0:01:04 ago)
Arad5/0 serdes 11: 1 (last occurred: 0:01:04 ago)
Arad5/0 serdes 12: 1 (last occurred: 0:01:04 ago)
Arad5/0 serdes 13: 1 (last occurred: 0:01:04 ago)
Arad5/0 serdes 14: 1 (last occurred: 0:01:04 ago)
Arad5/0 serdes 15: 1 (last occurred: 0:01:04 ago)
Arad5/0 serdes 16: 1 (last occurred: 0:01:04 ago)
Arad5/0 serdes 17: 1 (last occurred: 0:01:04 ago)

switch(config)#
```



### 10.4.7.44 show interfaces

The **show interfaces** command displays operational status and configuration information of specified interfaces. The output includes speed, duplex, flow control information and basic interface statistics.

The input and output bit rates, as displayed, do not include framing bits that are part of the Ethernet standard, the inter-frame gap and preamble that total 20 bytes per packet. The percentage number includes those framing bits to provide a better link utilization estimate.

#### Command Mode

EXEC

#### Command Syntax

```
show interfaces [INT_NAME]
```

#### Parameters

- INT\_NAME Interface type and numbers. Options include:
  - **no parameter** all interfaces.
  - **ethernet e\_range** Ethernet interface range specified by **e\_range**.
  - **loopback l\_range** Loopback interface specified by **l\_range**.
  - **management m\_range** Management interface range specified by **m\_range**.
  - **port-channel p\_range** Port-Channel Interface range specified by **p\_range**.
  - **vlan v\_range** VLAN interface range specified by **v\_range**.
  - **vxlan vx\_range** VXLAN interface range specified by **vx\_range**.

Valid range formats include number, number range, or comma-delimited list of numbers and ranges.

#### Example

This command display configuration and status information for Ethernet interface **1** and **2**.

```
switch>show interfaces ethernet 1-2
Ethernet1 is up, line protocol is up (connected)
Hardware is Ethernet, address is 001c.2481.7647 (bia 001c.2481.7647)
Description: mkt.1
MTU 9212 bytes, BW 10000000 Kbit
Full-duplex, 10Gb/s, auto negotiation: off
Last clearing of "show interface" counters never
5 seconds input rate 33.5 Mbps (0.3% with framing), 846 packets/sec
5 seconds output rate 180 kbps (0.0% with framing), 55 packets/sec
 76437268 packets input, 94280286608 bytes
 Received 2208 broadcasts, 73358 multicast
 0 runts, 0 giants
 0 input errors, 0 CRC, 0 alignment, 0 symbol
 0 PAUSE input
 6184281 packets output, 4071319140 bytes
 Sent 2209 broadcasts, 345754 multicast
 0 output errors, 0 collisions
 0 late collision, 0 deferred
 0 PAUSE output
Ethernet2 is up, line protocol is up (connected)
Hardware is Ethernet, address is 001c.2481.7648 (bia 001c.2481.7648)
Description: mkt.2
MTU 9212 bytes, BW 10000000 Kbit
Full-duplex, 10Gb/s, auto negotiation: off
Last clearing of "show interface" counters never
5 seconds input rate 711 kbps (0.0% with framing), 271 packets/sec
5 seconds output rate 239 kbps (0.0% with framing), 65 packets/sec
 73746370 packets input, 78455101010 bytes
```

---

```
Received 11 broadcasts, 83914 multicast
0 runts, 0 giants
0 input errors, 0 CRC, 0 alignment, 0 symbol
0 PAUSE input
5687714 packets output, 4325064454 bytes
Sent 15 broadcasts, 107279 multicast
0 output errors, 0 collisions
0 late collision, 0 deferred
0 PAUSE output
switch>
```

### 10.4.7.45 show interfaces description

The `show interfaces description` command displays the status and description text of the specified interfaces. The `description` command configures an interface's description parameter.

#### Command Mode

EXEC

#### Command Syntax

```
show interfaces [INT_NAME] description
```

#### Parameters

- **INT\_NAME** Interface type and labels. Options include:
  - *no parameter* all interfaces.
  - **ethernet e\_range** Ethernet interface range specified by *e\_range*.
  - **loopback l\_range** Loopback interface specified by *l\_range*.
  - **management m\_range** Management interface range specified by *m\_range*.
  - **port-channel p\_range** Port-Channel Interface range specified by *p\_range*.
  - **vlan v\_range** VLAN interface range specified by *vx\_range*.
  - **vxlan vx\_range** VXLAN interface range specified by *vx\_range*.

Range formats include number, number range, or comma-delimited list of numbers and ranges.

#### Example

This command displays description text and status of **ethernet interfaces 1-10**.

```
switch>show interfaces ethernet 1-10 description
Interface Status Protocol Description
Et1 up up ctar_01
Et2 up up ctar_02
Et3 up up ctar_03
Et4 up up fobd_01
Et5 up up fobd_02
Et6 up up yzrq_01
Et7 up up yzrq_02
Et8 down down yzrq_03
Et9 up up yzrq_04
Et10 up up yzrq_05
switch>
```

## 10.4.7.46 show interfaces phy diag

### Command Mode

EXEC

### Command Syntax

```
show interfaces [interface type interface range] phy diag [error-correction | test pattern]
```

### Parameters

- **interface type *interface range*** Type of interface and range.
- **error-correction** Forwards error correction.
- **test pattern** Displays test patterns.

### Guidelines

The user-configured test pattern is displayed under the **Configured** column, which is divided based on transmitter and receiver configuration. The currently operational test pattern is displayed under the **Operational** column. The **Available** column lists the test patterns available for the interface.

### Example

- In this example, interfaces ethernet 26/1 and ethernet 31/1 in the **show interfaces ethernet 26/1,31/1 phy diag test pattern** command are selected to display the the configured and operational test pattern, and the available test patterns.

```
switch#show interfaces ethernet 26/1,31/1 phy diag test pattern
 Configured Operational
Interface Transmit Receive Transmit Receive Available

Ethernet26/1 PRBS15 PRBS15 PRBS15 PRBS15 PRBS 7,9,11,15,23,31,58
Ethernet31/1 PRBS7 PRBS31 PRBS7 PRBS31 PRBS 7,9,11,15,23,31,58
```

The user-configured test pattern is displayed under the **Configured** column, which is divided based on transmitter and receiver configuration. The currently operational test pattern is displayed under the **Operational** column. The **Available** column lists the test patterns available for the interface.

- In this example, the **show interfaces ethernet 26/1 phys detail | i Test pattern** command displays the operational test pattern for an interface. Here the **Test pattern** field will not be available, on disabling the test pattern.

```
switch#show interfaces ethernet 26/1 phy detail | i Test pattern
Test pattern enabled
switch#show interfaces ethernet 31/1 phy detail | i Test pattern
Test pattern enabled
```

- In this example, the **show interfaces ethernet 26/1,31/1 phy diag test pattern counters** command displays test pattern link state and error information.

The following information is listed in the display output:

- **Link state:** whether or not the checker locked on to the configured test pattern.
- **Bit Errors:** the accumulated number of bit errors.
- **Largest Burst:** the largest burst of errors that occurred.
- **Burst Count:** the number of occurrences of errors.
- **Last Error Time:** the last time an error has occurred, 'never' if no errors have occurred.

```
switch#show interfaces ethernet 26/1,31/1 phy diag test pattern counters
Current System Time: Wed May 30 22:24:32 2018
Interface Lane Link State Bit Errors Largest Burst Burst Count Last Error Time

Ethernet26/1 0 locked 409266 409266 1 0:21:27 ago
```

|              |   |            |         |        |   |             |
|--------------|---|------------|---------|--------|---|-------------|
| Ethernet26/1 | 1 | locked     | 347084  | 347084 | 1 | 0:21:27 ago |
| Ethernet26/1 | 2 | locked     | 420681  | 420681 | 1 | 0:21:27 ago |
| Ethernet26/1 | 3 | locked     | 392969  | 392969 | 1 | 0:21:27 ago |
| Ethernet31/1 | 0 | not locked | 1417655 | 651822 | 3 | 0:03:20 ago |
| Ethernet31/1 | 1 | not locked | 1782238 | 736819 | 3 | 0:03:20 ago |
| Ethernet31/1 | 2 | not locked | 1760538 | 866185 | 3 | 0:03:20 ago |
| Ethernet31/1 | 3 | not locked | 1817413 | 923941 | 3 | 0:03:20 ago |

- In this example, the **show interfaces ethernet 26/1,31/1 phy diag test pattern counters** command displays the lock state of an interface along with a detailed information on the recorded bit errors.

The following information is listed in the display output:

- **Last clear:** the time when the test pattern results were last cleared.
- **Operational test pattern:** the test pattern operational at the receiver side.
- **Bit rate:** the transmission bit rate.
- **Lock state:** the current lock status, number of times it changed and the last time the lock status got changed.
  - **locked:** receiver is able to lock on to the incoming test pattern.
  - **not locked:** receiver is not able to lock on to the incoming test pattern.
- **Largest burst:** the largest burst of errors that occurred.
- **Bit errors\*:** the accumulated number of errors, number of occurrences of errors, and last time errors were captured. The \* suffix, indicating that data may not be accurate due to loss of lock, is applied if the current lock status is not locked or if the lock status has changed more than once. This suffix is cleared when the test pattern status data is cleared via the CLI listed above.
- **Total Bits:** the total bits received.
- **Bit error rate (BER)\*:** the ratio of captured bit errors to the total bit received. The \* suffix, indicating that data may not be accurate due to loss of lock, is applied if the current lock status is not locked or if the lock status has changed more than once. This suffix is cleared when the test pattern status data is cleared via the CLI listed above.
- **Bit errors since last lock:** the accumulated number of errors since last time lock was gained.
- **Total bits since last lock:** the total bits received since last lock.
- **BER since last lock:** the ratio of captured bit errors to the total bit received since last lock.

```
switch#show interfaces ethernet 26/1,31/1 phy diag test pattern counters detail
*: Data may not be accurate due to loss of lock.

Current System Time: Wed May 30 23:36:34 2018
Ethernet26/1
 Last clear 1:33:29 ago
 Operational test pattern PRBS15
 Current State Changes Last Change

Lane 0
 Bit rate 25.781 Gbps
 Lock state locked 1 1:33:28 ago
 Largest burst 409266
 Bit errors 409266 1 1:33:28 ago
 Total bits 144,607.648 Gb
 Bit error rate 2.83E-09
 Bit errors since last lock 409266
 Total bits since last lock 161,542.986 Gb
 BER since last lock 2.53E-09
Lane 1
 Bit rate 25.781 Gbps
 Lock state locked 1 1:33:28 ago
 Largest burst 347084
 Bit errors 347084 1 1:33:28 ago
 Total bits 144,607.668 Gb
 Bit error rate 2.40E-09
 Bit errors since last lock 347084
 Total bits since last lock 161,543.006 Gb
 BER since last lock 2.15E-09
Lane 2
 Bit rate 25.781 Gbps
 Lock state locked 1 1:33:28 ago
```

|                            |                |         |             |
|----------------------------|----------------|---------|-------------|
| Largest burst              | 420681         |         |             |
| Bit errors                 | 420681         | 1       | 1:33:28 ago |
| Total bits                 | 144,607.658 Gb |         |             |
| Bit error rate             | 2.91E-09       |         |             |
| Bit errors since last lock | 420681         |         |             |
| Total bits since last lock | 161,542.996 Gb |         |             |
| BER since last lock        | 2.60E-09       |         |             |
| Lane 3                     |                |         |             |
| Bit rate                   | 25.781 Gbps    |         |             |
| Lock state                 | locked         | 1       | 1:33:28 ago |
| Largest burst              | 392969         |         |             |
| Bit errors                 | 392969         | 1       | 1:33:28 ago |
| Total bits                 | 144,607.678 Gb |         |             |
| Bit error rate             | 2.72E-09       |         |             |
| Bit errors since last lock | 392969         |         |             |
| Total bits since last lock | 161,543.016 Gb |         |             |
| BER since last lock        | 2.43E-09       |         |             |
| Ethernet31/1               |                |         |             |
| Last clear                 | 1:33:29 ago    |         |             |
| Operational test pattern   | PRBS31         |         |             |
|                            | Current State  | Changes | Last Change |
|                            | -----          | -----   | -----       |
| Lane 0                     |                |         |             |
| Bit rate                   | 25.781 Gbps    |         |             |
| Lock state                 | not locked     | 3       | 1:15:22 ago |
| Largest burst              | 651822         |         |             |
| Bit errors                 | 1417655*       | 3       | 1:15:22 ago |
| Total bits                 | 144,626.220 Gb |         |             |
| Bit error rate             | > 9.80E-09*    |         |             |
| Bit errors since last lock | 765833*        |         |             |
| Total bits since last lock | 144,471.763 Gb |         |             |
| BER since last lock        | > 5.30E-09*    |         |             |
| Lane 1                     |                |         |             |
| Bit rate                   | 25.781 Gbps    |         |             |
| Lock state                 | not locked     | 3       | 1:15:22 ago |
| Largest burst              | 736819         |         |             |
| Bit errors                 | 1782238*       | 3       | 1:15:22 ago |
| Total bits                 | 144,626.240 Gb |         |             |
| Bit error rate             | > 1.23E-08*    |         |             |
| Bit errors since last lock | 1147126*       |         |             |
| Total bits since last lock | 144,471.783 Gb |         |             |
| BER since last lock        | > 7.94E-09*    |         |             |
| Lane 2                     |                |         |             |
| Bit rate                   | 25.781 Gbps    |         |             |
| Lock state                 | not locked     | 3       | 1:15:22 ago |
| Largest burst              | 866185         |         |             |
| Bit errors                 | 1760538*       | 3       | 1:15:22 ago |
| Total bits                 | 144,626.230 Gb |         |             |
| Bit error rate             | > 1.22E-08*    |         |             |
| Bit errors since last lock | 894353*        |         |             |
| Total bits since last lock | 144,471.773 Gb |         |             |
| BER since last lock        | > 6.19E-09*    |         |             |
| Lane 3                     |                |         |             |
| Bit rate                   | 25.781 Gbps    |         |             |
| Lock state                 | not locked     | 3       | 1:15:22 ago |
| Largest burst              | 923941         |         |             |
| Bit errors                 | 1817413*       | 3       | 1:15:22 ago |
| Total bits                 | 144,626.250 Gb |         |             |
| Bit error rate             | > 1.26E-08*    |         |             |
| Bit errors since last lock | 893472*        |         |             |
| Total bits since last lock | 144,471.793 Gb |         |             |
| BER since last lock        | > 6.18E-09*    |         |             |

### 10.4.7.47 show link tracking group

The **show link tracking group** command displays information about a specified link-state group or about all groups.

#### Command Mode

EXEC

#### Command Syntax

```
show link tracking group [DATA_LEVEL][GROUPS]
```

#### Parameters

- **DATA\_LEVEL** device for which the command provides data. Options include:
  - **no parameter** information about all groups in group list.
  - **detail** detailed information about all groups in group list.
- **GROUPS**
  - **no parameter** all link-state groups.
  - **group\_name** link-state group name.

#### Example

This command displays all the link-state group information.

```
switch#show link tracking group detail
Link State Group: 1 Status: up
Upstream Interfaces : Vlan100
Downstream Interfaces : Vlan200
Number of times disabled : 2
Last disabled 0:10:29 ago

Link State Group: group3 Status: down
Upstream Interfaces : Ethernet24
Downstream Interfaces : Ethernet8
Number of times disabled : 2
Last disabled 0:30:35 ago

Link State Group: 2 Status: up
Upstream Interfaces : Ethernet2 Ethernet5
Downstream Interfaces : Ethernet12
Number of times disabled : 0
Last disabled never
switch#
```

---

#### 10.4.7.48 show mac address-table count

The `show mac-address-table count` command displays the number of entries in the MAC address table for the specified VLAN or for all VLANs.

##### Command Mode

EXEC

##### Command Syntax

```
show mac address-table count [VLANS]
```

##### Parameters

- **VLANS** The VLANs for which the command displays the entry count.
  - *no parameter* all configured VLANs.
  - **vlan v\_num** VLAN interface specified by *v\_num*.

##### Example

This command displays the number of entries on **VLAN 39**.

```
switch>show mac address-table count vlan 39

Mac Entries for Vlan 39:

Dynamic Address Count : 1
Unicast Static Address Count : 1
Multicast Static Address Count : 0
Total Mac Addresses : 2

switch>
```



### 10.4.7.49 show mac address-table mlag-peer

The `show mac-address-table mlag-peer` command displays the specified MAC address table entries learned from the MLAG peer switch.

#### Command Mode

EXEC

#### Command Syntax

```
show mac address-table mlag-peer [ENTRY_TYPE][MAC_ADDR][INTF_1 ... INTF_N][VLAN]
```

#### Parameters

- **ENTRY\_TYPE** command filters display by entry type. Entry types include mlag-peer, dynamic, static, unicast, multicast entries, and configured.
  - **no parameter** all MLAG peer entries.
  - **configured** static entries on MLAG peer; includes unconfigured VLAN entries.
  - **dynamic** entries learned on MLAG peer.
  - **static** MLAG entries entered by CLI commands and include a configured VLAN.
  - **unicast** MLAG entries with unicast MAC address.
- **MAC\_ADDR** command uses MAC address to filter displayed entries.
  - **no parameter** all MAC addresses table entries.
  - **address mac\_address** displays entries with specified address (dotted hex notation – H.H.H).
- **INTF\_X** command filters display by port list. When parameter lists multiple interfaces, command displays all entries containing at least one listed interface.
  - **no parameter** all Ethernet and port channel interfaces.
  - **ethernet e\_range** Ethernet interfaces specified by **e\_range**.
  - **port-channel p\_range** Port channel interfaces specified by **p\_range**.
- **VLAN** command filters display by VLAN.
  - **no parameter** all VLANs.
  - **vlan v\_num** VLANs specified by **v\_num**.

#### Related Commands

- [show mac address-table](#)
- [show mac address-table multicast](#)

---

#### 10.4.7.50 show mac address-table multicast brief

The `show mac-address-table` command displays a summary of multicast MAC address table entries.

##### Command Mode

EXEC

##### Command Syntax

```
show mac address-table multicast [VLANS] brief
```

##### Parameters

- **VLANS** command filters display by VLAN.
  - *no parameter* all VLANs.
  - **vlan v\_num** VLANs specified by **v\_num**.

##### Related Command

[show mac address-table multicast](#).

### 10.4.7.51 show mac address-table multicast

The `show mac-address-table` command displays the specified multicast MAC address table entries.

#### Command Mode

EXEC

#### Command Syntax

```
show mac address-table multicast [MAC_ADDR][INTF][VLANS]
```

#### Parameters

- **MAC\_ADDR** command uses MAC address to filter displayed entries.
  - *no parameter* all MAC addresses table entries.
  - **address mac\_address** displays entries with specified address (dotted hex notation – H.H.H).
- **INTF** command filters display by port list. When parameter lists multiple interfaces, command displays all entries containing at least one listed interface.
  - *no parameter* all Ethernet and port channel interfaces.
  - **ethernet e\_range** Ethernet interfaces specified by **e\_range**.
  - **port-channel p\_range** Port channel interfaces specified by **p\_range**.
- **VLANS** command filters display by VLAN.
  - *no parameter* all VLANs.
  - **vlan v\_num** VLANs specified by **v\_num**.

#### Related Commands

- [show mac address-table](#)
- [show mac address-table multicast brief](#)

## 10.4.7.52 show mac address-table

The `show mac address-table` command displays the specified MAC address table entries.

### Command Mode

EXEC

### Command Syntax

```
show mac address-table [ENTRY_TYPE][MAC_ADDR][INTF_1 ... INTF_N][VLANS]
```

### Parameters

- **ENTRY\_TYPE** command filters display by entry type. Entry types include mlag-peer, dynamic, static, unicast, multicast entries, and configured.
  - **no parameter** all table entries.
  - **configured** static entries; includes unconfigured VLAN entries.
  - **dynamic** entries learned by the switch.
  - **static** entries entered by CLI commands and include a configured VLAN.
  - **unicast** entries with unicast MAC address.
- **MAC\_ADDR** command uses MAC address to filter displayed entries.
  - **no parameter** all MAC addresses table entries.
  - **address mac\_address** displays entries with specified address (dotted hex notation – H.H.H).
- **INTF\_X** command filters display by port list. When parameter lists multiple interfaces, command displays all entries containing at least one listed interface.
  - **no parameter** all Ethernet and port channel interfaces.
  - **ethernet e\_range** Ethernet interfaces specified by **e\_range**.
  - **port-channel p\_range** Port channel interfaces specified by **p\_range**.
- **VLANS** command filters display by VLAN.
  - **no parameter** all VLANs.
  - **vlan v\_num** VLANs specified by **v\_num**.

### Related Commands

- [show mac address-table mlag-peer](#)
- [show mac address-table multicast](#)

### Examples

- This command displays the MAC address table.

```
switch>show mac address-table
 Mac Address Table

Vlan Mac Address Type Ports Moves Last Move

 101 001c.8224.36d7 DYNAMIC Po2 1 9 days, 15:57:28 ago
 102 001c.8220.1319 STATIC Po1 1 0:05:05 ago
 102 001c.8229.a0f3 DYNAMIC Po1 1 0:05:05 ago
 661 001c.8220.1319 STATIC Po1 1 0:20:10 ago
 661 001c.822f.6b22 DYNAMIC Po7 1 0:20:10 ago
3000 001c.8220.1319 STATIC Po1 1 0:07:38 ago
3000 0050.56a8.0016 DYNAMIC Po1 1 0:07:38 ago
3902 001c.8220.1319 STATIC Po1 1 0:07:38 ago
3902 001c.822b.a80e DYNAMIC Po4 2 9 days, 15:57:30 ago
3903 001c.8220.1319 STATIC Po1 1 0:07:38 ago
3903 001c.822c.3009 DYNAMIC Po5 1 4 days, 15:13:03 ago
3908 001c.8220.1319 STATIC Po1 1 0:07:38 ago
3908 001c.822c.4e1d DYNAMIC Po1 1 0:07:26 ago
3908 001c.822c.55d9 DYNAMIC Po1 1 0:04:33 ago
3909 001c.8220.1319 STATIC Po1 1 0:07:38 ago
3909 001c.822f.6a80 DYNAMIC Po1 1 0:07:08 ago
3910 001c.730f.6a80 DYNAMIC Et9 1 4 days, 15:13:07 ago
```

```

3911 001c.8220.1319 STATIC Po1
3911 001c.8220.40fa DYNAMIC Po8 1 1:19:58 ago
3912 001c.822b.033e DYNAMIC Et11 1 9 days, 15:57:23 ago
3913 001c.8220.1319 STATIC Po1
3913 001c.822b.033e DYNAMIC Po1 1 0:04:35 ago
3984 001c.8220.178f DYNAMIC Et8 1 4 days, 15:07:29 ago
3992 001c.8220.1319 STATIC Po1
3992 001c.8221.07b9 DYNAMIC Po6 1 4 days, 15:13:15 ago
Total Mac Addresses for this criterion: 25

```

Multicast Mac Address Table

```

Vlan Mac Address Type Ports

Total Mac Addresses for this criterion: 0
switch>

```

- This command displays the MAC address learning status on **VLAN 10**.

```

switch(config)#vlan 10
switch(config-vlan-10)#no mac address learning
switch(config-vlan-10)#show mac address-table
 Mac Address Table

Vlan Mac Address Type Ports Moves Last Move

Total Mac Addresses for this criterion: 0

 Multicast Mac Address Table

Vlan Mac Address Type Ports

Total Mac Addresses for this criterion: 0

VLANs with disabled MAC learning: 10

```

---

### 10.4.7.53 show monitor server-failure history

The **show monitor server-failure history** command displays the time of all link failures detected by Rapid Automated Indication of Link-Loss (RAIL) and includes the interface name for each failure.

The history is cleared by removing RAIL from the switch (**no monitor server-failure**).

#### Command Mode

EXEC

#### Command Syntax

```
show monitor server-failure history
```

#### Related Command

[clear server-failure servers inactive](#)

#### Example

This command displays the Fast Server Failure link failure history from the time RAIL is instantiated on the switch.

```
switch>show monitor server-failure history
Total server failures: 4

Server IP Server MAC Interface Last Failed

10.1.67.92 01:22:ab:cd:ee:ff Ethernet17 2013-02-02 11:26:22
44.11.11.7 ad:3e:5f:dd:64:cf Ethernet23 2013-02-10 00:07:56
10.1.1.1 01:22:df:42:78:cd Port-Channel6 2013-02-09 19:36:09
10.1.8.13 01:33:df:ee:39:91 Port-Channel5 2013-02-10 00:03:39

switch>
```

### 10.4.7.54 show monitor server-failure servers

The **show monitor server-failure servers** command displays status and configuration information about each server that RAIL is monitoring. The display format depends on the parameter specified by the command:

- **single IP address:** command displays information about the server at the specified address, including IP address, MAC address, RAIL state, the time of most recent entry of all RAIL states, and the number of failed, proxied, and inactive state entries.
- **no parameter, key specifying a server list:** command displays a table. Each row corresponds to a monitored server. Information that the command displays includes IP address, MAC address, RAIL state, the time of most recent link failure.

#### Command Mode

EXEC

#### Command Syntax

```
show monitor server-failure servers [SERVER_LIST]
```

#### Parameters

- **SERVER\_LIST** Servers for which command displays information. Valid options include:
  - **no parameter** all servers in up, down, and proxying states.
  - **ipv4\_addr** individual server; command displays detailed information.
  - **all** all servers on monitored networks.
  - **inactive** all servers in inactive state.
  - **proxying** all servers in proxying state.

#### Examples

- This command displays RAIL information for the server at IP address **10.11.11.7**.

```
switch>show monitor server-failure servers 10.11.11.7
Server information:
Server Ip Address : 10.11.11.7
MAC Address : ad:3e:5f:dd:64:cf
Current state : down
Interface : Ethernet23
Last Discovered : 2013-01-06 06:47:39
Last Failed : 2013-02-10 00:07:56
Last Proxied : 2013-02-10 00:08:33
Last Inactive : 2013-02-09 23:52:21
Number of times failed : 3
Number of times proxied : 1
Number of times inactive : 18

switch>
```

- This command displays RAIL data for all servers in monitored networks that are in inactive state.

```
switch>show monitor server-failure servers inactive
Inactive servers: 1

Server IP Server MAC Interface State Last Failed

10.1.67.92 01:22:ab:cd:ee:ff Ethernet17 inactive 7 days, 12:48:06
ago

switch>
```

- This command displays RAIL information for all servers in monitored networks that are in up, down, and proxying states.

```
switch>show monitor server-failure servers
Active servers: 4

Server IP Server MAC Interface State Last
Failed

44.11.11.7 ad:3e:5f:dd:64:cf Ethernet23 down
0:03:21 ago
10.1.1.1 01:22:df:42:78:cd Port-Channel6 up
4:35:08 ago
10.1.8.13 01:33:df:ee:39:91 Port-Channel5 proxying
0:07:38 ago
132.23.23.1 00:11:aa:bb:32:ad Ethernet1 up never

switch>
```

- This command displays RAIL information for all servers on configured interfaces.

```
switch>show monitor server-failure servers all
Total servers monitored: 5

Server IP Server MAC Interface State Last Failed

10.1.67.92 01:22:ab:cd:ee:ff Ethernet17 inactive 7 days,
12:47:48 ago
44.11.11.7 ad:3e:5f:dd:64:cf Ethernet23 down 0:06:14 ago
10.1.1.1 01:22:df:42:78:cd Port-Channel6 up 4:38:01 ago
10.1.8.13 01:33:df:ee:39:91 Port-Channel5 proxying 0:10:31 ago
132.23.23.1 00:11:aa:bb:32:ad Ethernet1 up never

switch>
```



### 10.4.7.55 show monitor server-failure

The **show monitor server-failure** command displays Rapid Automated Indication of Link-Loss (RAIL) configuration settings and the number of servers on each monitored network.

#### Command Mode

EXEC

#### Command Syntax

```
show monitor server-failure
```

#### Example

This command displays RAIL configuration status and lists the number of servers that are on each monitored network.

```
switch>show monitor server-failure
Server-failure monitor is enabled
Proxy service: disabled
Networks being monitored: 3
 10.2.1.96/28 : 0 servers
 10.1.1.0/24 : 0 servers
 10.3.0.0/16 : 3 servers
switch>
```

---

### 10.4.7.56 show monitor session

The **show monitor session** command displays the configuration of the specified port mirroring session. The command displays the configuration of all mirroring sessions on the switch when the session name parameter is omitted.

#### Command Mode

EXEC

#### Command Syntax

```
show monitor session SESSION_NAME
```

#### Parameters

- **SESSION\_NAME** Port mirroring session identifier. Options include:
  - **no parameter** displays configuration for all sessions.
  - **label** command displays configuration of the specified session.

#### Example

This command displays the mirroring configuration of the specified monitor session.

```
switch>show monitor session redirect_1

Session redirect_1

Source Ports

 Both: Et7

Destination Port: Et8
switch(config)>
```

### 10.4.7.57 show platform trident mirroring

The **show platform trident mirroring** command displays current parameters of all configured mirroring sessions in Trident series platforms.

#### Command Mode

Privileged EXEC

#### Command Syntax

```
show platform trident mirroring [detail | session]
```

#### Parameters

- **detail** displays the detailed information of all configured mirroring sessions.
- **session *session\_name*** displays the information of specified mirroring session.

#### Guidelines

This command is supported on DCS-7050/7050X, DCS-7250X, and DCS-7300X devices only.

#### Examples

- This command displays the detailed information of all configured mirroring sessions.

```
switch(config)#show platform trident mirroring detail

Session : 123
=====

srcIntf(rx): Ethernet12/3
Hw Mirror Id: 0x1

IM_MTP_INDEX

count: 1
Dest: Et15/1

EGR_IM_MTP_INDEX

DestPort[0]: Et15/1
Encap Enable: 0

srcIntf(tx): Ethernet12/3
Hw Mirror Id: 0x2

EM_MTP_INDEX

count: 1
Dest: Et15/1

EGR_EM_MTP_INDEX

DestPort[0]: Et15/1

Session : abc
=====

srcIntf(rx): Ethernet24/2
Hw Mirror Id: 0x0

IM_MTP_INDEX

count: 1
Dest: Et24/4
```

---

```
EGR_IM_MTP_INDEX

DestPort[0]: Et24/4
 Encap Enable: 0

switch(config)#
```

- This command displays the information of session **123**.

```
switch(config)#show platform trident mirroring session 123

Session SrcIntf Acl DestIntf NextHopMac
 OutIntf
===== ===== === =====
=====
123 Et12/3(rx) Et12/3(tx) Et15/1
 Et12/3(tx) Et15/1

switch(config)#
```

### 10.4.7.58 show port-channel load-balance

The **show port-channel load-balance** command displays the traffic distribution between the member ports of the specified port channels. The command displays distribution for unicast, multicast, and broadcast streams.

- The distribution values displayed are based on the total interface counters which start from zero at boot time or when the counters are cleared. For more current traffic distribution values, clear the interface counters of the member interfaces using the [clear counters](#) command.

#### Command Mode

EXEC

#### Command Syntax

```
show port-channel load-balance [MEMBERS]
```

#### Parameters

- **MEMBERS** List of port channels for which information is displayed. Options include:
  - **no parameter** All configured port channels.
  - **c\_range** Ports in specified channel list (number, number range, or list of numbers and ranges).

#### Example

This command displays traffic distribution for all configured port channels.

```
switch>show port-channel load-balance
ChanId Port Rx-Ucst Tx-Ucst Rx-Mcst Tx-Mcst Rx-Bcst Tx-Bcst

 8 Et10 100.00% 100.00% 100.00% 100.00% 0.00% 100.00%

 1 Et1 13.97% 42.37% 47.71% 30.94% 0.43% 99.84%
 1 Et2 86.03% 57.63% 52.29% 69.06% 99.57% 0.16%

 2 Et23 48.27% 50.71% 26.79% 73.22% 0.00% 100.00%
 2 Et24 51.73% 49.29% 73.21% 26.78% 0.00% 0.00%

 4 Et3 55.97% 63.29% 51.32% 73.49% 0.00% 0.00%
 4 Et4 44.03% 36.71% 48.68% 26.51% 0.00% 0.00%

 5 Et19 39.64% 37.71% 50.00% 90.71% 0.00% 0.00%
 5 Et20 60.36% 62.29% 50.00% 9.29% 0.00% 100.00%

 6 Et6 100.00% 100.00% 100.00% 100.00% 0.00% 100.00%

 7 Et5 100.00% 0.00% 100.00% 100.00% 0.00% 0.00%
switch>
```

---

### 10.4.7.59 show port-security interface

The **show port-security interface** command displays the switchport port-security status of all specified interfaces.

#### Command Mode

EXEC

#### Command Syntax

```
show port-security interface [INT_NAME]
```

#### Parameters

- **INT\_NAME** Interface type and numbers. Options include:
  - **no parameter** Display information for all interfaces.
  - **ethernet e\_range** Ethernet interface range specified by **e\_range**.
  - **loopback l\_range** Loopback interface specified by **l\_range**.
  - **management m\_range** Management interface range specified by **m\_range**.
  - **port-channel p\_range** Port-Channel Interface range specified by **p\_range**.
  - **vlan v\_range** VLAN interface range specified by **v\_range**.
  - **vxlan vx\_range** VXLAN interface range specified by **vx\_range**.

Valid **range** formats include number, number range, or comma-delimited list of numbers and ranges.

#### Example

This command display port-security configuration and status for the specified interfaces.

```
switch>show port-security interface ethernet 7-8
Interface : Ethernet7
Port Security : Enabled
Port Status : Secure-down
Violation Mode : Shutdown
Maximum MAC Addresses : 5
Aging Time : 5 mins
Aging Type : Inactivity
SecureStatic Address Aging : Disabled
Total MAC Addresses : 3
Configured MAC Addresses : 3
Learn/Move/Age Events : 5
Last Source Address:Vlan : 164f.29ae.4e14:10
Last Address Change Time : 0:39:47 ago
Security Violation Count : 0

Interface : Ethernet8
Port Security : Disabled
Port Status : Secure-down
Violation Mode : Shutdown
Maximum MAC Addresses : 1
Aging Time : 5 mins
Aging Type : Inactivity
SecureStatic Address Aging : Disabled
switch>
```

### 10.4.7.60 show port-security mac-address

The **show port-security mac-address** command display static unicast MAC addresses assigned to interfaces where switchport port security is enabled.

#### Command Mode

EXEC

#### Command Syntax

```
show port-security mac-address
```

#### Example

This command displays MAC addresses assigned to port-security protected interfaces.

```
switch>show port-security mac-address
Secure Mac Address Table

Vlan Mac Address Type Ports Remaining Age
----- -
 10 164f.29ae.4e14 SecureConfigured Et7 N/A
 10 164f.29ae.4f11 SecureConfigured Et7 N/A
 10 164f.320a.3a11 SecureConfigured Et7 N/A

Total Mac Addresses for this criterion: 3
switch>
```

### 10.4.7.61 show port-security

The **show port-security** command displays a summary of MAC address port security configuration and status on each interface where switchport port security is enabled.

#### Command Mode

EXEC

#### Command Syntax

```
show port-security
```

#### Display Values

Each column corresponds to one physical interface. The table displays interfaces with port security enabled.

- **Secure Port:** Interface with switchport port-security enabled.
- **MaxSecureAddr:** Maximum quantity of MAC addresses that the specified port can process.
- **CurrentAddr:** Static MAC addresses assigned to the interface.
- **SecurityViolation:** Number of frames with unsecured addresses received by port.
- **Security Action:** Action triggered by a security violation.
- These are the value displayed by the command.
- **Aging Time:** Age of Mac address.
- **MAC Moveable:** Mac address movement.
- **Port Security:** Enabled or disabled status

#### Example

This command displays switchport port security configuration and status data.

```
switch>show port-security
Secure Port MaxSecureAddr CurrentAddr SecurityViolation Security Action
 (Count) (Count) (Count)

 Et7 5 3 0 Shutdown
 Et10 1 0 0 Shutdown

Total Addresses in System: 3
switch>
```

From **EOS Release 4.26.0F**, **show port-security** command displays the settings for the new global port security configurations, including MAC aging, MAC moves, and persistent port security.

```
switch(config)#show port-security
Secure address moves: disabled
Secure address aging: disabled
Secure address reboot persistence: enabled
Secure address link down persistence: enabled
Secure Port MaxSecureAddr CurrentAddr SecurityViolation Security
Action
 (Count) (Count) (Count)

Total Addresses in System: 0
```



### 10.4.7.62 show storm-control

The **show storm-control** command displays the storm-control level and interface inbound packet capacity for the specified interface.

The configured value ([storm-control](#)) differs from the programmed threshold in that the hardware accounts for Interframe Gaps (IFG) based on the minimum packet size. This command displays the broadcast or multicast rate after this adjustment.

#### Command Mode

Privileged EXEC

#### Command Syntax

```
show storm-control [INT_NAME]
```

#### Parameters

- **no parameter** Command returns data for all interfaces configured for storm control.
- **INT\_NAME** interface type and port range. Settings include:
  - **ethernet e\_range** Ethernet interfaces that **e\_range** denotes.
  - **port-channel p\_range** Port channel interfaces that **p\_range** denotes.

When storm control commands exist for a port-channel and an Ethernet port that is a member of the port channel, the command for the port-channel takes precedence.

Valid **range** formats include number, number range, or comma-delimited list of numbers and ranges.

#### Example

This command displays the storm control configuration for Ethernet port 2 through Ethernet port 4.

```
switch#show storm-control
Port Type Level Rate (Mbps) Status Drops Reason
Et10/2 all 75 7500 active 0
Et10/3 multicast 55 5500 active 0
Et10/4 broadcast 50 5000 active 0
switch#
```

---

### 10.4.7.63 show switch forwarding-mode

The **show switch forwarding-mode** command displays the switch's current and available forwarding plane hardware modes.

#### Command Mode

EXEC

#### Command Syntax

```
show switch forwarding-mode
```

#### Related Command

[switch forwarding-mode](#) configures the switch's forwarding mode setting.

#### Example

This command changes the switch's forward mode to **store-and-forward**, then displays the forwarding mode.

```
switch(config)#switch forwarding-mode store-and-forward
switch(config)#show switch forwarding-mode
Current switching mode: store and forward
Available switching modes: cut through, store and forward
```

### 10.4.7.64 show track

The **show track** command displays information about tracked objects configured on the switch.

#### Command Mode

EXEC

#### Command Syntax

```
show track [OBJECT][INFO_LEVEL]
```

#### Parameters

- **OBJECT** tracked object for which information is displayed. Options include:
  - **no parameter** displays information for all tracked objects configured on the switch.
  - **object\_name** displays information for the specified object.
- **INFO\_LEVEL** amount of information that is displayed. Options include:
  - **no parameter** displays complete information including object status, number of status changes, time since last change, and client process tracking the object (if any).
  - **brief** displays brief list of all tracked objects and their current status.

#### Examples

- This command displays all information for tracked object **ETH8**.

```
switch#show track ETH8
Tracked object ETH8 is up
 Interface Ethernet8 line-protocol
 4 change, last change time was 0:36:12 ago
 Tracked by:
 Ethernet5/1 vrrp instance 50
switch#
```

- This command displays summary information for all tracked objects.

```
switch#show track brief
Tracked object ETH2 is up
Tracked object ETH4 is down
Tracked object ETH6 is up
Tracked object ETH8 is up
switch#
```

---

#### 10.4.7.65 shutdown (server-failure configuration mode)

The **shutdown** command disables Rapid Automated Indication of Link-Loss (RAIL). By default, RAIL is disabled.

After entering server-failure configuration mode, a **no shutdown** command is required to enable RAIL.

The **no shutdown** command enables RAIL on the switch. The **shutdown** and **default shutdown** commands disable RAIL by removing the shutdown command from *running-config*.

##### Command Mode

Server-failure Configuration

##### Command Syntax

```
shutdown
```

```
no shutdown
```

```
default shutdown
```

##### Examples

- This command enables RAIL on the switch.

```
switch(config)#monitor server
switch(config-server-failure)#no shutdown
switch(config-server-failure)#show active
monitor server-failure
 no shutdown
switch(config-server-failure)#
```

- This command disables RAIL on the switch.

```
switch(config-server-failure)#shutdown
switch(config-server-failure)#show active
monitor server-failure
switch(config-server-failure)#
```

### 10.4.7.66 storm-control

The **storm-control** command configures and enables storm control on the configuration mode physical interface. The command provides three mode options:

- **storm-control all** unicast, multicast, and broadcast inbound packet control.
- **storm-control broadcast** broadcast inbound packet control.
- **storm-control multicast** multicast inbound packet control.

An interface configuration can contain three storm-control statements, one with each mode setting. The **storm-control all** threshold overrides broadcast and multicast thresholds.

The threshold is a percentage of the available port bandwidth and is configurable on each interface for each transmission mode.

The **no storm-control** and **default storm-control** commands remove the corresponding **storm-control** statement from *running-config*, disabling storm control for the specified transmission type on the configuration mode interface.

#### Command Mode

Interface-Ethernet Configuration

Interface-Port-Channel Configuration

#### Command Syntax

```
storm-control MODE level threshold
```

```
no storm-control MODE
```

```
default storm-control MODE
```

#### Parameters

- **MODE** packet transmission type. Options include:
  - **all**
  - **broadcast**
  - **multicast**
- **threshold** Inbound packet level that triggers storm control, as a percentage of port capacity. Value ranges from 0.01 to 100. Storm control is suppressed by a level of 100.

The configured value differs from the programmed threshold in that the hardware accounts for Interframe Gaps (IFG) based on the minimum packet size. The [show storm-control](#) command displays the broadcast or multicast rate after this adjustment.

#### Restrictions

The **storm-control all** option is not available on Arad platform switches.

#### Example

These commands enable multicast and broadcast storm control on Ethernet port 20 and sets thresholds of 65% (multicast) and 50% (broadcast). During each one second interval, the interface drops inbound multicast traffic and broadcast traffic in excess of the specified thresholds.

```
switch(config)#interface ethernet 20
switch(config-if-Et20)#storm-control multicast level 65
switch(config-if-Et20)#storm-control broadcast level 50
switch(config-if-Et20)#show active
interface Ethernet20
 storm-control broadcast level 50
 storm-control multicast level 65
switch(config-if-Et20)#
```

---

### 10.4.7.67 switch forwarding-mode

The **switch forwarding-mode** command specifies the mode of the switch's forwarding plane hardware. The default forwarding mode is **cut through**.

The **no switch forwarding-mode** and **default switch forwarding-mode** commands restore the default forwarding mode by removing the **switch forwarding-mode** command from *running-config*.

#### Command Mode

Global Configuration

#### Command Syntax

```
switch forwarding-mode MODE_SETTING
```

```
no switch forwarding-mode
```

```
default switch forwarding-mode
```

#### Parameters

- **MODE\_SETTING** Specifies the switch's forwarding plane hardware mode. Options include:
  - **cut-through** the switch begins forwarding frames before their reception is complete.
  - **store-and-forward** the switch accumulates entire packets before forwarding them.

#### Guidelines

The forwarding plane mode is **store-and-forward** on Petra and Arad platform switches.

#### Related Command

[show switch forwarding-mode](#) displays the current forwarding mode.

#### Example

This command changes the forwarding mode to **store-and-forward**.

```
switch(config)#switch forwarding-mode store-and-forward
switch(config)#
```

### 10.4.7.68 `switchport default mode access`

The `switchport default mode access` command places the configuration mode interface in ***switched port default access*** (Layer 3) mode. Switched ports are configurable as members of one or more VLANs through other switchport commands. Switched ports ignore all IP level configuration commands, including IP address assignments.

#### Command Mode

Global Configuration

#### Command Syntax

```
switchport default mode access
```

#### Related Command

[switchport default mode routed](#) puts a switch with all ports in routed port mode.

#### Example

This command puts a switch with all ports in access port mode.

```
switch(config)#switchport default mode access
```

---

### 10.4.7.69 `switchport default mode routed`

The `switchport default mode routed` command places the configuration mode interface in ***switched port default routed*** (Layer 3) mode. Switched ports are configurable as members of one or more VLANs through other switchport commands. Switched ports ignore all IP level configuration commands, including IP address assignments.

By default, on a switch with default startup config or no config, all ports come up in access mode. By adding the CLI command `switchport default mode routed` to kickstart config, all ports will come up in routed mode after boot up. On boot up, Zero Touch Provisioning (ZTP) is enabled by default if the startup config (/mnt/flash/startupconfig) is deleted. ZTP can be disabled by setting `DISABLE=True` in ZTP config (/mnt/flash/zerotouchconfig). Kickstart config (/mnt/flash/kickstart-config) is used when startup config is missing and ZTP is disabled.

#### Command Mode

Global Configuration

#### Command Syntax

```
switchport default mode routed
```

#### Related Command

[switchport default mode access](#) puts a switch with all ports in access port mode.

#### Example

This command puts a switch with all ports in routed port mode.

```
switch(config)#switchport default mode routed
```



### 10.4.7.70 switchport mac address learning

The **switchport mac address learning** command enables MAC address learning for the configuration mode interface. MAC address learning is enabled by default on all Ethernet and port channel interfaces.

The switch maintains a MAC address table for switching frames between VLAN ports. When the switch receives a frame, it associates the MAC address of the transmitting interface with the recipient VLAN and port. When MAC address learning is enabled for the recipient port, the entry is added to the MAC address table. When MAC address learning is not enabled, the entry is not added to the table.

The **no switchport mac address learning** command disables MAC address learning for the configuration mode interface. The **switchport mac address learning** and **default switchport mac address learning** commands enable MAC address learning for the configuration mode interface by deleting the corresponding **no switchport mac address learning** command from *running-config*.

#### Command Mode

Interface-Ethernet Configuration

Interface-Port Channel Configuration

#### Command Syntax

```
switchport mac address learning
no switchport mac address learning
default switchport mac address learning
```

#### Example

These commands disables MAC address learning for Ethernet interface 8, then displays the active configuration for the interface.

```
switch(config)#interface ethernet 8
switch(config-if-Et8)#no switchport mac address learning
switch(config-if-Et8)#show active
interface Ethernet8
 no switchport mac address learning
switch(config-if-Et8)#
```

---

### 10.4.7.71 `switchport port-security mac-address maximum`

The `switchport port-security mac-address maximum` command specifies the maximum MAC address limit for the configuration mode interface when configured as a secure port. When port security is enabled, the port accepts traffic and adds source addresses to the MAC table until the maximum is reached. Once the maximum is reached, if any traffic arrives from a source not already in the MAC table for the secure port, the port becomes errdisabled. The `switchport port-security` command configures an interface as a secure port.

The `no switchport port-security mac-address maximum` and `default switchport port-security mac-address maximum` commands restore the maximum MAC address limit of one on the configuration mode interface by removing the corresponding `switchport port-security mac-address maximum` command from *running-config*.

#### Command Mode

Interface-Ethernet Configuration

Interface-Port Channel Configuration

#### Command Syntax

```
switchport port-security mac-address maximum max_addr
```

```
no switchport port-security mac-address maximum
```

```
default switchport port-security mac-address maximum
```

#### Parameters

*max\_addr* maximum number of MAC addresses. Value ranges from 1 to 1000. Default value is 1.

#### Example

These commands configure a maximum of five incoming addresses for secure port channel interface 14.

```
switch(config)#interface port-channel 14
switch(config-if-Po14)#switchport port-security mac-address maximum 5
switch(config-if-Po14)#
```

### 10.4.7.72 switchport port-security violation

The **switchport port-security violation** command configures port security in protect mode (with the option of enabling logging) or the shutdown mode.

The **no switchport port-security** and **no switchport port-security violation protect log** commands disable port security protect mode and port security protect mode logging on the configuration mode interface.

#### Command Mode

Interface-Ethernet Configuration

Interface-Port Channel Configuration

#### Command Syntax

```
switchport port-security violation {protect [log] | shutdown}
no switchport port-security violation protect log
default switchport port-security violation protect log
```

#### Parameters

- **protect** configures the port security in the protect mode.
- **shutdown** configures the port security in the shutdown mode.
- **log** *the log of new addresses seen after limit is reached in the protect mode.*

#### Guidelines

When port security is enabled, the port accepts traffic and adds source addresses to the MAC table until the maximum is reached. The **switchport port-security** command configures an interface as a secure port.

In the protect mode, the ACLs are dynamically created to block incoming MAC addresses when the configured maximum MAC value is reached.

In the shutdown mode, once the maximum is reached, if any traffic arrives from a source not already in the MAC table for the secure port, the port is set to be errdisabled.

#### Examples

- These commands configure port security violation protect mode for secure port channel interface 14.

```
switch(config)#interface port-channel 14
switch(config-if-Po14)#switchport port-security violation protect
switch(config-if-Po14)#
```

- These commands configure port security violation protect logging mode for secure port channel interface 14.

```
switch(config)#interface port-channel 14
switch(config-if-Po14)#switchport port-security violation protect log
switch(config-if-Po14)#
```

- These commands configure port security violation shutdown mode for secure port channel interface 15.

```
switch(config)#interface port-channel 15
switch(config-if-Po15)#switchport port-security violation shutdown
switch(config-if-Po15)#
```

---

### 10.4.7.73 `switchport port-security`

The `switchport port-security` command enables MAC address port security on the configuration mode interface. Ports with port security enables restrict traffic to a limited number of hosts, as determined by their MAC addresses. On enabling the `switchport port-security` command, the port-security mode would be 'shutdown', by default.

The `switchport port-security mac-address maximum` command specifies the maximum number of MAC addresses. The `switchport port-security violation` command enables port security in protect mode.

The `no switchport port-security` and `default switchport port-security` commands disable port security on the configuration mode interface by removing the corresponding `switchport port-security` command from *running-config*.

#### Command Mode

Interface-Ethernet Configuration

Interface-Port Channel Configuration

#### Command Syntax

```
switchport port-security
```

```
no switchport port-security
```

```
default switchport port-security
```

#### Example

These commands enable port security on *ethernet interface 7*.

```
switch(config)#interface ethernet 7
switch(config-if-Et7)#switchport port-security
switch(config-if-Et7)#
```

### 10.4.7.74 switchport

The **switchport** command places the configuration mode interface in **switched port** (Layer 2) mode. Switched ports are configurable as members of one or more VLANs through other switchport commands. Switched ports ignore all IP level configuration commands, including IP address assignments.

The **no switchport** command places the configuration mode interface in **routed port** (Layer 3) mode. Routed ports are not members of any VLANs and do not switch or bridge packets. All IP level configuration commands, including IP address assignments, apply directly to the routed port interface.

By default, Ethernet and Port Channel interfaces are in switched port mode. The **default switchport** command also places the configuration mode interface in switched port mode by removing the corresponding **no switchport** command from **running-config**.

These commands only toggle the interface between switched and routed modes. They have no effect on other configuration states.

#### Command Mode

Interface-Ethernet Configuration

Interface-Port Channel Configuration

#### Command Syntax

```
switchport
```

```
no switchport
```

```
default switchport
```

#### Guidelines

When an interface is configured as a routed port, the switch transparently allocates an internal VLAN whose only member is the routed interface. Internal VLANs are created in the range from 1006 to 4094. VLANs that are allocated internally for a routed interface cannot be directly created or configured. The **vlan internal order** command specifies the method that VLANs are allocated.

All IP-level configuration commands, except **autostate** and **ip virtual-router**, can be used to configure a routed interface. Any IP-level configuration changes made to a routed interface are maintained when the interface is toggled to switched port mode.

A LAG that is created with the **channel-group** command inherits the mode of the member port. A LAG created from a routed port becomes a routed LAG. IP-level configuration statements are not propagated to the LAG from its component members.

#### Examples

- These commands put Ethernet interface 5 in routed port mode.

```
switch(config)#interface ethernet 5
switch(config-if-Et5)#no switchport
switch(config-if-Et5)#
```

- These commands returns Ethernet interface 5 to switched port mode.

```
switch(config)#interface ethernet 5
switch(config-if-Et5)#switchport
switch(config-if-Et5)#
```

---

### 10.4.7.75 system control-plane

The **system control-plane** command places the switch in control-plane configuration mode. Control-plane mode is used for assigning an ACL (access control list) to the control plane.

Control-plane configuration mode is not a group change mode; **running-config** is changed immediately after commands are executed. Exiting control-plane configuration mode does not affect the configuration.

The **exit** command returns the switch to global configuration mode.

#### Command Mode

Global Configuration

#### Command Syntax

```
system control-plane
```

#### Command Available in control-plane Configuration Mode

[ip access-group \(Control Plane mode\)](#)

#### Examples

- This command places the switch in control plane mode.

```
switch(config)#system control-plane
switch(config-system-cp)
```

- This command assigns the **control-plane-2** ACL to the control plane.

```
switch(config-system-cp)#ip access-group control-plane-2
switch(config-system-cp)
```

- This command exits control plane mode.

```
switch(config-system-cp)#exit
switch(config)
```

### 10.4.7.76 track

The **track** command creates an object whose state changes to provide information to a client process. The client process must be separately configured for object tracking to have an effect on the switch.

The **no track** and **default track** commands remove the specified tracked object by removing the corresponding **track** command from *running-config*.

#### Command Mode

Global Configuration

#### Command Syntax

```
track object_name interface INTERFACE_NAME PROPERTY
```

```
no track object_name
```

```
default track object_name
```

#### Parameters

- *object\_name* User-created name for the tracked object.
- INTERFACE\_NAME Interface associated with the tracked object. Options include:
  - ethernet *e\_num* Ethernet interface specified by *e\_num*.
  - loopback *l\_num* Loopback interface specified by *l\_num*.
  - management *m\_num* Management interface specified by *m\_num*.
  - port-channel *p\_num* Port-channel interface specified by *p\_num*.
  - vlan *v\_num* VLAN interface specified by *v\_num*.
  - vxlan *vx\_num* VXLAN interface specified by *vx\_num*.
- PROPERTY Tracked property. Options include:
  - line-protocol Object changes when the state of the associated interface changes.

#### Example

This command creates a tracked object which tracks the state of the line protocol on *Ethernet interface 8*.

```
switch(config)#track ETH8 interface ethernet 8 line-protocol
switch(config)#
```

### 10.4.7.77 traffic-loopback

The **traffic-loopback** command is used to create loopbacks to verify the functionality of interfaces and partner links. The **source** determines whether outgoing traffic is being looped back to the interface (**system**) to test the interface itself, or incoming traffic is being looped back to the link partner (**network**) to test the link between the systems. The **device** determines whether **system** traffic is looped on the physical level (**phy**) or Layer-2 level (**mac**). Only the **phy** level is available for **network** traffic.

The **no traffic-loopback** command deletes the loopback configuration.

#### Command Mode

Interface Configuration

#### Command Syntax

```
traffic-loopback source [system|network] device [phy|mac]
no traffic-loopback
```

#### Parameters

- **system** loops outgoing traffic back to the interface
- **network** loops incoming traffic back to the link partner
- **phy** implements loopback in the physical layer
- **mac** implements loopback in the MAC layer (available only for **system** traffic)

#### Examples

- These commands cause outgoing traffic on Ethernet interface 1 to be looped back to the interface at the MAC level.

```
switch(config)#interface ethernet 1
switch(config-if-Et1)#traffic-loopback source system device mac
switch(config-if-Et1)#
```

- These commands cause incoming traffic on Ethernet interface 1 to be looped back to the link partner at the physical level.

```
switch(config)#interface ethernet 1
switch(config-if-Et1)#traffic-loopback source network device phy
switch(config-if-Et1)#
```

- These commands delete the loopback configuration from Ethernet interface 1.

```
switch(config)#interface ethernet 1
switch(config-if-Et1)#no traffic-loopback
switch(config-if-Et1)#
```



## Layer 2 Configuration

---

This chapter contains the following sections:

- [Spanning Tree Protocol](#)
- [Link Layer Discovery Protocol](#)
- [Virtual LANs \(VLANs\)](#)
- [DCBX and Flow Control](#)
- [IP Locking](#)
- [Layer 2 Subinterfaces](#)

### 11.1 Spanning Tree Protocol

Spanning Tree Protocols prevent bridging loops in Layer 2 Ethernet networks. Arista switches support Rapid Spanning Tree, Multiple Spanning Tree, and Rapid-Per VLAN Spanning Tree protocols.

These sections describe the Arista Spanning Tree Protocol implementation.

- [Introduction to Spanning Tree Protocols](#)
- [Spanning Tree Overview](#)
- [Configuring a Spanning Tree](#)
- [STP Commands](#)

#### 11.1.1 Introduction to Spanning Tree Protocols

Arista Switches support the leading spanning tree protocols: RSTP, MST and Rapid-PVST. This variety of options simplifies integration into existing networks without compromising network reliability, scalability or performance.

#### 11.1.2 Spanning Tree Overview

An Ethernet network functions properly when only one active path exists between any two stations. A spanning tree is a loop-free subset of a network topology. STP is a L2 network protocol that ensures a loop-free topology for any bridged Ethernet LAN. STP allows a network to include spare links as automatic backup paths that are available when an active link fails without creating loops or requiring manual intervention. The original STP is standardized as IEEE 802.1D.

Several variations to the original STP improve performance and add capacity. Arista switches support these STP versions:

- Rapid Spanning Tree (RSTP)
- Multiple Spanning Tree (MSTP)
- Rapid Per-VLAN Spanning Tree (Rapid-PVST)

The Overview contains the following sections:

- [Spanning Tree Protocol Versions](#)
- [Structure of a Spanning Tree Instance](#)
- [BPDU](#)s

---

### 11.1.2.1 Spanning Tree Protocol Versions

STP versions supported by Arista switches address two limitations of the original Spanning Tree protocol that was standardized as IEEE 802.1D:

- Slow convergence to the new spanning tree topology after a network change
- The entire network is covered by one spanning tree instance.

The following sections describe the supported STP versions, compatibility issues in networks containing switches running different STP versions, and supported alternatives to spanning tree.

#### 11.1.2.1.1 Rapid Spanning Tree Protocol (RSTP)

RSTP is specified in **802.1w** and supersedes STP. RSTP provides rapid convergence after network topology changes. Similar to STP, RSTP provides a single instance of spanning tree for the entire network. Standard **802.1D-2004** incorporates RSTP and obsoletes STP.

The RSTP instance is the base unit of MST and Rapid-PVST spanning trees.

#### 11.1.2.1.2 Rapid Per-VLAN Spanning Tree Protocol (Rapid-PVST)

Rapid Per-VLAN Spanning Tree (PVST) extends the original STP to support a spanning tree instance on each VLAN in the network. The maximum number of PVST instances that can be created on a switch depends on the hardware platform. In most of the cases, it is 510. PVST can load balance Layer-2 traffic without creating a loop because it handles each VLAN as a separate network. However, PVST does not address slow network convergence after a network topology change.

Arista switches support Rapid-PVST, which is a variation of PVST based on RSTP instances. Rapid-PVST provides rapid connectivity recovery after the failure of a bridge, port, or LAN. Rapid-PVST can be enabled or disabled on individual VLANs.

#### 11.1.2.1.3 Multiple Spanning Tree Protocol (MSTP)

MST extends rapid spanning tree protocol (RSTP) to support multiple spanning tree instances on a network, but is still compatible with RSTP. By default, Arista switches use MSTP.

MST supports multiple spanning tree instances, similar to Rapid PVST. However, MST associates an instance with multiple VLANs. This architecture supports load balancing by providing numerous forwarding paths to data traffic. Network fault tolerance is improved because failures in one instance do not affect other instances.

##### **MST Regions**

An *MST region* is a group of connected switches with identical MST configuration. Each region can support a maximum of 65 spanning-tree instances. MST regions are identified by a version number, name, and VLAN-to-instance map. You must configure identical parameters on all switches in the regions. Only MST region members participate with the MST instances defined in the region. A VLAN can be simultaneously assigned to only one spanning-tree instance. MST does not specify the maximum number of regions that a network can contain.

##### **MST Instances**

Each MST instance is identified by an instance number that ranges from 0 to 4094 and is associated with a set of VLANs. An MST region contains two types of spanning tree instances: an Internal Spanning Tree Instance (IST) and Multiple Spanning Tree Instances (MSTI).

- IST is the default spanning tree instance in MST regions; and is always zero. It gives a root switch to the region that contains all VLANs configured across all switches in the region but not assigned to a MST instance.

- *Multiple Spanning Tree instances* (MSTIs) consist of VLANs that are assigned through MST configuration statements. VLANs assigned to an MSTI are removed from the IST instance. VLANs in an MSTI operate as a part of a single Spanning Tree topology. Because each VLAN can belong to only one instance, MST instances (and the IST) are topologically independent.

### MSTP-Rapid PVST+ interoperation

MSTP-Rapid PVST+ interoperation allows protocol-level interaction between MSTP and Rapid PVST+ by consuming and transmitting PVST BPDUs through MSTP at the border ports. While transmitting from Rapid PVST+ to MSTP or vice-versa, you can deploy MSTP in certain regions and Rapid PVST+ in other regions based on their merits or other factors. MSTP-Rapid PVST+ interoperation allows MSTP to work with any Rapid PVST+ implementation.

MSTP inter-operation can be viewed as bi-directional BPDU conversion occurring at MSTP PVST+ border ports as following:

- The outgoing Common Internal Spanning Tree (CIST) BPDU is projected as Rapid PVST+ BPDUs across various VLANs.
- Incoming PVST+ topology BPDU is mapped to corresponding MSTI based on incoming VLAN.

The following restrictions are enforced based on port role. These are relevant only for border ports with roles designated or root (for CIST) that can potentially forward.

- Case (A): If the MSTP-Rapid PVST+ border port role is designated for CIST, it should not receive any superior PVST BPDU (with respect to CIST). Root of all VLANs in the PVST region should be towards the MSTP region.
- Case (B): If the MSTP-Rapid PVST+ border port role is root for CIST, it should not receive any inferior Rapid PVST+ BPDU (with respect to CIST). Root of all VLANs in the Rapid PVST+ region should be within the PVST+ region.



**Note:** If the restrictions are violated, the port enters blocking state. The BPDU translation occurs only on MSTP-Rapid PVST+ border ports with the forwarding state for CIST.

It is desirable to configure multiple MSTP-Rapid PVST+ border ports conforming to Case(A) for a specified Rapid PVST+ region as it allows VLAN load balancing across the ports. This can be achieved by adjusting the per-VLAN port cost towards the Rapid PVST+ region such that the per-VLAN root port is evenly distributed across the border ports.

#### 11.1.2.1.4 Version Interoperability

A network can contain switches running different spanning tree versions. The common spanning tree (CST) is a single forwarding path the switch calculates for STP, RSTP, MSTP, and Rapid-PVST topologies in networks containing multiple spanning tree variations.

In multi-instance topologies, the following instances correspond to the CST:

- **Rapid-PVST:** VLAN 1
- **MST:** IST (instance 0)

RSTP and MSTP are compatible with other spanning tree versions:

- An RSTP bridge sends 802.1D (original STP) BPDUs on ports connected to an STP bridge.
- RSTP bridges operating in 802.1D mode remain in 802.1D mode even after all STP bridges are removed from their links.
- An MST bridge detects a port is at a region boundary when it receives an STP BPDU or an MST BPDU from a different region.
- MST ports assume they are boundary ports when the bridges to which they connect join the same region.

The `clear spanning-tree detected-protocols` command forces MST ports to renegotiate with their neighbors.

---

### 11.1.2.1.5 Switchport Interface Pairs

Switchport interface pairs associate two interfaces in a primary-backup configuration. When the primary interface is functioning, the backup interface remains dormant in standby mode. When the primary interface stops functioning, the backup interface handles the traffic.

An alternative implementation balances traffic between the primary and backup interfaces. If either interface shuts down, the other handles traffic addressed to the pair.

The following guidelines apply to switchport interface pairs.

- Ethernet and Port Channels can be primary interfaces.
- Ethernet, Port Channel, Management, Loopback, and VLAN interfaces can be backup interfaces.
- The primary and backup interfaces can be different interface types.
- Interface pairs should be similarly configured to ensure consistent behavior.
- An interface can be associated with a maximum of one backup interface.
- An interface can back up a maximum of one interface.
- Any Ethernet interface configured in an interface pair cannot be a port channel member.
- STP is disabled on ports configured as primary or backup interfaces.
- Static MAC addresses should be configured after primary-backup pairs are established.

### 11.1.2.2 Structure of a Spanning Tree Instance

A Layer 2 network consists of bridges and network segments. A loop exists when multiple active paths connect two components. Spanning tree protocols allow only one active path between any two network components. Loops are removed by blocking selected ports that connect bridges to network segments.

Ports are assigned cost values that reflect their transmission speed and any other criteria selected by the administrator. Ports with faster transmission speeds and other desirable characteristics are assigned lower costs. High cost ports are blocked in deference to lower cost ports.

A network topology defines multiple possible spanning trees. Network bridges collectively compute and implement one spanning tree to maintain connectivity between all network components while blocking ports that could result in loops. Administrators improve network performance by adjusting parameter settings to select the most efficient spanning tree.

Spanning tree bridges continuously transmit topology information to notify all other bridges on the network when topology changes are required, such as when a link fails. Bridge Protocol Data Units (BPDUs) are STP information packets that bridges exchange.

The following sections describe spanning tree configuration parameters.

#### 11.1.2.2.1 Root and Designated Bridges

The **root bridge** is the center of the STP topology. A spanning tree instance has one root bridge. Spanning tree bases path calculations on each network components distance from the root bridge.

All other network bridges calculate paths to the root bridge when selecting spanning tree links. STP calculates the distance to the root bridge to build a loop-free topology that features the shortest distance between devices among all possible paths.

Each switch is assigned a unique bridge ID number for each instance. All network switches collectively elect the root bridge by comparing bridge IDs. The root bridge is the switch with the lowest bridge ID.

The bridge ID contains the following eight bytes, in order of decreasing significance:

- Port priority (four bits)
- Instance number (12 bits): VLAN number (Rapid-PVST); instance number (MST); 0 (RST)
- MAC address of switch (six bytes)

A **designated bridge** is defined for each network segment as the switch that provides the segments shortest path to the root bridge. A designated bridge is selected for each segment after a root bridge is selected; a switch can be a designated bridge for multiple segments.

The following network calculations in [Spanning Tree Network Example](#) assume that each path has the same cost:

- Switch B is the root bridge its bridge ID is lowest because it has the smallest port priority.
- Switch A is the designated bridge for VLAN 11.
- Switch B is the designated bridge for VLAN 10, VLAN 13, VLAN 16, VLAN 18, VLAN 19.
- Switch C is the designated bridge for VLAN 25.
- Switch D is the designated bridge for VLAN 21, VLAN 23.

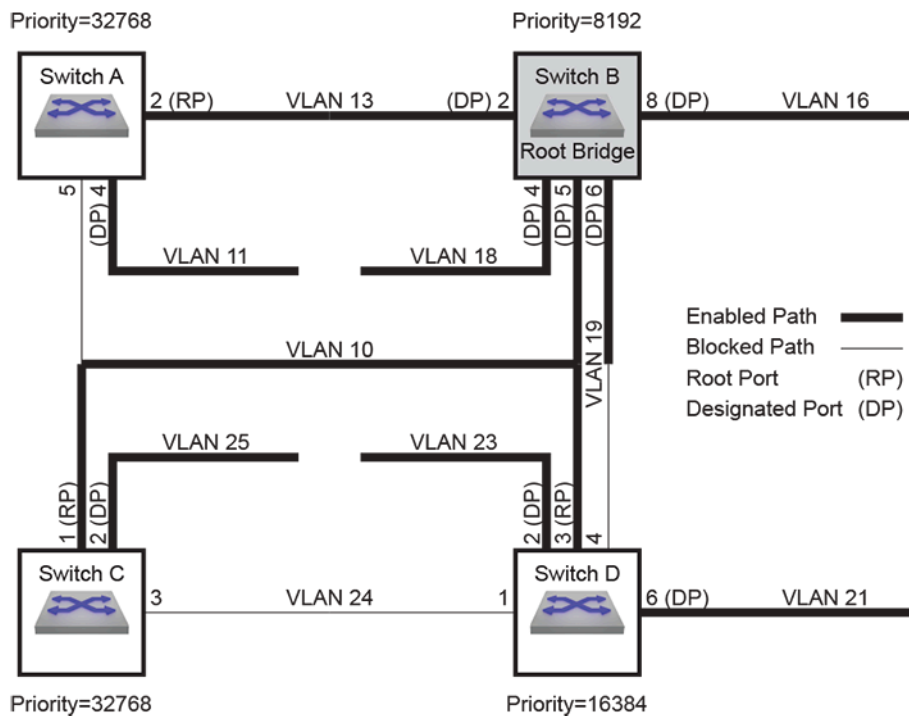

**Figure 26: Spanning Tree Network Example**

### 11.1.2.2.2 Port Roles

Messages from connected devices to the root bridge traverse a least-cost path, which has the smallest cost among all possible paths to the root bridge. The cost of a path is the sum of the costs of all path segments, as defined through port cost settings.

Active ports in a least cost-path fulfill one of two possible roles: root port and designated port. STP blocks all other network ports. STP also defines alternate and backup ports to handle traffic when an active port is inaccessible.

- Root Port (RP) accesses the bridges least-cost path to the root bridge. Each bridge selects its root port after calculating the cost of each possible path to the root bridge.

The following ports in [Spanning Tree Network Example](#) are root ports:

- **Switch A:** port 2
- **Switch C:** port 1
- **Switch D:** port 3

- 
- Designated port (DP) accesses a network segments designated bridge. Each segment defines one DP. Switches can provide DPs for multiple segments. All ports on the root bridge are DPs.

The following ports in [Spanning Tree Network Example](#) are designated ports:

- **Switch A:** port 4 (VLAN 11)
- **Switch B:** port 2 (VLAN 13), port 4 (VLAN 18), port 5 (VLAN 10), port 6 (VLAN 19), port 8 (VLAN 16)
- **Switch C:** port 2 (VLAN 25)
- **Switch D:** port 2 (VLAN 23), port 6 (VLAN 21)
- Alternate ports provide backup paths from their bridges to the root bridge. An alternate port is blocked until a network change transforms it into a root port.
- Backup ports provide alternative paths from VLANs to their designated bridges. A backup port is blocked until a network change transforms it into a designated port.

#### 11.1.2.2.3 Port Activity States

A ports activity state defines its current STP activity level. STP monitors BPDUs for network changes that require an activity state transition.

STP defines three port activity states:

- **Forwarding:** The port receives and sends data. Root ports and designated ports are either in, or transitioning to, this state.
- **Discarding:** The port does not receive or send data. Blocked ports receive BPDU packets. All ports except RPs and DPs are blocked, including alternate and backup ports.
- **Learning:** The transitional post-discarding state where the port prepares to forward frames by adding source addresses from inbound data packets to the switching database.

#### 11.1.2.2.4 Port Types

Port type is a configurable parameter that reflects the type of network segment that is connected to the port. Proper port type configuration results in rapid convergence after network topology changes. RSTP port types include normal, network, and edge ports. Normal is the default port type.

- **Normal** ports have an unspecified topology.
- **Network** ports connect only to switches or bridges.

RSTP immediately transitions network ports to the discarding state.

- **Edge** ports connect directly to end stations.

Edge ports transition directly to forwarding state because they do not create loops. An edge port becomes a normal port when it receives a BPDU.

#### 11.1.2.2.5 Link Types

Link type is a configurable parameter that determines candidates for RSTP fast state transition.

- the default link type for full-duplex ports is **point-to-point**.
- the default link type for half-duplex ports is **shared**.

Fast state transitions are allowed on point-to-point links that connect bridges. Fast state transitions are not allowed on shared ports regardless of the duplex setting.

#### 11.1.2.3 BPDUs

Spanning tree rules specify a root bridge, select designated bridges, and assign roles to ports. STP rule implementation requires that network topology information is available to each switch.

Switches exchange topology information through bridge protocol data units (BPDUs). Information provided by BPDU packets include bridge IDs and root path costs.

### 11.1.2.3.1 BPDU Types

STP defines three BPDU types:

- Configuration BPDU (CBPDU), used for computing the spanning tree.
- Topology Change Notification (TCN) BPDU, announces network topology changes.
- Topology Change Notification Acknowledgment (TCA), acknowledges topology changes.

Bridges enter the following addresses in outbound BPDU frames:

- source address: outbound port's MAC address.
- destination address: STP multicast address **01:80:C2:00:00:00**.

Bridges regularly exchange BPDUs to track network changes that trigger STP recomputations and port activity state transitions. The *hello timer* specifies the period between consecutive BPDU messages; the default is two seconds.

### 11.1.2.3.2 Bridge Timers

Bridge timers specify parameter values that the switch includes in BPDU packets that it sends as a root bridge. Bridge timers include:

- **hello-time**: transmission interval between consecutive BPDU packets.
- **forward-time**: the period that ports remain in learning state.
- **max-age**: the period that BPDU data remains valid after it is received.
- **max-hop**: the number of bridges in an MST region that a BPDU can traverse before it is discarded.

The switch recomputes the spanning tree topology if it does not receive another BPDU before the max-age timer expires. When **edge** ports and **point-to-point** links are properly configured, RSTP network convergence does not require forward-delay and max-age timers.

### 11.1.2.3.3 MSTP BPDUs

MSTP BPDUs are targeted at a single instance and provide STP information for the entire region. MSTP encodes a standard BPDU for the IST, then adds region information and MST instance messages for all configured instances, where each message conveys spanning tree data for an instance. Frames assigned to VLANs operate in the instance to which the VLAN is assigned. Bridges enter an MD5 digest of the VLAN-to-instance map table in BPDUs to avoid including the entire table in each BPDU. Recipients use this digest and other administratively configured values to identify bridges in the same MST region.

MSTP BPDUs are compatible with RSTP. RSTP bridges view an MST region as a single-hop RSTP bridge regardless of the number of bridges inside the region because:

- RSTP bridges interpret MSTP BPDUs as RSTP BPDUs.
- RSTP bridges increment the **message age timer** only once while data flows through an MST region; MSTP measures **time to live** with a **remaining hops** variable, instead of the **message age timer**.

Ports at the edge of an MST region connecting to a bridge (RSTP or STP) or to an endpoint are *boundary ports*.

## 11.1.3 Configuring a Spanning Tree

These sections describe the following configuration processes:

- [Version Configuration and Instance Creation](#)

- 
- [Spanning Tree Instance Configuration](#)
  - [Port Roles and Rapid Convergence](#)
  - [Configuring BPDU Transmissions](#)

### 11.1.3.1 Version Configuration and Instance Creation

The switch supports three STP versions and switchport backup interface pairs. Disabling spanning tree is also supported but not recommended.

The `spanning-tree mode` global configuration command specifies the spanning tree version the switch runs. This section describes command options that enable and configure STP versions.

#### 11.1.3.1.1 Multiple Spanning Tree (MST)

Multiple Spanning Tree is enabled by the `spanning-tree mode` command with the `mstp` option. MSTP is the default STP version.

##### Example

This command enables Multiple Spanning Tree.

```
switch(config)#spanning-tree mode mstp
switch(config)#
```

### Configuring MST Regions

All switches in an MST region must have the same name, revision, and VLAN-to-instance map. MST configuration mode commands sets the region parameters. MST configuration mode is a group-change mode where changes are saved by exiting the mode.

##### Example

The `spanning-tree mst configuration` command places the switch in MST configuration mode.

```
switch(config)#spanning-tree mst configuration
switch(config-mst)#
```

The `instance` command assigns VLANs to MST instances. The `name (mst-configuration mode)` and `revision (mst-configuration mode)` commands configure the MST region name and revision.

##### Examples

- These commands assign VLANs 4-7 and 9 to instance 8 and remove VLAN 6 from instance 10.

```
switch(config-mst)#instance 8 vlans 4-7,9
switch(config-mst)#no instance 10 vlans 6
switch(config-mst)#
```

- These commands assign the `name (corporate_1)` and `revision (3)` to the switch.

```
switch(config-mst)#name corporate_1
switch(config-mst)#revision 3
switch(config-mst)#
```

The `exit (mst-configuration mode)` command transitions the switch out of MST configuration mode and saves all pending changes. The `abort (mst-configuration mode)` command exits MST configuration mode without saving the pending changes.

##### Example



This command exits MST configuration mode and saves all pending changes.

```
switch(config-mst) #exit
switch(config) #
```

### Configuring MST Instances

These STP commands provide an optional MST instance parameter. These commands apply to instance 0 when the optional parameter is not included.

- `spanning-tree priority`
- `spanning-tree root`
- `spanning-tree port-priority`

### Examples

- This command configures priority for MST instance 4.

```
switch(config) #spanning-tree mst 4 priority 4096
switch(config) #
```

- Each of these commands configure priority for MST instance 0.

```
switch(config) #spanning-tree mst 0 priority 4096
```

or

```
switch(config) #spanning-tree priority 4096
```

#### 11.1.3.1.2 Rapid Spanning Tree (RST)

Rapid spanning tree is enabled through the `spanning-tree mode rstp` command with the `rstp` option.

### Example

- This command enables Rapid Spanning Tree.

```
switch(config) #spanning-tree mode rstp
switch(config) #
```

These STP commands, when they do not include an optional MST or VLAN parameter, apply to RSTP. Commands that configure MSTP instance 0 also apply to the RSTP instance.

- `spanning-tree priority`
- `spanning-tree root`
- `spanning-tree port-priority`

### Examples

- These commands apply to the RST instance.

```
switch(config) #spanning-tree priority 4096
```

and

```
switch(config) #spanning-tree mst 0 priority 4096
```

- These commands do not apply to the RST instance.

```
switch(config)#spanning-tree mst 4 priority 4096
```

and

```
switch(config)#spanning-tree vlan-id 3 priority 4096
```

**Show** commands (such as `show spanning-tree`) displays the RSTP instance as MST0 (MST instance 0).

### Example

- This command, while the switch is in RST mode, displays RST instance information.

```
switch(config)#show spanning-tree
MST0
 Spanning tree enabled protocol rstp<---RSTP mode indicator
 Root ID Priority 32768
 Address 001c.730c.1867
 This bridge is the root

 Bridge ID Priority 32768 (priority 32768 sys-id-ext 0)
 Address 001c.730c.1867
 Hello Time 2.000 sec Max Age 20 sec Forward Delay 15
sec

Interface Role State Cost Prio.Nbr Type

Et51 designated forwarding 2000 128.51 P2p

switch(config)#
```

### 11.1.3.1.3 Rapid Per-VLAN Spanning Tree (Rapid-PVST)

Rapid-PVST mode is enabled by the `spanning-tree mode` command with the `rapid-pvst` option.

### Example

- This command enables Rapid Per-VLAN Spanning Tree.

```
switch(config)#spanning-tree mode rapid-pvst
switch(config)#
```

These commands provide an optional VLAN parameter for configuring Rapid-PVST instances.

- `spanning-tree priority`
- `spanning-tree root`
- `spanning-tree port-priority`
- `spanning-tree mst pvst border`

### Examples

- This command configures bridge priority for **VLAN 4**.

```
switch(config)#spanning-tree vlan-id 4 priority 4096
switch(config)#
```

- This command enables MSTP PVST+ border ports. The command is effective only if spanning-tree mode is MSTP.

```
switch(config)#spanning-tree mst pvst border
```

#### 11.1.3.1.4 Switchport Backup Mode

Switchport backup interface pairs are enabled through the `spanning-tree mode` command with the backup option. Enabling switchport backup disables all spanning-tree modes. For loop avoidance under switchport backup mode, use the [Loop Protection](#) feature.

##### Example

This command enables switchport backup.

```
switch(config)#spanning-tree mode backup
switch(config)#
```

The `switchport backup-link` command establishes an interface pair between the command mode interface (primary) and the interface specified by the command (backup).

##### Example

These commands establish **Ethernet interface 7** as the backup port for **Ethernet interface 1**.

```
switch(config)#interface ethernet 1
switch(config-if-Et1)#switchport backup-link ethernet 7
switch(config-if-Et1)#
```

The prefer option of the `switchport backup-link` command establishes a peer relationship between the primary and backup interfaces and specifies VLAN traffic that the backup interface normally carries. If either interface goes down, the other interface carries traffic normally handled by both interfaces.

##### Examples

These steps perform the following:

- configures Ethernet interface 1 as a trunk port that handles VLANs 4 through 9 traffic.
  - configures Ethernet interface 2 as the backup interface.
  - assigns Ethernet 2 as the preferred interface for VLANs 7 through 9.
1. Enter configuration mode for the primary interface.

```
switch(config)#interface ethernet 1
```

2. Configure the primary interface as a trunk port that services VLANs 4-9

```
switch(config-if-Et1)#switchport mode trunk
switch(config-if-Et1)#switchport trunk allowed vlan 4-9
```

3. Configure the backup interface and specify the VLANs that it normally services.

```
switch(config-if-Et1)#switchport backup-link Ethernet 2 prefer vlan 7-9
switch(config-if-Et1)#
```

#### 11.1.3.1.5 Loop Protection

Loop protection is a loop detection and prevention method which is independent of STP and is not disabled when the switch is in switchport backup mode. When loop protection is active on an interface,

---

that interface periodically sends out loop-detection frames; if one is received that originated on the switch, the receiving port is errdisabled until a timeout period has passed or it is manually reset.

Loop protection is configured and enabled per VLAN, but individual ports in a VLAN can be configured to disable loop protection.

 **Note:** Loop protection cannot be enabled on an MLAG peer link.

This feature is disabled by default. To enable it, use the `monitor loop-protection` command to enter loop-protection configuration mode, then use the `no shutdown (Loop-protection)` command to enable the feature. To enable loop protection on a VLAN, use the `protect vlan` command. To exclude a port from loop protection, use the `no loop-protection` command.

The feature is configured with the following additional commands:

- `transmit-interval`
- `disabled-time`
- `rate-limit`

### Examples

- This command enters loop protection configuration mode.

```
switch(config)#monitor loop-protection
switch(config-monitor-loop-protect)#
```

- These commands enable loop protection on VLANs 1025-2000.

```
switch(config)#monitor loop-protection
switch(config-monitor-loop-protect)#no shutdown
switch(config-monitor-loop-protect)#protect vlan 1025-2000
switch(config-monitor-loop-protect)#
```

- These commands exclude **Ethernet interface 38** from loop protection.

```
switch(config)#interface ethernet 38
switch(config-if-Et38)#no loop-protection
switch(config-if-Et38)#
```

- These commands configure loop protection with a transmission interval of **10** seconds, a disabled time of two days, and a maximum rate of **500** loop detection frames per second.

```
switch(config-monitor-loop-protect)#transmit-interval 10
switch(config-monitor-loop-protect)#disabled-time 172800
switch(config-monitor-loop-protect)#rate-limit 500
switch(config-monitor-loop-protect)#
```

#### 11.1.3.1.6 Disabling Spanning Tree

Spanning tree is disabled by the `spanning-tree mode` command with the **none** option. The switch does not generate STP packets. Switchport interfaces forward packets when connected to other ports. The switch forwards inbound STP packets as multicast data packets on the VLAN where they are received.

### Example

This command disables all STP functions.

```
switch(config)#spanning-tree mode none
switch(config)#
```

### 11.1.3.2 Spanning Tree Instance Configuration

A network performs these steps to set up an STP instance:

1. The bridge with the lowest ID is elected root bridge.
2. Root ports (RP) are selected on all other bridges.
3. Designated bridges are selected for each network segment.
4. Designated ports (DP) are selected on each designated bridge.
5. Networks begin forwarding data through RPs and DPs. All other ports are blocked.

#### 11.1.3.2.1 Root Bridge Parameters

STPs use bridge IDs for electing the root bridge. Switches denote a bridge ID for each configured Spanning Tree instance. The bridge ID composition is

- Priority (four bits)

Priority is expressed as a multiple of 4096 because it is stored as the four most significant bits of a two-byte number.

- Protocol Dependent (twelve bits)
  - Rapid-PVST: VLAN number
  - MST: Instance number
  - RST: 0
- MAC address of switch (six bytes)

#### Example

- The switch defines bridge IDs for three MST instances:
  - MST 0: 32768 (Priority (32768)+Instance number(0)) and 001c.7301.23de (MAC address)
  - MST101: 32869 (Priority (32768)+Instance number(101)) and 001c.7301.23de (MAC address)
  - MST102: 32870 (Priority (32768)+Instance number(102)) and 001c.7301.23de (MAC address)

This command displays a table of root bridge information.

```
switch>show spanning-tree root
```

| Instance | Root ID  |                | Root Cost | Hello Time | Max Age | Fwd Dly | Root Port |
|----------|----------|----------------|-----------|------------|---------|---------|-----------|
|          | Priority | MAC addr       |           |            |         |         |           |
| MST0     | 32768    | 001c.7301.23de | 0         | 2          | 20      | 15      | Po937     |
| MST101   | 32869    | 001c.7301.23de | 3998      | 0          | 0       | 0       | Po909     |
| MST102   | 32870    | 001c.7301.23de | 3998      | 0          | 0       | 0       | Po911     |

The switch provides two commands that configure the switch priority: `spanning-tree priority` and `spanning-tree root`. The commands differ in the available parameter options:

- **spanning-tree priority** options are integer multiples of 4096 between 0 and 61440.
- **spanning-tree root** options are primary and secondary.
- **primary** assigns a priority of 8192.
- **secondary** assigns a priority of 16384.

The default priority value is 32768.

The following examples configure bridge IDs with both commands.

#### Examples

- These commands configure MST instance bridge priorities with the **root** command:

```
switch(config)#spanning-tree mst 0 root primary
switch(config)#spanning-tree mst 1 root secondary
```

```
switch>show spanning-tree root
```

| Instance | Priority | Root ID<br>MAC addr | Root<br>Cost | Hello<br>Time | Max<br>Age | Fwd<br>Dly | Root Port |
|----------|----------|---------------------|--------------|---------------|------------|------------|-----------|
| MST0     | 8192     | 001c.7301.6017      | 0            | 2             | 20         | 15         | None      |
| MST1     | 16385    | 001c.7301.6017      | 0            | 0             | 0          | 0          | None      |
| MST2     | 32770    | 001c.7301.6017      | 0            | 0             | 0          | 0          | None      |

- Instance 0 root priority is 8192: primary priority plus the instance number of 0.
- Instance 1 root priority is 16385: secondary priority plus the instance number of 1.
- Instance 2 root priority is 32770: default priority plus the instance number of 2.

These priority settings normally program the switch to be the primary root bridge for instance 0, the secondary root bridge for instance 1, and a normal bridge for instance 2. Primary and secondary root bridge elections also depend on the configuration of other network bridges.

- These priority commands configure Rapid-PVST VLAN bridge priorities:

```
switch(config)#spanning-tree vlan-id 1 priority 8192
switch(config)#spanning-tree vlan-id 2 priority 16384
switch(config)#spanning-tree vlan-id 3 priority 8192
switch(config)#no spanning-tree vlan-id 4 priority
switch(config)#show spanning-tree root
```

| Instance | Priority       | Root ID<br>MAC addr | Root<br>Cost | Hello<br>Time | Max<br>Age | Fwd<br>Dly | Root Port |
|----------|----------------|---------------------|--------------|---------------|------------|------------|-----------|
| VL18193  | 001c.7301.6017 | 001c.7301.6017      | 0            | 2             | 20         | 15         | None      |
| VL216386 | 001c.7301.6017 | 001c.7301.6017      | 0            | 2             | 20         | 15         | None      |
| VL38195  | 001c.7301.6017 | 001c.7301.6017      | 0            | 2             | 20         | 15         | None      |
| VL432788 | 001c.7301.6017 | 001c.7301.6017      | 0            | 2             | 20         | 15         | None      |

- VLAN 1 root priority is 8193: configured priority plus the VLAN number of 1.
- VLAN 2 root priority is 16386: configured priority plus the VLAN number of 2.
- VLAN 3 root priority is 8195: configured priority plus the VLAN number of 3.
- These priority settings normally program the switch to be the primary root bridge for VLANs 1 and 3, the secondary root bridge for VLAN2, and a normal bridge for VLAN 4. Primary and secondary root bridge elections also depend on the configuration of other network bridges.VLAN 4 root priority is 32788: default priority plus the VLAN number of 4.

### 11.1.3.2.2 Path Cost

Spanning tree calculates the costs of all possible paths from each component to the root bridge. The path cost is equal to the sum of the cost assigned to each port in the path. Ports are assigned a cost by default or through CLI commands. Cost values range from 1 to 200000000 (200 million).

The default cost is a function of the interface speed:

- 1 gigabit interfaces have a default cost of 20000.
- 10 gigabit interfaces have a default cost of 2000.

The `spanning-tree cost` command configures the path cost of the configuration mode interface. Costs can be specified for Ethernet and port channel interfaces. The command provides a mode parameter for assigning multiple costs to a port for MST instances or Rapid-PVST VLANs.

#### Examples

- These commands configure a port cost of 25000 to **Ethernet interface 5**. This cost is valid for RSTP or MSTP instance 0.

```
switch(config)#interface ethernet 5
switch(config-if-Et5)#spanning-tree cost 25000
switch(config-if-Et5)#
```

- This command configures a path cost of 300000 to **Ethernet interface 5** in MST instance 200.

```
switch(config)#interface ethernet 5
switch(config-if-Et5)#spanning-tree mst 200 cost 300000
switch(config-if-Et5)#
```

- This command configures a path cost of 10000 to **Ethernet interface 5** in Rapid-PVST VLAN 200-220.

```
switch(config)#interface ethernet 5
switch(config-if-Et5)#spanning-tree vlan-id 200-220 cost 10000
switch(config-if-Et5)#
```

### 11.1.3.2.3 Port Priority

STP uses the port priority interface parameter to select ports when resolving loops. The port with the lower port priority numerical value is placed in forwarding mode. When multiple ports are assigned equal port priority numbers, the port with the lower interface number is placed in forwarding mode. Valid port-priority numbers are multiples of 16 between 0 and 240; the default is 128.

The `spanning-tree port-priority` command configures the port-priority number for the configuration mode interface. The command provides a mode option for assigning different priority numbers to a port for multiple MST instances or Rapid-PVST VLANs. Port-priority can be specified for Ethernet and port channel interfaces.

#### Examples

- This command sets the access port priority of 144 for Ethernet 5 interface.

```
switch(config)#interface ethernet 5
switch(config-if-Et5)#spanning-tree port-priority 144
switch(config-if-Et5)#
```

- This command sets the access port priority of 144 for Ethernet 5 interface in MST instance 10.

```
switch(config)#interface ethernet 5
switch(config-if-Et5)#spanning-tree mst 10 port-priority 144
switch(config-if-Et5)#
```

### 11.1.3.3 Port Roles and Rapid Convergence

Spanning Tree provides the following options for controlling port configuration and operation:

- **PortFast**: Allows ports to skip learning state before entering the forwarding state.
- **Port type** and **link type**: Designates ports for rapid transitions to the forwarding state.
- **Root guard**: Ensures that a port will not become the root port.
- **Loop guard**: Prevents loops resulting from unidirectional failure of links.
- **Bridge assurance**: Prevents loops caused by unidirectional links or a malfunctioning switch.

---

### 11.1.3.3.1 PortFast

PortFast allows devices to gain immediate network access before convergence of the spanning tree. Enabling PortFast on ports connected to another switch can create loops.

A **portfast** port that receives a BPDU sets its operating state to **non-portfast** while remaining in **portfast** configured state. In this state, the port is subject to topology changes and can enter the discarding state.

The [spanning-tree portfast](#) command programs access ports to immediately enter the forwarding state. PortFast connects devices attached to an access port, such as a single workstation, to the network immediately without waiting for STP convergence. PortFast can also be enabled on trunk ports.

#### Example

This command unconditionally enables portfast on Ethernet 5 interface.

```
switch(config)#interface ethernet 5
switch(config-if-Et5)#spanning-tree portfast
switch(config-if-Et5)#
```

### 11.1.3.3.2 Port Type and Link Type Configuration

RSTP only achieves rapid transition to forwarding state on edge ports and point-to-point links.

#### Port Type

Edge ports are directly connected to end stations. Because edge ports do not create loops, they transition directly to forwarding state when a link is established.

The [spanning-tree portfast <port type>](#) command sets the configuration mode interfaces port type. Spanning tree ports can be configured as edge ports, **network** ports, or **normal** ports. The default port type is **normal**.

- **Edge ports** connect to a host (end station). Configuring a port that connects to a bridge as an edge port may create a loop. Edge ports that receive a BPDU become a normal spanning tree port.
- **Network ports** connect only to a Layer 2 switch or bridge. Configuring a port connected to a host as a network port transitions the port to the discarding state.
- **Normal ports** have an unspecified topology.

#### Example

- This command configures Ethernet 5 interface as a network port.

```
switch(config)#interface ethernet 5
switch(config-if-Et5)#spanning-tree portfast network
switch(config-if-Et5)#
```

- Auto-edge detection converts ports into edge ports when they do not receive a new BPDU before the current BPDU expires, as measured by the max-age timer. The [spanning-tree portfast auto](#) command enables auto-edge detection on the configuration mode interface, superseding the [spanning-tree portfast](#) command. Auto-edge detection is enabled by default.

#### Example

This command enables auto-edge detection on Ethernet interface 5.

```
switch(config)#interface ethernet 5
switch(config-if-Et5)#spanning-tree portfast auto
switch(config-if-Et5)#
```



## Link Type

The switch derives a ports default link type from its duplex mode:

- full-duplex ports are **point-to-point**.
- half-duplex ports are **shared link**.

The `spanning-tree link-type` command specifies the configuration mode interfaces link-type. RSTP fast transition is not allowed on **shared link** ports, regardless of their duplex setting. Because the ports are full-duplex by default, the default link-type setting is **point-to-point**.

### Example

This command configures Ethernet 5 interface as a shared port.

```
switch(config)#interface ethernet 5
switch(config-if-Et5)#spanning-tree link-type shared
switch(config-if-Et5)#
```

### 11.1.3.3.3 Root Guard and Loop Guard

**Root guard** stops a port from becoming a root port, which stops connected switches from becoming root bridges. When a switch detects a new root bridge, its root-guard-enabled ports enter blocked (root-inconsistent) state. When the switch no longer detects a new root, these ports enter learning state.

Root guard is enabled on a per-port basis. The setting applies to all STP instances. Disabling root guard places the port in learning state.

The `spanning-tree guard` command, with the `root` option, enables root guard on the configuration mode interface.

### Example

This command enables root guard on Ethernet 5 interface.

```
switch(config)#interface ethernet 5
switch(config-if-Et5)#spanning-tree guard root
switch(config-if-Et5)#
```

**Loop guard** prevents loops resulting from unidirectional failure of point-to-point links by verifying that non-designated ports (root, blocked, and alternate) are receiving BPDUs from their designated ports. A loop-guard-enabled root or blocked port that stops receiving BPDUs transitions to the discarding (loop-inconsistent) state. The port recovers from this state when it receives a BPDU.

Loop guard, when enabled globally, applies to all point-to-point ports. Loop guard is configurable on individual ports and applies to all STP instances of an enabled port. Loop-inconsistent ports transition to learning state when loop guard is disabled.

If loop guard is enabled on a root switch, it takes effect only if the switch becomes a nonroot switch.

When using loop guard:

- Do not enable loop guard on portfast-enabled ports.
- Loop guard is not functional on ports not connected to point-to-point links.
- Loop guard has no effect on disabled spanning tree instances.

Loop guard aspects on port channels include:

- BPDUs are sent over the channels first operational port. Loop guard blocks the channel if that link becomes unidirectional even when other channel links function properly.
- Creating a new channel destroys state information for its component ports; new channels with loop-guard-enabled ports can enter forwarding state as a DP.

- Disassembling a channel destroys its state information; component ports from a blocked channel can enter the forwarding state as DPs, even if the channel contained unidirectional links.
- If a link on any port of the channel becomes unidirectional, the channel is blocked. Transmission resumes if the port is removed from the channel or the bidirectional communication is restored.

Loop guard configuration commands include:

- `spanning-tree guard loop default` command enables loop guard as a default on all switch ports.
- `spanning-tree guard` control the loop guard setting on the configuration mode interface. This command overrides the default command for the specified interface.

### Examples

- This command enables loop guard as the default on all switch ports.

```
switch(config)#spanning-tree guard loop default
switch(config)#
```

- This command enables loop guard on Ethernet 6 interface.

```
switch(config)#interface ethernet 6
switch(config-if-Et6)#spanning-tree guard loop
switch(config-if-Et6)#
```

#### 11.1.3.3.4 Bridge Assurance

Bridge assurance protects against unidirectional link failures, other software failures, and devices that continue forwarding data traffic after they quit running spanning tree.

Bridge assurance programs the switch to send BPDUs at each hello time period through all bridge assurance-enabled ports (i.e., network ports). Bridge assurance operates only on network ports with point-to-point links, ideally with bridge assurance enabled on each side of the link. Bridge assurance-enabled ports will not necessarily be blocked when they link to a port where bridge assurance is not enabled.

Ports not receiving a BPDU packet within a hello time period enter inconsistent (blocking) state. In this case, the `show spanning-tree transmit active` command will show a bridge assurance status of inconsistent for the port. If the other side of the link has bridge assurance enabled, or if the other switch is the root bridge, it will send periodic BPDUs, preventing an inconsistent blocking state.

Bridge assurance is globally enabled by default, but must also be enabled on a per-port basis by designating the port as a network port with the `spanning-tree portfast <port type>` command. The `no spanning-tree transmit active` command disables bridge assurance globally.

### Example

These commands enable bridge assurance on the switch, then enable bridge assurance on Ethernet port 5 by designating it a network port.

```
switch(config)#spanning-tree transmit active
switch(config)#interface ethernet 5
switch(config-if-Et5)#spanning-tree portfast network
switch(config-if-Et5)#
```

#### 11.1.3.4 Configuring BPDU Transmissions

The following sections describe instructions that configure BPDU packet contents and transmissions.

### 11.1.3.4.1 Configuring Bridge Timers

Bridge timers specify parameter values that the switch includes in BPDU packets that it sends as a root bridge. Bridge timers include:

- **hello-time**: transmission interval between consecutive BPDU packets.
- **forward-time**: the period that ports remain in learning state.
- **max-age**: the period that BPDU data remains valid after it is received.
- **max-hop**: the number of bridges in an MST region that a BPDU can traverse before it is discarded.

In standard STP, ports passively wait for **forward\_delay** and **max\_age** periods before entering the forwarding state. RSTP achieves faster convergence by relying on edge port and link type definitions to start forwarding traffic. When edge ports and link types are properly configured, bridge timers are used in RSTP as backup or when interacting with networks running standard STP.

The **spanning-tree hello-time** command configures the hello time.

#### Example

This command configures a hello-time of 1 second (1000 ms).

```
switch(config) #spanning-tree hello-time 1000
switch(config) #
```

The **spanning-tree max-hops** command specifies the max hop setting that the switch inserts into BPDUs that it sends out as the root bridge.

#### Example

This command sets the max hop value to **40**.

```
switch(config) #spanning-tree max-hops 40
switch(config) #
```

The **spanning-tree forward-time** command configures the forward delay setting that the switch inserts into BPDUs that it sends out as the root bridge.

#### Example

This command sets the forward delay timer value to **25** seconds.

```
switch(config) #spanning-tree forward-time 25
switch(config) #
```

The **spanning-tree max-age** command configures the max age setting that the switch inserts into BPDUs that it sends out as the root bridge.

#### Example

This command sets the max age timer value to **25** seconds.

```
switch(config) #spanning-tree max-age 25
switch(config) #
```

### 11.1.3.4.2 BPDU Transmit Hold-Count

The **spanning-tree bpdu tx hold-count** command specifies the maximum number of BPDUs per second that the switch can send from an interface. Valid settings range from 1 to 10 BPDUs with a default of 6 BPDUs.

Higher hold-count settings can significantly impact CPU utilization, especially in Rapid-PVST mode. Smaller values can slow convergence in some configurations.

---

## Example

This command configures a transmit hold-count of 8 BPDUs.

```
switch(config) #spanning-tree bpdu tx hold-count 8
switch(config) #
```

### 11.1.3.4.3 BPDU Guard

PortFast interfaces do not receive BPDUs in a valid configuration. BPDU Guard provides a secure response to invalid configurations by disabling ports when they receive a BPDU. Disabled ports differ from blocked ports in that they are re-enabled only through manual intervention.

- When configured globally, BPDU Guard is enabled on ports in the operational portfast state.
- When configured on an individual interface, BPDU Guard disables the port when it receives a BPDU, regardless of the ports portfast state.

The `spanning-tree edge-port bpduguard default` global configuration command enables BPDU guard by default on all portfast ports. BPDU guard is disabled on all ports by default.

The `spanning-tree bpduguard` interface configuration command controls BPDU guard on the configuration mode interface. This command takes precedence over the default setting configured by `spanning-tree edge-port bpduguard default`.

- `spanning-tree bpduguard` enables BPDU guard on the configuration mode interface.
- `spanning-tree bpduguard disable` disables BPDU guard on the configuration mode interface.
- `no spanning-tree bpduguard` reverts the configuration mode interface to the default BPDU guard setting.

## Example

These commands enable BPDU guard by default on all portfast ports, then disable BPDU guard on Ethernet 5.

```
switch(config) #spanning-tree edge-port bpduguard default
switch(config) #interface ethernet 5
switch(config-if-Et5) #spanning-tree bpduguard disable
switch(config-if-Et5)
```

### 11.1.3.4.4 BPDU Filter

BPDU filtering prevents the switch from sending or receiving BPDUs on specified ports. BPDU filtering is configurable on Ethernet and port channel interfaces.

Ports with BPDU filtering enabled do not send BPDUs and drops inbound BPDUs. Enabling BPDU filtering on a port not connected to a host can result in loops as the port continues forwarding data while ignoring inbound BPDU packets.

The `spanning-tree bpdufilter` command controls BPDU filtering on the configuration mode interface. BPDU filtering is disabled by default.

## Example

- These commands enable BPDU filtering on Ethernet 5.

```
switch(config) #interface ethernet 5
switch(config-if-Et5) #spanning-tree bpdufilter enable
switch(config-if-Et5) #
```

### 11.1.3.4.5 BPDU Rate Limit

BPDU input rate limiting restricts the number of BPDUs that a port with BPDU guard and BPDU filter disabled, can process during a specified interval. The port discards all BPDUs that it receives in excess of the specified limit. Configuring the rate limiter requires two steps:

- Establishing the rate limit threshold
- Enabling rate limiting

#### Establishing the Rate Limit Threshold

The `spanning-tree bpduguard rate-limit count (interface)` command specifies the BPDU reception rate (quantity per interval) that triggers the discarding of BPDUs. The command is available in global and interface configuration modes.

- The `spanning-tree bpduguard rate-limit count` global command specifies the maximum reception rate for ports that are not covered by interface rate limit count commands. The global command specifies the default limit.



**Note:** Arista Networks recommends to retain the default values of rate limit. In the PVST mode, when the VLAN membership of a port is changed by a significant margin, it is advisable to disable interface BPDU rate limit on both ends of a port. For example, if three VLANs are present on a port initially, the operator must first add 300 more VLANs on one side of the port and then add the same 300 VLANs on the other side of the port. In this case, if the VLANs are increased towards the root bridge first, then the other side can cross the rate-limit threshold.

- The `spanning-tree bpduguard rate-limit count` interface command defines the maximum BPDU reception rate for ports in the configuration mode interface.

#### Examples

- This command configures the global limit of 5000 BPDUs over a four second interval.

```
switch(config)#spanning-tree bpduguard rate-limit count 5000 interval 4
switch(config)#
```

- These commands configure a limit of 7500 BPDUs over an 8 second interval on the Ethernet interface 2.

```
switch(config)#interface ethernet 2
switch(config-if-Et2)#spanning-tree bpduguard rate-limit count 7500
interval 8
switch(config-if-Et2)#
```

#### Enabling Rate Limiting

BPDU rate limiting is enabled globally or on individual ports:

- `spanning-tree bpduguard rate-limit default` enables ratelimiting on all ports that are not covered by the interface rate limiting command. The default setting is **enabled**.
- `spanning-tree bpduguard rate-limit enable / disable` interface command enables or disables BPDU rate limiting on the configuration mode interface. This command has precedence over the global command.

#### Example

- This command enables rate limiting on ports that are not covered by interface rate limit commands.

```
switch(config)#spanning-tree bpduguard rate-limit default
switch(config)#
```

- 
- These commands enable rate limiting on the *Ethernet interface 15*.

```
switch(config)#interface ethernet 15
switch(config-if-Et15)#spanning-tree bpduguard rate-limit enable
switch(config-if-Et15)#
```

## 11.1.4 STP Commands

### Spanning Tree Commands: Global Configuration

- `spanning-tree bpdu tx hold-count`
- `spanning-tree bpduguard rate-limit default`
- `spanning-tree bpduguard rate-limit count (global)`
- `spanning-tree edge-port bpdudfilter default`
- `spanning-tree edge-port bpduguard default`
- `spanning-tree forward-time`
- `spanning-tree guard loop default`
- `spanning-tree hello-time`
- `spanning-tree max-age`
- `spanning-tree max-hops`
- `spanning-tree mode`
- `spanning-tree mst configuration`
- `spanning-tree mst pvst border`
- `spanning-tree portchannel guard misconfig`
- `spanning-tree priority`
- `spanning-tree root`
- `spanning-tree transmit active`
- `spanning-tree vlan-id`

### Loop Protection Commands

- `disabled-time`
- `loop-protection`
- `monitor loop-protection`
- `protect vlan`
- `rate-limit`
- `shutdown (Loop-protection)`
- `transmit-interval`

### Spanning Tree Commands: Interface Configuration Mode

- `spanning-tree bpdudfilter`
- `spanning-tree bpduguard`
- `spanning-tree bpduguard rate-limit count (interface)`
- `spanning-tree bpduguard rate-limit enable / disable`
- `spanning-tree cost`
- `spanning-tree guard`
- `spanning-tree link-type`
- `spanning-tree port-priority`
- `spanning-tree portfast`
- `spanning-tree portfast auto`
- `spanning-tree portfast <port type>`
- `switchport backup-link`

### MST Configuration Commands

- `abort (mst-configuration mode)`

- 
- exit (mst-configuration mode)
  - instance
  - name (mst-configuration mode)
  - revision (mst-configuration mode)
  - show (mst-configuration mode)

### **Display Commands**

- show spanning-tree
- show spanning-tree blockedports
- show spanning-tree counters
- show spanning-tree instance
- show spanning-tree instance detail
- show spanning-tree interface
- show spanning-tree mst
- show spanning-tree mst configuration
- show spanning-tree mst interface
- show spanning-tree mst test information
- show spanning-tree root
- show spanning-tree topology status
- show spanning-tree transmit active

### **Clear Commands**

- clear spanning-tree counters
- clear spanning-tree counters session
- clear spanning-tree detected-protocols



### 11.1.4.1 abort (mst-configuration mode)

The **abort** command, in MST-configuration mode, discards pending changes to the MST region configuration, then returns the switch to global configuration mode.

The `exit (mst-configuration mode)` command saves MST region changes to **running-config** before returning the switch to global configuration mode.

#### Command Mode

MST-configuration

#### Command Syntax

```
abort
```

#### Example

This command discards changes to the MST region, then returns the switch to global configuration mode.

```
switch(config-mst)#abort
switch(config)#
```

### 11.1.4.2 clear spanning-tree counters session

The **clear spanning-tree counter session** command resets the BPDU counters to zero on all interfaces in the current CLI session. Counters in other CLI sessions are not affected.

#### Command Mode

Privileged EXEC

#### Command Syntax

```
clear spanning-tree counters session
```

#### Example

This command resets the BPDU counters in the current CLI session.

```
switch#show spanning-tree counters
 Port Sent Received Tagged Error Other

0 Ethernet15 32721 0 0
0 Port-Channel10 8487 0 0

switch#clear spanning-tree counters session
switch#show spanning-tree counters
 Port Sent Received Tagged Error Other

0 Ethernet15 11 0 0
0 Port-Channel10 7 2 6

switch#
```

### 11.1.4.3 clear spanning-tree counters

The **clear spanning-tree counters** command resets the BPDU counters for the specified interfaces to zero in all CLI sessions.

#### Command Mode

Privileged EXEC

#### Command Syntax

```
clear spanning-tree counters [INT_NAME]
```

#### Parameters

- **INT\_NAME** Interface type and number. Options include:
  - **no parameter** resets counters for all interfaces.
  - **interface ethernet e\_num** Ethernet interface specified by **e\_num**.
  - **interface loopback l\_num** Loopback interface specified by **l\_num**.
  - **interface management m\_num** Management interface specified by **m\_num**.
  - **interface port-channel p\_num** Port-Channel Interface specified by **p\_num**.
  - **interface vlan v\_num** VLAN interface specified by **v\_num**.

#### Example

This command resets the BPDU counters on **Ethernet 15 interface**.

```
switch#show spanning-tree counters
 Port Sent Received Tagged Error Other

0 Ethernet15 32721 0 0
0 Port-Channel10 8487 0 0

switch#clear spanning-tree counters interface ethernet 15<---Clear
command
switch#show spanning-tree counters
 Port Sent Received Tagged Error Other

0 Ethernet15 11 0 0
0 Port-Channel10 84942 6 0

switch#
```

---

#### 11.1.4.4 clear spanning-tree detected-protocols

The **clear spanning-tree detected-protocols** command restarts the spanning tree protocol (STP) migration state machine on the specified interfaces. The switch is reset to running rapid spanning tree protocol on an interface where it previously detected a bridge running an old version of the protocol.

##### Command Mode

Privileged EXEC

##### Command Syntax

```
clear spanning-tree detected-protocols [INT_NAME]
```

##### Parameters

- **INT\_NAME** Interface type and number. Values include:
  - **no parameter** all interfaces.
  - **ethernet e\_num** Ethernet interface specified by **e\_num**.
  - **loopback l\_num** Loopback interface specified by **l\_num**.
  - **management m\_num** Management interface specified by **m\_num**.
  - **port-channel p\_num** Port-Channel Interface specified by **p\_num**.
  - **vlan v\_num** VLAN interface specified by **v\_num**.

##### Example

This command restarts the STP migration machine on all switch interfaces.

```
switch#clear spanning-tree detected-protocols
switch#
```

### 11.1.4.5 disabled-time

The **disabled-time** command sets the time for which the port remains disabled after a loop is detected by loop protection. The **no disabled-time** and **default disabled-time** commands reset the disabled time to the default of 604800 seconds (seven days).

 **Note:** If this value is changed, interfaces that are already disabled by loop protection will remain disabled for the previously configured period.

#### Command Mode

Loop-protection Configuration

#### Command Syntax

```
disabled-time [period]
no disabled-time [period]
default disabled-time [period]
```

#### Parameters

***period*** Time in seconds for which the port remains disabled. Values range from 0 to 604800 (seven days). Default is 604800. A value of 0 disables the interface until it is manually reset, even if the disabled time is later set to a non-zero value. To restore the port manually, shut it down and then re-enable it.

#### Example

This command configures loop protection to disable a port on which a loop is detected for a period of two days (**172800** seconds).

```
switch(config-monitor-loop-protect) #disabled-time 172800
switch(config-monitor-loop-protect) #
```

---

#### 11.1.4.6 exit (mst-configuration mode)

The **exit** command, in MST-configuration mode, saves changes to the MST region configuration, then returns the switch to global configuration mode. MST region configuration changes are also saved by entering a different configuration mode.

##### Command Mode

MST-configuration

##### Command Syntax

```
exit
```

##### Examples

- This command saves changes to the MST region, then returns the switch to global configuration mode.

```
switch(config-mst) #exit
switch(config) #
```

- This command saves changes to the MST region, then places the switch in Interface-Ethernet mode.

```
switch(config-mst) #interface ethernet 3
switch(config-if-Et3) #
```

### 11.1.4.7 instance

The **instance** command inserts an entry into the VLAN-to-instance map that associates a set of VLANs to an MST instance. In addition to defining the MST topology, the VLAN-to-instance map is one of three parameters, along with the MST name and revision number, that identifies the switches MST region.

The **no instance** command removes specified entries from the VLAN-to-instance map. If the command does not provide a VLAN list, all entries are removed for the specified instance. The **no instance** and **default instance** commands function identically.

#### Command Mode

MST-Configuration

#### Command Syntax

```
instance mst_inst vlans v_range
no instance mst_inst [vlans v_range]
no default instance mst_inst [vlans v_range]
```

#### Parameters

- ***mst\_inst*** MST instance number. Value of *mst\_inst* ranges from 0 to 4094.
- ***v\_range*** VLAN list. Formats include a number, number range, or comma-delimited list of numbers and ranges.

#### Examples

- This command maps VLANs 20-39 to MST instance 2

```
switch(config)#spanning-tree mst configuration
switch(config-mst)#instance 2 vlans 20-39
switch(config-mst)#
```

- This command removes all VLAN mappings to MST instance 10.

```
switch(config-mst)#no instance 10
switch(config-mst)#
```

---

### 11.1.4.8 loop-protection

The **loop-protection** command enables loop protection on the configuration mode interface. All interfaces in a VLAN under loop protection have loop protection enabled by default. The **no loop-protection** and **default loop-protection** commands disable loop protection on the interface.

When loop protection is disabled (at the VLAN or interface level), the computed state of the interface is forgotten and packets queued to be sent are dropped. If an interface is err-disabled by loop protection, disabling loop protection removes the err-disable.

#### Command Mode

Interface-Ethernet Configuration

#### Command Syntax

```
loop-protection
```

```
no loop-protection
```

```
default loop-protection
```

#### Example

These commands disable loop protection on **Ethernet interface 2/4**. If the interface is currently err-disabled by loop protection, the err-disable will be removed.

```
switch(config)#interface ethernet 2/4
switch(config-if-Et2/4)#no loop-protection
switch(config-if-Et2/4)#
```



### 11.1.4.9 monitor loop-protection

The `monitor loop-protection` command places the switch in loop-protection configuration mode.

#### Command Mode

Global Configuration

#### Command Syntax

```
monitor loop-protection
```

#### Commands available in loop-protection configuration mode:

- [shutdown \(Loop-protection\)](#)
- [protect vlan](#)
- [transmit-interval](#)
- [disabled-time](#)
- [rate-limit](#)

#### Example

This command places the switch in loop-protection configuration mode.

```
switch(config) #monitor loop-protection
switch(config-monitor-loop-protect) #
```

---

#### 11.1.4.10 name (mst-configuration mode)

The **name** command configures the MST region name. The name is one of three parameters, along with the MST revision number and VLAN-to-instance map, that identifies the switch's MST region.

The name has up to 32 characters. The default name is an empty string. The name string accepts all characters except the space.

The **no name** and **default name** commands restore the default name by removing the **name** command from *running-config*.

##### Command Mode

MST-Configuration

##### Command Syntax

```
name label_text
```

```
no name
```

```
default name
```

##### Parameters

**label\_text** character string assigned to name attribute. Maximum 32 characters. The space character is not permitted in the name string.

##### Example

This command assigns corporate\_100 as the MST region name.

```
switch(config)#spanning-tree mst configuration
switch(config-mst)#name corporate_100
switch(config-mst)#show pending
Active MST configuration
Name [corporate_100]
Revision 0 Instances configured 1

Instance Vlans mapped

0 1-4094

```

### 11.1.4.11 protect vlan

The **protect vlan** command specifies which VLANs will participate in loop protection. The **no protect vlan** and **default protect vlan** commands remove loop protection from the specified VLANs.

#### Command Mode

Loop-protection Configuration

#### Command Syntax

```
protect vlan vlan-range
```

#### Parameters

**vlan-range** List of VLANs (number, range, comma-delimited list of numbers and ranges). Numbers range from 1 to 4094.

#### Example

This command enables loop protection on VLANs 1025-2000.

```
switch(config-monitor-loop-protect) #protect vlan 1025-2000
switch(config-monitor-loop-protect) #
```

---

#### 11.1.4.12 rate-limit

The **rate-limit** command sets the maximum number of loop detection frames which can be sent by the switch per second. The **no rate-limit** and **default rate-limit** commands return the rate limit to the default value of 1000.

##### Command Mode

Loop-protection Configuration

##### Command Syntax

```
rate-limit [frames]
```

```
no rate-limit [frames]
```

```
default rate-limit [frames]
```

##### Parameters

**frames** Maximum number of frames sent per second. Values range from 0-1000, default is 1000. A value of zero disables throttling.

##### Example

This command sets the maximum number of loop detection frames to **500** per second.

```
switch(config-monitor-loop-protect) #rate-limit 500
switch(config-monitor-loop-protect) #
```

### 11.1.4.13 revision (mst-configuration mode)

The **revision** command configures the MST revision number. The revision number is one of three parameters, along with the MST name and VLAN-to-instance map, that identifies the switch's MST region. Revision numbers range from 0 to 65535. The default revision number is 0.

The **no revision** and **default revision** commands restore the revision number to its default value by removing the revision command from **running-config**.

#### Command Mode

MST-Configuration

#### Command Syntax

```
revision rev_number
```

```
no revision
```

```
default revision
```

#### Parameters

**rev\_number** revision number. Possible ranges from 0 to 65535 with a default of 0.

#### Example

This command sets the revision number to 15.

```
switch(config)#spanning-tree mst configuration
switch(config-mst)#revision 15
switch(config-mst)#show pending
Active MST configuration
Name []
Revision 15Instances configured 1

Instance Vlans mapped
----- -
0 1-4094

```

#### 11.1.4.14 show (mst-configuration mode)

The **show** command displays the current and pending MST configuration:

Exiting MST configuration mode stores all pending configuration changes to *running-config*.

##### Command Mode

MST-Configuration

##### Command Syntax

**show** [EDIT\_VERSION]

##### Parameters

- **EDIT\_VERSION** specifies configuration version that the command displays. Options include:
  - **no parameter** command displays pending MST configuration.
  - **active** command displays MST configuration stored in *running-config*.
  - **current** command displays MST configuration stored in *running-config*.
  - **pending** command displays pending MST configuration.

##### Example

These commands contrast the difference between the active and pending configuration by adding MST configuration commands, then showing the configurations.

```
switch(config-mst)#show pending
Active MST configuration
Name []
Revision 0 Instances configured 1

Instance Vlans mapped

0 1-4094

switch(config-mst)#instance 2 vlan 20-29,102
switch(config-mst)#revision 2
switch(config-mst)#name baseline
switch(config-mst)#show pending
Pending MST configuration
Name [baseline]
Revision 2 Instances configured 2

Instance Vlans mapped

0 1-19,30-101,103-4094
2 20-29,102

switch(config-mst)#show active
Active MST configuration
Name []
Revision 0 Instances configured 1

Instance Vlans mapped

0 1-4094

```

### 11.1.4.15 show loop-protection

The **show loop-protection** command displays loop protection status.

#### Command Syntax

```
show loop-protection [detail]
```

#### Examples

- This command displays basic loop protection information.

```
switch#show loop-protection
Loop protection is enabled
Transmit interval: 5
Disable Time: 604800(or Permanent)
Packets Transmitted rate: 12/second(or Unthrottled)
Total: 3 Vlans enabled.
switch>
```

- This command displays detailed information about loop protection.

```
switch#show loop-protection detail
Loop protection is enabled

Transmit interval: 5
Disable Time: 604800
Packets Transmitted rate: 12/second
Total: 3 Vlans enabled.
Destination address: ffff.ffff.ffff
Ethernet type: 0x88b7
Receive action: Interface Disable

Vlan Loop Disabled Intfs Total Latest
Detected ----- ----- ----- -----
1 Yes Et1-2 20 18:01
2 No - 20 -
3 No - 20 -
switch#
```

- This command displays loop protection information for the interfaces in VLANS 3-4.

```
switch#show loop-protection vlan 3-4
Vlan Intf LP Enabled State LP Disabled Bring
----- ----- ----- ----- ----- -----
3 Et1 Yes shutdown Yes 17:21 18:21
3 Et2 Yes shutdown No - -
3 Et3 Yes enabled No - -
3 Et4 No - - - -
4 - No - - - -
switch#
```

- This command displays the number of loop detection packets sent and received.

```
switch#show loop-protection counters
VLAN Tx Rx Rx-Other
----- ----- ----- -----
2 200 0 100
3 200 1 0

Intfs Tx Rx Rx-Other
----- ----- ----- -----
```

---

```
Et1 200 0 100
Et2 200 1 0
switch#
```



### 11.1.4.16 show spanning-tree blockedports

The **show spanning-tree blockedports** command displays the list of blocked (discarding) ports.

#### Command Mode

EXEC

#### Command Syntax

```
show spanning-tree blockedports
```

#### Example

This command shows the ports that are in discarding state.

```
switch#show spanning-tree blockedports
Name Blocked Interfaces List

MST0 Po903, Po905, Po907, Po909, Po911, Po913, Po915, Po917, Po919, Po921, Po923
 Po925, Po927, Po929, Po931, Po933, Po935, Po939, Po941, Po943, Po945, Po947

Number of blocked ports (segments) in the system : 22
switch#
```

### 11.1.4.17 show spanning-tree counters

The **show spanning-tree counters** command displays the number of BPDU transactions on each interface running spanning tree.

#### Command Mode

EXEC

#### Command Syntax

```
show spanning-tree counters
```

#### Example

This command displays the BPDU counter status on each interface running spanning tree.

```
switch#show spanning-tree counters
 Port Sent Received Tagged Error Other Error
sinceTimer

0 Ethernet2 1008399 0 0 0
0 Ethernet3 1008554 0 0 0
0 Ethernet4 454542 0 0 0
0 Ethernet5 1008556 0 0 0
0 Ethernet6 827133 0 0 0
0 Ethernet8 1008566 0 0 0
0 Ethernet10 390732 0 0 0
0 Ethernet11 1008559 0 0 0
0 Ethernet15 391379 0 0 0
0 Ethernet17 621253 0 0 0
0 Ethernet19 330855 0 0 0
0 Ethernet23 245243 0 0 0
0 Ethernet25 591695 0 0 0
0 Ethernet26 1007903 0 0 0
0 Ethernet32 1010429 8 0 0
0 Ethernet33 510227 0 0 0
0 Ethernet34 827136 0 0 0
0 Ethernet38 1008397 0 0 0
0 Ethernet39 1008564 0 0 0
0 Ethernet40 1008185 0 0 0
0 Ethernet41 1007467 0 0 0
0
```

```
 Ethernet42 82925 0 0 0
0
Port-Channel1 1008551 0 0 0
0
Port-Channel2 334854 678589 0 0
3
Port-Channel3 1010420 4 0 0
0

switch#
```

### 11.1.4.18 show spanning-tree instance

The **show spanning-tree instance** command displays spanning tree protocol bridge configuration settings for each instance on the switch. The display includes Bridge ID, Hello Time, Max Age, and Forward Delay times.

The command also displays the restartability of the STP agent when the **detail** option is selected. A switch can continue support of MLAG operation when its peer is offline and the STP agent is unavailable.

#### Command Mode

EXEC

#### Command Syntax

```
show spanning-tree instance [INFO_LEVEL]
```

#### Parameters

- INFO\_LEVEL specifies level of information detail provided by the command.
  - **no parameter** command displays information in a data table.
  - **detail** command displays bridge information in data blocks for each instance.

#### Examples

- This command displays a bridge data table.

```
switch#show spanning-tree instance
 Bridge ID Hello Max
 Fwd Time Age
Instance Priority MAC addr Time Age
Dly

MST0 32768(32768, sys-id 0) 001c.7302.2f98 2000 20
 15
MST101 32869(32768, sys-id 101) 001c.7302.2f98 2000 20
 15
MST102 32870(32768, sys-id 102) 001c.7302.2f98 2000 20
 15
switch#
```

- This command displays bridge data blocks.

```
switch#show spanning-tree instance detail
Stp Detailed Status:
 Stp agent restartable : True
 MST-PVST interoperation : Disabled
 Stp heartbeat timeout : 2.0
 Last local heartbeat timeout : 0:04:07 ago
 Local heartbeat timeout since reboot : 1

MST0
 Bridge ID Priority 32768 (priority 32768 sys-id-ext 0)
 Address 001c.7302.2f98
 Hello Time 2.000 sec Max Age 20 sec Forward Delay 15
sec
MST101
 Bridge ID Priority 32869 (priority 32768 sys-id-ext 101)
 Address 001c.7302.2f98
 Hello Time 2.000 sec Max Age 20 sec Forward Delay 15
sec
```

```
MST102
 Bridge ID Priority 32870 (priority 32768 sys-id-ext 102)
 Address 001c.7302.2f98
 Hello Time 2.000 sec Max Age 20 sec Forward Delay 15
sec
switch#
```

---

#### 11.1.4.19 show spanning-tree instance detail

The **show spanning-tree instance detail** command displays detailed MST information including MSTP-Rapid PVST+ interoperation status.

##### Command Mode

EXEC

##### Command Syntax

```
show spanning-tree instance detail
```

##### Example

This command displays detailed MST information.

```
switch#show spanning-tree instance detail
Stp Detailed Status:
 Stp agent restartable : True
 MST-PVST interoperation : Enabled
 Stp heartbeat timeout : 2.0
 Last local heartbeat timeout : 36 days, 19:10:46 ago
 Local heartbeat timeout since reboot : 1
MST0
 Bridge ID Priority 32768 (priority 32768 sys-id-ext 0)
 Address 001c.7374.8572
 Hello Time 2.000 sec Max Age 20 sec Forward Delay 15 sec
switch#
```

### 11.1.4.20 show spanning-tree interface

The **show spanning-tree interface** command displays spanning tree protocol information for the specified interface.

#### Command Mode

EXEC

#### Command Syntax

```
show spanning-tree interface INT_NAME [INFO_LEVEL]
```

#### Parameters

- **INT\_NAME** Interface type and number. Values include:
  - **ethernet e\_num** Ethernet interface specified by **e\_num**.
  - **peer ethernet e\_num** Ethernet interface specified by **e\_num**.
  - **port-channel p\_num** Port-Channel Interface specified by **p\_num**.
  - **peerport-channel p\_num** Port-Channel Interface specified by **p\_num**.
- **INFO\_LEVEL** specifies level of detail provided by the output. Options include:
  - **no parameter** command displays a table of STP data for the specified interface.
  - **detail** command displays a data block for the specified interface.

#### Examples

- This command displays an STP table for Ethernet interface 5.

```
switch#show spanning-tree interface ethernet 5
Instance Role State Cost Prio.Nbr Type

MST0 designated forwarding 20000 128.5 P2p
switch#
```

- This command displays a data block for Ethernet interface 5.

```
switch#show spanning-tree interface ethernet 5 detail
Port 5 (Ethernet5) of MST0 is designated forwarding
 Port path cost 20000, Port priority 128, Port Identifier 128.5.
 Designated root has priority 32768, address 001c.7301.07b9
 Designated bridge has priority 32768, address 001c.7304.195b
 Designated port id is 128.5, designated path cost 1999 (Ext) 0 (Int)
 Timers: message age 1, forward delay 15, hold 20
 Number of transitions to forwarding state: 1
 Link type is point-to-point by default, Internal
 BPDU: sent 1008766, received 0, taggedErr 0, otherErr 0,
 rateLimiterCount 0
 Rate-Limiter: enabled, Window: 10 sec, Max-BPDU: 400

switch#
```

#### 11.1.4.21 show spanning-tree mst configuration

The **show spanning-tree mst configuration** command displays information about the MST regions VLAN-to-instance mapping. The command provides two display options:

- **default** displays a table that lists the instance to VLAN map.
- **digest** displays the configuration digest.

The configuration digest is a 16-byte hex string calculated from the md5 encoding of the VLAN-to-instance mapping table. Switches with identical mappings have identical digests.

##### Command Mode

EXEC

##### Command Syntax

```
show spanning-tree mst configuration [INFO_LEVEL]
```

##### Parameters

- **INFO\_LEVEL** specifies data provided by the output. Options include:
  - **no parameter** command displays VLAN-to-instance map.
  - **digest** command displays the MST configuration digest.

##### Examples

- This command displays the MST regions VLAN-to-instance map.

```
switch#show spanning-tree mst configuration
Name []
Revision 0 Instances configured 3

Instance Vlans mapped

01,4-4094
22
33

switch#
```

- This command displays the MST regions configuration digest.

```
switch#show spanning-tree mst configuration digest
Name []
Revision 0 Instances configured 1
Digest 0xAC36177F50283CD4B83821D8AB26DE62
switch#
```



### 11.1.4.22 show spanning-tree mst interface

The **show spanning-tree mst interface** command displays Multiple Spanning Tree Protocol (MSTP) information for a specified interface on the specified MST instances.

#### Command Mode

EXEC

#### Command Syntax

```
show spanning-tree mst [INSTANCE] interface INT_NAME [INFO_LEVEL]
```

#### Parameters

- **INSTANCE** MST instance for which the command displays information. Options include:
  - *no parameter* all MST instances.
  - **mst\_inst** denotes a single MST instance. Value of *mst\_inst* ranges from 0 to 4094.
- **INT\_NAME** Interface type and number. Values include:
  - **ethernet e\_num** Ethernet interface specified by *e\_num*.
  - **peerethernet e\_num** Ethernet interface specified by *e\_num*.
  - **port-channel p\_num** Port-channel interface specified by *p\_num*.
  - **peerport-channel p\_num** Port-channel interface specified by *p\_num*.
- **INFO\_LEVEL** specifies level of detail provided by the output. Options include:
  - *no parameter* command displays a table of STP instance data for the specified interface
  - **detail** command displays a data block for all specified instance-interface combinations.

#### Examples

- This command displays an table of STP instance data for Ethernet 1 interface:

```
switch#show spanning-tree mst interface ethernet 1
Ethernet1 of MST0 is root forwarding
Edge port: nobpdu guard: disabled
Link type: point-to-point
Boundary : Internal
Bpdus sent 2120, received 2164, taggedErr 0, otherErr 0

Instance Role Sts CostPrio.Nbr Vlans mapped

0RootFWD2000128.11,4-4094
2DesgFWD2000128.12
3RootFWD2000128.13
```

- This command displays blocks of STP instance information for Ethernet 1 interface.

```
switch#show spanning-tree mst 3 interface ethernet 1 detail
Edge port: nobpdu guard: disabled
Link type: point-to-point
Boundary : Internal
Bpdus sent 2321, received 2365, taggedErr 0, otherErr 0

Ethernet1 of MST3 is root forwarding
Vlans mapped to MST3 3
Port infoport id128.1priority128 cost2000
Designated rootaddress 0011.2233.4401priority32768 cost0
Designated bridgeaddress 0011.2233.4401priority32768 port id128.1
```

---

### 11.1.4.23 show spanning-tree mst test information

The **show spanning-tree mst test information** displays diagnostic spanning tree protocol information.

#### Command Mode

EXEC

#### Command Syntax

```
show spanning-tree mst test information
```

#### Example

This command displays diagnostic STP information.

```
switch#show spanning-tree mst test information
bi = MstInfo.BridgeInfo("dut")
bi.stpVersion = "rstp"
bi.mstpRegionId = ""
bi.bridgeAddr = "00:1c:73:01:60:17"
si = MstInfo.BridgeStpiInfo("Mst")
bi.stpiInfoIs("Mst", si)
si.cistRoot = Tac.Value("Stp::BridgeId", priority=32768, systemId=0,
address='00:1c:73:01:60:17')
si.cistPathCost = 0
bmi = MstInfo.BridgeMstiInfo("Mst0")
bmi.bridgeId = Tac.Value("Stp::BridgeId", priority=32768, systemId=0,
address='00:1c:73:01:60:17')
bmi.designatedRoot = Tac.Value("Stp::BridgeId", priority=32768,
systemId=0,
address='00:1c:73:01:60:17')
si.mstiInfoIs("Mst0", bmi)
bmii = MstInfo.BridgeMstiIntfInfo("Mst0", "Ethernet15")
bmii.portId = Tac.Value("Stp::PortId",
portPriority=128, portNumber=15)
bmii.role = "designated"
bmii.operIntPathCost = 2000
bmii.fdbFlush = 1
bmi.mstiIntfInfoIs("Ethernet15", bmii)
bii = MstInfo.BridgeIntfInfo("Ethernet15")
bii.operExtPathCost = 2000
si.intfInfoIs("Ethernet15", bii)
bmii = MstInfo.BridgeMstiIntfInfo("Mst0", "Port-Channel10")
bmii.portId = Tac.Value("Stp::PortId",
portPriority=128, portNumber=101)
bmii.role = "designated"
bmii.operIntPathCost = 1999
bmii.fdbFlush = 1
bmi.mstiIntfInfoIs("Port-Channel10", bmii)
bii = MstInfo.BridgeIntfInfo("Port-Channel10")
bii.operExtPathCost = 1999
si.intfInfoIs("Port-Channel10", bii)
switch>
```

### 11.1.4.24 show spanning-tree mst

The **show spanning-tree mst** command displays configuration and state information for Multiple Spanning Tree Protocol (MST) instances.

#### Command Mode

EXEC

#### Command Syntax

```
show spanning-tree mst [INSTANCE] [INFO_LEVEL]
```

#### Parameters

- **INSTANCE** MST instance for which the command displays information. Options include:
  - *no parameter* all MST instances.
  - **mst\_inst** MST instance number. Value of *mst\_inst* ranges from 0 to 4094.
- **INFO\_LEVEL** type and amount of information in the output. Options include:
  - *no parameter* output is interface data in tabular format.
  - **detail** output is a data block for each interface.

#### Examples

- This command displays interface data blocks for MST instance 3.

```
switch#show spanning-tree mst 3 detail
MST3vlans mapped:3
Bridgeaddress 0011.2233.4402priority32771(32768 sysid 3)
Rootaddress 0011.2233.4401priority32771(32768 sysid 3)

Ethernet1 of MST3 is root forwarding
Port infoport id128.1priority128cost2000
Designated rootaddress 0011.2233.4401priority32768cost0
Designated bridgeaddress 0011.2233.4401priority32768portid128.1
Ethernet2 of MST3 is alternate discarding
Port infoport id128.2 priority128cost2000
Designated rootaddress 0011.2233.4401 priority32768cost0
Designated bridgeaddress 0011.2233.4401 priority32768port id128.2

Ethernet3 of MST3 is designated forwarding
Port infoport id128.3 priority128cost2000
Designated rootaddress 0011.2233.4401 priority32768cost2000
Designated bridgeaddress 0011.2233.4402 priority32768port id128.3
```

- This command displays interface tables for all MST instances.

```
switch#show spanning-tree mst
MST0vlans mapped:1,4-4094
Bridgeaddress 0011.2233.4402priority32768 (32768 sysid 0)
Rootaddress 0011.2233.4401priority32768 (32768 sysid 0)
Regional Root address 0011.2233.4401priority32768 (32768 sysid 0)

Interface Role State Cost Prio.Nbr Type

Et1 root forwarding 2000 128.1 P2p
Et2 alternate discarding 2000 128.2 P2p
Et3 designated forwarding 2000 128.3 P2p
Et4 designated forwarding 2000 128.4 P2p

MST2 vlans mapped: 2
Bridgeaddress 0011.2233.4402priority8194 (8192 sysid 2)
Rootthis switch for MST2
```

| Interface | Role       | State      | Cost | Prio.Nbr | Type |
|-----------|------------|------------|------|----------|------|
| Et1       | designated | forwarding | 2000 | 128.1    | P2p  |
| Et2       | designated | forwarding | 2000 | 128.2    | P2p  |
| Et3       | designated | forwarding | 2000 | 128.3    | P2p  |
| Et4       | designated | forwarding | 2000 | 128.4    | P2p  |

##### MST3 vlans mapped: 3

Bridgeaddress 0011.2233.4402priority32771 (32768 sysid 3)

Rootaddress 0011.2233.4401priority32771 (32768 sysid 3)

| Interface | Role       | State      | Cost | Prio.Nbr | Type |
|-----------|------------|------------|------|----------|------|
| Et1       | root       | forwarding | 2000 | 128.1    | P2p  |
| Et2       | alternate  | discarding | 2000 | 128.2    | P2p  |
| Et3       | designated | forwarding | 2000 | 128.3    | P2p  |
| Et4       | designated | forwarding | 2000 | 128.4    | P2p  |

### 11.1.4.25 show spanning-tree root

The **show spanning-tree root** command displays the Bridge-ID, cost to the root bridge, root port, and the root bridge timer settings for all instances.

#### Command Mode

EXEC

#### Command Syntax

```
show spanning-tree root [INFO_LEVEL]
```

#### Parameters

- **INFO\_LEVEL** specifies output format. Options include:
  - **no parameter** output displays data in tabular format.
  - **detail** output displays a data block for each instance.

#### Examples

- This command displays a table of root bridge information.

```
switch#show spanning-tree root
 Root ID
Instance Priority MAC addr Cost Hello Max Fwd
----- -
MST0 32768 001c.7301.23de 0 2 20 15 Po937
MST101 32869 001c.7301.23de 3998 0 0 0 Po909
MST102 32870 001c.7301.23de 3998 0 0 0 Po911
switch>
```

- This command displays root bridge data blocks for each MSTP instance.

```
switch#show spanning-tree root detail
MST0
MST0
 Root ID Priority 32768
 Address 001c.7301.23de
 Cost 0 (Ext) 3998 (Int)
 Port 100 (Port-Channel937)
 Hello Time 2.000 sec Max Age 20 sec Forward Delay 15
sec
MST101
 Root ID Priority 32869
 Address 001c.7301.23de
 Cost 3998
 Port 107 (Port-Channel909)
 Hello Time 0.000 sec Max Age 0 sec Forward Delay 0
sec
MST102
 Root ID Priority 32870
 Address 001c.7301.23de
 Cost 3998
 Port 104 (Port-Channel911)
 Hello Time 0.000 sec Max Age 0 sec Forward Delay 0
sec
switch>
```

#### 11.1.4.26 show spanning-tree topology status

The **show spanning-tree topology status** command displays the forwarding state of ports on the specified VLANs.

##### Command Mode

EXEC

##### Command Syntax

```
show spanning-tree topology [VLAN_NAME] status [INFO_LEVEL]
```

##### Parameters

- **VLAN\_NAME** specifies the VLANs that the output displays. Options include:
  - **no parameter** output includes all VLANs.
  - **vlan** output includes all VLANs.
  - **vlan v\_num** command includes specified VLAN; **v\_num** ranges from 1 to 4094.
- **INFO\_LEVEL** specifies information provided by output. Options include:
  - **no parameter** output lists forwarding state of interfaces.
  - **detail** output lists forwarding state and change history of interfaces.

##### Examples

- This command displays forwarding state for ports mapped to all VLANs.

```
switch#show spanning-tree topology status
Topology: Cist
Mapped Vlans: 1-4,666,1000-1001,1004-1005
Cpu: forwarding
Ethernet2: forwarding
Ethernet3: forwarding
Ethernet4: forwarding
Ethernet5: forwarding
Ethernet6: forwarding
Ethernet8: forwarding
Ethernet10: forwarding
Port-Channel1: forwarding
Port-Channel2: forwarding
Port-Channel3: forwarding

switch>
```

- This command displays forwarding state and history for ports mapped to **VLAN 1000**.

```
switch#show spanning-tree topology vlan 1000 status detail
Topology: Cist
Mapped Vlans: 1000
Cpu: forwarding (1 changes, last 23 days, 22:54:43 ago)
Ethernet2: forwarding (3 changes, last 23 days, 22:48:59 ago)
Ethernet4: forwarding (3 changes, last 10 days, 19:54:17 ago)
Ethernet5: forwarding (3 changes, last 23 days, 22:54:38 ago)
Ethernet6: forwarding (3 changes, last 19 days, 15:49:10 ago)
Ethernet10: forwarding (3 changes, last 9 days, 7:37:05 ago)
Port-Channel1: forwarding (3 changes, last 23 days, 22:54:34 ago)
Port-Channel3: forwarding (5 changes, last 21 days, 4:56:41 ago)

switch>
```

### 11.1.4.27 show spanning-tree transmit active

The **show spanning-tree transmit active** command displays spanning tree protocol bridge assurance information for network ports or for all ports. Bridge assurance-enabled ports will not necessarily be blocked when they link to a port where bridge assurance is not enabled, but if they do not receive periodic BPDUs from the other side of the link the **show spanning-tree transmit active** command will show a bridge assurance status of inconsistent (blocking) for that port.

#### Command Mode

EXEC

#### Command Syntax

```
show spanning-tree transmit active INFO_LEVEL
```

#### Parameters

- **INFO\_LEVEL** specifies level of information detail provided by the command.
  - **no parameter** command displays bridge assurance information for network ports.
  - **detail** command displays bridge assurance information for all ports.

#### Example

This command displays the bridge assurance status of network ports.

```
switch#show spanning-tree transmit active
Name Bridge Assurance Status

VL1 Et5/1 consistent

Number of bridge assurance inconsistent ports in the system : 0
switch>
```

---

### 11.1.4.28 show spanning-tree

The `show spanning-tree command` displays spanning tree protocol (STP) data, organized by instance.

#### Command Mode

EXEC

#### Command Syntax

```
show spanning-tree [VLAN_ID] [INFO_LEVEL]
```

#### Parameters

- **VLAN\_ID** specifies the VLANs for which the command displays information. Formats include:
  - **no parameter** displays information for all VLANs.
  - **vlan** displays data for instances containing the first VLAN listed in running-config.
  - **vlan v\_range** displays data for instances containing a VLAN in the specified range.
- **INFO\_LEVEL** specifies level of information detail provided by the command.
  - **no parameter** displays table for each instance listing status, configuration, and history.
  - **detail** displays data blocks for each instance and all ports on each instance.

#### Display Values

- **Root ID** Displays information on the ROOT ID (elected spanning tree root bridge ID):
  - **Priority** Priority of the bridge. Default value is 32768.
  - **Address** MAC address of the bridge.
- **Bridge ID** bridge status and configuration information for the locally configured bridge:
  - **Priority** Priority of the bridge. The default priority is 32768.
  - **Address** MAC address of the bridge.
  - **Hello Time** Interval (seconds) between bridge protocol data units (BPDUs) transmissions.
  - **Max Age** Maximum time that a BPDU is saved.
  - **Forward Delay** Time (in seconds) that is spent in the learning state.
- **Interface** STP configuration participants. Link-down interfaces are not shown.
- **Role** Role of the port as one of the following:
  - **Root** The best port for a bridge to a root bridge used for forwarding.
  - **Designated** A forwarding port for a LAN segment.
  - **Alternate** A port acting as an alternate path to the root bridge.
  - **Backup** A port acting as a redundant path to another bridge port.
- **State** Displays the interface STP state as one of the following:
  - **Learning**
  - **Discarding**
  - **Forwarding**
- **Cost** STP port path cost value.
- **Prio. Nbr.** STP port priority. Values range from 0 to 240. Default is 128.
- **Type** The link type of the interface (automatically derived from the duplex mode of an interface):
  - **P2p Peer (STP)** Point to point full duplex port running standard STP.
  - **shr Peer (STP)** Shared half duplex port running standard STP.

#### Examples

- This command displays STP data, including a table of port parameters.

```
switch#show spanning-tree vlan 1000
```



```

MST0
 Spanning tree enabled protocol rstp
 Root ID Priority 32768
 Address 001c.7301.07b9
 Cost 1999 (Ext) 0 (Int)
 Port 101 (Port-Channel2)
 Hello Time 2.000 sec Max Age 20 sec Forward Delay 15
sec

 Bridge ID Priority 32768 (priority 32768 sys-id-ext 0)
 Address 001c.7304.195b
 Hello Time 2.000 sec Max Age 20 sec Forward Delay 15
sec

Interface Role State Cost Prio.Nbr Type

Et4 designated forwarding 20000 128.4 P2p
Et5 designated forwarding 20000 128.5 P2p
Et6 designated forwarding 20000 128.6 P2p
Et23 designated forwarding 20000 128.23 P2p
Et26 designated forwarding 20000 128.26 P2p
Et32 designated forwarding 2000 128.32 P2p

switch>

```

- This command displays output from the show spanning-tree command:

```

Switch#show spanning-tree
MST0
 Spanning tree enabled protocol mstp
 Root ID Priority 32768
 Address 0011.2201.0301
 This bridge is the root

 Bridge ID Priority 32768 (priority 32768 sys-id-ext 0)
 Address 0011.2201.0301
 Hello Time 2 sec Max Age 20 sec Forward Delay 15 sec

Interface Role State Cost Prio.Nbr Type

Et4 designated forwarding 2000 128.4 P2p
Et5 designated forwarding 2000 128.5 P2p
...
PEt4 designated forwarding 2000 128.31 P2p
PEt5 designated forwarding 2000 128.44 P2p
...
Po3 designated forwarding 1999 128.1003 P2p

```

- This command displays STP data, including an information block for each interface running STP.

```

switch#show spanning-tree vlan 1000 detail
MST0 is executing the rstp Spanning Tree protocol
 Bridge Identifier has priority 32768, sysid 0, address 001c.7304.195b
 Configured hello time 2.000, max age 20, forward delay 15, transmit
 hold-count 6
 Current root has priority 32768, address 001c.7301.07b9

```

---

```
Root port is 101 (Port-Channel2), cost of root path is 1999 (Ext) 0
(Int)
Number of topology changes 4109 last change occurred 1292651 seconds
ago
```

```
from Ethernet13
```

```
Port 4 (Ethernet4) of MST0 is designated forwarding
Port path cost 20000, Port priority 128, Port Identifier 128.4.
Designated root has priority 32768, address 001c.7301.07b9
Designated bridge has priority 32768, address 001c.7304.195b
Designated port id is 128.4, designated path cost 1999 (Ext) 0 (Int)
Timers: message age 1, forward delay 15, hold 20
Number of transitions to forwarding state: 1
Link type is point-to-point by default, Internal
BPDU: sent 452252, received 0, taggedErr 0, otherErr 0,
rateLimiterCount 0
Rate-Limiter: enabled, Window: 10 sec, Max-BPDU: 400
```

```
Port 5 (Ethernet5) of MST0 is designated forwarding
Port path cost 20000, Port priority 128, Port Identifier 128.5.
Designated root has priority 32768, address 001c.7301.07b9
Designated bridge has priority 32768, address 001c.7304.195b
Designated port id is 128.5, designated path cost 1999 (Ext) 0 (Int)
Timers: message age 1, forward delay 15, hold 20
Number of transitions to forwarding state: 1
Link type is point-to-point by default, Internal
BPDU: sent 1006266, received 0, taggedErr 0, otherErr 0,
rateLimiterCount 0
Rate-Limiter: enabled, Window: 10 sec, Max-BPDU: 400
```

```
switch#
```

### 11.1.4.29 shutdown (Loop-protection)

The **shutdown** command disables loop protection globally. The feature is disabled by default, and is enabled by using the **no shutdown** command.

 **Note:** To function, loop protection must also be enabled on a per-VLAN basis using the `protect vlan` command.

#### Command Mode

Loop-protection Configuration

#### Command Syntax

```
shutdown
```

```
no shutdown
```

#### Example

This command enables loop protection globally on the switch.

```
switch(config-monitor-loop-protect) #no shutdown
switch(config-monitor-loop-protect) #
```

---

### 11.1.4.30 spanning-tree bpdu tx hold-count

The **spanning-tree bpdu tx hold-count** command specifies the maximum number of BPDUs per second that the switch can send from an interface. Valid settings range from 1 to 10 BPDUs with a default of 6 BPDUs.

The **no spanning-tree bpdu tx hold-count** and **default spanning-tree bpdu tx hold-count** commands restore the transmit hold count default of 6 BPDUs by removing the **spanning-tree bpdu tx hold-count** command from *running-config*.

#### Command Mode

Global Configuration

#### Command Syntax

```
spanning-tree bpdu tx hold-count max_bpdu
```

```
no spanning-tree bpdu tx hold-count
```

```
default spanning-tree bpdu tx hold-count
```

#### Parameters

**max\_bpdu** BPDU packets. Value ranges from 1 to 10. Default is 6.

#### Example

This command configures a transmit hold-count of 8 BPDUs.

```
switch(config)#spanning-tree bpdu tx hold-count 8
switch(config)#
```

### 11.1.4.31 spanning-tree bpdudfilter

The `spanning-tree bpdudfilter` command controls bridge protocol data unit (BPDU) filtering on the configuration mode interface. BPDU filtering is disabled by default.

- `spanning-tree bpdudfilter enabled` enables BPDU filtering.
- `spanning-tree bpdudfilter disabled` disables BPDU filtering by removing the `spanning-tree bpdudfilter` command from *running-config*.

The BPDU filter default setting for portfast ports is configured by the `spanning-tree edge-port bpdudfilter default` command; BPDU filter is disabled by default on all non-portfast ports.

The `no spanning-tree bpdudfilter` and `default spanning-tree bpdudfilter` commands restore the global BPDU filter setting on the configuration mode interface by removing the corresponding `spanning-tree bpdudfilter` command from *running-config*.

#### Command Mode

Interface-Ethernet Configuration

Interface-Port-Channel Configuration

#### Command Syntax

```
spanning-tree bpdudfilter FILTER_STATUS
no spanning-tree bpdudfilter
default spanning-tree bpdudfilter
```

#### Parameters

- **FILTER\_STATUS** BPDU filtering status. Options include:
  - **enabled** BPDU filter is enabled on the interface.
  - **disabled** BPDU filter is disabled on the interface.

#### Example

This command enables BPDU filtering on Ethernet 5 interface.

```
switch(config)#interface ethernet 5
switch(config-if-Et5)#spanning-tree bpdudfilter enabled
switch(config-if-Et5)#
```

---

### 11.1.4.32 spanning-tree bpduguard rate-limit count (global)

The `spanning-tree bpduguard rate-limit count` command sets the maximum BPDU reception rate (quantity per interval) for ports that are not covered by a `spanning-tree bpduguard rate-limit count (interface)` command.

BPDU rate limiting restricts the number of BPDUs that ports with BPDU guard or BPDU filter disabled can process during a specified interval. Ports discard BPDUs they receive in excess of the specified limit. BPDU rate limiting is enabled or disabled by `spanning-tree bpduguard rate-limit enable / disable` commands.

The `no spanning-tree bpduguard rate-limit count` and `default spanning-tree bpduguard rate-limit count` commands restore the global setting to its default value by removing the `spanning-tree bpduguard rate-limit count` command from *running-config*.

#### Command Mode

Global Configuration

#### Command Syntax

```
spanning-tree bpduguard rate-limit count max_bpdu [interval period]
```

```
no spanning-tree bpduguard rate-limit count
```

```
default spanning-tree bpduguard rate-limit count
```

#### Parameters

- *max\_bpdu* configures the maximum number of BPDUs per timer interval. The value of *BPDU quantity* ranges from 1 to 20000.
- *interval period* configures the timer interval in seconds. The value of *period* ranges from 1 to 15.

#### Guidelines

Arista Networks recommends to retain the default values of rate limit.

In the PVST mode, when the VLAN membership of a port is changed by a significant margin, it is advisable to disable interface BPDU rate limit on both ends of a port. For example, if three VLANs are present on a port initially, the operator must first add 300 more VLANs on one side of the port and then add the same 300 VLANs on the other side of the port. In this case, if the VLANs are increased towards the root bridge first, then the other side can cross the rate-limit threshold.

#### Example

This command configures the global rate limit as 5000 BPDUs per four second period.

```
switch(config)#spanning-tree bpduguard rate-limit count 5000 interval 4
switch(config)#
```

### 11.1.4.33 spanning-tree bpduguard rate-limit count (interface)

The `spanning-tree bpduguard rate-limit count` command configures the maximum BPDU reception rate for the configuration mode interface. The default rate limit is specified by the `spanning-tree bpduguard rate-limit count (global)` command.

BPDU rate limiting restricts the number of BPDUs that ports with BPDU guard or BPDU filter disabled can process during a specified interval. Ports discard BPDUs it receives in excess of the specified limit. BPDU rate limiting is enabled or disabled by `spanning-tree bpduguard rate-limit enable / disable` commands.

The `no spanning-tree bpduguard rate-limit count` and `default spanning-tree bpduguard rate-limit count` commands restore the interface value to the global setting by removing the corresponding `spanning-tree bpduguard rate-limit count` command from *running-config*.

#### Command Mode

Interface-Ethernet Configuration

Interface-Port-Channel Configuration

#### Command Syntax

```
spanning-tree bpduguard rate-limit count max_bpdu [TIMER]
no spanning-tree bpduguard rate-limit count
default spanning-tree bpduguard rate-limit count
```

#### Parameters

- *max\_bpdu* BPDU quantity. Value ranges from 1 to 20,000.
- **TIMER** BPDU reception interval (seconds). Options include:
  - *period* reception interval defaults to **hello-time**.
  - **interval** *period* Value of *period* ranges from 1 to 15.

#### Example

These commands configure rate limit as **7500** BPDUs per 8 second period on *interface Ethernet 2*.

```
switch(config)#interface ethernet 2
switch(config-if-Et2)#spanning-tree bpduguard rate-limit count 7500
interval 8
switch(config-if-Et2)#
```

---

#### 11.1.4.34 spanning-tree bpduguard rate-limit default

The **spanning-tree bpduguard rate-limit default** command configures the global BPDU rate limit setting. The global BPDU rate limit setting provides the default for individual ports whose configuration does not include a [spanning-tree bpduguard rate-limit enable / disable](#) command. The default global setting is enabled.

BPDU rate limiting restricts the number of BPDUs that ports with BPDU guard or BPDU filter disabled can process during a specified interval. Ports discard BPDUs it receives in excess of the specified limit. BPDU rate limits are established by [spanning-tree bpduguard rate-limit count \(global\)](#) commands.

The **no spanning-tree bpduguard rate-limit default** sets the global BPDU rate limit setting to disabled. The **spanning-tree bpduguard rate-limit default** and **default spanning-tree bpduguard rate-limit default** commands restore the default global rate limit setting to enabled by removing the **no spanning-tree bpduguard rate-limit default** command from *running-config*.

##### Command Mode

Global Configuration

##### Command Syntax

```
spanning-tree bpduguard rate-limit default
no spanning-tree bpduguard rate-limit default
default spanning-tree bpduguard rate-limit default
```

##### Example

This command enables rate limiting on all ports not covered by an interface rate limit command.

```
switch(config)# spanning-tree bpduguard rate-limit default
switch(config)#
```



### 11.1.4.35 spanning-tree bpduguard rate-limit enable / disable

These commands enable and disable BPDU rate limiting on the configuration mode interface:

- `spanning-tree bpduguard rate-limit enable` enables BPDU rate limiting.
- `spanning-tree bpduguard rate-limit disable` disables BPDU rate limiting.

The `spanning-tree bpduguard rate-limit default` command enables BPDU rate limiting on all ports not configured with a `spanning-tree bpduguard rate-limit` command.

BPDU rate limiting restricts the number of BPDUs that ports with BPDU guard or BPDU filter disabled can process during a specified interval. Ports discard BPDUs it receives in excess of the specified limit. BPDU rate limits are established by `spanning-tree bpduguard rate-limit count (interface)` commands.

The `no spanning-tree bpduguard rate-limit` and `default spanning-tree bpduguard rate-limit` commands restore the global rate limit setting on the configuration mode interface by removing the corresponding `spanning-tree bpduguard rate-limit` command from *running-config*.

#### Command Mode

Interface-Ethernet Configuration

Interface-Port-Channel Configuration

#### Command Syntax

```
spanning-tree bpduguard rate-limit enable
spanning-tree bpduguard rate-limit disable
no spanning-tree bpduguard rate-limit
default spanning-tree bpduguard rate-limit
```

#### Example

These commands enable rate limiting on *interface Ethernet 15*.

```
switch(config)#interface ethernet 15
switch(config-if-Et15)#spanning-tree bpduguard rate-limit enable
switch(config-if-Et15)#
```

---

### 11.1.4.36 spanning-tree bpduguard

The **spanning-tree bpduguard** command controls BPDU guard on the configuration mode interface. A BPDU guard-enabled port is disabled when it receives a BPDU packet.

The BPDU guard default setting for portfast ports is configured by the [spanning-tree edge-port bpduguard default](#) command; BPDU guard is disabled by default on all non-portfast ports.

The **no spanning-tree bpduguard** and **default spanning-tree bpduguard** commands restore the global BPDU guard setting on the configuration mode interface by removing the corresponding **spanning-tree bpduguard** command from *running-config*.

#### Command Mode

Interface-Ethernet Configuration

Interface-Port-Channel Configuration

#### Command Syntax

```
spanning-tree bpduguard GUARD_ACTION
```

```
no spanning-tree bpduguard
```

```
default spanning-tree bpduguard
```

#### Parameters

- **GUARD\_ACTION** BPDU guard setting. Options include:
  - **disable** Disable bpduguard
  - **enable** Enable bpduguard
  - **rate-limit** BPDU Input Rate Limiter options

#### Example

These commands enable BPDU guard on *interface Ethernet 5*.

```
switch(config)#interface ethernet 5
switch(config-if-Et5)#spanning-tree bpduguard enabled
switch(config-if-Et5)
```

### 11.1.4.37 spanning-tree cost

The **spanning-tree cost** command configures the path cost of the configuration mode interface. Cost values range from 1 to 200000000 (200 million). The default cost depends on the interface speed:

- 1 gigabit interface: cost = 20000
- 10 gigabit interface: cost = 2000

The **spanning-tree cost** command provides a mode option:

- RST instance cost is configured by not including a mode.
- MST instance 0 cost is configured by not including a mode or with the **mst** mode option.
- MST instance cost is configured with the **mst** mode option.
- Rapid-PVST VLAN cost is configured with the **vlan** mode option.

The **no spanning-tree cost** and **default spanning-tree cost** commands restore the default cost on the configuration mode interface by removing the corresponding **spanning-tree cost** command from *running-config*.

#### Command Mode

Interface-Ethernet Configuration

Interface-Port-Channel Configuration

#### Command Syntax

```
spanning-tree MODE cost value
```

```
no spanning-tree MODE cost
```

```
default spanning-tree MODE cost
```

#### Parameters

- **MODE** specifies the spanning tree instances for which the cost is configured. Values include:
  - **no parameter** RST instance, MST instance 0, or all Rapid-PVST instances permitted on the interface.
  - **mst m\_range** specified MST instances. **m\_range** formats include a number, number range, or comma-delimited list of numbers and ranges. Instance numbers range from 0 to 4094.
  - **vlan v\_range** specified Rapid-PVST instances. **v\_range** formats include a number, number range, or comma-delimited list of numbers and ranges. VLAN numbers range from 1 to 4094.
- **value** path cost assigned to interface. Values range from 1 to 200000000 (200 million). Default values are 20000 (1 G interfaces) or 2000 (10 G interfaces).

#### Examples

- These commands configure a port cost of **25000** for **interface Ethernet 5** when configured as an RST port, as a port in MST instance 0, or all unconfigured Rapid-PVST instances that are not explicitly configured.

```
switch(config)#interface ethernet 5
switch(config-if-Et5)#spanning tree cost 25000
```

- This command configures a port cost of **30000** for **interface Ethernet 5** when configured as a port in MST instance 200.

```
switch(config-if-Et5)#spanning tree mst 200 cost 30000
```

- This command configures a port cost of **100000** for **interface Ethernet 5** when configured as a port in VLANs 200-220.

```
switch(config-if-Et5)#spanning tree vlan 200-220 cost 100000
```

---

```
switch(config-if-Et5) #
```

### 11.1.4.38 spanning-tree edge-port bpdufilter default

The **spanning-tree edge-port bpdufilter default** command configures the global BPDU filter setting as enabled. Ports not covered by a [spanning-tree bpdufilter](#) command use the global BPDU filter setting.

#### Command Mode

Global Configuration

#### Command Syntax

```
spanning-tree edge-port bpdufilter default
no spanning-tree edge-port bpdufilter default
default spanning-tree edge-port bpdufilter default
```

#### Example

This command configures the BPDU filter global setting to **enabled**.

```
switch(config)#spanning-tree edge-port bpdufilter default
switch(config)#
```

---

### 11.1.4.39 spanning-tree edge-port bpduguard default

The **spanning-tree edge-port bpduguard default** command sets the global BPDU guard setting as **enabled**. Ports not covered by a [spanning-tree bpduguard](#) command use the global BPDU guard setting.

#### Command Mode

Global Configuration

#### Command Syntax

```
spanning-tree edge-port bpduguard default
no spanning-tree edge-port bpduguard default
default spanning-tree edge-port bpduguard default
```

#### Example

This command configures the global BPDU guard setting to enabled.

```
switch(config)#spanning-tree edge-port bpduguard default
switch(config)#
```

#### 11.1.4.40 spanning-tree forward-time

The **spanning-tree forward-time** command configures the forward delay timer. Forward delay is the time that a port is in learning state before it begins forwarding data packets.

The switch inserts the forward delay timer value in BPDU packets it sends as the root bridge. The forward delay value ranges from 4 to 30 seconds with a default of 15 seconds.

The **no spanning-tree forward-time** and **default spanning-tree forward-time** commands restore the forward delay timer default of 15 seconds by removing the **spanning-tree forward-time** command from *running-config*.

##### Command Mode

Global Configuration

##### Command Syntax

**spanning-tree forward-time *period***

no spanning-tree forward-time

default spanning-tree forward-time

##### Parameters

***period*** forward delay timer (seconds). Value ranges from 4 to 30. Default is 15.

##### Example

This command sets the forward delay timer value to **25** seconds.

```
switch(config)#spanning-tree forward-time 25
switch(config)#
```

---

#### 11.1.4.41 spanning-tree guard loop default

The **spanning-tree guard loop default** command configures the global loop guard setting as enabled. Ports not covered by a **spanning-tree guard** command use the global loop guard setting. Loop guard prevents blocked or root ports from becoming a designated port due to failures resulting in a unidirectional link. The **spanning-tree guard** interface configuration statement overrides the global setting for a specified interface. The default global loop guard setting is disabled.

The **no spanning-tree guard loop default** and **default spanning-tree guard loop default** commands restore the global loop guard setting of disabled by removing the **spanning-tree guard loop default** command from *running-config*.

##### Command Mode

Global Configuration

##### Command Syntax

```
spanning-tree guard loop default
no spanning-tree guard loop default
default spanning-tree guard loop default
```

##### Example

This command enables loop guard as the default on all switch ports.

```
switch(config)#spanning-tree guard loop default
switch(config)#
```



#### 11.1.4.42 spanning-tree guard

The **spanning-tree guard** command enables root guard or loop guard on the configuration mode interface. The **spanning-tree guard loop default** command configures the global loop guard setting.

- Root guard prevents a port from becoming a root or blocked port. A root guard port that receives a superior BPDU transitions to the root-inconsistent (blocked) state.
- Loop guard protects against loops resulting from unidirectional link failures on point-to-point links by preventing non-designated ports from becoming designated ports. When loop guard is enabled, a root or blocked port transitions to loop-inconsistent (blocked) state if it stops receiving BPDUs from its designated port. The port returns to its prior state when it receives a BPDU.

The **no spanning-tree guard** and **default spanning-tree guard** commands sets the configuration mode interface to the global loop guard mode by removing the **spanning-tree guard** statement from **running-config**. The **spanning-tree guard none** command disables loop guard and root guard on the interface, overriding the global setting.

##### Command Mode

Interface-Ethernet Configuration

Interface-Port-Channel Configuration

##### Command Syntax

**spanning-tree guard PORT\_MODE**

```
no spanning-tree guard
```

```
default spanning-tree guard
```

##### Parameters

- **PORT\_MODE** the port mode. Options include:
  - **loop** enables loop guard on the interface.
  - **root** enables root guard on the interface.
  - **none** disables root guard and loop guard.

##### Example

This command enables root guard on **interface Ethernet 5**.

```
switch(config)#interface ethernet 5
switch(config-if-Et5)#spanning-tree guard root
switch(config-if-Et5)#
```

---

#### 11.1.4.43 spanning-tree hello-time

The **spanning-tree hello-time** command configures the hello time, which specifies the transmission interval between consecutive bridge protocol data units (BPDU) that the switch sends as a root bridge. The hello time is also inserted in outbound BPDUs.

This hello time ranges from 0.2 seconds to 10 seconds with a default of 2 seconds.

The **no spanning-tree hello-time** and **default spanning-tree hello-time** commands restore the hello time default of 2 seconds by removing the **spanning-tree hello-time** command from *running-config*.

##### Command Mode

Global Configuration

##### Command Syntax

**spanning-tree hello-time *period***

no spanning-tree hello-time

default spanning-tree hello-time

##### Parameters

***period*** hello-time (milliseconds). Value ranges from 200 to 10000. Default is 2000.

##### Example

This command configures a hello-time of one second.

```
switch(config)#spanning-tree hello-time 1000
switch(config)#
```

#### 11.1.4.44 spanning-tree link-type

The **spanning-tree link-type** command specifies the configuration mode interfaces link type, which is normally derived from the ports duplex setting. The default setting depends on a ports duplex mode:

- full-duplex ports are **point-to-point**.
- half-duplex ports are **shared**.

The **no spanning-tree link-type** and **default spanning-tree link-type** commands restore the default link type on the configuration mode interface by removing the corresponding **spanning-tree link-type** command from *running-config*.

##### Command Mode

Interface-Ethernet Configuration

Interface-Port-Channel Configuration

##### Command Syntax

**spanning-tree link-type TYPE**

no spanning-tree link-type

default spanning-tree link-type

##### Parameters

- **TYPE** link type of the configuration mode interface. Options include:
  - **point-to-point**
  - **shared**

##### Example

This command configures *interface Ethernet 5* as a shared port.

```
switch(config)#interface ethernet 5
switch(config-if-Et5)#spanning-tree link-type shared
switch(config-if-Et5)#
```

---

#### 11.1.4.45 spanning-tree max-age

The **spanning-tree max-age** command configures the switch's max age timer, which specifies the max age value that the switch inserts in outbound BPDU packets it sends as a root bridge. The max-age time value ranges from 6 to 40 seconds with a default of 20 seconds.

Max age is the interval, specified in the BPDU, that BPDU data remains valid after its reception. The bridge recomputes the spanning tree topology if it does not receive a new BPDU before max age expiry.

The **no spanning-tree max-age** and **default spanning-tree max-age** commands restore the max-age default of 20 seconds by removing the **spanning-tree max-age** command from **running-config**.

##### Command Mode

Global Configuration

##### Command Syntax

**spanning-tree max-age *period***

no spanning-tree max-age

default spanning-tree max-age

##### Parameters

***period*** max age period (seconds). Value ranges from 6 to 40. Default is 20.

##### Example

This command sets the max age timer value to **25** seconds.

```
switch(config)#spanning-tree max-age 25
switch(config)#
```

#### 11.1.4.46 spanning-tree max-hops

The **spanning-tree max-hops** command specifies the max hop setting that the switch inserts into BPDUs that it sends out as the root bridge. The max hop setting determines the number of bridges in an MST region that a BPDU can traverse before it is discarded. The max-hop value ranges from 1 to 40 with a default of 20.

The **no spanning-tree max-hops** and **default spanning-tree max-hops** commands restore the max-hops setting to its default value of 20 by removing the **spanning-tree max-hops** command from **running-config**.

##### Command Mode

Global Configuration

##### Command Syntax

```
spanning-tree max-hops ports
```

```
no spanning-tree max-hops
```

```
default spanning-tree max-hops
```

##### Parameters

**ports** max hops (bridges). Value ranges from 1 to 40. Default is 20.

##### Example

This command sets the max hop value to **40**.

```
switch(config)#spanning-tree max-hop 40
switch(config)#
```

---

#### 11.1.4.47 spanning-tree mode

The **spanning-tree mode** command specifies the spanning tree protocol version that the switch runs. The default mode is Multiple Spanning Tree (MSTP).

The **no spanning-tree mode** and **default spanning-tree mode** commands restore the default spanning tree protocol version.



**Note:** The **spanning-tree mode** command may disrupt user traffic. When the switch starts a different STP version, all spanning-tree instances are stopped, then restarted in the new mode.

#### Command Mode

Global Configuration

#### Command Syntax

```
spanning-tree mode VERSION
```

```
no spanning-tree mode
```

```
default spanning-tree mode
```

#### Parameters

- **VERSION** spanning tree version that the switch runs. Options include:
  - **mstp** multiple spanning tree protocol described in the *IEEE 802.1Q-2005* specification and originally specified in the *IEEE 802.1s* specification.
  - **rstp** rapid spanning tree protocol described in the *IEEE 802.1D-2004* specification and originally specified in the *IEEE 802.1w* specification.
  - **rapid-pvst** rapid per-VLAN spanning tree protocol described in the *IEEE 802.1D-2004* specification and originally specified in the *IEEE 802.1w* specification.
  - **backup** disables STP and enables switchport interface pairs configured with the [switchport backup-link](#) command.
  - **none** disables STP. The switch does not generate STP packets. Each switchport interface forwards data packets to all connected ports and forwards STP packets as multicast data packets on the VLAN where they are received.

#### Guidelines

Backup mode is not available on Trident platform switches.

#### Example

This command configures the switch to run multiple spanning tree protocol.

```
switch(config)#spanning-tree mode mstp
switch(config)#
```

### 11.1.4.48 spanning-tree mst configuration

The **spanning-tree mst configuration** command places the switch in MST-configuration mode, which is the group change mode where MST region parameters are configured.

Changes made in a group change mode are saved by leaving the mode through the **exit** command or by entering another configuration mode. To discard changes from the current edit session, leave the mode with the **abort** command.

These commands are available in MST-configuration mode:

- `abort (mst-configuration mode)`
- `exit (mst-configuration mode)`
- `instance`
- `name (mst-configuration mode)`
- `revision (mst-configuration mode)`
- `show (mst-configuration mode)`

The **no spanning-tree mst configuration** and **default spanning-tree mst configuration** commands restore the MST default configuration.

#### Command Mode

Global Configuration

#### Command Syntax

```
spanning-tree mst configuration
```

```
no spanning-tree mst configuration
```

```
default spanning-tree mst configuration
```

#### Examples

- This command enters MST configuration mode.

```
switch(config)#spanning-tree mst configuration
switch(config-mst)#
```

- This command exits MST configuration mode, saving MST region configuration changes to **running-config**.

```
switch(config-mst)#exit
switch(config)#
```

- This command exits MST configuration mode without saving MST region configuration changes to **running-config**.

```
switch(config-mst)#abort
switch(config)#
```

---

#### 11.1.4.49 spanning-tree mst pvst border

The **spanning-tree mst pvst border** command configures MSTP PVST border feature to automatically detect border ports facing PVST+ regions. By default, spanning-tree mst pvst border is disabled.

The **no spanning-tree mst pvst border** and **default spanning-tree mst pvst border** commands restore the default MST configuration.

##### Command Mode

MST Configuration

##### Command Syntax

```
spanning-tree mst pvst border
```

```
no spanning-tree mst pvst border
```

```
default spanning-tree mst pvst border
```

##### Example

This command enters the MST configuration mode.

```
switch(config)#spanning-tree mst configuration
switch(config-mst)#spanning-tree mst pvst border
```



### 11.1.4.50 spanning-tree portchannel guard misconfig

The **spanning-tree portchannel guard misconfig** command enables the switch to detect misconfigured port channels that may cause network loops by monitoring inbound BPDUs. When a port channel receives 75 inconsistent BPDUs within 30 seconds, the switch error disables the port. When a port channel receives 5 BPDUs with the same source BPDU during the 30 second measurement interval, the error counter is reset and the port continues normal port channel operation. Misconfigured port channel detection is disabled by default.

The **no spanning-tree portchannel guard misconfig** and **default spanning-tree portchannel guard misconfig** commands disables the detection of misconfigured port channels by removing the **spanning-tree portchannel guard misconfig** statement from **running-config**.

#### Command Mode

Global Configuration

#### Command Syntax

```
spanning-tree portchannel guard misconfig
no spanning-tree portchannel guard misconfig
default spanning-tree portchannel guard misconfig

spanning-tree etherchannel guard misconfig
no spanning-tree etherchannel guard misconfig
default spanning-tree etherchannel guard misconfig
```

#### Guidelines

The **spanning-tree portchannel guard misconfig** and **spanning-tree etherchannel guard misconfig** commands are equivalent.

#### Examples

- This command enables port channel misconfiguration detection on the switch.

```
switch(config)#spanning-tree portchannel guard misconfig
switch(config)#show running-config

!
spanning-tree mode mstp
spanning-tree portchannel guard misconfig
!

!
end
switch(config)#
```

- This command disables port channel misconfiguration detection on the switch.

```
switch(config)#no spanning-tree portchannel guard misconfig
switch(config)#show running-config

!
spanning-tree mode mstp
!

!
end
switch(config)#
```

---

#### 11.1.4.51 spanning-tree portfast auto

The **spanning-tree portfast auto** command enables auto-edge detection on the configuration mode interface. When auto-edge detection is enabled, the port is configured as an edge port if it does not receive a new BPDU before the current BPDU expires. Auto-edge detection is enabled by default. The **spanning-tree portfast** command, when configured, has priority over this command.

The **no spanning-tree portfast auto** command disables auto-edge port detection. This command is removed from **running-config** with the **spanning-tree portfast auto** and **default spanning-tree portfast auto** commands.

##### Command Mode

Interface-Ethernet Configuration

Interface-Port-Channel Configuration

##### Command Syntax

```
spanning-tree portfast auto
no spanning-tree portfast auto
default spanning-tree portfast auto
```

##### Example

This command enables auto-edge detection on **interface Ethernet 5**.

```
switch(config)#interface ethernet 5
switch(config-if-Et5)#spanning-tree portfast auto
switch(config-if-Et5)#
```

### 11.1.4.52 spanning-tree portfast <port type>

The **spanning-tree portfast** command specifies the STP port mode for the configuration mode interface. Default port mode is normal.

Port modes include:

- **Edge:** Edge ports connect to hosts and transition to the forwarding state when the link is established. An edge port that receives a BPDU becomes a normal port.
- **Network:** Network ports connect only to switches or bridges and support bridge assurance. Network ports that connect to hosts or other edge devices transition to the discarding state.
- **Normal:** Normal ports function as normal STP ports and can connect to any type of device.

The **no spanning-tree portfast <port-type>** and **default spanning-tree portfast <port-type>** commands restore the default port mode of normal by removing the corresponding **spanning-tree portfast <port-type>** command from *running-config*.

#### Command Mode

Interface-Ethernet Configuration

Interface-Port-Channel Configuration

#### Command Syntax

```
spanning-tree portfast PORT_MODE
no spanning-tree portfast PORT_MODE
default spanning-tree portfast PORT_MODE
```

#### Parameters

- **PORT\_MODE** STP port mode. Options include:
  - **edge**
  - **network**
  - **normal**

The **normal** option is not available for the **no** and **default** commands.

#### Related Commands

The **spanning-tree portfast** command also affects the **spanning-tree portfast auto** and **spanning-tree portfast** configuration for the configuration mode interface:

- **spanning-tree portfast normal:** **spanning-tree portfast auto** is enabled.
- **spanning-tree portfast edge:** **spanning-tree portfast** is enabled.
- **spanning-tree portfast network:** **spanning-tree portfast auto** is disabled.

#### Example

This command configures *interface Ethernet 5* as a network port.

```
switch(config)#interface ethernet 5
switch(config-if-Et5)#spanning-tree portfast network
switch(config-if-Et5)#
```

---

### 11.1.4.53 spanning-tree portfast

The **spanning-tree portfast** command programs configuration mode ports to immediately enter forwarding state when they establish a link. PortFast ports are included in spanning tree topology calculations and can enter discarding state. This command overrides the `spanning-tree portfast auto` command.

The **no spanning-tree portfast** and **default spanning-tree portfast** commands remove the corresponding **spanning-tree portfast** command from *running-config*.

#### Command Mode

Interface-Ethernet Configuration

Interface-Port-Channel Configuration

#### Command Syntax

```
spanning-tree portfast
no spanning-tree portfast
default spanning-tree portfast
```

#### Example

This command unconditionally enables portfast on *interface Ethernet 5*.

```
switch(config)#interface ethernet 5
switch(config-if-Et5)#spanning-tree portfast
switch(config-if-Et5)#
```

### 11.1.4.54 spanning-tree port-priority

The **spanning-tree port-priority** command specifies the configuration mode interfaces port-priority number. The switch uses this number to determine which interface it places into forwarding mode when resolving a loop. Valid settings are all multiples of 16 between 0 and 240. Default value is 128. Ports with lower numerical priority values are selected over other ports.

The **no spanning-tree port-priority** and default spanning-tree port-priority commands restore the default of 128 for the configuration mode interface by removing the **spanning-tree port-priority** command from *running-config*.

The **spanning-tree port-priority** command provides a mode option:

- RST instance port-priority is configured by not including a mode.
- MST instance 0 port-priority is configured by not including a mode or with the **mst** mode option.
- MST instance port-priority is configured with the **mst** mode option.
- Rapid-PVST VLAN port-priority is configured with the **vlan** mode option.

#### Command Mode

Interface-Ethernet Configuration

Interface-Port-Channel Configuration

#### Command Syntax

```
spanning-tree [MODE] port-priority value
no spanning-tree [MODE] port-priority
default spanning-tree [MODE] port-priority
```

#### Parameters

- **MODE** specifies the spanning tree instances for which the cost is configured. Values include:
  - **no parameter** RST instance or MST instance 0.
  - **mst *m\_range*** specified MST instances. ***m\_range*** formats include a number, number range, or comma-delimited list of numbers and ranges. Instance numbers range from 0 to 4094.
  - **vlan *v\_range*** specified Rapid-PVST instances. ***v\_range*** formats include a number, number range, or comma-delimited list of numbers and ranges. VLAN numbers range from 1 to 4094.
- **value** bridge priority number. Values range from 0 to 240 and must be a multiple of 16.

#### Example

This command sets the port priority of *interface Ethernet 5* to **144**.

```
switch(config)#interface ethernet 5
switch(config-if-Et5)#spanning-tree port-priority 144
switch(config-if-Et5)#
```

---

### 11.1.4.55 spanning-tree priority

The **spanning-tree priority** command configures the bridge priority number. The bridge priority is the four most significant digits of the bridge ID, which is used by spanning tree algorithms to select the root bridge and choose among redundant links. Bridge ID numbers range from 0 to 65535 (16 bits); bridges with smaller bridge IDs are elected over other bridges.

Because bridge priority sets the four most significant bits of the bridge ID, valid settings include all multiples of 4096 between 0 and 61440. Default value is 32768.

The **spanning-tree priority** command provides a mode option:

- RST instance priority is configured by not including a mode.
- MST instance 0 priority is configured by not including a mode or with the **mst** mode option.
- MST instance priority is configured with the **mst** mode option.
- Rapid-PVST VLAN priority is configured with the **vlan** mode option.

The **no spanning-tree priority** and **default spanning-tree priority** commands restore the bridge priority default of 32768 for the specified mode by removing the corresponding **spanning-tree priority** command from *running-config*.

Another method of adding **spanning-tree priority** commands to the configuration is through the **spanning-tree root** command. Similarly, the **no spanning-tree root** command removes the corresponding **spanning-tree priority** command from *running-config*.

#### Command Mode

Global Configuration

#### Command Syntax

```
spanning-tree [MODE] priority level
no spanning-tree [MODE] priority
default spanning-tree [MODE] priority
```

#### Parameters

- **MODE** spanning tree instances for which the command configures priority. Options include:
  - **no parameter** RST instance or MST instance 0.
  - **mst m\_range** specified MST instances. **m\_range** formats include a number, number range, or comma-delimited list of numbers and ranges. Instance numbers range from 0 to 4094.
  - **vlan v\_range** specified Rapid-PVST instances. **v\_range** formats include a number, number range, or comma-delimited list of numbers and ranges. VLAN numbers range from 1 to 4094.
- **level** priority number. Values include multiples of 4096 between 0 and 61440. Default is 32768.

#### Examples

- This command configures a bridge priority value of 20480 for Rapid-PVST VLANs 20, 24, 28, and 32.

```
switch(config)#spanning-tree vlan-id 20,24,28,32 priority 20480
switch(config)#
```

- This command configures a bridge priority value of 36864 for the RST instance. When MST is enabled, this command configures a priority of 36864 for MST instance 0.

```
switch(config)#spanning-tree priority 36864
switch(config)#
```

### 11.1.4.56 spanning-tree root

The **spanning-tree root** command configures the bridge priority number by adding a **spanning-tree priority** command to the configuration. Parameter settings set the following priority values:

- **primary** sets the bridge priority to 8192.
- **secondary** sets the bridge priority to 16384.

The bridge priority is the four most significant digits of the bridge ID, which is used by spanning tree algorithms to select the root bridge and choose among redundant links. Bridge ID numbers range from 0 to 65535 (16 bits); bridges with smaller bridge IDs are elected over other bridges.

When no other switch in the network is similarly configured, assigning the primary value to the switch facilitates its selection as the root switch. Assigning the secondary value to the switch facilitates its selection as the backup root in a network that contains one switch with a smaller priority number.

The **spanning-tree root** command provides a mode option:

- RST instance priority is configured by not including a mode.
- MST instance 0 priority is configured by not including a mode or with the **mst** mode option.
- MST instance priority is configured with the **mst** mode option.
- Rapid-PVST VLAN priority is configured with the **vlan** mode option.

The **no spanning-tree root** and **default spanning-tree root** commands restore the bridge priority default of 32768 by removing the corresponding **spanning-tree priority** command from **running-config**. The **no spanning-tree root**, **no spanning-tree priority**, **default spanning-tree root** and **default spanning-tree priority** commands perform the same function.

#### Command Mode

Global Configuration

#### Command Syntax

```
spanning-tree [MODE] root TYPE
```

```
no spanning-tree [MODE] root
```

```
default spanning-tree [MODE] root
```

#### Parameters

- **MODE** specifies the spanning tree instances for which priority is configured. Values include:
  - **no parameter** RST instance or MST instance 0.
  - **mst m\_range** specified MST instances. **m\_range** formats include a number, number range, or comma-delimited list of numbers and ranges. Instance numbers range from 0 to 4094.
  - **vlan v\_range** specified Rapid-PVST instances. **v\_range** formats include a number, number range, or comma-delimited list of numbers and ranges. VLAN numbers range from 1 to 4094.
- **TYPE** sets the bridge priority number. Values include:
  - **primary** sets the bridge priority to 8192.
  - **secondary** sets the bridge priority to 16384.

#### Examples

- This command configures a bridge priority value of 8192 for Rapid-PVST VLANs 20-36.

```
switch(config)#spanning-tree vlan-id 20-36 root primary
```

- 
- This command configures a bridge priority value of 16384 for the RSTP instance and MST instance 0.

```
switch(config)#spanning-tree root secondary
```



### 11.1.4.57 spanning-tree transmit active

The **spanning-tree transmit active** command enables bridge assurance globally, which enables bridge assurance on all ports with a port type of network. Bridge assurance protects against unidirectional link failure, other software failure, and devices that quit running a spanning tree algorithm.

Bridge assurance is available only on point-to-point links on spanning tree network ports. Both ends of the link should ideally have bridge assurance enabled. Bridge assurance-enabled ports will not necessarily be blocked when they link to a port where bridge assurance is not enabled, but if they do not receive periodic BPDUs from the other side of the link the `show spanning-tree transmit active` command will show a bridge assurance status of inconsistent (blocking) for that port.

The **no spanning-tree transmit active** command disables bridge assurance.

The **spanning-tree transmit active** and **default spanning-tree transmit active** commands restore the default behavior by removing the **no spanning-tree transmit active** command from *running-config*.

#### Command Mode

Global Configuration

#### Command Syntax

```
spanning-tree transmit active
no spanning-tree transmit active
default spanning-tree transmit active
```

#### Example

This command enables bridge assurance on the switch.

```
switch(config)#spanning-tree transmit active
switch(config)#
```

---

### 11.1.4.58 spanning-tree vlan-id

The **spanning-tree vlan-id** command enables Spanning Tree Protocol (STP) on specified VLANs by removing any corresponding **no spanning-tree vlan-id** statements from **running-config**. Spanning-tree is enabled on all VLANs by default.

The **no spanning-tree vlan-id** command disables STP on the specified interfaces. The **default spanning-tree vlan-id** enables STP on the specified interfaces.

 **Note:** Disabling STP is not recommended, even in topologies free of physical loops; STP guards against configuration mistakes and cabling errors. When disabling STP, ensure that there are no physical loops in the VLAN.

When disabling STP on a VLAN, ensure that all switches and bridges in the network disable STP for the same VLAN. Disabling STP on a subset of switches and bridges in a VLAN may have unexpected results because switches and bridges running STP will have incomplete information regarding the network's physical topology.

The following STP global configuration commands provide a **vlan** option for configuring Rapid-PVST VLAN instances:

- [spanning-tree priority](#)
- [spanning-tree root](#)

#### Command Mode

Global Configuration

#### Command Syntax

```
spanning-tree vlan-id v_range
no spanning-tree vlan-id v_range
default spanning-tree vlan-id v_range
```

#### Parameters

**v\_range** VLAN list. Formats include a number, number range, or comma-delimited list of numbers and ranges. VLAN numbers range from 1 to 4094.

#### Examples

- This command disables STP on **VLANs 200-205**.

```
switch(config)#no spanning-tree vlan-id 200-205
switch(config)#
```

- This command enables STP on **VLAN 203**.

```
switch(config)#spanning-tree vlan-id 203
switch(config)#
```

### 11.1.4.59 switchport backup-link

The **switchport backup-link** command establishes a primary-backup configuration for forwarding VLAN traffic between the command mode interface and a specified interface. The **show interfaces switchport backup-link** command displays the state of backup interface pairs on the switch:

- the primary interface is the command mode interface.
- the backup interface is the interface specified in the command.

The following guidelines apply to primary and backup interfaces.

- Ethernet and Port Channels can be primary interfaces.
- Ethernet, Port Channel, Management, Loopback, and VLANs can be backup interfaces.
- The primary and backup interfaces can be different interface types.
- Interface pairs should be similarly configured to ensure consistent behavior.
- An interface can be associated with a maximum of one backup interface.
- An interface can back up a maximum of one interface.
- Any Ethernet interface configured in an interface pair cannot be a port channel member.
- The STP mode is backup.
- Static MAC addresses should be configured after primary-backup pairs are established.

When load balancing is not enabled, the primary and backup interfaces cannot simultaneously forward VLAN traffic. When the primary interface is forwarding VLAN traffic, the backup interface drops all traffic. If the primary interface fails, the backup interface forwards VLAN traffic until the primary interface is functional.

The **prefer vlan** option balances the load across the primary and backup interfaces. When the command includes the **prefer vlan** option, each interface is the primary for a subset of the vlans carried by the pair. When both interfaces are up, prefer option vlans are forwarded on the backup interface and all other configured vlans are carried by the primary interface.

The **no switchport backup-link** and **default switchport backup-link** commands remove the primary-backup configuration for the configuration mode interface.

#### Command Mode

Interface-Ethernet Configuration

Interface-Port Channel Configuration

#### Command Syntax

```
switchport backup-link INT_NAME [BALANCE]
no switchport backup-link
default switchport backup-link
```

#### Parameters

- **INT\_NAME** the backup interface. Options include:
  - **ethernet e\_num** Ethernet interface specified by **e\_num**.
  - **loopback l\_num** Loopback interface specified by **l\_num**.
  - **management m\_num** Management interface specified by **m\_num**.
  - **port-channel p\_num** Channel group interface specified by **p\_num**.
  - **vlan v\_num** VLAN interface specified by **v\_num**.
  - **vxlan vx\_num** VXLAN interface specified by **vx\_num**.
- **BALANCE** VLANs whose traffic is normally handled on the backup interfaces. Values include:
  - **no parameter** backup interface handles no traffic if the primary interface is operating.
  - **prefer vlan v\_range** list of VLANs whose traffic is handled by backup interface.

---

## Examples

- These commands establish *interface Ethernet 7* as the backup port for *interface Ethernet 1*.

```
switch(config)#interface ethernet 1
switch(config-if-Et1)#switchport backup-link ethernet 7
switch(config-if-Et1)#
```

- These commands configure the following:
  - *interface Ethernet 1* as a trunk port that handles VLAN 4 through 9 traffic.
  - *interface Ethernet 2* as its backup interface.
  - *interface Ethernet 2* as the preferred interface for VLANs 7 through 9.

```
switch(config-if-Et1)#switchport mode trunk
switch(config-if-Et1)#switchport trunk allowed vlan 4-9
switch(config-if-Et1)#switchport backup-link Ethernet 2 prefer vlan
7-9
switch(config-if-Et1)#
```

#### 11.1.4.60 transmit-interval

The **transmit-interval** command sets the interval at which loop detection packets are transmitted. The **no transmit-interval** and **default transmit-interval** commands restore the transmission interval to the default of 5 seconds.

##### Command Mode

Loop-protection Configuration

##### Command Syntax

```
transmit-interval interval
```

##### Parameters

***interval*** Interval in seconds at which loop-detection packets are transmitted. Values range from 1 to 10; default is 5.

##### Example

This command sets the loop detection packet transmission interval to **10** seconds.

```
switch(config-monitor-loop-protect) #transmit-interval 10
switch(config-monitor-loop-protect) #
```

---

## 11.2 Link Layer Discovery Protocol

This section describes Link Layer Discovery Protocol (LLDP) configuration tasks. Refer to the command descriptions for information about commands used in this chapter.

Topics in this section include:

- [LLDP Introduction](#)
- [LLDP Overview](#)
- [LLDP Configuration Procedures](#)
- [LLDP Configuration Commands](#)

### 11.2.1 LLDP Introduction

Link Layer Discovery Protocol (LLDP) lets Ethernet network devices to advertise details about themselves, such as capabilities, identification, and device configurations to directly connected devices on the network that are also using LLDP.

### 11.2.2 LLDP Overview

LLDP is a discovery protocol that allows devices to advertise information about themselves to peer devices that are on the same physical LAN and store information about the network. LLDP allows a device to learn higher layer management reachability and connection endpoint information from adjacent devices.

Each switch with an active LLDP agent sends and receives messages on all physical interfaces enabled for LLDP transmission. These messages are sent periodically and are typically configured for short time intervals to ensure that accurate information is always available. These messages are then stored for a configurable period of time, and contained within the received packet. The message information expires and is discarded when the configured value is met. The only other time an advertisement is sent is when a relevant change takes place in the switch. If information changes for any reason, the LLDP agent is notified and will send out and update the new values.

#### 11.2.2.1 LLDP Data Units

A single LLDP Data Unit (LLDPDU) is transmitted in a single 802.3 Ethernet frame. The basic LLDPDU includes a header and a series of type-length-value elements (TLVs). Each TLV advertises different types of information, such as its device ID, type, or management addresses.

LLDP advertises the following TLVs by default:

- port-description
- system-capabilities
- system-description
- system-name
- management-address
- port-vlan

#### 11.2.2.2 Transmission and Reception

Every device that uses LLDP has its own LLDP agent. The LLDP agent is responsible for the reception, transmission, and management of LLDP. When LLDP is enabled on a port, transmission and reception of LLDPDUs are both enabled by default, but the agent can be configured to only transmit or only receive.

## Transmission

When LLDP transmission is enabled, the LLDP agent advertises information about the switch to neighbors at regular intervals. Each transmitted LLDPDU contains the mandatory TLVs, and any enabled optional TLVs.

## Reception

When LLDP reception is enabled, the LLDP agent receives and stores advertised information from neighboring devices.

### 11.2.2.3 Storing LLDP Information

Whenever the switch receives a valid and current LLDP advertisement from a neighbor, it stores the information in a Simple Network Management Protocol (SNMP) Management Information Base (MIB).

### 11.2.2.4 Guidelines and Limitations

LLDP has the following configuration limitations:

- LLDP must be enabled globally before it can be enabled on an interface.
- LLDP is not supported on virtual interfaces.
- LLDP can discover only one device per port.

## 11.2.3 LLDP Configuration Procedures

These sections describe the following configuration processes:

- [Enabling LLDP Globally](#)
- [Enabling LLDP on an Interface](#)
- [Optional LLDP Parameters](#)
- [Clearing LLDP Statistics](#)
- [Displaying LLDP Information](#)

### 11.2.3.1 Enabling LLDP Globally

The `lldp run` command globally enables LLDP on the Arista switch. Once LLDP is enabled, the switch will transmit advertisements from the ports that are configured to send TLVs. The neighbor information table is populated as advertisements from the neighbors arrive on the ports.

#### Example

This command enables LLDP globally on the Arista switch.

```
switch(config) #lldp run
switch(config) #
```

### 11.2.3.2 Enabling LLDP on an Interface

When enabling LLDP, it is enabled on all interfaces by default. By using the `lldp transmit` and `lldp receive` commands, LLDP can be enabled or disabled on individual interfaces or configured to only send or only receive LLDP packets.

## Examples

- These commands enable *Ethernet port 3/1* to transmit LLDP packets.

```
switch(config)#interface ethernet 3/1
switch(config-if-Et3/1)#lldp transmit
switch(config-if-Et3/1)#
```

- These commands enable *Ethernet port 3/1* to receive LLDP packets.

```
switch(config)#interface ethernet 3/1
switch(config-if-Et3/1)#lldp receive
switch(config-if-Et3/1)#
```

### 11.2.3.3 Optional LLDP Parameters

The following sections describe these tasks:

- [Setting the LLDP Timer](#)
- [Setting the LLDP Hold Time](#)
- [Setting the LLDP Re-initialization Timer](#)
- [Setting the IP Management Address to be used in the TLV](#)
- [Selecting the LLDP TLVs](#)
- [Configuring LLDP for Power over Ethernet](#)

#### 11.2.3.3.1 Setting the LLDP Timer

The `lldp timer` command specifies the time in seconds between LLDP updates sent by the switch.

## Examples

- This command specifies that the LLDP updates should be sent every **120** seconds.

```
switch(config)#lldp timer 120
switch(config)#
```

- This command reverts the LLDP timer to its default value of **30** seconds.

```
switch(config)#no lldp timer 120
switch(config)#
```

#### 11.2.3.3.2 Setting the LLDP Hold Time

The `lldp hold-time` command sets the amount of time a receiving device should retain the information sent by the device.

## Examples

- This command specifies that the receiving device should retain the information for **180** seconds before discarding it.

```
switch(config)#lldp hold-time 180
switch(config)#
```

- This command reverts the LLDP hold time and to the default value of **120** seconds.

```
switch(config)#no lldp hold-time 180
switch(config)#
```



### 11.2.3.3.3 Setting the LLDP Re-initialization Timer

The `lldp run` command specifies the amount in time in seconds to delay the re-initialization attempt by the switch.

#### Example

This command specifies that the switch waits **10** seconds before attempting to re-initialize.

```
switch(config)#lldp timer reinitialization 10
switch(config)#
```

### 11.2.3.3.4 Setting the IP Management Address to be used in the TLV

The `lldp management-address` command specifies the IP management address or the IP address of the VRF interface in LLDP type-length-value (TLV) triplets.

#### Example

- This command specifies the IP management address to be used in the TLV.

```
switch(config)# lldp management-address ethernet 3/1
switch(config)#
```

### 11.2.3.3.5 Selecting the LLDP TLVs

The `lldp tlv transmit` command specifies which type, length, and value elements (TLVs) are to be included in LLDP packets. The `no lldp tlv transmit` command removes the TLV configuration.

#### Example

This command enables the system descriptions to be included in the TLVs.

```
switch(config)#lldp tlv transmit system-description
switch(config)#
```

### 11.2.3.3.6 Configuring LLDP for Power over Ethernet

Initial power over Ethernet (PoE) power-level negotiation with a powered device (PD) takes place in hardware (see [Configuring Power over Ethernet \(PoE\)](#)). Once hardware negotiation has taken place, IEEE 802.3at Power Via MDI type-length-value elements (TLVs) are included by default in LLDP packets sent to connected PDs to allow LLDP to further negotiate power needs. LLDP allows the switch to deal with more granular power requests from PDs, and also allows dynamic power-level setting. TLVs received from connected power-sourcing equipment (PSE) are ignored.

 **Note:** Power Via MDI TLVs are not sent (even when enabled) under the following circumstances: 1) there is a user-configured power limit on the port, or 2) hardware negotiation sets the power to higher than class 4 because **IEEE 802.3bt**, which increases the maximum power output for PoE, is not yet supported by LLDP.

To disable Power Via MDI TLVs globally, use the `no lldp tlv transmit` command and specify the Power Via MDI TLV. Hardware negotiation and manual power limits will remain in effect.

#### Example

This command disables the sending of Power Via MDI TLVs globally.

```
switch(config)#no lldp tlv transmit power-via-mdi
```

```
switch(config)#
```

To disable Power Via MDI TLVs on an individual interface, use the [poeg negotiation lldp disabled](#) command. Hardware negotiation and manual power limits will remain in effect.

### Example

These commands disable the sending of Power Via MDI TLVs on *interface Ethernet 5*.

```
switch(config)#interface ethernet 5
switch(config-if-Et5)#poeg negotiation lldp disabled
switch(config-if-Et5)#
```

### New LLDP Fields Defined by IEEE 802.3at-2009

Arista switches *do not* support the following new LLDP/SNMP fields defined in IEEE standard 802.3at-2009:

- **Power type** a LldpXdot3RemPowerType
- **Power source** a LldpXdot3RemPowerSource
- **Power priority** a LldpXdot3RemPowerPriority
- **PD requested power value** a LldpXdot3RemPDRequestedPowerValue
- **PSE allocated power value** a LldpXdot3RemPSEAllocatedPowerValue

#### 11.2.3.4 Clearing LLDP Statistics

- [clear lldp counters](#)
- [clear lldp table](#)

#### 11.2.3.5 Displaying LLDP Information

- [Viewing LLDP Global Information](#)
- [Viewing LLDP Local Information](#)
- [Viewing LLDP Neighbors](#)
- [Viewing LLDP Traffic](#)

##### 11.2.3.5.1 Viewing LLDP Global Information

The [show lldp](#) command displays LLDP information.

### Examples

- This command displays global information about LLDP.

```
switch#show lldp
LLDP transmit interval : 60 seconds
LLDP transmit holdtime : 120 seconds
LLDP reinitialization delay : 2 seconds
LLDP Management Address VRF : default
Enabled optional TLVs:
 Port Description
 System Name
 System Description
 System Capabilities
 Management Address (Management0)
 IEEE802.1 Port VLAN ID
 IEEE802.3 Link Aggregation
 IEEE802.3 Maximum Frame Size
```

```

Port Tx Enabled Rx Enabled
Et3/1 Yes Yes

switch#

```

- This command displays LLDP information.

```

switch#show lldp ethernet interface 3/1
LLDP transmit interval : 30 seconds
LLDP transmit holdtime : 120 seconds
LLDP reinitialization delay : 2 seconds
LLDP Management Address VRF : default
Enabled optional TLVs:
 Port Description
 System Name
 System Description
 System Capabilities
switch#

```

### 11.2.3.5.2 Viewing LLDP Local Information

The `show lldp local-info` command displays the information contained in the LLDP TLVs to be sent about the local system.

#### Example

This command displays information contained in the TLVS about the local systems.

```

switch#show lldp local-info management 1
Local System:
- Chassis ID type: MAC address (4)
 Chassis ID : 001c.730f.11a8
- System Name: "switch.aristanetworks.com"
- System Description: "Arista Networks EOS version 4.13.2F running on
an Arista
Networks DCS-7150S-64-CL"
- System Capabilities : Bridge, Router
 Enabled Capabilities: Bridge

Interface Management1:
- Port ID type: Interface name (5)
 Port ID : "Management1"
- Port Description: ""
- Management Address Subtype: IPv4 (1)
 Management Address : 172.22.30.154
 Interface Number Subtype : ifIndex (2)
 Interface Number : 999001
 OID String :
- IEEE802.1 Port VLAN ID: 0
- IEEE802.1/IEEE802.3 Link Aggregation
 Link Aggregation Status: Not Capable (0x00)
 Port ID : 0
- IEEE802.3 Maximum Frame Size: 1518 bytes
switch(config)#

```

### 11.2.3.5.3 Viewing LLDP Neighbors

The `show lldp neighbors` command displays information about LLDP neighbors.

## Examples

- This command shows information about LLDP neighbors.

```
switch#show lldp neighbor
Last table change time : 0:12:33 ago
Number of table inserts : 33
Number of table deletes : 0
Number of table drops : 0
Number of table age-outs : 0

Port Neighbor Device ID Neighbor Port ID TTL
Et3/1 tg104.sjc.aristanetworks.com Ethernet3/2 120

Ma1/1 dc1-rack11-tor1.sjc 1/1 120
switch#
```

- This command displays detailed information about the neighbor **Ethernet 3/1**.

```
switch# show lldp neighbor ethernet 3/1
Last table change time : 0:16:24 ago
Number of table inserts : 33
Number of table deletes : 0
Number of table drops : 0
Number of table age-outs : 0

Port Neighbor Device ID Neighbor Port ID TTL
Et3/1 tg104.sjc.aristanetworks.com Ethernet3/2 120
switch#
```

### 11.2.3.5.4 Viewing LLDP Traffic

The [show lldp counters](#) command displays the LLDP traffic information for the switch.

#### Example

This command displays the LLDP counters on the switch.

```
switch#show lldp counters
Port Tx Frames Tx Length Exceeded
Et20 69485 0
Et21 69394 0
Et22 69203 0
Et23 57546 0
Et24 0 0
Ma1 69665 0

Port Rx Frames Rx Errors Rx Discard TLVs Discard TLVs Unknown
Et20 69470 0 0 0 0
Et21 69383 0 0 0 0
Et22 69143 0 0 0 0
Et23 55370 0 0 0 0
Et24 0 0 0 0 0
Ma1 69078 69078 0 69078 0
switch#
```

## 11.2.4 LLDP Configuration Commands

### Global Configuration Commands

- `lldp hold-time`
- `lldp management-address`
- `lldp management-address vrf`
- `lldp run`
- `lldp receive packet tagged drop`
- `lldp timer`
- `lldp timer reinitialization`
- `lldp tlv transmit`

### Interface Configuration Commands – Ethernet Interface

- `lldp receive`
- `lldp transmit`
- `poe negotiation lldp disabled`

### Privileged EXEC Commands

- `clear lldp counters`
- `clear lldp table`

### EXEC Commands

- `show lldp`
- `show lldp counters`
- `show lldp local-info`
- `show lldp neighbors`

---

### 11.2.4.1 clear lldp counters

The `clear lldp counters` command resets the LLDP counters to zero.

#### Command Mode

Privileged EXEC

#### Command Syntax

```
clear lldp counters [SCOPE]
```

#### Parameters

- **SCOPE** Session affected by command. Options include:
  - **no parameter** command affects counters on all CLI sessions.
  - **session** clears LLDP counters for the current CLI session only.

#### Examples

- This command resets all the LLDP counters to zero.

```
switch(config)#clear lldp counters
switch(config)#
```

- This command resets only the LLDP counters for the current CLI session.

```
switch(config)#clear lldp counters session
switch(config)#
```

### 11.2.4.2 clear lldp table

The `clear lldp table` command clears neighbor information from the LLDP table.

#### Command Mode

Privileged EXEC

#### Command Syntax

```
clear lldp table
```

#### Example

This command clears neighbor information from the LLDP table.

```
switch(config)#clear lldp table
switch(config)#
```

---

### 11.2.4.3 lldp hold-time

The `lldp hold-time` command specifies the amount of time a receiving device should maintain the information sent by the device before discarding it.

#### Command Mode

Global Configuration

#### Command Syntax

```
lldp hold-time period
no lldp hold-time
default lldp hold-time
```

#### Parameters

***period*** The amount of time a receiving device should hold LLDPDU information before discarding it. Value ranges from 10 to 65535 second; default value is 120 seconds.

#### Examples

- This command sets the amount of time before the receiving device discards LLDPDU information to **180** seconds.

```
switch(config)#lldp hold-time 180
switch(config)#
```

- This command restores the hold-time to its default value of **120** seconds.

```
switch(config)#no lldp hold-time 180
switch(config)#
```



#### 11.2.4.4 lldp management-address vrf

The `lldp management-address vrf` command enables the user to add the IP address of the VRF interface used in LLDP type-length-value (TLV).

##### Command Mode

Global Configuration

##### Command Syntax

```
lldp management-address vrf VRF_INSTANCE
no lldp management-address vrf VRF_INSTANCE
default lldp management-address vrf VRF_INSTANCE
```

##### Parameters

**VRF\_INSTANCE** specifies the VRF instance.

##### Examples

- This command specifies the management address VRF to be used in the TLV.

```
switch(config)#lldp management-address vrf test 1
switch(config)#
```

- This command removes the management VRF used in the TLV.

```
switch(config)#no lldp management-address vrf test 1
switch(config)#
```

---

### 11.2.4.5 lldp management-address

The `lldp management-address` command enables the user to add the IP management address used for LLDP type-length-value (TLV).

#### Command Mode

Global Configuration

#### Command Syntax

```
lldp management-address [INTERFACE]
no lldp management-address [INTERFACE]
default lldp management-address [INTERFACE]
```

#### Parameters

- **INTERFACE** Interface type and number. Options include:
  - **all** all interfaces.
  - **ethernet e\_num** Ethernet interface specified by **e\_num**.
  - **loopback l\_num** Loopback interface specified by **l\_num**.
  - **management m\_num** Management interface specified by **m\_num**.
  - **port-channel p\_num** Port-Channel Interface specified by **p\_num**.
  - **vlan v\_num** VLAN interface specified by **v\_num**.

#### Examples

- This command specifies the IP management address to be used in the TLV.

```
switch(config)#lldp management-address ethernet 3/1
switch(config)#
```

- This command removes the IP management address used in the TLV.

```
switch(config)#no lldp management-address ethernet 3/1
switch(config)#
```

- This command specifies that **VLAN 200** is used in the TLV.

```
switch(config)#lldp management-address vlan 200
switch(config)#
```

- This command removes the VLAN ID used in the TLV.

```
switch(config)#no lldp management-address vlan 200
switch(config)#
```

### 11.2.4.6 lldp receive

The **lldp receive** command enables LLDP packets on an interface. The **no lldp receive** command disables the acceptance of LLDP packets.

#### Command Mode

Interface-Ethernet configuration

Interface-Management configuration

#### Command Syntax

```
lldp receive
```

```
no lldp receive
```

```
default lldp receive
```

#### Examples

- These commands enable the reception of LLDP packets on **interface Ethernet 4/1**.

```
switch(config)#interface ethernet 4/1
switch(config-if-Et4/1)#lldp receive
switch(config-if-Et4/1)#
```

- These commands disable LLDP the reception of LLDP packets on **interface Ethernet 4/1**.

```
switch(config)#interface ethernet 4/1
switch(config-if-Et4/1)#no lldp receive
switch(config-if-Et4/1)#
```

---

#### 11.2.4.7 lldp receive packet tagged drop

The `lldp receive packet tagged drop` command is a global configuration command and when configured the LLDP ignores all the packets with **VLAN-tag**. By default this command is disabled.

##### Command Mode

Global Configuration

##### Command Syntax

```
lldp receive packet tagged drop
```

##### Example

This command when configured, the LLDP ignores all the packets with **VLAN-tag**.

```
switch(config)#lldp receive packet tagged drop
```

### 11.2.4.8 lldp run

The `lldp run` command enables LLDP on the Arista switch.

#### Command Mode

Global Configuration

#### Command Syntax

```
lldp run
no lldp run
default lldp run
```

#### Examples

- This command enables LLDP globally on the Arista switch.

```
switch(config)#lldp run
switch(config)#
```

- This command disables LLDP globally on the Arista switch.

```
switch(config)#no lldp run
switch(config)#
```

---

### 11.2.4.9 lldp timer reinitialization

The `lldp timer reinitialization` command sets the time delay in seconds for LLDP to initialize.

#### Command Mode

Global Configuration

#### Command Syntax

```
lldp timer reinitialization delay
no lldp timer reinitialization
default lldp timer reinitialization
```

#### Parameters

*delay* the amount of time the device should wait before re-initialization is attempted. Value ranges from 1 to 20 seconds; default value is 2 seconds.

#### Examples

- This command specifies that the switch should wait **10** seconds before attempting to re-initialize.

```
switch(config)#lldp timer reinitialization 10
switch(config)#
```

- This command restores the default initialization delay of **2** seconds.

```
switch(config)#no lldp timer reinitialization 10
switch(config)#
```

### 11.2.4.10 lldp timer

The **lldp timer** command specifies the amount of time a receiving device should maintain the information sent by the device before discarding it. The **no lldp timer** command removes the configured LLDP timer.

#### Command Mode

Global Configuration

#### Command Syntax

```
lldp timer transmission_time
```

```
no lldp timer
```

```
default lldp timer
```

#### Parameters

***transmission\_time*** the period of time at which LLDPDUs are transmitted. Values range from 5 to 32768 seconds; the default is 30 seconds.

#### Examples

- This command configures a period of 80 seconds at which the LLDPDUs are transmitted.

```
switch(config)#lldp timer 180
switch(config)#
```

- This command removes the configured period of time at which the LLDPDUs are transmitted.

```
switch(config)#no lldp timer 180
switch(config)#
```

---

### 11.2.4.11 lldp tlv transmit

The `lldp tlv transmit` command allows the user to specify the type-length-values (TLVs) to include in LLDP packets.

#### Command Mode

Global Configuration

#### Command Syntax

```
lldp tlv transmit TLV_NAME
no lldp tlv transmit TLV_NAME
default lldp tlv transmit TLV_NAME
```

#### Parameters

- TLV\_NAME Options include:
  - **link-aggregation** specifies the link aggregation TLV.
  - **management-address** specifies the management address TLV.
  - **max-frame-size** specifies the Frame size TLV.
  - **port-description** specifies the port description TLV.
  - **port-vlan** specifies the port VLAN ID TLV.
  - **power-via-mdi** specifies the power over Ethernet TLV.
  - **system-capabilities** specifies the system capabilities TLV.
  - **system-description** specifies the system description TLV.
  - **system-name** specifies the system name TLV.

#### Examples

- This command enables the system description TLV:

```
switch(config)#lldp tlv transmit system-description
switch(config)#
```

- This command disables the system description TLV:

```
switch(config)#no lldp tlv transmit system-description
switch(config)#
```

- This command enables the max-frame-size TLV:

```
switch(config)#lldp tlv transmit max-frame-size
switch(config)#
```

- This command disables the max-frame-size TLV:

```
switch(config)#no lldp tlv transmit max-frame-size
switch(config)#
```



### 11.2.4.12 lldp transmit

The `lldp transmit` command enables the transit of LLDP packets on an interface.

#### Command Mode

Interface-Ethernet configuration

Interface-Management configuration

#### Command Syntax

```
lldp transmit
```

```
no lldp transmit
```

```
default lldp transmit
```

#### Examples

- These commands enable the transmission of LLDP packets

```
switch(config)#interface ethernet 4/1
switch(config-if-Et4/1)#lldp transmit
switch(config-if-Et4/1)#
```

- These commands disable the transmission of LLDP packets.

```
switch(config)#interface ethernet 4/1
switch(config-if-Et4/1)#no lldp transmit
switch(config-if-Et4/1)#
```

---

### 11.2.4.13 poe negotiation lldp disabled

Power Via MDI TLVs are included by default in LLDP packets sent to power over Ethernet (PoE) powered devices (PDs) to allow dynamic negotiation of power levels. The **poe negotiation lldp disabled** command disables the sending of Power Via MDI TLVs from the configuration-mode interface.

The **no poe negotiation lldp disabled** and **default poe negotiation lldp disabled** commands restore the default behavior (sending Power Via MDI TLVs) by removing the corresponding **poe negotiation lldp disabled** command from *running-config*.

To disable Power Via MDI TLVs globally, use the [no lldp tlv transmit](#) command and specify the Power Via MDI TLV.

#### Command Mode

Interface-Ethernet configuration

#### Command Syntax

```
poe negotiation lldp disabled
no poe negotiation lldp disabled
default poe negotiation lldp disabled
```

#### Example

These commands disable the sending of Power Via MDI TLVs on *interface Ethernet 5*.

```
switch(config)#interface ethernet 5
switch(config-if-Et5)#poe negotiation lldp disabled
switch(config-if-Et5)#
```

### 11.2.4.14 show lldp counters

The `show lldp counters` command displays LLDP traffic information for the switch.

#### Command Mode

EXEC

#### Command Syntax

```
show lldp counters [INTERFACE]
```

#### Parameters

- **INTERFACE** Interface type and numbers. Options include:
  - **no parameter** Display information for all interfaces.
  - **ethernet e\_range** Ethernet interface range specified by **e\_range**.
  - **management m\_range** Management interface range specified by **m\_range**.

Valid **e\_range** and **m\_range** formats include number, number range, or comma-delimited list of numbers and ranges.

#### Example

This command displays the LLDP counters on the switch.

```
switch#show lldp counters
```

| Port | Tx Frames | Tx Length Exceeded |
|------|-----------|--------------------|
| Et20 | 69485     | 0                  |
| Et21 | 69394     | 0                  |
| Et22 | 69203     | 0                  |
| Et23 | 57546     | 0                  |
| Et24 | 0         | 0                  |
| Ma1  | 69665     | 0                  |

| Port | Rx Frames | Rx Errors | Rx Discard | TLVs Discard | TLVs Unknown |
|------|-----------|-----------|------------|--------------|--------------|
| Et20 | 69470     | 0         | 0          | 0            | 0            |
| Et21 | 69383     | 0         | 0          | 0            | 0            |
| Et22 | 69143     | 0         | 0          | 0            | 0            |
| Et23 | 55370     | 0         | 0          | 0            | 0            |
| Et24 | 0         | 0         | 0          | 0            | 0            |
| Ma1  | 69078     | 69078     | 0          | 69078        | 0            |

### 11.2.4.15 show lldp local-info

The `show lldp local-info` command displays LLDP errors and overflows.

#### Command Mode

EXEC

#### Command Syntax

```
show lldp local-info [INTERFACE]
```

#### Parameters

- **INTERFACE** Interface type and numbers. Options include:
  - **no parameter** Display information for all interfaces.
  - **ethernet e\_range** Ethernet interface range specified by **e\_range**.
  - **management m\_range** Management interface range specified by **m\_range**.

Valid **e\_range** and **m\_range** formats include number, number range, or comma-delimited list of numbers and ranges.

#### Example

This command displays the specific LLDP errors and overflows on **management interface 1**.

```
switch#show lldp local-info management 1
Local System:
- Chassis ID type: MAC address (4)
 Chassis ID : 001c.730f.11a8qqq
- System Name: "switch.aristanetworks.com"
- System Description: "Arista Networks EOS version 4.13.2F running on
an Arista
Networks DCS-7150S-64-CL"
- System Capabilities : Bridge, Router
 Enabled Capabilities: Bridge

Interface Management1:
- Port ID type: Interface name (5)
 Port ID : "Management1"
- Port Description: ""
- Management Address Subtype: IPv4 (1)
 Management Address : 172.22.30.154
 Interface Number Subtype : ifIndex (2)
 Interface Number : 999001
 OID String :
- IEEE802.1 Port VLAN ID: 0
- IEEE802.1/IEEE802.3 Link Aggregation
 Link Aggregation Status: Not Capable (0x00)
 Port ID : 0
- IEEE802.3 Maximum Frame Size: 1518 bytes
se505.16:01:44#
switch#
```

### 11.2.4.16 show lldp neighbors

The `show lldp neighbors` command displays information about the switch's LLDP neighbors.

#### Command Mode

EXEC

#### Command Syntax

```
show lldp neighbors [INTERFACE][INFO_LEVEL]
```

#### Parameters

- **INTERFACE** Interface type and numbers. Options include:
  - *no parameter* displays information for all interfaces.
  - **ethernet e\_range** Ethernet interface range specified by *e\_range*.
  - **management m\_range** Management interface range specified by *m\_range*.

Valid *e\_range* and *m\_range* formats include number, number range, or comma-delimited list of numbers and ranges.

- **INFO\_LEVEL** amount of information that is displayed. Options include:
  - *no parameter* Displays information for all interfaces.
  - **detailed** LLDP information for all the adjacent LLDP devices.

#### Examples

- This command displays the neighbor's information about LLDP.

```
switch(config)#show lldp neighbors
Last table change time : 0:12:33 ago
Number of table inserts : 33
Number of table deletes : 0
Number of table drops : 0
Number of table age-outs : 0

Port Neighbor Device ID Neighbor Port ID TTL
Et3/1 tg104.sjc.aristanetworks.com Ethernet3/2 120

Ma1/1 dc1-rack11-tor1.sjc 1/1 120
switch#
```

- This command displays LLDP neighbor information for *interface Ethernet 3/1*.

```
switch#show lldp neighbors ethernet 3/1
Last table change time : 0:16:24 ago
Number of table inserts : 33
Number of table deletes : 0
Number of table drops : 0
Number of table age-outs : 0

Port Neighbor Device ID Neighbor Port ID TTL
Et3/1 tg104.sjc.aristanetworks.com Ethernet3/2 120
switch#
```

- This command displays detailed LLDP neighbor information for *interface Ethernet 3/1*.

```
switch# show lldp neighbors 3/1 detail

Interface Ethernet 3/1 detected 1 LLDP neighbors:

Neighbor 001c.7300.1506/Ethernet6/25, age 8 seconds
Discovered 5 days, 3:58:58 ago; Last changed 5 days, 3:56:57 ago
```

---

```
- Chassis ID type: MAC address (4)
 Chassis ID : 001c.7300.1506
- Port ID type: Interface name (5)
 Port ID : "Ethernet6/25"
- Time To Live: 120 seconds
- Port Description: "Ethernet6/25"
- IEEE802.3 Power Via MDI
 Port Class : PD
 PSE MDI Power Support : Not Supported
 PSE MDI Power State : Disabled
- System Name: "Leaf-Switch1.aristanetworks.com"
- System Description: "Arista Networks EOS version 4.10.1-SSO
running on an Arista Networks DCS-7504"
- System Capabilities : Bridge, Router
 Enabled Capabilities: Bridge
- Management Address Subtype: IPv4 (1)
 Management Address : 172.22.30.116
 Interface Number Subtype : ifIndex (2)
 Interface Number : 999999
 OID String :
- IEEE802.1 Port VLAN ID: 1
- IEEE802.1/IEEE802.3 Link Aggregation
 Link Aggregation Status: Capable, Disabled (0x01)
 Port ID : 0
- IEEE802.3 Maximum Frame Size: 9236 bytes
switch#
```

### 11.2.4.17 show lldp

The **show lldp** command displays LLDP information.

#### Command Mode

EXEC

#### Command Syntax

```
show lldp [INTERFACE]
```

#### Parameters

- **INTERFACE** Interface type and numbers. Options include:
  - **no parameter** Display information for all interfaces.
  - **ethernet e\_range** Ethernet interface range specified by **e\_range**.
  - **management m\_range** Management interface range specified by **m\_range**.

Valid **e\_range** and **m\_range** formats include number, number range, or comma-delimited list of numbers and ranges.

#### Examples

- This command displays all LLDP information.

```
switch#show lldp
LLDP transmit interval : 60 seconds
LLDP transmit holdtime : 120 seconds
LLDP reinitialization delay : 2 seconds
LLDP Management Address VRF : test

Enabled optional TLVs:
 Port Description
 System Name
 System Description
 System Capabilities
 Management Address (Management0)
 IEEE802.1 Port VLAN ID
 IEEE802.3 Link Aggregation
 IEEE802.3 Maximum Frame Size

Port Tx Enabled Rx Enabled
Et3/1 Yes Yes

switch#
```

- This command displays specific information about LLDP for **interface Ethernet 3/1**.

```
switch#show lldp ethernet 3/1
LLDP transmit interval : 30 seconds
LLDP transmit holdtime : 120 seconds
LLDP reinitialization delay : 2 seconds
LLDP Management Address VRF : default

Enabled optional TLVs:
 Port Description
 System Name
 System Description
 System Capabilities

switch#
```

- This command displays specific information about LLDP for **management interface 1/1**.

```
switch#show lldp management 1/1
```

---

```
LLDP transmit interval : 60 seconds
LLDP transmit holdtime : 120 seconds
LLDP reinitialization delay : 2 seconds
LLDP Management Address VRF : default
```

```
Enabled optional TLVs:
```

```
 Port Description
 System Name
 System Description
 System Capabilities
 Management Address (Management0)
 IEEE802.1 Port VLAN ID
 IEEE802.3 Link Aggregation
 IEEE802.3 Maximum Frame Size
```

```
Port Tx Enabled Rx Enabled
Ma1/1 Yes Yes
switch#
```



## 11.3 Virtual LANs (VLANs)

This chapter describes Arista's Virtual LANs (VLANs) implementation and MAC address tables.

Sections in this chapter include:

- [VLAN Introduction](#)
- [VLAN Conceptual Overview](#)
- [VLAN Configuration Procedures](#)
- [VLAN Configuration Commands](#)

### 11.3.1 VLAN Introduction

Arista switches support industry standard 802.1q VLANs. Arista EOS provides tools to manage and extend VLANs throughout the data center network.

### 11.3.2 VLAN Conceptual Overview

#### 11.3.2.1 VLAN Definition

A virtual local area network (VLAN) allows a group of devices to communicate as if they were in the same network regardless of their physical location. VLANs are Layer 2 structures based on the 802.1Q standard.

These parameters are associated with a VLAN:

- VLAN number (1-4094): VLAN numbers uniquely identify the VLAN within a network. VLAN 1 exists by default; all other VLANs only exist after they are configured.
- VLAN name (optional): The VLAN name is a text string that describes the VLAN.
- VLAN state (**active** or **suspended**): The state specifies the VLAN transmission status within the switch. In the **suspended** state, VLAN traffic is blocked on all switch ports. The default state is **active**.

VLANs define Layer 2 broadcast domains in a Layer 2 network, in which each device can receive broadcast frames sent by any other within the domain. Switches accommodating multiple broadcast domains serve as multi-port bridges where each broadcast domain is a distinct virtual bridge. Traffic does not pass directly between different VLANs within a switch or between two switches.

#### 11.3.2.2 VLAN Switching

Ethernet and port channel interfaces are configured as switched ports by default. Switched ports are configurable as members of one or more VLANs. Switched ports ignore all IP-level configuration commands, including IP address assignments.

##### 11.3.2.2.1 VLAN Trunking and Trunk Groups

Trunking extends multiple VLANs beyond the switch through a common interface or port channel.

A trunk group is the set of physical interfaces that comprise the trunk and the collection of VLANs whose traffic is carried on the trunk. The traffic of a VLAN that belongs to one or more trunk groups is carried only on ports that are members of trunk groups to which the VLAN belongs, i.e., VLANs configured in a trunk group are pruned of all ports that are not associated with the trunk group. See the Trunk Ports example section for further details.

 **Note:** Be cautious when using allowed VLAN lists or trunk groups to ensure that the VLAN topology is consistent with any Layer-2 control protocol topology, or unpredictable results can occur.

---

VLAN traffic is carried through Ethernet or LAG ports. A port's switchport mode defines the number of VLANs for which the port can carry traffic.

- Access ports carry traffic for one VLAN – the access VLAN. Access ports associate untagged frames with the access VLAN. Access ports drop tagged frames that are not tagged with the access VLAN.
- Trunk ports carry traffic for multiple VLANs. Tag frames specify the VLAN for which trunk ports process packets.

#### 11.3.2.2.2 Q-in-Q Trunking

A Q-in-Q network is a multi-tier layer 2 VLAN network. A typical Q-in-Q network is composed of a service provider network (tier 1) where each node connects to a customer network (tier 2).

802.1ad is a networking standard that supports Q-in-Q networks by allowing multiple 802.1Q tags in an Ethernet frame.

Each interface in a customer network is assigned to a customer-VLAN (c-VLAN). Packets in c-VLANs contain 802.1q tags that switch traffic within the network. c-VLANs access the service provider VLAN (s-VLAN) through a provider switch. Customer switch ports connect to an s-VLAN through provider switch edge ports, which are configured as dot1q ports and operate as follows:

- **Inbound traffic (from customer switches):** adds an s-VLAN tag, then forwards packets to the provider network.
- **Outbound traffic (to customer switches):** removes the s-VLAN tag, then forwards packets to the customer network.

#### 11.3.2.2.3 TPID (Configurable Ethertypes)

By default, VLAN-tagged packets carry a tag protocol identifier (TPID) of 0x8100. On some Arista platforms, however, the TPID of a switchport can be modified in accordance with IEEE 802.1ad to allow for the use of 802.1q TPIDs other than 0x8100. Well known and standard tags include:

- **0x8100** customer VLAN
  - **0x88a8** service VLAN tag used in provider bridging
  - **0x9100** service VLAN tag used in provider bridging (common, but not standardized)

Other non-standard TPID values may also be configured for interoperability with legacy equipment or non-standard systems. Values range from 0x600 (1536) through 0xFFFF (65535).

Non-default TPID values are most commonly used for provider bridging on a network-to-network interface.

#### 11.3.2.3 VLAN Routing

Each VLAN can be associated with a switch virtual interface (SVI), also called a VLAN interface. The VLAN interface functions in a routed network (Layer 3) with an assigned IP subnet address. Connecting different VLANs requires Layer 3 networking.

##### 11.3.2.3.1 VLAN Interfaces

A switched virtual interface (SVI) connects to the VLAN segment on the switch to provide Layer 3 processing for packets from the VLAN. An SVI can be activated only after it is connected to a VLAN. SVIs are typically configured for a VLAN to a default gateway for a subnet to facilitate traffic routing with other subnets.

In a Layer 3 network, each VLAN SVI is associated with an IP subnet, with all stations in the subnet members of the VLAN. Traffic between different VLANs is routed when IP routing is enabled.

### 11.3.2.3.2 Internal VLANs

A routed port is an Ethernet or port channel interface that functions as a Layer 3 interface. Routed ports do not bridge frames nor switch VLAN traffic. Routed ports have IP addresses assigned to them and packets are routed directly to and from the port.

The switch allocates an internal VLAN for an interface when it is configured as a routed port. The internal VLAN is assigned a previously unused VLAN ID. The switch prohibits the subsequent configuration of VLANs and VLAN interfaces with IDs corresponding to allocated internal VLANs.

### 11.3.2.3.3 VLAN Translation

VLAN translation allows you to map packets from one VLAN to another. This can be carried out only on packets having a dot1q header (tagged frames). The translation rewrites the VID field (VLAN ID) in dot1q headers on packets passing through a switched port without changing any other fields.

VLAN translation also supports the ability to translate packets with a dot1q header to the internal VLAN for a routed port. The VLAN in the incoming packets is mapped to the internal VLAN of the routed port and packets egressing the routed port are encapsulated with a dot1q header for the specified VLAN. For egress packets, no priority information is added to the dot1q header and the priority from the incoming encapsulation will be retained.

When configuring the VLAN translation mode, consider the following:

- VLAN translation is only supported for tagged packets.
- BPDUs from STP, LLDP and other protocols are not affected by this mapping.
- VLAN translation is not applicable for access ports.
- Untagged packets entering the switch on the trunk native VLAN are not mapped.
- TPID and VLAN priority does not get re-written during the translation.

## 11.3.3 VLAN Configuration Procedures

These sections describe basic VLAN configuration tasks.

- [Creating and Configuring VLANs](#)
- [Configuring VLAN Switching](#)
- [Creating and Configuring VLAN Interfaces](#)
- [Allocating Internal VLANs](#)
- [Configuring VLAN Translation](#)

### 11.3.3.1 Creating and Configuring VLANs

The CLI provides two methods of creating VLANs.

- Explicitly through the `vlan` command.
- Implicitly through the `switchport access vlan` command.

The `switchport access vlan` command generates a warning message when it creates a VLAN.

To create a VLAN, use the `vlan` command in global configuration mode. Valid VLAN numbers range between 1 and 4094. To create multiple VLANs, specify a range of VLAN numbers.

To edit an existing VLAN, enter the `vlan` command with the number of the existing VLAN.

#### Example

This command creates **VLAN 45** and enters VLAN configuration mode for the new VLAN.

```
switch(config)#vlan 45
switch(config-vlan-45)#
```

---

Use the [name \(VLAN configuration mode\)](#) command to assign a name to a VLAN.

### Example

These commands assign the name Marketing to VLAN 45.

```
switch(config)#vlan 45
switch(config-vlan-45)#name Marketing
switch(config-vlan-45)#show vlan 45
```

| VLAN | Name      | Status | Ports |
|------|-----------|--------|-------|
| 45   | Marketing | active | Et1   |

```
switch(config-vlan-45)#
```

To change a VLAN's state, use the [state](#) command in VLAN configuration mode.

### Examples

- These commands suspend **VLAN 45**. VLAN traffic is blocked on all switch ports.

```
switch(config)#vlan 45
switch(config-vlan-45)#state suspend
switch(config-vlan-45)#show vlan 45
```

| VLAN | Name      | Status    | Ports |
|------|-----------|-----------|-------|
| 45   | Marketing | suspended |       |

```
switch(config-vlan-45)#
```

- These commands activate **VLAN 45**.

```
switch(config)#vlan 45
switch(config-vlan-45)#state active
switch(config-vlan-45)#show vlan 45
```

| VLAN | Name      | Status | Ports |
|------|-----------|--------|-------|
| 45   | Marketing | active | Et1   |

```
switch(config-vlan-45)#
```

#### 11.3.3.1.1 VLAN Policy

The VLAN policy configuration command enables a switch to configure a VLAN policy when it receives a packet with unknown destination MAC address on a VLAN. The [mac address forwarding](#) command provides three options to configure a VLAN policy:

- Flood the Layer 2 miss packets on the VLAN
- Drop the Layer 2 miss packets
- Log the Layer 2 miss packets to the CPU (while still flooding them on the VLAN)

The default behavior is to flood the L2 miss packets on all ports of the VLAN.

VLAN policy configuration is supported on the Arista 7010, 7050 (excluding 7050SX3-48YC12, 7050CX3-32S, 7050QX2-32S, 7050SX2-72Q, 7050SX2-128, 7050TX2-128), 7060, 7250, and the 7300 series platforms.

VLAN policy is not supported in the following cases:

- STP, LLDP, and LACP packets
- VLAN policy configurations on VXLAN-enabled VLAN
- On a VLAN if IGMP snooping is configured with Multicast miss action is set to drop, then all multicast packets received on that VLAN are dropped.

### Examples

- These commands create a **VLAN 333** and then set the unicast policy to 'drop' and the multicast policy to 'log' for the specific **VLAN 333**.

```
switch(config)#vlan 333
switch(config-vlan-333)#mac address forwarding unicast miss action drop
switch(config-vlan-333)#mac address forwarding multicast miss action
log
```

- These commands display the VLAN policy that was defined when VLAN 333 is created.

```
switch(config)#show vlan 333 mac address forwarding
```

| VLAN | UcMissAction | McMissAction |
|------|--------------|--------------|
| 333  | flood        | flood        |

- These commands display the VLAN policy type that was defined when **VLAN 333** is configured with the 'drop' unicast policy and the 'log' multicast policy.

```
switch(config)#show vlan 333 mac address forwarding
```

| VLAN | UcMissAction | McMissAction |
|------|--------------|--------------|
| 333  | drop         | log          |

```
switch(config)#show vlan mac address forwarding
```

| VLAN | UcMissAction | McMissAction |
|------|--------------|--------------|
| 1    | flood        | flood        |
| 333  | drop         | log          |

### 11.3.3.2 Configuring VLAN Switching

The following describe the configuration of VLAN ports.

#### 11.3.3.2.1 Access Ports

Access ports carry traffic for one VLAN, as designated by a `switchport access vlan` command. Access ports associate untagged frames with the access VLAN. Tagged frames received by the interface are dropped unless they are tagged with the access VLAN.

To configure an interface group as an access port, use the `switchport mode` command.

#### Example

These commands configure **interface Ethernet 1** as an access port.

```
switch(config)#interface ethernet 1
switch(config-if-Et1)#switchport mode access
switch(config-if-Et1)#
```

To specify the port's access VLAN, use the `switchport access vlan` command.

## Examples

- These commands configure **VLAN 15** as the access VLAN for **interface Ethernet 5**.

```
switch(config)#interface ethernet 5
switch(config-if-Et5)#switchport access vlan 15
switch(config-if-Et5)#
```

- These commands configure interface Ethernet 1 through 3 as access ports that process untagged frames as **VLAN 5** traffic.

```
switch(config)#interface Ethernet 1-3
switch(config-if-Et1-3)#switchport mode access
switch(config-if-Et1-3)#switchport access vlan 5
switch(config-if-Et1-3)#show interfaces ethernet 1-3 vlans
Port Untagged Tagged
Et1 None 23,25
Et2 18 -
Et3 None 14
switch(config-if-Et1-3)#
```

### 11.3.3.2.2 Trunk Ports

Trunk ports carry traffic for multiple VLANs. Messages use tagged frames to specify the VLAN for which trunk ports process traffic.

- The **vlan trunk list** specifies the VLANs for which the port handles tagged frames. The port drops any packets tagged for VLANs not in the VLAN list.
- The **native vlan** is the VLAN where the port switches untagged frames.

To configure an interface group as a trunk port, use the **switchport mode** command.

#### Example

These commands configure **interface Ethernet 8** as a trunk port.

```
switch(config)#interface ethernet 8
switch(config-if-Et8)#switchport mode trunk
switch(config-if-Et8)#
```

By default all VLANs are permitted on a port configured with 'switchport mode trunk'. To limit the port's VLAN trunk list, use the **switchport trunk allowed vlan** command. Only VLANs in the allowed list will be permitted.

#### Examples

- These commands configure VLAN 15, 20, 21, 22, 40, and 75 as the explicitly permitted VLAN trunk list for Ethernet interface 12-16.

```
switch(config)#interface ethernet 12-16
switch(config-if-Et12-16)#switchport trunk allowed vlan 15,20-22,40,75
switch(config-if-Et12-16)#
```

- These commands explicitly permit VLAN 100 through 120 to the VLAN trunk list for **interface Ethernet 14**.

```
switch(config)#interface ethernet 14
switch(config-if-Et14)#switchport trunk allowed vlan add 100-120
switch(config-if-Et14)#
```

To specify the port's native VLAN, use the `switchport trunk native vlan` command.

### Example

These commands configure VLAN 12 as the native VLAN trunk for *interface Ethernet 10*.

```
switch(config)#interface ethernet 10
switch(config-if-Et10)#switchport trunk native vlan 12
switch(config-if-Et10)#
```

By default, ports send native VLAN traffic with untagged frames. The `switchport trunk native vlan` command can also configure the port to send native VLAN traffic with tag frames.

### Examples

- These commands configure *interface Ethernet 10* to send native VLAN traffic as tagged.

```
switch(config)#interface ethernet 10
switch(config-if-Et10)#switchport trunk native vlan tag
switch(config-if-Et10)#
```

- These commands configure *interface Ethernet 12* as a trunk with *VLAN 15* as the native VLAN. The port's trunk list includes all VLANs except 201-300.

```
switch(config)#interface ethernet 12
switch(config-if-Et12)#switchport mode trunk
switch(config-if-Et12)#switchport trunk native vlan 15
switch(config-if-Et12)#switchport trunk allowed vlan except 201-300
switch(config-if-Et12)#
```

### Example

Assume that all ports on the switch are configured with `switchport mode trunk` similar to Ethernet 1 and 2 shown below:

```
!
interface ethernet 1
 switchport mode trunk
!
interface ethernet 2
 switchport mode trunk
!
```

Further assume that *VLAN 30* is not configured as part of a trunk group

```
switch#show vlan
VLAN Name Status Ports

1 default active Et1, Et2
30 vlan30 active Et1, Et2
```

Now configure *VLAN 30* as part of *trunk group 30*:

```
switch(config)#vlan 30
switch(config-vlan-30)#trunk group 30
```

This updates the VLAN membership for *VLAN 30*.

```
switch#show vlan
```

| VLAN | Name    | Status | Ports    |
|------|---------|--------|----------|
| 1    | default | active | Et1, Et2 |
| 30   | vlan30  | active |          |

**Note:** *Vlan 30* is no longer on Et1, Et2 i.e. it has been 'pruned' due to the trunk group command in the vlan configuration.

To permit **VLAN 30** on **Et1**, you need to associate the interface with the trunk group as follows:

```
switch(config-if-Et1)#switchport trunk group 30
```

Now we see Et1 included in the vlan 30 list

```
switch#show vlan
```

| VLAN | Name    | Status | Ports    |
|------|---------|--------|----------|
| 1    | default | active | Et1, Et2 |
| 30   | vlan30  | active | Et1      |

The trunk group command is not additive to the allowed VLAN command

```
interface ethernet 1
 switchport mode trunk
 switchport trunk allowed vlan 10
 switchport trunk group trunk30
```

Vlan 30 will not be permitted on the interface as it is not listed in the allowed vlan list.

### 11.3.3.2.3 Dot1q Tunnel Ports

**Dot1q (802.1Q)** is a tunneling protocol that encapsulates traffic from multiple customer (c-tag) VLANs in an additional single outer service provider (s-tag) VLAN for transit across a larger network structure that includes traffic from all customers. Tunneling eliminates the service provider requirement that every VLAN be configured from multiple customers, avoiding overlapping address space issues.

Tunneling preserves the inner VLANs through the tunneled network; these inner VLANs are ignored by intermediate devices that make forwarding decisions based only on the outermost VLAN tag (S-Tag)

A dot1q-tunnel port sits at the edge of the tunneled network. Unlike regular access ports, a dot1q-tunnel port does not drop traffic that arrives with **802.1Q** tags in place; it ignores existing 802.1Q information and associates arriving traffic (with or without **802.1Q** headers) with a new tunnel VLAN ID.

Packets arriving at a tunnel port are encapsulated with an additional **802.1Q** tag that can be trunked between multiple devices like any traditional VLAN. When exiting a dot1-tunnel port, the S-Tag is removed to revert the customer traffic to its original tagged or untagged state.

To configure an interface group as a dot1q tunnel port, use the **switchport mode** command.

#### Example

- These commands configure **interface Ethernet 12** as a dot1q tunnel port.

```
switch(config)# interface ethernet 12
switch(config-if-Et12)# switchport mode dot1q-tunnel
switch(config-if-Et12)#
```

To specify the dot1q-tunnel port's access VLAN, use the **switchport access vlan** command. The port then handles all inbound traffic as untagged VLAN traffic.



**Example**

- These commands configure **VLAN 60** as the access VLAN for **interface Ethernet 12**.

```
switch(config)#interface ethernet 12
switch(config-if-Et12)#switchport access vlan 60
switch(config-if-Et12)#
```

**11.3.3.2.4 TPID Configuration**

The default tag protocol identifier (TPID, also called dot1q ethertype) on all switch ports is 0x8100. To configure a different TPID on a port, use the [switchport dot1q ethertype](#) command. This feature is available only on 7280E and 7500E platforms.

 **Note:** If dot1q tunneling is enabled on the interface, a TPID configured on the interface becomes irrelevant.

**Example**

In this provider bridging example, **interface Ethernet 1** is the user network interface and **interface Ethernet 2** is the network-to-network interface. These commands configure dot1q tunneling on **interface Ethernet 1** and set the TPID of **interface Ethernet 2** to 0x9100.

```
switch(config)#interface ethernet 1
switch(config-if-Et1)#switchport mode dot1q-tunnel
switch(config-if-Et1)#interface ethernet 2
switch(config-if-Et2)#switchport mode trunk
switch(config-if-Et2)#switchport dot1q ethertype 0x9100
switch(config-if-Et2)#
```

In the above configuration, packets from Et1 to Et2 will undergo dot1q-tunneling (stacking of an additional dot1q tag), with an outer TPID of 0x9100 at egress, while packets with outer TPID 0x9100 going from Et2 to Et1 will have the outer tag removed at egress.

**11.3.3.2.5 Layer 2 802.1Q Encapsulation**

Layer 2 traffic encapsulation is enabled on the configuration mode interface for a specified VLAN through [l2-protocol encapsulation dot1q vlan](#).

**Example**

These commands enable traffic encapsulation for **VLAN 200** traffic passing through **interface Ethernet 5/2**.

```
switch(config)#interface ethernet 5/2
switch(config-if-Et5/2)#l2-protocol encapsulation dot1q vlan 200
```

**11.3.3.2.6 Port VLAN Scaling on DCS-7160**

Port VLAN scaling allows the user to configure a subset of ports in the scale mode. The [switchport vlan forwarding](#) command forwards packets between the ports belonging to VLAN in the interface configuration mode. Port-VLAN table is used for storing the configuration on a per port/VLAN combination. The scaling configuration is applicable on a per-port basis and supports a maximum of 128 ports.

 **Note:** The configuration is applicable to trunk ports only.

## Example

- This command enables VLAN scaling on a port with an *interface Ethernet 2*.

```
switch# config terminal
switch(config)# interface Ethernet 2
switch(config-if-Et2)# switchport vlan forwarding accept all
```

- This command disables VLAN scaling on a port.

```
switch# config
switch(config)# interface Ethernet 2
switch(config-if-Et2)# no switchport vlan forwarding accept all
```

### 11.3.3.3 Creating and Configuring VLAN Interfaces

The [interface vlan](#) command places the switch in VLAN-interface configuration mode for modifying an SVI. An SVI provides a management address point and Layer 3 processing for packets from all VLAN ports.

## Example

This command enters VLAN-interface configuration mode for **VLAN 12**. The command also creates **VLAN 12** interface if it was not previously created.

```
switch#config t
switch(config)#interface vlan 12
switch(config-if-Vl12)#
```

### 11.3.3.4 Allocating Internal VLANs

The [vlan internal order](#) command specifies the VLANs that the switch allocates as internal VLANs when configuring routed ports and the order of their allocation. By default, the switch allocates VLANs in ascending order. The default allocation range is between VLAN 1006 and VLAN 4094.

The **no switchport** command converts an Ethernet or port channel interface into a routed port, disabling layer 2 switching for the interface.

## Examples

- This command configures the switch to allocate internal VLANs in ascending order starting with 1006.

```
switch(config)#vlan internal order ascending
switch(config)#
```

- This command configures the switch to allocate internal VLANs in descending order starting with 4094.

```
switch(config)#vlan internal order descending
switch(config)#
```

- This command configures the switch to allocate internal VLANs in descending order from 4094 through 4000.

```
switch(config)#vlan internal order descending range 4000 4094
switch(config)#
```

### 11.3.3.5 Configuring VLAN Translation

VLAN translation changes the VLAN ID of specified packets entering or leaving a port. The following sections describe the configuration of VLAN translation.

#### 11.3.3.5.1 Per-port VLAN Translation on Switched Ports

The `switchport vlan translation` command allows translation of the VLAN tag of traffic entering or exiting a switched port.

To use VLAN translation on a switched port, the port must be configured as a trunk port using the `switchport mode` command.

#### Example

This command configures *interface Ethernet 5* as a trunk port.

```
switch(config)#interface ethernet 5
switch(config-if-Et5)#switchport mode trunk
switch(config-if-Et5)#
```

By default, the translation is bidirectional: packets ingressing an interface through *VLAN A* are internally mapped to *VLAN B*; *VLAN B* packets egressing the same interface are mapped to *VLAN A*.

#### Examples

- These commands map *interface Ethernet 5* traffic with dot1q tag 50 to bridging *VLAN 60*.

```
switch(config)#interface ethernet 5
switch(config-if-Et5)#switchport vlan translation 50 60
switch(config-if-Et5)#
```

- These commands provides multiple 1:1 VLAN mappings under an interface.

```
switch(config)#interface ethernet 5
switch(config-if-Et5)#switchport vlan translation 50 60
switch(config-if-Et5)#switchport vlan translation 61 71
switch(config-if-Et5)#switchport vlan translation 62 72
switch(config-if-Et5)#
```

- These commands translate only incoming packets.

```
switch(config)#interface ethernet 5
switch(config-if-Et5)#switchport vlan translation in 50 60
switch(config-if-Et5)#
```

- These commands translate only egress packets.

```
switch(config)#interface ethernet 5
switch(config-if-Et5)#switchport vlan translation out 60 50
switch(config-if-Et5)#
```

#### 11.3.3.5.2 Per-port VLAN Translation on Routed Ports

On routed ports, the `encapsulation dot1q vlan` command (permitted only on routed ports) configures the VLAN on the interface to act as the native VLAN. This command will map packets ingressing with the specified VLAN ID to the internal VLAN ID of the routed port. All traffic egressing out of the routed port will be tagged with the VLAN ID specified in the command.

---

## Examples

These commands translate between **VLAN 50** and the internal VLAN for **interface Ethernet 5** (a routed port).

```
switch(config)#interface ethernet 5
switch(config-if-Et5)#no switchport
switch(config-if-Et5)#encapsulation dot1q vlan 50
switch(config-if-Et5)#
```

### 11.3.3.5.3 Double VLAN Translation

Double VLAN translation creates mappings between an inner and outer VLAN ID pair of a double-tagged packet and a single bridging VLAN. On ingress, specified double-tagged packets are mapped to the bridging VLAN, and on egress packets with the ID of the bridging VLAN are double tagged as specified. By default, the translation is bidirectional, but it can be applied only on ingress or egress.

#### Example

- These commands causes packets entering **interface Ethernet 3/1** with an outer VLAN ID of 1000 and an inner VLAN ID of 100 to be processed in bridging **VLAN 200**.

```
switch(config)#interface ethernet 3/1
switch(config-if-Et3/1)#switchport vlan translation in 1000 inner 100
200
switch(config-if-Et3/1)#
```

## 11.3.4 VLAN Configuration Commands

### Global VLAN Configuration Commands

- [interface vlan](#)
- [vlan](#)
- [vlan internal order](#)

### VLAN Configuration Mode Commands

- [mac address forwarding](#)
- [name \(VLAN configuration mode\)](#)
- [state](#)
- [trunk group](#)

### Layer 2 Interface (Ethernet and Port Channel) Configuration Commands

- [switchport access vlan](#)
- [switchport dot1q ethertype](#)
- [switchport mode](#)
- [switchport trunk allowed vlan](#)
- [switchport trunk group](#)
- [switchport trunk native vlan](#)
- [switchport vlan forwarding](#)
- [switchport vlan translation](#)

### VLAN Interface Configuration Mode Commands

- [autostate](#)
- [encapsulation dot1q vlan](#)
- [l2-protocol encapsulation dot1q vlan](#)
- [name \(VLAN configuration mode\)](#)
- [pvlan mapping](#)

### Show Commands

- [show dot1q-tunnel](#)
- [show interfaces switchport](#)
- [show interfaces switchport backup-link](#)
- [show interfaces switchport vlan mapping](#)
- [show interfaces trunk](#)
- [show interfaces vlans](#)
- [show pvlan mapping interfaces](#)
- [show vlan](#)
- [show vlan brief count](#)
- [show vlan dynamic](#)
- [show vlan internal allocation policy](#)
- [show vlan internal usage](#)
- [show vlan trunk group](#)

---

### 11.3.4.1 vlan internal order

The **vlan internal order** command specifies the range that the switch can allocate as internal VLANs when configuring routed ports and the order of their allocation. By default, the switch allocates VLANs in ascending order from VLAN 1006 to VLAN 4094.

The **no vlan internal order** and **default vlan internal order** commands revert the policy to its default.

#### Command Mode

Global Configuration

#### Command Syntax

```
vlan internal order DIRECTION [RANGE_VLAN]
```

```
no vlan internal order
```

```
default vlan internal order
```

#### Parameters

- **DIRECTION** VLAN allocation number direction. Options include:
  - **ascending** allocates internal VLANs from lower VLAN bound to upper VLAN bound.
  - **descending** allocates internal VLAN from upper VLAN bound to lower VLAN bound.
- **RANGE\_VLAN** allocation range. Options include:
  - **no parameter** 1006 (lower bound) to 4094 (upper bound).
  - **range, lower, upper** specifies lower bound (**lower**) and upper bound (**upper**).

#### Examples

- This command configures the switch to allocate internal VLANS from **3000** through **3999**.

```
switch(config)#vlan internal order ascending range 3000 3999
switch(config)#
```

- This command configures the switch to allocate internal VLANS from **4094** through **1006**.

```
switch(config)#vlan internal order descending
switch(config)#
```

- This command configures the switch to allocate internal VLANS from **4094** down through **4000**.

```
switch(config)#vlan internal order descending range 4000 4094
switch(config)#
```

- This command reverts the allocation policy to its default (ascending, between **1006** and **4094**).

```
switch(config)#no vlan internal order
switch(config)#
```

### 11.3.4.2 vlan

The **vlan** command places the switch in VLAN configuration mode to configure a set of virtual LANs. The command creates the specified VLANs if they do not exist prior to issuing the command. A VLAN that is in use as an internal VLAN may not be created or configured. The switch rejects any **vlan** command that specifies an internal VLAN ID.

The **default vlan** and **no vlan** commands removes the VLAN statements from **running-config** for the specified VLANs.

The **exit** command returns the switch to global configuration mode.

#### Command Mode

Global Configuration

#### Command Syntax

```
vlan vlan_range
```

```
no vlan vlan_range
```

```
default vlan vlan_range
```

#### Parameters

- **vlan\_range** VLAN list.

Formats include a name, number, number range, or comma-delimited list of numbers and ranges.

#### Commands Available in VLAN configuration mode

- [name \(VLAN configuration mode\)](#)
- [state](#)
- [trunk group](#)

#### Guidelines

In MLAG configurations, VLANs operate as follows:

- The VLAN must be configured identically on both MLAG peer switches.
- The port-specific bridging configuration originates on the switch where the port is physically located. This configuration includes the switchport access VLAN, switchport mode (trunk or access), trunk-allowed VLANs, the trunk native VLAN, and the switchport trunk groups.

#### Example

This command creates **VLAN 49** and enters VLAN configuration mode for the new VLAN:

```
switch(config) #vlan 49
switch(config-vlan-49) #
```

---

### 11.3.4.3 autostate

When **autostate** is **enabled**, the VLAN interface will be up when:

- the corresponding VLAN exists and is in the active state.
- one or more layer 2 ports in the VLAN are up and in spanning-tree forwarding state.
- the VLAN interface exists and is not in a shutdown state.

Autostate is **enabled** by default. When autostate is **disabled**, the VLAN interface is forced to be active.

- The **no autostate** command disables autostate on the configuration mode interface. The **no autostate** command is stored to **running-config**.
- The **autostate** command enables the autostate function on the configuration mode VLAN SVI by removing the corresponding **no autostate** statement from **running-config**.
- The **default autostate** command restores the autostate default state of **enabled** by removing the corresponding **no autostate** statement from **running-config**.

#### Command Mode

Interface-VLAN Configuration

#### Command Syntax

```
autostate
```

```
no autostate
```

```
default autostate
```

#### Guidelines

Autostate should be disabled on SVIs configured as an MLAG local interface.

#### Examples

- These commands disable autostate on **VLAN 100**.

```
switch(config)#interface vlan 100
switch(config-if-Vl100)#no autostate
switch(config-if-Vl100)#
```

- These commands enable autostate on **VLAN 100**.

```
switch(config)#interface vlan 100
switch(config-if-Vl100)#autostate
switch(config-if-Vl100)#
```



### 11.3.4.4 encapsulation dot1q vlan

#### Routed Port VLAN Translation

In the configuration mode for an Ethernet or port channel interface, the **encapsulation dot1q vlan** translates packets with a dot1q header to the internal VLAN for a routed port. The VLAN in the incoming packets is mapped to the internal VLAN of the routed port, and packets egressing the routed port are encapsulated with a dot1q header for the specified VLAN. For egress packets, no priority information is added to the dot1q header and the priority from the incoming encapsulation will be retained.

#### Subinterface VLAN Assignment

When used in the configuration mode for an Ethernet or port channel subinterface, however, the **encapsulation dot1q vlan** command assigns a dot1q tag to the subinterface. Traffic ingressing on the parent interface with that dot1q tag will then be sent to the configured subinterface. See **Subinterfaces** and **Subinterface Configuration** for details.

The **no encapsulation dot1q vlan** and **default encapsulation dot1q vlan** commands restore the default VLAN to the configuration mode interface by removing the corresponding **encapsulation dot1q vlan** command from *running-config*.

#### Command Mode

Interface-Ethernet Configuration

Interface-port-channel Configuration

Subinterface-Ethernet Configuration

Subinterface-port-channel Configuration

#### Command Syntax

```
encapsulation dot1q vlan vlan_id
no encapsulation dot1q vlan
default encapsulation dot1q vlan
```

#### Parameters

**vlan\_id** For VLAN translation, the ID of the external VLAN to be translated; for subinterface configuration, the VLAN of the subinterface. Values range from 1 to 4094.

#### Examples

- These commands translate between **VLAN 50** and the internal VLAN for **interface Ethernet 5** (a routed port).

```
switch(config)#interface ethernet 5
switch(config-if-Et5)#no switchport
switch(config-if-Et5)#encapsulation dot1q vlan 50
switch(config-if-Et5)#
```

- These commands assign packets ingressing on **interface Ethernet 1/1** with **VLAN ID 100** to subinterface Ethernet 1/1.1.

```
switch(config)#interface ethernet1/1.1
switch(config-if-Et1/1.1)#no switchport
switch(config-if-Et1/1.1)#encapsulation dot1q vlan 100
switch(config-if-Et1/1.1)#
```

---

### 11.3.4.5 interface vlan

The **interface vlan** command places the switch in VLAN-interface configuration mode for modifying parameters of the switch virtual interface (SVI). An SVI provides Layer 3 processing for packets from all ports associated with the VLAN. There is no physical interface for the VLAN.

When entering configuration mode to modify existing SVIs, the command can specify multiple interfaces. The command creates an SVI if the specified interface does not exist prior to issuing the command. When creating an SVI, the command can only specify a single interface.

The **no interface vlan** command deletes the specified SVI interfaces from **running-config**. The **default interface vlan** commands remove all configuration statements for the specified SVI interfaces from **running-config** without deleting the interfaces.

#### Command Mode

Global Configuration

#### Command Syntax

```
interface vlan v_range
no interface vlan v_range
default interface vlan v_range
```

#### Parameter

- **v\_range** VLAN interfaces (number, range, or comma-delimited list of numbers and ranges). VLAN number ranges from 1 to 4094.

#### Restrictions

**Internal VLANs:** A VLAN interface cannot be created or configured for internal VLAN IDs. The switch rejects any **interface vlan** command that specifies an internal VLAN ID.

#### Example

This example creates an SVI for **VLAN 12**:

```
switch#config
switch(config)#interface vlan 12
switch(config-if-Vl12)#
```

### 11.3.4.6 I2-protocol encapsulation dot1q vlan

The `l2-protocol encapsulation dot1q vlan` command enables Layer 2 802.1Q traffic encapsulation on the configuration mode interface for a specified VLAN. The default VLAN for all interfaces is VLAN 1.

The `no l2-protocol encapsulation dot1q vlan` and `default l2-protocol encapsulation dot1q vlan` commands disable the specified encapsulation on the configuration mode interface by removing the corresponding `l2-protocol encapsulation dot1q vlan` command from *running-config*.

#### Command Mode

Interface-Ethernet Configuration

Interface-Port-channel Configuration

#### Command Syntax

```
l2-protocol encapsulation dot1q vlan vlan_id
no l2-protocol encapsulation dot1q vlan
default l2-protocol encapsulation dot1q vlan
```

#### Parameters

- ***vlan\_id*** the ID of the native VLAN. Values range from 1 to 4094.

#### Example

These commands enable 802.1Q encapsulation of traffic on **VLAN 200**.

```
switch(config)#interface ethernet 5/2
switch(config-if-Et5/2)#l2-protocol encapsulation dot1q vlan 200
switch(config-if-Et5/2)#show active
interface Ethernet5/2
 l2-protocol encapsulation dot1q vlan 200
switch(config-if-Et5/2)#
```

---

### 11.3.4.7 mac address forwarding

The **mac address forwarding** command enables a switch to configure a VLAN policy when it receives a packet with an unknown destination MAC address on a VLAN. The command provides three options to configure a VLAN policy:

- Flood the Layer 2 miss packets on the VLAN
- Drop the Layer 2 miss packets
- Log the Layer 2 miss packets to the CPU (while still flooding them on the VLAN)

The default state is to flood the L2 miss packets on all ports of the VLAN.

The **show vlan** command displays information about the VLAN policy that is being configured.

The **no** form and the default form of the command removes the previously configured VLAN policy on the VLAN.

#### Command Mode

VLAN Configuration

#### Command Syntax

```
mac address forwarding [unicast | multicast] miss action [drop | flood | log]
```

```
no mac address forwarding [unicast | multicast] miss action [drop | flood | log]
```

```
default mac address forwarding [unicast | multicast] miss action [drop | flood | log]
```

#### Parameters

- **unicast** the unicast type of transmission.
- **multicast** the multicast type of transmission.
- **drop** the selected packets are dropped.
- **flood** the selected packets are flooded in the specific VLAN.
- **log** the selected packets are sent to the CPU for logging purpose.

#### Guidelines

VLAN policy configuration is supported on the Arista 7010, 7050 (excluding 7050SX3-48YC12, 7050CX3-32S, 7050QX2-32S, 7050SX2-72Q, 7050SX2-128, 7050TX2-128), 7060, 7250, and the 7300 series platforms.

VLAN policy is not supported in the following cases:

- STP, LLDP, and LACP packets
- VLAN policy configurations on VXLAN-enabled VLAN
- On a VLAN if IGMP snooping is configured with Multicast miss action is set to drop, then all multicast packets received on that VLAN are dropped.

#### Examples

- These commands create a **VLAN 333** and then set the unicast policy to 'drop' and the multicast policy to 'log' for the specific **VLAN 333**.

```
switch(config)#vlan 333
switch(config-vlan-333)#mac address forwarding unicast miss action drop
switch(config-vlan-333)#mac address forwarding multicast miss action
log
```

- These commands display the VLAN policy that was defined when **VLAN 333** is created.

```
switch(config)#show vlan 333 mac address forwarding
VLAN UcMissAction McMissAction
```

```

333 flood flood
```

- These commands display the VLAN policy type that was defined when **VLAN 333** is configured with the 'drop' unicast policy and the 'log' multicast policy.

```
switch(config)#show vlan 333 mac address forwarding
```

```
VLAN UcMissAction McMissAction

333 drop log
```

```
switch(config)#show vlan mac address forwarding
```

```
VLAN UcMissAction McMissAction

1 flood flood
333 drop log
```

---

### 11.3.4.8 name (VLAN configuration mode)

The **name** command configures the VLAN name. The name can have up to 32 characters. The default name for VLAN 1 is **default**. The default name for all other VLANs is VLANxxxx, where xxxx is the VLAN number. The default name for VLAN 55 is VLAN0055. The [show vlan](#) command displays the VLAN name.

The **name** command accepts all characters except the space.

The **no name** and **default name** commands restore the default name by removing the **name** command from *running-config*.

#### Command Mode

VLAN Configuration

#### Command Syntax

```
name label_text
```

```
no name
```

```
default name
```

#### Parameters

- **label\_text** character string assigned to name attribute. Maximum length is 32 characters. The space character is not permitted in the name string.

#### Example

These commands assign corporate\_100 as the name for **VLAN 25**, then displays the VLAN name.

```
switch(config)#vlan 25
switch(config-vlan-25)#name corporate_100
switch(config-vlan-25)#show vlan 25
VLAN Name Status Ports

25 corporate_100 active
switch(config-vlan-25)#
```

### 11.3.4.9 pvlan mapping

The `pvlan mapping` command maps a switch virtual interface (SVI) available in the primary VLAN to the secondary VLAN or VLANs in the VLAN configuration mode. The [show pvlan mapping interfaces](#) command displays the list of mapped VLANs.

The `no pvlan mapping` and `default pvlan mapping` commands restore the default state of the private VLAN mapping.

#### Command Mode

VLAN Configuration

#### Command Syntax

```
pvlan mapping{add | remove | vlan ID}
no pvlan mapping{add | remove | vlan ID}
default pvlan mapping{add | remove | vlan ID}
```

#### Parameters

- **add** adding VLANs to the PVLAN mapping of the current VLAN interface.
- **remove** removing VLANs from the PVLAN mapping of the current VLAN interface.
- **vlan ID** The secondary VLAN IDs of the private VLAN mapping. The IDs range from 1 to 4094.

#### Related Commands

[show pvlan mapping interfaces](#)

#### Example

These commands assign a secondary VLAN ID of 50 to the primary VLAN.

```
switch(config)#vlan 25
switch(config-vlan-25)#pvlan mapping 50
switch(config-vlan-25)#
```

---

### 11.3.4.10 show dot1q-tunnel

The **show dot1q-tunnel** command displays the ports that are configured in dot1q-tunnel switching mode. The **switchport mode** command configures the switching mode for the configuration mode interface.

#### Command Mode

EXEC

#### Command Syntax

```
show dot1q-tunnel [INTERFACE]
```

#### Parameters

- **INTERFACE** Interface type and numbers. Options include:
  - **no parameter** Display information for all interfaces.
  - **ethernet e\_range** Ethernet interface range specified by **e\_range**.
  - **loopback l\_range** Loopback interface specified by **l\_range**.
  - **management m\_range** Management interface range specified by **m\_range**.
  - **port-channel p\_range** Port-Channel Interface range specified by **p\_range**.
  - **vlan v\_range** VLAN interface range specified by **v\_range**.
  - **vxlan vx\_range** VXLAN interface range specified by **vx\_range**.

Valid **range** formats include number, number range, or comma-delimited list of numbers and ranges.

#### Example

This command displays the ports that are configured in dot1q-tunnel switching mode.

```
switch>show dot1q-tunnel
dot1q-tunnel mode LAN Port (s)

Po4
Po21
Po22
switch>
```



### 11.3.4.11 show interfaces switchport backup-link

The **show interfaces switchport backup-link** command displays interfaces that are configured as switchport backup pairs and the operational status of each interface. For each pair, the command displays the names, roles, status, and VLAN traffic of each interface.

#### Command Mode

EXEC

#### Command Syntax

```
show interfaces [INTERFACE] switchport backup-link
```

```
show interfaces switchport backup-link [module{Fabric f_num | Linecard lc_num | Supervisor svr_num | Switchcard | 1-2 | 3-6}]
```

#### Parameters

- **INTERFACE** Interface type and numbers. Options include:
  - **no parameter** Display information for all interfaces.
  - **ethernet *e\_range*** Ethernet interface range specified by ***e\_range***.
  - **loopback *l\_range*** Loopback interface specified by ***l\_range***.
  - **management *m\_range*** Management interface range specified by ***m\_range***.
  - **port-channel *p\_range*** Port-Channel Interface range specified by ***p\_range***.
  - **vlan *v\_range*** VLAN interface range specified by ***v\_range***.

Valid ***e\_range***, ***l\_range***, ***m\_range***, ***p\_range***, and ***v\_range*** formats include number, number range, or comma-delimited list of numbers and ranges.

- **module** Displays interfaces of the specified module. Options include:
  - **Fabric *f\_num*** Displays interfaces of the specified fabric module. Value ranges from 1 to 6.
  - **Linecard *lc\_num*** Displays interfaces of the specified linecard module. Value ranges from 3 to 6.
  - **Supervisor *svr\_num*** Displays interfaces of the specified supervisor module. Accepted values are 1 and 2.
  - **Switchcard** Displays interfaces of switchcard modules.
  - **1-2** Displays interfaces of the specified supervisor module.
  - **3-6** Displays interfaces of the specified linecard module.

#### Display Values

- **State** Operational status of the interface. Values include:
  - **Up** Spanning tree mode is *backup*, interface status is **up**.
  - **Down** Spanning tree mode is *backup*, interface status is **down**.
  - **Inactive Configuration** The spanning tree mode is not **backup**.
- **Forwarding vlans** VLANs forwarded by the interface. Depends on interface operation status and prefer option specified by the **switchport backup** command.

#### Example

- This command displays the configured switchport primary-backup pairs.

```
switch>show interfaces switchport backup-link
Switch backup interface pair: Ethernet3/17, Ethernet3/8
Primary Interface: Ethernet3/17 State: Inactive Configuration
Backup Interface: Ethernet3/8 State: Inactive Configuration
Preemption delay: 0 milliseconds
Mac move burst size: 0
Mac move burst interval: 20 milliseconds
```

---

```
Mac move destination: ff:ff:ff:ff:ff:ff
```

- This command displays interfaces of the module for *linecard 4*.

```
switch(config)#show int switchport backup-link module Linecard 4
Switch backup interface pair: Ethernet4/19/1, Ethernet4/19/2
Primary Interface: Ethernet4/19/1 State: Inactive Configuration
Backup Interface: Ethernet4/19/2 State: Inactive Configuration
Preemption delay: 0 milliseconds
Mac move burst size: 0
Mac move burst interval: 20 milliseconds
Mac move destination: ff:ff:ff:ff:ff:ff
```

### 11.3.4.12 show interfaces switchport vlan mapping

The **show interfaces switchport vlan mapping** command displays mapping information of the configured VLANs in an interface mode.

#### Command Mode

EXEC

#### Command Syntax

**show interfaces switchport vlan mapping**

#### Examples

- This command displays mapping information of the configured VLAN IDs.

```
switch#show interfaces switchport vlan mapping

Ethernet3

```

| Original Vlan | New Vlan | Status | Direction<br>Configured | Direction<br>Active |
|---------------|----------|--------|-------------------------|---------------------|
| 10            | 100      | Active | In/Out                  | In/Out              |
| 11            | 200      | Active | In                      | In                  |
| 300           | 12       | Active | Out                     | Out                 |

- This command displays dual tag mapping information of the configured VLAN IDs.

```
switch(config)#show interfaces switchport vlan mapping

Ethernet3/1
Direction
Outer Tag Direction
 Inner Tag VLAN ID Status Configured Active Dot1 qTunnel

1000 100 200 active In/Out In/Out -
1001 101 201 active In In -
1002 102 202 active Out Out -
```

- This command displays dual tag mapping information of the configured VLAN IDs.

```
switch(config)#show interfaces switchport vlan mapping

Ethernet1/1

```

| Outer Tag | Inner Tag | VLAN ID | Status | Direction<br>Configured | Direction<br>Active |
|-----------|-----------|---------|--------|-------------------------|---------------------|
| 70        | -         | 300     | Active | In/Out                  | In/Out              |
| 10        | 50        | 100     | Active | In/Out                  | In/Out              |
| 20        | 60        | 100     | Active | In                      | In                  |
| 30        | 40        | 200     | Active | Out                     | Out                 |

### 11.3.4.13 show interfaces switchport

The **show interfaces switchport** command displays the switching configuration and operational status of the specified ports.

#### Command Mode

EXEC

#### Command Syntax

```
show interfaces [INTERFACE] switchport
```

#### Parameters

- **INTERFACE** Interface type and numbers. Options include:
  - **no parameter** Display the switching status for all interfaces.
  - **ethernet e\_range** Ethernet interface range specified by **e\_range**.
  - **loopback l\_range** Loopback interface specified by **l\_range**.
  - **management m\_range** Management interface range specified by **m\_range**.
  - **port-channel p\_range** Port-Channel Interface range specified by **p\_range**.
  - **vlan v\_range** VLAN interface range specified by **v\_range**.

Valid **e\_range**, **l\_range**, **m\_range**, **p\_range**, and **v\_range** formats include number, number range, or comma-delimited list of numbers and ranges.

#### Example

- This command displays the switching status for all interfaces.

```
switch(config)#show interface switchport
Default switchport mode: access

Name: Et5/1
Switchport: Enabled
Administrative Mode: static access
Operational Mode: static access
MAC Address Learning: enabled
Access Mode VLAN: 1 (default)
Trunking Native Mode VLAN: 1 (default)
Administrative Native VLAN tagging: disabled
Trunking VLANs Enabled: ALL
Static Trunk Groups:
Dynamic Trunk Groups:

Name: Et5/2
Switchport: Enabled
Administrative Mode: static access
Operational Mode: static access
MAC Address Learning: enabled
Access Mode VLAN: 1 (default)
Trunking Native Mode VLAN: 1 (default)
Administrative Native VLAN tagging: disabled
Trunking VLANs Enabled: ALL
Static Trunk Groups:
Dynamic Trunk Groups:

[...]

switch(config)#
```

- This command displays the switching status of port channel interfaces **21** and **22**.

```
switch>show interface port-channel 21-22 switchport
```

```
Name: Po21
Switchport: Enabled
Administrative Mode: tunnel
Operational Mode: tunnel
Access Mode VLAN: 1 (inactive)
Trunking Native Mode VLAN: 100 (VLAN0100)
Administrative Native VLAN tagging: disabled
Trunking VLANs Enabled: ALL
Trunk Groups: foo
```

```
Name: Po22
Switchport: Enabled
Administrative Mode: tunnel
Operational Mode: tunnel
Access Mode VLAN: 1 (inactive)
Trunking Native Mode VLAN: 1 (inactive)
Administrative Native VLAN tagging: disabled
Trunking VLANs Enabled: ALL
Trunk Groups:
```

```
switch>
```

- This command displays the configured status of VLAN scaling for the **interface Ethernet 2/1** port.

```
switch#show interface Ethernet 2/1 switchport
Name: Ethernet 2/1
Switchport: Enabled
Administrative Mode: trunk
Operational Mode: trunk
MAC Address Learning: enabled
Dot1q ethertype/TPID: 0x8100 (active)
Dot1q VLAN Tag: Allowed
Access Mode VLAN: 1 (default)
Trunking Native Mode VLAN: 1 (default)
Administrative Native VLAN tagging: disabled
Trunking VLANs Enabled: ALL
Static Trunk Groups:
Dynamic Trunk Groups:
Source interface filtering: enabled
VLAN forwarding mode: allConfiguredVlans

switch>
```

---

### 11.3.4.14 show interfaces trunk

The **show interfaces trunk** command displays configuration and status information for interfaces configured in switchport trunk mode.

#### Command Mode

EXEC

#### Command Syntax

```
show interfaces [INTERFACE] trunk
```

#### Parameters

- **INTERFACE** Interface type and numbers. Options include:
  - **no parameter** Display information for all interfaces.
  - **ethernet e\_range** Ethernet interface range specified by **e\_range**.
  - **management m\_range** Management interface range specified by **m\_range**.
  - **port-channel p\_range** Port-Channel Interface range specified by **p\_range**.

Valid **e\_range**, **m\_range**, and **p\_range** formats include number, number range, or comma-delimited list of numbers and ranges.

#### Example

This command displays the trunk status for all interfaces configured in switchport trunk mode.

```
switch>show interfaces trunk
Port Mode Status Native vlan
Po1 trunk trunking 1
Po2 trunk trunking 1

Port Vlans allowed
Po1 1-15
Po2 16-30

Port Vlans allowed and active in management domain
Po1 1-10
Po2 21-30

Port Vlans in spanning tree forwarding state
Po1 1-10
Po2 21-30

switch>
```

### 11.3.4.15 show interfaces vlans

The **show interfaces vlans** command displays a table that lists the VLANs that are carried by the specified interfaces. Interfaces that do not carry VLANs are not listed in the table. The table lists the untagged (native or access) and tagged VLANs for each interface.

#### Command Mode

EXEC

#### Command Syntax

```
show interfaces [INT_NAME] vlans
```

#### Parameters

- **INT\_NAME** Interface type and number. Values include
  - **ethernet e\_num** Ethernet interface specified by **e\_num**.
  - **management m\_num** Management interface specified by **m\_num**.
  - **port-channel p\_num** Port-Channel Interface specified by **p\_num**.

#### Example

This command displays the VLANs carried by all L2 ports.

```
switch>show interfaces vlans
Port Untagged Tagged
Et9 3910 -
Et11 3912 -
Et16 500 -
Et17 3908 -
Et18 3908 -
Po1 1 101-102,500,721,3000,
Po2 101 -
Po4 3902 -
Po5 3903 -
Po6 3992 -
Po7 661 -
Po8 3911 -
```

---

### 11.3.4.16 show pvlan mapping interfaces

The `show pvlan mapping interfaces` command displays information about the private VLAN mapping interfaces.

#### Command Mode

EXEC

#### Command Syntax

```
show pvlan mapping interfaces
```

#### Example

- This command displays information about the private VLAN mapping interfaces.

```
switch(config)#int vlan 50
switch(config-if-Vl50)#pvlan mapping 70
switch(config-if-Vl50)#show pvlan mapping interfaces
Interface Secondary Vlans

Vlan50 70
```



### 11.3.4.17 show vlan brief count

The **show vlan brief count** command displays the number of VLANs that are configured on the switch.

#### Command Mode

EXEC

#### Command Syntax

```
show vlan brief count
```

#### Example

This command displays the number of VLANs on the switch.

```
switch>show vlan brief count
Number of existing VLANs : 18
switch>
```

---

### 11.3.4.18 show vlan dynamic

The **show vlan dynamic** command displays the source and quantity of dynamic VLANs on the switch. Dynamic VLANs support VM Tracer monitoring sessions.

#### Command Mode

EXEC

#### Command Syntax

```
show vlan dynamic
```

#### Example

This command displays the source and quantity of dynamic VLANs on the switch.

```
switch>show vlan dynamic
Dynamic VLAN source VLANS
vmtracer-poc 88
switch>
```

### 11.3.4.19 show vlan internal allocation policy

The **show vlan internal allocation policy** command displays the method the switch uses to allocate VLANs to routed ports. The [vlan internal order](#) command configures the allocation method.

The allocation method consists of two configurable components:

- range: the list of VLANs that are allocated to routed ports.
- direction: the direction by which VLANs are allocated (ascending or descending).

#### Command Mode

EXEC

#### Command Syntax

```
show vlan internal allocation policy
```

#### Example

This command displays the internal allocation policy.

```
switch>show vlan internal allocation policy
Internal VLAN Allocation Policy: ascending
Internal VLAN Allocation Range: 1006-4094
switch>
```

---

### 11.3.4.20 show vlan internal usage

The **show vlan internal usage** command shows the VLANs that are allocated as internal VLANs for routed ports.

A routed port is an Ethernet or port channel interface that is configured as a layer 3 interface. Routed ports do not bridge frames and are not members of any VLANs. Routed ports can have IP addresses assigned to them and packets are routed directly to and from the port.

When an interface is configured as a routed port, the switch allocates an SVI with a previously unused VLAN ID. The switch prohibits the configuration of VLANs with numbers corresponding to internal VLAN interfaces allocated to a routed port. VLAN interfaces corresponding to SVIs allocated to a routed port cannot be configured by VLAN interface configuration mode commands.

#### Command Mode

EXEC

#### Command Syntax

```
show vlan internal usage
```

#### Example

This command displays the VLANs that are allocated to routed ports.

```
switch>show vlan internal usage
1006 Ethernet3
1007 Ethernet4
switch>
```

### 11.3.4.21 show vlan trunk group

The `show vlan trunk group` command displays the trunk group membership of the specified VLANs.

#### Command Mode

EXEC

#### Command Syntax

```
show vlan [VLAN_LIST] trunk group
```

#### Parameters

- **VLAN\_LIST** VLAN list. Options include:
  - *no parameter* all VLANs.
  - *v\_range* VLANs specified by *v\_range*.
  - *id v\_range* VLANs specified by *v\_range*.
  - *name v\_name* VLANs specified by the VLAN name *v\_name*.

#### Display Values

- **VLAN** VLAN ID.
- **Trunk Groups** Trunk groups associated with the listed VLANs.

#### Example

This command displays the trunk group membership of all configured VLANs.

```
switch>show vlan trunk group
VLAN Trunk Groups

5
10 first_group
12
40 second_group
100 third_group
101 middle_group
102
200

switch>
```

### 11.3.4.22 show vlan

The **show vlan** command displays the VLAN ID, name, status, and member ports of all configured VLANs. The command only displays active ports by default; by specifying **configured-ports**, the command displays all ports that are members of a configured VLAN regardless of their activity status, including Ethernet ports that are members of a port channel.

#### Command Mode

EXEC

#### Command Syntax

```
show vlan [VLAN_LIST][PORT_ACTIVITY]
```

#### Parameters

- **VLAN\_LIST** List of VLANs displayed by command. Options include:
  - **no parameter** all VLANs.
  - **v\_range** VLANs specified by **v\_range**.
  - **id v\_range** VLANs specified by **v\_range**.
  - **name v\_name** VLANs specified by the VLAN name **v\_name**.

**v\_range** formats include number, number range, or comma-delimited list of numbers and ranges.

- **PORT\_ACTIVITY** Ports listed in table. Options include:
  - **no parameter** table displays only active ports (same as **active-configuration** option).
  - **active-configuration** table displays only active ports.
  - **configured-ports** table displays all configured ports.

#### Display Values

- **VLAN** The VLAN ID.
- **Name** The name of the VLAN.
- **Status** The status of the VLAN.
- **Ports** The ports that are members of the VLAN.

#### Examples

- This command displays status and ports of VLANs 1-1000.

```
switch>show vlan 1-1000
VLAN Name Status Ports

 1 default active Po1
184 fet.arka active Cpu, Po1, Po2
262 mgq.net active PPo2, Po1
512 sant.test active Cpu, Et16, Po1
821 ipv6.net active Cpu, Po1, Po7

switch>
```

- This command displays the list of all the member interfaces under each SVI.

```
switch#show vlan
VLAN Name Status Ports

 1 default active
2148 VLAN2148 active Cpu, Et1, Et26
2700 VLAN2700 active Cpu, Et18
```

### 11.3.4.23 state

The **state** command configures the VLAN transmission state of the configuration mode VLAN.

- **Active state:** Ports forward VLAN traffic.
- **Suspend state:** Ports block VLAN traffic.

The default transmission status is active.

The **no state** command restores the default VLAN transmission state to the configuration mode VLAN by removing the corresponding **state** command from *running-config*.

#### Command Mode

VLAN Configuration

#### Command Syntax

```
state OPERATION_STATE
```

```
no state
```

```
default state
```

#### Parameters

- **OPERATION\_STATE** VLAN transmission state. Options include:
  - **active** VLAN traffic is forwarded
  - **suspend** VLAN traffic is blocked.

#### Example

These commands suspend VLAN traffic on VLANs 100-102.

```
switch(config)#vlan 100-102
switch(config-vlan-100-102)#state suspend
switch(config-vlan-100-102)#
```

---

### 11.3.4.24 switchport access vlan

The **switchport access vlan** command specifies the access VLAN of the configuration mode interface. Ethernet or port channel interfaces that are in access mode are members of only the access VLAN. Untagged frames that the interface receives are associated with the access VLAN. Frames tagged with the access VLAN are also associated with the access VLAN. The interface drops all other tagged frames that it receives. By default, VLAN 1 is the access VLAN of all Ethernet and port channel interfaces.

An interface's access mode is effective only when the interface is in access mode or dot1q-tunnel mode, as specified by the switchport mode command. Interfaces in dot1q-tunnel mode handle inbound traffic as untagged traffic and associate all traffic with the access VLAN. Interfaces configured to switchport trunk mode maintain and ignore existing switchport access commands.

The **no switchport access vlan** and **default switchport access vlan** commands restore **VLAN 1** as the access VLAN of the configuration mode interface by removing the corresponding **switchport access vlan** statement from **running-config**.

#### Command Mode

Interface-Ethernet Configuration

Interface-Port-channel Configuration

#### Command Syntax

```
switchport access vlan v_num
no switchport access vlan
default switchport access vlan
```

#### Parameters

- **v\_num** number of access VLAN. Value ranges from 1 to 4094. Default is 1.

#### Example

These commands assign **VLAN 100** as the access VLAN to **interface Ethernet 5**.

```
switch(config)#interface ethernet 5
switch(config-if-Et5)#switchport access vlan 100
switch(config-if-Et5)#
```



### 11.3.4.25 switchport dot1q ethertype

The **switchport dot1q ethertype** command configures the tag protocol identifier (TPID, also known as a dot1q ethertype), of the configuration mode interface. By default, all switch ports use the standard TPID of 0x8100.

The **no switchport dot1q ethertype** and **default switchport dot1q ethertype** commands restore the TPID to 0x8100 by removing the corresponding **switchport dot1q ethertype** statement from *running-config*.

#### Command Mode

Interface-Ethernet Configuration

#### Command Syntax

```
switchport dot1q ethertype ethertype
```

```
no switchport dot1q ethertype
```

```
default switchport dot1q ethertype
```

#### Parameters

**ethertype** ethertype number (TPID). Value ranges from 0x600 (1536) through 0xFFFF (65535), and can be entered in decimal or hexadecimal notation. Value is stored and displayed in hexadecimal form; the default value is 0x8100.

#### Example

These commands configure 0x9100 as the TPID of *interface Ethernet 5*.

```
switch(config)#interface ethernet 5
switch(config-if-Et5)#switchport dot1q ethertype 0x9100
switch(config-if-Et5)#
```

---

### 11.3.4.26 switchport mode

The **switchport mode** command specifies the switching mode of the configuration mode interface. The switch supports five switching modes: access, trunk, dot1q-tunnel, tap, and tool.

- **Access switching mode:** The interface is a member of one VLAN, called the access VLAN, as specified by the **switchport access vlan** command. Tagged frames received on the interface are dropped unless they are tagged with the access VLAN. Frames transmitted from the interface are always untagged.
- **Trunk switching mode:** The interface may be a member of multiple VLANs, as configured by the **switchport trunk allowed vlan** command. Untagged traffic is associated with the interface's native VLAN, as configured with the **switchport trunk native vlan** command.
- **Dot1q-tunnel switching mode:** The interface treats all inbound packets as untagged traffic and handles them as traffic of its access VLAN, as specified by the **switchport access vlan** command.
- **Tap mode:** The interface operates as a tap port. Tap ports receive traffic for replication on one or more tool ports. The interface may be a member of multiple VLANs, as configured by the **switchport tap allowed vlan** command. Untagged traffic is associated with the interface's native VLAN, as configured with the **switchport tap native vlan** command.

Tap ports are in STP forwarding state and prohibit egress traffic. MAC learning, control plane interaction and traps for inbound traffic are disabled.

- **Tool mode:** The interface operates as a tool port. Tool ports replicate traffic received by tap ports. The interface may be a member of multiple VLANs, as configured by the **switchport tool allowed vlan** command. MAC learning, control plane interaction and traps for inbound traffic are disabled.

Tool ports are in STP forwarding state and prohibit ingress traffic that uses port settings.

The status of switchport configured ports depends on the switch's tap aggregation mode (which can be viewed by using the **mode** command):

- tap aggregation mode enabled: tap and tool ports are errdisabled. Switching ports are errdisabled.
- tap aggregation mode disabled: tap and tool ports are errdisabled. Switching ports are enabled.

The **no switchport mode** and **default switchport mode** commands return the configuration mode interface to its default setting as an access port by deleting the corresponding **switchport mode** command from **running-config**.

#### Command Mode

Interface-Ethernet Configuration

Interface-Port-channel Configuration

#### Command Syntax

```
switchport mode MODE_TYPE
```

```
no switchport mode
```

```
default switchport mode
```

#### Parameters

- **MODE\_TYPE** switching mode of the configuration mode interfaces. Options include:
  - **access** access switching mode.
  - **dot1q-tunnel** dot1q-tunnel switching mode.
  - **tap** tap switching mode.
  - **tool** tool switching mode.
  - **trunk** trunk switching mode.

#### Restrictions

**Dot1q-tunnel** switching mode is not available on Petra platform switches.

**Tap** aggregation (tap and tool modes) is available on FM6000 and Arad platform switches.

### Example

These commands configure *interface Ethernet 4* as a trunk port.

```
switch(config)#interface ethernet 4
switch(config-if-Et4)#switchport mode trunk
switch(config-if-Et4)#
```

---

### 11.3.4.27 switchport trunk allowed vlan

The **switchport trunk allowed vlan** command creates or modifies the list of VLANs for which the configuration mode interface, in trunk mode, handles tagged traffic. By default, interfaces handle tagged traffic for all VLANs. Command settings persist in **running-config** without taking effect when the switch is in tap aggregation mode or the interface is not in trunk mode.

The **no switchport trunk allowed vlan** and **default switchport trunk allowed vlan** commands restore the trunk mode default allowed VLAN setting of **all** by removing the corresponding **switchport trunk allowed vlan** statement from **running-config**.

#### Command Mode

Interface-Ethernet Configuration

Interface-Port-channel Configuration

#### Command Syntax

```
switchport trunk allowed vlan EDIT_ACTION
```

```
no switchport trunk allowed vlan
```

```
default switchport trunk allowed vlan
```

#### Parameters

- **EDIT\_ACTION** modifications to the VLAN list.
  - **v\_range** Creates VLAN list from *v\_range*.
  - **add v\_range** Adds specified VLANs to current list.
  - **all** VLAN list contains all VLANs.
  - **except v\_range** VLAN list contains all VLANs except those specified.
  - **none** VLAN list is empty (no VLANs).
  - **remove v\_range** Removes specified VLANs from current list.

Valid **v\_range** formats include number, range, or comma-delimited list of numbers and ranges.

#### Example

These commands create the trunk mode allowed VLAN list of 6-10 for **interface Ethernet 14**, then verifies the VLAN list.

```
switch(config)#interface ethernet 14
switch(config-if-Et14)#switchport trunk allowed vlan 6-10
switch(config-if-Et14)#show interfaces ethernet 14 switchport
Name: Et14
Switchport: Enabled
Administrative Mode: trunk
Operational Mode: trunk
Access Mode VLAN: 1 (inactive)
Trunking Native Mode VLAN: 1 (inactive)
Administrative Native VLAN tagging: disabled
Trunking VLANs Enabled: 6-10
Trunk Groups:

switch(config-if-Et14)#
```

### 11.3.4.28 switchport trunk group

The **switchport trunk group** command assigns the configuration mode interface to the specified trunk group. Trunk group ports handle traffic of the VLANs assigned to the group.

The **no switchport trunk group** and **default switchport trunk group** commands remove the configuration mode interface from the specified trunk group by deleting the corresponding statement from running-config. If the command does not specify a trunk group, the interface is removed from all trunk groups to which it is assigned.



**Note:** On platforms which support the use of port channels as mirror destinations, a port channel which is being used as a mirror destination *must not* be assigned to an MLAG.

#### Command Mode

Interface-Ethernet Configuration

Interface-Port-channel Configuration

#### Command Syntax

```
switchport trunk group [group_name]
no switchport trunk group [group_name]
default switchport trunk group [group_name]
```

#### Parameters

- **group\_name** trunk group name.

#### Example

These commands assign **port channel 4** to trunk group **fe-1**.

```
switch(config)#interface port-channel 4
switch(config-if-Po4)#switchport trunk group fe-1
switch(config-if-Po4)#
```

---

### 11.3.4.29 switchport trunk native vlan

The **switchport trunk native vlan** command specifies the trunk mode native VLAN for the configuration mode interface. Interfaces in trunk mode associate untagged frames with the native VLAN. Trunk mode interfaces can also be configured to drop untagged frames. The default native VLAN for all interfaces is VLAN 1.

The **no switchport trunk native vlan** and **default switchport trunk native vlan** commands restore **VLAN 1** as the trunk mode native VLAN to the configuration mode interface by removing the corresponding **switchport trunk native vlan** command from **running-config**.

#### Command Mode

Interface-Ethernet Configuration

Interface-Port-channel Configuration

#### Command Syntax

```
switchport trunk native vlan VLAN_ID
```

```
no switchport trunk native vlan
```

```
default switchport trunk native vlan
```

#### Parameters

- **VLAN\_ID** the ID of the native VLAN. Options include
  - **v\_num** VLAN number. Value ranges from 1 to 4094
  - **tag** interface drops all untagged frames.

#### Example

These commands configure **VLAN 100** as the native VLAN for **port channel 21**.

```
switch(config)#interface port-channel 21
switch(config-if-Po21)#switchport trunk native vlan 100
switch(config-if-Po21)#
```

### 11.3.4.30 switchport vlan forwarding

The **switchport vlan forwarding** command forwards packets between the ports belonging to VLAN in the interface configuration mode. The scaling configuration is applicable on a per-port basis. In the 7160 platform, the hardware uses a Port-VLAN table for storing the configuration on a per port/VLAN combination and supports a maximum of 128 ports.

 **Note:** The configuration is applicable to trunk ports only.

#### Command Mode

Interface-Ethernet Configuration

#### Command Syntax

```
switchport vlan forwarding accept | all
```

#### Parameters

- **accept** accepts packets for VLAN
- **all** all VLANs

#### Example

This command forwards and accepts all the packets of VLAN of *interface ethernet 2*.

```
switch(config) #interface ethernet 2
switch(config-if-Et2) #switchport vlan forwarding accept all
switch(config-if-Et2) #
```

---

### 11.3.4.31 switchport vlan translation

The **switchport vlan translation** command allows you to map packets from one VLAN to another using VLAN translation. This is carried out on packets having a dot1q header (tagged frames) only. The translation rewrites the VLAN ID (VID) field in dot1q headers on packets passing through a switched port without changing any other fields.

By default, the translation is bidirectional. The packets ingressing an interface through VLAN A are internally mapped to VLAN B; VLAN B packets egressing the same interface are mapped to VLAN A.

To use VLAN translation on a switched port, the port must be configured as a trunk port using the [switchport mode](#) command.

VLAN translation on routed ports is accomplished through the [encapsulation dot1q vlan](#) command.

The **no switchport vlan translation** and **default switchport vlan translation** commands remove VLAN mapping by removing the switchport vlan translation command from *running-config*.

#### Command Mode

Interface-Ethernet Configuration

Interface-Port-channel Configuration

#### Command Syntax

```
switchport vlan translation [DIRECTION] incoming_vlanid new_vlanid
```

```
no switchport vlan translation incoming_vlanid new_vlanid
```

```
no switchport vlan translation DIRECTION incoming_vlanid
```

```
default switchport vlan translation incoming_vlanid new_vlanid
```

```
default switchport vlan translation DIRECTION incoming_vlanid
```

#### Parameters

- **DIRECTION** direction of traffic to be translated.
  - **no parameter** translates the specified VLAN IDs for transmitted and received traffic.
  - **in** translates the specified VLAN IDs for received traffic only.
  - **out** translates the specified VLAN IDs for transmitted traffic only.
- **incoming\_vlanid** Enter the VLAN ID to be translated. Value ranges from 1 to 4094.
- **new\_vlanid** The new VLAN ID or bridging VLAN ID that will be used internally. Value ranges from 1 to 4094.

#### Example

- These commands translate only incoming packets, changing the VLAN ID to 2008 in the dot1q header of packets ingressing on **VLAN 201**.

```
switch(config)#interface ethernet 5
switch(config-if-Et5)#switchport vlan translation in 201 2008
switch(config-if-Et5)#
```

- These commands translate multiple VLAN mappings on an **interface Ethernet 5**.

```
switch(config)#interface ethernet 5
switch(config-if-Et5)#switchport vlan translation 50 60
switch(config-if-Et5)#switchport vlan translation 61 71
switch(config-if-Et5)#switchport vlan translation 62 72
switch(config-if-Et5)#
```



### 11.3.4.32 trunk group

The **trunk group** command assigns the configuration mode VLAN to a specified trunk group.

A trunk group is the set of physical interfaces that comprise the trunk and the collection of VLANs whose traffic is carried on the trunk. The traffic of a VLAN that belongs to one or more trunk groups is carried only on ports that are members of trunk groups to which the VLAN belongs. Switchport commands specify the physical interfaces that carry trunk group traffic.

The **no trunk group** and **default trunk group** commands remove the configuration mode VLAN from the specified trunk group by removing the corresponding **trunk group** statement from **running-config**. If a trunk group is not specified, the commands remove the configuration mode VLAN from all trunk groups.

#### Command Mode

VLAN Configuration

#### Command Syntax

```
trunk group [name]
```

```
no trunk group [name]
```

```
default trunk group [name]
```

#### Parameters

**name** a name representing the trunk group.

#### Example

These commands assigns **VLAN 49** to the trunk group **mlagpeer**:

```
switch(config)#vlan 49
switch(config-vlan-49)#trunk group mlagpeer
switch(config-vlan-49)#
```

---

## 11.4 DCBX and Flow Control

This section describes Data Center Bridging Capability Exchange (DCBX) configuration tasks. Topics in this section include:

- [Introduction](#)
- [Overview](#)
- [DCBX Configuration and Verification](#)
- [Configuring Priority-Flow-Control \(PFC\)](#)
- [Configuring PFC Watchdog](#)
- [DCBX and Flow Control Commands](#)

### 11.4.1 Introduction

EOS implements Link Layer Discovery Protocol (LLDP) and the Data Center Bridging Capability Exchange (DCBX) protocol to help automate the configuration of Data Center Bridging (DCB) parameters, including the Priority-Based Flow Control (PFC) standard, which allows an end-to-end flow-control feature.

This feature enables a switch to recognize when it is connected to an iSCSI device and automatically configure the switch link parameters (such as priority flow control) to provide optimal support for that device. DCBX can be used to prioritize the handling of iSCSI traffic to help ensure that packets are not dropped or delayed. DCBX is off by default.

### 11.4.2 Overview

#### 11.4.2.1 Data Center Bridging Capability Exchange (DCBX)

DCBX works with LLDP to allow switches to exchange information about their data center bridging (DCB) capabilities and configuration and automatically negotiate common Priority-Based Flow Control (PFC) parameters.

Data is exchanged in Type-Length-Value (TLV) format. For DCBX to function on an interface LLDP must be enabled on that interface as well.

#### 11.4.2.2 Priority-Based Flow Control (PFC)

Priority-Based Flow Control (PFC) uses a new control packet defined in IEEE 802.1Qbb and is not compatible with 802.3x Flow Control (FC). An interface that is configured for PFC will be disabled for FC. When PFC is disabled on an interface, the FC configuration for the interface becomes active. Any FC frames received on a PFC configured interface are ignored.

Each priority is configured as either drop or no-drop. If a priority that is designated as no-drop is congested, the priority is paused. Drop priorities do not participate in pause.

When PFC is disabled, the interface defaults to the IEEE 802.3x flow control setting for the interface. PFC is disabled by default.

#### 11.4.2.3 PFC Watchdog

The PFC watchdog identifies the egress queues that are unable to transmit packets for a long time due to receiving continuous PFC pause frames. On identifying such stuck tx-queue PFC watchdog error-disables the respective port with a error-disable reason of stuck-queue. When there is an error reported on a port the traffic is re-routed through a different port to the destination.

The PFC watchdog supports the following PFC watchdog configurations:

- PFC watchdog forced recovery of queues

- PFC watchdog polling interval configuration
- PFC Watchdog non-disruptive priorities configuration
- Displaying stuck queue and recovery counters

### 11.4.3 DCBX Configuration and Verification

#### 11.4.3.1 Set the Priority Rank to the Traffic Class

The `dcbx application priority` command assigns a priority rank to the specified traffic class in the application priority table. This table is transmitted on each DCBX-enabled interface.

##### Examples

- These commands tell the DCBX peer that iSCSI frames (TCP ports **860** and **3260**) should be assigned the given priority of **5**.

```
switch(config)#dcbx application tcp-sctp 860 priority 5
switch(config)#dcbx application tcp-sctp 3260 priority 5
```

- These commands specify a different priority for the two iSCSI traffic ports.

```
switch(config)# dcbx application tcp-sctp 860 priority 3
switch(config)# dcbx application tcp-sctp 3260 priority 4
```

- This command is equivalent to the `dcbx application tcp-sctp` command. The DCBX peer that iSCSI frames are assigned are the given the priority **5**.

```
switch(config)#dcbx application iscsi priority 5
switch(config)#
```

- These commands prevent the peers from sending anything about the iSCSI frames.

```
switch(config)#no dcbx application tcp-sctp 860 priority 5
switch(config)#no dcbx application tcp-sctp 3260 priority 5
```

#### 11.4.3.2 Configuring CEE DCBX Priority Group

The `priority-flow-control priority` command configures the Enhanced Transmission Selection (ETS) to the specified QoS group, and sets the traffic class priority and the bandwidth percentage for the packets in the traffic class.

##### Examples

- This command configures the ETS to the QoS group map and assigns the CoS map value as **7** and sets traffic class priority to **5**.

```
switch(config)#dcbx ets qos map cos 7 traffic-class 5
```

- This command configures the ETS to the traffic class and sets the traffic class priority as **7** and bandwidth value to **70** percent.

```
switch(config)#dcbx ets traffic-class 7 bandwidth 70
```

#### 11.4.3.3 DCBX Verification

To display the DCBX status and the interfaces on which DCBX is enabled, use the `show dcbx` command.

## Examples

- This command displays the DCBX status for *Ethernet 50*.

```
switch#show dcbx Ethernet 50
Ethernet50:
 IEEE DCBX is enabled and active
 Last LLDPDU received on Thu Feb 14 12:06:01 2013
 No priority flow control configuration TLV received
 No application priority configuration TLV received
switch#
```

## 11.4.4 Configuring Priority-Flow-Control (PFC)

### 11.4.4.1 Enable Priority-Flow-Control (PFC)

The [priority-flow-control](#) command enables Priority-Flow-Control (PFC) on an individual port.

#### Example

The `priority-flow-control` command in DCBX mode enables PFC on an interface.

```
switch(config)#interface ethernet 2
switch(config-if-Et2)#priority-flow-control on
```

### 11.4.4.2 Set the Priority Flow Control Priority

The [priority-flow-control priority](#) command in DCBX mode creates a priority group that pauses priority. Each priority is configured as either drop or no-drop. If a priority that is designated as no-drop is congested, the priority is paused. Drop priorities do not participate in pause.

#### Examples

- The `priority-flow-control priority` command in DCBX mode creates a priority group that pauses priority **5** on *interface Ethernet 2*.

```
switch(config)#interface ethernet 2
switch(config-if-Et2)#priority-flow-control on
switch(config-if-Et2)# priority-flow-control priority 5 no-drop
```

- To enable lossy behavior, use the drop option of the `priority-flow-control priority` command.

```
switch(config)#interface ethernet 2
switch(config-if-Et2)#priority-flow-control on
switch(config-if-Et2)#priority-flow-control priority 5 drop
```

### 11.4.4.3 Disable Priority-Flow-Control (PFC)

To disable priority flow control (PFC) on the configuration mode interface and restore the default packet drop setting on the interface, use the [priority-flow-control priority](#) command.

#### Example

To disable PFC, use the `no priority-flow-control` command.

```
switch (config)#interface ethernet 2
```

```
switch(config-if-Et2) #no priority-flow-control
```

## 11.4.5 Configuring PFC Watchdog

### 11.4.5.1 Enabling PFC Watchdog

The `priority-flow-control pause watchdog default timeout` command starts monitoring all the egress queues which have guaranteed bandwidth enabled and for the priorities on which PFC is enabled.



**Note:** To enable PFC watchdog, user is required to configure guaranteed bandwidth on the tx-queue to be monitored. Also, PFC must be enabled on the port for the traffic flowing into the queue that is being monitored.

#### Example

These commands enable the PFC watchdog monitoring on **tx-queue 3** of **Ethernet 1/1**, and configures a PFC congestion timeout of **10** seconds which error-disables the port if the queue is stuck.

```
switch# config
switch(config)# interface Ethernet1/1
switch(config-if-Et1/1)# priority-flow-control on
switch(config-if-Et1/1)# priority-flow-control priority 3 no-drop
switch(config-if-Et1/1)# tx-queue 3
switch(config-if-Et1/1-txq-3)# bandwidth guaranteed 100
switch(config-if-Et1/1-txq-3)# exit
switch(config-if-Et1/1)# exit
switch(config)# priority-flow-control pause watchdog default timeout 10
```

### 11.4.5.2 Enabling PFC Watchdog Queue Recovery

The `priority-flow-control pause watchdog default recovery-time forced` command recovers a stuck queue after the PFC storm ceases. PFC watchdog supports the following two recovery methods.

- Auto Recovery – recover queue(s) after the PFC storm ceases.
- Forced Recovery – recover queue(s) after a fixed duration, irrespective of PFC storm being received.



**Note:** The default recovery mode is “auto”.

#### Example

This command recovers a stuck queue after a fixed duration of **10** seconds.

```
switch(config)# priority-flow-control pause watchdog default recovery-time 10 forced
```

### 11.4.5.3 Configuring PFC Watchdog Polling Interval

The `priority-flow-control pause watchdog default polling-interval` command configures the frequency at which queues should be checked for stuck or recovery detection. By default, polling interval is calculated internally or it considers the value configured through CLI.



**Note:** Configuring a very low polling interval may increase load on the CPU.

## Example

This command configures a polling interval of **10** seconds on the switch.

```
switch(config) # priority-flow-control pause watchdog default polling-
interval 10
```

### 11.4.5.4 Displaying Stuck Queue and Recovery Counters

The `show priority-flow-control counters watchdog` command displays the value of number of times a queue is identified as stuck and recovered. These counters are maintained only for those queues that have PFC watchdog functionality enabled. These counters are cleared when either PFC or PFC watchdog configuration is disabled. Alternatively, `show interfaces priority-flow-control counters watchdog` command can be used to display the counters.

## Example

- This command displays the value of number of times the queue was stuck and recovered for all the interfaces.

```
switch#show priority-flow-control counters watchdog
Port TxQ Total times Total times
 stuck recovered

Et1/1 UC2 2 2
Et1/1 UC3 3 3
Et2/1 UC2 12 12
Et2/1 UC3 31 30
```

- This command displays the value of number of times the queue was stuck and recovered for a specific interface. In this case it is **Et1/1**.

```
switch#show priority-flow-control interfaces Ethernet 1/1 counters
watchdog
Port TxQ Total times Total times
 stuck recovered

Et1/1 UC2 2 2
Et1/1 UC3 3 3
```

### 11.4.5.5 PFC Watchdog Non-disruptive Priorities

The PFC Watchdog acts to drop the traffic entering or leaving the port at the stuck PFC priority. Later when the queue recovers, this action is reversed. While applying these actions, some traffic (for all priorities) is dropped on that port. In such case, the `priority-flow-control pause watchdog hardware non-disruptive priority` command can be used to avoid the traffic drop on ports at stuck queues.

This traffic drop can be avoided by configuring specific PFC priorities as non-disruptive. When queues corresponding to these priorities are stuck/recovered, the traffic for other priorities are not impacted.

## Example

- This command configures the specific PFC priorities as non-disruptive, and the priority is set to **3**.

```
switch(config) #priority-flow-control pause watchdog hardware non-
disruptive priority 3
```

- This command configures all the ports, having a subset of non-disruptive priorities as a part of their no-drop priorities, start in non-disruptive mode.

```
switch(config)#priority-flow-control pause watchdog hardware port non-disruptive-only
```

#### 11.4.5.6 Displaying PFC Watchdog Information

The `show priority-flow-control` command displays the PFC watchdog status information. Note, if the PFC watchdog default timeout value is non-zero then PFC watchdog is active on the switch.

##### Example

This command displays the PFC watchdog default timeout value, in this show example the timeout value is **3.0** which means the PFC watchdog is active.

```
switch#show priority-flow-control
The hardware supports PFC on priorities 0 1 2 3 4 5 6 7
The PFC watchdog default timeout is 3.0

Port Enabled Priorities Active Note
Et1/1 Yes 34 Yes DCBX disabled
Et1/2 Yes 34 Yes DCBX disabled
Et1/3 Yes 34 Yes DCBX disabled
Et1/4 Yes 34 Yes DCBX disabled
```

The `show interface status errdisabled` command displays the port which is error-disabled due to stuck-queue condition.

##### Example

This command displays the interface Ethernet **Eth1/1** status as errdisabled and the reason.

```
switch#show interface Eth1/1 status errdisabled

Port Name Status Reason

Et1/1 errdisabled stuck-queue
```

The `show priority-flow-control status` command displays the current PFC watchdog details.

##### Example

This command displays the PFC watchdog configuration details at global and interface level.

```
switch#show priority-flow-control status
The hardware supports PFC on priorities 0 1 2 3 4 5 6 7
The PFC watchdog timeout is 1.0 second(s)
The PFC watchdog recovery-time is 2.0 second(s) (auto)
The PFC watchdog polling-interval is 0.1 second(s)
The PFC watchdog non-disruptive priorities are 3 4
The PFC watchdog port non-disruptive-only is False

E: PFC Enabled, D: PFC Disabled, A: PFC Active, W: PFC Watchdog Enabled
Port Status Priorities Note
Et1/1 E A W 1 7 DCBX disabled
Et1/2 E A - - - DCBX disabled
Et1/3 D - - - -
```

---

```
Et1/4 D - -
Et2/1 D - -
..
..
```



## 11.4.6 DCBX and Flow Control Commands

### Configuration Commands

- `dcbx application priority`
- `dcbx ets`
- `dcbx mode`
- `no priority-flow-control`
- `platform fm6000 pfc-wm`
- `priority-flow-control`
- `priority-flow-control pause watchdog action`
- `priority-flow-control pause watchdog default`
- `priority-flow-control pause watchdog hardware`
- `priority-flow-control priority`

### Show Commands

- `show dcbx`
- `show dcbx application-priority-configuration`
- `show dcbx priority-flow-control-configuration`
- `show dcbx status`
- `show interfaces priority-flow-control`
- `show platform fm6000 pfc-wm`
- `show priority-flow-control`

### 11.4.6.1 dcbx application priority

The **dcbx application priority** command assigns a priority rank to the specified traffic class in the application priority table. This table is transmitted on each DCBX-enabled interface.

The **no dcbx application priority** and **default dcbx application priority** commands remove the specified DCBX traffic class priority assignment by deleting the corresponding **dcbx application priority** command from *running-config*. When the command does not specify a traffic class, all DCBX traffic class priority assignments are removed.

#### Command Mode

Global Configuration

#### Command Syntax

```
dcbx application [APPLICATION_TYPE priority] rank
```

```
no dcbx application [APPLICATION_TYPE priority]
```

```
default dcbx application [APPLICATION_TYPE priority]
```

#### Parameters

- **APPLICATION\_TYPE** traffic class receiving the priority assignment. Options include:
  - **ether *ethertype\_number*** Ethernet traffic. *ethertype\_number* varies from 1536 to 65535.
  - **iscsi** iSCSI traffic. Maps to TCP/SCTP ports 860 and 3260.
  - **tcp-sctp *port\_number*** TCP/SCTP traffic. Port number varies from 1 to 65535.
  - **tcp-sctp-udp *port\_number*** TCP/SCTP/UDP traffic. Port number varies from 1 to 65535.
  - **udp *port\_number*** UDP traffic. Port number varies from 1 to 65535.
- **rank** priority assigned to traffic class. Values range from 0 to 7.

#### Examples

- These commands tell the DCBX peer that iSCSI frames (TCP ports 860 and 3260) should be assigned the given priority of **5**.

```
switch(config)#dcbx application tcp-sctp 860 priority 5
switch(config)#dcbx application tcp-sctp 3260 priority 5
```

- These commands specify a different priority for the two iSCSI traffic ports.

```
switch(config)#dcbx application tcp-sctp 860 priority 3
switch(config)#dcbx application tcp-sctp 3260 priority 4
```

- This command is equivalent to the **dcbx application tcp-sctp** command. The DCBX peer that iSCSI frames are assigned to is given priority **5**.

```
switch(config)#dcbx application iscsi priority 5
switch(config)#
```

- These commands prevent the peers from sending anything about the iSCSI frames.

```
switch(config)#no dcbx application tcp-sctp 860 priority
switch(config)#no dcbx application tcp-sctp 3260 priority
```

### 11.4.6.2 dcbx ets

The **dcbx ets** command configures the enhanced transmission selection (ETS) to the specified QoS group, and sets the traffic class priority and the bandwidth percentage for the packets in the traffic class.

The **no dcbx ets** and **default dcbx ets** commands remove the specified DCBX traffic class priority assignment by deleting the corresponding **dcbx ets** command from the **running-config**.

#### Command Mode

Global Configuration

#### Command Syntax

```
dcbx ets [qos map cos value traffic-class value | traffic-class value bandwidth value]
```

```
no dcbx ets [qos map cos value traffic-class value | traffic-class value bandwidth value]
```

```
default dcbx ets [qos map cos value traffic-class value | traffic-class value bandwidth value]
```

#### Parameters

- **qos** QoS to configure. (The sub options include)
  - **map** QoS map to configure.
  - **cos** CoS value assigned to port. Value ranges from 0 to 7. Default value is 0.
  - **traffic-class** Assigns the traffic-class priority to the QoS map. The value ranges from 0 to 7.
- **traffic-class** Assigns the traffic class priority. The value ranges from 0 to 7. (The sub options include)
  - **bandwidth** The percentage of bandwidth assigned to the packets received from traffic class. The value ranges from 0 to 100 in percentage. The default value is 0.

#### Examples

- This command configures the ETS to the QoS group map and assigns the CoS map value as **7** and sets the traffic class priority to **5**.

```
switch(config)#dcbx ets qos map cos 7 traffic-class 5
```

- This command configures the ETS to the traffic class and sets the traffic class priority value to **7** and sets the bandwidth value to **70** percent.

```
switch(config)#dcbx ets traffic-class 7 bandwidth 70
```

---

### 11.4.6.3 dcbx mode

The **dcbx mode** command enables DCBX mode on the configuration mode interface. The switch supports IEEE P802.1Qaz. When DCBX is enabled, two TLVs are added to outgoing LLDPDUs, which instruct the peer on the interface to configure PFC (priority flow control) and the application priority table in the same way as the switch.

The **no dcbx mode**, **default dcbx mode**, and **dcbx mode none** commands disable DCBX on the configuration mode interface by removing the corresponding **dcbx mode** command from **running-config**.

#### Command Mode

Interface-Ethernet Configuration

#### Command Syntax

```
dcbx mode MODE_NAME
```

```
no dcbx mode
```

```
default dcbx mode
```

#### Parameters

- **MODE\_NAME** Specifies the DCBX version. Options include:
  - **ieee** IEEE version.
  - **cee** Converged Enhanced Ethernet version.
  - **none** DCBX is disabled.

#### Examples

- These commands enable **interface Ethernet 2** to use IEEE DCBX.

```
switch(config)#interface ethernet 2
switch(config-if-Et2)#dcbx mode ieee
switch(config-if-Et2)#
```

- These commands disable DCBX on **interface Ethernet 2**.

```
switch(config)#interface ethernet 2
switch(config-if-Et2)#dcbx mode none
switch(config-if-Et2)
```

#### 11.4.6.4 no priority-flow-control

The `no priority-flow-control` and `default priority-flow-control` commands disable the priority flow control (PFC) on the configuration mode interface and restore the default packet drop setting on the interface, which takes effect when PFC is re-enabled. The commands delete all corresponding `priority-flow-control` commands from *running-config*.

##### Command Mode

Interface-Ethernet Configuration

##### Command Syntax

```
no priority-flow-control
default priority-flow-control
```

##### Example

These commands disable priority flow control (PFC) on *interface Ethernet 3*.

```
switch(config) #interface Ethernet 3
switch(config-if-Et3) #no priority-flow-control
switch(config-if-Et3) #
```

---

### 11.4.6.5 platform fm6000 pfc-wm

The `platform fm6000 pfc-wm` command configures the hardware buffer space allocated to the PFC (Priority Flow Control) RX-Private buffer. The command provides options to configure the buffer size and specify when PFC frames are sent to request that a neighbor stop sending traffic. The default values are as follows:

- **RX-Private:** 18400 bytes
- **on (watermark):** 9280 bytes
- **off (watermark):** 1600 bytes

Values that are entered in the command are rounded up to the closest multiple of 160. The **RX-Private** value must be greater than the **off** value, which must be larger than the **on** value.

The `no platform fm6000 pfc-wm` and `default platform fm6000 pfc-wm` commands restore the default settings by removing the `platform fm6000 pfc-wm` command from *running-config*.

#### Command Mode

Global Configuration

#### Command Syntax

```
platform fm6000 pfc-wm [RX-PRIVATE_SIZE][PFC-ON_WM][PFC-OFF_WM]
no platform fm6000 pfc-wm
default platform fm6000 pfc-wm
```

The `platform fm6000 pfc-wm` command must explicitly configure at least one parameter.

#### Parameters

- **RX-PRIVATE\_SIZE** Specifies size of rx-private buffer. Options include:
  - **no parameter** rx-private buffer retains previously configured size.
  - **rx-private 18268 to 102400** Size of rx-private buffer (bytes).
- **PFC-ON\_WM** Buffer capacity that triggers the switch to send PFC frames. Options include:
  - **no parameter** Parameter retains previously configured value.
  - **on 9134 to 102400** Buffer capacity that triggers PFC frames (bytes).
- **PFC-OFF\_WM** Buffer capacity that triggers the switch to stop PFC frame transmissions. Options include:
  - **no parameter** Parameter retains previously configured value.
  - **off 1536 to 102400** Buffer capacity that turns off PFC frames.

#### Related Command

[show platform fm6000 pfc-wm](#) displays the PFC RX-Private buffer memory allocations.

#### Example

This command configures the rx-private hardware buffer.

```
switch(config) #platform fm6000 pfc-wm rx-private 24800 on 16000 off 3200
switch(config) #
```

### 11.4.6.6 priority-flow-control pause watchdog action

The **priority-flow-control pause watchdog** action command either drops the traffic on a stuck queue, or error disables the port which has a stuck queue, or notifies if there is no action on the stuck queue. The following actions are performed based on the queue status.

The **no priority-flow-control pause watchdog** action command removes the specified **priority-flow-control pause watchdog action configuration** by deleting the corresponding **priority-flow-control pause watchdog action** command from **running-config**.

#### Command Mode

Global Configuration

#### Command Syntax

```
priority-flow-control pause watchdog action
no priority-flow-control pause watchdog action
```

#### Parameters

- **action** PFC watchdog action for stuck transmit queues. Options include.
  - **drop** Drop traffic on the stuck queue.
  - **errdisable** Error disable port which has the stuck transmit queue.
  - **notify-only** No action on the stuck queue.

#### Guidelines

Before enabling the PFC watchdog configuration, configure the guaranteed bandwidth on the tx-queue to be monitored. Also, enable the PFC on the port for the PFC priorities for the traffic flowing into the queue that is being monitored.

#### Example

These commands enables the pfc-watchdog monitoring on **tx-queue 3** of **Ethernet 1/1**, and configures a PFC watchdog action drop and drops the traffic if the queue is a stuck queue.

```
switch#config
switch(config)#interface Ethernet1/1
switch(config-if-Et1/1)#priority-flow-control on
switch(config-if-Et1/1)#priority-flow-control priority 3 no-drop
switch(config-if-Et1/1)#tx-queue 3
switch(config-if-Et1/1-txq-3)#bandwidth guaranteed 100
switch(config-if-Et1/1-txq-3)#exit
switch(config-if-Et1/1)#exit
switch(config)#priority-flow-control pause watchdog action drop
```

---

### 11.4.6.7 priority-flow-control pause watchdog default

The **priority-flow-control pause watchdog** default command monitors all the egress queues which have guaranteed bandwidth enabled and for the priorities on which PFC is enabled. Guaranteed bandwidth is needed to ensure starvation due to higher priority traffic is not wrongly flagged as a stuck-queue due to congestion. The stuck duration after which the port needs to be error disabled is also configurable.

The **no priority-flow-control pause watchdog default** command removes the specified **priority-flow-control pause watchdog configuration** by deleting the corresponding **priority-flow-control pause watchdog** command from *running-config*.

#### Command Mode

Global Configuration

#### Command Syntax

```
priority-flow-control pause watchdog default
no priority-flow-control pause watchdog default
```

#### Parameters

- **default** Specifies the default value. Options include.
  - **polling-interval** Configures the interval at which the watchdog should poll the queues. The polling interval value ranges from 0.005 to 30 seconds.
  - **recovery-time** Configures recovery-time after which stuck queue should recover and start forwarding. The recovery-time value ranges from 0.01 to 60 seconds.
    - **forced** Force recover any stuck queue(s) after the recovery-time interval, irrespective of whether PFC frames are being received or not.
  - **timeout** Configures timeout after which port should be errdisabled or should start dropping on congested priorities. The timeout value ranges from 0.01 to 60 seconds.

#### Guidelines

Before enabling the PFC watchdog configuration, configure the guaranteed bandwidth on the tx-queue to be monitored. Also, enable the PFC on the port for the PFC priorities for the traffic flowing into the queue that is being monitored.

- Polling Interval Discrepancy

For user configured polling-interval to be valid, it must satisfy the following conditions

When the recovery-mode is auto and timeout, recovery-time, and polling-interval are non-default,  $\text{polling-interval} \leq \min(\text{timeout}, \text{recovery-time}) / 2$ ,

When recovery-mode is forced or recovery-time is not configured,  $\text{polling-interval} \leq (\text{timeout} / 2)$

For better functioning of PFC Watchdog, when user configured polling interval is too large compared to either timeout or recovery time values, Watchdog will use auto calculated value instead of user configured value until the discrepancy is resolved. Also, CLI warning and syslog messages are generated to inform user of the discrepancy.

- CLI Warnings

When there is discrepancy between timeout and polling-interval, the format of the message is as shown below:

```
! User configured polling interval <user-cfgd polling-interval>
second(s) is
greater than half of timeout <user-cfgd timeout> second(s). Setting
```



```
polling-interval to <to-be-used polling-interval> second(s)
```

When there is discrepancy between recovery-time and polling-interval, the format of the message is as shown below

```
! User configured polling interval <user-cfgd polling-interval>
second(s) is
greater than half of recovery-time <user-cfgd recovery-time> second(s).
Setting
polling-interval to <to-be-used polling-interval> second(s)
```

### Examples

- These commands enable the pfc-watchdog monitoring on tx-queue **3** of **Ethernet 1/1**, and configures a PFC congestion timeout of **10** seconds which error-disables the port if the queue is stuck.

```
switch#config
switch(config)#interface Ethernet1/1
switch(config-if-Et1/1)#priority-flow-control on
switch(config-if-Et1/1)#priority-flow-control priority 3 no-drop
switch(config-if-Et1/1)#tx-queue 3
switch(config-if-Et1/1-txq-3)#bandwidth guaranteed 100
switch(config-if-Et1/1-txq-3)#exit
switch(config-if-Et1/1)#exit
switch(config)#priority-flow-control pause watchdog default timeout 10
```

- These commands enable the pfc-watchdog monitoring on tx-queue **3** of **Ethernet 1/1**, and configures a PFC forced recovery-time interval of **30** seconds after which the stuck queue(s) are recovered, irrespective of whether PFC frames are being received or not.

```
switch#config
switch(config)#interface Ethernet1/1
switch(config-if-Et1/1)#priority-flow-control on
switch(config-if-Et1/1)#priority-flow-control priority 3 no-drop
switch(config-if-Et1/1)#tx-queue 3
switch(config-if-Et1/1-txq-3)#bandwidth guaranteed 100
switch(config-if-Et1/1-txq-3)#exit
switch(config-if-Et1/1)#exit
switch(config)#priority-flow-control pause watchdog default recovery-
time 30 forced
```

- These commands enable the pfc-watchdog monitoring on tx-queue **3** of **Ethernet 1/1**, and configures a PFC polling-interval of **20** seconds after which queue is polled.

```
switch#config
switch(config)#interface Ethernet1/1
switch(config-if-Et1/1)#priority-flow-control on
switch(config-if-Et1/1)#priority-flow-control priority 3 no-drop
switch(config-if-Et1/1)#tx-queue 3
switch(config-if-Et1/1-txq-3)#bandwidth guaranteed 100
switch(config-if-Et1/1-txq-3)#exit
switch(config-if-Et1/1)#exit
switch(config)#priority-flow-control pause watchdog default polling-
interval 20
```

---

### 11.4.6.8 priority-flow-control pause watchdog hardware

The **priority-flow-control pause watchdog hardware** command configures specific PFC priorities as non-disruptive. This will avoid traffic drop on queues corresponding to these priorities are stuck/recovered, the traffic for other priorities are not impacted.

The **no priority-flow-control pause watchdog hardware** command removes the specified **priority-flow-control pause watchdog non-disruptive configuration** by deleting the corresponding **priority-flow-control pause watchdog hardware** command from *running-config*.

#### Command Mode

Global Configuration

#### Command Syntax

```
priority-flow-control pause watchdog hardware
```

```
no priority-flow-control pause watchdog hardware
```

#### Parameters

- **hardware** Configure PFC priority through hardware. Options include.
  - **non-disruptive** PFC watchdog non-disruptive configuration. The priority value ranges from 0 to 7.

#### Guidelines

Before enabling the PFC watchdog configuration, configure the guaranteed bandwidth on the tx-queue to be monitored. Also, enable the PFC on the port for the PFC priorities for the traffic flowing into the queue that is being monitored.

#### Example

These commands enable the pfc-watchdog monitoring on tx-queue **3** of **Ethernet 1/1**, and configures PFC priorities as non-disruptive on PFC priorities **3** and **4**.

```
switch#config
switch(config)#interface Ethernet1/1
switch(config-if-Et1/1)#priority-flow-control on
switch(config-if-Et1/1)#priority-flow-control priority 3 no-drop
switch(config-if-Et1/1)#tx-queue 3
switch(config-if-Et1/1-txq-3)#bandwidth guaranteed 100
switch(config-if-Et1/1-txq-3)#exit
switch(config-if-Et1/1)#exit
switch(config)#priority-flow-control pause watchdog hardware non-
disruptive priority 3 4
```

### 11.4.6.9 priority-flow-control priority

The **priority-flow-control priority** command configures the packet resolution setting on the configuration mode interface. This setting determines if packets are dropped when priority flow control (PFC) is enabled on the interface. Packets are dropped by default.

The **no priority-flow-control priority** and **default priority-flow-control priority** commands restore the default packet drop setting on the configuration mode interface by deleting the corresponding **priority-flow-control priority** command from **running-config**. The **priority-flow-control priority** command also restores the default setting on the configuration mode interface.

#### Command Mode

Interface-Ethernet Configuration

#### Command Syntax

```
priority-flow-control priority pack-drop
no priority-flow-control priority
default priority-flow-control priority
```

#### Parameters

- **pack-drop** denotes the interfaces. Options include:
  - **drop** Packets are dropped. Default setting.
  - **no drop** Packets are not dropped.

#### Examples

- These commands in DCBX mode create a priority group that pauses dot1p priority **5** on **Ethernet 2**.

```
switch(config)#interface ethernet 2
switch(config-if-Et2)#priority-flow-control on
switch(config-if-Et2)#priority-flow-control priority 5 no-drop
```

- These commands enable lossy behavior.

```
switch(config)#interface ethernet 2
switch(config-if-Et2)#priority-flow-control on
switch(config-if-Et2)#priority-flow-control priority 5 drop
```

- These commands remove the priority group that pauses dot1p priority **5** on **Ethernet 2**.

```
switch(config)#interface ethernet 2
switch(config-if-Et2)#priority-flow-control on
switch(config-if-Et2)#no priority-flow-control priority
```

---

#### 11.4.6.10 priority-flow-control

The **priority-flow-control** command enables priority flow control (PFC) on the configuration mode interface to pause selected traffic classes.

The **no priority-flow-control** and **default priority-flow-control** commands disable PFC on the configuration mode interface by deleting the corresponding **priority-flow-control** command from **running-config**. The **priority-flow-control priority** command also disables PFC on the configuration mode interface.

##### Command Mode

Interface-Ethernet Configuration

##### Command Syntax

```
priority-flow-control on
no priority-flow-control on
default priority-flow-control on
```

##### Example

- These commands enable PFC on **interface Ethernet 3**.

```
switch(config)#interface Ethernet 3
switch(config-if-Et3)#priority-flow-control on
switch(config-if-Et3)#
```

- These commands disable PFC on **interface Ethernet 3**.

```
switch(config)#interface Ethernet 3
switch(config-if-Et3)#no priority-flow-control
switch(config-if-Et3)#
```

### 11.4.6.11 show dcbx application-priority-configuration

The `show dcbx application-priority-configuration` command displays the DCBX peer application priority configuration.

#### Command Mode

EXEC

#### Command Syntax

```
show dcbx [INTERFACE] application-priority-configuration
```

#### Parameters

- **INTERFACE** Interface type and number. Options include:
  - *no parameter* All configured DCBX interfaces.
  - **ethernet e-num** Ethernet interface specified by *e-num*.

#### Guidelines

This command and the [show priority-flow-control](#) command function identically.

#### Example

This command displays the DCBX peer application priority configuration for all DCBX-enabled interfaces.

```
switch#show dcbx application-priority-configuration
Ethernet1:
 Last LLDPDU received on Thu Feb 14 10:52:20 2013
 No application priority configuration TLV received
Ethernet2:
 Last LLDPDU received on Thu Feb 14 10:52:20 2013
 No application priority configuration TLV received
...
Ethernet50:
 Last LLDPDU received on Thu Feb 14 12:08:29 2013
 - Application priority configuration:
 2 application priorities configured:
 tcp-sctp 860 priority 5
 tcp-sctp 3260 priority 5
switch#
```

---

### 11.4.6.12 show dcbx priority-flow-control-configuration

The **show dcbx priority-flow-control-configuration** command displays the IEEE DCBX peer priority flow control configurations.

#### Command Mode

EXEC

#### Command Syntax

```
show dcbx [INTERFACE] priority-flow-control-configuration
```

#### Parameters

- **INTERFACE** Interface type and number. Options include:
  - **no parameter** all configured DCBX interfaces.
  - **ethernet e-num** Ethernet interface specified by **e-num**.

#### Example

This command displays the DCBX peer priority flow control configuration for the DCBX-enabled interfaces on the device.

```
switch#show dcbx priority-flow-control-configuration
Ethernet1:
 Last LLDPDU received on Thu Feb 14 10:52:20 2013
 No priority flow control configuration TLV received
Ethernet2:
 Last LLDPDU received on Thu Feb 14 10:52:20 2013
 No priority flow control configuration TLV received
...
Ethernet50:
 Last LLDPDU received on Thu Feb 14 12:11:29 2013
 - PFC configuration: willing
 not capable of bypassing MACsec
 supports PFC on up to 4 traffic classes
 PFC enabled on priorities: 5 7
 WARNING: peer PFC configuration does not match the local PFC
 configuration
switch#
```

### 11.4.6.13 show dcbx status

The `show dcbx status` command displays the DCBX status on the interfaces on which DCBX is enabled.

#### Command Mode

EXEC

#### Command Syntax

```
show dcbx [INTERFACE] status
```

#### Parameters

- **INTERFACE** Interface type and number. Options include:
  - *no parameter* all configured DCBX interfaces.
  - **ethernet e-num** Ethernet interface specified by *e-num*.

#### Example

This command displays the DCBX status for the DCBX-enabled interfaces.

```
switch#show dcbx status
Ethernet1:
 Last LLDPDU received on Thu Feb 14 10:52:20 2013
Ethernet2:
 Last LLDPDU received on Thu Feb 14 10:52:20 2013
Ethernet50:
 IEEE DCBX is enabled and active
 Last LLDPDU received on Thu Feb 14 12:11:54 2013
switch#
```

---

#### 11.4.6.14 show dcbx

The **show dcbx** command list DCBX status and the interfaces on which DCBX is enabled.

##### Command Mode

EXEC

##### Command Syntax

```
show dcbx [INTERFACE]
```

##### Parameters

- **INTERFACE** Interface type and number. Options include:
  - **no parameter** all configured DCBX interfaces.
  - **ethernet e-num** Ethernet interface specified by **e-num**.

##### Examples

- This command displays the DCBX status for **Ethernet 50**.

```
switch#show dcbx Ethernet 50
Ethernet50:
 IEEE DCBX is enabled and active
 Last LLDPDU received on Thu Feb 14 12:06:01 2013
 No priority flow control configuration TLV received
 No application priority configuration TLV received
switch#
```

- This command displays the DCBX status for **Ethernet 50** when Priority Flow Control (PFC) is not enabled.

```
switch#show dcbx Ethernet 50
Ethernet50:
 IEEE DCBX is enabled and active
 Last LLDPDU received on Thu Feb 14 12:08:29 2013
 - PFC configuration: willing
 not capable of bypassing MACsec
 supports PFC on up to 4 traffic classes
 PFC enabled on priorities: 5 7
 WARNING: peer PFC configuration does not match the local PFC
configuration
 - Application priority configuration:
 2 application priorities configured:
 tcp-sctp 860 priority 5
 tcp-sctp 3260 priority 5
switch#
```



### 11.4.6.15 show interfaces priority-flow-control

The `show interfaces priority-flow-control` command displays the status of PFC on all interfaces.

#### Command Mode

EXEC

#### Command Syntax

```
show interfaces [INTERFACE] priority-flow-control [INFO_LEVEL]
```

#### Parameters

- **INTERFACE** Interface type and numbers. Options include:
  - *no parameter* Display information for all interfaces.
  - **ethernet e\_range** Ethernet interface range specified by *e\_range*.
  - **loopback l\_range** Loopback interface specified by *l\_range*.
  - **management m\_range** Management interface range specified by *m\_range*.
  - **port-channel p\_range** Port-Channel Interface range specified by *p\_range*.
  - **vlan v\_range** VLAN interface range specified by *v\_range*.
  - **vxlan vx\_range** VXLAN interface range specified by *vx\_range*.

Valid range formats include number, number range, or comma-delimited list of numbers and ranges.
- **INFO\_LEVEL** specifies the type of information displayed. Options include:
  - *no parameter* Displays information about all DCBX neighbor interfaces.
  - **status** Displays the DCBX status.
  - **counters** Displays the DCBX counters.

#### Guidelines

This command and the [show priority-flow-control](#) command function identically.

#### Example

This command displays the PFC for all interfaces.

```
switch#show interfaces priority-flow-control
The hardware supports PFC on priorities 0 1 2 3 4 5 6 7

Port Enabled Priorities Active Note
Et1 No
Et2 No
...
Et50 Yes 5 Yes

...
Port RxFc TxPfc
Et1 0 0
Et2 0 0
...
Et50 0 0
...
switch#
```

---

#### 11.4.6.16 show platform fm6000 pfc-wm

The **show platform fm6000 pfc-wm** command displays the buffer space allocated to the RX-Private buffer and buffer levels that trigger PFC frame transmission activities.

##### Command Mode

Privileged EXEC

##### Command Syntax

```
show platform fm6000 pfc-wm
```

##### Related Command

[priority-flow-control priority](#) specifies the PFC RX-Private buffer memory allocation.

##### Example

This command displays the rx-private hardware buffer memory allocation.

```
switch#show platform fm6000 pfc-wm
Pfc_Rx_Private_WM: 24800 Bytes
Pfc_On_WM: 16000 Bytes
Pfc_Off_WM: 3200 Bytes
switch#
```

### 11.4.6.17 show priority-flow-control

The **show priority-flow-control** command displays the status and other PFC and PFC watchdog information on all interfaces if no specific interface is specified.

#### Command Mode

EXEC

#### Command Syntax

```
show priority-flow-control [status | counters | interfaces]
```

#### Parameters

- **interfaces** specifies the interface for which the information is displayed. Options include.
  - **Ethernet** Hardware Ethernet interface
  - **Loopback** Loopback interface
  - **Management** Management interface
  - **Port-Channel** Lag interface
  - **Recirc-Channel** Recirculation interface
  - **Tunnel** Tunnel interface
  - **Vlan** VLAN interface
  - **Vxlan** Vxlan Tunnel Interface
- **status** displays the interface PFC status.
- **counters** displays the interface PFC counters. Options include.
  - **detail** displays the DCBX counters for each priority class. This option is available only on Trident switches.
  - **watchdog** displays the PFC watchdog counters.

#### Examples

- This command displays the PFC status on all interfaces.

```
switch#show priority-flow-control
The hardware supports PFC on priorities 0 1 2 3 4 5 6 7
Port Enabled Priorities Active Note

Et1 No No

Et2 No No

...
Et50 Yes 5 Yes

...
Port RxPfc TxPfc
Et1 0 0
Et2 0 0
...
Et50 0 0
...
```

- This command displays the PFC watchdog status. If PFC watchdog default timeout is non-zero (in this case it is 3.0) then PFC watchdog is actively running on the switch.

```
switch# show priority-flow-control
The hardware supports PFC on priorities 0 1 2 3 4 5 6 7
The PFC watchdog default timeout is 3.0

Port Enabled Priorities Active Note
```

|       |     |    |     |               |
|-------|-----|----|-----|---------------|
| Et1/1 | Yes | 34 | Yes | DCBX disabled |
| Et1/2 | Yes | 34 | Yes | DCBX disabled |
| Et1/3 | Yes | 34 | Yes | DCBX disabled |
| Et1/4 | Yes | 34 | Yes | DCBX disabled |
| ...   |     |    |     |               |

- This command displays the current value of these counters for all the interfaces being monitored by PFC watchdog. Alternatively, show interfaces priority-flow-control counters watchdog command can be used for the same.

```
switch #show priority-flow-control counters watchdog
Port TxQ Total times Total times
 stuck recovered

Et1/1 UC2 2 2
Et1/1 UC3 3 3
Et2/1 UC2 12 12
Et2/1 UC3 31 30
```

- This command displays the current value of these counters for a specific subset of interfaces. Alternatively, show interfaces <name> priority-flow-control counters watchdog command can be used for the same.

```
switch #show priority-flow-control interfaces Ethernet 1/1 counters
watchdog
Port TxQ Total times Total times
 stuck recovered

Et1/1 UC2 2 2
Et1/1 UC3 3 3
```

- This command displays the configuration details of PFC watchdog at global and interface level.

```
switch #show priority-flow-control status
The hardware supports PFC on priorities 0 1 2 3 4 5 6 7
The PFC watchdog timeout is 1.0 second(s)
The PFC watchdog recovery-time is 2.0 second(s) (auto)
The PFC watchdog polling-interval is 0.1 second(s)
The PFC watchdog non-disruptive priorities are 3 4
The PFC watchdog port non-disruptive-only is False

E: PFC Enabled, D: PFC Disabled, A: PFC Active, W: PFC Watchdog Enabled
Port Status Priorities Note
Et1/1 E A W 1 7 DCBX disabled
Et1/2 E A - - - DCBX disabled
Et1/3 D - - - -
Et1/4 D - - - -
Et2/1 D - - - -
..
```

## 11.5 IP Locking

This section describes IP Locking configuration tasks. Topics in this section include:

- [Release Updates](#)
- [Platform Compatibility](#)
- [IPv4 Locking Configuration Commands](#)
- [IPv6 Locking Configuration Commands](#)
- [Show Commands](#)
- [Limitations](#)
- [IP Locking Commands](#)

## 11.5.1 IP Locking

IP Locking is an EOS feature configured on an Ethernet Layer 2 port.

When enabled, IP Locking ensures that a port will only permit IP and ARP packets with IP source addresses that have been authorized. As of the **EOS Release 4.25.0F** release update, IP locking can run in two modes - IPv4 Locking (which will be referred to as IP Locking) and IPv6 Locking, which is configured using the commands mentioned in the following sections. IP Locking prevents another host on a different interface from claiming ownership of an IP address through ARP spoofing. IPv6 Locking extends this behavior to IPv6 packets, including ICMPv6 Neighbor Discovery (Router Advertisement, Redirect) and DHCP (server-to-client) packets. Mode specific commands are also discussed.

On an IP Locked Port,

- ARP probes with **0.0.0.0** as Sender Protocol Address (SPA) and is allowed for duplicate address detection (DAD).
- Incoming DHCP server response packets are dropped to avoid rogue device(s) acting as DHCP server(s).
- Incoming DHCP client request packets are allowed for devices to complete DHCP handshake and obtain DHCP leases.

On an IPv6 Locked Port,

- Incoming DHCPv6 server response packets are dropped and incoming DHCPv6 client request packets are allowed.
- Incoming ICMPv6 ND : Router Advertisement packets are dropped as only routers should send these packets.
- Incoming ICMPv6 ND : Router Solicitation packets are allowed.
- Incoming ICMPv6 ND : Redirect packets are dropped as only routers should send these packets.

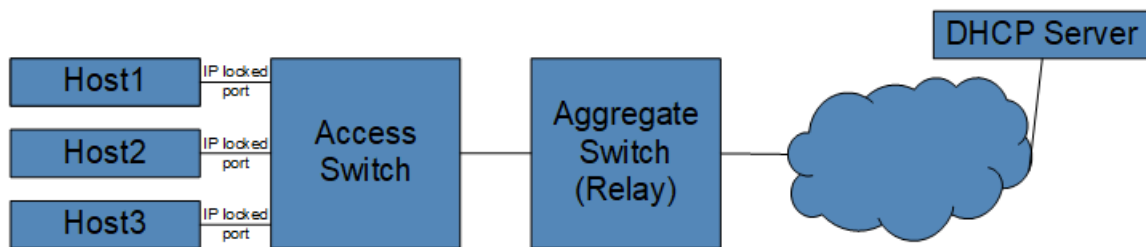

IP Locking relies on DHCP LeaseQuery (**RFC4388**) and MAC address learning to determine that an IP address has been authorized on a particular port. It is necessary to ensure that DHCP servers used in the network allow LeaseQuery messages.

### 11.5.1.1 Release Updates

Refer to the release updates for IP Locking.

#### **EOS Release 4.25.1F:**

Added support for disabling address filtering for IPv6 packets while still keeping all packet type specific drop rules such as ICMPv6 ND:RA, and ICMPv6 ND:Redirect and DHCPv6 (server-to-client) packets, using the `locked-address ipv6 enforcement disabled` command.

#### **EOS Release 4.24.0F:**

- Added support for expiration modes of locked addresses, using the `locked-address expiration mac disabled` command.
- Added support for counters, using the `show address locking counters` and `clear address locking counters` commands.

#### **EOS Release 4.23.2F:**

Added support for `static lease` command, `lease <V4ADDR> mac <MACADDR>`.

#### **EOS Release 4.23.1F:**

Added support for `clear address locking lease` command.

#### **EOS Release 4.23.0F:**

- Initial release.
- Supports IPv4 address locking.

### 11.5.1.2 Platform Compatibility

Support for IP Locking is found on the following platforms:

- CCS-720XP
- DCS-7050CX3
- DCS-7050SX3

### 11.5.1.3 IPv4 Locking Configuration Commands

Configure IP Locking commands in the address locking configuration mode.

#### **Example**

```
switch#configure
switch(config)#address locking
switch(config-address-locking)#
```

To enable IP Locking, you must configure

- the DHCP servers from which hosts are expected to acquire leases. IP Locking communicates with these DHCP servers to learn the IP addresses that must be authorized on the switch.

```
switch(config-address-locking)#dhcp server ipv4 10.1.1.1
switch(config-address-locking)#dhcp server ipv4 10.30.1.3
```

- a local L3 interface to communicate with the DHCP server(s). This could be the management interface, a routed interface, or a Switch Virtual Interface (SVI). This interface requires a valid IP address assigned, routable to the configured DHCP server(s), and can reside in non-default VRF. The interface IP is used as the source IP in the switch's packets to the DHCP server.

```
switch#configure
switch(config)#interface Vlan2160
switch(config-if-Vl2160)#ip address 10.10.1.2/16

switch#configure
switch(config)#address locking
switch(config-address-locking)#local-interface Vlan2160
```

To activate IP Locking on ports connected to clients, IP Locking must be enabled in the interface configuration mode. Running this command only activates IPv4 Locking and overrides the previous configuration for the interface.

#### **Example**

```
switch(config)#interface Ethernet27/1
```

```
switch(config-if-Et27/1)#address locking ipv4
```

It is possible to disable IP Locking using the `disabled` command in address-locking mode. This turns off the feature and allows a host to use any IP address, authorized or unauthorized, on any port.

#### Example

```
switch#configure
switch(config)#address locking
switch(config-address-locking)#disabled
```

### 11.5.1.3.1 Clear Commands

Supported since *EOS Release 4.23.1F*, the `clear address locking lease...` command removes the lease from hardware. This enable mode command removes lease bindings at different granularities.

- The `clear address locking lease ipv4 V4ADDR` command removes a single lease associated with an IPv4 address.
- The `clear address locking lease ipv6 V6ADDR` removes a single lease associated with an IPv6 address.
- The `clear address locking lease intf ethernet slot` removes all leases associated with the specified interface.
- The `clear address locking lease all` removes all leases on the switch.

### 11.5.1.3.2 Static Lease Commands

Supported since *EOS Release 4.23.2*, the `lease <V4ADDR> mac <MACADDR>` command within address locking configuration mode installs a lease into hardware for the configured IP address on the interface the configured MAC address is associated with. If the MAC address is not in the MAC table or the MAC address is on an interface that is not configured with IP Locking feature, the lease is not installed until the MAC address is added to an interface that is configured with IP Locking.



**Note:** Any lease from the DHCP server that matches either the same IP or MAC as a statically configured lease is removed from the switch.

```
switch#configure
switch(config)#address locking
switch(config-address-locking)#lease 1.1.1.1 mac a.b.c
```

### 11.5.1.3.3 Locked Address Expiration Commands

In releases prior to *EOS Release 4.24.0F*, IP addresses remain authorized and installed even after their corresponding MAC addresses have aged out. Beginning with *EOS Release 4.24.0F*, IP Locking, by default, deauthorizes leases after their corresponding MAC addresses age out. The `locked-address expiration mac disabled` command configures IP Locking to keep leases installed, even after their corresponding MAC addresses have aged out.

#### Example

```
switch#configure
switch(config)#address locking
```



```
switch(config-address-locking)#locked-address expiration mac
disabled
```

#### 11.5.1.3.4 IP Locking Counters

Supported since *EOS Release 4.24.0F*, the `show address locking counters` command displays DHCP lease query messages sent, received, and dropped. There are two sets of counters: first, the number of packets sent to and received from each DHCP server; and second, the number of packets sent and received for each locked interface. There are separate counters for the different kinds of messages communicated between the switch and the DHCP server.

##### Example

```
switch#show address locking counters
 Lease Active Lease Unknown Lease Unassigned
DHCP Server Query Rcvd Drop Rcvd Drop Rcvd Drop
Unknown

80.80.80.80 32860 8002 34 8001 32 13423 134
3234

Interface Query Lease Active Lease Unknown Lease Unassigned

Ethernet2 1747 1234 189 324
```

The `clear address locking counters` command resets all the counters associated with IP Locking to zero.

#### 11.5.1.4 IPv6 Locking

##### 11.5.1.4.1 IPv6 Locking Configuration Commands

To enable IPv6 locking, you must:

- Disable enforcement of IPv6 address locking.

```
switch#configure
switch(config)#address locking
switch(config-address-locking)#locked-address ipv6 enforcement disabled
```

To activate IPv6 Locking on ports connected to clients, IPv6 Locking must be enabled in the interface configuration mode. Running this command only activates IPv6 Locking and overrides the previous configuration for the interface.

##### Example

```
switch(config)#interface Ethernet27/1
switch(config-if-Et27/1)#address locking ipv6
```

Both IPv4 and IPv6 locking can be activated on a port by running commands similar to the following:

```
switch(config)#interface Ethernet27/1
switch(config-if-Et27/1)#address locking ipv4 ipv6
```

It is possible to disable IPv6 Locking using the **disabled** command in address-locking mode. This turns off the feature and allows a host to use any IP address, authorized or unauthorized, on any port. Note that this will also disable IP Locking as well.

#### Example

```
switch#configure
switch(config)#address locking
switch(config-address-locking)#disabled
```

#### 11.5.1.4.2 Locked Address IPv6 Enforcement Commands

Starting with **EOS Release 4.25.0F**, the **locked-address ipv6 enforcement disabled** command disables address filtering for all ports that have IPv6 Locking enabled. This permits IPv6 packets while still keeping all other drop rules.

#### Example

```
switch#configure
switch(config)#address locking
switch(config-address-locking)#locked-address ipv6 enforcement
disabled
```

#### 11.5.1.5 Show Commands

Use the **show address locking** command to display the status of IP and IPv6 locking.

#### Example

```
switch#show address locking
IP Locking is active
 Interface IPv4 IPv6

 Ethernet27/1 yes no (not configured)
 Ethernet31/1 no (not configured) no (not a layer 2
 interface)
```

The **show address locking** command also displays the reason as to why IP Locking is not enabled for an interface. For an interface, the following priority (highest at top) is imposed on the output when IP Locking is not enabled for an interface:

- not configured
- not a Layer 2 interface
- no local interface
- no dhcp server

The `show address locking table ipv4` command displays all the DHCP leases that IP Locking knows about, whether or not those leases are installed and the interfaces on which these IP addresses are authorized.

#### Example

```
switch#show address locking table ipv4
IP Address MAC Address Interface Installed
Expiration Time

10.30.4.4 ba76.a467.7ff8 Et27/1 installed in
0:01:57
```

#### 11.5.1.6 Limitations

The IP Locking feature contains the following limitations:

- IP Locking is supported for IPv4 but has limited functionality for IPv6.
- IP Locking works only with DHCP servers that support RFC 4388 (LeaseQuery) and are configured to allow lease queries. ISC DHCPD and BlueCat are currently known servers that support LeaseQuery.
- IP Locking can only be configured on Ethernet interfaces, excluding sub-interfaces.
- IP Locking and DHCP relay cannot be configured on the same switch. When both are configured, IP Locking is disabled.
- IP Locking and DHCP snooping cannot be configured on the same switch. When both are configured, IP Locking is disabled.
- IP Locking and DHCP server cannot be configured on the same switch. When both are configured, IP Locking is disabled.
- Do not configure IP Locking and the ARP inspection feature on the same switch.
- Do not configure IP Locking and the IP source guard feature on the same switch.
- IP Locking may not immediately invalidate a lease on an access port if the host moves to another port on a different access switch.
- IP Locking supports up to 3400 hosts on the DCS-7050X3 platform, and up to 3800 hosts on the CCS-720XP platform. This scale may reduce further with other features using TCAM resources.
- IPv6 Locking currently only allows disabling address filtering for IPv6 packets while keeping all packet type specific drop rules such as ND:RA, ND:RD, and DHCP Server-to-Client.
- Some DHCP server implementations (such as ISC DHCPD) do not respond to lease query if the **fixed-address** configuration is used. Use reserved leases instead.
- CVP Endpoint Identification is not able to identify hosts connected to an IP Locking enabled switch.

---

### 11.5.1.7 IP Locking Commands

#### IPv4 Clear Commands

- [clear address locking lease](#)

#### IPv4 Static Lease Commands

- [lease mac](#)

#### IPv4 Lock Address Expiration Commands

- [locked-address expiration mac disabled](#)

#### IP Locked Show Commands

- [show address locking](#)
- [show address locking counters](#)
- [show address locking table ipv4](#)

### 11.5.1.7.1 clear address locking lease

Use the `clear address locking lease` command to remove lease bindings at different granularities.

Support beginning with *EOS Release 4.23.1F*:

- The `clear address locking lease...` command removes the lease from the hardware.
  - The `clear address locking lease ipv4 V4ADDR` command removes a single lease associated with an IPv4 address.
  - The `clear address locking lease ipv6 V6ADDR` command removes a single lease associated with an IPv6 address.
  - The `clear address locking lease intf ethernet slot` command removes all leases associated with the specified interface.
  - The `clear address locking lease all` command remove all leases on the switch.

#### Command Mode

Address locking mode

#### Command Syntax

```
clear address locking lease [all | interface [ethernet slot] | ipv4 V4ADDR | ipv6 V6ADDR]
```

#### Parameters

- **all** The entire lease table.
- **interface** The interface of the lease to be cleared.
  - **ethernet slot** Ethernet interface slot number.
- **ipv4 V4ADDR** IPv4 address of the lease to be cleared.
- **ipv6 V6ADDR** IPv6 address of the lease to be cleared.

#### Example

```
switch(config-address-locking) #clear address locking lease all
```

---

### 11.5.1.7.2 lease mac

Supported beginning with **EOS Release 4.23.2**, the **lease mac** command within the address locking configuration mode installs a lease into hardware for the configured IP address on the interface the configured MAC address is associated with. If the MAC address is not in the MAC table or the MAC address is on an interface that is not configured with IP Locking feature, the lease is not installed until the MAC address is added to an interface that is configured with IP Locking. The **no** and **default** forms of the command removes the lease into hardware for the configured IP address on the interface the configured MAC address is associated with.

#### Command Mode

Address locking configuration mode

#### Command Syntax

```
lease V4ADDR mac MACADDR
```

```
no lease V4ADDR mac MACADDR
```

```
default lease V4ADDR mac MACADDR
```

#### Parameters

- **lease V4ADDR** The lease IP address.
- **mac MACADDR** The configured mac address for static lease.

#### Example

```
Arista#config t
Arista(config)#address locking
Arista(config-address-locking)#lease 1.1.1.1 mac a.b.c
```

### 11.5.1.7.3 locked-address expiration mac disabled

Beginning with **EOS Release 4.24.0F**, IP Locking, by default, deauthorizes leases after their corresponding MAC addresses age out. Use the **locked-address expiration mac disabled** command to configure IP Locking to keep leases installed, even after their corresponding MAC addresses have aged out.

#### Command Mode

Address locking configuration mode

#### Command Syntax

```
locked-address expiration mac disabled
```

```
no locked-address expiration mac disabled
```

```
default locked-address expiration mac disabled
```

#### Parameters

- **expiration** Configures expiration mode for locked addresses.
- **mac** Configures deauthorizing locked addresses upon MAC aging out.
- **disabled** Disables deauthorizing locked address upon MAC aging out.

#### Example

```
switch#configure t
switch(config)#address locking
switch(config-address-locking)#locked-address expiration mac disabled
```

---

#### 11.5.1.7.4 show address locking

Use the **show address locking** command to display the status of IP and IPv6 locking.

The **show address locking** command also displays the reason as to why IP Locking is not enabled for an interface. For an interface, the following priority (highest at top) is imposed on the output when IP Locking is not enabled for an interface:

- not configured
- not a Layer 2 interface
- no local interface
- no dhcp server

#### Command Mode

EXEC

#### Command Syntax

```
show address locking
```

#### Example

```
switch#show address locking
IP Locking is active
 Interface IPv4 IPv6

Ethernet27/1 yes no (not configured)
Ethernet31/1 no (not configured) no (not a layer 2 interface)
```



### 11.5.1.7.5 show address locking counters

Supported beginning with **EOS Release 4.24.0F**, the **show address locking counters** command displays DHCP lease query messages sent, received, and dropped. There are two sets of counters: first, the number of packets sent to and received from each DHCP server; and second, the number of packets sent and received for each locked interface. There are separate counters for the different kinds of messages communicated between the switch and the DHCP server.

#### Command Mode

EXEC

#### Command Syntax

```
show address locking counters
```

#### Related Commands

The **clear address locking counters** command resets all the counters associated with IP Locking to zero.

#### Example

```
switch#show address locking counters
 Lease Active Lease Unknown Lease Unassigned
DHCP Server Query Rcvd Drop Rcvd Drop Rcvd Drop Unknown

80.80.80.80 32860 8002 34 8001 32 13423 134 3234

Interface Query Lease Active Lease Unknown Lease Unassigned

Ethernet2 1747 1234 189 324
```

---

### 11.5.1.7.6 show address locking table ipv4

Use the `show address locking table ipv4` command to display all the DHCP leases that IP Locking knows about, whether or not those leases are installed and the interfaces on which these IP addresses are authorized.

#### Command Mode

EXEC

#### Command Syntax

```
show address locking table ipv4 [dynamic [installed | [interface Ethernet s/ot] | installed | interface [Ethernet [s/ot] | static [installed | interface [Ethernet s/ot]]]
```

#### Parameters

- **dynamic** Only display the dynamic leases.
  - **installed** Only display the leases that are installed in the hardware.
  - **interface** Only display the leases belonging to a specified interface.
- **installed** Only display the leases that are installed in the hardware.
- **interface** Only display the leases belonging to a specified interface.
  - **Ethernet *s/ot*** Specified Ethernet sub-interface.
- **static** Only display the static leases.
  - **installed** Only display the leases that are installed in the hardware.
  - **interface** Only display the leases belonging to a specified interface.
    - **Ethernet *s/ot*** Specified Ethernet sub-interface.

#### Example

```
switch#show address locking table ipv4
IP Address MAC Address Interface Installed Expiration Time

10.30.4.4 ba76.a467.7ff8 Et27/1 installed in 0:01:57
```

## 11.6 Layer 2 Subinterfaces

A Layer 2 subinterface is a logical bridging endpoint associated with traffic on an interface distinguished by 802.1Q tags, where each **interface, 802.1q tag** tuple is treated as a first-class bridging interface.

Like other types of interfaces, an L2 subinterface is a normal bridging endpoint in the bridging domain.

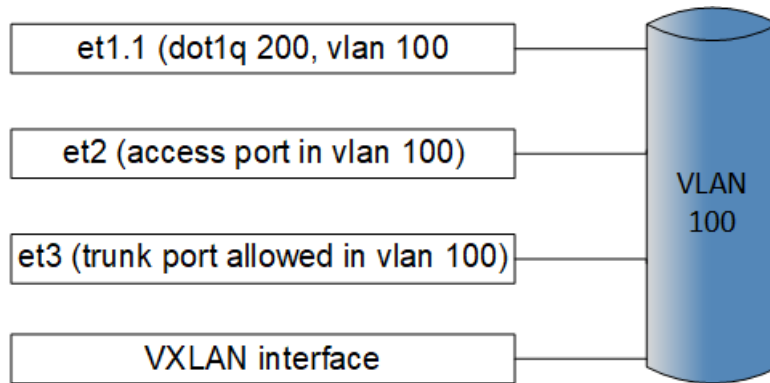

### 11.6.1 Platform Compatibility

The following platforms support the Layer 2 subinterface:

- DCS-7280R Series
- DCS-7280R2 Series
- DCS-7280R3 Series
- DCS-7500R Series
- DCS-7500R2 Series
- DCS-7500R3 Series
- DCS-7800R3 Series

### 11.6.2 Configurations

#### 11.6.2.1 Creating a Layer 2 Subinterface

Complete the following steps to configure a layer 2 (L2) subinterface on an Arista switch:

1. Configure the parent interface to be a routed port.

```
switch(config)#interface et1
switch(config-if-Et1)#no switchport
```

2. Create a subinterface on the parent interface (**et1.1**), assign 802.1q encapsulation (**vlan 100**), and assign the forwarding VLAN ID (**vlan 200**).

```
switch(config-if-Et1)#interface et1.1
switch(config-if-Et1.1)#encapsulation dot1q vlan 100
switch(config-if-Et1.1)#vlan id 200
! VLAN does not exist. Creating vlan 200
```

3. An alternative to configuring a forwarding VLAN id is to use VLAN name (**office**).

```
switch(config)#vlan 200
switch(config-vlan-200)#name office
```

```
switch(config-vlan-200)#int et1.2
switch(config-if-Et1.2)#encapsulation dot1q vlan 101
switch(config-if-Et1.2)#vlan name office
```

4. Now subinterfaces **et1.1** and **et1.2** have been created and added to **VLAN 200**.

```
switch#show interface et1.1-2 status
```

| Port  | Name          | Status    | Vlan | Duplex | Speed | Type                | Flags |
|-------|---------------|-----------|------|--------|-------|---------------------|-------|
|       | Encapsulation |           |      |        |       |                     |       |
| Et1.1 |               | connected | 200  | full   | 10G   | dot1q-encapsulation | 100   |
| Et1.2 |               | connected | 200  | full   | 10G   | dot1q-encapsulation | 101   |

### 11.6.2.2 MAC Address on Layer 2 Subinterface

MAC addresses can either be statically configured or dynamically assigned behind Layer 2 (L2) subinterfaces.

```
switch(config)#mac address-table static 0000.000a.000a vlan 200
interface et1.1
```

```
switch#show mac address-table interface et1.1-2
```

Mac Address Table

```

```

| Vlan                                      | Mac Address    | Type    | Ports | Moves | Last    |
|-------------------------------------------|----------------|---------|-------|-------|---------|
| Move                                      |                |         |       |       |         |
| -----                                     |                |         |       |       |         |
| 200                                       | 0000.000a.000a | STATIC  | Et1.1 |       |         |
| 200                                       | 0000.000b.000b | DYNAMIC | Et1.2 | 1     | 0:00:06 |
| ago                                       |                |         |       |       |         |
| Total Mac Addresses for this criterion: 2 |                |         |       |       |         |

MAC address learning can be enabled or disabled on an L2 subinterface using the following commands:

In the following example, the **show interface ethernet1.1 switchport** command has this **running-config**:

```
switch(config-if-Et1.1)#show interface ethernet1.1 switchport
Name: Et1.1
Switchport: Enabled
Administrative Mode: tunnel
Operational Mode: tunnel
MAC Address Learning: disabled
Dot1q ethertype/TPID: 0x8100 (active)
Dot1q VLAN Tag: Allowed
Access Mode VLAN: 1 (default)
Trunking Native Mode VLAN: 1 (default)
Administrative Native VLAN tagging: disabled
Trunking VLANs Enabled: ALL
Static Trunk Groups:
```

```
Dynamic Trunk Groups:
Source interface filtering: enabled
VLAN forwarding mode: allowedVlansOnly
```

To enable MAC address learning, use the `no mac address learning disabled` command:

```
switch(config-if-Et1.1)#no mac address learning disabled
```

### 11.6.2.3 QoS Feature

Supported QoS features are:

#### Shaping

After creating an L2 subinterface, you can configure a shape rate (in Kbps) on the sub-interface. For example, the shape rate is configured to **50000000** Kbps.

```
switch(config-if-Et1.1)#shape rate 50000000
```

The configuration of non-default shape rate results in the allocation of dedicated virtual output queues (VOQ) for the subinterface. Each subinterface allocates four (4) VOQs. Different TC traffic goes to the VOQ according to the following mapping:

|         |      |
|---------|------|
| TC6-7 : | VOQ3 |
| TC4-5 : | VOQ2 |
| TC2-3 : | VOQ1 |
| TC0-1 : | VOQ0 |

VOQ3 is in strict-priority mode to the other VOQs.

VOQ2, VOQ1, and VOQ0 are in WRR with a static credit ratio 2:3:6 (higher ratio implies more credits).

The subinterface inherits the trust mode of the parent interface.

Before **EOS Release 4.24.2F**, shaping is supported only on L2 subinterfaces of which the parents are Ethernet interfaces, for example, **Et1.1**. Beginning with **EOS Release 4.24.2F**, shaping on L2 subinterface over a parent interface which is port-channel (for example, **Po1.1**), is supported.

#### Policing

For policing to work on the L2 subinterface, you must switch to the QoS profile.

#### Example

```
switch(config)#hardware tcam
switch(config-hw-tcam)#system profile qos

Sample Policy-map Configuration:

switch(config)#ip access-list a1
switch(config-acl-a1)#statistics per-entry
switch(config-acl-a1)#10 permit ip any any

switch(config)#class-map type qos match-any c1
```

```

switch(config-cmap-qos-c1) #match ip access-group a1

switch(config) #class-map type qos match-any c2
switch(config-cmap-qos-c2) #match vlan 100 0xfff

switch(config) #ipv6 access-list a1
switch(config-ipv6-acl-a1) #statistics per-entry
switch(config-ipv6-acl-a1) #10 permit ipv6 any any

switch(config) #class-map type qos match-any c3
switch(config-cmap-qos-c3) #match ipv6 access-group a1

switch(config) #policy-map type quality-of-service p1
switch(config-pmap-quality-of-service-p1) #class c1
switch(config-pmap-quality-of-service-p1-c1) #police cir 10 Mbps bc 100000
 bytes
 exit
exit

```

After you create an L2 subinterface, you can configure a policy-map on the sub-interface, similar to the following example.

```

switch(config-if-Et1.1) #service-policy type qos input p1

```

## Interface Counters

To enable the hardware features for counting packets on L2 subinterfaces ingress and/or egress, use the **hardware counter feature** command, similar to the following example. In the example, subinterface **layer2** is enabled for ingress then enabled for egress.

### Example

```

switch(config) #hardware counter feature subinterface in layer2
switch(config) #hardware counter feature subinterface out layer2

```

To display the L2 subinterface counters, use the **show interface counters** command similar to the following example. In the example, subinterface **et1.1** is configured to be displayed.

```

switch#show interfaces et1.1 counters

Port InOctets InPkts
Et1.1 0 0

Port OutOctets OutPkts
Et1.1 0 0

```

To clear all of the interface counters, use the **clear counters** command similar to the following example:

```

switch#clear counters

```

To learn counters for a specific L2 interface, use the **clear counters** command, and specify the L2 subinterface to clear, similar to the following example. In the example, L2 subinterface **et1.1** is to be cleared.

```

switch#clear counters et1.1

```

### 11.6.2.4 Syslog Messages

A combined total of 1024 subinterfaces are currently supported on the system, 256 and 512 of which can be configured with shaping on modular systems and fixed systems, respectively. Shape rate configuration beyond this limitation results in the following Syslog and unpredictable behavior.

```
%SAND-3-SUBINTF_SHAPING_HW_LIMIT_REACHED: Shaping configuration on
Interface Port-Channel1.257 failed. The system is already configured
with the maximum number of subinterfaces with shaping supported
(256d).
```

The hardware resource used by L2 subinterfaces is shared by multiple different applications, such as VLAN Mapping and L3 subinterfaces. When the resources are exhausted on a particular forwarding chip, the configuring subinterfaces result in a Syslog.

```
%SAND-3-SUBINTF_HW_RESOURCE_EXHAUSTED: Shaping configuration on Interface
Ethernet5/2/1.48 failed due to lack of queuing hardware resources.
```

### 11.6.3 Show Commands

Use the `show interfaces status` command to display the subinterface status.

#### Example

```
switch#show interfaces status sub-interfaces
Port Name Status Vlan Duplex Speed Type Flags
Encapsulation
Et1.1 connected 200 full 10G dot1q-encapsulation 100
Et1.2 connected 200 full 10G dot1q-encapsulation 101
```

Use the `show vlan` command to display the VLAN membership. In the following example, **VLAN 200** is configured to be displayed.

#### Example

```
switch#show vlan 200
VLAN Name Status Ports

200 office active Et1.1, Et1.2, Et5
```

Use the `show qos interface` command to display the QoS configuration on an L2 subinterface. In the following example, QoS subinterface **Ethernet 1.1** is configured to be displayed.

#### Example

```
switch#show qos interface Ethernet 1.1
Ethernet1.1:

Trust Mode: DSCP
Default COS: 0
Default DSCP: 0
```

```
Port shaping rate: 50625 / 50000 kbps
```

Use the **show interface counters** with the queue keyword to display the L2 subinterface counters. For example subinterface **Ethernet 1.1** is configured to display the L2 subinterface counters.

#### Example

```
switch#show interface Ethernet 1.1 counters queue
Aggregate VoQ Counters
Egress Traffic Pkts Octets DropPkts
DropOctets
Port Class

Et1.1 TC0-1 0 0 0
0
Et1.1 TC2-3 0 0 0
0
Et1.1 TC4-5 0 0 0
0
Et1.1 TC6-7 460266 276159600 109316
65589600
```

Use the **show mac address-table** command to display the MAC address on L2 subinterfaces. For example, subinterfaces **Et1.1** and **Et1.2** are configured to be displayed.

#### Example

```
switch#show mac address-table interface et1.1-2
Mac Address Table

Vlan Mac Address Type Ports Moves Last
Move

200 0000.000a.000a STATIC Et1.1
200 0000.000b.000b DYNAMIC Et1.2 1 0:00:16
ago
Total Mac Addresses for this criterion: 2
```

## 11.6.4 Limitations

The following limitations apply to the Layer 2 subinterface feature:

- A total of 256 Layer 2 subinterfaces with shaping are supported across the entire switch and they can be distributed across any number of Ethernet ports. Starting in **EOS Release 4.24.2F**, the number of total L2 subinterfaces with shaping per switch have been changed to 512 on a fixed system. The 256 limit holds for modular platforms.
- When a shape rate is configured on an L2 subinterface over a parent interface which is port-channel (example: **Po1.1**), traffic load-balancing is disabled and is directed to a selected port-channel member. Also, the bandwidth of the port-channel subinterface will be equal to the selected



member. However, the `show interface` command continues to show the bandwidth of the port-channel which is incorrect.

- After configuring a shape rate on an L2 subinterface, the L2 subinterface must be flapped by using the `shut` and `no shut` commands.
- Shaping of BUM traffic on L2 subinterfaces is supported only with “*ingress replication*”.
- Layer 3 forwarding through SVIs is not supported.
- Routing through the parent interface of a subinterface is not supported.
- Control plane processing, such as IGMP snooping and STP BPDU is not supported.
- When IGMP protocol packets are expected to be forwarded on L2 subinterfaces, then IGMP snooping must be disabled globally on the entire switch using the `no ip igmp snooping` command. When IGMP snooping is configured on any VLAN, then IGMP protocol packets are discarded by L2 subinterfaces.
- Double tagged packets arriving on L2 subinterfaces with a single `encapsulation dot1q vlan <outer_vid>` command configured will match on the outer VLAN tag, and have only the outer VLAN tags terminated.
- Configuration of double tagged L2 subinterfaces through the `encapsulation dot1q vlan <outer_vid> inner <inner_vid>` command is not supported.
- Mixing of shaped and non-shaped subinterfaces under the same parent interface is not supported.
- Traffic classification on ingress traffic to L2 subinterface is disabled by default. To enable this feature, configure using the `qos trust cos` command on the parent interface.
- Counters are supported from **EOS Release 4.25.0F** release on DCS-7500R3, DCS-7800R3, DCS-7280R3, Jericho QMX, and Jericho+ platforms
- Starting **EOS Release 4.25.0F**, Qos policies are supported on DCS-7500R3, DCS-7800R3, and DCS-7280R3. Matching on CoS and inner VLAN is not supported.
- L2 subinterfaces are not supported in an MLAG environment.



## Layer 3 Configuration

---

This chapter covers the following Layer 3 sections:

- [IPv4](#)
- [IPv6](#)
- [Ingress and Egress Per-Port for IPv4 and IPv6 Counters](#)
- [ACLs and Route Maps](#)
- [VARP](#)
- [OpenFlow](#)
- [DirectFlow](#)
- [Decap Groups](#)
- [Nexthop Groups](#)
- [Global Knob to Set MTU for all Layer 3 Interfaces](#)
- [Support for L3 MTU on 7280R3/7500R3/7800R3](#)

### 12.1 IPv4

Arista switches support Internet Protocol version 4 (IPv4) and Internet Protocol version 6 (IPv6) for routing packets across network boundaries. This section describes Arista's implementation of IPv4 and includes these topics:

- [IPv4 Addressing](#)
- [IPv4 Routing](#)
- [IPv4 Multicast Counters](#)
- [Route Management](#)
- [IPv4 Route Scale](#)
- [IP Source Guard](#)
- [DHCP Server](#)
- [DHCP Relay Global Configuration Mode](#)
- [DHCP Relay Across VRF](#)
- [DHCP Relay in VXLAN EVPN](#)
- [DHCP Snooping with Bridging](#)
- [TCP MSS Clamping](#)
- [IPv4 GRE Tunneling](#)
- [IPv4 Commands](#)

#### 12.1.1 IPv4 Addressing

Each IPv4 network device is assigned a 32-bit IP address that identifies its network location. These sections describe IPv4 address formats, data structures, configuration tasks, and display options:

- [IPv4 Address Formats](#)
- [IPv4 Address Configuration](#)
- [Address Resolution Protocol \(ARP\)](#)
- [Displaying ARP Entries](#)

### 12.1.1.1 IPv4 Address Formats

IPv4 addresses are composed of 32 bits, expressed in dotted decimal notation by four decimal numbers, each ranging from 0 to 255. A subnet is identified by an IP address and an address space defined by a routing prefix. The switch supports the following subnet formats:

- **IP address and subnet mask:** The subnet mask is a 32-bit number (dotted decimal notation) that specifies the subnet address space. The subnet address space is calculated by performing an AND operation between the IP address and subnet mask.
- **IP address and wildcard mask:** The wildcard mask is a 32-bit number (dotted decimal notation) that specifies the subnet address space. Wildcard masks differ from subnet masks in that the bits are inverted. Some commands use wildcard masks instead of subnet masks.
- **CIDR notation:** CIDR notation specifies the scope of the subnet space by using a decimal number to identify the number of leading ones in the routing prefix. When referring to wildcard notation, CIDR notation specifies the number of leading zeros in the routing prefix.

#### Examples:

- These subnets (subnet mask and CIDR notation) are calculated identically:

```
10.24.154.13 255.255.255.0
10.24.154.13/24
```

The defined space includes all addresses between **10.24.154.0** and **10.24.154.255**.

- These subnets (wildcard mask and CIDR notation) are calculated identically:

```
124.17.3.142 0.0.0.15
124.17.3.142/28
```

The defined space includes all addresses between **124.17.3.128** and **124.17.3.143**.

### 12.1.1.2 IPv4 Address Configuration

#### Assigning an IPv4 Address to an Interface

The `ip address` command specifies the IPv4 address of an interface and the mask for the subnet to which the interface is connected.

#### Example:

- These commands configure an IPv4 address with subnet mask for **VLAN 200**:

```
switch(config)#interface vlan 200
switch(config-if-Vl200)#ip address 10.0.0.1/24
switch(config-if-Vl200)#
```

#### Assigning an IPv4 Class E Address to an Interface

The `ipv4 routable 240.0.0.0/4` command assigns a class E addresses to an interface. When configured, the class E address traffic are routed through BGP, OSPF, ISIS, RIP, static routes and programmed to the FIB and kernel. By default, this command is disabled.

#### Example:

- These commands configure an IPv4 Class E (240/4) address to an interface.

```
switch(config)#router general
```

```
switch(config-router-general)#ipv4 routable 240.0.0.0/4
```

### Detecting duplicate IP Addresses on an Interface

The `ip address duplicate detection disabled` command detects any duplicate IP address on the interface. When the duplicate IP address is detected, a syslog message is generated. It helps the network operator to identify IP addresses misconfiguration. By default, this feature is enabled.

#### Example:

- This command disables the feature on the switch.

```
switch(config)#ip address duplicate detection disabled
```

- This command enables the feature.

```
switch(config)#ip address duplicate detection logging
```



**Note:** Commands are in global configuration mode, and are not per VRF.

This is an example of a Syslog message, when a duplicate IP address is detected.

```
Mar 24 16:41:57 cd290 Arp: %INTF-4-DUPLICATE_ADDRESS_WITH_HOST: IP
address 100.1.1.2
configured on interface Ethernet1/1 is in use by a host with
MAC address 00:00:01:01:00:00 on interface Ethernet1/1 in VRF default
```

### 12.1.1.3 Address Resolution Protocol (ARP)

Address Resolution Protocol (ARP) is a protocol that maps IP addresses to MAC addresses that local network devices recognize. The ARP cache is a table that stores the correlated addresses of the devices for which the router facilitates data transmissions.

After receiving a packet, routers use ARP to find the MAC address of the device assigned to the packet's destination IP address. If the ARP cache contains both addresses, the router sends the packet to the specified port. If the ARP cache does not contain the addresses, ARP broadcasts a request packet to all devices in the subnet. The device at the requested IP address responds and provides its MAC address. ARP updates the ARP cache with a dynamic entry and forwards the packet to the responding device. Static ARP entries can also be added to the cache through the CLI.

Proxy ARP is an ARP variant. A network device (proxy) responds to ARP requests for network addresses on a different network with its MAC address. Traffic to the destination is directed to the proxy device which then routes the traffic toward the ultimate destination.

#### Configuring ARP

The switch uses ARP cache entries to correlate 32-bit IP addresses to 48-bit hardware addresses. The `arp aging timeout` command specifies the duration of dynamic address entries in the Address Resolution Protocol (ARP) cache for addresses learned through the Layer 3 interface. The default duration is **14400** seconds (four hours).

Entries are refreshed and expired at a random time that is in the range of 80%-100% of the cache expiry time. The refresh is tried three times at an interval of 2% of the configured timeout.

Static ARP entries never time out and must be removed from the table manually.

**Example:**

---

This command specifies an ARP cache duration of **7200** seconds (two hours) for dynamic addresses added to the ARP cache that were learned through **VLAN 200**.

```
switch(config)#interface vlan 200
switch(config-if-Vl200)#arp aging timeout 7200
switch(config-if-Vl200)#show active
interface Vlan200
 arp aging timeout 7200
switch(config-if-Vl200)#
```

The `arp` command adds a static entry to an Address Resolution Protocol (ARP) cache.

**Example:**

This command adds a static entry to the ARP cache in the default VRF.

```
switch(config)#arp 172.22.30.52 0025.900e.c63c arpa
switch(config)#
```

### 12.1.1.3.1 Gratuitous ARP

Gratuitous ARP packets are broadcast by a device in response to an internal change rather than as a response to an ARP request. The gratuitous ARP packet is a request packet (no reply expected) that supplies an unrequested update of ARP information. In a gratuitous ARP packet, both the source and destination IP addresses are the IP of the sender, and the destination MAC address is the broadcast address (**ff:ff:ff:ff:ff:ff**).

Gratuitous ARP packets are generated to update ARP tables after an IPv4 address or a MAC address change occurs.

#### Configuring Gratuitous ARP

By default, Arista switch interfaces reject gratuitous ARP request packets. The `arp gratuitous accept` command configures an L3 interface to accept the gratuitous ARP request packets sent from a different device in the network and add their mappings to the ARP table. Gratuitous ARP can be configured on Ethernet interfaces, VLANs/SVI, or L3 port channels, but has no effect on L2 interfaces.

**Example**

These commands enable gratuitous ARP packet acceptance on **interface Ethernet 2/1**.

```
switch (config)#interface ethernet 2/1
switch (config-if-Et2/1)#arp gratuitous accept
```

### 12.1.1.4 Displaying ARP Entries

The `show ip arp` command displays ARP cache entries that map an IP address to a corresponding MAC address. The table displays addresses by their host names when the command includes the **resolve** argument.

**Examples**

- This command displays ARP cache entries that map MAC addresses to IPv4 addresses.

```
switch>show ip arp

Address Age (min) Hardware Addr Interface
172.25.0.2 0 004c.6211.021e Vlan101, Port-
Channel2
172.22.0.1 0 004c.6214.3699 Vlan1000, Port-
Channel1
172.22.0.2 0 004c.6219.a0f3 Vlan1000, Port-
Channel1
172.22.0.3 0 0045.4942.a32c Vlan1000,
Ethernet33
172.22.0.5 0 f012.3118.c09d Vlan1000, Port-
Channel1
172.22.0.6 0 00e1.d11a.a1eb Vlan1000, Ethernet5
172.22.0.7 0 004f.e320.cd23 Vlan1000, Ethernet6
172.22.0.8 0 0032.48da.f9d9 Vlan1000,
Ethernet37
172.22.0.9 0 0018.910a.1fc5 Vlan1000,
Ethernet29
172.22.0.11 0 0056.cbe9.8510 Vlan1000,
Ethernet26

switch>
```

- This command displays ARP cache entries that map MAC addresses to IPv4 addresses. Host names assigned to IP addresses are displayed in place of the address.

```
switch>show ip arp resolve

Address Age (min) Hardware Addr Interface
green-vl101.new 0 004c.6211.021e Vlan101, Port-
Channel2
172.22.0.1 0 004c.6214.3699 Vlan1000, Port-
Channel1
orange-vl1000.n 0 004c.6219.a0f3 Vlan1000, Port-
Channel1
172.22.0.3 0 0045.4942.a32c Vlan1000,
Ethernet33
purple.newcompa 0 f012.3118.c09d Vlan1000, Port-
Channel1
pink.newcompany 0 00e1.d11a.a1eb Vlan1000, Ethernet5
yellow.newcompa 0 004f.e320.cd23 Vlan1000, Ethernet6
172.22.0.8 0 0032.48da.f9d9 Vlan1000,
Ethernet37
royalblue.newco 0 0018.910a.1fc5 Vlan1000,
Ethernet29
172.22.0.11 0 0056.cbe9.8510 Vlan1000,
Ethernet26

switch>
```

#### 12.1.1.4.1 ARP Inspection

Address Resolution Protocol (ARP) inspection command `ip arp inspection vlan` activates a security feature that protects the network from ARP spoofing. ARP requests and responses on untrusted interfaces are intercepted on specified VLANs, and intercepted packets are verified to have valid IP-

---

MAC address bindings. All invalid ARP packets are dropped. On trusted interfaces, all incoming ARP packets are processed and forwarded without verification.

### Enabling and Disabling ARP Inspection

By default, ARP inspection is disabled on all VLANs.

#### Examples

- This command enables ARP inspection on VLANs **1** through **150**.

```
switch(config)#ip arp inspection vlan 1 - 150
switch(config)#
```

- This command disables ARP inspection on VLANs **1** through **150**.

```
switch(config)#no ip arp inspection vlan 1 - 150
switch(config)#
```

- This command sets the ARP inspection default to VLANs **1** through **150**.

```
switch(config)#default ip arp inspection vlan 1 - 150
switch(config)#
```

- These commands enable ARP inspection on multiple VLANs **1** through **150** and **200** through **250**.

```
switch(config)#ip arp inspection vlan 1-150,200-250
switch(config)#
```

### Syslog for Invalid ARP Packets Dropped

When an invalid ARP packet is dropped, the following syslog message appears. The log severity level can be set higher if required.

```
%SECURITY-4-ARP_PACKET_DROPPED: Dropped ARP packet on interface
Ethernet28/1 Vlan
2121 because invalid mac and ip binding. Received: 00:0a:00:bc:0
0:de/1.1.1.1.
```

### Displaying ARP Inspection States

The command [show ip arp inspection vlan](#) displays the configuration and operation state of ARP inspection. For a VLAN range specified by `show ip arp inspection vlan` only VLANs with ARP inspection enabled will be displayed. If no VLAN is specified, all VLANs with ARP inspection enabled are displayed. The operation state turns to **Active** when hardware is ready to trap ARP packets for inspection.

#### Example

This command displays the configuration and operation state of ARP inspection for VLANs **1** through **150**.

```
switch(config)#show ip arp inspection vlan 1 - 150

VLAN 1

```



```

Configuration
: Enabled
Operation State : Active
VLAN 2

Configuration
: Enabled
Operation State : Active
{...}
VLAN 150

Configuration
: Enabled
Operation State : Active

switch(config)#

```

### Displaying ARP Inspection Statistics

The command `show ip arp inspection statistics` displays the statistics of inspected ARP packets. For a VLAN specified by `show ip arp inspection vlan` only VLANs with ARP inspection enabled will be displayed. If no VLAN is specified, all VLANs with ARP inspection enabled are displayed.

The command `clear arp inspection statistics` clears ARP inspection.

### Examples

- This command displays ARP inspection statistics for **VLAN 1**.

```

switch(config)#show ip arp inspection statistics vlan 2

Vlan : 2

ARP Req Forwarded = 20
ARP Res Forwarded = 20
ARP Req Dropped = 1
ARP Res Dropped = 1

Last invalid ARP:
Time: 10:20:30 (5 minutes ago)
Reason: Bad IP/Mac match
Received on: Ethernet 3/1
Packet:
 Source MAC: 00:01:00:01:00:01
 Dest MAC: 00:02:00:02:00:02
 ARP Type: Request
 ARP Sender MAC: 00:01:00:01:00:01
 ARP Sender IP: 1.1.1

switch(config)#

```

- This command displays ARP inspection statistics for **Ethernet interface 3/1**.

```

switch(config)#show ip arp inspection statistics ethernet
interface 3/1

Interface : 3/1

ARP Req Forwarded = 10
ARP Res Forwarded = 10
ARP Req Dropped = 1

```

```
ARP Res Dropped = 1

Last invalid ARP:
Time: 10:20:30 (5 minutes ago)
Reason: Bad IP/Mac match
Received on: VLAN 10
Packet:
 Source MAC: 00:01:00:01:00:01
 Dest MAC: 00:02:00:02:00:02
 ARP Type: Request
 ARP Sender MAC: 00:01:00:01:00:01
 ARP Sender IP: 1.1.1

switch(config)#
```

- This command clears ARP inspection statistics.

```
switch(config)#clear arp inspection statistics
switch(config)#
```

### Configure Trust Interface

By default, all interfaces are untrusted. The command `ip arp inspection trust` configures the trust state of an interface.

#### Examples

- This command configures the trust state of an interface.

```
switch(config)#ip arp inspection trust
switch(config)#
```

- This command configures the trust state of an interface to untrusted.

```
switch(config)#no ip arp inspection trust
switch(config)#
```

- This command configures the trust state of an interface to its default (untrusted).

```
switch(config)#default ip arp inspection trust
switch(config)#
```

### Configure Rate Limit

When ARP inspection is enabled, ARP packets are trapped to the CPU. Two actions can be taken when the incoming ARP rate exceeds expectation. For notification purpose, the command `ip arp inspection logging` will enable logging of the incoming ARP packets. To prevent a denial-of-service attack, the command `ip arp inspection limit` will error-disable interfaces.

#### Examples

- This command enables logging of incoming ARP packets when its rate exceeds the configured value, and sets the rate to 2048 (which is the upper limit for the number of

invalid ARP packets allowed per second), and sets the burst consecutive interval over which the interface is monitored for a high ARP rate to 15 seconds.

```
switch(config)#ip arp inspection logging rate 2048 burst
interval 15
switch(config)#
```

- This command configures the rate limit of incoming ARP packets to errdisable the interface when the incoming ARP rate exceeds the configured value, sets the rate to 512 (which is the upper limit for the number of invalid ARP packets allowed per second), and sets the burst consecutive interval over which the interface is monitored for a high ARP rate to 11 seconds.

```
switch(config)#ip arp inspection limit rate 512 burst interval
11
switch(config)#
```

- This command displays verification of the interface specific configuration.

```
switch(config)#interface Ethernet 3 / 1
switch(config)#ip arp inspection limit rate 20 burst interval
5
switch(config)#interface Ethernet 3 / 3
switch(config)#ip arp inspection trust
switch(config)#show ip arp inspection interfaces
```

| Interface | Trust State | Rate (pps) | Burst Interval |
|-----------|-------------|------------|----------------|
| Et3/1     | Untrusted   | 20         | 5              |
| Et3/3     | Trusted     | None       | N/A            |

```
switch(config)#
```

### Configure Errdisable Caused by ARP Inspection

If the incoming ARP packet rate on an interface exceeds the configured rate limit in burst interval, the interface will be errdisabled (by default). If errdisabled, the interface will stay in this state until you intervene with the command **errdisable detect cause arp-inspection** (e.g., after you perform a **shutdown** or **no shutdown** of the interface) or it automatically recovers after a certain time period. The command **errdisable recovery cause arp-inspection** will enable auto recovery. The command **errdisable recovery interval** will enable sharing the auto recovery interval among all errdisable interfaces. (See the chapter “Data Transfer” for information on all **errdisable** commands.)

#### Examples:

- This command enables errdisable caused by an ARP inspection violation.

```
switch(config)#errdisable detect cause arp-inspection
switch(config)#
```

- This command disables errdisable caused by an ARP inspection violation.

```
switch(config)#no errdisable detect cause arp-inspection
switch(config)#
```

- This command enables auto recovery.

```
switch(config)#errdisable recovery cause arp-inspection
switch(config)#
```

- This command disables auto recovery.

```
switch(config)#no errdisable recovery cause arp-inspection
switch(config)#
```

- This command enables sharing the auto recovery interval of **10** seconds among all errdisable interfaces.

```
switch(config)#errdisable recovery interval 10
switch(config)#
```

- This command disables sharing the auto recovery interval of **10** seconds among all errdisable interfaces.

```
switch(config)#no errdisable recovery interval 10
switch(config)#
```

- This command displays the reason for a port entering the errdisable state.

```
switch(config)#show interfaces status errdisabled
```

| Port  | Name | Status      | Reason         |
|-------|------|-------------|----------------|
| Et3/2 |      | errdisabled | arp-inspection |

```
switch(config)#
```

## Configure Static IP MAC Binding

The ARP inspection command [ip source binding](#) allows users to add static IP-MAC binding. If enabled, ARP inspection verifies incoming ARP packets based on the configured IP-MAC bindings. The static IP-MAC binding entry can only be configured on Layer 2 ports. By default, there is no binding entry on the system.

### Examples:

- This command configures static IP-MAC binding for IP address **127.0.0.1**, MAC address **0001.0001.0001**, **VLAN 1**, and Ethernet interface **slot 4** and **port 1**.

```
switch(config)#ip source binding 127.0.0.1 0001.0001.0001 vlan
1 interface
ethernet 4/1
switch(config)#
```

- This command configures static IP-MAC binding for IP address **127.0.0.1**, MAC address **0001.0001.0001**, **VLAN 1**, and **port-channel interface 20**.

```
switch(config)#ip source binding 127.0.0.1 0001.0001.0001 vlan
1 interface
port-channel 20
switch(config)#
```

- This command displays the configured IP-MAC binding entries. Note that the Lease column is mainly used for displaying dynamic DHCP snooping binding entries. For static binding entries, lease time is shown as infinite.

```
switch(config)#show ip source binding 127.0.0.1 0001.0001.0001
static vlan 1
interface port-channel 20
```

| MacAddress     | IpAddress | Lease(sec) | Type   | VLAN | Interface      |
|----------------|-----------|------------|--------|------|----------------|
| 0001.0001.0001 | 127.0.0.1 | infinite   | static | 1    | Port-Channel20 |

```
switch(config)#
```

## 12.1.2 IPv4 Routing

Internet Protocol version 4 (IPv4) is a communications protocol used for relaying network packets across a set of connected networks using the Internet Protocol suite. Routing transmits network layer data packets over connected independent subnets. Each subnet is assigned an IP address range and each device on the subnet is assigned an IP address from that range. The connected subnets have IP address ranges that do not overlap.

A router is a network device that connects multiple subnets. Routers forward inbound packets to the subnet whose address range includes the packets' destination address. IPv4 and IPv6 are internet layer protocols that define packet-switched internetworking, including source-to-destination datagram transmission across multiple networks.

These sections describe IPv4 routing and route creation options:

- [Enabling IPv4 Routing](#)
- [Static and Default IPv4 Routes](#)
- [Dynamic IPv4 Routes](#)
- [Viewing IPv4 Routes and Network Components](#)

### 12.1.2.1 Enabling IPv4 Routing

When IPv4 routing is enabled, the switch attempts to deliver inbound packets to destination IPv4 addresses by forwarding them to interfaces or next hop addresses specified by the forwarding table.

The [ip routing](#) command enables IPv4 routing.

#### Example

This command enables IP routing:

```
switch(config)#ip routing
switch(config)#
```

### 12.1.2.2 Static and Default IPv4 Routes

Static routes are entered through the CLI and are typically used when dynamic protocols are unable to establish routes to a specified destination prefix. Static routes are also useful when dynamic routing protocols are not available or appropriate. Creating a static route associates a destination IP address

---

with a local interface. The routing table refers to these routes as connected routes that are available for redistribution into routing domains defined by dynamic routing protocols.

The `ip route` command creates a static route. The destination is a network segment; the nexthop is either an IP address or a routable interface port. When multiple routes exist to a destination prefix, the route with the lowest administrative distance takes precedence.

By default, the administrative distance assigned to static routes is **1**. Assigning a higher administrative distance to a static route configures it to be overridden by dynamic routing data. For example, a static route with a distance value of **200** is overridden by OSPF intra-area routes, which have a default distance of **110**.

A route tag is a 32-bit number that is attached to a route. Route maps use tags to filter routes. Static routes have a default tag value of **0**.

#### Example

This command creates a static route:

```
switch(config)#ip route 172.17.252.0/24 vlan 500
switch(config)#
```

### Creating Default IPv4 Routes

The default route denotes the packet forwarding rule that takes effect when no other route is configured for a specified IPv4 address. All packets with destinations that are not established in the routing table are sent to the destination specified by the default route.

The IPv4 destination prefix is `0.0.0.0/0` and the next-hop is the default gateway.

#### Example

This command creates a default route and establishes `192.14.0.4` as the default gateway address:

```
switch(config)#ip route 0.0.0.0/0 192.14.0.4
switch(config)#
```

### 12.1.2.3 Dynamic IPv4 Routes

Dynamic routes are established by dynamic routing protocols. These protocols also maintain the routing table and modify routes to adjust for topology or traffic changes. Routing protocols assist the switch in communicating with other devices to exchange network information, maintaining routing tables, and establishing data paths.

The switch supports these dynamic IPv4 routing protocols:

- [OSPFv2 Introduction](#)
- [Border Gateway Protocol \(BGP\)](#)
- [Routing Information Protocol \(RIP\)](#)
- [IS-IS](#)

## 12.1.2.4 Viewing IPv4 Routes and Network Components

### Displaying the FIB and Routing Table

The `show ip route` command displays routing table entries that are in the forwarding information base (FIB), including static routes, routes to directly connected networks, and dynamically learned routes. Multiple equal-cost paths to the same prefix are displayed contiguously as a block, with the destination prefix displayed only on the first line.

The `show running-config` command displays configured commands not in the FIB. The `show ip route summary` command displays the number of routes, categorized by source, in the routing table.

#### Examples

- This command displays IP routes learned through BGP.

```
switch>show ip route bgp

Codes: C - connected, S - static, K - kernel,
 O - OSPF, IA - OSPF inter area, E1 - OSPF external type
 1,
 E2 - OSPF external type 2, N1 - OSPF NSSA external type
 1,
 N2 - OSPF NSSA external type2, B I - iBGP, B E - eBGP,
 R - RIP, A - Aggregate

B E 170.44.48.0/23 [20/0] via 170.44.254.78
B E 170.44.50.0/23 [20/0] via 170.44.254.78
B E 170.44.52.0/23 [20/0] via 170.44.254.78
B E 170.44.54.0/23 [20/0] via 170.44.254.78
B E 170.44.254.112/30 [20/0] via 170.44.254.78
B E 170.53.0.34/32 [1/0] via 170.44.254.78
B I 170.53.0.35/32 [1/0] via 170.44.254.2
 via 170.44.254.13
 via 170.44.254.20
 via 170.44.254.67
 via 170.44.254.35
 via 170.44.254.98

switch>
```

- This command displays a summary of routing table contents.

```
switch>show ip route summary

Route Source Number Of Routes

connected 15
static 0
ospf 74
 Intra-area: 32 Inter-area:33 External-1:0 External-2:9
 NSSA External-1:0 NSSA External-2:0
bgp 7
 External: 6 Internal: 1
internal 45
attached 18
aggregate 0

switch>
```

---

## Displaying the IP Route Age

The `show ip route age` command displays the time when the route for the specified network was present in the routing table. It does not account for the changes in parameters like metric, next-hop etc.

### Example:

This command displays the amount of time since the last update to ip route **172.17.0.0/20**.

```
switch>show ip route 172.17.0.0/20 age

Codes: C - connected, S - static, K - kernel,
 O - OSPF, IA - OSPF inter area, E1 - OSPF external type 1,
 E2 - OSPF external type 2, N1 - OSPF NSSA external type 1,
 N2 - OSPF NSSA external type2, B I - iBGP, B E - eBGP,
 R - RIP, I - ISIS, A - Aggregate

B E 172.17.0.0/20 via 172.25.0.1, age 3d01h

switch>
```

## Displaying Gateways

A gateway is a router that provides access to another network. The gateway of last resort, also known as the default route, is the route that a packet uses when the route to its destination address is unknown. The IPv4 default route in is **0.0.0.0/0**.

The `show ip route gateway` command displays IP addresses of all gateways (next hops) used by active routes.

### Example

This command displays next hops used by active routes.

```
switch>show ip route gateway

The following gateways are in use:
172.25.0.1 Vlan101
172.17.253.2 Vlan2000
172.17.254.2 Vlan2201
172.17.254.11 Vlan2302
172.17.254.13 Vlan2302
172.17.254.17 Vlan2303
172.17.254.20 Vlan2303
172.17.254.66 Vlan2418
172.17.254.67 Vlan2418
172.17.254.68 Vlan2768
172.17.254.29 Vlan3020

switch>
```

## Displaying Host Routes

The `show ip route host` command displays all host routes in the host forwarding table. Host routes are those whose destination prefix is the entire address (mask = **255.255.255.255** or prefix = **/32**). Each displayed host route is labeled with its purpose:



- **F** static routes from the FIB.
- **R** routes defined because the IP address is an interface address.
- **B** broadcast address.
- **A** routes to any neighboring host for which the switch has an ARP entry.

### Example

This command displays all host routes in the host forwarding table.

```
switch#show ip route host

R - receive B - broadcast F - FIB, A - attached

F 127.0.0.1 to cpu
B 172.17.252.0 to cpu
A 172.17.253.2 on Vlan2000
R 172.17.253.3 to cpu
A 172.17.253.10 on Vlan2000
R 172.17.254.1 to cpu
A 172.17.254.2 on Vlan2901
B 172.17.254.3 to cpu
B 172.17.254.8 to cpu
A 172.17.254.11 on Vlan2902
R 172.17.254.12 to cpu

F 172.26.0.28 via 172.17.254.20 on Vlan3003
 via 172.17.254.67 on Vlan3008
 via 172.17.254.98 on Vlan3492
via 172.17.254.86 on Vlan3884
 via 172.17.253.2 on Vlan3000
F 172.26.0.29 via 172.25.0.1 on Vlan101
F 172.26.0.30 via 172.17.254.29 on Vlan3910
F 172.26.0.31 via 172.17.254.33 on Vlan3911
F 172.26.0.32 via 172.17.254.105 on Vlan3912

switch#
```

## 12.1.3 IPv4 Multicast Counters

IPv4 multicast counters allow association of IPv4 multicast routes with a packet or byte counter.

This chapter contains the following sections.

- [Multicast Counters Hardware Overview](#)
- [Multicast Counters iBGP and eBGP Configuration](#)
- [Configuring IPv4 Multicast Counters](#)

### 12.1.3.1 Multicast Counters Hardware Overview

This section describes a hardware overview for multicast counters, and contains the following sections.

- [Platform Independent Requirements for Counters](#)
- [Policer Counter Overview](#)
- [BGP Functions Supported for Arista Switches](#)
- [Additional Requirements](#)

---

#### 12.1.3.1.1 Platform Independent Requirements for Counters

The following platform independent requirements include:

- Enable/Disable counters
- Clear counters
- Show counters
- Configure counter mode for byte (default) or frame mode

#### 12.1.3.1.2 Policer Counter Overview

The switch hardware has two policer banks, each with 4k entries and each entry has one 32 bit entry1, and one 32 bit entry2, which can be used as either packet counter or byte counter.

In the pipeline, each bank can have one policer index coming from upstream blocks, which means different features cannot update multiple policer entries in the same bank simultaneously. Therefore, different features cannot share entries in the same bank.

In switch hardware routing, each FFU/BST entry points to a corresponding RAM. A policer index is saved in the action ram, so when installing a multicast route into hardware, platform code will get a policer index and saved in the action field. If a policer index is unavailable, a counter is not added to the action field.

Switch hardware can have multiple features competing for the policer banks. It is desirable to have a platform command to reserve policer banks dedicated for a certain feature.

The following command reserves one or two policer banks to be used only by the named feature:

```
[no] platform fm6000 [nat|acl|qos|multicast] policer banks <1|2>
```

Available bank(s) are reserved for the feature. Otherwise the command takes effect at the next reboot or FocalPointV2 agent restart. This reservation guarantees the configured number of bank(s) for this feature. However, the feature can still possibly obtain the other policer bank if it needs more, and the other bank is available.

If a feature has a pending reservation request which is not fulfilled because of availability, and some other feature frees a bank, the bank will be allocated to the pending feature.

#### 12.1.3.1.3 BGP Functions Supported for Arista Switches

Arista switches support these BGP functions:

- A single BGP instance
- Simultaneous internal (IBGP) and external (EBGP) peering
- Multiprotocol BGP
- BGP Confederations

#### 12.1.3.1.4 Additional Requirements

On switch hardware, the following additional requirements include:

- Reservation of policer banks
- Notification of policer bank availability when a policer entry is freed by other features

#### 12.1.3.2 Multicast Counters iBGP and eBGP Configuration

This section describes the commands required to configure an iBGP and an eBGP topology, and contains the following sections.

- [Policer Usage](#)

### 12.1.3.2.1 Policer Usage

There are two types of counters – those created by wildcard creation and by specific creation. When a specific counter is required and the hardware runs out of policer entries, a wildcard counter is forced to give up its policer entry.

If the user configures a specific counter and the Starter Group (SG) already has a wildcard-created counter for it, then this counter is upgraded to a specific one, with no change in hardware policer index. If the user configures both a wildcard counter and specific counter for this SG, and subsequently deletes the specific counter, the counter for this SG is downgraded to a wildcard, with no change in hardware policer index. However, if another specific counter is pending for a hardware policer index, then this policer entry will be assigned to that counter due to its higher precedence.

Even if a counter is configured by the user, in order to conserve the use of hardware resources, do not allocate a policer entry until a real route (G, S) is programmed into the frame filtering and forwarding unit (FFU).

### 12.1.3.3 Configuring IPv4 Multicast Counters

Perform the following CLI steps to configure IPv4 multicast counters on the FM6000 platform:

1. Execute the global configuration command:

- **no | default ip multicast count bytes | packets**

Enables wildcard counters. Also used to change bytes / packets mode. When hardware runs out of resources, specific creation has priority to preempt counters from wildcard creation. The **bytes | packets** optional keyword enables the counter to be in either bytes mode or packets mode. This mode applies to all counters. When the counter mode changes, all counter values will be reset to zero.

- **no | default ip multicast count <G> <S>**

This only takes effect when **ip multicast count** is enabled. Either **<G> <S>** or **bytes | packets** optional keyword is used. They can not be used concurrently.

No | default Commands: (default is same as no)

- **no ip multicast count** Deletes all multicast counters, including explicit **<G> <S>** routes
  - **no ip multicast count <G> <S>** Removes the config. Does not delete the counter because the wildcard is still active.
    - If no **<G, S>** is specified, all multicast routes will have counters unless the hardware runs out of resources. The creation of counters is referred to as “wildcard creation.”
    - If **<G, S>** is specified, only **<G, S>** will get a counter (and no other route). The creation of counters is referred to as “specific creation.” By default, all mcast routes will have counters allocated. This **<G, S>** configuration is applicable when the hardware runs out of resources. Specific **<G, S>** creation has priority to preempt counters from wildcard creation.

The **byte | frame** optional keyword enables the counter to be in either byte mode or frame mode. This mode applies to all counters. When the counter mode changes, all counter values will be reset to zero.

Either **<G, S>**, or **byte | frame** optional keywords are used but cannot be used together. All counters are **byte | frame**. The **byte | frame** mode is global, and not applicable on a **<G, S>** basis.

2. Execute clear command:

- ```
clear ip multicast count <G> <S>
```

3. Execute show command:

- ```
show multicast fib ipv4 <G> count
```

This command currently exists but does not show anything.

This show command is intended to display the following (example):

```
switch>show multicast fib ipv4 count
Activity poll time: 60 seconds
225.1.1.1 100.0.0.2
Byte: 123
Vlan100 (iif)
Vlan200
Activity 0:00:47 ago
```

Total counts is the sum of counts from all sources in that group.

The count value can be **N/A** if a mroute does not have an associated counter.

If the count value for any source in a **G** is **N/A**, then the total counts for **G** will be shown as **N/A**. However, the count values for other sources are still shown.

## 12.1.4 Route Management

When routing is enabled, the switch discovers the best route to a packet's destination address by exchanging routing information with other devices. IP routing is disabled by default.

The following sections describes routing features that the switch supports:

- [Route Redistribution](#)
- [Equal Cost Multipath Routing \(ECMP\) and Load Sharing](#)
- [Unicast Reverse Path Forwarding \(uRPF\)](#)
- [Routing Tables / Virtual Routing and Forwarding \(VRF\)](#)
- [RIB Route Control](#)

### 12.1.4.1 Route Redistribution

Route redistribution is the advertisement, into a dynamic routing protocol's routing domain, of connected (static) routes or routes established by other routing protocols. By default, the switch advertises only routes in a routing domain that are established by the protocol that defined the domain.

Route redistribution commands specify the scope of the redistribution action. By default, all routes from a specified protocol (or all static routes) are advertised into the routing domain. Commands can also filter routes by applying a route map, which defines the subset of routes to be advertised.

### 12.1.4.2 Equal Cost Multipath Routing (ECMP) and Load Sharing

Equal Cost Multi-Path (ECMP) is a routing strategy where traffic is forwarded over multiple paths that have equal routing metric values.

#### Configuring ECMP (IPv4)

All ECMP paths are assigned the same tag value; commands that change the tag value of a path also change the tag value of all paths in the ECMP route.

In a network topology using ECMP routing, hash polarization may result when all switches perform identical hash calculations. Hash polarization leads to uneven load distribution among the data paths. Hash polarization is avoided when switches use different hash seeds to perform hash calculations.

The `ip load-sharing` command provides the hash seed to an algorithm that the switch uses to distribute data streams among multiple equal-cost routes to a specified subnet.

#### Example

This command sets the IPv4 load sharing hash seed to **20**:

```
switch(config)#ip load-sharing fm6000 20
switch(config)#
```

### Multicast Traffic Over ECMP

The switch attempts to spread outbound unicast and multicast traffic to all ECMP route paths equally. To disable the sending of multicast traffic over ECMP, use the `multipath none` command or the no version of the `multipath deterministic` command.

### Resilient ECMP

Resilient ECMP is used for those prefixes where it is not desirable for routes to be rehashed due to link flap, typically where ECMP is being used for load balancing. Resilient ECMP configures a fixed number of next-hop entries in the hardware ECMP table for all the routes within a specified IP address prefix. Implementing fixed table entries for a specified next-hop address allows data flows that are hashed to a valid next-hop number to remain intact even when some of the next hops go down or come back online.

Resilient ECMP is enabled for all routes within a specified prefix using the `ip hardware fib ecmp resilience` command. The command specifies the maximum number of next-hop addresses that the hardware ECMP table can contain for the specified IP prefix, and configures a redundancy factor that facilitates the duplication of next-hop addresses in the table. The fixed table space for the address is the maximum number of next hops multiplied by the redundancy factor. When the table contains the maximum number of next-hop addresses, the redundancy factor specifies the number of times each address is listed in the table. When the table contains fewer than the maximum number of next-hop addresses, the table space entries are filled by additional duplication of the nexthop addresses.

Resilient ECMP is also available for IPv6 IP addresses.

#### Example

This command configures a hardware ECMP table space of 24 entries for the IP address **10.14.2.2/24**. A maximum of six next-hop addresses can be specified for the IP address. When the table contains six next-hop addresses, each appears in the table four times. When the table contains fewer than six next-hop addresses, each is duplicated until the 24 table entries are filled.

```
switch(config)#ip hardware fib ecmp resilience 10.14.2.2/24
capacity 6 redundancy 4
switch(config)#
```

### 12.1.4.3 Unicast Reverse Path Forwarding (uRPF)

Unicast Reverse Path Forwarding (uRPF) verifies the accessibility of source IP addresses in packets that the switch forwards. The switch drops a packet when uRPF determines that the routing table does not contain an entry with a valid path to that packet's source IP address.

---

IPv4 and IPv6 uRPF operate independently. uRPF is VRF aware. Commands that do not specify a VRF utilize the default instance. Multicast routing is not affected by uRPF.

uRPF defines two operational modes: strict mode and loose mode.

- **Strict mode:** uRPF also verifies that a packet is received on the interface that its routing table entry will use for its return packet.
- **Loose mode:** uRPF validation does not consider the inbound packet's ingress interface.

#### 12.1.4.3.1 uRPF Operation

uRPF is configurable on interfaces. For packets arriving on a uRPF-enabled interfaces, the source IP address is verified by examining the source and destination addresses of unicast routing table entries.

uRPF requires a reconfigured routing table to support IP address verification. When uRPF is enabled for the first time, unicast routing is briefly disabled to facilitate the routing table reconfiguration. Multicast routing is not affected by the initial uRPF enabling.

A packet fails uRPF verification if the table does not contain an entry whose source or destination address matches the packet's source IP address. In strict mode, the uRPF also fails when the matching entry's outbound interface does not match the packet's ingress interface.

uRPF verification is not available for the following packets:

- DHCP (Source is **0.0.0.0** – Destination is **255.255.255.255**)
- IPv6 link local (**FE80::/10**)
- Multicast packets

#### ECMP uRPF

When verifying ECMP routes, strict mode checks all possible paths to determine that a packet is received on the correct interface. Strict mode is supported for ECMP groups with a maximum of eight routing table entries. The switch reverts to loose mode for ECMP groups that exceed eight entries.

#### Default Routes

uRPF strict mode provides an **allow-default** option that accepts default routes. On interfaces that enable allow-default and a default route is defined, uRPF strict mode validates a packet even when the routing table does not contain an entry that matches the packet's source IP address. When allow-default is not enabled, uRPF does not consider the default route when verifying an inbound packet.

#### Null Routes

**NULL0** routes drop traffic destined to a specified prefix. When uRPF is enabled, traffic originating from a null route prefixes is dropped in strict and loose modes.

#### 12.1.4.3.2 uRPF Configuration

Unicast Reverse Path Forwarding (uRPF) is enabled for IPv4 packets ingress the configuration mode interface through the **ip verify** command.

 **Note:** uRPF cannot be enabled on interfaces with ECMP member FECs.

#### Examples

- This command enables uRPF loose mode on **interface vlan 17**.

```
switch(config)#interface vlan 17
switch(config-if-Vl17)#ip verify unicast source reachable-via
any
```

```
switch(config-if-Vl17)#show active
interface Vlan17
 ip verify unicast source reachable-via any
switch(config-if-Vl17)#
```

- This command enables uRPF strict mode on **interface vlan 18**.

```
switch(config)#interface vlan 18
switch(config-if-Vl18)#ip verify unicast source reachable-via
rx
switch(config-if-Vl18)#show active
interface Vlan18
 ip verify unicast source reachable-via rx
switch(config-if-Vl18)#
```

#### 12.1.4.4 Routing Tables / Virtual Routing and Forwarding (VRF)

An IP routing table is a data table that lists the routes to network destinations and metrics (distances) associated with those routes. A routing table is also known as a Routing Information Base (RIB).

Virtual Routing and Forwarding (VRF) allows traffic separation by maintaining multiple routing tables. Arista switches support multiple VRF instances: one global or default VRF called “default” and multiple user-defined VRFs; the number of user-defined VRFs supported varies by platform. VRFs can be used as management or data plane VRFs.

- Management VRFs have routing disabled. They are typically used for management-related traffic.
- Dataplane VRFs have routing enabled. They support routing protocols and packet forwarding (hardware and software).

Dataplane VRFs are supported by Trident, FM6000, and Arad platform switches.

VRFs support unicast IPv4 and IPv6 traffic and multicast traffic. Loopback, SVI, and routed ports may be added to VRFs. Management ports may be added without any hardware forwarding.

To allow overlap in the sets of IP addresses used by different VRF instances, a Route Distinguisher (RD) may be prepended to each address. RDs are defined in **RFC 4364**.

##### 12.1.4.4.1 Default VRF

The default VRF on Arista switches is called “default.” It is created automatically and cannot be renamed or configured. Some configuration options accept “default” as a VRF input.

#### 12.1.4.4.2 User-Defined VRFs

A user-defined VRF is created with the `vrf instance` command. After its creation, a VRF may be assigned a route distinguisher (RD) with the `rd (VRF configuration mode)` command in the VRF submode of Router-BGP Configuration Mode.

##### Examples

- These commands create a VRF named **purple**, place the switch in BGP VRF configuration mode for that VRF, and specify a route distinguisher for the VRF identifying the administrator as **AS 530** and assigning **12** as its local number.

```
switch(config)#vrf instance purple
switch(config-vrf-purple)#router bgp 50
switch(config-router-bgp)#vrf purple
switch(config-router-bgp-vrf-purple)#rd 530:12
switch(config-router-bgp-vrf-purple)#
```

- To add interfaces to a user-defined VRF, enter configuration mode for the interface and use the `vrf (Interface mode)` command. Loopback, SVI, and routed ports can be added to a VRF.

These commands add **VLAN 20** to the VRF named **purple**.

```
switch(config)#interface VLAN 20
switch(config-if-Vl20)#vrf purple
switch(config-if-Vl20)#
```

- The `show vrf` command shows information about user-defined VRFs on the switch.

This command displays information for the VRF named **purple**.

```
switch>show vrf purple
Vrf RD Protocols State

Interfaces

purple 64496:237 ipv4 no routing
 Vlan42, Vlan43

switch>
```



#### 12.1.4.4.2.1rd (VRF configuration mode)

The `rd` command issued in VRF Configuration Mode is a legacy command supported for backward compatibility. To configure a route distinguisher (RD) for a VRF, use the `rd` (VRF configuration mode) command.

 **Note:** Legacy RDs that were assigned to a VRF in VRF Configuration Mode will still appear in `show vrf` outputs if an RD has not been configured in Router-BGP VRF Configuration Mode, but they no longer have an effect on the system.

#### 12.1.4.4.3 Context-Active VRF

The context-active VRF specifies the default VRF that VRF-context aware commands use when displaying or refreshing routing table data.

VRF-context aware commands include:

- `clear arp-cache`
- `show ip`
- `show ip arp`
- `show ip route`
- `show ip route gateway`
- `show ip route host`

The `cli vrf` command specifies the context-active VRF.

##### Example

This command specifies *magenta* as the context-active VRF.

```
switch#cli vrf magenta
switch#show routing-context vrf
Current VRF routing-context is magenta
```

The `show routing-context vrf` command displays the context-active VRF.

##### Example

This command displays the context-active VRF.

```
switch>show routing-context vrf
Current VRF routing-context is magenta

switch>
```

#### 12.1.4.5 RIB Route Control

The Routing Information Base (RIB) is composed of the routing information learned by the routing protocols, including static routes. The Forwarding Information Base (FIB) is composed of the routes actually used to forward traffic through a router.

Forwarding Information Base (FIB) makes IP destination prefix-based switching decisions. The FIB is similar to a routing table or information base. It maintains the forwarding information for the winning routes from the RIB. When routing or topology changes occur in the network, the IP routing table information is updated, and those changes are reflected in the FIB.

### 12.1.4.5.1 Configuring FIB policy

The RIB calculates the best/winning routes to each destination and place these routes in the forwarding table. Based on the FIB policy configured the best routes are advertised.

For example, a FIB policy can be configured to deny the routes for FIB programming, however, it does not prevent these routes from being advertised by a routing protocol, or to be redistributed into another routing domain, or to be used for recursive resolution in the IP RIB. FIB policies control the size and content of the routing tables, and the best route to take to reach a destination.

The `rib ipv4 | ipv6 fib policy` command is used to enable FIB policy for a particular VRF under router general configuration mode.

The following match statements are supported:

- match interface
- match [ ip | ipv6 ] address prefix-list
- match [ ip | ipv6 ] resolved-next-hop prefix-list
- match isis level
- match metric
- match source-protocol

#### Example

The following example enables FIB policy for IPv4 in the default VRF, using the route map, *map1*.

```
switch(config)#router general
switch(config-router-general)#vrf default
switch(config-router-general-vrf-default)#rib ipv4 fib policy
map1
```

### 12.1.4.5.2 Displaying FIB Information

Use the `show rib route <ipv4|ipv6> fib policy exclude` command to display the RIB information. The `fib policy exclude` option displays the RIB routes that have been excluded from being programmed into FIB, by FIB policy.

#### Example

The following example displays the routes filtered by FIB policy using the `fib policy excluded` option of the `show rib route ip|ipv6` command.

```
switch#show rib route ipv6 fib policy excluded
switch#show rib route ip bgp fib policy excluded

VRF name: default, VRF ID: 0xfe, Protocol: bgp
Codes: C - Connected, S - Static, P - Route Input
 B - BGP, O - Ospf, O3 - Ospf3, I - Isis
 > - Best Route, * - Unresolved Nexthop
 L - Part of a recursive route resolution loop
>B 10.1.0.0/24 [200/0]
 via 10.2.2.1 [115/20] type tunnel
 via 10.3.5.1, Ethernet1
 via 10.2.0.1 [115/20] type tunnel
 via 10.3.4.1, Ethernet2
 via 10.3.6.1, Ethernet3
>B 10.1.0.0/24 [200/0]
```

```

via 10.2.2.1 [115/20] type tunnel
 via 10.3.5.1, Ethernet1
via 10.2.0.1 [115/20] type tunnel
 via 10.3.4.1, Ethernet2
 via 10.3.6.1, Ethernet3

```

### 12.1.4.5.3 Displaying RIB Route Information

Use the [show rib route ip](#) command to view the IPv4 RIB information.

#### Example:

This command displays IPv4 RIB static routes.

```

switch#show rib route ip static

VRF name: default, VRF ID: 0xfe, Protocol: static
Codes: C - Connected, S - Static, P - Route Input
 B - BGP, O - Ospf, O3 - Ospf3, I - Isis
 > - Best Route, * - Unresolved Nexthop
 L - Part of a recursive route resolution loop
>S 10.80.0.0/12 [1/0]
 via 172.30.149.129 [0/1]
 via Management1, directly connected
>S 172.16.0.0/12 [1/0]
 via 172.30.149.129 [0/1]
 via Management1, directly connected

switch#

```

## 12.1.5 IPv4 Route Scale

IPv4 routes are optimized to achieve route scale when route distribution has a large number of routes of one or two parameters, with each parameter consisting of prefix lengths 12, 16, 20, 24, 28, and 32. If two separate prefix lengths are configured (in any order), one of them must be the prefix length of 32.



**Note:** IPv4 Route Scale cannot be used with AlgoMatch.

The following sections describes IPv4 route scale configuration, show commands, and system log messages:

- [Configuring IPv4 Route Scale](#)
- [IPv4 Routescale with 2-to-1 Compression](#)
- [Show Commands](#)

### 12.1.5.1 Configuring IPv4 Route Scale

IPv4 route scale is enabled by the [ip hardware fib optimize](#) command for the configuration mode interface. The platform Layer 3 agent is restarted to ensure IPv4 routes are optimized with the [agent SandL3Unicast terminate](#) command for the configuration mode interface.

#### Example

---

This configuration command allows configuring prefix lengths **12** and **32**.

```
switch(config)#ip hardware fib optimize exact-match prefix-length
12 32
! Please restart layer 3 forwarding agent to ensure IPv4 routes
are optimized
```

One of the two prefixes in this command is a prefix-length of **32**, which is required in the instance where there are two prefixes. For this command to take effect, the platform Layer 3 agent must be restarted.

#### Example

This configuration command restarts the platform Layer 3 agent to ensure IPv4 routes are optimized.

```
switch(config)#agent SandL3Unicast terminate
SandL3Unicast was terminated
```

Restarting the platform Layer 3 agent results in deletion of all IPv4 routes, which are re-added to the hardware.

#### Example:

This configuration command allows configuring prefix lengths **32** and **16**.

```
switch(config)#ip hardware fib optimize exact-match prefix-length
32 16
! Please restart layer 3 forwarding agent to ensure IPv4 routes
are optimized
```

One of the two prefixes in this command is a prefix-length of **32**, which is required in the instance where there are two prefixes. For this command to take effect, the platform Layer 3 agent must be restarted.

#### Examples

- This configuration command restarts the platform Layer 3 agent to ensure IPv4 routes are optimized.

```
switch(config)#agent SandL3Unicast terminate
SandL3Unicast was terminated
```

Restarting the platform Layer 3 agent results in deletion of all IPv4 routes, which are re-added to the hardware.

- This configuration command allows configuring prefix length **24**.

```
switch(config)#ip hardware fib optimize exact-match prefix-
length 24
```

```
! Please restart layer 3 forwarding agent to ensure IPv4
 routes are optimized
```

In this instance, there is only one prefix-length, so a prefix-length of **32** is not required. For this command to take effect, the platform Layer 3 agent must be restarted.

### Examples

- This configuration command restarts the platform Layer 3 agent to ensure IPv4 routes are optimized.

```
switch(config)#agent SandL3Unicast terminate
SandL3Unicast was terminated
```

Restarting the platform Layer 3 agent results in deletion of all IPv4 routes, which are re-added to the hardware.

- This configuration command allows configuring prefix length 32.

```
switch(config)#ip hardware fib optimize exact-match prefix-
length 32
! Please restart layer 3 forwarding agent to ensure IPv4
 routes are optimized
```

For this command to take effect, the platform Layer 3 agent must be restarted.

- This configuration command restarts the platform Layer 3 agent to ensure IPv4 routes are optimized.

```
switch(config)#agent SandL3Unicast terminate
SandL3Unicast was terminated
```

Restarting the platform Layer 3 agent results in deletion of all IPv4 routes, which are re-added to the hardware.

- This configuration command disables configuring prefix lengths **12** and **32**.

```
switch(config)#no ip hardware fib optimize exact-match prefix-
length 12 32
! Please restart layer 3 forwarding agent to ensure IPv4
 routes are not optimized
```

One of the two prefixes in this command is a prefix-length of **32**, which is required in the instance where there are two prefixes. For this command to take effect, the platform Layer 3 agent must be restarted.

### Examples

- This configuration command restarts the platform Layer 3 agent to ensure IPv4 routes are not optimized.

```
switch(config)#agent SandL3Unicast terminate
SandL3Unicast was terminated
```

Restarting the platform Layer 3 agent results in deletion of all IPv4 routes, which are re-added to the hardware.

- This configuration command attempts to configure prefix length **20** and **28** which triggers an error exception. One of the two prefixes in this command must be a prefix-length of **32**, which is required in the instance where there are two prefixes.

```
switch(config)#ip hardware fib optimize exact-match prefix-length 20 28
% One of the prefix lengths must be 32
```

### 12.1.5.2 IPv4 Routescale with 2-to-1 Compression

The IPv4 routescale with 2-to-1 compression optimizes certain prefix lengths and enhances the route scale capabilities on 7500R, 7280R, 7500R2, and 7280R2 platforms. The compression is best suited to achieve route scale when route distribution has a large number of routes of one or two prefix lengths.

#### 12.1.5.2.1 Configuring IPv4 Routescale 2-to-1 Compression

Use the **compress** command to increase the hardware resources available for the specified prefix length. This command allows configuring up to one compressed prefix length, and this command is supported only on 7500R, 7280R, 7500R2, and 7280R2 platforms.



**Note:** The **compress** command takes effect only when you restart the platform layer3 agent on 7500R, 7280R, 7500R2, and 7280R2 platforms. Use command **agent SandL3Unicast terminate** to restart the platform layer3 agent.

#### Examples

- In the following example we are configuring prefix length 20 and 24, expanding prefix length 19 and 23, and compressing prefix length 25.

```
switch(config)#ip hardware fib optimize prefix-length 20 24 expand 19
23 compress 25
! Please restart layer 3 forwarding agent to ensure IPv4 routes are
optimized
```

- In the following example we are configuring prefix length 20 and 23, expanding prefix length 19, compressing prefix length 24.

```
switch(config)#ip hardware fib optimize prefix-length 20 23 expand 19
compress 24
! Please restart layer 3 forwarding agent to ensure IPv4 routes are
optimized
```

- Optionally, you can also use the **internet** profile to configure the IPv4 route scale compression.

```
switch(config)#ip hardware fib optimize prefixes profile internet
! Please restart layer 3 forwarding agent to ensure IPv4 routes are
optimized
```

Configure a new TCAM profile for the **compress** configuration to work, and disable a few features in the new TCAM profile to make space for the flex-route feature in the hardware. Features like **acl vlan ip** and the **mirror ip** have to be disabled, if you need any of these features or any other features to be enabled with flex-route feature, contact the Arista team.

The **internet** profile works differently based on whether the flex-route feature is enabled in the TCAM profile or not. If the flex-route feature is enabled, the **internet** profile behaves like **ip hardware fib optimize prefix-length 20 23 expand 19 22 compress 24**. If the flex-route feature is

disabled, the **internet** profile behaves as `ip hardware fib optimize prefix-length 20 24 expand 19 23`.

### Example

```
switch(config)#hardware tcam
switch(config-hw-tcam)#profile flex-route copy default
switch(config-hw-tcam-profile-flex-route)#feature flex-route copy system-
feature-source-profile
switch(config-hw-tcam-profile-flex-route-feature-flex-route)#exit
switch(config-hw-tcam-profile-flex-route)#no feature acl vlan ip
switch(config-hw-tcam-profile-flex-route)#no feature mirror ip
switch(config-hw-tcam-profile-flex-route)#exit
Saving new profile 'flex-route'
switch(config-hw-tcam)#system profile flex-route
```

#### 12.1.5.2.2 Limitations

- A maximum of two prefix lengths can be optimized directly at any point of time, of which only one can be a non-nibble aligned prefix length. Additional prefix lengths can be optimized using the **expand** or the **compress** options.
- A maximum of 1-to-4 way expansion and 2-to-1 way compression into any optimized prefix length is supported. Multiple expansion prefix lengths can be programmed at any time, however, there can be just one compression prefix length programmed at any given point in time.
- A maximum of 4096 next-hops can be reliably pointed to by the compressed prefixes using 2-to-1 way compression.
- The 2-to-1 compression cannot be enabled along with unicast RPF. When both features are enabled together, unicast RPF functionality may not be correct.
- The flex-route feature in TCAM profiles based only on the default profile, while disabling the **acl vlan ip** and the **mirror ip** features. Contact the Arista team if any other feature, that is not available in the default TCAM profile, is required to be supported along with the flex-route feature, including support for Mirror to GRE tunnel or ACLs on SVI.
- VXLAN is not supported with the compress option of this feature. There is no Syslog or a warning message when VXLAN is configured along with the 2-to-1 way compression feature.

#### 12.1.5.3 Show Commands

The IPv4 route scale summary is displayed by the `show platform arad ip route summary` command for the configuration mode interface. Resources for all IPv4 route scale routes are displayed by the `show platform arad ip route` command for the configuration mode interface.

#### Examples

- This command shows hardware resource usage of IPv4 routes.

```
switch(config)#show platform arad ip route summary

Total number of VRFs: 1
Total number of routes: 25
Total number of route-paths: 21
Total number of lem-routes: 4
```

- This command shows resources for all IPv4 routes in hardware. Routes that use the additional hardware resources appear with an asterisk (\*).

```
switch(config)#show platform arad ip route

Tunnel Type: M(mpls), G(gre)
* - Routes in LEM
```

```

Routing Table
VRF
ID
Code | Index|Index|T Value

|0 | 0.0.0.0/8 |TRAP |CoppSystemL3DstMiss|0 | - |ArpTrap
| | | - |1030 | -
|0 | 100.1.0.0/32 |TRAP |CoppSystemIpBcast |0 | - |BcastReceive
| | | - |1032 | -
|0 | 100.1.0.0/32 |TRAP |CoppSystemIpUcast |0 | - |Receive
| | | - |32766| -
|0 | 100.1.255.255/32|TRAP |CoppSystemIpBcast |0 | - |BcastReceive
| | | - |1032 | -
|0 | 200.1.255.255/32|TRAP |CoppSystemIpBcast |0 | - |BcastReceive
| | | - |1032 | -
|0 | 200.1.0.0/16 |TRAP |CoppSystemL3DstMiss|1007| - |ArpTrap
| | | - |1029 | -
|0 | 0.0.0.0/0 |TRAP |CoppSystemL3LpmOver|0 | - |SlowReceive
| | | - |1024 | -
|0 | 4.4.4.0/24* |ROUTE|Et10 |1007| - |00:01:00:02:
00:03| - |1033 |
|0 | 10.20.30.0/24* |ROUTE|Et9 |1006| - |00:01:00:02:
00:03| - |1027 |

```

## 12.1.6 IP Source Guard

IP Source Guard (IPSG) prevents IP spoofing attacks.

IP Source Guard (IPSG) filters inbound IP packets based on their source MAC and IP addresses. IPSG is supported in hardware. IPSG enabled on a Layer 2 port verifies IP packets received on this port. Packets are permitted if each packet source MAC and IP addresses match any of the user-configured IP-MAC binding entries on the receiving VLAN and port. Packets with no match are dropped immediately.

### 12.1.6.1 Configuring IPSG

IPSG is applicable only to Layer 2 ports, and is enabled by the `ip verify source` command for the configuration mode interface. When configured on Layer 3 ports, IPSG does not take effect until this interface is converted to Layer 2.

IPSG is supported on Layer 2 Port-Channels, not member ports. The IPSG configuration on port channels supersedes the configuration on the physical member ports. Therefore, source IP MAC binding entries should be configured on port channels using the `ip source binding` command. When configured on a port channel member port, IPSG does not take effect until this port is deleted from the port channel configuration.

#### Examples:

- These configuration commands exclude VLAN IDs 1 through 3 from IPSG filtering. When enabled on a trunk port, IPSG filters the inbound IP packets on all allowed



VLANs. IP packets received on VLANs 4 through 10 on *Ethernet 36* will be filtered by IPSPG, while those received on VLANs 1 through 3 are permitted.

```
switch(config)#no ip verify source vlan 1-3
switch(config)#interface ethernet 36
switch(config-if-Et36)#switchport mode trunk
switch(config-if-Et36)#switchport trunk allowed vlan 1-10
switch(config-if-Et36)#ip verify source
switch(config-if-Et36)#
```

- This configuration command configures source IP-MAC binding entries to IP address 10.1.1.1, MAC address 0000.aaaa.1111, VLAN ID 4094, and Ethernet interface 36.

```
switch(config)#ip source binding 10.1.1.1 0000.aaaa.1111 vlan
4094 interface ethernet 36
switch(config)#
```

### 12.1.6.2 Show Commands

The IPSPG configuration and operational states and IP-MAC binding entries are displayed by the [show ip verify source](#) command for the configuration mode interface.

#### Examples:

- This command verifies the IPSPG configuration and operational states.

```
switch(config)#show ip verify source

Interface Operational State

Ethernet1 IP source guard enabled
Ethernet2 IP source guard disabled
```

- This command displays all VLANs configured in **no ip verify source vlan**. Hardware programming errors, e.g., VLAN classification failed, are indicated in the operational state. If an error occurs, this VLAN will be considered as enabled for IPSPG. Traffic on this VLAN will still be filtered by IPSPG.

```
switch(config)#show ip verify source vlan

IPSPG disabled on VLANs: 1-2
VLAN Operational State

1 IP source guard disabled
2 Error: vlan classification failed
```

- This command displays all source IP-MAC binding entries configured for IPSPG. A source binding entry is considered active if it is programmed in hardware. IP traffic matching any active binding entry will be permitted. If a source binding entry is configured on an interface or a VLAN whose operational state is IPSPG disabled, this entry will not be installed in the hardware, in which case an “IP source guard disabled” state will be shown. If a port channel has no member port configured, binding entries configured for this port channel will not be installed in hardware, and a “Port-Channel down” state will be shown.

```
switch(config)#show ip verify source detail

Interface IP Address MAC Address VLAN State

Ethernet1 10.1.1.1 0000.aaaa.1111 5 active
```

---

```
Ethernet1 10.1.1.5 0000.aaaa.5555 1 IP source guard disabled
Port-Channel1 20.1.1.1 0000.bbbb.1111 4 Port-Channel down
```

## 12.1.7 DHCP Server

The router with DHCP Server enabled acts as a server that allocates and delivers network addresses with desired configuration parameters to its hosts.

The DHCP server is based on ISC Kea.

Support for DHCPv4 (**RFC 2131**) and DHCPv6 Server (**RFC 8415**) was added to **EOS Release 4.22.1** and **EOS Release 4.23.0** respectively.

The router with an DHCP Server enabled acts as a server that allocates and delivers network addresses with desired configuration parameters to its hosts.

DHCP Server support includes:

Starting with **EOS Release 4.22.1**: DHCPv4 support includes:

- Configurable on different interfaces: Routed, VLAN, LAG, Sub-interface, and LAG Sub-interface.
- Configurable lease time for allocated network addresses.
- Configurable DNS domain.
- Configurable DNS servers.
- Configurable subnets with parameters:
  - Default gateway
  - DNS servers
  - Ranges
  - Lease time

Starting with **EOS Release 4.23.0**: DHCPv6 support for all features in **EOS Release 4.22.1**, except for default gateway.

Beginning with **EOS Release 4.23.1**: Additional features for DHCPv4 include:

- Configurable TFTP server (DHCP option 66)
- Configurable TFTP bootfile (DHCP option 67)

Beginning with **EOS Release 4.23.2**: Additional features for DHCPv4 includes a configurable list of TFTP servers (DHCP option 150).

Beginning with **EOS Release 4.24.1**: Additional features for DHCPv4 includes:

- Configurable Vendor options with sub options (DHCP option 43)
- Configurable sub option types include: IPv4 address, array of IPv4 addresses, and string
- TFTP bootfile (DHCP option 67) now supports an URI

Beginning with **EOS Release 4.24.2**: Additional features for DHCPv4 include a configurable static IP address for exclusive use by a given client, based on the client's MAC address.

Example deployment:

DHCP Server on an aggregation switch, via VXLAN tunnels.

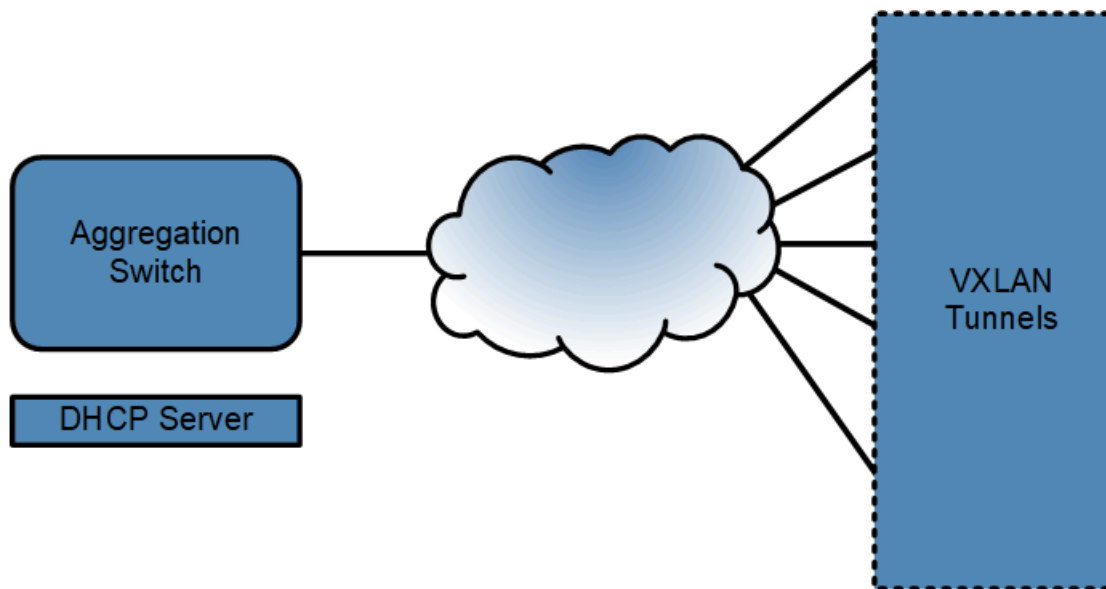

### 12.1.7.1 Platform Compatibility

All platforms support DHCP Server.

### 12.1.7.2 Configuration

You can enable DHCP Server per interface with the IPv4 or IPv6 address family option.

#### Example

```
switch(config)#interface Ethernet1
switch(config-if-Et1)#dhcp server ipv4

switch(config)#interface Ethernet2
switch(config-if-Et2)#dhcp server ipv6
```

For DHCPv4 to receive and reply to requests, minimum configurations of a valid subnet corresponding to the enabled interface with at least one valid range are required.

#### Example

```
switch(config)#interface Ethernet1
switch(config-if-Et1)#no switchport
switch(config-if-Et1)#dhcp server ipv4
switch(config-if-Et1)#ip address 10.0.0.1/8
switch(config-if-Et1)#dhcp server
switch(config-dhcp-server)#subnet 10.0.0.0/8
switch(config-if-Et1)#range 10.0.0.4 10.0.0.6
```

At least one non link-local address is required for DHCPv6.

## Example

```
switch(config)#interface Vlan1409
switch(config-if-vlan1409)#dhcp server ipv6
switch(config-dhcp-server)#ipv6 address fe80::1/10

switch(config-if-vlan1409)#dhcp server
 subnet fe80::/10
 range fe80::4 fe80::6
```

To enter DHCP Server global configuration mode (**config-dhcp-server**):

```
switch>config
switch(config)#dhcp server
switch(config-dhcp-server)#
```

To disable DHCP Server:

```
switch(config-dhcp-server)#disabled
switch(config)#
```

To set the lease time for allocated IP addresses. Lease time is configured globally and applied to all subnets. In the example, the lease time is set to 1 day.

```
switch>config
switch(config)#dhcp server
switch(config-dhcp-server)#lease time (ipv4|ipv6) 1 days 0 hours 0
minutes
```

To set the domain name for allocated IP addresses. In this example, the domain name is configured to **aristanetworks.com**.

```
switch>config
switch(config)#dhcp server
switch(config-dhcp-server)#dns domain name (ipv4|ipv6) aristanetworks.com
```

To set the DNS servers. You can only configure up to two servers. In this example, **10.2.2.2** for **DHCPv4** and **fe80::2** for **DHCPv6**.

```
switch>config
switch(config)#dhcp server
switch(config-dhcp-server)#dns server ipv4 10.2.2.2
switch(config-dhcp-server)#dns server ipv6 fe80::2
```

To set TFTP server. The server can be in the form of either an IP address or a fully qualified domain name. This is only available in DHCPv4. In this example, **TFTP** server **10.0.0.2**.

```
switch>config
switch(config)#dhcp server
switch(config-dhcp-server)#tftp server option 66 ipv4 10.0.0.2
```

To set a list of TFTP servers. The server can only be in the form of an IP address. This is only available in DHCPv4. In this example, **3.0.0.3** and **4.0.0.4** TFTP servers are configured.

```
switch>config
switch(config)#dhcp server
```

```
switch(config-dhcp-server) #tftp server option 150 ipv4 10.0.0.3 10.0.0.4
```

To set TFTP server boot file (such as DHCP option 67). This is only available in DHCPv4. In this example, TFTP boot file bootfile.conf is configured.

```
switch>config
switch(config) #dhcp server
switch(config-dhcp-server) #tftp server file ipv4 bootfile.conf
```

Or, a TFTP boot file URL //john.doe@www.example.com:123/example/one

```
switch>config
switch(config) #dhcp server
switch(config-dhcp-server) #tftp server file ipv4 https://john.
doe@www.example.com:123/example/one
```

To set a Vendor option, DHCP option 43, with sub options. Most of the time, different clients need different Vendor options. For this reason option 60, vendor class identifier, is used by the client to identify itself in order to request a specific Vendor option. To enter the Vendor option submode (**config-dhcp-vendor**) from (**config-dhcp-server**) config mode, specify a vendor class identifier. This is only available in DHCPv4.

```
switch>config
switch(config) #dhcp server
switch(config-dhcp-server) #vendor-option ipv4 vendorClassIDA
switch(config-dhcp-vendor) #
```

If **default** is specified, the configured Vendor option is sent to those clients requesting for a Vendor option whose vendor class identifier does not match any configured Vendor option. In this example, the default Vendor option for clients without a configured Vendor option.

```
switch>config
switch(config) #dhcp server
switch(config-dhcp-server) #vendor-option ipv4 default
```

The Vendor option may contain 0 or more sub options. The resulting Vendor option is sent in hexadecimal format to the desired client. In this example, the Vendor option holding a sub option with IPv4 address **10.0.0.1**, for clients with vendor class identifier **vendorClassIDA**, resulting in Vendor option **1:4:a:0:0:1**. The sub option number is **1**. Length of the Data is **4**. Data is **a:0:0:1**.

```
switch>config
switch(config) #dhcp server
switch(config-dhcp-server) #vendor-option ipv4 vendorClassIDA
switch(config-dhcp-vendor) #sub-option 1 type ipv4-address data 10.0.0.1
```

In this example, Vendor option holding a sub option with IPv4 addresses **10.0.0.5** and **10.0.0.6**, for clients with vendor class identifier **vendorClassIDA**. Resulting in Vendor option **fe:4:a:0:0:5:a:0:0:6**.

```
switch>config
switch(config) #dhcp server
switch(config-dhcp-server) #vendor-option ipv4 vendorClassIDA
switch(config-dhcp-vendor) #sub-option 254 type ipv4-address data 10.0.0.5
10.0.0.6
```

In this example, Vendor option holding a sub option with a string **FOO**, for all clients whose vendor class identifier does not match any configured Vendor option. Resulting in Vendor option **1e:3:46:4f:4f**.

```
switch>config
```

```
switch(config)#dhcp server
switch(config-dhcp-server)#vendor-option ipv4 default
switch(config-dhcp-vendor-option-default)#sub-option 30 type string data
"FOO"
```

In this example, Vendor option holding two sub options, where sub option 1 holds the IPv4 address **10.0.0.1**, and sub option 2 holds a string **FOO**, for all clients whose vendor class identifier does not match any configured Vendor option. Resulting in Vendor option **1:4:a:0:0:1:2:3:46:4f:4f**.

```
switch>config
switch(config)#dhcp server
switch(config-dhcp-server)#vendor-option ipv4 default
switch(config-dhcp-vendor-option-default)#sub-option 1 type ipv4-address
data 10.0.0.1
switch(config-dhcp-vendor-option-default)#sub-option 2 type string data
"FOO"
```

Configuration options for subnets are configured under IPv4 or IPv6 address family specific subnet submode (**config-dhcp-subnet**). To enter the submode from (**config-dhcp-server**) config mode, specify a subnet mask. In this example, **10.0.0.0/8** for DHCPv4 and **fe80::/10** for DHCPv6.

```
switch>config
switch(config)#dhcp server
switch(config-dhcp-server)#subnet 10.0.0.0/8
switch(config-dhcp-server)#subnet fe80::/10
```

There can be multiple subnets configured, but they must not overlap. If this happens, all overlapping subnets are disabled.

For DHCPv6, a subnet may match only one interface and vice versa; otherwise no lease is assigned for that subnet.

In this example. the user enables DHCPv6 on **Ethernet1** (with address **fe80::1/64**) and **Ethernet3** (with address **fe80::2/64**), then configures a subnet **fe80::/10** for the DHCPv6:

```
switch(config)#interface Ethernet1
switch(config-if-Et1)#no switchport
switch(config-if-Et1)#ipv6 address fe80::1/64
switch(config-if-Et1)#dhcp server ipv6

switch(config)#interface Ethernet3
switch(config-if-Et3)#no switchport
switch(config-if-Et3)#ipv6 address fe80::1/64
switch(config-if-Et3)#dhcp server ipv6

switch(config)#dhcp server
switch(config-dhcp-server)#subnet fe80::/1
```

To set default-gateway for a subnet. Only one default-gateway is allowed. This is only available in DHCPv4. In this example, **10.0.0.3** is configured as the default gateway for subnet **10.0.0.0/8**:

```
switch>config
switch(config)#dhcp server
switch(config-dhcp-server)#subnet 10.0.0.0/8
switch(config-dhcp-server-subnet-ipv4)#default-gateway 10.0.0.3
```

To set the DNS servers for a subnet. In this example, **10.1.1.1** and **10.2.2.2** for DHCPv4 and **fe80::1** and **fe80::2** for DHCPv6. The number of DNS servers cannot exceed two (2).

```
switch>config
```

```
switch(config)#dhcp server
switch(config-dhcp-server)#subnet 10.0.0.0/8
switch(config-dhcp-server-subnet-ipv4)#dns server 10.1.1.1 10.2.2.2
switch(config-dhcp-server-subnet-ipv4)#subnet fe80::/10
switch(config-dhcp-server-subnet-ipv6)#dns server fe80::1 fe80::2
```

To set the name of the subnet. In this example, the name *foo* for DHCPv4 and name *bar* for DHCPv6 are the selected names.

```
switch>config
switch(config)#dhcp server
switch(config-dhcp-server)#subnet 10.0.0.0/8
switch(config-dhcp-server-subnet-ipv4)#name foo
switch(config-dhcp-server-subnet-ipv4)#subnet fe80::/10
switch(config-dhcp-server-subnet-ipv6)#name bar
```

To set the range of IP addresses of the subnet. In this example, the IP address range for DHCPv4 is *10.0.0.1 to 10.0.0.10* and for DHCPv6 it is *fe80::1 fe80::5*. The range must be within the subnet mask, otherwise the subnet is disabled.

```
switch>config
switch(config)#dhcp server
switch(config-dhcp-server)#subnet 10.0.0.0/8
switch(config-)#range 10.0.0.1 10.0.0.10
switch(config-)#subnet fe80::/10
switch(config-)#range fe80::1 fe80::5
```

To set TFTP server for a subnet. The server can be in the form of either an IP address or a fully qualified domain name. This is only available in DHCPv4. In this example, *tftpserver.com* is configured.

```
switch>config
switch(config)#dhcp server
switch(config-dhcp-server)#subnet 10.0.0.8/24
switch(config-)#tftp server option 66 tftpserver.com
```

To set a list of TFTP servers. The server can only be in the form of an IP address. This is only available in DHCPv4. In this example, TFTP servers *3.0.0.3 4.0.0.4* are configured.

```
switch>config
switch(config)#dhcp server
switch(config-dhcp-server)#10.0.0.0/8
switch(config-)#tftp server option 150 3.0.0.3 4.0.0.4
```

To set a TFTP boot file for a subnet. This is only available in DHCPv4. In this example, *subnet-bootfile.conf* is configured.

```
switch>config
switch(config)#dhcp server
switch(config-dhcp-server)#subnet 10.0.0.0/8
switch(config-)#tftp server file subnet-bootfile.conf
```

To set a static IP address for exclusive use by a client, first enter the client's MAC address reservation submode.

To enter the MAC address reservation submode: (**config-dhcp-mac-address-ipv4**) from the (**config-dhcp-reservations-ipv4**) configuration mode, then specify the client's MAC address.

This is only available in DHCPv4. In this example, we use the static IP address of **10.0.0.1** for a client with MAC address of **1a1b.1c1d.1e1f**.

```
switch>config
switch(config)#dhcp server
switch(config-dhcp-server)#subnet 10.0.0.0/8
switch(config-)#reservations
switch(config-)#mac-address 1a1b.1c1d.1e1f
switch(config-)#ipv4-address 10.0.0.1
```

To enable a debug log and save log to a file (this disables kea syslog messages). In this example, you enable `/tmp/debug-dhcp.log` as the debug log.

```
switch>config
switch(config)#dhcp server
switch(config-dhcp-server)#debug log file:/tmp/debug-dhcp.log
```

### 12.1.7.3 Show Commands

Use the `show dhcp server` command to display DHCP server information.

- DHCPv4 display example:

```
switch#show dhcp server ipv4
IPv4 DHCP Server is active
Debug log is enabled
DNS server(s): 10.2.2.2
DNS domain name: domainFoo
Lease duration: 1 days 0 hours 0 minutes
TFTP server:
serverFoo (Option 66)
10.0.0.3 (Option 150)
TFTP file: fileFoo
Active Leases: 1
IPv4 DHCP interface status:
 Interface Status

Ethernet1 Inactive (Could not determine VRF)
Ethernet2 Inactive (Not in default VRF)
Ethernet3 Inactive (Kernel interface not created yet)
Ethernet4 Inactive (Not up)
Ethernet5 Inactive (No IP address)
Ethernet6 Active

Vendor information:
Vendor ID: default
 Sub-options Data

 1 192.0.2.0, 192.0.2.1

Vendor ID: vendorFoo
 Sub-options Data

 2 192.0.2.2
 3 "Foo"

Subnet: 10.0.0.0/8
Subnet name: subnetFoo
Range: 10.0.0.1 to 10.0.0.10
DNS server(s): 10.1.1.1 10.2.2.2
Lease duration: 3 days 3 hours 3 minutes
```



```

Default gateway address: 10.0.0.3
TFTP server:
subnetServerFoo (Option 66)
10.0.0.4 (Option 150)
TFTP boot file: subnetFileFoo
Active leases: 1
Reservations:
MAC address: 1a1b.1c1d.1e1f
IPv4 address: 10.0.0.1

MAC address: 2a2b.2c2d.2e2f
IPv4 address: 10.0.0.2

```

- For DHCPv6, there are two additional fields in subnet information output, **Direct** field and the **Relay** field. These two fields specify if the DHCP Server is accepting broadcast or relayed messages.

The **Direct** field displays **Active** when the subnet matches the interface with DHCPv6 configured. This indicates the server is accepting broadcast messages.

The **Direct** field displays **Inactive** when there is another existing subnet already matching the interface, or when the subnet matches more than one DHCP configured interface.

Examples of outputs for the DHCPv6 **show dhcp server** command:

In this example, DHCPv6 is configured with subnet **fe80::/10** while being enabled on **Ethernet1** with address **fe80::1/64** and on **Ethernet3** with address **fe80::2/64**.

```

switch#show dhcp server ipv6
IPv6 DHCP server is active
Debug log is enabled

DNS server(s): fe80::6

DNS domain name: testaristanetworks.com

Lease duration: 1 days 3 hours 30 minutes

Active leases: 0

IPv6 DHCP interface status:

 Interface Status

 Ethernet1 Active

```

---

```
Ethernet3 Active
```

```
Subnet: fe80::/10
```

```
Subnet name: foo
```

```
Range: fe80::1 to fe80::3
DNS server(s): fe80::4 fe80::5
```

```
Direct: Inactive (Multiple interfaces match this subnet: Ethernet1
Ethernet3)
Relay: Active
```

```
Active leases: 0
```

- This example illustrates when multiple subnets match an interface. In this example, DHCPv6 is configured with subnets **fc00::/7** and **fe80::/10** while being enabled on **Ethernet1** with address **fe80::1/10** and **fc00::1/7**.

```
switch#show dhcp server ipv6
IPv6 DHCP server is active
```

```
DNS server(s): fc00::2
```

```
DNS domain name: testaristanetworks.com
```

```
Lease duration: 1 days 3 hours 30 minutes
```

```
Active leases: 0
```

```
IPv6 DHCP interface status:
```

```
Interface Status
```

```

```

```
Ethernet1 Active
```

```
Subnet: fc00::/7
```

```
Subnet name: foo
```

```
Range: fc00::1 to fc00::5
```

```
DNS server(s): fc00::6 fc00::8
```

```
Direct: Inactive (This and other subnets match interface Ethernet1)
Relay: Active
```

```
Active leases: 0
```

```
Subnet: fe80::/10
```

```
Subnet name: bar
```

```
Direct: Inactive (This and other subnets match interface Ethernet1)
Relay: Active
```

```
Active leases: 0
```

- When a subnet is disabled, the **show dhcp server** command displays the disable message with a reason. The number of active leases of the disabled subnets will be 0. In this example, there are overlapping subnets.

```
switch#show dhcp server
IPv4 DHCP Server is active
DNS server(s): 10.2.2.2
Lease duration: 1 days 0 hours 0 minutes
Active Leases: 0
IPv4 DHCP interface status:
 Interface Status

 Ethernet1 Active

Subnet: 10.0.0.0/24 (Subnet is disabled - overlapping subnet
 10.0.0.0/8)
Range: 10.0.0.1 to 10.0.0.10
DNS server(s): 10.3.3.3 10.4.4.4
Default gateway address: 10.0.0.4
Active leases: 0

Subnet: 10.0.0.0/8 (Subnet is disabled - overlapping subnet
 10.0.0.0/24)
DNS server(s):
Default gateway address: 10.0.0.3
Active leases: 0
```

- In this example, the display output shows overlapping ranges.

```
switch#show dhcp server
IPv4 DHCP Server is active
DNS server(s): 10.2.2.2
Lease duration: 1 days 0 hours 0 minutes
Active Leases: 0
IPv4 DHCP interface status:
 Interface Status

 Ethernet1 Active

Subnet: 10.0.0.0/8 (Subnet is disabled - range 10.0.0.9-10.0.0.12
 overlaps with an existing pool)
Range: 10.0.0.1 to 10.0.0.10
Range: 10.0.0.9 to 10.0.0.12
DNS server(s): 10.3.3.3 10.4.4.4
Default gateway address: 10.0.0.4
Active leases: 0
```

- This example shows duplicate static IP address reservation.

```
Subnet: 10.0.0.0/8 (Subnet is disabled - ipv4-address 10.0.0.11 is
 reserved more than once)
Subnet name:
DNS server(s):
Default gateway address: 10.0.0.3
Active leases: 0
Reservations:
MAC address: 1a1b.1c1d.1e1f
```

```
IPv4 address: 10.0.0.11
MAC address: 2a2b.2c2d.2e2f
IPv4 address: 10.0.0.11
```

- Use the **show dhcp server leases** command to display detailed information about the IP addresses allocated by the DHCP Server (including the IP address, the expected end time for that address, the time when the address is handed out, and the equivalent MAC address).

```
switch#show dhcp server leases
10.0.0.10
End: 2019/06/20 17:44:34 UTC
Last transaction: 2019/06/19 17:44:34 UTC
MAC address: 5692.4c67.460a

2000:0:0:40::b

End: 2019/06/20 18:06:33 UTC

Last transaction: 2019/06/20 14:36:33 UTC

MAC address: 165a.a86d.ffac
```

#### 12.1.7.4 Limitations

The DHCP Server and DHCP Relay cannot be configured on the same router. The DHCP Relay has a higher precedence so the DHCP Server will be disabled when the DHCP Relay is configured.

If DHCPD is enabled on the router, configuring the EOS DHCP Server may cause DHCPD to crash or have unexpected behaviors.

During reload, the DHCP Server is not able to save its leases information. In a modular system, the second supervisor does not have an up-to-date lease database. The clients need to request for new leases. During the synchronizing phase for clients and server, duplicate IP addresses in the network may occur.

The DHCP Server is only supported on default VRF and it currently does not support legacy bootp requests.

All DHCP Server options must be less than 256 bytes in size, otherwise, the DHCP Server will not be able to send the affected option.

On certain platforms VXLAN Recirculation has to be enabled: [VXLAN Routing Configuration](#)

#### 12.1.8 DHCP Relay Global Configuration Mode

The [dhcp relay](#) command is configured under the global configuration mode. When configured, it places the switch on DHCP relay mode and allows the user to configure DHCP relay specific configuration on several interfaces with a single command. Furthermore, configuration entered in the DHCP Relay global configuration mode can be overridden by equivalent interface specific commands.

##### Example

- The `dhcp relay` command places the switch in the DHCP relay configuration mode.

```
switch(config)#dhcp relay
```

```
switch(config-dhcp-relay)#
```

It is possible to specify the IP address of the default DHCP or DHCPv6 Server. Multiple IP addresses can be specified and DHCP requests are forwarded to all specified helper addresses. This is equivalent to configuring **ip helper-address <IP\_Address>** under each desired routing interface.

- Example to forward DHCP broadcast packets received on interface Ethernet1 and Vlan2 to DHCP servers at **10.0.0.1**, **10.0.0.2**, and to hostname **DefaultDHCPHostname**:

```
switch(config)# interface Ethernet1
switch(config-if-Et1)# no switchport
switch(config-if-Et1)# ip address 192.168.1.1/16

switch(config)# interface Vlan2
switch(config-if-Et1)# ip address 172.16.1.1/16

switch(config)# dhcp relay
switch(config-dhcp-relay)# server 10.0.0.1
switch(config-dhcp-relay)# server 10.0.0.2
switch(config-dhcp-relay)# server DefaultDHCPHostname
```

- Example to forward DHCPv6 broadcast packet received on interface Ethernet1 to DHCPv6 Server at fc00::3.

```
switch(config)# interface Ethernet1
switch(config-if-Et1)# no switchport
switch(config-if-Et1)# ipv6 address fc00::1/10

switch(config)# dhcp relay
switch(config-dhcp-relay)# server fc00::3
```

This will point a routed interface to the specified DHCP and DHCPv6 server(s), if all the following criteria are met:

- The routed interface is in the default VRF
  - The interface has an IP address configured
  - The interface is not a Management or Loopback
- Example to remove the default DHCP or DHCPv6 Server.

```
switch(config)# dhcp relay
switch(config-dhcp-relay)# no server 10.0.0.1
switch(config-dhcp-relay)# no server 10.0.0.2
switch(config-dhcp-relay)# no server DefaultDHCPHostname
switch(config-dhcp-relay)# no server fc00::3
```

To override the default DHCP Server on an interface, **ip helper-address <IP\_Address>** must be used.

- Example to forward DHCP broadcast packet received on interface Ethernet1 to DHCP Servers at **10.0.0.1**, **10.0.0.2** and hostname **DefaultDHCPHostname**, but VLAN2s broadcast packets to DHCP Server at 10.0.0.3 only

```
switch(config)# interface Ethernet1
switch(config-if-Et1)# no switchport
switch(config-if-Et1)# ip address 192.168.1.1/16

switch(config)# interface Vlan2
switch(config-if-Et1)# ip address 172.16.1.1/16
switch(config-if-Et1)# ip helper-address 11.0.0.3

switch(config)# dhcp relay
```

```
switch(config-dhcp-relay)# server 10.0.0.1
switch(config-dhcp-relay)# server 10.0.0.2
switch(config-dhcp-relay)# server DefaultDHCPHostname
```

To override the default DHCPv6 Server on an interface, **ipv6 helper-address <IPv6\_Address>** must be used.

- Example to forward DHCPv6 broadcast packet received on interface Ethernet1 to DHCPv6 Server at **fc00::3**, but VLAN2s broadcast packets to DHCPv6 Server at **fc00::4** only.

```
switch(config)# interface Ethernet1
switch(config-if-Et1)# no switchport
switch(config-if-Et1)# ipv6 address fc00::1/10

switch(config)# interface Vlan2
switch(config-if-Et1)# ipv6 address fc00::2/10
switch(config-if-Et1)# ipv6 helper-address fc00::4

switch(config)# dhcp relay
switch(config-dhcp-relay)# server fc00::3
```

We can disable DHCP or DHCPv6 Relay functionality from a specific interface. This will disable both DHCP Relay global and interface mode configurations.

- Example to disable DHCP Relay functionality only.

```
switch(config)# interface Vlan3
switch(config-if-Et1)# dhcp relay ipv4 disabled
```

- Example to disable DHCPv6 Relay functionality only.

```
switch(config)# interface Vlan3
switch(config-if-Et1)# dhcp relay ipv6 disabled
```

### 12.1.8.1 Show Command

#### Example:

This command displays the VRF specifier for the server:

```
rtr1#show ip dhcp relay
DHCP Relay is active
DHCP Relay Option 82 is enabled
DHCP Smart Relay is disabled
Interface: Ethernet9
Option 82 Circuit ID: Ethernet9
DHCP Smart Relay is disabled
DHCP servers: 10.40.2.3
10.40.2.3:vrf=qchyh-vrf
```

### 12.1.8.2 Troubleshooting

To check if the interface is using DHCP Relay mode servers, check the output of **show ip dhcp relay**. Make sure that the desired interfaces to be affected are in the default VRF and have an IP address configured.

### 12.1.8.3 Limitations

The DHCP Relay global configuration mode's server commands won't be applied to:

- Interfaces in non-default VRF.
- Interfaces without an IP address configured.
- Management and Loopback interfaces.

### 12.1.9 DHCP Relay Across VRF

The EOS DHCP relay agent supports forwarding of DHCP requests to DHCP servers located in a different VRF to the DHCP client interface VRF. In order to enable VRF support for the DHCP relay agent, Option 82 (DHCP Relay Agent Information Option) must first be enabled. The DHCP relay agent uses Option 82 to pass client specific information to the DHCP server.

These sections describe DHCP Relay across VRF features:

- [Global Configuration](#)
- [Show Commands](#)

The DHCP relay agent inserts Option 82 information into the DHCP forwarded request, which requires the DHCP server belongs to a network on an interface, and that interface belongs to a different VRF than the DHCP client interface. Option 82 information includes the following:

- VPN identifier: The VRF name for the ingress interface of the DHCP request, inserted as sub-option 151.

**Table 66: VPN Identifier**

| SubOpt | Len | ASCII VRF Identifier |   |   |   |   |   |   |
|--------|-----|----------------------|---|---|---|---|---|---|
| 151    | 7   | V                    | R | F | N | A | M | E |

- Link selection: The subnet address of the interface that receives the DHCP request, inserted as sub-option 5. When the DHCP smart relay is enabled, the link selection is filled with the subnet of the active address. The relay agent will set the Gateway IP address (glPAddr) to its own IP address so that DHCP messages can be routed over the network to the DHCP server.

**Table 67: Link Selection**

| SubOpt | Len | Subnet IP Address |    |    |    |
|--------|-----|-------------------|----|----|----|
| 5      | 4   | A1                | A2 | A3 | A4 |

- Server identifier override: The primary IP address of the interface that receives the DHCP request, inserted as sub-option 11. When the DHCP smart relay is enabled, the server identifier is filled with the active address (one of the primary or secondary addresses chosen by smart relay mechanism).

**Table 68: Link Selection**

| SubOpt | Len | Overriding Server Identifier Address |    |    |    |
|--------|-----|--------------------------------------|----|----|----|
| 11     | 4   | B1                                   | B2 | B3 | B4 |

- VSS control suboption as suboption 152: The DHCP server will strip out this suboption when sending the response to the relay, indicating that the DHCP server used VPN information to allocate IP address.



**Note:**

The DHCP server must be capable of handling VPN identifier information in option 82.



Direct communication between DHCP client and server may not be possible as they are in separate VRFs. The Server identifier override and Link Selection sub-options set the relay agent to act as the DHCP server, and enable all DHCP communication to flow through the relay agent.

The relay agent adds all the appropriate sub-options, and forwards all (including renew and release) request packets to the DHCP server. When the DHCP server response messages are received by the relay, Option 82 information is removed and the response is forwarded to the DHCP client in the client VRF.

### 12.1.9.1 Global Configuration

The DHCP relay agent information option is inserted in DHCP messages relayed to the DHCP server. The `ip helper-address` command enables DHCP relay on an interface; and relays DHCP messages to the specified IPv4 address.

#### Example:

This command enables DHCP relay on the interface *Ethernet 1/2*; and relays DHCP messages to the server at *1.1.1.1*.

```
switch(config)#interface ethernet 1/2
switch(config-if-Et1/2)#ip helper-address 1.1.1.1
switch(config-if-Et1/2)#
```

The commands provided in examples below will turn on the attachment of VRF-related tags in the relay agent information option. If both the DHCP client interface and server interface are on the same VRF (default or non-default), then no VRF-related DHCP relay agent information option is inserted.

#### Examples:

- This command configures the DHCP relay to add option 82 information.

```
switch(config)#ip dhcp relay information option
```

- These commands configures two new VRF instances and assign them Route Distinguishers (RDs).

```
switch(config)#vrf instance mtxxg-vrf
switch(config-vrf-mtxxg-vrf)#router bgp 50
switch(config-router-bgp)#vrf mtxxg-vrf
switch(config-router-bgp-vrf-mtxxg-vrf)#rd 5546:5546
switch(config)#vrf instance qchyh-vrf
switch(config-vrf-qchyh-vrf)#router bgp 50
switch(config-router-bgp)#vrf qchyh-vrf
switch(config-router-bgp-vrf-qchyh-vrf)#rd 218:218
```

- This command configures an interface connected to DHCP client in vrf *mtxxg-vrf* and assigns an IP address.

```
switch(config)#interface Ethernet 9
switch(config-if-Et9)#no switchport
```

- This command configures the DHCP client interface in VRF *mtxxg-vrf*.

```
switch(config-if-Et9)#vrf mtxxg-vrf
switch(config-if-Et9)#ip address 10.10.0.1/16
```

- This command configures the server interface in VRF *qchyh-vrf*.

```
switch(config-if-Et11)#vrf qchyh-vrf
switch(config-if-Et11)#ip address 10.40.0.1/16
```

- This command configures a helper address for a DHCP server in VRF *qchyh-vrf*.

```
switch(config-if-Et11)#ip helper-address 10.40.2.3 vrf qchyh-
vrf
```

### 12.1.9.2 Show Command

#### Example:

This command displays the VRF specifier for the server:

```
rtr1#show ip dhcp relay
DHCP Relay is active
DHCP Relay Option 82 is enabled
DHCP Smart Relay is disabled
Interface: Ethernet9
Option 82 Circuit ID: Ethernet9
DHCP Smart Relay is disabled
DHCP servers: 10.40.2.3
10.40.2.3:vrf=qchyh-vrf
```

### 12.1.10 DHCP Relay in VXLAN EVPN

The `ip dhcp relay information option` command enables the configuration of the DHCP server to uniquely identify the origin of the request using a source-interface and the helper address. Source interface is configured with a routable address, which is used by the DHCP server to uniquely identify the DHCP relay agent which forwarded the client's request.

#### Configuring DHCP Relay in VXLAN EVPN (IPv4)

The following enables DHCP relay information option (Option 82) required to specify a source interface.

```
switch (config)# ip dhcp relay information option
```

The following configures a loopback interface as the source interface.

```
switch (config)# interface Loopback1
switch (config-if-Lo1)# ip address 1.1.1.1/24
```

The following configures the Loopback interface as the specified source interface for the helper address.

```
switch (config)# interface Vlan100
switch (config-if-Vl100)# ip helper-address 10.1.1.4 source-interface
Loopback1
```

The following configures the Loopback interface when the DHCP server is in a different VRF ('red'). The source interface must be configured in the DHCP server's VRF for the command to take effect.

```
switch (config)# interface Loopback3
switch (config-if-Lo3)# vrf red
```

```
switch (config-if-Lo3) # ip address 1.1.1.1/24

switch (config) # interface Vlan100
switch (config-if-Vl100) # ip helper-address 10.1.1.4 vrf red source-
interface Loopback3
```

The following disables the use of source interface along with the helper address.

```
switch (config) # interface Vlan100
switch (config-if-Vl100) # no ip helper-address 10.1.1.4 source-interface
Loopback1
```

### Configuring DHCP Relay in VXLAN EVPN (IPv6)

The following configures a local interface.

```
switch (config) # interface Loopback2
switch (config-if-Vl100) # ipv6 address 2001::10:20:30:1/128
```

The following configures the Loopback interface as the local interface for the helper address.

```
switch (config) # interface Vlan200
switch (config-if-Vl200) # ipv6 dhcp relay destination 2002::10:20:30:2
local-interface Loopback2
```

The following configures the Loopback interface when the DHCP server is in a different VRF ('red'). The local interface must be configured in the DHCP server's VRF for the command to take effect.

```
switch (config) # interface Loopback4
switch (config-if-Lo4) # vrf red
switch (config-if-Lo4) # ipv6 address 2001::10:20:30:1/128

switch (config) # interface Vlan200
switch (config-if-Vl200) # ipv6 dhcp relay destination 2002::10:20:30:2
vrf red local-interface Loopback4
```

The following disables the use of local interface along with the helper address.

```
switch (config-if-Vl200) # no ipv6 dhcp relay destination 2002::10:20:30:2
local-interface Loopback4
```

The following displays the status of DHCP relay option (Option 82) and lists the configured DHCP servers.

```
switch# show ip dhcp relay
DHCP Relay is active
DHCP Relay Option 82 is enabled
DHCP Smart Relay is disabled
Interface: Vlan100
 Option 82 Circuit ID: Vlan100
 DHCP Smart Relay is disabled
 DHCP servers: 10.1.1.4
Interface: Vlan200
 Option 82 Circuit ID: Vlan100
 DHCP Smart Relay is disabled
 DHCP servers: 2002::10:20:30:2
```

---

## Limitations

Client requests upto a rate of 130 packets/second are processed.

### 12.1.11 DHCP Snooping with Bridging

Starting 4.25.2F DHCP snooping can also be configured with bridging capabilities. In this configuration, in addition to sending DHCP packets to relay (after adding information option), the packets will also be bridged within the VLAN. In the bridging mode, the switch intercepts DHCP packets, inserts option-82 if not already present, and bridges the packet within the VLAN. This mode of DHCP snooping can be configured without DHCP relay configuration.

#### Platform Compatibility

- 7050
- 7050S, 7050SX, 7050SX2, 7050SX3
- 7050T, 7050TX, 7050TX2, 7050TX3
- 7050Q, 7050QX, 7050QX2
- 7050CX3
- 7050X, 7050X2
- 7160-32CQ
- 7160-48YC6
- 7160-48TC6

#### 12.1.11.1 Configuring DHCP Snooping with Bridging

Following are the steps to configure DHCP snooping with bridging:

1. Enable DHCP snooping feature using the `ip dhcp snooping` command.

```
switch# ip dhcp snooping
```

2. Enable the insertion of option-82 in DHCP request packets using the `ip dhcp snooping information option` command. By default, option-82 is not enabled and without this DHCP Snooping is not operational.

```
switch# ip dhcp snooping information option
```

3. Enable DHCP snooping on the corresponding VLANs using the `ip dhcp snooping vlan <vlan-id>` command. By default, DHCP snooping is not enabled on any VLAN.

```
switch# ip dhcp snooping vlan <vlan-id>
```

4. Set the circuit-id information that is sent in option-82. By default, Interface name and VLAN ID are sent. Remote circuit-id will always be the MAC address of the relay agent.

```
switch# ip dhcp snooping information option circuit-id type 2 format
%h:%p Hostname and interface name
%p:%v Interface name and VLAN ID
```

5. Enable bridging capabilities of DHCP snooping using the `ip dhcp snooping bridging` command. This command will enable DHCP snooping with or without DHCP relay configuration.

```
switch# ip dhcp snooping bridging
```

### 12.1.11.2 Show Commands

The `show ip dhcp snooping` displays the DHCP snooping with bridging information.

```
switch#sh ip dhcp snooping
DHCP Snooping is enabled
DHCP Snooping is operational
DHCP Snooping is configured on following VLANs:
 650
DHCP Snooping bridging is operational on following VLANs:
 650
Insertion of Option-82 is enabled
Circuit-id sub-option Type: 0
Circuit-id format: Interface name:Vlan ID
Remote-id: 00:1c:73:8d:eb:67 (Switch MAC)
```

### 12.1.11.3 Troubleshooting

- Configure all the needed commands so that DHCP snooping is enabled and operational on all the VLANs.
- `show ip dhcp snooping` displays whether the DHCP snooping is operational or not.
- `show ip dhcp snooping counters` displays if snooped packets are getting dropped or not.
- `show ip dhcp snooping counters debug` displays the reason for packets getting dropped.

```
switch#show ip dhcp snooping counters debug
Counter Requests Responses

Received 3 2
Forwarded 3 2
Dropped - Invalid VlanId 0 0
Dropped - Parse error 0 0
Dropped - Invalid Dhcp Optype 0 0
Dropped - Invalid Info Option 0 0
Dropped - Snooping disabled 0 0
```

- Check if the packets are hitting the TCAM rule.

```
switch#show platform trident tcam detail | grep -i dhcp
DHCP Snooping uses 3 entries.
...
655402 45 hits - DHCP client to relay trap-to-cpu
```

### 12.1.11.4 Limitations

- DHCP snooping with bridging is supported only for IPv4.
- When DHCP snooping is configured without bridging configuration, packets with option-82 already present will be dropped.
- DHCP snooping with bridging is available only on platforms:
  - 7050
  - 7050S, 7050SX, 7050SX2, 7050SX3
  - 7050T, 7050TX, 7050TX2, 7050TX3
  - 7050Q, 7050QX, 7050QX2
  - 7050CX3
  - 7050X, 7050X2

---

## 12.1.12 TCP MSS Clamping

TCP MSS clamping limits the value of the maximum segment size (MSS) in the TCP header of TCP SYN packets transiting a specified Ethernet or tunnel interface. Setting the MSS ceiling can avoid IP fragmentation in tunnel scenarios by ensuring that the MSS is low enough to account for the extra overhead of GRE and tunnel outer IP headers. TCP MSS clamping can be used when connecting via GRE to cloud providers that require asymmetric routing.

When MSS clamping is configured on an interface, if the TCP MSS value in a SYN packet transiting that interface exceeds the configured ceiling limit it will be overwritten with the configured limit and the TCP checksum will be recomputed and updated.

TCP MSS clamping is handled by default in the software data path, but the process can be supported through hardware configuration to minimize possible packet loss and a reduction in the number of TCP sessions which the switch can establish per second.

### 12.1.12.1 Cautions

*This feature should be used with caution.* When the TCP MSS clamping feature is enabled by issuing the `tcp mss ceiling` command on any routed interface, *all* routed IPv4 TCP SYN packets (TCP packets with the “SYN” flag set) are sent by default to the CPU and switched through software, even on interfaces where no TCP MSS ceiling has been configured, as long as TCP MSS clamping is enabled. This limits the number of TCP sessions that can be established through the switch per second, and, because throughput for software forwarding is limited, this feature can also cause packet loss if the rate at which TCP SYN packets are sent to the CPU exceeds the limits configured in the control-plane policy map.

Packet loss and TCP session reductions can be minimized by enabling TCP MSS clamping in hardware, but only SYN packets in which MSS is the first TCP option are clamped in the hardware data path; other TCP SYN packets are still switched through software.

To disable MSS clamping, the MSS ceiling must be removed from every interface on which it has been configured by issuing the `no tcp mss ceiling` command on each configured interface.

### 12.1.12.2 Enabling TCP MSS Clamping

There is no global configuration to enable TCP MSS clamping. It is enabled as soon as an MSS ceiling is configured on at least one interface.

### 12.1.12.3 Disabling TCP MSS Clamping

To disable TCP MSS clamping, the MSS ceiling configuration must be removed from every interface by using the `no` or `default` form of the `tcp mss ceiling` command on every interface where a ceiling has been configured.

### 12.1.12.4 Configuring the TCP MSS Ceiling on an Interface

The TCP MSS ceiling limit is set on an interface using the `tcp mss ceiling` command. This also enables TCP MSS clamping on the switch as a whole.

 **Note:** Configuring a TCP MSS ceiling on any interface enables TCP MSS clamping on the switch as a whole. Without hardware support, clamping routes all TCP SYN packets through software, even on interfaces where no TCP MSS ceiling has been configured. This significantly limits the number of TCP sessions the switch can establish per second, and can potentially cause packet loss if the CPU traffic exceeds control plane policy limits.

On Sand platform switches (Qumran-MX, Qumran-AX, Jericho, Jericho+), the following limitations apply:

- This command works only on egress.

- TCP MSS ceiling is supported on IPv4 unicast packets entering the switch; the configuration has no effect on GRE transit packets.
- The feature is supported only on IPv4 routed interfaces. It is not supported on L2 (switchport) interfaces or IPv6 routed interfaces.
- The feature is not supported for IPv6 packets even if they are going to be tunneled over an IPv4 GRE tunnel.
- The feature is not supported on VXLAN, loopback or management interfaces.
- The feature is only supported on IPv4 unicast packets entering the switch. The configuration has no effect on GRE transit packets or GRE decap, even if the egress interface has a TCP MSS ceiling configured.
- The feature cannot co-exist with Policy Based Routing (PBR) on switches running releases 4.21.5F or older.

**Example:**

These commands configure *Ethernet interface 5* as a routed port, then specify a maximum MSS ceiling value of *1458* bytes for TCP SYN packets exiting that port.

```
switch(config)#interface ethernet 5
switch(config-if-Et5)#no switchport
switch(config-if-Et5)#tcp mss ceiling ipv4 1458 egress
switch(config-if-Et5)#
```

**12.1.12.5 Configuring Hardware Support for TCP MSS Clamping**

TCP MSS clamping can be supported in hardware, but some packets are still routed through the software data path, and an MSS ceiling value must be configured on each interface where clamping is to be applied.

Hardware support for clamping is accomplished through the use of a user-defined TCAM profile. The TCAM profile can be created from scratch or copied from an existing profile, but in either case it must include the `tcp-mss-ceiling ip` feature.

**Guidelines**

- When the system TCAM profile is changed, some agents will restart.
- To ensure that the TCP MSS feature is allocated a TCAM DB, it may be necessary to remove some unused features from the TCAM profile.
- Hardware TCP MSS clamping only works for TCP packets with MSS as the first TCP option. Other TCP SYN packets are still trapped to the CPU for clamping in software.
- Hardware TCP MSS clamping is not supported with host routes when the clamping is applied on a non-tunnel interface. This limitation does not apply to GRE tunnel interfaces.
- The maximum MSS ceiling limit with hardware MSS clamping is 32727 even though the CLI allows configuration of much larger values.
- For more information on the creation of user-defined TCAM profiles, see <https://eos.arista.com/eos-4-20-5f/user-defined-pmf-profile/>

To configure hardware support for TCP MSS clamping, create a TCAM profile that includes the `tcp-mss-ceiling ip` feature, then apply it to the system.

**12.1.12.5.1 Creating the TCAM Profile**

A TCAM profile that supports TCP MSS clamping can be created from scratch, or the feature can be added to a copy of the default TCAM profile. When creating a profile from scratch, care must be taken to ensure that all needed TCAM features are included in the profile.

---

## Modifying a Copy of the Default TCAM Profile

The following commands create a copy of the default TCAM profile, name it “`tcp-mss-clamping`,” and configure it to enable MSS clamping in hardware, then remove some unused features included in the default profile to ensure that there are sufficient TCAM resources for the clamping feature.

```
switch(config)#hardware tcam
switch(config-hw-tcam)#profile tcp-mss-clamping copy default
switch(config-hw-tcam-profile-tcp-mss-clamping1)#feature tcp-mss-ceiling
ip copy
system-feature-source-profile
switch(config-hw-tcam-profile-tcp-mss-clamping-feature-tcp-mss-c
eiling)#key
size limit 160
switch(config-hw-tcam-profile-tcp-mss-clamping-feature-tcp-mss-c
eiling)#packet
ipv4 forwarding routed
switch(config-hw-tcam-profile-tcp-mss-clamping-feature-tcp-mss-c
eiling)#exit

switch(config-hw-tcam-profile-tcp-mss-clamping)#no feature mirror ip
switch(config-hw-tcam-profile-tcp-mss-clamping)#no feature acl port mac
switch(config-hw-tcam-profile-tcp-mss-clamping1)#exit

switch(config-hw-tcam)#exit

switch(config)#
```

### 12.1.12.5.2 Applying the TCAM Profile to the System

The following commands enter Hardware TCAM Configuration Mode and set the “`tcp-mss-clamping`” profile as the system profile.

```
switch(config)#hardware tcam
switch(config-hw-tcam)#system profile tcp-mss-clamping
switch(config-hw-tcam)#
```

### 12.1.12.5.3 Verifying the TCAM Profile Configuration

The following command displays hardware TCAM profile information to verify that the user-defined TCAM profile has been applied correctly.

```
switch(config)#show hardware tcam profile

Configuration Status
FixedSystem tcp-mss-clamping tcp-mss-clamping

switch(config)#
```

## 12.1.13 IPv4 GRE Tunneling

GRE tunneling supports the forwarding over IPv4 GRE tunnel interfaces. The GRE tunnel interfaces act as a logical interface that performs GRE encapsulation or decapsulation.

The following switches support the IPv4 forwarding of GRE tunnel interface.

- DCS-7020R
- DCS-7280R
- DCS-7500R





**Note:** The forwarding over GRE tunnel interface on DCS-7500R is supported only if all the line cards on the system have Jericho family chip-set.

### 12.1.13.1 Configuring GRE Tunneling Interface

#### On a local Arista switch

```
switch(config)#ip routing
switch(config)#interface Tunnel 10
switch(config-if-Tu10)#tunnel mode gre
switch(config-if-Tu10)#ip address 192.168.1.1/24
switch(config-if-Tu10)#tunnel source 10.1.1.1
switch(config-if-Tu10)#tunnel destination 10.1.1.2
switch(config-if-Tu10)#tunnel path-mtu-discovery
switch(config-if-Tu10)#tunnel tos 10
switch(config-if-Tu10)#tunnel ttl 10
```

#### On a remote Arista switch

```
switch(config)#ip routing
switch(config)#interface Tunnel 10
switch(config-if-Tu10)#tunnel mode gre
switch(config-if-Tu10)#ip address 192.168.1.2/24
switch(config-if-Tu10)#tunnel source 10.1.1.2
switch(config-if-Tu10)#tunnel destination 10.1.1.1
switch(config-if-Tu10)#tunnel path-mtu-discovery
switch(config-if-Tu10)#tunnel tos 10
switch(config-if-Tu10)#tunnel ttl 10
```

#### Alternative configuration for tunnel source IPv4 address

```
switch(config)#interface Loopback 10
switch(config-if-Lo10)#ip add 10.1.1.1/32
switch(config-if-Lo10)#exit

switch(config)#conf terminal
switch(config)#interface Tunnel 10
switch(config-if-Tu10)#tunnel source interface Loopback 10
```

#### Configuration for adding an IPv4 route over the GRE tunnel interface

```
switch(config)#ip route 192.168.100.0/24 Tunnel 10
```

#### Tunnel Mode

Tunnel Mode needs to be configured as gre, for GRE tunnel interface. Default value is tunnel mode gre.

#### IP address

Configures the IP address for the GRE tunnel interface. The IP address can be used for routing over the GRE tunnel interface. The configured subnet is reachable over the GRE tunnel interface and the packets to the subnet are encapsulated in the GRE header.

---

### Tunnel Source

Specifies the source IP address for the outer IPv4 encapsulation header for packets going over the GRE tunnel interface. The tunnel source IPv4 address should be a valid local IPv4 address configured on the Arista Switch. The tunnel source can also be specified as any routed interface on the Arista Switch. The routed interface's IPv4 address is assigned as the tunnel source IPv4 address.

### Tunnel Destination

Specifies the destination IPv4 address for the outer IPv4 encapsulation header for packets going over the GRE tunnel interface. The tunnel destination IPv4 should be reachable from the Arista Switch.

### Tunnel Path Mtu Discovery

Specifies if the "Do not Fragment" flag needs to set in the outer IPv4 encapsulation header for packets going over the GRE tunnel interface.

### Tunnel TOS

Specifies the Tunnel type of service (ToS) value to be assigned to the outer IPv4 encapsulation header for packets going over the GRE tunnel interface. Default TOS value of 0 will be assigned if tunnel TOS is not configured.

### Tunnel TTL

Specifies the TTL value to be assigned to the outer IPv4 encapsulation header for packet going over the GRE tunnel interface. The TTL value is copied from the inner IPv4 header if tunnel TTL is not configured. The tunnel TTL configuration requires the tunnel Path MTU Discovery to be configured.

## 12.1.13.2 Displaying GRE tunnel Information

- The following commands display the tunnel configuration.

```
switch#show interfaces Tunnel 10
Tunnel10 is up, line protocol is up (connected)
Hardware is Tunnel, address is 0a01.0101.0800
Internet address is 192.168.1.1/24
Broadcast address is 255.255.255.255
Tunnel source 10.1.1.1, destination 10.1.1.2
Tunnel protocol/transport GRE/IP
 Key disabled, sequencing disabled
 Checksumming of packets disabled
Tunnel TTL 10, Hardware forwarding enabled
Tunnel TOS 10
Path MTU Discovery
Tunnel transport MTU 1476 bytes
Up 3 seconds
```

- ```
switch#show gre tunnel static

Name      Index  Source  Destination  Nexthop  Interface
-----  -
Tunnel10  10     10.1.1.1 10.1.1.2     10.6.1.2 Ethernet6/1

switch#show tunnel fib static interface gre 10
Type 'Static Interface', index 10, forwarding Primary
  via 10.6.1.2, 'Ethernet6/1'
  GRE, destination 10.1.1.2, source 10.1.1.1, ttl 10, tos 0xa
```

- Use **show platform fap tcam summary** to verify if the TCAM bank is allocated for GRE packet termination lookup.

```
switch#show platform fap tcam summary

          Tcam Allocation (Jericho0)
Bank      Used By      Reserved By
-----
0         dbGreTunnel  -
```

- Use **show ip route** to verify if the routes over tunnel is setup properly.

```
switch#show ip route

VRF: default
Codes: C - connected, S - static, K - kernel,
       O - OSPF, IA - OSPF inter area, E1 - OSPF external type 1,
       E2 - OSPF external type 2, N1 - OSPF NSSA external type 1,
       N2 - OSPF NSSA external type2, B I - iBGP, B E - eBGP,
       R - RIP, I L1 - IS-IS level 1, I L2 - IS-IS level 2,
       O3 - OSPFv3, A B - BGP Aggregate, A O - OSPF Summary,
       NG - Nexthop Group Static Route, V - VXLAN Control Service,
       DH - DHCP client installed default route, M - Martian,
       DP - Dynamic Policy Route

Gateway of last resort is not set

C      192.168.1.0/24 is directly connected, Tunnel10, Static
Interface GRE tunnel
index 10, dst 10.1.1.2, src 10.1.1.1, TTL 10, TOS 10
S      192.168.100.0/24 is directly connected, Tunnel10, Static
Interface GRE
tunnel index 10, dst 10.1.1.2, src 10.1.1.1, TTL 10, TOS 10
```

- The following commands are used to verify the tunnel encapsulation programming.

```
switch#show platform fap eedb ip-tunnel gre interface Tunnel 10

-----
|                                     Jericho0
|
|                                     GRE Tunnel Egress Encapsulation DB
|
|-----|
| Bank/ | OutLIF | Next  | VSI  | Encap | TOS  | TTL  | Source | Destination|
| OamLIF| OutLIF | Drop  |      |       |      |      | IP     | IP          | Set
| Offset|         | OutLIF| LSB  | Mode  |      |      |        |             |
| Profile|         |       |      |       |      |      |        |             |
|-----|
| 3/0   | 0x6000 | 0x4010 | 0    | 2     | 10   | 10   | 10.1.1.1 | 10.1.1.2 | No
| 0     | No     |        |      |       |      |      |          |           |
|-----|

switch#show platform fap eedb ip-tunnel

-----
|                                     Jericho0
|
|                                     IP Tunnel Egress Encapsulation DB
|
|-----|
| Bank/ | OutLIF | Next  | VSI  | Encap| TOS  | TTL  | Src  | Destination | OamLIF
| OutLIF | Drop  |      |      |      |      |      |      |             |
| Offset|         | OutLIF| LSB  | Mode | Idx  | Idx  | Idx  | IP          | Set   |
| Profile|         |       |      |      |      |      |      |             | |
|---|---|---|---|---|---|---|---|---|---|
| 3/0   | 0x6000 | 0x4010 | 0    | 2     | 9    | 0    | 0    | 10.1.1.2   | No    |
| 0     | No     |        |      |       |      |      |      |            |
|-----|
```

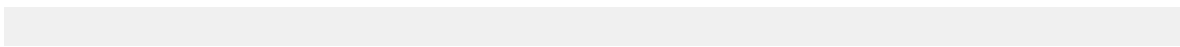

12.1.14 IPv4 Commands

IP Routing and Address Commands

- agent SandL3Unicast terminate
- clear arp inspection statistics
- compress
- ip arp inspection limit
- ip arp inspection logging
- ip arp inspection trust
- ip arp inspection vlan
- ip hardware fib ecmp resilience
- ip hardware fib optimize
- ip icmp redirect
- ip load-sharing
- ip route
- ip routing
- ip source binding
- ip verify
- ip verify source
- ipv4 routable 240.0.0.0/4
- rib fib policy
- show dhcp server
- show ip
- show ip arp inspection vlan
- show ip arp inspection statistics
- show ip interface
- show ip interface brief
- show ip route
- show ip route age
- show ip route gateway
- show ip route host
- show ip route match tag
- show ip route summary
- show rib route ip
- show rib route <ipv4 | ipv6> fib policy excluded
- show rib route summary
- show routing-context vrf
- show vrf
- show ip verify source
- show platform arad ip route
- show platform arad ip route summary
- tcp mss ceiling

IPv4 DHCP Relay

- clear ip dhcp relay counters
- dhcp relay
- ip dhcp relay all-subnets
- ip dhcp relay all-subnets default

-
- ip dhcp relay always-on
 - ip dhcp snooping information option
 - ip dhcp relay information option circuit-id
 - ip helper-address
 - show ip dhcp relay
 - show ip dhcp relay counters

IPv4 DHCP Snooping

- clear ip dhcp snooping counters
- ip dhcp snooping
- ip dhcp snooping bridging
- ip dhcp snooping information option
- ip dhcp snooping vlan
- show ip dhcp snooping
- show ip dhcp snooping counters
- show ip dhcp snooping hardware

IPv4 Multicast Counters

- clear ip multicast count
- ip multicast count

ARP Table

- arp
- arp aging timeout
- arp cache persistent
- arp gratuitous accept
- clear arp-cache
- clear arp
- ip local-proxy-arp
- ip proxy-arp
- show arp
- show ip arp

VRF Commands

- cli vrf
- description (VRF)
- show routing-context vrf
- show vrf
- vrf (Interface mode)
- vrf instance

Trident Forwarding Table Commands

- platform trident forwarding-table partition
- platform trident routing-table partition
- show platform trident forwarding-table partition

IPv4 GRE Tunneling Commands

- interface tunnel

- tunnel
- show interface tunnel
- show platform fap eedb ip-tunnel gre interface tunnel
- show tunnel fib static interface gre
- show platform fap tcam summary

12.1.14.1 agent SandL3Unicast terminate

The `agent SandL3Unicast terminate` command restarts the platform Layer 3 agent to ensure IPv4 routes are optimized.

Command Mode

Global Configuration

Command Syntax

```
agent SandL3Unicast terminate
```

Related Commands

- [ip hardware fib optimize](#) enables IPv4 route scale.
- [show platform arad ip route](#) shows resources for all IPv4 routes in hardware. Routes that use the additional hardware resources will appear with an asterisk.
- [show platform arad ip route summary](#) shows hardware resource usage of IPv4 routes.

Example:

This configuration command restarts the platform Layer 3 agent to ensure IPv4 routes are optimized.

```
switch(config)#agent SandL3Unicast terminate  
SandL3Unicast was terminated
```

Restarting the platform Layer 3 agent results in deletion of all IPv4 routes, which are re-added to the hardware.

12.1.14.2 arp aging timeout

The **arp aging timeout** command specifies the duration of dynamic address entries in the Address Resolution Protocol (ARP) cache for addresses learned through the configuration mode interface. The default duration is *14400* seconds (four hours).

The **arp aging timeout** and **default arp aging timeout** commands restores the default ARP aging timeout for addresses learned on the configuration mode interface by deleting the corresponding **arp aging timeout** command from *running-config*.

Command Mode

Interface-Ethernet Configuration

Interface-Loopback Configuration

Interface-Management Configuration

Interface-Port-channel Configuration

Interface-VLAN Configuration

Command Syntax

```
arp aging timeout arp_time
```

```
no arp aging timeout
```

```
default arp aging timeout
```

Parameters

- **arp_time** ARP aging timeout period (seconds). Values range from **60** to **65535**. Default value is **14400**.

Example:

This command specifies an ARP cache duration of *7200* seconds (two hours) for dynamic addresses added to the ARP cache that were learned through *VLAN 200*.

```
switch(config)#interface vlan 200
switch(config-if-Vl200)#arp aging timeout 7200
switch(config-if-Vl200)#show active
interface Vlan200
    arp aging timeout 7200
switch(config-if-Vl200)#
```

12.1.14.3 arp cache persistent

The **arp cache persistent** command restores the dynamic entries in the Address Resolution Protocol (ARP) cache after reboot.

The **no arp cache persistent** and **default arp cache persistent** commands remove the ARP cache persistent configuration from the running-config.

Command Mode

Global Configuration

Command Syntax

```
arp cache persistent
```

```
no arp cache persistent
```

```
default arp cache persistent
```

Example:

This command restores the ARP cache after reboot.

```
switch(config)#arp cache persistent  
switch(config)#
```

12.1.14.4 arp gratuitous accept

The **arp gratuitous accept** command configures the configuration mode interface to accept gratuitous ARP request packets received on that interface. Accepted gratuitous ARP requests are then learned by the ARP table.

The **no** and **default** forms of the command prevent the interface from accepting gratuitous ARP requests. Configuring gratuitous ARP acceptance on an L2 interface has no effect.

Command Mode

Interface-Ethernet Configuration

Interface-VLAN Configuration

Interface Port-channel Configuration

Command Syntax

```
arp gratuitous accept
```

```
no arp gratuitous accept
```

```
default arp gratuitous accept
```

Example:

These commands configure *Ethernet interface 2/1* to accept gratuitous ARP request packets.

```
switch (config)#interface ethernet 2/1  
switch (config-if-Et2/1)#arp gratuitous accept  
switch (config-if-Et2/1)#
```

12.1.14.5 arp

The **arp** command adds a static entry to an Address Resolution Protocol (ARP) cache. The switch uses ARP cache entries to correlate 32-bit IP addresses to 48-bit hardware addresses.

The **no arp** and **default arp** commands remove the ARP cache entry with the specified IP address. When multiple VRFs contain ARP cache entries for identical IP addresses, each entry can only be removed individually.

Command Mode

Global Configuration

Command Syntax

```
arp [VRF_INSTANCE] ipv4_addr mac_addr arpa
```

```
no arp [VRF_INSTANCE] ipv4_addr
```

```
default arp [VRF_INSTANCE] ipv4_addr
```

Parameters

- **VRF_INSTANCE** Specifies the VRF instance being modified.
 - **<no parameter>** Changes are made to the default VRF.
 - **vrf vrf_name** Changes are made to the specified user-defined VRF.
- **ipv4_addr** IPv4 address of ARP entry.
- **mac_addr** Local data-link (hardware) address (48-bit dotted hex notation – H.H.H).

Examples:

- This command adds a static entry to the ARP cache in the default VRF.

```
switch(config)#arp 172.22.30.52 0025.900e.c63c arpa
switch(config)#
```

- This command adds the same static entry to the ARP cache in the VRF named "purple."

```
switch(config)#arp vrf purple 172.22.30.52 0025.900e.c63c arpa
switch(config)#
```

12.1.14.6 clear arp inspection statistics

The `clear arp inspection statistics` command clears ARP inspection statistics.

Command Mode

EXEC

Command Syntax

```
clear arp inspection statistics
```

Related Commands

- [ip arp inspection limit](#)
- [ip arp inspection logging](#)
- [ip arp inspection trust](#)
- [ip arp inspection vlan](#)
- [show ip arp inspection vlan](#)
- [show ip arp inspection statistics](#)

Example:

This command clears ARP inspection statistics.

```
switch(config)#clear arp inspection statistics
switch(config)#
```

12.1.14.7 clear arp

The **clear arp** command removes the specified dynamic ARP entry for the specified IP address from the Address Resolution Protocol (ARP) table.

Command Mode

Privileged EXEC

Command Syntax

```
clear arp [VRF_INSTANCE] ipv4_addr Parameters
```

- **VRF_INSTANCE** Specifies the VRF instance for which arp data is removed.
 - **<no parameter>** Specifies the context-active VRF.
 - **vrf vrf_name** Specifies name of VRF instance. System default VRF is specified by **default**.
- **ipv4_addr** IPv4 address of dynamic ARP entry.
-

Example:

These commands display the ARP table before and after the removal of dynamic ARP entry for IP address 172.22.30.52.

```
switch#show arp
Address          Age (min)  Hardware Addr  Interface
172.22.30.1     0          001c.730b.1d15 Management1
172.22.30.52    0          0025.900e.c468 Management1
172.22.30.53    0          0025.900e.c63c Management1
172.22.30.133   0          001c.7304.3906 Management1

switch#clear arp 172.22.30.52
switch#show arp
Address          Age (min)  Hardware Addr  Interface
172.22.30.1     0          001c.730b.1d15 Management1
172.22.30.53    0          0025.900e.c63c Management1
172.22.30.133   0          001c.7304.3906 Management1

switch#
```

12.1.14.8 clear arp-cache

The **clear arp-cache** command refreshes dynamic entries in the Address Resolution Protocol (ARP) cache. Refreshing the ARP cache updates current ARP table entries and removes expired ARP entries not yet deleted by an internal, timer-driven process.

The command, without arguments, refreshes ARP cache entries for all enabled interfaces. With arguments, the command refreshes cache entries for the specified interface. Executing **clear arp-cache** for all interfaces can result in extremely high CPU usage while the tables are resolving.

Command Mode

Privileged EXEC

Command Syntax

```
clear arp-cache [VRF_INSTANCE][INTERFACE_NAME]
```

Parameters

- **VRF_INSTANCE** Specifies the VRF instance for which arp data is refreshed.
 - **<no parameter>** Specifies the context-active VRF.
 - **vrf vrf_name** Specifies name of VRF instance. System default VRF is specified by **default**.
- **INTERFACE_NAME** Interface upon which ARP cache entries are refreshed. Options include:
 - **<no parameter>** All ARP cache entries.
 - **interface ethernet e_num** ARP cache entries of specified Ethernet interface.
 - **interface loopback l_num** ARP cache entries of specified loopback interface.
 - **interface management m_num** ARP cache entries of specified management interface.
 - **interface port-channel p_num** ARP cache entries of specified port-channel Interface.
 - **interface vlan v_num** ARP cache entries of specified VLAN interface.
 - **interface vxlan vx_num** VXLAN interface specified by **vx_num**.

Related Commands

- [cli vrf](#) specifies the context-active VRF.

Example:

These commands display the ARP cache before and after ARP cache entries are refreshed.

```
switch#show arp

Address          Age (min)  Hardware Addr  Interface
172.22.30.1      0          001c.730b.1d15  Management1
172.22.30.118    0          001c.7301.6015  Management1

switch#clear arp-cache
switch#show arp

Address          Age (min)  Hardware Addr  Interface
172.22.30.1      0          001c.730b.1d15  Management1

switch#
```

12.1.14.9 clear ip dhcp relay counters

The `clear ip dhcp relay counters` command resets the DHCP relay counters. The configuration mode determines which counters are reset:

- **Interface configuration:** command clears the counter for the configuration mode interface.

Command Mode

Privileged EXEC

Command Syntax

```
clear ip dhcp relay counters [INTERFACE_NAME]
```

Parameters

- **INTERFACE_NAME** Entity for which counters are cleared. Options include:
 - **<no parameter>** Clears counters for the switch and for all interfaces.
 - **interface ethernet e_num** Clears counters for the specified Ethernet interface.
 - **interface loopback l_num** Clears counters for the specified loopback interface.
 - **interface port-channel p_num** Clears counters for the specified port-channel Interface.
 - **interface vlan v_num** Clears counters for the specified VLAN interface.

Examples:

- These commands clear the DHCP relay counters for *VLAN 1045* and shows the counters before and after the `clear` command.

```
switch#show ip dhcp relay counters
```

Interface	Dhcp Packets			Last Cleared
	Rcvd	Fwdd	Drop	
All Req	376	376	0	4 days, 19:55:12 ago
All Resp	277	277	0	
Vlan1001	207	148	0	4 days, 19:54:24 ago
Vlan1045	376	277	0	4 days, 19:54:24 ago

```
switch#clear ip dhcp relay counters interface vlan 1045
```

Interface	Dhcp Packets			Last Cleared
	Rcvd	Fwdd	Drop	
All Req	380	380	0	4 days, 21:19:17 ago
All Resp	281	281	0	
Vlan1000	207	148	0	4 days, 21:18:30 ago
Vlan1045	0	0	0	0:00:07 ago

- These commands clear all DHCP relay counters on the switch.

```
switch(config-if-Vl1045)#exit
switch(config)#clear ip dhcp relay counters
switch(config)#show ip dhcp relay counters
```

Interface	Dhcp Packets			Last Cleared
	Rcvd	Fwdd	Drop	
All Req	0	0	0	0:00:03 ago
All Resp	0	0	0	

```
Vlan1000 | 0 0 0 | 0:00:03 ago  
Vlan1045 | 0 0 0 | 0:00:03 ago
```

12.1.14.10 clear ip dhcp snooping counters

The `clear ip dhcp snooping counters` command resets the DHCP snooping packet counters.

Command Mode

Privileged EXEC

Command Syntax

```
clear ip dhcp snooping counters [COUNTER_TYPE]
```

Parameters

- **COUNTER_TYPE** The type of counter that the command resets. Options include:
 - **<no parameter>** Counters for each VLAN.
 - **debug** Aggregate counters and drop cause counters.

Examples:

- This command clears the DHCP snooping counters for each VLAN.

```
switch#clear ip dhcp snooping counters
switch#show ip dhcp snooping counters

      | Dhcp Request Pkts | Dhcp Reply Pkts |
Vlan |  Rcvd  Fwdd  Drop |  Rcvd  Fwdd  Drop | Last Cleared
-----|-----|-----|-----|-----|-----|
 100 |     0     0     0 |     0     0     0 | 0:00:10 ago

switch#
```

- This command clears the aggregate DHCP snooping counters.

```
switch#clear ip dhcp snooping counters debug
switch#show ip dhcp snooping counters debug

Counter                               Snooping to Relay Relay to
Snooping
-----|-----|-----|-----|
Received                               0
0
Forwarded                               0
0
Dropped - Invalid VlanId               0
0
Dropped - Parse error                  0
0
Dropped - Invalid Dhcp Optype          0
0
Dropped - Invalid Info Option          0
0
Dropped - Snooping disabled            0
0

Last Cleared: 0:00:08 ago

switch#
```

12.1.14.11 clear ip multicast count

The `clear ip multicast count` command clears all counters associated with the multicast traffic.

Command Mode

Global Configuration

Command Syntax

```
clear ip multicast count [group_address [source_address]]
```

Parameters

- **<no parameters>** Clears all counts of the multicast route traffic.
- **group_address** Clears the multicast traffic count of the specified group address.
 - **source_address** Clears the multicast traffic count of the specified group and source addresses.

Guidelines

- This command functions only when the `ip multicast count` command is enabled.

Examples:

- This command clears all counters associated with the multicast traffic.

```
switch(config)#clear ip multicast count
```

- This command clears the multicast traffic count of the specified group address.

```
switch(config)#clear ip multicast count 16.39.24.233
```

12.1.14.12 cli vrf

The `cli vrf` command specifies the context-active VRF. The context-active VRF determines the default VRF that VRF-context aware commands use when displaying routing table data.

Command Mode

Privileged EXEC

Command Syntax

```
cli vrf [VRF_ID]
```

Parameters

- **VRF_ID** Name of VRF assigned as the current VRF scope. Options include:
 - **vrf_name** Name of user-defined VRF.
 - **default** System-default VRF.

Guidelines

VRF-context aware commands include:

[clear arp-cache](#)

[show ip](#)

[show ip arp](#)

[show ip route](#)

[show ip route gateway](#)

[show ip route host](#)

Related Commands

- [show routing-context vrf](#) displays the context-active VRF.

Example:

These commands specify *magenta* as the context-active VRF, then display the context-active VRF.

```
switch#cli vrf magenta
switch#show routing-context vrf
Current VRF routing-context is magenta
switch#
```

12.1.14.13 compress

The **compress** command increases the hardware resources available for the specified prefix lengths.

The **no compress** command removes the 2-to-1 compression configuration from the running-config.



Note: The **compress** command is supported only on 7500R, 7280R, 7500R2 and 7280R2 platforms.

Command Mode

Global Configuration

Command Syntax

```
ip hardware fib optimize prefix-length<prefix-length>expand<prefix-length>compress
```

```
no ip hardware fib optimize prefix-length<prefix-length>expand<prefix-length>compress
```

Parameters

- **compress** Allows configuring up to one compressed prefix length.

Example:

In the following example we are configuring prefix length 20 and 24, expanding prefix length 19 and 23, and compressing prefix length 25.

```
switch(config)#ip hardware fib optimize prefix-length 20 24
expand 19 23 compress 25
! Please restart layer 3 forwarding agent to ensure IPv4 routes
are optimized
```

12.1.14.14 description (VRF)

The **description** command adds a text string to the configuration mode VRF. The string has no functional impact on the VRF.

The **no description** and **default description** commands remove the text string from the configuration mode VRF by deleting the corresponding **description** command from **running-config**.

Command Mode

VRF Configuration

Command Syntax

```
description label_text
```

```
no description
```

```
default description
```

Parameters

- **label_text** Character string assigned to the VRF configuration.

Related Commands

- [vrf instance](#) places the switch in VRF configuration mode.

Example:

These commands add description text to the *magenta* VRF.

```
switch(config)#vrf instance magenta
switch(config-vrf-magenta)#description This is the first vrf
switch(config-vrf-magenta)#show active
vrf instance magenta
    description This is the first vrf

switch(config-vrf-magenta)#
```

12.1.14.15 dhcp relay

The **dhcp relay** command places the switch in the DHCP relay mode. This command is executed under global configuration mode.

The **no dhcp relay** command removes DHCP relay configuration from the **running-config**.

Command Mode

Global Configuration Mode

Command Syntax

dhcp relay

no dhcp relay

Example

- The **dhcp relay** command places the switch in the DHCP relay configuration mode.

```
switch(config)#dhcp relay
switch(config-dhcp-relay)#
```

12.1.14.16 interface tunnel

The **interface tunnel** command places the switch in interface-tunnel configuration mode.

Interface-tunnel configuration mode is not a group change mode; **running-config** is changed immediately after commands are executed.

The **no interface tunnel** command deletes the specified interface tunnel configuration.

The **exit** command returns the switch to the global configuration mode.

Command Mode

Global Configuration

Command Syntax

```
interface tunnel <number>
```

```
no interface tunnel <number>
```

Parameter

- **number** Tunnel interface number. Values range from 0 to 255.

Example:

This command places the switch in interface-tunnel configuration mode for tunnel interface 10.

```
switch(config)#interface tunnel 10  
switch(config-if-Tu10)#
```

12.1.14.17 ip arp inspection limit

The `ip arp inspection limit` command err-disables the interface if the incoming ARP rate exceeds the configured value rate limit the incoming ARP packets on an interface.

Command Mode

EXEC

Command Syntax

```
ip arp inspection limit [ RATE <pps>] [BURST_INTERVAL <sec> | none]
no ip arp inspection limit [ RATE <pps>] [BURST_INTERVAL <sec> | none]
default ip arp inspection limit [ RATE <pps>] [BURST_INTERVAL <sec> | none]
```

Parameters

- **RATE** Specifies the ARP inspection limit rate in packets per second.
 - **<pps>** ARP inspection limit rate packets per second.
- **BURST_INTERVAL** Specifies the ARP inspection limit burst interval.
 - **<sec>** Burst interval second.

Related Commands

- [ip arp inspection limit](#)
- [ip arp inspection trust](#)
- [ip arp inspection vlan](#)
- [show ip arp inspection vlan](#)

Examples:

- This command configures the rate limit of incoming ARP packets to err-disable the interface when the incoming ARP rate exceeds the configured value, sets the rate to 512 (which is the upper limit for the number of invalid ARP packets allowed per second), and sets the burst consecutive interval over which the interface is monitored for a high ARP rate to 11 seconds.

```
switch(config)#ip arp inspection limit rate 512 burst interval
11
switch(config)#
```

- This command displays verification of the interface specific configuration.

```
switch(config)#interface Ethernet 3/1
switch(config)#ip arp inspection limit rate 20 burst interval
5
switch(config)#interface Ethernet 3/3
switch(config)#ip arp inspection trust
switch(config)#show ip arp inspection interfaces
```

Interface	Trust State	Rate (pps)	Burst Interval
Et3/1	Untrusted	20	5
Et3/3	Trusted	None	N/A

```
switch(config)#
```

12.1.14.18 ip arp inspection logging

The **ip arp inspection logging** command enables logging of incoming ARP packets on the interface if the rate exceeds the configured value.

Command Mode

EXEC

Command Syntax

```
ip arp inspection logging [RATE <pps> ][BURST_INTERVAL <sec> | none]
```

```
no ip arp inspection logging [RATE <pps> ][BURST_INTERVAL <sec> | none]
```

```
default ip arp inspection logging [RATE <pps> ][BURST_INTERVAL <sec> | none]
```

Parameters

- **RATE** Specifies the ARP inspection limit rate in packets per second.
 - **<pps>** ARP inspection limit rate packets per second.
- **BURST_INTERVAL** Specifies the ARP inspection limit burst interval.
 - **<sec>** Burst interval second.

Related Commands

- [ip arp inspection limit](#)
- [ip arp inspection trust](#)
- [ip arp inspection vlan](#)
- [show ip arp inspection vlan](#)

Example:

This command enables logging of incoming ARP packets when the incoming ARP rate exceeds the configured value on the interface, sets the rate to 2048 (which is the upper limit for the number of invalid ARP packets allowed per second), and sets the burst consecutive interval over which the interface is monitored for a high ARP rate to 15 seconds.

```
switch(config)#ip arp inspection logging rate 2048 burst interval  
15  
switch(config)#
```

12.1.14.19 ip arp inspection trust

The `ip arp inspection trust` command configures the trust state of an interface. By default, all interfaces are untrusted.

Command Mode

EXEC

Command Syntax

```
ip arp inspection trust
no ip arp inspection trust
default ip arp inspection trust
```

Related Commands

- [ip arp inspection limit](#)
- [ip arp inspection logging](#)
- [ip arp inspection vlan](#)
- [show ip arp inspection vlan](#)

Examples:

- This command configures the trust state of an interface.

```
switch(config)#ip arp inspection trust
switch(config)#
```

- This command configures the trust state of an interface to untrusted.

```
switch(config)#no ip arp inspection trust
switch(config)#
```

- This command configures the trust state of an interface to its default (untrusted).

```
switch(config)#default ip arp inspection trust
switch(config)#
```

12.1.14.20 ip arp inspection vlan

The **ip arp inspection vlan** command enables ARP inspection. ARP requests and responses on untrusted interfaces are intercepted on specified VLANs, and intercepted packets are verified to have valid IP-MAC address bindings. All invalid ARP packets are dropped. On trusted interfaces, all incoming ARP packets are processed and forwarded without verification. By default, ARP inspection is disabled on all VLANs.

Command Mode

EXEC

Command Syntax

```
ip arp inspection vlan [LIST]
```

Parameters

- **LIST** Specifies the VLAN interface number.

Related Commands

- [ip arp inspection limit](#)
- [ip arp inspection trust](#)
- [ip arp inspection vlan](#)

Example:

- This command enables ARP inspection on VLANs 1 through 150.

```
switch(config)#ip arp inspection vlan 1 - 150
switch(config)#
```

- This command disables ARP inspection on VLANs 1 through 150.

```
switch(config)#no ip arp inspection vlan 1 - 150
switch(config)#
```

- This command sets the ARP inspection default to VLANs 1 through 150.

```
switch(config)#default ip arp inspection vlan 1 - 150
switch(config)#
```

- These commands enable ARP inspection on multiple VLANs 1 through 150 and 200 through 250.

```
switch(config)#ip arp inspection vlan 1-150,200-250
switch(config)#
```

12.1.14.21 ip dhcp relay all-subnets default

The `ip dhcp relay all-subnets default` command configures the global DHCP smart relay setting. DHCP smart relay supports forwarding DHCP requests with a client's secondary IP addresses in the gateway address field. The default global DHCP smart relay setting is disabled.

The global DHCP smart relay setting is applied to all interfaces for which an `ip dhcp relay all-subnets` statement is not configured. Enabling DHCP smart relay on an interface requires that DHCP relay is also enabled on that interface.

The `no ip dhcp relay all-subnets default` and `default ip dhcp relay all-subnets default` commands restore the global DHCP smart relay default setting of disabled by removing the `ip dhcp relay all-subnets default` command from *running-config*.

Command Mode

Global Configuration

Command Syntax

```
ip dhcp relay all-subnets default
no ip dhcp relay all-subnets default
default ip dhcp relay all-subnets default
```

Related Commands

- [ip helper-address](#) Enables the DHCP relay agent on a configuration mode interface.
- [ip dhcp relay all-subnets](#) Enables the DHCP smart relay agent on a configuration mode interface.

Example:

This command configures the global DHCP smart relay setting to **enabled**.

```
switch(config)#ip dhcp relay all-subnets default
switch(config)#
```

12.1.14.22 ip dhcp relay all-subnets

The `ip dhcp relay all-subnets` command configures the DHCP smart relay status on the configuration mode interface. DHCP smart relay supports forwarding DHCP requests with a client's secondary IP addresses in the gateway address field. Enabling DHCP smart relay on an interface requires that DHCP relay is also enabled on that interface.

By default, an interface assumes the global DHCP smart relay setting as configured by the `ip dhcp relay all-subnets default` command. The `ip dhcp relay all-subnets` command, when configured, takes precedence over the global smart relay setting.

The `no ip dhcp relay all-subnets` command disables DHCP smart relay on the configuration mode interface. The `default ip dhcp relay all-subnets` command restores the interface's to the default DHCP smart relay setting, as configured by the `ip dhcp relay all-subnets default` command, by removing the corresponding `ip dhcp relay all-subnets` or `no ip dhcp relay all-subnets` statement from *running-config*.

Command Mode

Interface-Ethernet Configuration

Interface-Port-channel Configuration

Interface-VLAN Configuration

Command Syntax

```
ip dhcp relay all-subnets
no ip dhcp relay all-subnets
default ip dhcp relay all-subnets
```

Examples:

- This command enables DHCP smart relay on VLAN interface 100.

```
switch(config)#interface vlan 100
switch(config-if-Vl100)#ip helper-address 10.4.4.4
switch(config-if-Vl100)#ip dhcp relay all-subnets
switch(config-if-Vl100)#show ip dhcp relay
DHCP Relay is active
DHCP Relay Option 82 is disabled
DHCP Smart Relay is enabled
Interface: Vlan100
    DHCP Smart Relay is enabled
    DHCP servers: 10.4.4.4
switch(config-if-Vl100)#
```

- This command disables DHCP smart relay on VLAN interface 100.

```
switch(config-if-Vl100)#no ip dhcp relay all-subnets
switch(config-if-Vl100)#show active
interface Vlan100
    no ip dhcp relay all-subnets
    ip helper-address 10.4.4.4
switch(config-if-Vl100)#show ip dhcp relay
DHCP Relay is active
DHCP Relay Option 82 is disabled
DHCP Smart Relay is enabled
Interface: Vlan100
    DHCP Smart Relay is disabled
    DHCP servers: 10.4.4.4
switch(config-if-Vl100)#
```

- This command enables DHCP smart relay globally, configures VLAN interface 100 to use the global setting, then displays the DHCP relay status.

```
switch(config)#ip dhcp relay all-subnets default
switch(config)#interface vlan 100
switch(config-if-Vl100)#ip helper-address 10.4.4.4
switch(config-if-Vl100)#default ip dhcp relay
switch(config-if-Vl100)#show ip dhcp relay
DHCP Relay is active
DHCP Relay Option 82 is disabled
DHCP Smart Relay is enabled
Interface: Vlan100
  Option 82 Circuit ID: 333
  DHCP Smart Relay is enabled
  DHCP servers: 10.4.4.4
switch(config-if-Vl100)#
```

12.1.14.23 ip dhcp relay always-on

The `ip dhcp relay always-on` command enables the switch DHCP relay agent on the switch regardless of the DHCP relay agent status on any interface. By default, the DHCP relay agent is enabled only if at least one routable interface is configured with an `ip helper-address` statement.

The `no ip dhcp relay always-on` and `default ip dhcp relay always-on` commands remove the `ip dhcp relay always-on` command from *running-config*.

Command Mode

Global Configuration

Command Syntax

```
ip dhcp relay always-on
no ip dhcp relay always-on
default ip dhcp relay always-on
```

Related Commands

These commands implement DHCP relay agent.

- [ip helper-address](#)
- [ip dhcp relay information option \(Global\)](#)
- [ip dhcp relay information option circuit-id](#)

Example:

This command enables the DHCP relay agent.

```
switch(config)#ip dhcp relay always-on
switch(config)#
```

12.1.14.24 ip dhcp relay information option (Global)

The **ip dhcp relay information option** command configures the switch to attach tags to DHCP requests before forwarding them to the DHCP servers designated by [ip helper-address](#) commands. The command specifies the tag contents for packets forwarded by the interface that it configures.

The **no ip dhcp relay information option** and **default ip dhcp relay information option** commands restore the switch's default setting of not attaching tags to DHCP requests by removing the **ip dhcp relay information option** command from *running-config*.

Command Mode

Global Configuration

Command Syntax

```
ip dhcp relay information option
no ip dhcp relay information option
default ip dhcp relay information option
```

Related Commands

These commands implement DHCP relay agent.

- [ip helper-address](#)
- [ip dhcp relay always-on](#)
- [ip dhcp relay information option circuit-id](#)

Example:

This command enables the attachment of tags to DHCP requests that are forwarded to DHCP server addresses.

```
switch(config)#ip dhcp relay information option
switch(config)#
```

12.1.14.25 ip dhcp relay information option circuit-id

The `ip dhcp relay information option circuit-id` command specifies the content of tags that the switch attaches to DHCP requests before they are forwarded from the configuration mode interface to DHCP server addresses specified by `ip helper-address` commands. Tags are attached to outbound DHCP requests only if the information option is enabled on the switch (`ip dhcp relay information option circuit-id`). The default value for each interface is the name and number of the interface.

The `no ip dhcp relay information option circuit-id` and `default ip dhcp relay information option circuit-id` commands restore the default content setting for the configuration mode interface by removing the corresponding command from *running-config*.

Command Mode

Interface-Ethernet Configuration

Interface-Loopback Configuration

Interface-Management Configuration

Interface-Port-channel Configuration

Interface-VLAN Configuration

Command Syntax

```
ip dhcp relay information option circuit-id id_label
```

```
no ip dhcp relay information option circuit-id
```

```
default ip dhcp relay information option circuit-id
```

Parameters

- *id_label* Tag content. Format is alphanumeric characters (maximum 15 characters).

Related Commands

- [ip helper-address](#)
- [ip dhcp relay always-on](#)
- [ip dhcp relay information option \(Global\)](#)

Example:

This command configures `x-1234` as the tag content for packets send from VLAN 200.

```
switch(config)#interface vlan 200
switch(config-if-Vl200)#ip dhcp relay information option circuit-
id x-1234
switch(config-if-Vl200)#
```

12.1.14.26 ip dhcp snooping

The **ip dhcp snooping** command enables DHCP snooping globally on the switch. DHCP snooping is a set of layer 2 processes that can be configured on LAN switches and used with DHCP servers to control network access to clients with specific IP/MAC addresses. The switch supports Option-82 insertion, which is a DHCP snooping process that allows relay agents to provide remote-ID and circuit-ID information to DHCP reply and request packets. DHCP servers use this information to determine the originating port of DHCP requests and associate a corresponding IP address to that port. DHCP servers use port information to track host location and IP address usage by authorized physical ports.

DHCP snooping uses the information option (Option-82) to include the switch MAC address (router-ID) along with the physical interface name and VLAN number (circuit-ID) in DHCP packets. After adding the information to the packet, the DHCP relay agent forwards the packet to the DHCP server as specified by the DHCP protocol.

DHCP snooping on a specified VLAN requires all of these conditions to be met:

- DHCP snooping is globally enabled.
- Insertion of option-82 information in DHCP packets is enabled.
- DHCP snooping is enabled on the specified VLAN.
- DHCP relay is enabled on the corresponding VLAN interface.

The **no ip dhcp snooping** and **default ip dhcp snooping** commands disables global DHCP snooping by removing the **ip dhcp snooping** command from **running-config**.

Command Mode

Global Configuration

Command Syntax

```
ip dhcp snooping
```

```
no ip dhcp snooping
```

```
default ip dhcp snooping
```

Related Commands

- [ip dhcp snooping information option](#) enables insertion of option-82 snooping data.
- [ip helper-address](#) enables the DHCP relay agent on a configuration mode interface.

Example:

This command globally enables snooping on the switch, displaying DHCP snooping status prior and after invoking the command.

```
switch(config)#show ip dhcp snooping
DHCP Snooping is disabled
switch(config)#ip dhcp snooping
switch(config)#show ip dhcp snooping
DHCP Snooping is enabled
DHCP Snooping is not operational
DHCP Snooping is configured on following VLANs:
  None
DHCP Snooping is operational on following VLANs:
  None
Insertion of Option-82 is disabled
switch(config)#
```

12.1.14.27 ip dhcp snooping bridging

The `ip dhcp snooping bridging` command enables the DHCP snooping bridging configuration.

The `no ip dhcp snooping bridging` command removes the DHCP snooping bridging configuration from the `running-config`.

Command Mode

Global Configuration Mode

Command Syntax

`ip dhcp snooping bridging`

`no ip dhcp snooping bridging`

Example

- This command configures the DHCP snooping bridging.

```
switch#conf
switch(config)#ip dhcp snooping bridging
```

12.1.14.28 ip dhcp snooping information option

The **ip dhcp snooping information option** command enables the insertion of option-82 DHCP snooping information in DHCP packets on VLANs where DHCP snooping is enabled. DHCP snooping is a layer 2 switch process that allows relay agents to provide remote-ID and circuit-ID information to DHCP reply and request packets. DHCP servers use this information to determine the originating port of DHCP requests and associate a corresponding IP address to that port.

DHCP snooping uses information option (Option-82) to include the switch MAC address (router-ID) along with the physical interface name and VLAN number (circuit-ID) in DHCP packets. After adding the information to the packet, the DHCP relay agent forwards the packet to the DHCP server through DHCP protocol processes.

DHCP snooping on a specified VLAN requires all of these conditions to be met:

- DHCP snooping is globally enabled.
- Insertion of option-82 information in DHCP packets is enabled.
- DHCP snooping is enabled on the specified VLAN.
- DHCP relay is enabled on the corresponding VLAN interface.

When global DHCP snooping is not enabled, the **ip dhcp snooping information option** command persists in **running-config** without any operational effect.

The **no ip dhcp snooping information option** and **default ip dhcp snooping information option** commands disable the insertion of option-82 DHCP snooping information in DHCP packets by removing the **ip dhcp snooping information option** statement from **running-config**.

Command Mode

Global Configuration

Command Syntax

```
ip dhcp snooping information option
no ip dhcp snooping information option
default ip dhcp snooping information option
```

Related Commands

- [ip dhcp snooping](#) globally enables DHCP snooping.
- [ip helper-address](#) enables the DHCP relay agent on a configuration mode interface.

Example:

These commands enable DHCP snooping on DHCP packets from ports on snooping-enabled VLANs. DHCP snooping was previously enabled on the switch.

```
switch(config)#ip dhcp snooping information option
switch(config)#show ip dhcp snooping
DHCP Snooping is enabled
DHCP Snooping is operational
DHCP Snooping is configured on following VLANs:
 100
DHCP Snooping is operational on following VLANs:
 100
Insertion of Option-82 is enabled
Circuit-id format: Interface name:Vlan ID
Remote-id: 00:1c:73:1f:b4:38 (Switch MAC)
```

```
switch(config)#
```

12.1.14.29 ip dhcp snooping vlan

The **ip dhcp snooping vlan** command enables DHCP snooping on specified VLANs. DHCP snooping is a Layer 2 process that allows relay agents to provide remote-ID and circuit-ID information in DHCP packets. DHCP servers use this data to determine the originating port of DHCP requests and associate a corresponding IP address to that port. DHCP snooping is configured on a global and VLAN basis.

VLAN snooping on a specified VLAN requires each of these conditions:

- DHCP snooping is globally enabled.
- Insertion of option-82 information in DHCP packets is enabled.
- DHCP snooping is enabled on the specified VLAN.
- DHCP relay is enabled on the corresponding VLAN interface.

When global DHCP snooping is not enabled, the **ip dhcp snooping vlan** command persists in **running-config** without any operational affect.

The **no ip dhcp snooping information option** and **default ip dhcp snooping information option** commands disable DHCP snooping operability by removing the **ip dhcp snooping information option** statement from **running-config**.

Command Mode

Global Configuration

Command Syntax

```
ip dhcp snooping vlan v_range
no ip dhcp snooping vlan v_range
default ip dhcp snooping vlan v_range
```

Parameters

- **v_range** VLANs upon which snooping is enabled. Formats include a number, a number range, or a comma-delimited list of numbers and ranges. Numbers range from 1 to 4094.

Related Commands

- [ip dhcp snooping](#) globally enables DHCP snooping.
- [ip dhcp snooping vlan](#) enables insertion of option-82 snooping data.
- [ip helper-address](#) enables the DHCP relay agent on a configuration mode interface.

Example:

These commands enable DHCP snooping globally, DHCP on VLAN interface100, and DHCP snooping on VLAN 100.

```
switch(config)#ip dhcp snooping
switch(config)#ip dhcp snooping information option
switch(config)#ip dhcp snooping vlan 100
switch(config)#interface vlan 100
switch(config-if-Vl100)#ip helper-address 10.4.4.4
switch(config-if-Vl100)#show ip dhcp snooping
DHCP Snooping is enabled
DHCP Snooping is operational
DHCP Snooping is configured on following VLANs:
 100
DHCP Snooping is operational on following VLANs:
 100
Insertion of Option-82 is enabled
Circuit-id format: Interface name:Vlan ID
Remote-id: 00:1c:73:1f:b4:38 (Switch MAC)
```

```
switch(config)#
```

12.1.14.30 ip hardware fib ecmp resilience

The **ip hardware fib ecmp resilience** command enables resilient ECMP for the specified IP address prefix and configures a fixed number of next hop entries in the hardware ECMP table for that prefix. In addition to specifying the maximum number of next hop addresses that the table can contain for the prefix, the command includes a redundancy factor that allows duplication of each next hop address. The fixed table space for the address is the maximum number of next hops multiplied by the redundancy factor.

Resilient ECMP is useful when it is not desirable for routes to be rehashed due to link flap, as when ECMP is being used for load balancing.

The **no ip hardware fib ecmp resilience** and **default ip hardware fib ecmp resilience** commands restore the default hardware ECMP table management by removing the **ip hardware fib ecmp resilience** command from *running-config*.

Command Mode

Global Configuration

Command Syntax

```
ip hardware fib ecmp resilience net_addr capacity nhop_max redundancy duplicates
```

```
no ip hardware fib ecmp resilience net_addr
```

```
default ip hardware fib ecmp resilience net_addr
```

Parameters

- ***net_addr*** IP address prefix managed by command. (CIDR or address-mask).
- ***nhop_max*** Maximum number of nexthop addresses for specified IP address prefix. Value range varies by platform:
 - Helix: <2 to 64>
 - Trident: <2 to 32>
 - Trident II: <2 to 64>
- ***duplicates*** Specifies the redundancy factor. Value ranges from 1 to 128.

Example:

This command configures a hardware ECMP table space of 24 entries for the IP address 10.14.2.2/24. A maximum of six next-hop addresses can be specified for the IP address. When the table contains six next-hop addresses, each appears in the table four times. When the table contains fewer than six next-hop addresses, each is duplicated until the 24 table entries are filled.

```
switch(config)#ip hardware fib ecmp resilience 10.14.2.2/24
  capacity 6 redundancy 4
switch(config)#
```

12.1.14.31 ip hardware fib optimize

The `ip hardware fib optimize` command enables IPv4 route scale. The platform layer 3 agent is restarted to ensure IPv4 routes are optimized with the [agent SandL3Unicast terminate](#) command for the configuration mode interface.

Command Mode

Global Configuration

Command Syntax

```
ip hardware fib optimize exact-match prefix-length <prefix-length> <optional: prefix-length>
```

```
ip hardware fib optimize exact-match prefix-length <prefix-length> <optional: prefix-length>
```

Parameters

- **prefix-length** The length of the prefix equal to 12, 16, 20, 24, 28, or 32. One additional prefix-length limited to the prefix-length of 32 is optional.

Related Commands

- [agent SandL3Unicast terminate](#) enables restarting the layer 3 agent to ensure IPv4 routes are optimized.
- [show platform arad ip route](#) shows resources for all IPv4 routes in hardware. Routes that use the additional hardware resources will appear with an asterisk.
- [show platform arad ip route summary](#) shows hardware resource usage of IPv4 routes.

Examples:

- This configuration command allows configuring prefix lengths 12 and 32.

```
switch(config)#ip hardware fib optimize exact-match prefix-length 12 32
! Please restart layer 3 forwarding agent to ensure IPv4 routes are optimized
```

- One of the two prefixes in this command is a prefix-length of 32, which is required in the instance where there are two prefixes. For this command to take effect, the platform layer 3 agent must be restarted.
 - This configuration command restarts the platform layer 3 agent to ensure IPv4 routes are optimized.

```
switch(config)#agent SandL3Unicast terminate
SandL3Unicast was terminated
```

- Restarting the platform layer 3 agent results in deletion of all IPv4 routes, which are re-added to the hardware.
 - This configuration command allows configuring prefix lengths 32 and 16.

```
switch(config)#ip hardware fib optimize exact-match prefix-length 32 16
! Please restart layer 3 forwarding agent to ensure IPv4 routes are optimized
```

- One of the two prefixes in this command is a prefix-length of 32, which is required in the instance where there are two prefixes. For this command to take effect, the platform layer 3 agent must be restarted.

- This configuration command restarts the platform layer 3 agent to ensure IPv4 routes are optimized.

```
switch(config)#agent SandL3Unicast terminate
SandL3Unicast was terminated
```

- Restarting the platform layer 3 agent results in deletion of all IPv4 routes, which are re-added to the hardware.

- This configuration command allows configuring prefix length 24.

```
switch(config)#ip hardware fib optimize exact-match prefix-length 24
! Please restart layer 3 forwarding agent to ensure IPv4 routes are optimized
```

- In this instance, there is only one prefix-length, so a prefix-length of 32 is not required. For this command to take effect, the platform layer 3 agent must be restarted.

- This configuration command restarts the platform layer 3 agent to ensure IPv4 routes are optimized.

```
switch(config)#agent SandL3Unicast terminate
SandL3Unicast was terminated
```

- Restarting the platform layer 3 agent results in deletion of all IPv4 routes, which are re-added to the hardware.

- This configuration command allows configuring prefix length 32.

```
switch(config)#ip hardware fib optimize exact-match prefix-length 32
! Please restart layer 3 forwarding agent to ensure IPv4 routes are optimized
```

- For this command to take effect, the platform layer 3 agent must be restarted.

- This configuration command restarts the platform layer 3 agent to ensure IPv4 routes are optimized.

```
switch(config)#agent SandL3Unicast terminate
SandL3Unicast was terminated
```

- Restarting the platform layer 3 agent results in deletion of all IPv4 routes, which are re-added to the hardware.

- This configuration command disables configuring prefix lengths 12 and 32.

```
switch(config)#no ip hardware fib optimize exact-match prefix-length 12 32
! Please restart layer 3 forwarding agent to ensure IPv4 routes are not optimized
```

- One of the two prefixes in this command is a prefix-length of 32, which is required in the instance where there are two prefixes. For this command to take effect, the platform layer 3 agent must be restarted.

12.1.14.32 ip helper-address

The **ip helper-address** command enables the DHCP relay agent on the configuration mode interface and specifies a forwarding address for DHCP requests. An interface that is configured with multiple helper-addresses forwards DHCP requests to all specified addresses.

The **no ip helper-address** and **default ip helper-address** commands remove the corresponding **ip helper-address** command from *running-config*. Commands that do not specify an IP helper-address remove all helper-addresses from the interface.

Command Mode

Interface-Ethernet Configuration

Interface-Port-channel Configuration

Interface-VLAN Configuration

Command Syntax

```
ip helper-address ipv4_addr [vrf vrf_name][source-address ipv4_addr | source-interface INTERFACES]
```

```
no ip helper-address [ipv4_addr]
```

```
default ip helper-address [ipv4_addr]
```

Parameters

- **vrf *vrf_name*** Specifies the user-defined VRF for DHCP server.
- ***ipv4_addr*** Specifies the DHCP server address accessed by interface.
- **source-address *ipv4_addr*** Specifies the source IPv4 address to communicate with DHCP server.
- **source-interface INTERFACES** Specifies the source interface to communicate with DHCP server. Options include:
 - **Ethernet *eth_num*** Specifies the Ethernet interface number.
 - **Loopback *lpbck_num*** Specifies the loopback interface number. Value ranges from 0 to 1000.
 - **Management *mgmt_num*** Specifies the management interface number. Accepted values are 1 and 2.
 - **Port-Channel {*int_num* | *sub_int_num*}** Specifies the port-channel interface or subinterface number. Value of interface ranges from 1 to 2000. Value of sub-interface ranges from 1 to 4094.
 - **Tunnel *tnl_num*** Specifies the tunnel interface number. Value ranges from 0 to 255.
 - **VLAN *vlan_num*** Specifies the Ethernet interface number. Value ranges from 1 to 4094.

Related Commands

- [ip dhcp relay always-on](#)
- [ip dhcp relay information option \(Global\)](#)
- [ip dhcp relay information option circuit-id](#)

Guidelines

If the source-address parameter is specified, then the DHCP client receives an IPv4 address from the subnet of source IP address. The source-address must be one of the configured addresses on the interface.

Examples:

- This command enables DHCP relay on the VLAN interface 200; and configure the switch to forward DHCP requests received on this interface to the server at 10.10.41.15.

```
switch(config)#interface vlan 200
switch(config-if-Vl200)#ip helper-address 10.10.41.15
switch(config-if-Vl200)#show active
interface Vlan200
    ip helper-address 10.10.41.15
switch(config-if-Vl200)#
```

- This command enables DHCP relay on the interface Ethernet 1/2; and configures the switch to use 2.2.2.2 as the source IP address when relaying IPv4 DHCP messages to the server at 1.1.1.1.

```
switch(config)#interface ethernet 1/2
switch(config-if-Et1/2)#ip helper-address 1.1.1.1 source-
address 2.2.2.2
switch(config-if-Et1/2)#
```

12.1.14.33 ip icmp redirect

The **ip icmp redirect** command enables the transmission of ICMP redirect messages. Routers send ICMP redirect messages to notify data link hosts of the availability of a better route for a specific destination.

The **no ip icmp redirect** disables the switch from sending ICMP redirect messages.

Command Mode

Global Configuration

Command Syntax

```
ip icmp redirect
```

```
no ip icmp redirect
```

```
default ip icmp redirect
```

Example:

This command disables the redirect messages.

```
switch(config)#no ip icmp redirect
switch(config)#show running-config
<-----OUTPUT OMITTED FROM EXAMPLE----->
!
no ip icmp redirect
ip routing
!
<-----OUTPUT OMITTED FROM EXAMPLE----->
switch(config)#
```

12.1.14.34 ip load-sharing

The **ip load-sharing** command provides the hash seed to an algorithm that the switch uses to distribute data streams among multiple equal-cost routes to an individual IPv4 subnet.

In a network topology using Equal-Cost Multipath routing, all switches performing identical hash calculations may result in hash polarization, leading to uneven load distribution among the data paths. Hash polarization is avoided when switches use different hash seeds to perform different hash calculations.

The **no ip load-sharing** and **default ip load-sharing** commands return the hash seed to the default value of zero by removing the **ip load-sharing** command from *running-config*.

Command Mode

Global Configuration

Command Syntax

```
ip load-sharing HARDWARE seed
```

```
no ip load-sharing HARDWARE
```

```
default ip load-sharing HARDWARE
```

Parameters

- **HARDWARE** The ASIC switching device. The available option depend on the switch platform. Verify available options with the CLI ? command.
 - **arad**
 - **fm6000**
 - **petraA**
 - **trident**
- **seed** The hash seed. Value range varies by switch platform. The default value on all platforms is 0.
 - when **HARDWARE=arad** **seed** ranges from 0 to 2.
 - when **HARDWARE=fm6000** **seed** ranges from 0 to 39.
 - when **HARDWARE=petraA** **seed** ranges from 0 to 2.
 - when **HARDWARE=trident** **seed** ranges from 0 to 5.

Example:

This command sets the IPv4 load sharing hash seed to one on FM6000 platform switches.

```
switch(config)#ip load-sharing fm6000 1
switch(config)#
```

12.1.14.35 ip local-proxy-arp

The **ip local-proxy-arp** command enables local proxy ARP (Address Resolution Protocol) on the configuration mode interface. When local proxy ARP is enabled, ARP requests received on the configuration mode interface will return an IP address even when the request comes from within the same subnet.

The **no ip local-proxy-arp** and **default ip local-proxy-arp** commands disable local proxy ARP on the configuration mode interface by removing the corresponding **ip local-proxy-arp** command from *running-config*.

Command Mode

Interface-Ethernet Configuration
Interface-Loopback Configuration
Interface-Management Configuration
Interface-Port-channel Configuration
Interface-VLAN Configuration

Command Syntax

```
ip local-proxy-arp
no ip local-proxy-arp
default ip local-proxy-arp
```

Example:

These commands enable local proxy ARP on VLAN interface 140.

```
switch(config)#interface vlan 140
switch(config-if-Vl140)#ip local-proxy-arp
switch(config-if-Vl140)#show active
interface Vlan140
    ip local-proxy-arp
switch(config-if-Vl140)#
```

12.1.14.36 ip multicast count

The **ip multicast count** command enables the IPv4 multicast route traffic counter of group and source addresses in either bytes or packets.

The **no ip multicast count** command deletes all multicast counters including the routes of group and source addresses.

The **no ip multicast count *group_address source_address*** command removes the current configuration of the specified group and source addresses. It does not delete the counter because the wildcard is still active.

The **default ip multicast count** command reverts the current counter configuration of multicast route to the default state.

Command Mode

Global Configuration

Command Syntax

```
ip multicast count [group_address [source_address] | bytes | packets]
```

```
no ip multicast count [group_address [source_address] | bytes | packets]
```

```
default ip multicast count [group_address [source_address] | bytes | packets]
```

Parameters

- **group_address** Configures the multicast route traffic count of the specified group address.
 - **source_address** Configures the multicast route traffic count of the specified group and source addresses.
- **bytes** Configures the multicast route traffic count to bytes.
- **packets** Configures the multicast route traffic count to packets.

Guidelines

This command is supported on the FM6000 platform only.

Examples:

- This command configures the multicast route traffic count to bytes.

```
switch(config)#ip multicast count bytes
```

- This command configures the multicast route traffic count of the specified group and source addresses.

```
switch(config)#ip multicast count 10.50.30.23 45.67.89.100
```

- This command deletes all multicast counters including the routes of group and source addresses.

```
switch(config)#no ip multicast count
```

- This command reverts the current multicast route configuration to the default state.

```
switch(config)#default ip multicast count
```

12.1.14.37 ip proxy-arp

The **ip proxy-arp** command enables proxy ARP on the configuration mode interface. Proxy ARP is disabled by default.

The **no ip proxy-arp** and **default ip proxy-arp** commands disable proxy ARP on the configuration mode interface by removing the corresponding **ip proxy-arp** command from *running-config*.

Command Mode

Interface-Ethernet Configuration

Interface-Loopback Configuration

Interface-Management Configuration

Interface-Port-channel Configuration

Interface-VLAN Configuration

Command Syntax

```
ip proxy-arp
```

```
no ip proxy-arp
```

```
default ip proxy-arp
```

Example:

This command enables proxy ARP on Ethernet interface 4.

```
switch(config)#interface ethernet 4  
switch(config-if-Et4)#ip proxy-arp  
switch(config-if-Et4)#
```

12.1.14.38 ip route

The **ip route** command creates a static route. The destination is a network segment; the nexthop address is either an IPv4 address or a routable port. When multiple routes exist to a destination prefix, the route with the lowest administrative distance takes precedence.

By default, the administrative distance assigned to static routes is 1. Assigning a higher administrative distance to a static route configures it to be overridden by dynamic routing data. For example, a static route with an administrative distance value of 200 is overridden by OSPF intra-area routes, which have a default administrative distance of 110.

Tags are used by route maps to filter routes. The default tag value on static routes is 0.

Multiple routes with the same destination and the same administrative distance comprise an Equal Cost Multi-Path (ECMP) route. The switch attempts to spread outbound traffic equally through all ECMP route paths. All paths comprising an ECMP are assigned identical tag values; commands that change the tag value of a path change the tag value of all paths in the ECMP.

The **no ip route** and **default ip route** commands delete the specified static route by removing the corresponding **ip route** command from **running-config**. Commands that do not list a nexthop address remove all **ip route** statements with the specified destination from **running-config**. If an **ip route** statement exists for the same IP address in multiple VRFs, each must be removed separately. All static routes in a user-defined VRF are deleted when the VRF is deleted.

Command Mode

Global Configuration

Command Syntax

```
ip route [VRF_INSTANCE]dest_net NEXTHOP [DISTANCE][TAG_OPTION][RT_NAME]
```

```
no ip route [VRF_INSTANCE]dest_net [NEXTHOP][DISTANCE]
```

```
default ip route [VRF_INSTANCE] dest_net [NEXTHOP][DISTANCE]
```

Parameters

- **VRF_INSTANCE** Specifies the VRF instance being modified.
 - **<no parameter>** Changes are made to the default VRF.
 - **vrf vrf_name** Changes are made to the specified VRF.
- **dest_net** Destination IPv4 subnet (CIDR or address-mask notation).
- **NEXTHOP** Location or access method of next hop device. Options include:
 - **ipv4_addr** An IPv4 address.
 - **null0** Null0 interface.
 - **ethernet e_num** Ethernet interface specified by **e_num**.
 - **loopback l_num** Loopback interface specified by **l_num**.
 - **management m_num** Management interface specified by **m_num**.
 - **port-channel p_num** Port-channel interface specified by **p_num**.
 - **vlan v_num** VLAN interface specified by **v_num**.
 - **vxlan vx_num** VXLAN interface specified by **vx_num**.
- **DISTANCE** Administrative distance assigned to route. Options include:
 - **<no parameter>** Route assigned default administrative distance of one.
 - **<1-255>** The administrative distance assigned to route.
- **TAG_OPTION** Static route tag. Options include:
 - **<no parameter>** Assigns default static route tag of 0.
 - **tag t_value** Static route tag value. **t_value** ranges from 0 to 4294967295.

-
- **RT_NAME** Associates descriptive text to the route. Options include:
 - **<no parameter>** No text is associated with the route.
 - **name *descriptive_text*** The specified text is assigned to the route.

Related Command

The `ip route nexthop-group` command creates a static route that specifies a Nexthop Group to determine the Nexthop address.

Example

This command creates a static route in the default VRF.

```
switch(config)#ip route 172.17.252.0/24 vlan 2000
switch(config)#
```

12.1.14.39 ip routing

The **ip routing** command enables IPv4 routing. When IPv4 routing is enabled, the switch attempts to deliver inbound packets to destination IPv4 addresses by forwarding them to interfaces or next hop addresses specified by the forwarding table.

The **no ip routing** and **default ip routing** commands disable IPv4 routing by removing the **ip routing** command from *running-config*. When IPv4 routing is disabled, the switch attempts to deliver inbound packets to their destination MAC addresses. When this address matches the switch's MAC address, the packet is delivered to the CPU. IP packets with IPv4 destinations that differ from the switch's address are typically discarded. The **delete-static-routes** option removes static entries from the routing table.

IPv4 routing is disabled by default.

Command Mode

Global Configuration

Command Syntax

```
ip routing [VRF_INSTANCE]
no ip routing [DELETE_ROUTES][VRF_INSTANCE]
default ip routing [DELETE_ROUTES][VRF_INSTANCE]
```

Parameters

- **DELETE_ROUTES** Resolves routing table static entries when routing is disabled.
 - **<no parameter>** Routing table retains static entries.
 - **delete-static-routes** Static entries are removed from the routing table.
- **VRF_INSTANCE** Specifies the VRF instance being modified.
 - **<no parameter>** Changes are made to the default VRF.
 - **vrf vrf_name** Changes are made to the specified user-defined VRF.

Example:

This command enables IPv4 routing.

```
switch(config)#ip routing
switch(config)#
```

12.1.14.40 ip source binding

IP source guard (IPSG) is supported on Layer 2 Port-Channels, not member ports. The IPSG configuration on port channels supersedes the configuration on the physical member ports. Hence, source IP MAC binding entries should be configured on port channels. When configured on a port channel member port, IPSG does not take effect until this port is deleted from the port channel configuration.

 **Note:** IP source bindings are also used by static ARP inspection.

The `no ip source binding` and `default ip source binding` commands exclude parameters from IPSG filtering, and set the default for `ip source binding`.

Command Mode

Interface-Ethernet Configuration

Command Syntax

```
ip source binding [IP_ADDRESS][MAC_ADDRESS]vlan [VLAN_RANGE] interface [INTERFACE]
```

```
no ip source binding [IP_ADDRESS][MAC_ADDRESS] vlan [VLAN_RANGE] interface [INTERFACE]
```

```
default ip source binding [IP_ADDRESS][MAC_ADDRESS] vlan [VLAN_RANGE] interface [INTERFACE]
```

Parameters

- **IP_ADDRESS** Specifies the IP ADDRESS.
- **MAC_ADDRESS** Specifies the MAC ADDRESS.
- **VLAN_RANGE** Specifies the VLAN ID range.
- **INTERFACE** Specifies the Ethernet interface.

Related Commands

- [ip verify source](#)
- [show ip verify source](#)

Example:

This command configures source IP-MAC binding entries to IP address *10.1.1.1*, MAC address *0000.aaaa.1111*, VLAN ID *4094*, and *Ethernet interface 36*.

```
switch(config)#ip source binding 10.1.1.1 0000.aaaa.1111 vlan
4094 interface
ethernet 36
switch(config)#
```

12.1.14.41 ip verify source

The **ip verify source** command configures IP source guard (IPSG) applicable only to Layer 2 ports. When configured on Layer 3 ports, IPSG does not take effect until this interface is converted to Layer 2.

IPSG is supported on Layer 2 Port-Channels, not member ports. The IPSG configuration on port channels supersedes the configuration on the physical member ports. Therefore, source IP MAC binding entries should be configured on port channels. When configured on a port channel member port, IPSG does not take effect until this port is deleted from the port channel configuration.

The **no ip verify source** and **default ip verify source** commands exclude VLAN IDs from IPSG filtering, and set the default for **ip verify source**.

Command Mode

Interface-Ethernet Configuration

Command Syntax

```
ip verify source vlan [VLAN_RANGE]
no ip verify source [VLAN_RANGE]
default ip verify source
```

Parameters

- **VLAN_RANGE** Specifies the VLAN ID range.

Related Commands

- [ip source binding](#)
- [show ip verify source](#)

Example:

This command excludes VLAN IDs 1 through 3 from IPSG filtering. When enabled on a trunk port, IPSG filters the inbound IP packets on all allowed VLANs. IP packets received on VLANs 4 through 10 on *Ethernet* 36 will be filtered by IPSG, while those received on VLANs 1 through 3 are permitted.

```
switch(config)#no ip verify source vlan 1-3
switch(config)#interface ethernet 36
switch(config-if-Et36)#switchport mode trunk
switch(config-if-Et36)#switchport trunk allowed vlan 1-10
switch(config-if-Et36)#ip verify source
switch(config-if-Et36)#
```

12.1.14.42 ip verify

The **ip verify** command configures Unicast Reverse Path Forwarding (uRPF) for inbound IPv4 packets on the configuration mode interface. uRPF verifies the accessibility of source IP addresses in packets that the switch forwards.

uRPF defines two operational modes: strict mode and loose mode.

- **Strict mode:** uRPF verifies that a packet is received on the interface that its routing table entry specifies for its return packet.
- **Loose mode:** uRPF validation does not consider the inbound packet's ingress interface only that there is a valid return path.

The **no ip verify** and **default ip verify** commands disable uRPF on the configuration mode interface by deleting the corresponding **ip verify** command from **running-config**.

Command Mode

Interface-Ethernet Configuration

Interface-Loopback Configuration

Interface-Management Configuration

Interface-Port-Channel Configuration

Interface-VLAN Configuration

Command Syntax

```
ip verify unicast source reachable-via RPF_MODE
```

```
no ip verify unicast
```

```
default ip verify unicast
```

Parameters

- **RPF_MODE** Specifies the uRPF mode. Options include:
 - **any** Loose mode.
 - **rx** Strict mode.
 - **rx allow-default** Strict mode. All inbound packets are forwarded if a default route is defined.

Guidelines

The first IPv4 uRPF implementation briefly disrupts IPv4 unicast routing. Subsequent **ip verify** commands on any interface do not disrupt IPv4 routing.

Examples:

- This command enables uRPF loose mode on *VLAN interface 17*.

```
switch(config)#interface vlan 17
switch(config-if-Vl17)#ip verify unicast source reachable-via
any
switch(config-if-Vl17)#show active
interface Vlan17
    ip verify unicast source reachable-via any
switch(config-if-Vl17)#
```

- This command enables uRPF strict mode on *VLAN interface 18*.

```
switch(config)#interface vlan 18
switch(config-if-Vl18)#ip verify unicast source reachable-via
rx
```



```
switch(config-if-Vl18)#show active  
interface Vlan18  
  ip verify unicast source reachable-via rx  
switch(config-if-Vl18)#
```

12.1.14.43 ipv4 routable 240.0.0.0/4

The **ipv4 routable 240.0.0.0/4** command assigns an class E addresses to an interface. When configured, the class E address traffic are routed through BGP, OSPF, ISIS, RIP, static routes and programmed to the FIB and kernel. By default, this command is disabled.

The **no ipv4 routable 240.0.0.0/4** and **default ipv4 routable 240.0.0.0/4** commands disable IPv4 Class E routing by removing the **ipv4 routable 240.0.0.0/4** command from **running-config**.

IPv4 routable 240.0.0.0/4 routing is disabled by default.

Command Mode

Router General Configuration

Command Syntax

```
ipv4 routable 240.0.0.0/4
no ipv4 routable 240.0.0.0/4
default ipv4 routable 240.0.0.0/4
```

Example:

- These commands configure an IPv4 Class E (240/4) address to an interface.

```
switch(config)#router general
switch(config-router-general)#ipv4 routable 240.0.0.0/4
```

12.1.14.44 platform trident forwarding-table partition

The **platform trident forwarding-table partition** command provides a shared table memory for L2, L3 and algorithmic LPM entries that can be partitioned in different ways.

Instead of having fixed-size tables for L2 MAC entry tables, L3 IP forwarding tables, and Longest Prefix Match (LPM) routes, the tables can be unified into a single shareable forwarding table.

 **Note:** Changing the Unified Forwarding Table mode causes the forwarding agent to restart, briefly disrupting traffic forwarding on all ports.

The **no platform trident forwarding-table partition** and **default platform trident forwarding-table partition** commands remove the **platform trident forwarding-table partition** command from *running-config*.

Command Mode

Global Configuration

Command Syntax

```
platform trident forwarding-table partition SIZE
no platform trident forwarding-table partition
default platform trident forwarding-table partition
```

Parameters

- **SIZE** Size of partition. Options include:
 - **0** 288k I2 entries, 16k host entries, 16k lpm entries
 - **1** 224k I2 entries, 80k host entries, 16k lpm entries
 - **2** 160k I2 entries, 144k host entries, 16k lpm entries
 - **3** 96k I2 entries, 208k host entries, 16k lpm entries

The default value is **2** (160k I2 entries, 144k host entries, 16k lpm entries).

Examples:

- This command sets the single shareable forwarding table to option 2 that supports 160k L2 entries, 144k host entries, and 16k LPM entries.

```
switch(config)#platform trident forwarding-table partition 2
switch(config)
```

- This command sets the single shareable forwarding table to option 3 that supports 96k L2 entries, 208k host entries, and 16k LPM entries. Since the switch was previously configured to option 2, you'll see a warning notice before the changes are implemented.

```
#switch(config)#platform trident forwarding-table partition 3
Warning: StrataAgent will restart immediately
```

12.1.14.45 platform trident routing-table partition

The **platform trident routing-table partition** command manages the partition sizes for the hardware LPM table that stores IPv6 routes of varying sizes.

An IPv6 route of length /64 (or shorter) requires half the hardware resources of an IPv6 route that is longer than /64. The switch installs routes of varying lengths in different table partitions. This command specifies the size of these partitions to optimize table usage.



Note: Changing the routing table partition mode causes the forwarding agent to restart, briefly disrupting traffic forwarding on all ports.

The **no platform trident routing-table partition** and **default platform trident routing-table partition** commands restore the default partitions sizes by removing the **platform trident routing-table partition** command from *running-config*.

Command Mode

Global Configuration

Command Syntax

```
platform trident routing-table partition SIZE
no platform trident routing-table partition
default platform trident routing-table partition
```

Parameters

- **SIZE** Size of partition. Options include:
 - **1** 16k IPv4 entries, 6k IPv6 (/64 and smaller) entries, 1k IPv6 (any prefix length)
 - **2** 16k IPv4 entries, 4k IPv6 (/64 and smaller) entries, 2k IPv6 (any prefix length)
 - **3** 16k IPv4 entries, 2k IPv6 (/64 and smaller) entries, 3k IPv6 (any prefix length)

The default value is **2** (16k IPv4 entries, 4k IPv6 (/64 and smaller) entries, 2k IPv6 (any prefix length)).

Restrictions

Partition allocation cannot be changed from the default setting when uRPF is enabled for IPv6 traffic.

Example:

This command sets the shareable routing table to option **1** that supports 6K prefixes equal to or shorter than /64 and 1K prefixes longer than /64.

```
switch(config)#platform trident routing-table partition 1
switch(config)
```

12.1.14.46 rib fib policy

The **rib fib policy** command enables FIB policy for a particular VRF under router general configuration mode. The FIB policy can be configured to advertise only specific RIB routes and exclude all other routes.

For example, a FIB policy can be configured that will not place routes associated with a specific origin in the routing table. These routes will not be used to forward data packets and these routes are not advertised by the routing protocol to neighbors.

The **no rib fib policy** and **default rib fib policy** commands restore the switch to its default state by removing the corresponding rib fib policy command from **running-config**.

Command Mode

Router General Configuration

Command Syntax

```
rib [ipv4 | ipv6] fib policy name
no rib [ipv4 | ipv6] fib policy name
default rib [ipv4 | ipv6] fib policy name
```

Parameters

- **ipv4** IPv4 configuration commands.
- **ipv6** IPv6 configuration commands.
- **name** Route map name.

Example:

The following example enables FIB policy for IPv4 in the default VRF, using the route map, *map1*.

```
Switch(config)#router general
Switch(config-router-general)#vrf default
Switch(config-router-general-vrf-default)#rib ipv4 fib policy
map1
```

12.1.14.47 show arp

The **show arp** command displays all ARP tables. This command differs from the **show ip arp** command in that it shows MAC bindings for all protocols, whereas **show ip arp** only displays MAC address – IP address bindings. Addresses are displayed as their host name by including the **resolve** argument.

Command Mode

EXEC

```
show arp [VRF_INST][FORMAT][HOST_ADD][HOST_NAME][INTF][MAC_ADDR][DATA]
```

Parameters

The **VRF_INST** and **FORMAT** parameters are always listed first and second. The **DATA** parameter is always listed last. All other parameters can be placed in any order.

- **VRF_INST** Specifies the VRF instance for which data is displayed.
 - *<no parameter>* Context-active VRF.
 - **vrf vrf_name** Specifies name of VRF instance. System default VRF is specified by **default**.
- **FORMAT** Displays format of host address. Options include:
 - *<no parameter>* Entries associate hardware address with an IPv4 address.
 - **resolve** Enter associate hardware address with a host name (if it exists).
- **HOST_ADD** IPv4 address by which routing table entries are filtered. Options include:
 - *<no parameter>* Routing table entries are not filtered by host address.
 - **ipv4_addr** Table entries matching specified IPv4 address.
- **HOST_NAME** Host name by which routing table entries are filtered. Options include:
 - *<no parameter>* Routing table entries are not filtered by host name.
 - **host hostname** Entries matching **hostname** (text).
- **INTF** Interfaces for which command displays status.
 - *<no parameter>* Routing table entries are not filtered by interface.
 - **interface ethernet e_num** Routed Ethernet interface specified by **e_num**.
 - **interface loopback l_num** Routed loopback interface specified by **l_num**.
 - **interface management m_num** Routed management interface specified by **m_num**.
 - **interface port-channel p_num** Routed port channel Interface specified by **p_num**.
 - **interface vlan v_num** VLAN interface specified by **v_num**.
 - **interface vxlan vx_num** VXLAN interface specified by **vx_num**.
- **MAC_ADDR** MAC address by which routing table entries are filtered. Options include:
 - *<no parameter>* Routing table entries are not filtered by interface MAC address.
 - **mac_address mac_address** Entries matching **mac_address** (dotted hex notation – H.H.H).
- **DATA** Detail of information provided by command. Options include:
 - *<no parameter>* Routing table entries.
 - **summary** Summary of ARP table entries.
 - **summary total** Number of ARP table entries.

Related Commands

- **cli vrf** specifies the context-active VRF.

Example:

This command displays the ARP table.

```
switch>show arp
Address          Age (min)  Hardware Addr  Interface
172.22.30.1      0          001c.730b.1d15  Management1
172.22.30.133    0          001c.7304.3906  Management1
switch>
```

12.1.14.48 show dhcp server

Use the **show dhcp server** command to display DHCP server information.

Command Mode

EXEC

Command Syntax

```
show dhcp server [ ipv4 | ipv6 [ leases [ A.B.C.D/E | NAME ]]] | [ leases [ ipv4 | ipv6 | NAME ]]
```

Parameters

- **ipv4** Displays details related to IPv4.
- **ipv6** Displays details related to IPv6.
- **leases** Displays active leases.
 - **A.B.C.D/E** IPv4 subnet.
 - **NAME** Subnet name.

Example

- DHCPv4 display example.

```
switch#show dhcp server ipv4
IPv4 DHCP Server is active
Debug log is enabled
DNS server(s): 10.2.2.2
DNS domain name: domainFoo
Lease duration: 1 days 0 hours 0 minutes
TFTP server:
serverFoo (Option 66)
10.0.0.3 (Option 150)
TFTP file: fileFoo
Active Leases: 1
IPv4 DHCP interface status:
  Interface      Status
-----
Ethernet1      Inactive (Could not determine VRF)
Ethernet2      Inactive (Not in default VRF)
Ethernet3      Inactive (Kernel interface not created yet)
Ethernet4      Inactive (Not up)
Ethernet5      Inactive (No IP address)
Ethernet6      Active

Vendor information:
Vendor ID: default
  Sub-options      Data
-----
      1              192.0.2.0, 192.0.2.1

Vendor ID: vendorFoo
  Sub-options      Data
-----
      2              192.0.2.2
      3              "Foo"

Subnet: 10.0.0.0/8
Subnet name: subnetFoo
Range: 10.0.0.1 to 10.0.0.10
DNS server(s): 10.1.1.1 10.2.2.2
Lease duration: 3 days 3 hours 3 minutes
Default gateway address: 10.0.0.3
TFTP server:
```



```
subnetServerFoo (Option 66)
10.0.0.4 (Option 150)
TFTP boot file: subnetFileFoo
Active leases: 1
Reservations:
MAC address: 1a1b.1c1d.1e1f
IPv4 address: 10.0.0.1

MAC address: 2a2b.2c2d.2e2f
IPv4 address: 10.0.0.2
```

- In this example, DHCPv6 is configured with subnet **fe80::/10** while being enabled on **Ethernet1** with address **fe80::1/64** and on **Ethernet3** with address **fe80::2/64**.

```
switch#show dhcp server ipv6
IPv6 DHCP server is active
Debug log is enabled

DNS server(s): fe80::6

DNS domain name: testaristanetworks.com

Lease duration: 1 days 3 hours 30 minutes

Active leases: 0

IPv6 DHCP interface status:

  Interface      Status
  -----
  Ethernet1      Active
  Ethernet3      Active

Subnet: fe80::/10
```

```
Subnet name: foo
```

```
Range: fe80::1 to fe80::3  
DNS server(s): fe80::4 fe80::5
```

```
Direct: Inactive (Multiple interfaces match this subnet: Ethernet1  
Ethernet3)  
Relay: Active
```

```
Active leases: 0
```

- This example illustrates when multiple subnets match an interface. In this example, DHCPv6 is configured with subnets **fc00::/7** and **fe80::/10** while being enabled on **Ethernet1** with address **fe80::1/10** and **fc00::1/7**.

```
switch#show dhcp server ipv6  
IPv6 DHCP server is active
```

```
DNS server(s): fc00::2
```

```
DNS domain name: testaristanetworks.com
```

```
Lease duration: 1 days 3 hours 30 minutes
```

```
Active leases: 0
```

```
IPv6 DHCP interface status:
```

Interface	Status
-----------	--------

```
Ethernet1    Active

Subnet: fc00::/7

Subnet name: foo

Range: fc00::1 to fc00::5

DNS server(s): fc00::6 fc00::8

Direct: Inactive (This and other subnets match interface Ethernet1)
Relay: Active

Active leases: 0

Subnet: fe80::/10

Subnet name: bar

Direct: Inactive (This and other subnets match interface Ethernet1)
Relay: Active

Active leases: 0
```

- When a subnet is disabled, the **show dhcp server** command displays the disable message with a reason. The number of active leases of the disabled subnets will be 0. In this example, there are overlapping subnets.

```
switch#show dhcp server
IPv4 DHCP Server is active
```

```

DNS server(s): 10.2.2.2
Lease duration: 1 days 0 hours 0 minutes
Active Leases: 0
IPv4 DHCP interface status:
  Interface    Status
-----
  Ethernet1    Active

Subnet: 10.0.0.0/24 (Subnet is disabled - overlapping subnet
 10.0.0.0/8)
Range: 10.0.0.1 to 10.0.0.10
DNS server(s): 10.3.3.3 10.4.4.4
Default gateway address: 10.0.0.4
Active leases: 0

Subnet: 10.0.0.0/8 (Subnet is disabled - overlapping subnet
 10.0.0.0/24)
DNS server(s):
Default gateway address: 10.0.0.3
Active leases: 0

```

- In this example, the display output shows overlapping ranges.

```

switch#show dhcp server
IPv4 DHCP Server is active
DNS server(s): 10.2.2.2
Lease duration: 1 days 0 hours 0 minutes
Active Leases: 0
IPv4 DHCP interface status:
  Interface    Status
-----
  Ethernet1    Active

Subnet: 10.0.0.0/8 (Subnet is disabled - range 10.0.0.9-10.0.0.12
 overlaps with an existing pool)
Range: 10.0.0.1 to 10.0.0.10
Range: 10.0.0.9 to 10.0.0.12
DNS server(s): 10.3.3.3 10.4.4.4
Default gateway address: 10.0.0.4
Active leases: 0

```

- This example shows duplicate static IP address reservation.

```

Subnet: 10.0.0.0/8 (Subnet is disabled - ipv4-address 10.0.0.11 is
 reserved more than once)
Subnet name:
DNS server(s):
Default gateway address: 10.0.0.3
Active leases: 0
Reservations:
MAC address: 1a1b.1c1d.1e1f
IPv4 address: 10.0.0.11

MAC address: 2a2b.2c2d.2e2f
IPv4 address: 10.0.0.11

```

- Use the **show dhcp server leases** command to display detailed information about the IP addresses allocated by the DHCP Server (including the IP address, the expected end time for that address, the time when the address is handed out, and the equivalent MAC address).

```

switch#show dhcp server leases
10.0.0.10
End: 2019/06/20 17:44:34 UTC

```

Last transaction: 2019/06/19 17:44:34 UTC

MAC address: 5692.4c67.460a

2000:0:0:40::b

End: 2019/06/20 18:06:33 UTC

Last transaction: 2019/06/20 14:36:33 UTC

MAC address: 165a.a86d.ffac

12.1.14.49 show interface tunnel

The **show interface tunnel** command displays the interface tunnel information.

Command Mode

EXEC

Command Syntax

```
show interface tunnel <number>
```

Parameter

- **number** Specifies the tunnel interface number.

Example:

This command displays tunnel interface configuration information for tunnel interface *10*.

```
switch#show interface tunnel 10

Tunnel10 is up, line protocol is up (connected)
Hardware is Tunnel, address is 0a01.0101.0800
Internet address is 192.168.1.1/24
Broadcast address is 255.255.255.255
Tunnel source 10.1.1.1, destination 10.1.1.2
Tunnel protocol/transport GRE/IP
  Key disabled, sequencing disabled
  Checksumming of packets disabled
Tunnel TTL 10, Hardware forwarding enabled
Tunnel TOS 10
Path MTU Discovery
Tunnel transport MTU 1476 bytes
Up 3 seconds
```

12.1.14.50 show ip arp inspection statistics

The **show ip arp inspection statistics** command displays the statistics of inspected ARP packets. For a VLAN specified, only VLANs with ARP inspection enabled will be displayed. If no VLAN is specified, all VLANs with ARP inspection enabled are displayed.

Command Mode

EXEC

Command Syntax

```
show ip arp inspection statistics [vlan [VID]][[INTERFACE] interface < intf_slot/intf_port>]
```

Parameters

- **VID** Specifies the VLAN interface ID.
- **INTERFACE** Specifies the interface (e.g., Ethernet).
 - <intf_slot> Interface slot.
 - <intf_port> Interface port.
- **INTF** Specifies the VLAN interface slot and port.

Related Commands

- [ip arp inspection limit](#)
- [ip arp inspection trust](#)
- [ip arp inspection vlan](#)

Examples:

- This command displays statistics of inspected ARP packets for VLAN 10.

```
switch(config)#show ip arp inspection statistics vlan 10

Vlan : 10
-----
ARP
Req Forwarded = 20
ARP Res Forwarded = 20
ARP Req Dropped = 1
ARP Res Dropped = 1
Last invalid ARP:
Time: 10:20:30 ( 5 minutes ago )
Reason: Bad IP/Mac match
Received on: Ethernet 3/1
Packet:
  Source MAC: 00:01:00:01:00:01
  Dest MAC: 00:02:00:02:00:02
  ARP Type: Request
  ARP Sender MAC: 00:01:00:01:00:01
  ARP Sender IP: 1.1.1

switch(config)#
```

- This command displays ARP inspection statistics for Ethernet interface 3/1.

```
switch(config)#show ip arp inspection statistics ethernet
interface 3/1
-----
ARP Req Forwarded = 10
ARP Res Forwarded = 10
ARP Req Dropped = 1
```

```
ARP Res Dropped = 1
```

```
Last invalid ARP:
```

```
Time: 10:20:30 ( 5 minutes ago )
```

```
Reason: Bad IP/Mac match
```

```
Received on: VLAN 10
```

```
Packet:
```

```
Source MAC: 00:01:00:01:00:01
```

```
Dest MAC: 00:02:00:02:00:02
```

```
ARP Type: Request
```

```
ARP Sender MAC: 00:01:00:01:00:01
```

```
ARP Sender IP: 1.1.1
```

```
switch(config)#
```

12.1.14.51 show ip arp inspection vlan

The **show ip arp inspection vlan** command displays the configuration and operation state of ARP inspection. For a VLAN range specified, only VLANs with ARP inspection enabled will be displayed. If no VLAN is specified, all VLANs with ARP inspection enabled are displayed. The operation state turns to **Active** when hardware is ready to trap ARP packets for inspection.

Command Mode

EXEC

Command Syntax

```
show ip arp inspection vlan [LIST]
```

Parameters

- **LIST** Specifies the VLAN interface number.

Related Commands

- [ip arp inspection limit](#)
- [ip arp inspection trust](#)
- [show ip arp inspection statistics](#)

Example:

This command displays the configuration and operation state of ARP inspection for VLANs 1 through 150.

```
switch(config)#show ip arp inspection vlan 1 - 150

VLAN 1
-----
Configuration
: Enabled
Operation State : Active
VLAN 2
-----
Configuration
: Enabled
Operation State : Active
{...}
VLAN 150
-----
Configuration
: Enabled
Operation State : Active

switch(config)#
```

12.1.14.52 show ip arp

The `show ip arp` command displays ARP cache entries that map an IPv4 address to a corresponding MAC address. The table displays addresses by their host names when the command includes the **resolve** argument.

Command Mode

EXEC

Command Syntax

```
show ip arp [VRF_INST][FORMAT][HOST_ADDR][HOST_NAME][INTF][MAC_ADDR][DATA]
```

Parameters

The **VRF_INST** and **FORMAT** parameters are always listed first and second. The **DATA** parameter is always listed last. All other parameters can be placed in any order.

- **VRF_INST** Specifies the VRF instance for which data is displayed.
 - **<no parameter>** Context-active VRF.
 - **vrf vrf_name** Specifies name of VRF instance. System default VRF is specified by **default**.
- **FORMAT** Displays format of host address. Options include:
 - **<no parameter>** Entries associate hardware address with an IPv4 address.
 - **resolve** Enter associate hardware address with a host name (if it exists).
- **HOST_ADDR** IPv4 address by which routing table entries are filtered. Options include:
 - **<no parameter>** Routing table entries are not filtered by host address.
 - **ipv4_addr** Table entries matching specified IPv4 address.
- **HOST_NAME** Host name by which routing table entries are filtered. Options include:
 - **<no parameter>** Routing table entries are not filtered by host name.
 - **host hostname** Entries matching **hostname** (text).
- **INTERFACE_NAME** Interfaces for which command displays status.
 - **<no parameter>** Routing table entries are not filtered by interface.
 - **interface ethernet e_num** Routed Ethernet interface specified by **e_num**.
 - **interface loopback l_num** Routed loopback interface specified by **l_num**.
 - **interface management m_num** Routed management interface specified by **m_num**.
 - **interface port-channel p_num** Routed port channel Interface specified by **p_num**.
 - **interface vlan v_num** VLAN interface specified by **v_num**.
 - **interface vxlan vx_num** VXLAN interface specified by **vx_num**.
- **MAC_ADDR** MAC address by which routing table entries are filtered. Options include:
 - **<no parameter>** Routing table entries are not filtered by interface MAC address.
 - **mac_address mac_address** entries matching **mac_address** (dotted hex notation – H.H.H).
- **DATA** Detail of information provided by command. Options include:
 - **<no parameter>** Routing table entries.
 - **summary** Summary of ARP table entries.
 - **summary total** Number of ARP table entries.

Related Commands

- **cli vrf** specifies the context-active VRF.

Examples:

- This command displays ARP cache entries that map MAC addresses to IPv4 addresses.

```
switch>show ip arp

Address          Age (min)  Hardware Addr  Interface
172.25.0.2      0          004c.6211.021e  Vlan101, Port-
Channel2
172.22.0.1      0          004c.6214.3699  Vlan1000, Port-
Channel1
172.22.0.2      0          004c.6219.a0f3  Vlan1000, Port-
Channel1
172.22.0.3      0          0045.4942.a32c  Vlan1000,
Ethernet33
172.22.0.5      0          f012.3118.c09d  Vlan1000, Port-
Channel1
172.22.0.6      0          00e1.d11a.a1eb  Vlan1000, Ethernet5
172.22.0.7      0          004f.e320.cd23  Vlan1000, Ethernet6
172.22.0.8      0          0032.48da.f9d9  Vlan1000,
Ethernet37
172.22.0.9      0          0018.910a.1fc5  Vlan1000,
Ethernet29
172.22.0.11     0          0056.cbe9.8510  Vlan1000,
Ethernet26
switch>
```

- This command displays ARP cache entries that map MAC addresses to IPv4 addresses. Host names assigned to IP addresses are displayed in place of the address.

```
switch>show ip arp resolve

Address          Age (min)  Hardware Addr  Interface
green-vl101.new  0          004c.6211.021e  Vlan101, Port-
Channel2
172.22.0.1      0          004c.6214.3699  Vlan1000, Port-
Channel1
orange-vl1000.n  0          004c.6219.a0f3  Vlan1000, Port-
Channel1
172.22.0.3      0          0045.4942.a32c  Vlan1000,
Ethernet33
purple.newcompa  0          f012.3118.c09d  Vlan1000, Port-
Channel1
pink.newcompany  0          00e1.d11a.a1eb  Vlan1000, Ethernet5
yellow.newcompa  0          004f.e320.cd23  Vlan1000, Ethernet6
172.22.0.8      0          0032.48da.f9d9  Vlan1000,
Ethernet37
royalblue.newco  0          0018.910a.1fc5  Vlan1000,
Ethernet29
172.22.0.11     0          0056.cbe9.8510  Vlan1000,
Ethernet26
switch>
```

12.1.14.53 show ip dhcp relay counters

The **show ip dhcp relay counters** command displays the number of DHCP packets received, forwarded, or dropped on the switch and on all interfaces enabled as DHCP relay agents.

Command Mode

EXEC

Command Syntax

```
show ip dhcp relay counters
```

Example:

This command displays the IP DHCP relay counter table.

```
switch>show ip dhcp relay counters
```

Interface	Dhcp Packets			Last Cleared
	Rcvd	Fwdd	Drop	
All Req	376	376	0	4 days, 19:55:12 ago
All Resp	277	277	0	
Vlan1000	0	0	0	4 days, 19:54:24 ago
Vlan1036	376	277	0	4 days, 19:54:24 ago

```
switch>
```

12.1.14.54 show ip dhcp relay

The **show ip dhcp relay** command displays the DHCP relay agent configuration status on the switch.

Command Mode

EXEC

Command Syntax

```
show ip dhcp relay
```

Example:

This command displays the DHCP relay agent configuration status.

```
switch>show ip dhcp relay  
DHCP Relay is active  
DHCP Relay Option 82 is disabled  
DHCP Smart Relay is enabled  
Interface: Vlan100  
    DHCP Smart Relay is disabled  
    DHCP servers: 10.4.4.4  
switch>
```

12.1.14.55 show ip dhcp snooping counters

The **show ip dhcp snooping counters** command displays counters that track the quantity of DHCP request and reply packets that the switch receives. Data is either presented for each VLAN or aggregated for all VLANs with counters for packets dropped.

Command Mode

EXEC

Command Syntax

```
show ip dhcp snooping counters [COUNTER_TYPE]
```

Parameters

- **COUNTER_TYPE** The type of counter that the command resets. Formats include:
 - **<no parameter>** Command displays counters for each VLAN.
 - **debug** Command displays aggregate counters and drop cause counters.

Examples:

- This command displays the number of DHCP packets sent and received on each VLAN.

```
switch>show ip dhcp snooping counters

Vlan | Dhcp Request Pkts | Dhcp Reply Pkts |
-----|-----|-----|
      | Rcvd  Fwdd  Drop | Rcvd  Fwdd  Drop | Last Cleared
-----|-----|-----|-----
 100 |    0    0    0 |    0    0    0 | 0:35:39 ago

switch>
```

- This command displays the number of DHCP packets sent on the switch.

```
switch>show ip dhcp snooping counters debug
Counter                               Snooping to Relay Relay to
Snooping
-----
----
Received                               0
  0
Forwarded                               0
  0
Dropped - Invalid VlanId                0
  0
Dropped - Parse error                   0
  0
Dropped - Invalid Dhcp Optype           0
  0
Dropped - Invalid Info Option           0
  0
Dropped - Snooping disabled              0
  0

Last Cleared:  3:37:18 ago
switch>
```

12.1.14.56 show ip dhcp snooping hardware

The **show ip dhcp snooping hardware** command displays internal hardware DHCP snooping status on the switch.

Command Mode

EXEC

Command Syntax

```
show ip dhcp snooping hardware
```

Example:

This command DHCP snooping hardware status.

```
switch>show ip dhcp snooping hardware
DHCP Snooping is enabled
DHCP Snooping is enabled on following VLANs:
  None
  Vlans enabled per Slice
    Slice: FixedSystem
    None
switch>
```

12.1.14.57 show ip dhcp snooping

The **show ip dhcp snooping** command displays the DHCP snooping configuration.

Command Mode

EXEC

Command Syntax

```
show ip dhcp snooping
```

Related Commands

- [ip dhcp snooping](#) globally enables DHCP snooping.
- [ip dhcp snooping vlan](#) enables DHCP snooping on specified VLANs.
- [ip dhcp relay information option \(Global\)](#) enables insertion of option-82 snooping data.
- [ip helper-address](#) enables the DHCP relay agent on a configuration mode interface.

Example:

This command displays the switch's DHCP snooping configuration.

```
switch>show ip dhcp snooping
DHCP Snooping is enabled
DHCP Snooping is operational
DHCP Snooping is configured on following VLANs:
 100
DHCP Snooping is operational on following VLANs:
 100
Insertion of Option-82 is enabled
  Circuit-id format: Interface name:Vlan ID
  Remote-id: 00:1c:73:1f:b4:38 (Switch MAC)
switch>
```

12.1.14.58 show ip interface brief

Use the **show ip interface brief** command output to display the status summary of the specified interfaces that are configured as routed ports. The command provides the following information for each specified interface:

- IP address
- Operational status
- Line protocol status
- MTU size

Command Mode

EXEC

Command Syntax

```
show ip interface [INTERFACE_NAME][VRF_INST] brief
```

Parameters

- **INTERFACE_NAME** Interfaces for which command displays status.
 - **<no parameter>** All routed interfaces.
 - **ipv4_addr** Neighbor IPv4 address.
 - **ethernet e_range** Routed Ethernet interfaces specified by **e_range**.
 - **loopback l_range** Routed loopback interfaces specified by **l_range**.
 - **management m_range** Routed management interfaces specified by **m_range**.
 - **port-channel p_range** Routed port channel Interfaces specified by **p_range**.
 - **vlan v_range** VLAN interfaces specified by **v_range**.
 - **vxlan vx_range** VXLAN interface range specified by **vx_range**.
- **VRF_INST** Specifies the VRF instance for which data is displayed.
 - **<no parameter>** Context-active VRF.
 - **vrf vrf_name** Specifies name of VRF instance. System default VRF is specified by **default**.

Example:

This command displays the summary status of VLAN interfaces 900-910.

```
switch>show ip interface vlan 900-910 brief

! Some interfaces do not exist
Interface          IP Address      Status    Protocol
  MTU
Vlan901            170.33.254.1/30 up        up
  9212
Vlan902            170.33.254.14/29 up        up
  9212
Vlan905            170.33.254.17/29 up        up
  1500
Vlan907            170.33.254.67/29 up        up
  9212
Vlan910            170.33.254.30/30 up        up
  9212
```

12.1.14.59 show ip interface

The **show ip interface** command displays the status of specified interfaces that are configured as routed ports. The command provides the following information:

- Interface description
- Internet address
- Broadcast address
- Address configuration method
- Proxy-ARP status
- MTU size

Command Mode

EXEC

Command Syntax

```
show ip interface [INTERFACE_NAME][VRF_INST]
```

Parameters

- **INTERFACE_NAME** Interfaces for which command displays status.
 - **<no parameter>** All routed interfaces.
 - **ipv4_addr** Neighbor IPv4 address.
 - **ethernet e_range** Routed Ethernet interfaces specified by **e_range**.
 - **loopback l_range** Routed loopback interfaces specified by **l_range**.
 - **management m_range** Routed management interfaces specified by **m_range**.
 - **port-channel p_range** Routed port channel Interfaces specified by **p_range**.
 - **vlan v_range** VLAN interfaces specified by **v_range**.
 - **vxlan vx_range** VXLAN interfaces specified by **vx_range**.
- **VRF_INST** Specifies the VRF instance for which data is displayed.
 - **<no parameter>** Context-active VRF.
 - **vrf vrf_name** Specifies name of VRF instance. System default VRF is specified by **default**.

Example:

- This command displays IP status of configured VLAN interfaces numbered between 900 and 910.

```
switch>show ip interface vlan 900-910
! Some interfaces do not exist
Vlan901 is up, line protocol is up (connected)
  Description: ar.pqt.mlag.peer
  Internet address is 170.23.254.1/30
  Broadcast address is 255.255.255.255
  Address determined by manual configuration
  Proxy-ARP is disabled
  MTU 9212 bytes
Vlan903 is up, line protocol is up (connected)
  Description: ar.pqt.rn.170.23.254.16/29
  Internet address is 170.23.254.19/29
  Broadcast address is 255.255.255.255
  Address determined by manual configuration
  Proxy-ARP is disabled
  MTU 9212 bytes
```

- This command displays the configured TCP maximum segment size (MSS) ceiling value of 1436 bytes for an Ethernet interface 25.

```
switch>show ip interface ethernet 25
Ethernet25 is up, line protocol is up (connected)
  Internet address is 10.1.1.1/24
  Broadcast address is 255.255.255.255
  IPv6 Interface Forwarding : None
  Proxy-ARP is disabled
  Local Proxy-ARP is disabled
  Gratuitous ARP is ignored
  IP MTU 1500 bytes
  IPv4 TCP MSS egress ceiling is 1436 bytes
```

12.1.14.60 show ip route age

The **show ip route age** command displays the time when the route for the specified network was present in the routing table. It does not account for the changes in parameters like metric, next-hop etc.

Command Mode

EXEC

Command Syntax

```
show ip route ADDRESS age
```

Parameters

- **ADDRESS** Filters routes by IPv4 address or subnet.
 - **ipv4_addr** Routing table entries matching specified address.
 - **ipv4_subnet** Routing table entries matching specified subnet (CIDR or address-mask).

Example:

This command shows the amount of time since the last update to ip route *172.17.0.0/20*.

```
switch>show ip route 172.17.0.0/20 age
Codes: C - connected, S - static, K - kernel,
       O - OSPF, IA - OSPF inter area, E1 - OSPF external type 1,
       E2 - OSPF external type 2, N1 - OSPF NSSA external type 1,
       N2 - OSPF NSSA external type2, B I - iBGP, B E - eBGP,
       R - RIP, I - ISIS, A - Aggregate

B E    172.17.0.0/20 via 172.25.0.1, age 3d01h
switch>
```

12.1.14.61 show ip route gateway

The **show ip route gateway** command displays IP addresses of all gateways (next hops) used by active routes.

Command Mode

EXEC

Command Syntax

```
show ip route [VRF_INSTANCE] gateway
```

Parameters

- **VRF_INSTANCE** Specifies the VRF instance for which data is displayed.
 - **<no parameter>** Context-active VRF.
 - **vrf vrf_name** Specifies name of VRF instance. System default VRF is specified by **default**.

Related Commands

- [cli vrf](#) specifies the context-active VRF.

Example:

This command displays next hops used by active routes.

```
switch>show ip route gateway
The following gateways are in use:
 172.25.0.1 Vlan101
 172.17.253.2 Vlan3000
 172.17.254.2 Vlan3901
 172.17.254.11 Vlan3902
 172.17.254.13 Vlan3902
 172.17.254.17 Vlan3903
 172.17.254.20 Vlan3903
 172.17.254.66 Vlan3908
 172.17.254.67 Vlan3908
 172.17.254.68 Vlan3908
 172.17.254.29 Vlan3910
 172.17.254.33 Vlan3911
 172.17.254.35 Vlan3911
 172.17.254.105 Vlan3912
 172.17.254.86 Vlan3984
 172.17.254.98 Vlan3992
 172.17.254.99 Vlan3992
switch>
```

12.1.14.62 show ip route host

The **show ip route host** command displays all host routes in the host forwarding table. Host routes are those whose destination prefix is the entire address (mask = 255.255.255.255 or prefix = /32). Each entry includes a code of the route's purpose:

- **F** static routes from the FIB.
- **R** routes defined because the IP address is an interface address.
- **B** broadcast address.
- **A** routes to any neighboring host for which the switch has an ARP entry.

Command Mode

EXEC

Command Syntax

```
show ip route [VRF_INSTANCE] host
```

Parameters

- **VRF_INSTANCE** Specifies the VRF instance for which data is displayed.
 - **<no parameter>** Context-active VRF.
 - **vrf vrf_name** Specifies name of VRF instance. System default VRF is specified by **default**.

Related Commands

- [cli vrf](#) specifies the context-active VRF.

Example:

This command displays all host routes in the host forwarding table.

```
switch>show ip route host
R - receive B - broadcast F - FIB, A - attached

F 127.0.0.1 to cpu
B 172.17.252.0 to cpu
A 172.17.253.2 on Vlan2000
R 172.17.253.3 to cpu
A 172.17.253.10 on Vlan2000
B 172.17.253.255 to cpu
B 172.17.254.0 to cpu
R 172.17.254.1 to cpu
B 172.17.254.3 to cpu
B 172.17.254.8 to cpu
A 172.17.254.11 on Vlan2902
R 172.17.254.12 to cpu

F 172.26.0.28 via 172.17.254.20 on Vlan3003
via 172.17.254.67 on Vlan3008
via 172.17.254.98 on Vlan3492
via 172.17.254.2 on Vlan3601
via 172.17.254.13 on Vlan3602
via 172.17.253.2 on Vlan3000
F 172.26.0.29 via 172.25.0.1 on Vlan101
F 172.26.0.30 via 172.17.254.29 on Vlan3910
F 172.26.0.32 via 172.17.254.105 on Vlan3912
switch>
```

12.1.14.63 show ip route match tag

The **show ip route match tag** command displays the route tag assigned to the specified IPv4 address or subnet. Route tags are added to static routes for use by route maps.

Command Mode

EXEC

Command Syntax

```
show ip route [VRF_INSTANCE] ADDRESS match tag
```

Parameters

- **VRF_INSTANCE** Specifies the VRF instance for which data is displayed.
 - **<no parameter>** Context-active VRF.
 - **vrf vrf_name** Specifies name of VRF instance. System default VRF is specified by **default**.
- **ADDRESS** Displays routes of specified IPv4 address or subnet.
 - **ipv4_addr** Routing table entries matching specified IPv4 address.
 - **ipv4_subnet** Routing table entries matching specified IPv4 subnet (CIDR or address-mask).

Example:

This command displays the route tag for the specified subnet.

```
switch>show ip route 172.17.50.0/23 match tag
Codes: C - connected, S - static, K - kernel,
       O - OSPF, IA - OSPF inter area, E1 - OSPF external type 1,
       E2 - OSPF external type 2, N1 - OSPF NSSA external type 1,
       N2 - OSPF NSSA external type2, B I - iBGP, B E - eBGP,
       R - RIP, I L1 - IS-IS level 1, I L2 - IS-IS level 2,
       O3 - OSPFv3, A B - BGP Aggregate, A O - OSPF Summary,
       NG - Nexthop Group Static Route, V - VXLAN Control
Service,
       DH - DHCP client installed default route, M - Martian

O E2   172.17.50.0/23 tag 0

switch>
```

12.1.14.64 show ip route summary

The **show ip route summary** command displays the number of routes, categorized by destination prefix, in the routing table.

Command Mode

EXEC

Command Syntax

`show ip route [VRF_INSTANCE] summary` **Parameters**

- **VRF_INSTANCE** Specifies the VRF instance for which data is displayed.
 - *<no parameter>* Context-active VRF.
 - **vrf vrf_name** Specifies name of VRF instance. System default VRF is specified by **default**.

Example:

This command displays a summary of the routing table contents.

```
switch>show ip route summary
Route Source          Number Of Routes
-----
connected              15
static                 0
ospf                   74
  Intra-area: 32 Inter-area:33 External-1:0 External-2:9
  NSSA External-1:0 NSSA External-2:0
bgp                     7
  External: 6 Internal: 1
internal               45
attached               18
aggregate              0
switch>
```

12.1.14.65 show ip route

The **show ip route** command displays routing table entries that are in the Forwarding Information Base (FIB), including static routes, routes to directly connected networks, and dynamically learned routes. Multiple equal-cost paths to the same prefix are displayed contiguously as a block, with the destination prefix displayed only on the first line.

The **show running-config** command displays configured commands not in the FIB.

Command Mode

EXEC

Command Syntax

```
show ip route [VRF_INSTANCE][ADDRESS][ROUTE_TYPE][INFO_LEVEL][PREFIX]
```

Parameters

The **VRF_INSTANCE** and **ADDRESS** parameters are always listed first and second, respectively. All other parameters can be placed in any order.

- **VRF_INSTANCE** Specifies the VRF instance for which data is displayed.
 - *<no parameter>* Context-active VRF.
 - **vrf vrf_name** Specifies name of VRF instance. System default VRF is specified by **default**.
- **ADDRESS** Filters routes by IPv4 address or subnet.
 - *<no parameter>* All routing table entries.
 - **ipv4_addr** Routing table entries matching specified address.
 - **ipv4_subnet** Routing table entries matching specified subnet (CIDR or address-mask).
- **ROUTE_TYPE** Filters routes by specified protocol or origin. Options include:
 - *<no parameter>* All routing table entries.
 - **aggregate** Entries for BGP aggregate routes.
 - **bgp** Entries added through BGP protocol.
 - **connected** Entries for routes to networks directly connected to the switch.
 - **isis** Entries added through ISIS protocol.
 - **kernel** Entries appearing in Linux kernel but not added by EOS software.
 - **ospf** Entries added through OSPF protocol.
 - **rip** Entries added through RIP protocol.
 - **static** Entries added through CLI commands.
 - **vrf** Displays routes in a VRF.
- **INFO_LEVEL** Filters entries by next hop connection. Options include:
 - *<no parameter>* Filters routes whose next hops are directly connected.
 - **detail** Displays all routes.
- **PREFIX** Filters routes by prefix.
 - *<no parameter>* Specific route entry that matches the ADDRESS parameter.
 - **longer-prefixes** All subnet route entries in range specified by ADDRESS parameter.

Related Commands

- [cli vrf](#) specifies the context-active VRF.

Examples:

- This command displays IPv4 routes learned through BGP.

```
switch>show ip route bgp
Codes: C - connected, S - static, K - kernel,
```

```

O - OSPF, IA - OSPF inter area, E1 - OSPF external type
1,
E2 - OSPF external type 2, N1 - OSPF NSSA external type
1,
N2 - OSPF NSSA external type2, B I - iBGP, B E - eBGP,
R - RIP, A - Aggregate

B E    170.44.48.0/23 [20/0] via 170.44.254.78
B E    170.44.50.0/23 [20/0] via 170.44.254.78
B E    170.44.52.0/23 [20/0] via 170.44.254.78
B E    170.44.54.0/23 [20/0] via 170.44.254.78
B E    170.44.254.112/30 [20/0] via 170.44.254.78
B E    170.53.0.34/32 [1/0] via 170.44.254.78
B I    170.53.0.35/32 [1/0] via 170.44.254.2
                               via 170.44.254.13
                               via 170.44.254.20
                               via 170.44.254.67
                               via 170.44.254.35
                               via 170.44.254.98

```

- This command displays the unicast IP routes installed in the system.

```

switch#show ip route
VRF name: default
Codes: C - connected, S - static, K - kernel,
O - OSPF, IA - OSPF inter area, E1 - OSPF external type 1,
E2 - OSPF external type 2, N1 - OSPF NSSA external type 1,
N2 - OSPF NSSA external type2, B I - iBGP, B E - eBGP,
R - RIP, I - ISIS, A B - BGP Aggregate, A O - OSPF Summary,
NG - Nexthop Group Static Route

Gateway of last resort is not set
C 10.1.0.0/16 is directly connected, Vlan2659
C 10.2.0.0/16 is directly connected, Vlan2148
C 10.3.0.0/16 is directly connected, Vlan2700
S 172.17.0.0/16 [1/0] via 172.24.0.1, Management1
S 172.18.0.0/16 [1/0] via 172.24.0.1, Management1
S 172.19.0.0/16 [1/0] via 172.24.0.1, Management1
S 172.20.0.0/16 [1/0] via 172.24.0.1, Management1
S 172.22.0.0/16 [1/0] via 172.24.0.1, Management1
C 172.24.0.0/18 is directly connected, Management1

```

- This command displays the leaked routes from a source VRF.

```

switch#show ip route vrf VRF2 20.0.0.0/8
...
S L    20.0.0.0/8 [1/0] (source VRF VRF1) via 10.1.2.10,
Ethernet1

```

12.1.14.66 show ip verify source

The **show ip verify source** command displays the IP source guard (IPSG) configuration, operational states, and IP-MAC binding entries for the configuration mode interface.

Command Mode

EXEC

Command Syntax

```
show ip verify source [VLAN | DETAIL]
```

Parameters

- **VLAN** Displays all VLANs configured in **no ip verify source vlan**.
- **DETAIL** Displays all source IP-MAC binding entries configured for IPSG.

Related Commands

- [ip source binding](#)
- [ip verify source](#)

Examples:

- This command verifies the IPSG configuration and operational states.

```
switch(config)#show ip verify source
Interface          Operational State
-----
Ethernet1         IP source guard enabled
Ethernet2         IP source guard disabled
```

- This command displays all VLANs configured in **no ip verify source vlan**. Hardware programming errors, e.g., VLAN classification failed, are indicated in the operational state. If an error occurs, this VLAN will be considered as enabled for IPSG. Traffic on this VLAN will still be filtered by IPSG.

```
switch(config)#show ip verify source vlan
IPSG disabled on VLANs: 1-2
VLAN              Operational State
-----
1                 IP source guard disabled
2                 Error: vlan classification failed
```

- This command displays all source IP-MAC binding entries configured for IPSG. A source binding entry is considered active if it is programmed in hardware. IP traffic matching any active binding entry will be permitted. If a source binding entry is configured on an interface or a VLAN whose operational state is IPSG disabled, this entry will not be installed in the hardware, in which case an "IP source guard disabled" state will be shown. If a port channel has no member port configured, binding entries configured for this port channel will not be installed in hardware, and a "Port-Channel down" state will be shown.

```
switch(config)#show ip verify source detail
Interface          IP Address      MAC Address      VLAN   State
-----
Ethernet1         10.1.1.1       0000.aaaa.1111  5     active
Ethernet1         10.1.1.5       0000.aaaa.5555  1     IP
source guard disabled
```

Port-Channel1	20.1.1.1	0000.bbbb.1111	4	Port-
Channel down				

12.1.14.67 show ip

The **show ip** command displays IPv4 routing, IPv6 routing, IPv4 multicast routing, and VRRP status on the switch.

Command Mode

EXEC

Command Syntax

```
show ip
```

Example:

This command displays IPv4 routing status.

```
switch>show ip

IP Routing : Enabled
IP Multicast Routing : Disabled
VRRP: Configured on 0 interfaces

IPv6 Unicast Routing : Enabled
IPv6 ECMP Route support : False
IPv6 ECMP Route nexthop index: 5
IPv6 ECMP Route num prefix bits for nexthop index: 10

switch>
```

12.1.14.68 show platform arad ip route summary

The **show platform arad ip route summary** command shows hardware resource usage of IPv4 routes.

Command Mode

EXEC

Command Syntax

```
show platform arad ip route summary
```

Related Commands

- [agent SandL3Unicast terminate](#) enables restarting the layer 3 agent to ensure IPv4 routes are optimized.
- [ip hardware fib optimize](#) enables IPv4 route scale.
- [show platform arad ip route](#) shows resources for all IPv4 routes in hardware. Routes that use the additional hardware resources will appear with an asterisk.

Example:

This command shows hardware resource usage of IPv4 routes.

```
switch(config)#show platform arad ip route summary
Total number of VRFs: 1
Total number of routes: 25
Total number of route-paths: 21
Total number of lem-routes: 4

switch(config)#
```

12.1.14.69 show platform arad ip route

The **show platform arad ip route** command shows resources for all IPv4 routes in hardware. Routes that use the additional hardware resources will appear with an asterisk.

Command Mode

EXEC

Command Syntax

```
show platform arad ip route
```

Examples:

- This command displays the platform unicast forwarding routes. In this example, the ACL label field in the following table is *4094* by default for all routes. If an IPv4 egress RACL is applied to an SVI, all routes corresponding to that VLAN will have an ACL label value. In this case, the ACL Label field value is 2.

```
switch#show platform arad ip route
Tunnel Type: M(mpls), G(gre)

-----
|
|                               Routing Table
|
|-----
|VRF| Destination | | | | Acl |
|
|ECMP| FEC | Tunnel
| ID| Subnet | Cmd | Destination | VID | Label | MAC / CPU
Code |Index|Index|T Value
-----
--
|0 |0.0.0.0/8 |TRAP | CoppSystemL3DstMiss|0 | - | ArpTrap | - |
|1031 | -
|0 |10.1.0.0/16 |TRAP | CoppSystemL3DstMiss|2659 | - | ArpTrap | - |
|1030 | -
|0 |10.2.0.0/16 |TRAP | CoppSystemL3DstMiss|2148 | - | ArpTrap | - |
|1026 | -
|0 |172.24.0.0/18 |TRAP | CoppSystemL3DstMiss|0 | - | ArpTrap | - |
|1032 | -
|0 |0.0.0.0/0 |TRAP | CoppSystemL3LpmOver|0 | - | SlowReceive | -
|1024 | -
|0 |10.1.0.0/32* |TRAP | CoppSystemIpBcast |0 | - | BcastReceive |
|
|1027 | -
|0 |10.1.0.1/32* |TRAP | CoppSystemIpUcast |0 | - | Receive | - |
|32766| -
|0 |10.1.255.1/32* |ROUTE| Pol |2659 |4094 | 00:1f:5d:6b:c
e:45
| - |1035 | -
|0 |10.1.255.255/32* |TRAP | CoppSystemIpBcast |0 | - | BcastReceive |
|
|1027 | -
|0 |10.3.0.0/32* |TRAP | CoppSystemIpBcast |0 | - | BcastReceive |
|
|1027 | -
|0 |10.3.0.1/32* |TRAP | CoppSystemIpUcast |0 | - | Receive | - |
|32766| -
|0 |10.3.255.1/32* |ROUTE| Et18 |2700 |2 | 00:1f:5d:6b:0
0:01
| - |1038 | -
.....
```

- **Related Commands**

- [agent SandL3Unicast terminate](#) enables restarting the layer 3 agent to ensure IPv4 routes are optimized.
 - [ip hardware fib optimize](#) enables IPv4 route scale.
 - [show platform arad ip route summary](#) shows hardware resource usage of IPv4 routes.
- This command shows resources for all IPv4 routes in hardware. Routes that use the additional hardware resources will appear with an asterisk.

```
switch(config)#show platform arad ip route
Tunnel Type: M(mpls), G(gre)
* - Routes in LEM

-----
|
|                               Routing Table                               |
|
|-----
|
|VRF| Destination |      |      | Acl |      |
|ECMP|
| FEC | Tunnel
|ID | Subnet | Cmd | Destination |VID |Label| MAC / CPU Code
|Index|Index|T Value
|-----
|
|0 |0.0.0.0/8 |TRAP |CoppSystemL3DstMiss|0 | - |ArpTrap |
|
|1030 | -
|0 |100.1.0.0/32 |TRAP |CoppSystemIpBcast |0 | - |BcastReceive |
|
|1032 | -
|0 |100.1.0.0/32 |TRAP |CoppSystemIpUcast |0 | - |Receive |
|
|32766| -
|0 |100.1.255.255/32|TRAP |CoppSystemIpBcast |0 | - |BcastReceive |
|
|1032 | -
|0 |200.1.255.255/32|TRAP |CoppSystemIpBcast |0 | - |BcastReceive |
|
|1032 | -
|0 |200.1.0.0/16 |TRAP |CoppSystemL3DstMiss|1007| - |ArpTrap |
|
|1029 | -
|0 |0.0.0.0/0 |TRAP |CoppSystemL3LpmOver|0 | - |SlowReceive |
|
|1024 | -
|0 |4.4.4.0/24* |ROUTE|Et10 |1007| - |00:01:00:02:00:03|
|
|1033 | -
|0 |10.20.30.0/24* |ROUTE|Et9 |1006| - |00:01:00:02:00:03|
|
|1027 | -

switch(config)#
```

12.1.14.70 show platform fap eedb ip-tunnel gre interface tunnel

The `show platform fap eedb ip-tunnel gre interface tunnel` command verifies the tunnel encapsulation programming for the tunnel interface.

Command Mode

EXEC

Command Syntax

```
show platform fap eedb ip-tunnel gre interface tunnel <number>
```

Parameter

- *number* Specifies the tunnel interface number.

Example:

These commands verify the tunnel encapsulation programming for the tunnel interface 10.

```
switch#show platform fap eedb ip-tunnel gre interface tunnel 10
-----
|                                     Jericho0                               |
|                                     GRE Tunnel Egress Encapsulation DB      |
|-----|
| Bank/ | OutLIF | Next  | VSI  | Encap | TOS  | TTL  | Source | Destination|
| OamLIF| OutLIF | Drop|     |      |     |     |        |             |
| Offset|         | OutLIF| LSB  | Mode  |     |     | IP     | IP         | Set
| Profile|         |-----|
| 3/0   | 0x6000 | 0x4010 | 0    | 2     | 10   | 10   | 10.1.1.1 | 10.1.1.2 | No
| 0     | No    |-----|
switch#show platform fap eedb ip-tunnel
-----
|                                     Jericho0                               |
|                                     IP Tunnel Egress Encapsulation DB      |
|-----|
| Bank/ | OutLIF | Next  | VSI  | Encap| TOS  | TTL  | Src  | Destination | OamLIF|
| OutLIF | Drop|     |      |      |     |     |     |             |       |
| Offset|         | OutLIF| LSB  | Mode | Idx  | Idx  | Idx  | IP         |       | Set
| Profile |         |-----|
| 3/0   | 0x6000 | 0x4010 | 0    | 2    | 9    | 0    | 0    | 10.1.1.2   |       | No
| 0     | No    |-----|
```

12.1.14.71 show platform fap tcam summary

The **show platform fap tcam summary** command displays information about the TCAM bank that is allocated for GRE packet termination lookup.

Command Mode

EXEC

Command Syntax

```
show platform fap tcam summary
```

Example:

This command verifies if the TCAM bank is allocated for GRE packet termination lookup.

```
switch#show platform fap tcam summary

Tcam Allocation (Jericho0)
Bank          Used By          Reserved By
-----
0             dbGreTunnel          -
```

12.1.14.72 show platform trident forwarding-table partition

The **show platform trident forwarding-table partition** command displays the size of the L2 MAC entry tables, L3 IP forwarding tables, and Longest Prefix Match (LPM) routes.

Command Mode

Privileged EXEC

Command Syntax

```
show platform trident forwarding-table partition
```

Example:

This command shows the Trident forwarding table information.

```
switch(config)#show platform trident forwarding-table partition  
L2 Table Size: 96k  
L3 Host Table Size: 208k  
LPM Table Size: 16k  
switch(config)#
```

12.1.14.73 show rib route ip

The `show rib route ip` command displays a list of IPv4 Routing Information Base (RIB) routes.

Command Mode

EXEC

Command Syntax

```
show rib route ip [vrf vrf_name][PREFIX][ROUTE TYPE]
```

Parameters

- **vrf vrf_name** Displays RIB routes from the specified VRF.
- **PREFIX** dDisplays routes filtered by the specified IPv4 information. Options include:
 - **ip_address** Displays RIB routes filtered by the specified IPv4 address.
 - **ip_subnet_mask** Displays RIB routes filtered by the specified IPv4 address and subnet mask.
 - **ip_prefix** Displays RIB routes filtered by the specified IPv4 prefix.
- **ROUTE TYPE** Displays routes filtered by the specified route type. Options include:
 - **bgp** Displays RIB routes filtered by BGP.
 - **connected** Displays RIB routes filtered by connected routes.
 - **dynamicPolicy** Displays RIB routes filtered by dynamic policy routes.
 - **host** Displays RIB routes filtered by host routes.
 - **isis** Displays RIB routes filtered by ISIS routes.
 - **ospf** Displays RIB routes filtered by OSPF routes.
 - **ospf3** Displays RIB routes filtered by OSPF3 routes.
 - **reserved** Displays RIB routes filtered by reserved routes.
 - **route-input** Displays RIB routes filtered by route-input routes.
 - **static** Displays RIB routes filtered by static routes.
 - **vrf** Displays routes in a VRF.
 - **vrf-leak** Displays leaked routes in a VRF.

Examples:

- This command displays IPv4 RIB static routes.

```
switch#show rib route ip static
VRF name: default, VRF ID: 0xfe, Protocol: static
Codes: C - Connected, S - Static, P - Route Input
       B - BGP, O - Ospf, O3 - Ospf3, I - Isis
       > - Best Route, * - Unresolved Nexthop
       L - Part of a recursive route resolution loop
>S    10.80.0.0/12 [1/0]
      via 172.30.149.129 [0/1]
      via Management1, directly connected
>S    172.16.0.0/12 [1/0]
      via 172.30.149.129 [0/1]
      via Management1, directly connected
switch#
```

- This command displays IPv4 RIB connected routes.

```
switch#show rib route ip connected
VRF name: default, VRF ID: 0xfe, Protocol: connected
Codes: C - Connected, S - Static, P - Route Input
       B - BGP, O - Ospf, O3 - Ospf3, I - Isis
       > - Best Route, * - Unresolved Nexthop
```

```
L - Part of a recursive route resolution loop
>C 10.1.0.0/24 [0/1]
    via 10.1.0.102, Ethernet1
>C 10.2.0.0/24 [0/1]
    via 10.2.0.102, Ethernet2
>C 10.3.0.0/24 [0/1]
    via 10.3.0.102, Ethernet3
switch#
```

- This command displays routes leaked through VRF leak agent.

```
switch#show rib route ip vrf VRF2 vrf-leak
VRF: VRF2, Protocol: vrf-leak
...
>VL 20.0.0.0/8 [1/0] source VRF: VRF1
    via 10.1.2.10 [0/0] type ipv4
    via 10.1.2.10, Ethernet1
```

12.1.14.74 show rib route <ipv4 | ipv6> fib policy excluded

The **show rib route <ipv4 | ipv6> fib policy excluded** command displays the RIB routes filtered by FIB policy. The **fib policy exclude** option displays the RIB routes that have been excluded from being programmed into FIB, by FIB policy.

Command Mode

EXEC

Command Syntax

```
show rib route<ipv4 | ipv6> fib policy excluded
```

Example:

The following example displays the RIB routes excluded by the FIB policy using the **fib policy excluded** option of the **show rib route <ipv4 | ipv6>** command.

```
Switch#show rib route ipv6 fib policy excluded
switch#show rib route ip bgp fib policy excluded

VRF name: default, VRF ID: 0xfe, Protocol: bgp
Codes: C - Connected, S - Static, P - Route Input
       B - BGP, O - Ospf, O3 - Ospf3, I - Isis
       > - Best Route, * - Unresolved Nexthop
       L - Part of a recursive route resolution loop
>B 10.1.0.0/24 [200/0]
    via 10.2.2.1 [115/20] type tunnel
      via 10.3.5.1, Ethernet1
    via 10.2.0.1 [115/20] type tunnel
      via 10.3.4.1, Ethernet2
      via 10.3.6.1, Ethernet3
>B 10.1.0.0/24 [200/0]
    via 10.2.2.1 [115/20] type tunnel
      via 10.3.5.1, Ethernet1
    via 10.2.0.1 [115/20] type tunnel
      via 10.3.4.1, Ethernet2
      via 10.3.6.1, Ethernet3
```

12.1.14.75 show rib route summary

The **show rib route summary** command displays information about the routes present in the Routing Information Base.

Command Mode

EXEC

Command Syntax

```
show rib route summary [INFO_LEVEL]
```

Parameters

- <no parameter> command displays data in one table with the summary of all routes in the RIB for default VRF.
- brief command displays one table with the summary of all routes across all configured VRFs.
- ip command displays one table with the summary of all IPv4 in the RIB for default VRF.
- ipv6 command displays one table with the summary of all IPv4 in the RIB for default VRF.
- vrf <vrf_Name> command displays one table with the summary of all routes in the Routing Information Base for the specified VRF.
- vrf all command displays one table with the summary of all routes in the Routing Information Base for each configured VRF.
- INFO_LEVEL amount of information that is displayed. Options include:
- **Display Values**
 - **VRF** VRF RIB displayed.
 - **Route Source** Source for the route.
 - **Number of Routes** Number of routes for each source.

- The following displays data in one table with the summary of all routes in the RIB for default VRF.

```
switch>show rib route summary
VRF: default
Route Source          Number Of Routes
-----
BGP                   1
Connected             4
Dynamic policy        0
IS-IS                 0
OSPF                  0
OSPFv3                0
RIP                   0
Route input           2
Static                0
VRF leak              0
```

- The following displays data in one table with the summary of all routes across all configured VRFs.

```
switch>show rib route summary brief
Route Source          Number Of Routes
-----
BGP                   2
Connected             8
Dynamic policy        0
IS-IS                 0
OSPF                  0
```

```

OSPFv3          0
RIP             0
Route input     4
Static          0
VRF leak        0

```

- The following displays data in one table with the summary of all IPv4 routes in the RIB for default VRF.

```

switch>show rib route summary ip
VRF: default
Route Source          Number Of Routes
-----
BGP                   1
Connected             4
Dynamic policy        0
IS-IS                 0
OSPF                  0
OSPFv3                0
RIP                   0
Route input           2
Static                0
VRF leak              0

```

- The following displays data in one table with the summary of all IPv6 routes in the RIB for default VRF.

```

switch>show rib route summary ipv6
VRF: default
Route Source          Number Of Routes
-----
BGP                   0
Connected             0
Dynamic policy        0
IS-IS                 0
OSPF                  0
OSPFv3                0
RIP                   0
Route input           0
Static                0
VRF leak              0

```

- The following displays data in one table with the summary of all routes in the RIB for the VRF named "red".

```

switch>show rib route summary vrf red
VRF: red
Route Source          Number Of Routes
-----
BGP                   1
Connected             4
Dynamic policy        0
IS-IS                 0
OSPF                  0
OSPFv3                0
RIP                   0
Route input           2
Static                0
VRF leak              0

```

- The following displays data in one table with the summary of all routes in the RIB for each configured VRF.

```
switch>show rib route summary vrf all
VRF: red
Route Source          Number Of Routes
-----
BGP                   1
Connected             4
Dynamic policy       0
IS-IS                0
OSPF                 0
OSPFv3               0
RIP                  0
Route input          2
Static               0
VRF leak             0

VRF: default
Route Source          Number Of Routes
-----
BGP                   1
Connected             4
Dynamic policy       0
IS-IS                0
OSPF                 0
OSPFv3               0
RIP                  0
Route input          2
Static               0
VRF leak             0
```

12.1.14.76 show routing-context vrf

The **show routing-context vrf** command displays the context-active VRF. The context-active VRF determines the default VRF that VRF-context aware commands use when displaying routing table data from a specified VRF.

Command Mode

EXEC

Command Syntax

```
show routing-context vrf
```

Related Commands

- [cli vrf](#) specifies the context-active VRF.

Example:

This command displays the context-active VRF.

```
switch>show routing-context vrf  
Current VRF routing-context is PURPLE  
switch>
```

12.1.14.77 show tunnel fib static interface gre

The **show tunnel fib static interface gre** command displays the forwarding information base (FIB) information for a static interface GRE tunnel.

Command Mode

EXEC

Command Syntax

```
show tunnel fib static interface gre <number>
```

Parameter

- *number* Specifies the tunnel index number.

Example:

This command display the interface tunnel configuration with GRE configured.

```
switch#show tunnel fib static interface gre 10  
  
Type 'Static Interface', index 10, forwarding Primary  
via 10.6.1.2, 'Ethernet6/1'  
GRE, destination 10.1.1.2, source 10.1.1.1, ttl 10, tos 0xa
```

12.1.14.78 show vrf

The **show vrf** command displays the VRF name, RD, supported protocols, state and included interfaces for the specified VRF or for all VRFs on the switch.

Command Mode

EXEC

Command Syntax

```
show vrf [VRF_INSTANCE]
```

Parameters

- **VRF_INSTANCE** Specifies the VRF instance to display.
 - *<no parameter>* Information is displayed for all VRFs.
 - **vrf vrf_name** Information is displayed for the specified user-defined VRF.

Example:

This command displays information for the VRF named “purple.”

```
switch>show vrf purple
Vrf          RD          Protocols    State
Interfaces
-----
purple      64496:237   ipv4         no routing   Vlan42,
Vlan43
switch>
```

12.1.14.79 tcp mss ceiling

The `tcp mss ceiling` command configures the maximum segment size (MSS) limit in the TCP header on the configuration mode interface and enables TCP MSS clamping.

The `no tcp mss ceiling` and the `default tcp mss ceiling` commands remove any MSS ceiling limit previously configured on the interface.



Note: Configuring a TCP MSS ceiling on any Ethernet or tunnel interface enables TCP MSS clamping on the switch as a whole. Without hardware support, clamping routes all TCP SYN packets through software, even on interfaces where no TCP MSS ceiling has been configured. This significantly limits the number of TCP sessions the switch can establish per second, and can potentially cause packet loss if the CPU traffic exceeds control plane policy limits.

Command Mode

Interface-Ethernet Configuration

Subinterface-Ethernet Configuration

Interface-Port-channel Configuration

Subinterface-Port-channel Configuration

Interface-Tunnel Configuration

Interface-VLAN Configuration

Command Syntax

```
tcp mss ceiling {ipv4 segment size | ipv6 segment size} {egress | ingress}
```

```
no tcp mss ceiling
```

```
default tcp mss ceiling
```

Parameters

- **ipv4 segment size** The IPv4 segment size value in bytes. Values range from 64 to 65515.
- **ipv6 segment size** The IPv6 segment size value in bytes. Values range from 64 to 65495. This option is not supported on Sand platform switches (Qumran-MX, Qumran-AX, Jericho, Jericho+).
- **egress** The TCP SYN packets that are forwarded from the interface to the network.
- **ingress** The TCP SYN packets that are received from the network to the interface. Not supported on Sand platform switches.

Guidelines

- On Sand platform switches (Qumran-MX, Qumran-AX, Jericho, Jericho+), this command works only for egress, and is supported only on IPv4 unicast packets entering the switch.
- Clamping can only be configured in one direction per interface and works only on egress on Sand platform switches.
- To configure ceilings for both IPv4 and IPv6 packets, both configurations must be included in a single command; re-issuing the command overwrites any previous settings.
- Clamping configuration has no effect on GRE transit packets.

Example:

These commands configure *Ethernet interface 5* as a routed port, then specify a maximum MSS ceiling value of 1458 bytes in TCP SYN packets exiting that port. This enables TCP MSS clamping on the switch.

```
switch(config)#interface ethernet 5
switch(config-if-Et5)#no switchport
switch(config-if-Et5)#tcp mss ceiling ipv4 1458 egress
```

```
switch(config-if-Et5) #
```

12.1.14.80 tunnel

The **tunnel** command configures options for protocol-over-protocol tunneling. Because interface-tunnel configuration mode is not a group change mode, **running-config** is changed immediately after commands are executed. The **exit** command does not affect the configuration.

The **no tunnel** command deletes the specified tunnel configuration.

Command Mode

Interface-tunnel Configuration

Command Syntax

```
tunnel <options>
```

```
no tunnel <options>
```

Parameters

- **options** Specifies the various tunneling options as listed below.
 - **destination** Destination address of the tunnel.
 - **ipsec** Secures the tunnel with the IPsec address.
 - **key** Sets the tunnel key.
 - **mode** Tunnel encapsulation method.
 - **path-mtu-discovery** Enables the Path MTU discovery on tunnel.
 - **source** Source of the tunnel packets.
 - **tos** Sets the IP type of service value.
 - **ttl** Sets time to live value.
 - **underlay** Tunnel underlay.

Example:

These commands place the switch in interface-tunnel configuration mode for *tunnel interface 10* and with GRE tunnel configured on the interfaces specified.

```
switch(config)#ip routing
switch(config)#interface Tunnel 10
switch(config-if-Tu10)#tunnel mode gre
switch(config-if-Tu10)#ip address 192.168.1.1/24
switch(config-if-Tu10)#tunnel source 10.1.1.1
switch(config-if-Tu10)#tunnel destination 10.1.1.2
switch(config-if-Tu10)#tunnel path-mtu-discovery
switch(config-if-Tu10)#tunnel tos 10
switch(config-if-Tu10)#tunnel ttl 10
```

12.1.14.81 vrf (Interface mode)

The **vrf** command adds the configuration mode interface to the specified VRF. You must create the VRF first, using the [vrf instance](#) command.

The **no vrf** and **default vrf** commands remove the configuration mode interface from the specified VRF by deleting the corresponding **vrf** command from *running-config*.

All forms of the **vrf** command remove all IP addresses associated with the configuration mode interface.

Command Mode

Interface-Ethernet Configuration

Interface-Loopback Configuration

Interface-Management Configuration

Interface-Port-channel Configuration

Interface-VLAN Configuration

Command Syntax

```
vrf [vrf_name]
```

```
no vrf [vrf_name]
```

```
default vrf [vrf_name]
```

Parameters

- **vrf_name** Name of configured VRF.

Examples:

- These commands add the configuration mode interface (*VLAN 20*) to the VRF named *“purple”*.

```
switch(config)#interface vlan 20  
switch(config-if-Vl20)#vrf purple  
switch(config-if-Vl20)#
```

- These commands remove the configuration mode interface from VRF *“purple”*.

```
switch(config)#interface vlan 20  
switch(config-if-Vl20)#no vrf purple  
switch(config-if-Vl20)#
```

12.1.14.82 vrf instance

The **vrf instance** command places the switch in VRF configuration mode for the specified VRF. If the named VRF does not exist, this command creates it. The number of user-defined VRFs supported varies by platform.

To add an interface to the VRF once it is created, use the [vrf \(Interface mode\)](#) command.

The **no vrf instance** and **default vrf instance** commands delete the specified VRF instance by removing the corresponding **vrf instance** command from *running-config*. This also removes all IP addresses associated with interfaces that belong to the deleted VRF.

The **exit** command returns the switch to global configuration mode.

Command Mode

Global Configuration

Command Syntax

```
vrf instance [vrf_name]
no vrf instance [vrf_name]
default vrf instance [vrf_name]
```

Parameters

- **vrf_name** Name of VRF being created, deleted or configured. The names “main” and “default” are reserved.

Example:

This command creates a VRF named “purple” and places the switch in VRF configuration mode for that VRF.

```
switch(config)#vrf instance purple
switch(config-vrf-purple)#
```

12.2 IPv6

Arista switches support Internet Protocol version 4 (IPv4) and Internet Protocol version 6 (IPv6) for routing packets across network boundaries. This section describes Arista’s implementation of IPv6 and includes these topics:

- [Introduction](#)
- [IPv6 Description](#)
- [Configuring IPv6](#)
- [IPv6 Commands](#)

12.2.1 Introduction

Routing transmits network layer data packets over connected independent subnets. Each subnet is assigned an IP address range and each device on the subnet is assigned an IP address from that range.

Connected subnets have IP address ranges that do not overlap. A router is a network device connecting multiple subnets. Routers forward inbound packets to the subnet whose address range includes the packets’ destination address.

IPv4 and IPv6 are Internet layer protocols that define packet-switched inter-networking, including source-to-destination datagram transmission across multiple networks. The switch supports IP Version 4 (IPv4) and IP Version 6 (IPv6).

IPv6 is described by RFC 2460: Internet Protocol, Version 6 (IPv6) Specification. RFC 2463 describes ICMPv6 for IPv6. ICMPv6 is a core protocol of the Internet Protocol suite.

12.2.2 IPv6 Description

Internet Protocol Version 6 is a communications protocol used for relaying network packets across a set of connected networks using the Internet Protocol suite. Each network device is assigned a 128 bit IP address that identifies its network location.

IPv6 specifies a packet format that minimizes router processing of packet headers. Since the IPv4 and IPv6 packet headers differ significantly, the protocols are not interoperable. Many transport and application-layer protocols require little or no change to operate over IPv6.

- [IPv6 Address Format](#)
- [IPv6 DHCP Snooping](#)
- [Neighbor Discovery Protocol](#)

12.2.2.1 IPv6 Address Format

IPv6 addresses have 128 bits, represented by eight 16-bit hexadecimal numbers separated by colons. IPv6 addresses are abbreviated as follows:

- Leading zeros in each 16-bit number may be omitted.
- One set of consecutive 16-bit numbers that equal zero may be replaced by a double colon.

Example

- The following three IPv6 hexadecimal number representations refer to the same address:

```
d28e:0000:0000:0000:0234:812f:61ed:4419
d28e:0:0:0:234:812f:61ed:4419
d28e::234:812f:61ed:4419
```

IPv6 addresses typically denote a 64-bit network prefix and a 64-bit host address.

Unicast and Anycast Addressing

Unicast addressing defines a one-to-one association between the destination address and a network endpoint. Each destination address uniquely identifies a single receiver endpoint. Anycast addressing defines a one-to-one-of-many association: packets to a single member of a group of potential receivers identified by the same destination address.

Unicast and anycast addresses are typically composed as follows:

- a 64-bit network prefix that identifies the network segment.
- a 64-bit interface identifier that is based on interface MAC address.

The format of a network address identifies the scope of the address

- Global address: valid in all networks and connect with other addresses with global scope anywhere or to addresses with link-local scope on the directly attached network.
- Link-local address: scope extends only to the link to which the interface is directly connected. Link-local addresses are not routable off the link.

Link-local addresses are created by the switch and are not configurable. The following figure depicts the switch's link local address derivation method.

Figure 27: Link Local Address Derivation

Multicast Addressing

Multicast addressing defines a one-to-many association: packets are simultaneously routed from a single sender to multiple endpoints in a single transmission. The network replicates packets as required by network links that contain a recipient endpoint. One multicast address is assigned to an interface for each multicast group to which the interface belongs.

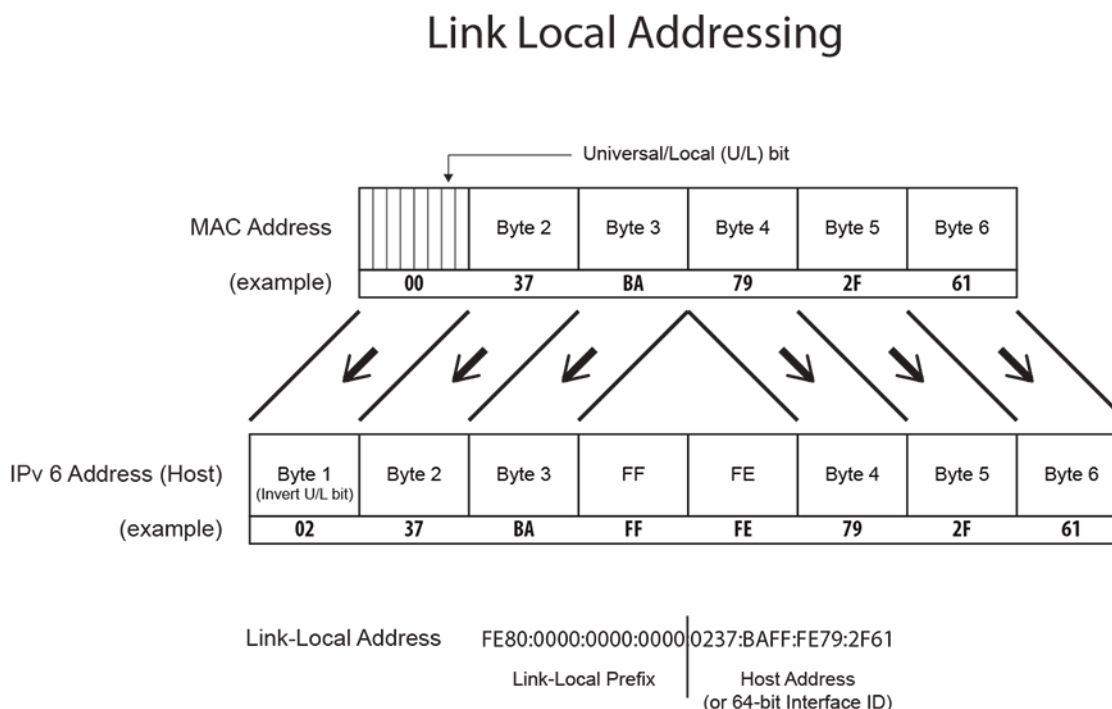

Figure 28: Link Local Address Derivation

A solicited-node multicast address is an IPv6 multicast address whose scope extends only to the link to which the interface is directly connected. All IPv6 hosts have at least one such address per interface. Solicited-node multicast addresses are used by the Neighbor Discovery Protocol to obtain layer 2 link-layer addresses of other nodes.

12.2.2.2 IPv6 DHCP Snooping

DHCP (Dynamic Host Configuration Protocol) snooping is a layer 2 feature that is configured on LAN switches. The Arista EOS switch supports Option-37 insertion that allows relay agents to provide remote-ID information in DHCP request packets. DHCP servers use this information to determine the originating port of DHCP requests and associate a corresponding IP address to that port. DHCP servers use port information to track host location and IP address usage by authorized physical ports.

DHCP snooping uses the information option (Option-37) to include the switch MAC address (router-ID) along with the physical interface name and VLAN number (remote-ID) in DHCP packets. After adding the information to the packet, the DHCP relay agent forwards the packet to the DHCP server as specified by the DHCP protocol.

Platform Compatibility

- DCS-7010

-
- DCS-7050
 - DCS-7060
 - DCS-7250
 - DCS-7260
 - DCS-7300

12.2.2.3 Neighbor Discovery Protocol

The Neighbor Discovery Protocol (RFC 4861) operates with IPv6 to facilitate the following tasks for nodes within a specified prefix space:

- autoconfiguring a node's IPv6 address
- sensing other nodes on the link
- discovering the link-local addresses of other nodes on the link
- detecting duplicate addresses
- discovering available routers
- discovering DNS servers
- discovering the link's address prefix
- maintaining path reachability data to other active neighbor nodes

The Neighbor Discovery Protocol protocol defines five different ICMPv6 packet types:

- Router Solicitation
- Router Advertisement
- Neighbor Solicitation
- Neighbor Advertisement
- Redirect

12.2.3 Configuring IPv6

These sections describe IPv6 configuration tasks:

- [Configuring IPv6 on the Switch](#)
- [Configuring IPv6 on an Interface](#)
- [Configuring IPv6 DHCP Snooping](#)
- [Viewing IPv6 Network Components](#)
- [DHCP Relay Agent for IPv6](#)

12.2.3.1 Configuring IPv6 on the Switch

12.2.3.1.1 Enabling IPv6 Unicast Routing on the Switch

The `ipv6 unicast-routing` command enables the forwarding of IPv6 unicast packets. When routing is enabled, the switch attempts to deliver inbound packets to destination addresses by forwarding them to interfaces or next hop addresses specified by the IPv6 routing table.

Example

This command enables IPv6 unicast-routing.

```
switch(config) #ipv6 unicast-routing
switch(config) #
```

12.2.3.1.2 Configuring Default and Static IPv6 Routes

The `ipv6 route` command creates an IPv6 static route. The destination is a IPv6 prefix; the source is an IPv6 address or a routable interface port. When multiple routes exist to a destination prefix, the route with the lowest administrative distance takes precedence.

By default, the administrative distance assigned to static routes is 1. Assigning a higher administrative distance to a static route configures it to be overridden by dynamic routing data. For example, a static route with a distance value of 200 is overridden by OSPF intra-area routes, which have a default distance of 110.

Example

This command creates an IPv6 static route.

```
switch(config)#ipv6 route 10:23:31:00:01:32:93/24 vlan 300
switch(config)#
```

The default route denotes the packet forwarding rule that takes effect when no other route is configured for a specified IPv6 address. All packets with destinations that are not established in the routing table are sent to the destination specified by the default route.

The IPv6 default route source is `::/0`. The default route destination is referred to as the default gateway.

Example

This command creates a default route and establishes `fd7a:629f:52a4:fe61::2` as the default gateway address.

```
switch(config)#ipv6 route ::/0 fd7a:629f:52a4:fe61::2
switch(config)#
```

12.2.3.1.3 IPv6 ECMP

Multiple routes that are configured to the same destination with the same administrative distance comprise an Equal Cost Multi-Path (ECMP) route. The switch attempts to spread outbound traffic across all ECMP route paths equally. All ECMP paths are assigned the same tag value; commands that change the tag value of any ECMP path change the tag value of all paths in the ECMP.

Resilient ECMP is available for IPv6 routes. [Equal Cost Multipath Routing \(ECMP\) and Load Sharing](#) describes resilient ECMP. The `ipv6 hardware fib ecmp resilience` command implements IPv6 resilient ECMP.

Example

This command implements IPv6 resilient ECMP by configuring a hardware ECMP table space of 15 entries for IPv6 address `2001:db8:0::/64`. A maximum of five nexthop addresses can be specified for the address. When the table contains five addresses, each appears in the table three times. When the table contains fewer than five addresses, each is duplicated until the 15 table entries are filled.

```
switch(config)#ipv6 hardware fib ecmp resilience 2001:db8:0::/64 capacity
5
redundancy 3
switch(config)#
```

12.2.3.2 Configuring IPv6 on an Interface

12.2.3.2.1 Enabling IPv6 on an Interface

The **ipv6 enable** command enables IPv6 on the configuration mode interface if it does not have a configured IPv6 address. It also configures the interface with an IPv6 address.

The **no ipv6 enable** command disables IPv6 on a configuration mode interface not configured with an IPv6 address. Interfaces configured with an IPv6 address are not disabled by this command.

Example

This command enables IPv6 on *VLAN interface 200*.

```
switch(config)#interface vlan 200
switch(config-vl200)#ipv6 enable
switch(config-vl200)#
```

12.2.3.2.2 Assigning an IPv6 Address to an Interface

The **ipv6 address** command enables IPv6 on the configuration mode interface, assigns a global IPv6 address to the interface, and defines the prefix length. This command is supported on routable interfaces. Multiple global IPv6 addresses can be assigned to an interface.

Example

- These commands configure an IPv6 address with subnet mask for VLAN 200:

```
switch(config)#interface vlan 200
switch(config-if-Vl200)#ipv6 address 10:23:31::1:32:93/64
switch(config-if-Vl200)#
```

12.2.3.2.3 IPv6 Neighbor Discovery

The IPv6 Neighbor Discovery protocol defines a method for nodes to perform the following network maintenance tasks:

- determine layer 2 addresses for neighbors known to reside on attached links
- detect changed layer 2 addresses
- purge invalid values from the neighbor cache table
- (hosts) find neighboring routers to forward packets
- track neighbor reachability status

IPv6 Neighbor Discovery is defined by RFC 2461. IPv6 Stateless Address Autoconfiguration is described by RFC 2462.

The following sections describe Neighbor Discovery configuration tasks.

12.2.3.2.3.1 Reachable Time

The **ipv6 nd reachable-time** command specifies the time period that the switch includes in the reachable time field of Router Advertisements (RAs) sent from the configuration mode interface. The reachable time defines the period that a remote IPv6 node is considered reachable after a reachability confirmation event.

Example

These commands configure the entry of *25000* (25 seconds) in the reachable time field of RAs sent from *VLAN 200*.

```
switch(config)#interface vlan 200
switch(config-if-Vl200)#ipv6 nd reachable-time 25000
switch(config-if-Vl200)#show active
  interface Vlan200
    ipv6 address fd7a:4321::1/64
    ipv6 nd reachable-time 25000
switch(config-if-Vl200)#
```

12.2.3.2.3 Router Advertisement Interval

The `ipv6 nd ra interval` command configures the interval between IPv6 RA transmissions from the configuration mode interface.

Example

These commands configure a RA transmission interval of 60 seconds on VLAN interface 200, then displays the interface status.

```
switch(config)#interface vlan 200
switch(config-if-Vl200)#ipv6 nd ra interval 60
switch(config-if-Vl200)#show active
interface Vlan200
  ipv6 nd ra interval 60
switch(config-if-Vl200)#
```

12.2.3.2.3.3 Router Lifetime

The `ipv6 nd ra lifetime` command specifies the value that the switch places in the **router lifetime** field of IPv6 RAs sent from the configuration mode interface.

If the value is set to 0, IPv6 peers connected to the specified interface will remove the switch from their lists of default routers. Values greater than 0 indicate the time in seconds that peers should keep the router on their default router lists without receiving further RAs from the switch. Unless the value is 0, the router lifetime value should be equal to or greater than the interval between unsolicited RAs sent on the interface.

Example

This command configures the switch to enter *2700* in the router lifetime field of RAs transmitted from *VLAN 200*.

```
switch(config)#interface vlan 200
switch(config-if-Vl200)#ipv6 nd ra lifetime 2700
switch(config-if-Vl200)#show active
interface Vlan200
  ipv6 nd ra lifetime 2700
switch(config-if-Vl200)#
```

12.2.3.2.3.4 Router Advertisement Prefix

The `ipv6 nd prefix` command configures neighbor discovery router advertisement prefix inclusion for RAs sent from the configuration mode interface.

By default, all prefixes configured as IPv6 addresses are advertised in the interface's RAs. The `ipv6 nd prefix` command with the `no-advertise` option prevents advertising of the specified prefix without affecting the advertising of other prefixes specified as IPv6 addresses. When an interface configuration includes at least one `ipv6 nd prefix` command that enables prefix advertising, RAs advertise only prefixes specified through `ipv6 nd prefix` commands.

Commands enabling prefix advertising also specify the advertised valid and preferred lifetime periods. Default periods are 2,592,000 (valid) and 604,800 (preferred) seconds.

Example

These commands enable neighbor discovery advertising for IPv6 address `3012:D678::/64`, specifying a valid lifetime of `1,296,000` seconds and the default preferred lifetime.

```
switch(config)#interface vlan 200
switch(config-if-Vl200)#ipv6 nd prefix 3012:D678::/64 1296000
switch(config-if-Vl200)#
```

12.2.3.2.3.5 Router Advertisement Suppression

The `ipv6 nd ra disabled` command suppress IPv6 RA transmissions on the configuration mode interface. By default, only unsolicited RAs that are transmitted periodically are suppressed. The `all` option configures the switch to suppress all RAs, including those responding to a router solicitation.

Example

- This command suppresses all RAs on VLAN interface 200.

```
switch(config)#interface vlan 200
switch(config-vl200)#ipv6 nd ra disabled all
switch(config-vl200)#
```

12.2.3.2.3.6 Router Advertisement MTU Suppression

The `ipv6 nd ra mtu suppress` command suppresses the router advertisement MTU option on the configuration mode interface. The MTU option causes an identical MTU value to be advertised by all nodes on a link. By default, the router advertisement MTU option is not suppressed.

Example

This command suppresses the MTU option on VLAN interface 200.

```
switch(config)#interface vlan 200
switch(config-vl200)#ipv6 nd ra mtu suppress
switch(config-vl200)#
```

12.2.3.2.3.7 Router Advertisement Flag Configuration

The following commands sets the specified configuration flag in IPv6 RAs transmitted from the configuration mode interface:

- The `ipv6 nd managed-config-flag` command sets the **managed address configuration** flag. This bit instructs hosts to use stateful address autoconfiguration.
- The `ipv6 nd other-config-flag` command sets the other **stateful configuration** flag. This bit indicates availability of autoconfiguration information, other than addresses. Hosts should use stateful autoconfiguration when available. The setting of this flag has no effect if the **managed address configuration** flag is set.

- These commands configure the switch to set the **managed address configuration** flag in advertisements sent from VLAN interface 200.

```
switch(config)#interface vlan 200
switch(config-if-Vl200)#ipv6 nd managed-config-flag
switch(config-if-Vl200)#
```

- These commands configure the switch to set the **other stateful configuration** flag in advertisements sent from VLAN interface 200.

```
switch(config)#interface vlan 200
switch(config-if-Vl200)#ipv6 nd other-config-flag
switch(config-if-Vl200)#
```

12.2.3.2.4 IPv6 Router Preference

The IPv6 Router Preference protocol supports an extension to RA messages for communicating default router preferences and more specific routes from routers to hosts. This provides assistance to hosts when selecting a router. RFC 4191 describes the IPv6 Router Preference Protocol.

The **ipv6 nd router-preference** command specifies the value that the switch enters in the Default Router Preference (DRP) field of RAs that it sends from the configuration mode interface. The default field entry value is **medium**.

Example

This command configures the switch as a medium preference router on RAs sent from *VLAN 200*.

```
switch(config)#interface vlan 200
switch(config-if-Vl200)#ipv6 nd router-preference medium
switch(config-if-Vl200)#
```

12.2.3.2.5 uRPF Configuration

Unicast Reverse Path Forwarding (uRPF) verifies the accessibility of source IP addresses in packets that the switch forwards. [Unicast Reverse Path Forwarding \(uRPF\)](#) describes uRPF. uRPF is enabled for IPv6 packets entering the configuration mode interface through the **ipv6 verify** command.

uRPF defines two operational modes: strict mode and loose mode.

- **Strict mode:** uRPF verifies that a packet is received on the interface that its routing table entry specifies for its return packet.
 - **Loose mode:** uRPF validation does not consider the inbound packet's ingress interface only that there is a valid return path.

Example

This command enables uRPF strict mode on VLAN interface 100. If a default route is configured on the interface, all inbound packets will pass the uRPF check as valid.

```
switch(config)#interface vlan 100
switch(config-if-Vl100)#ipv6 verify unicast source reachable-via rx
allow-default
switch(config-if-Vl100)#show active
interface Vlan100
  ipv6 verify unicast source reachable-via rx allow-default
switch(config-if-Vl100)#
```

12.2.3.3 Configuring IPv6 DHCP Snooping

12.2.3.3.1 Enabling IPv6 DHCP Snooping on the Switch

The `ipv6 dhcp snooping` command enables DHCP snooping globally on the switch. DHCP snooping is a layer 2 feature that can be configured on LAN switches. The Arista switch supports Option-37 insertion that allows relay agents to provide remote-ID information in DHCP request packets.

 **Note:** DHCPv6 VLAN classification and DHCPv4 VLAN classification share same hardware resource.

Example

- The following configuration enables IPv6 DHCP snooping feature at the global level.

```
switch(config)#ipv6 dhcp snooping
switch(config)#ipv6 dhcp snooping remote-id option
switch(config)#ipv6 dhcp snooping vlan <vlan|vlan-range>
```

- The following command display IPv6 DHCP snooping state.

```
switch(config)#ipv6 dhcp snooping
switch(config)#show ipv6 dhcp snooping
DHCPv6 Snooping is enabled
DHCPv6 Snooping is operational
DHCPv6 Snooping is configured on following VLANs:
 2789-2790
DHCPv6 Snooping is operational on following VLANs:
 2789
Insertion of Option-37 is enabled
```

12.2.3.4 Viewing IPv6 Network Components

12.2.3.4.1 Displaying RIB Route Information

Use the `show rib route ipv6` command view the IPv6 Routing Information Base (RIB) information.

Example

This command displays IPv6 RIB BGP routes.

```
switch#show rib route ipv6 bgp
VRF name: default, VRF ID: 0xfe, Protocol: bgp
Codes: C - Connected, S - Static, P - Route Input
       B - BGP, O - Ospf, O3 - Ospf3, I - Isis
       > - Best Route, * - Unresolved Nexthop
       L - Part of a recursive route resolution loop
B      2001:10:1::/64 [200/42]
       via 2001:10:1::100 [0/1]
       via Ethernet1, directly connected
>B     2001:10:100::/64 [200/200]
       via 2001:10:1::100 [0/1]
       via Ethernet1, directly connected
>B     2001:10:100:1::/64 [200/0]
       via 2001:10:1::100 [0/1]
       via Ethernet1, directly connected
>B     2001:10:100:2::/64 [200/42]
```

```

        via 2001:10:1::100 [0/1]
          via Ethernet1, directly connected

switch#

```

12.2.3.4.2 Displaying the FIB and Routing Table

The **show ipv6 route** command displays routing table entries that are in the Forwarding Information Base (FIB), including static routes, routes to directly connected networks, and dynamically learned routes. Multiple equal cost paths to the same prefix are displayed contiguously as a block, with the destination prefix displayed only on the first line.

Example

This command displays a route table entry for a specific IPv6 route.

```

switch>show ipv6 route fd7a:3418:52a4:fe18::/64
IPv6 Routing Table - 77 entries
Codes: C - connected, S - static, K - kernel, O - OSPF, B - BGP, R - RIP,
       A -
       Aggregate

O   fd7a:3418:52a4:fe18::/64 [10/20]
    via f180::21c:73ff:fe00:1319, Vlan3601
    via f180::21c:73ff:fe00:1319, Vlan3602
    via f180::21c:73ff:fe00:1319, Vlan3608
    via f180::21c:73ff:fe0f:6a80, Vlan3610
    via f180::21c:73ff:fe00:1319, Vlan3611

switch>

```

12.2.3.4.3 Displaying the Route Age

The **show ipv6 route age** command displays the IPv6 route age to the specified IPv6 address or prefix.

Example

This command displays the route age for the specified prefix.

```

switch>show ipv6 route 2001::3:0/11 age
IPv6 Routing Table - 74 entries
Codes: C - connected, S - static, K - kernel, O - OSPF, B - BGP, R - RIP,
       A -
       Aggregate

C 2001::3:0/11 age 00:02:34

switch>

```

12.2.3.4.4 Displaying Host Routes

The **show ipv6 route host** command displays all host routes in the IPv6 host forwarding table. Host routes are those whose destination prefix is the entire address (prefix = /128). Each displayed host route is labeled with its purpose:

- **F** static routes from the FIB.
- **R** routes defined because the IP address is an interface address.
- **A** routes to any neighboring host for which the switch has an ARP entry.

Example

This command displays all IPv6 host routes in the host forwarding table.

```
switch#show ipv6 route host
R - receive F - FIB, A - attached

F  ::1 to cpu
A  fee7:48a2:0c11:1900:400::1 on Vlan102
R  fee7:48a2:0c11:1900:400::2 to cpu
F  fee7:48a2:0c11:1a00::b via fe80::21c:73ff:fe0b:a80e on Vlan3902
R  fee7:48a2:0c11:1a00::17 to cpu
F  fee7:48a2:0c11:1a00::20 via fe80::21c:73ff:fe0b:33e on Vlan3913
F  fee7:48a2:0c11:1a00::22 via fe80::21c:73ff:fe01:5fe1 on Vlan3908
                               via fe80::21c:73ff:fe01:5fe1 on Vlan3902

switch#
```

12.2.3.4.5 Displaying Route Summaries

The `show ipv6 route summary` command displays the current number of routes of the IPv6 routing table in summary format.

Example

This command displays the route source and the corresponding number of routes in the IPv6 routing table.

```
switch>show ipv6 route summary
Route Source      Number Of Routes
-----
connected         2
static            0
ospf              5
bgp               7
isis              0
internal          1
attached          0
aggregate         2

Total Routes     17
switch>
```

12.2.3.5 DHCP Relay Agent for IPv6

12.2.3.5.1 Configuring IPv6 DHCP Relay

12.2.3.5.1.1 Configuring the IPv6 DHCP Relay Agent (Global)

The `ipv6 dhcp relay always-on` command enables the switch DHCP relay agent globally regardless of the DHCP relay agent status on any interface. The DHCP relay agent is enabled by default if at least one routable interface is configured with an `ipv6 dhcp relay destination` statement.

Example

This command enables the DHCP relay agent.

```
switch(config) # ipv6 dhcp relay always-on
switch(config) #
```

12.2.3.5.1.2 Configuring DHCP for IPv6 relay agent

The **ipv6 dhcp relay destination** command enables the DHCPv6 relay agent function and specifies the client message destination address on an interface.

Example

This command enables the DHCPv6 relay agent function and sets the client message destination address to 2001:0db8:0:1::1 on Ethernet interface 4.

```
switch(config) #interface ethernet 4
switch(config-if-Et4) #ipv6 dhcp relay destination 2001:0db8:0:1::1
switch(config-if-Et4)
```

12.2.3.5.1.3 Configuring the Client Link Layer Address for the IPv6 DHCP relay agent

The **ipv6 dhcp relay option link-layer address** command enables the DHCPv6 relay agent to configure the client link layer address option to solicit and request messages. In other words, the command enables the link layer address option (79) in the global configuration mode. The **no ipv6 dhcp relay option link-layer address** command disables the link layer address option (79) in the global configuration mode.

Example

This command enables the insertion of link layer address option (79) in the global configuration mode.

```
switch(config) #ipv6 dhcp relay option link-layer address
```

12.2.3.5.1.4 Clearing IPv6 DHCP Relay Counters

The **clear ipv6 dhcp relay counters** command resets the DHCP relay counters. The configuration mode determines which counters are reset:

- Global configuration: command clears the counters for the switch and for all interfaces.
- Interface configuration: command clears the counter for the configuration mode interface.

Example

- These commands clear all DHCP relay counters on the switch.

```
switch(config-if-Et4) #exit
switch(config) #clear ipv6 dhcp relay counters
switch(config) #
```

- These commands clear the DHCP relay counters for Ethernet interface 4.

```
switch(config) #interface ethernet 4
switch(config-if-Et4) #clear ipv6 dhcp relay counters
switch(config) #
```

12.2.3.5.2 Viewing IPv6 DHCP Relay Information

12.2.3.5.2.1 IPv6 DHCP Status

The **show ip dhcp relay** command displays the status of DHCP relay agent parameters on the switch and each interface where at least one feature parameter is listed. The command displays the status for both global and interface configurations.

Example

This command displays the DHCP Agent Relay parameter status.

```
switch(config)#interface ethernet 1/2
switch(config-if-Et1/2)#show ip dhcp relay
DHCP Relay is active
DHCP Relay Option 82 is disabled
DHCPv6 Relay Link-layer Address Option (79) is disabled
DHCP Smart Relay is disabled
Interface: Ethernet1/2
    DHCP Smart Relay is disabled
    DHCP servers: 1::1
                  2001:db8:0:1::1
switch(config-if-Et1/2)#
```

12.2.3.5.2.2 IPv6 DHCP Relay Counters

The **show ipv6 dhcp relay counters** command displays the number of DHCP packets received, forwarded, or dropped on the switch and on all interfaces enabled as DHCP relay agents.

Example

This command displays the IP DHCP relay counter table.

```
switch>show ipv6 dhcp relay counters
```

Interface	Dhcp Packets			Last Cleared
	Rcvd	Fwdd	Drop	
All Req	376	376	0	4 days, 19:55:12 ago
All Resp	277	277	0	
Ethernet4	207	148	0	4 days, 19:54:24 ago

```
switch>
```

12.2.4 IPv6 Commands

Global Configuration Commands

- `ipv6 dhcp relay always-on`
- `ipv6 dhcp relay option link-layer address`
- `ipv6 hardware fib aggregate-address`
- `ipv6 hardware fib ecmp resilience`
- `ipv6 hardware fib nexthop-index`
- `ipv6 neighbor`
- `ipv6 neighbor cache persistent`
- `ipv6 route`
- `ipv6 unicast-routing`

Interface Configuration Commands

- `ipv6 address`
- `ipv6 dhcp relay destination`
- `ipv6 dhcp snooping`
- `ipv6 enable`
- `ipv6 nd managed-config-flag`
- `ipv6 nd ns-interval`
- `ipv6 nd other-config-flag`
- `ipv6 nd prefix`
- `ipv6 nd ra dns-server`
- `ipv6 nd ra dns-servers lifetime`
- `ipv6 nd ra dns-suffix`
- `ipv6 nd ra dns-suffixes lifetime`
- `ipv6 nd ra hop-limit`
- `ipv6 nd ra interval`
- `ipv6 nd ra lifetime`
- `ipv6 nd ra mtu suppress`
- `ipv6 nd ra disabled`
- `ipv6 nd reachable-time`
- `ipv6 nd router-preference`
- `ipv6 verify`
- `pim ipv6 sparse-mode`

Privileged EXEC Commands

- `clear ipv6 dhcp relay counters`
- `clear ipv6 dhcp snooping counters`
- `clear ipv6 neighbors`

EXEC Commands

- `show ipv6 dhcp relay counters`
- `show ipv6 dhcp snooping`
- `show ipv6 dhcp snooping counters`
- `show ipv6 dhcp snooping hardware`
- `show ipv6 hardware fib aggregate-address`

-
- `show ipv6 interface`
 - `show ipv6 nd ra internal state`
 - `show ipv6 neighbors`
 - `show ipv6 route`
 - `show ipv6 route age`
 - `show ipv6 route host`
 - `show ipv6 route interface`
 - `show ipv6 route match tag`
 - `show ipv6 route summary`
 - `show rib route ipv6`

12.2.4.1 clear ipv6 dhcp relay counters

The `clear ipv6 dhcp relay counters` command resets the DHCP relay counters. When no port is specified, the command clears the counters for the switch and for all interfaces. Otherwise, the command clears the counter for the specified interface.

Command Mode

Privileged EXEC

Command Syntax

```
clear ipv6 dhcp relay counters [PORT]
```

Parameters

- PORT Interface through which neighbor is accessed. Options include:
 - <no parameter> all dynamic entries are removed.
 - interface ethernet *e_num* Ethernet interface specified by *e_num*.
 - interface loopback *l_num* Loopback interface specified by *l_num*.
 - interface port-channel *p_num* Port-channel interface specified by *p_num p_num*.
 - interface vlan *v_num* VLAN interface specified by *v_num*.

Example

These commands clear the DHCP relay counters for Ethernet interface 4 and shows the counters before and after the `clear` command.

```
switch(config)#show ipv6 dhcp relay counters
```

Interface	Dhcp Packets			Last Cleared
	Rcvd	Fwdd	Drop	
All Req	376	376	0	4 days, 19:55:12 ago
All Resp	277	277	0	
Ethernet4	207	148	0	4 days, 19:54:24 ago

```
switch(config)#interface ethernet 4
switch(config-if-Et4)#clear ipv6 dhcp relay counters
```

Interface	Dhcp Packets			Last Cleared
	Rcvd	Fwdd	Drop	
All Req	380	380	0	4 days, 21:19:17 ago
All Resp	281	281	0	
Ethernet4	0	0	0	4 days, 21:18:30 ago

These commands clear all DHCP relay counters on the switch.

```
switch(config-if-Et4)#exit
switch(config)#clear ipv6 dhcp relay counters
switch(config)#show ipv6 dhcp relay counters
```

Interface	Dhcp Packets			Last Cleared
	Rcvd	Fwdd	Drop	
All Req	0	0	0	0:00:03 ago
All Resp	0	0	0	
Ethernet4	0	0	0	0:00:03 ago

```
switch(config)#
```

12.2.4.2 clear ipv6 dhcp snooping counters

The `clear ipv6 dhcp snooping counters` command resets the DHCP snooping packet counters.

Command Mode

Privileged EXEC

Command Syntax

```
clear ipv6 dhcp snooping counters [COUNTER_TYPE]
```

Parameters

- **COUNTER_TYPE** The type of counter that the command resets.
- `<no parameter>` command clears the counters for each VLAN.
- `debug` command clears aggregate counters and drop cause counters.

Examples

- This command clears the number of DHCP packets sent and received on each VLAN.

```
switch#clear ipv6 dhcp snooping counters
switch# show ipv6 dhcp snooping counters
```

Vlan	Dhcpv6 Request Pkts			Dhcpv6 Reply Pkts			Last Cleared
-----	Rcvd	Fwdd	Drop	Rcvd	Fwdd	Drop	-----
2789	1	1	0	1	1	0	0:03:09 ago

- This command clears the number of DHCP packets sent on the switch.

```
switch#clear ipv6 dhcp snooping counters debug
switch#show ipv6 dhcp snooping counters debug
```

Counter	Snooping to Relay	Relay to Snooping
-----	-----	-----
Received	1	1
Forwarded	1	1
Dropped - Invalid VlanId	0	0
Dropped - Parse error	0	0
Dropped - Invalid Dhcp Optype	0	0
Dropped - Invalid Remote-ID Option	0	0
Dropped - Snooping disabled	0	0

Last Cleared: 0:04:29 ago

12.2.4.3 clear ipv6 neighbors

The `clear ipv6 neighbors` command removes the specified dynamic IPv6 neighbor discovery cache entries. Commands that do not specify an IPv6 address remove all dynamic entries for the listed interface. Commands that do not specify an interface remove all dynamic entries.

Command Mode

Privileged EXEC

Command Syntax

```
clear ipv6 neighbors [PORT][DYNAMIC_IPV6]
```

Parameters

- **PORT** Interface through which neighbor is accessed. Options include:
 - `<no parameter>` all dynamic entries are removed.
 - `ethernet e_num` Ethernet interface specified by `e_num`.
 - `loopback l_num` Loopback interface specified by `l_num`.
 - `management m_num` Management interface specified by `m_num`.
 - `port-channel p_num` Port-channel interface specified by `p_num`.
 - `vlan v_num` VLAN interface specified by `v_num`.
 - `vxlan vx_num` VXLAN interface specified by `vx_num`.
- **DYNAMIC_IPV6** Address of entry removed by the command. Options include:
 - `<no parameter>` All dynamic entries for specified interface are removed.
 - `ipv6_addr` IPv6 address of entry.

Example

This command removes all dynamic neighbor entries for **VLAN interface 200**.

```
switch#clear ipv6 neighbors vlan 200
switch#
```

12.2.4.4 ipv6 address

The **ipv6 address** command assigns a global IPv6 address to the IPv6 interface, and defines the prefix length. This command is supported on routable interfaces. Multiple global IPv6 addresses can be assigned to an interface.

The **no ipv6 address** and **default ipv6 address** commands remove the IPv6 address assignment from the configuration mode interface by deleting the corresponding **ipv6 address** command from **running-config**. If the command does not include an address, all address assignments are removed from the interface. IPv6 remains enabled on the interface after the removal of all IPv6 addresses only if an **ipv6 enable** command is configured on the interface.

Command Mode

Interface-Ethernet Configuration

Interface-Loopback Configuration

Interface-Management Configuration

Interface-Port-channel Configuration

Interface-VLAN Configuration

Command Syntax

```
ipv6 address [ipv6_prefix]
```

```
no ipv6 address [ipv6_prefix]
```

```
default ipv6 address [ipv6_prefix]
```

Parameters

ipv6_prefix address assigned to the interface (CIDR notation).

Guidelines

This command is supported on routable interfaces.

Example

These commands configure an IPv6 address and prefix length for *VLAN 200*:

```
switch(config)#interface vlan 200
switch(config-if-Vl200)#ipv6 address 10:23:31:00:01:32:93/64
switch(config-if-Vl200)#
```

12.2.4.5 ipv6 dhcp relay always-on

The `ipv6 dhcp relay always-on` command enables the switch DHCP relay agent on the switch regardless of the DHCP relay agent status on any interface. By default, the DHCP relay agent is enabled only if at least one routable interface is configured with an `ipv6 dhcp relay destination` statement.

The `no ipv6 dhcp relay always-on` and `default ipv6 dhcp relay always-on` commands remove the `ipv6 dhcp relay always-on` command from *running-config*.

Command Mode

Global Configuration

Command Syntax

```
ipv6 dhcp relay always-on
no ipv6 dhcp relay always-on
default ipv6 dhcp relay always-on
```

Example

This command enables the DHCP relay agent.

```
switch(config)#ipv6 dhcp relay always-on
switch(config)#
```

12.2.4.6 ipv6 dhcp relay destination

The **ipv6 dhcp relay destination** command enables the DHCPv6 relay agent and sets the destination address on the configuration mode interface.

The **no ipv6 dhcp relay destination** and **default ipv6 dhcp relay destination** commands remove the corresponding **ipv6 dhcp relay destination** command from **running-config**. When the commands do not list an IPv6 address, all **ipv6 dhcp relay destination** commands are removed from **running-config**.

Command Mode

Interface-Ethernet Configuration

Interface-Port-channel Configuration

Interface-VLAN Configuration

Command Syntax

```
ipv6 dhcp relay destination [ipv6_addr][source-address ipv6_addr]
```

```
no ipv6 dhcp relay destination [ipv6_addr]
```

```
default ipv6 dhcp relay destination [ipv6_addr]
```

Parameters

- *ipv6_addr* DHCP Server's IPv6 address.
- *source-address ipv6_addr* specify the source IPv6 address to communicate with DHCP server.

Guidelines

If the *source-address* parameter is specified, then the DHCP client receives an IPv6 address from the subnet of source IP address. The *source-address* must be one of the configured addresses on the interface.

Example

This command enables the DHCPv6 relay agent and sets the destination address to *2001:0db8:0:1::1* on *Ethernet interface 4*.

```
switch(config)#interface ethernet 4
switch(config-if-Et4)#ipv6 dhcp relay destination 2001:0db8:0:1::1
switch(config-if-Et4)#show ip dhcp relay
DHCP Relay is active
DHCP Relay Option 82 is disabled
DHCPv6 Relay Link-layer Address Option (79) is disabled
DHCP Smart Relay is disabled
Interface: Ethernet4
    DHCP Smart Relay is disabled
    DHCP servers: 1::1
                  2001:db8:0:1::1
switch(config-if-Et4)#
```

12.2.4.7 ipv6 dhcp relay option link-layer address

The **ipv6 dhcp relay option link-layer address** command enables the DHCPv6 relay agent to configure the client link layer address option to solicit and request messages. In other words, the command enables the link layer address option (79) in the global configuration mode.

The **no ipv6 dhcp relay option link-layer address** command disables the link layer address option (79) in the global configuration mode.

Command Mode

Global Configuration

Command Syntax

```
ipv6 dhcp relay option link-layer address
no ipv6 dhcp relay option link-layer address
default ipv6 dhcp relay option link-layer address
```

Example

This command enables the insertion of link layer address option (79) in the global configuration mode.

```
switch(config)#ipv6 dhcp relay option link-layer address
```

12.2.4.8 ipv6 enable

The **ipv6 enable** command enables IPv6 on the configuration mode interface. Assigning an IPv6 address to an interface also enables IPv6 on the interface.

The **no ipv6 enable** and **default ipv6 enable** command remove the corresponding **ipv6 enable** command from **running-config**. This action disables IPv6 on interfaces that are not configured with an IPv6 address.

Command Mode

Interface-Ethernet Configuration

Interface-Loopback Configuration

Interface-Management Configuration

Interface-Port-channel Configuration

Interface-VLAN Configuration

Command Syntax

```
ipv6 enable
```

```
no ipv6 enable
```

```
default ipv6 enable
```

Example

This command enables IPv6 on *VLAN interface 200*.

```
switch(config)#interface vlan 200  
switch(config-vl200)#ipv6 enable  
switch(config-vl200)#
```

12.2.4.9 ipv6 hardware fib aggregate-address

The **ipv6 hardware fib aggregate-address** command specifies the routing table repository of specified IPv6 route.

By default, routes that are created statically through the CLI or dynamically through routing protocols are initially stored in software routing tables, then entered in the hardware routing table by the routing agent. This command prevents the entry of the specified route into the hardware routing table. Specified routes that are in the hardware routing table are removed by this command. Specific routes that are encompassed within the specified route prefix are affected by this command.

The **no ipv6 hardware fib aggregate-address** and **default ipv6 hardware fib aggregate-address** commands remove the restriction from the hardware routing table for the specified routes by removing the corresponding **ipv6 hardware fib aggregate-address** command from *running-config*.

Command Mode

Global Configuration

Command Syntax

```
ipv6 hardware fib aggregate-address ipv6_prefix summary-only software-forward
no ipv6 hardware fib aggregate-address ipv6_prefix
default ipv6 hardware fib aggregate-address ipv6_prefix
```

Parameters

ipv6_prefix IPv6 prefix that is restricted from the hardware routing table (CIDR notation).

Example

These commands configure a hardware routing restriction for an IPv6 prefix, then displays that restriction.

```
switch(config)#ipv6 hardware fib aggregate-address fd77:4890:5313:ffed::/64
summary-only software-forward
switch(config)#show ipv6 hardware fib aggregate-address
Codes: S - Software Forwarded
S fd77:4890:5313:ffed::/64

switch(config)#
```

12.2.4.10 ipv6 hardware fib ecmp resilience

The **ip hardware fib ecmp resilience** command configures a fixed number of next hop entries in the hardware ECMP table for the specified IPv6 address prefix. In addition to specifying the maximum number of next hop addresses that the table can contain for the prefix, the command introduces a redundancy factor that allows duplication of each next hop address. The fixed table space for the address is the maximum number of next hops multiplied by the redundancy factor.

The default method of adding or removing next hop entries when required by the active hashing algorithm leads to inefficient management of the ECMP table, which can result in the rerouting of packets to different next hops that breaks TCP packet flows. Implementing fixed table entries for a specified IP address allows data flows that are hashed to a valid next hop number to remain intact. Additionally, traffic is evenly distributed over a new set of next hops.

The **no ip hardware fib ecmp resilience** and **default ip hardware fib ecmp resilience** commands restore the default hardware ECMP table management by removing the **ip hardware fib ecmp resilience** command from *running-config*.

Command Mode

Global Configuration

Command Syntax

```
ipv6 hardware fib ecmp resilience net_prfx capacity nhop_max redundancy duplicates  
no ipv6 hardware fib ecmp resilience net_addr  
default ipv6 hardware fib ecmp resilience net_addr
```

Parameters

- *net_prfx* IPv6 address prefix managed by command.
- *nhop_max* Specifies maximum number of nexthop entries for specified IP address prefix. Value range varies by platform:
 - Helix: <2 to 64>
 - Trident: <2 to 32>
 - Trident II: <2 to 64>
- *duplicates* Specifies the redundancy factor. Value ranges from 1 to 128.

Example

This command configures a hardware ECMP table space of 15 entries for the IPv6 address *2001:db8:0::/64*. A maximum of five nexthop addresses can be specified for the address. When the table contains five nexthop addresses, each appears in the table three times. When the table contains fewer than five nexthop addresses, each is duplicated until the 15 table entries are filled.

```
switch(config)#ipv6 hardware fib ecmp resilience 2001:db8:0::/64 capacity  
5 redundancy 3
```

12.2.4.11 ipv6 hardware fib nexthop-index

The **ipv6 hardware fib nexthop-index** command deterministically selects the next hop used for ECMP routes. By default, routes that are created statically through the CLI or dynamically through routing protocols are initially stored in software routing tables, then entered in the hardware routing table by the routing agent. This command specifies the method of creating an index-offset number that points to the next hop from the list of the route's ECMP next hops.

The index-offset is calculated by adding the next hop index to a prefix offset.

- **Next hop index:** specified in the command.
- **Prefix offset:** the least significant bits of the route's prefix.

The command specifies the number of bits that comprise the prefix offset. The prefix offset is set to the prefix when the command specifies a prefix size larger than the prefix. If the command specifies a prefix size of zero, the prefix-offset is also zero and the index-offset is set to the next hop index.

When the index-offset is greater than the number of next hops in the table, the position of the next hop is the remainder of the division of the index-offset by the number of next hop entries.

The **no ipv6 hardware fib nexthop-index** and **default ipv6 hardware fib nexthop-index** commands remove the specified nexthop used for ECMP routes by removing the **ipv6 hardware fib nexthop-index** command from *running-config*.

Command Mode

Global Configuration

Command Syntax

```
ipv6 hardware fib nexthop nxthop_index [PREFIX]
```

```
no ipv6 hardware fib nexthop
```

```
default ipv6 hardware fib nexthop
```

Parameters

- *nxthop_index* specifies the next hop index. Value ranges from 0 to 32.
- PREFIX Number of bits of the route's prefix to use as the prefix-offset. Value ranges from 0 to 64.
 - *<no parameter>* The prefix offset is set to zero.
 - prefix-bits **<0 to 64>** Specifies the number bits to use as the prefix-offset.

Example

This command specifies the next hop from the list of ECMP next hops for the route.

```
switch(config)#ipv6 hardware fib nexthop-index 5 prefix-bits 10
switch>show ip
IP Routing : Enabled
IP Multicast Routing : Disabled
VRRP: Configured on 0 interfaces

IPv6 Unicast Routing : Enabled
IPv6 ECMP Route support : False
IPv6 ECMP Route nexthop index: 5
IPv6 ECMP Route num prefix bits for nexthop index: 10
switch>
```

12.2.4.12 ipv6 nd managed-config-flag

The `ipv6 nd managed-config-flag` command causes the `managed address configuration` flag to be set in IPv6 RA packets transmitted from the configuration mode interface.

The `no ipv6 nd managed-config-flag` and `default ipv6 nd managed-config-flag` commands restore the default setting where the `managed address configuration` flag is not set in IPv6 RA packets transmitted by the interface by removing the corresponding `ipv6 nd managed-config-flag` command from *running-config*.

Command Mode

Interface-Ethernet Configuration

Interface-Loopback Configuration

Interface-Management Configuration

Interface-Port-channel Configuration

Interface-VLAN Configuration

Command Syntax

```
ipv6 nd managed-config-flag
```

```
no ipv6 nd managed-config-flag
```

```
default ipv6 nd managed-config-flag
```

Example

These commands cause the managed address configuration flag to be set in IPv6 RA packets sent from *VLAN interface 200*.

```
switch(config)#interface vlan 200  
switch(config-if-Vl200)#ipv6 nd managed-config-flag  
switch(config-if-Vl200)#
```

12.2.4.13 ipv6 nd ns-interval

The **ipv6 nd ns-interval** command configures the interval between IPv6 neighbor solicitation (NS) transmissions from the configuration mode interface.

The **no ipv6 nd ns-interval** and **default ipv6 nd ns-interval** commands return the IPv6 NS transmission interval for the configuration mode interface to the default value of 1000 milliseconds by removing the corresponding **ipv6 nd ns-interval** command from **running-config**.

Command Mode

Interface-Ethernet Configuration

Interface-Loopback Configuration

Interface-Management Configuration

Interface-Port-channel Configuration

Interface-VLAN Configuration

Command Syntax

```
ipv6 nd ns-interval period no ipv6 nd ns-interval
```

```
default ipv6 nd ns-interval
```

Parameters

period interval in milliseconds between successive IPv6 neighbor solicitation transmissions. Values range from 1000 to 4294967295. The default period is 1000 milliseconds.

Example

This command configures a neighbor solicitation transmission interval of 30 seconds on *VLAN interface 200*.

```
switch(config)#interface vlan 200  
switch(config-if-Vl200)#ipv6 nd ns-interval 30000  
switch(config-if-Vl200)#
```

12.2.4.14 ipv6 nd other-config-flag

The **ipv6 nd other-config-flag** command configures the configuration mode interface to send IPv6 RAs with the **other stateful configuration** flag set.

The **no ipv6 nd other-config-flag** and **default ipv6 nd other-config-flag** commands restore the default setting by removing the corresponding **ipv6 nd other-config-flag** command from **running-config**.

Command Mode

Interface-Ethernet Configuration

Interface-Loopback Configuration

Interface-Management Configuration

Interface-Port-channel Configuration

Interface-VLAN Configuration

Command Syntax

```
ipv6 nd other-config-flag
```

```
no ipv6 nd other-config-flag
```

```
default ipv6 nd other-config-flag
```

Example

These commands configure the switch to set the other stateful configuration flag in advertisements sent from *VLAN interface 200*.

```
switch(config)#interface vlan 200  
switch(config-if-Vl200)#ipv6 nd other-config-flag  
switch(config-if-Vl200)#
```

12.2.4.15 ipv6 nd prefix

The **ipv6 nd prefix** command configures neighbor discovery Router Advertisements (RAs) prefix inclusion for RAs sent from the configuration mode interface.

By default, all prefixes configured as [IPv6 addresses](#) are advertised in the interface's RAs. The **ipv6 nd prefix** command with the **no-advertise** option prevents advertising of the specified prefix without affecting the advertising of other prefixes specified as IPv6 addresses. When an interface configuration includes at least one **ipv6 nd prefix** command that enables prefix advertising, RAs advertise only prefixes specified through **ipv6 nd prefix** commands.

Commands enabling prefix advertising also specify the advertised valid and preferred lifetime periods. Default periods are 2,592,000 (valid) and 604,800 (preferred) seconds.

The **no ipv6 nd prefix** and **default ipv6 nd prefix** commands remove the corresponding **ipv6 nd prefix** command from *running-config*.

Command Mode

Interface-Ethernet Configuration

Interface-Loopback Configuration

Interface-Management Configuration

Interface-Port-channel Configuration

Interface-VLAN Configuration

Command Syntax

```
ipv6 nd prefix ipv6_prefix LIFETIME [FLAGS]
```

```
ipv6 nd prefix ipv6_prefix no-advertise
```

```
no ipv6 nd prefix ipv6_prefix
```

```
default ipv6 nd prefix ipv6_prefix
```

Parameters

- *ipv6_prefix* IPv6 prefix (CIDR notation).
- no-advertise Prevents advertising of the specified prefix.
- LIFETIME Period that the specified IPv6 prefix is advertised (seconds). Options include
 - valid preferred Two values that set the *valid* and *preferred* lifetime periods.
 - valid One value that sets the *valid* lifetime. The *preferred* lifetime is set to the default value.
 - <no parameter> The *valid* and *preferred* lifetime periods are set to their default values.

Options for valid: <0 to 4294967295 > and infinite. Default value is 2592000 Options for preferred: <0 to 4294967295 > and infinite. Default value is 604800 The maximum value (4294967295) and infinite are equivalent settings.

- FLAGS on-link and autonomous address-configuration flag values in RAs.
 - <no parameter> both flags are set.
 - no-autoconfig autonomous address-configuration flag is reset.
 - no-onlink on-link flag is reset.
 - no-autoconfig no-onlink both flags are reset.
 - no-onlink no-autoconfig both flags are reset.

Example

These commands enable neighbor discovery advertising for IPv6 address `3012:D678::/64`, on *VLAN interface 200*, specifying a valid lifetime of 1,296,000 seconds and the default preferred lifetime.

```
switch(config)#interface vlan 200  
switch(config-if-Vl200)#ipv6 nd prefix 3012:D678::/64 1296000
```

12.2.4.16 ipv6 nd ra disabled

The **ipv6 nd ra disabled** command suppress IPv6 Router Advertisement (RA) transmissions on the configuration mode interface. By default, only unsolicited RAs that are transmitted periodically are suppressed. The **all** option configures the switch to suppress all RAs, including those responding to a router solicitation.

The **no ipv6 nd ra disabled** and **default ipv6 nd ra disabled** commands restore the transmission of RAs on the configuration mode interface by deleting the corresponding **ipv6 nd ra disabled** command from *running-config*.

Command Mode

Interface-Ethernet Configuration

Interface-Loopback Configuration

Interface-Management Configuration

Interface-Port-channel Configuration

Interface-VLAN Configuration

Command Syntax

```
ipv6 nd ra disabled [SCOPE]
no ipv6 nd ra disabled
default ipv6 nd ra disabled
```

Parameters

- **SCOPE** specifies the RAs that are suppressed.
 - *<no parameter>* Periodic unsolicited RAs are suppressed.
 - **all** All RAs are suppressed.

Example

This command suppresses all RAs on *VLAN interface 200*.

```
switch(config)#interface vlan 200
switch(config-vl200)#ipv6 nd ra disabled all
switch(config-vl200)#
```

12.2.4.17 ipv6 nd ra dns-server

The **ipv6 nd ra dns-server** command configures the IPv6 address of a preferred Recursive DNS Server (RDNSS) for the command mode interface to include in its neighbor-discovery Router Advertisements (RAs). Including RDNSS information in RAs provides DNS server configuration for connected IPv6 hosts without requiring DHCPv6.

Multiple servers can be configured on the interface by using the command repeatedly. A lifetime value for the RDNSS can optionally be specified with this command, and overrides any default value configured for the interface using the **ipv6 nd ra dns-servers lifetime** command.

The **no ipv6 nd ra dns-server** and **default ipv6 nd ra dns-server** commands remove the corresponding **ipv6 nd ra dns-server** command from *running-config*.

Command Mode

Interface-Ethernet Configuration

Interface-Loopback Configuration

Interface-Management Configuration

Interface-Port-channel Configuration

Interface-VLAN Configuration

Command Syntax

```
ipv6 nd ra dns-server ipv6_addr SERVER_LIFE
```

```
no ipv6 nd ra dns-server ipv6_addr
```

```
default ipv6 nd ra dns-server ipv6_addr
```

Parameters

- *ipv6_addr* RDNSS address to be included in RAs from the command mode interface.
- SERVER_LIFE maximum lifetime value for the specified RDNSS entry. This value overrides any default lifetime value. Value should be between the RA interval configured on the interface and two times that interval. Options include:
 - *<no parameter>* lifetime period is the default lifetime period configured on the interface. If no lifetime period is configured on the interface, the default value is 1.5 times the maximum RA interval set by the **ipv6 nd ra interval** command.
 - lifetime 0 the configured RDNSS is not to be used.
 - lifetime **< 1 to 4294967295 >** specifies the lifetime period for this RDNSS in seconds.

Example

This command configures the RDNSS at *2001:0db8:0:1::1* as a preferred RDNSS for *VLAN interface 200* to include in its neighbor-discovery route advertisements, and sets its lifetime value to *300* seconds.

```
switch(config)#interface vlan 200
switch(config-if-Vl200)#ipv6 nd ra dns-server 2001:0db8:0:1::1 lifetime
300
switch(config-if-Vl200)#
```

12.2.4.18 ipv6 nd ra dns-servers lifetime

The `ipv6 nd ra dns-servers lifetime` command sets the default value that the configuration mode interface uses for the lifetime of any Recursive DNS Server (RDNSS) configured on the interface. A lifetime value set for an individual RDNSS overrides this value. The lifetime value is the maximum amount of time after a route advertisement packet is sent that the RDNSS referenced in the packet may be used for name resolution.

The `no ipv6 nd ra dns-servers lifetime` and `default ipv6 nd ra dns-servers lifetime` commands remove the default lifetime value from the interface by removing the corresponding `ipv6 nd ra dns-servers lifetime` command from *running-config*. When there is no default RDNSS lifetime value configured on the interface, an RDNSS without a custom lifetime value will default to 1.5 times the RA interval configured on the interface. A lifetime of zero seconds means that the RDNSS must not be used for name resolution.

Command Mode

Interface-Ethernet Configuration

Interface-Loopback Configuration

Interface-Management Configuration

Interface-Port-channel Configuration

Interface-VLAN Configuration

Command Syntax

```
ipv6 nd ra dns-servers lifetime period
no ipv6 nd ra dns-servers lifetime
default ipv6 nd ra dns-servers lifetime
```

Parameters

- *period* the RDNSS lifetime value for the configuration mode interface. Options include:
 - `<0>` any RDNSS configured on the command mode interface without a custom lifetime value must not be used.
 - `< 1 to 4294967295 >` maximum RDNSS lifetime value for the configuration mode interface. This value is overridden by any lifetime value set with the `ipv6 nd ra dns-server` command. Should be between the router advertisement interval configured on the interface and two times that interval.

Example

- This command sets the default RDNSS maximum lifetime value for *VLAN 200* to 350 seconds.

```
switch(config)#interface vlan 200
switch(config-if-Vl200)#ipv6 nd ra dns-servers lifetime 350
switch(config-if-Vl200)#
```

12.2.4.19 ipv6 nd ra dns-suffix

The **ipv6 nd ra dns-suffix** command creates a DNS Search List (DNSSL) for the command mode interface to include in its neighbor-discovery Router Advertisements as defined in RFC 6106 . The DNSSL contains the domain names of DNS suffixes for IPv6 hosts to append to short, unqualified domain names for DNS queries.

Multiple DNS domain names can be added to the DNSSL by using the command repeatedly. A lifetime value for the DNSSL can optionally be specified with this command, and overrides any default value configured for the interface using the **ipv6 nd ra dns-suffixes lifetime** command.

The **no ipv6 nd ra dns-suffix** and **default ipv6 nd ra dns-suffix** commands remove the corresponding **ipv6 nd ra dns-suffix** command from *running-config*.

Command Mode

Interface-Ethernet Configuration

Interface-Loopback Configuration

Interface-Management Configuration

Interface-Port-channel Configuration

Interface-VLAN Configuration

Command Syntax

```
ipv6 nd ra dns-suffix domain SUFFIX_LIFE
```

```
no ipv6 nd ra dns-suffix ipv6_addr
```

```
default ipv6 nd ra dns-suffix ipv6_addr
```

Parameters

- *domain* domain suffix for IPv6 hosts to append to short, unqualified domain names for DNS queries. Suffix must contain only alphanumeric characters, "." and "-" and must begin and end with an alphanumeric character.
- SUFFIX_LIFE maximum lifetime value for the specified domain suffix. This value overrides any default lifetime value. Value should be between the RA interval configured on the interface and two times that interval. Options include:
 - *<no parameter>* lifetime period is the default lifetime period configured on the interface. If no lifetime period is configured on the interface, the default value is 1.5 times the maximum RA interval set by the `ipv6 nd ra interval` command.
 - `lifetime 0` the configured domain suffix is not to be used.
 - `lifetime < 1 to 4294967295 >` specifies the lifetime period for this domain suffix in seconds.

Example

These commands create a DNSSL for *VLAN interface 200* to include in its neighbor-discovery route advertisements, and set its lifetime value to *300* seconds.

```
switch(config)#interface vlan 200  
switch(config-if-Vl200)#ipv6 nd ra dns-suffix test.com lifetime 300  
switch(config-if-Vl200)#
```

12.2.4.20 ipv6 nd ra dns-suffixes lifetime

The **ipv6 nd ra dns-suffixes lifetime** command sets the default value that the configuration mode interface uses for the lifetime of any DNS Search List (DNSSL) configured on the interface. A lifetime value set for an individual DNSSL overrides this value. The lifetime value is the maximum amount of time after a route advertisement packet is sent that the DNSSL included in the packet may be used for name resolution.

The **no ipv6 nd ra dns-suffixes lifetime** and **default ipv6 nd ra dns-suffixes lifetime** commands remove the default lifetime value from the interface by removing the corresponding **ipv6 nd ra dns-suffixes lifetime** command from *running-config*. When there is no default DNSSL lifetime value configured on the interface, a DNSSL without a custom lifetime value will default to 1.5 times the RA interval configured on the interface. A lifetime of zero seconds means that the DNSSL must not be used for name resolution.

Command Mode

Interface-Ethernet Configuration

Interface-Loopback Configuration

Interface-Management Configuration

Interface-Port-channel Configuration

Interface-VLAN Configuration

Command Syntax

```
ipv6 nd ra dns-suffixes lifetime period
no ipv6 nd ra dns-suffixes lifetime
default ipv6 nd ra dns-suffixes lifetime
```

Parameters

- *period* the DNSSL lifetime value for the configuration mode interface. Options include:
 - **<0>** any DNSSL configured on the command mode interface without a custom lifetime value must not be used.
 - **< 1 to 4294967295 >** maximum DNSSL lifetime value for the configuration mode interface. This value is overridden by any lifetime value set with the **ipv6 nd ra dns-suffix** command. Should be between the RA interval configured on the interface and two times that interval.

Example

This command sets the default DNSSL maximum lifetime value for *VLAN 200* to 350 seconds.

```
switch(config)#interface vlan 200
switch(config-if-Vl200)#ipv6 nd ra dns-suffixes lifetime 350
switch(config-if-Vl200)#
```

12.2.4.21 ipv6 nd ra hop-limit

The **ipv6 nd ra hop-limit** command sets a suggested hop-limit value to be included in Router Advertisement (RA) packets. The hop-limit value is to be used by attached hosts in outgoing packets.

The **no ipv6 nd ra hop-limit** and **default ipv6 nd ra hop-limit** commands remove the corresponding **ipv6 nd ra hop-limit** command from *running-config*.

Command Mode

Interface-Ethernet Configuration
Interface-Loopback Configuration
Interface-Management Configuration
Interface-Port-channel Configuration
Interface-VLAN Configuration

Command Syntax

```
ipv6 nd ra hop-limit quantity  
no ipv6 nd ra hop-limit lifetime  
default ipv6 nd ra hop-limit lifetime
```

Parameters

- *quantity* the hop-limit value to be included in RA packets sent by the configuration mode interface. Options include:
 - **<0>** indicates that outgoing packets from attached hosts are to be immediately discarded.
 - **<1 to 255>** number of hops. The default value is 64.

Example

These commands include a hop-limit value of *100* in RA packets sent by *VLAN 200*.

```
switch(config)#interface vlan 200  
switch(config-if-Vl200)#ipv6 nd ra hop-limit  
switch(config-if-Vl200)#
```

12.2.4.22 ipv6 nd ra interval

The **ipv6 nd ra interval** command configures the interval between IPv6 Router Advertisement transmissions from the configuration mode interface.

The **no ipv6 nd ra interval** and **default ipv6 nd ra interval** commands return the IPv6 RA transmission interval for the configuration mode interface to the default value of 200 seconds by removing the corresponding **ipv6 nd ra interval** command from *running-config*.

Command Mode

Interface-Ethernet Configuration
Interface-Loopback Configuration
Interface-Management Configuration
Interface-Port-channel Configuration
Interface-VLAN Configuration

Command Syntax

```
ipv6 nd ra interval [SCALE] ra_period [minimum_period]
```

```
no ipv6 nd ra interval
default ipv6 nd ra interval
```

Parameters

- **SCALE** timescale in which command parameter values are expressed.
 - *<no parameter>* seconds
 - **msec** milliseconds
- *ra_period* maximum interval between successive IPv6 RA transmissions. The default period is 200 seconds.
 - **< 4 - 1800 >** valid range when scale is set to default value (seconds).
 - **< 500 - 1800000 >** valid range when scale is set to msec.
- *minimum_period* minimum interval between successive IPv6 RA transmissions. Must be smaller than *ra_period*. By default, a minimum period is not defined.
 - *<no parameter>* Command does not specify a minimum period.
 - **< 3 - 1799 >** valid range when scale is set to default value (seconds).
 - **< 375 - 1799999 >** valid range when scale is set to msec.

Example

These commands configure a RA transmission interval of 60 seconds on VLAN interface 200, then displays the interface status.

```
switch(config)#interface vlan 200
switch(config-if-Vl200)#ipv6 nd ra interval 60
switch(config-if-Vl200)#show active
interface Vlan200
    ipv6 nd ra interval 60
switch(config-if-Vl200)#
```

12.2.4.23 ipv6 nd ra lifetime

The **ipv6 nd ra lifetime** command specifies the value that the switch places in the **router lifetime** field of IPv6 Router Advertisements sent from the configuration mode interface.

If the value is set to 0, IPv6 peers connected to the specified interface will remove the switch from their lists of default routers. Values greater than 0 indicate the time in seconds that peers should keep the router on their default router lists without receiving further RAs from the switch. Unless the value is 0, the router lifetime value should be equal to or greater than the interval between unsolicited RAs sent on the interface.

The **no ipv6 nd ra lifetime** and **default ipv6 nd ra lifetime** commands return the IPv6 RA lifetime data entry filed for the configuration mode interface to the default value of 1800 seconds by removing the corresponding **ipv6 nd ra lifetime** command from *running-config*.

Command Mode

Interface-Ethernet Configuration

Interface-Loopback Configuration

Interface-Management Configuration

Interface-Port-channel Configuration

Interface-VLAN Configuration

Command Syntax

```
ipv6 nd ra lifetime ra_lifetime
```

```
no ipv6 nd ra lifetime
```

```
default ipv6 nd ra lifetime
```

Parameters

- *ra_lifetime* router lifetime period (seconds). Default value is 1800. Options include
 - **< 0 >** Router should not be considered as a default router
 - **< 1 - 65535 >** Lifetime period advertised in RAs. Should be greater than or equal to the interval between IPv6 RA transmissions from the configuration mode interface as set by the **ipv6 nd ra interval** command.

Example

This command configures the switch to enter 2700 in the router lifetime field of RAs transmitted from VLAN 200.

```
switch(config)#interface vlan 200
switch(config-if-Vl200)#ipv6 nd ra lifetime 2700
switch(config-if-Vl200)#show active
interface Vlan20
    ipv6 nd ra lifetime 2700
switch(config-if-Vl200)#
```

12.2.4.24 ipv6 nd ra mtu suppress

The **ipv6 nd ra mtu suppress** command suppresses the Router Advertisement (RA) MTU option on the configuration mode interface. The MTU option causes an identical MTU value to be advertised by all nodes on a link. By default, the RA MTU option is not suppressed.

The **no ipv6 nd ra mtu suppress** and **default ipv6 nd ra mtu suppress** commands restores the MTU option setting to enabled by for the configuration mode interface by removing the corresponding **ipv6 nd ra mtu suppress** command from *running-config*.

Command Mode

Interface-Ethernet Configuration

Interface-Loopback Configuration

Interface-Management Configuration

Interface-Port-channel Configuration

Interface-VLAN Configuration

Command Syntax

```
ipv6 nd ra mtu suppress
```

```
no ipv6 nd ra mtu suppress
```

```
default ipv6 nd ra mtu suppress
```

Example

This command suppresses the MTU option on *VLAN interface 200*.

```
switch(config)#interface vlan 200  
switch(config-vl200)#ipv6 nd ra mtu suppress  
switch(config-vl200)#
```

12.2.4.25 ipv6 nd reachable-time

The **ipv6 nd reachable-time** command specifies the time period that the switch includes in the reachable time field of RAs sent from the configuration mode interface. The reachable time defines the period that a remote IPv6 node is considered reachable after a reachability confirmation event.

RAs that advertise zero seconds indicate that the router does not specify a reachable time. The default advertisement value is 0 seconds. The switch reachability default period is 30 seconds.

The **no ipv6 nd reachable-time** and **default ipv6 nd reachable-time** commands restore the entry of the default value (0) in RAs sent from the configuration mode interface by deleting the corresponding **ipv6 nd reachable-time** command from **running-config**.

Command Mode

Interface-Ethernet Configuration

Interface-Loopback Configuration

Interface-Management Configuration

Interface-Port-channel Configuration

Interface-VLAN Configuration

Command Syntax

```
ipv6 nd reachable-time period  
no ipv6 nd reachable-time  
default ipv6 nd reachable-time
```

Parameters

period Reachable time value (milliseconds). Value ranges from <0 to 4294967295>. Default is 0.

Example

These commands configure the entry of 25000 (25 seconds) in the reachable time field of RAs sent from VLAN 200.

```
switch(config)#interface vlan 200  
switch(config-if-Vl200)#ipv6 nd reachable-time 25000  
interface Vlan200  
    ipv6 address fd7a:4321::1/64  
    ipv6 nd reachable-time 25000  
switch(config-if-Vl200)#
```

12.2.4.26 ipv6 nd router-preference

The **ipv6 nd router-preference** command specifies the value that the switch enters in the Default Router Preference (DRP) field of Router Advertisements (RAs) that it sends from the configuration mode interface. The default field entry value is **medium**.

The **no ipv6 nd router-preference** and **default ipv6 nd router-preference** commands restore the switch to enter the default DRP field value of **medium** in RAs sent from the configuration mode interface by deleting the corresponding **ipv6 nd router-preference** command from *running-config*.

Command Mode

Interface-Ethernet Configuration

Interface-Loopback Configuration

Interface-Management Configuration

Interface-Port-channel Configuration

Interface-VLAN Configuration

Command Syntax

```
ipv6 nd router-preference RANK
no ipv6 nd router-preference
default ipv6 nd router-preference
```

Parameters

- **RANK** Router preference value. Options include:
 - high
 - low
 - medium

Example

This command configures the switch as a medium preference router on RAs sent from *VLAN 200*.

```
switch(config)#interface vlan 200
switch(config-if-Vl200)#ipv6 nd router-preference medium
switch(config-if-Vl200)#
```

12.2.4.27 ipv6 neighbor cache persistent

The `ipv6 neighbor cache persistent` command restores the IPv6 neighbor cache after reboot.

The `no ipv6 neighbor cache persistent` and `default ipv6 neighbor cache persistent` commands remove the ARP cache persistent configuration from the *running-config*.

Command Mode

Global Configuration

Command Syntax

```
ipv6 neighbor cache persistent
no ipv6 neighbor cache persistent
default ipv6 neighbor cache persistent
```

Example

This command restores the ipv6 neighbor cache after reboot.

```
switch(config)#ipv6 neighbor cache persistent
switch(config)#
```

12.2.4.28 ipv6 neighbor

The **ipv6 neighbor** command creates an IPv6 neighbor discovery cache static entry. The command converts pre-existing dynamic cache entries for the specified address to static entries.

The **no ipv6 neighbor** and **default ipv6 neighbor** commands remove the specified static entry from the IPV6 neighbor discovery cache and delete the corresponding **ipv6 neighbor** command from *running-config*. These commands do not affect any dynamic entries in the cache.

Command Mode

Global Configuration

Command Syntax

```
ipv6 neighbor ipv6_addr PORT mac_addr
```

```
no ipv6 neighbor ipv6_address PORT
```

```
default ipv6 neighbor ipv6_addr PORT
```

Parameters

- *ipv6_addr* Neighbor's IPv6 address.
- PORT Interface through which the neighbor is accessed. Options include:
 - ethernet *e_num* Ethernet interface specified by *e_num*.
 - loopback *L_num* Loopback interface specified by *L_num*.
 - management *m_num* Management interface specified by *m_num*.
 - port-channel *p_num* Port-channel interface specified by *p_num*.
 - vlan *v_num* VLAN interface specified by *v_num*.
 - vxlan *vx_num* VXLAN interface specified by *vx_num*.
- *mac_addr* Neighbor's data-link (hardware) address. (48-bit dotted hex notation – H.H.H).

Example

This command will add a static entry to the neighbor discovery cache for the neighbor located at *3100:4219::3EF2* with hardware address *0100.4EA1.B100* and accessible through *VLAN 200*.

```
switch(config)#ipv6 neighbor 3100:4219::3EF2 vlan 200 0100.4EA1.B100
switch(config)#
```

12.2.4.29 ipv6 route

The `ipv6 route` command creates an IPv6 static route. The destination is a IPv6 prefix; the source is an IPv6 address or a routable interface port. When multiple routes exist to a destination prefix, the route with the lowest administrative distance takes precedence.

By default, the administrative distance assigned to static routes is 1. Assigning a higher administrative distance to a static route configures it to be overridden by dynamic routing data. For example, a static route with a distance value of 200 is overridden by OSPF intra-area routes, which have a default distance of 110.

The command provides these methods of designating the nexthop location:

- **null0:** Traffic to the specified destination is dropped.
- **IPv6 gateway:** Switch identifies egress interface by recursively resolving the next-hop.
- **Egress interface:** Switch assumes destination subnet is directly connected to interface; when routing to any subnet address, the switch sends an ARP request to find the MAC address for the first packet.
- **Combination Egress interface and IPv6 gateway:** Switch does not assume subnet is directly connected to interface; the only ARP traffic is for the nexthop address for the first packet on the subnet. Combination routes are not recursively resolved.

Multiple routes that are configured to the same destination with the same administrative distance comprise an Equal Cost Multi-Path (ECMP) route. The switch attempts to spread outbound traffic across all ECMP route paths equally. All ECMP paths are assigned the same tag value; commands that change the tag value of any ECMP path change the tag value of all paths in the ECMP.

The `no ipv6 route` and `default ipv6 route` commands delete static routes by removing the corresponding `ipv6 route` statements from *running-config*. Commands not including a source delete all statements to the destination. Only statements with parameters that match specified command arguments are deleted. Parameters that are not in the command line are not evaluated.

Command Mode

Global Configuration

Command Syntax

```
ipv6 route dest_prefix NEXTHOP [DISTANCE][TAG_OPT][RT_NAME]
```

```
no ipv6 route dest_prefix [nexthop_addr][DISTANCE]
```

```
default ipv6 route dest_prefix [nexthop_addr][DISTANCE]
```

Parameters

- *dest_prefix* Destination IPv6 prefix (CIDR notation).

- NEXTHOP Access method of next hop device. Options include:
 - `null0` Null0 interface – route is dropped.
 - `nexthop_addr` IPv6 address of nexthop device.
 - `ethernet e_num` Ethernet interface specified by `e_num`.
 - `loopback l_num` Loopback interface specified by `l_num`.
 - `management m_num` Management interface specified by `m_num`.
 - `port-channel p_num` Port-channel interface specified by `p_num`.
 - `vlan v_num` VLAN interface specified by `v_num`.
 - `vxlan vx_num` VXLAN interface specified by `vx_num`.
 - `ethernet e_num nexthop_addr` Combination route (Ethernet interface and gateway).
 - `loopback l_num nexthop_addr` Combination route (loopback interface and gateway).
 - `management m_num nexthop_addr` Combination route (management interface and gateway).
 - `port-channel p_num nexthop_addr` Combination route (port channel interface and gateway).
 - `vlan v_num nexthop_addr` Combination route (VLAN interface and gateway).
 - `vxlan vx_num nexthop_addr` Combination route (VXLAN interface and gateway)
- DISTANCE administrative distance assigned to route. Options include:
 - `<no parameter>` route assigned default administrative distance of one.
 - `<1 to 255>` The administrative distance assigned to route.
- TAG_OPT static route tag. Options include:
 - `<no parameter>` assigns default static route tag of 0.
 - `tag <0 to 4294967295>` Static route tag value.
- RT_NAME Associates descriptive text to the route. Options include:
 - `<no parameter>` No text is associated with the route.
 - `name descriptive_text` The specified text is assigned to the route.

Example

This command creates an IPv6 static route.

```
switch(config)#ipv6 route 10:23:31:00:01:32:93/24 vlan 300
```

12.2.4.30 ipv6 unicast-routing

The **ipv6 unicast-routing** command enables the forwarding of IPv6 unicast packets. When routing is enabled, the switch attempts to deliver inbound packets to destination addresses by forwarding them to interfaces or next hop addresses specified by the IPv6 routing table.

The **no ipv6 unicast-routing** and default **ip ipv6 unicast-routing** commands disable IPv6 unicast routing by removing the **ipv6 unicast-routing** command from **running-config**. Dynamic routes added by routing protocols are removed from the routing table. Static routes are preserved by default; the **delete-static-routes** option removes static entries from the routing table.

IPv6 unicast routing is disabled by default.

Command Mode

Global Configuration

Command Syntax

```
ipv6 unicast-routing
```

```
no ipv6 unicast-routing [DELETE_ROUTES]
```

```
default ipv6 unicast-routing [DELETE_ROUTES]
```

Parameters

- **DELETE_ROUTES** Resolves routing table static entries when routing is disabled.
 - *<no parameter>* Routing table retains static entries.
 - **delete-static-routes** Static entries are removed from the routing table.

Example

This command enables IPv6 unicast-routing.

```
switch(config)#ipv6 unicast-routing  
switch(config)#
```

12.2.4.31 ipv6 verify

The **ipv6 verify** command configures Unicast Reverse Path Forwarding (uRPF) for inbound IPv6 packets on the configuration mode interface. uRPF verifies the accessibility of source IP addresses in packets that the switch forwards.

uRPF defines two operational modes: strict mode and loose mode.

- Strict mode: uRPF also verifies that a packet is received on the interface that its routing table entry specifies for its return packet.
- Loose mode: uRPF validation does not consider the inbound packet's ingress interface.

The **no ipv6 verify** and **default ipv6 verify** commands disable uRPF on the configuration mode interface by deleting the corresponding **ipv6 verify** command from *running-config*.

Command Mode

Interface-Ethernet Configuration

Interface-Loopback Configuration

Interface-Management Configuration

Interface-Port-Channel Configuration

Interface-VLAN Configuration

Command Syntax

```
ipv6 verify unicast source reachable-via RPF_MODE
no ipv6 verify unicast
default ipv6 verify unicast
```

Parameters

- RPF_MODE Specifies the uRPF mode. Options include:
 - any Loose mode.
 - rx Strict mode
 - rx allow-default Strict mode. All inbound packets are forwarded if a default route is defined.

Guidelines

The first IPv6 uRPF implementation briefly disables IPv6 unicast routing. Subsequent **ip verify** commands on any interface do not disable IPv6 routing.

Example

This command enables uRPF strict mode on VLAN interface 100. When a default route is configured on the interface, all inbound packets are checked as valid.

```
switch(config)#interface vlan 100
switch(config-if-Vl100)#ipv6 verify unicast source reachable-via rx
allow-default
switch(config-if-Vl100)#show active
  interface Vlan100
    ipv6 verify unicast source reachable-via rx allow-default
switch(config-if-Vl100)#
```

12.2.4.32 ipv6 dhcp snooping

The **ipv6 dhcp snooping** command enables DHCP snooping globally on the switch.

The **no ipv6 dhcp snooping** and **default ipv6 dhcp snooping** commands disable global DHCP snooping by removing the ipv6 dhcp snooping command from running-config.

Command Mode

Global Configuration

Command Syntax

```
ipv6 dhcp snooping [remote-id option | vlan [$ | vlan-range]]
```

```
no ipv6 dhcp snooping [remote-id option | vlan [$ | vlan-range]]
```

```
default ipv6 dhcp snooping [remote-id option | vlan [$ | vlan-range]]
```

Parameters

- remote-id option configures the remote ID option.
- vlan enables IPv6 DHCP snooping for a specific VLAN. Numbers range from 1 to 4094.
- \$ end of range.
- vlan-range VLANs based on the snooping enabled. Formats include a number, a number range, or a comma-delimited list of numbers and ranges. Numbers range from 1 to 4094.

Platform Compatibility

- DCS-7010
- DCS-7050
- DCS-7060
- DCS-7250
- DCS-7260
- DCS-7300

Examples

- The following configuration enables IPv6 DHCP snooping feature at the global level.

```
switch(config)#ipv6 dhcp snooping  
switch(config)#ipv6 dhcp snooping remote-id option  
switch(config)#ipv6 dhcp snooping vlan <vlan|vlan-range>
```

- The following command display IPv6 DHCP snooping state.

```
switch(config)#ipv6 dhcp snooping  
switch(config)# show ipv6 dhcp snooping  
DHCPv6 Snooping is enabled  
DHCPv6 Snooping is operational  
DHCPv6 Snooping is configured on following VLANs:  
 2789-2790  
DHCPv6 Snooping is operational on following VLANs:  
 2789  
Insertion of Option-37 is enabled
```

12.2.4.33 pim ipv6 sparse-mode

The **pim ipv6 sparse-mode** command enables PIM Sparse Mode (PIM-SM) and IGMP (router mode) on the configuration mode interface.



Note: PIM and multicast border router (MBR) must be mutually exclusive on an interface. If the interface is configured as an MBR, do not enable PIM on the interface.

The **no pim ipv6 sparse-mode** and **default pim ipv6 sparse-mode** commands restore the default PIM and IGMP (router mode) settings of **disabled** on the configuration mode interface by removing the **pim ipv6 sparse-mode** command from **running-config**.

Command Mode

Interface-Ethernet Configuration

Interface-Port-Channel

Configuration Interface-VLAN Configuration

Command Syntax

```
pim ipv6 sparse-mode
no pim ipv6
no pim ipv6 sparse-mode
default pim ipv6
default pim ipv6 sparse-mode
```

Example

This command enables PIM ipv6 sparse mode on *VLAN 4* interface.

```
switch(config)#interface vlan 4
switch(config-if-Vl4)#pim ipv6 sparse-mode
switch(config-if-Vl4)#
```

12.2.4.34 show ipv6 dhcp relay counters

The **show ipv6 dhcp relay counters** command displays the number of DHCP packets received, forwarded, or dropped on the switch and on all interfaces enabled as DHCP relay agents.

Command Mode

EXEC

Command Syntax

```
show ipv6 dhcp relay counters
```

Example

This command displays the IP DHCP relay counter table.

```
switch>show ipv6 dhcp relay counters
```

Interface	Dhcp Packets			Last Cleared
	Rcvd	Fwdd	Drop	
All Req	376	376	0	4 days, 19:55:12 ago
All Resp	277	277	0	
Ethernet4	207	148	0	4 days, 19:54:24 ago

```
switch>
```

12.2.4.35 show ipv6 dhcp snooping counters

The **show ipv6 dhcp snooping counters** command displays counters that track the quantity of DHCP request and reply packets that the switch receives. Data is either presented for each VLAN or aggregated for all VLANs with counters for packets dropped.

Command Mode

EXEC

Command Syntax

show ipv6 dhcp snooping counters [COUNTER_TYPE] **Parameters**

- COUNTER_TYPE The type of counter that the command displays.
- <no parameter> command displays counters for each VLAN.
- debug command displays aggregate counters and drop cause counters.

Examples

- This command displays the number of DHCP packets sent and received on each VLAN.

```
switch#show ipv6 dhcp snooping counters
```

Vlan	Dhcpv6 Request Pkts			Dhcpv6 Reply Pkts			Last Cleared
	Rcvd	Fwdd	Drop	Rcvd	Fwdd	Drop	
2789	1	1	0	1	1	0	0:03:09 ago

- This command displays the number of DHCP packets sent on the switch.

```
switch#show ipv6 dhcp snooping counters debug
```

Counter	Snooping to Relay	Relay to Snooping
Received	1	1
Forwarded	1	1
Dropped - Invalid VlanId	0	0
Dropped - Parse error	0	0
Dropped - Invalid Dhcp Optype	0	0
Dropped - Invalid Remote-ID Option	0	0
Dropped - Snooping disabled	0	0

Last Cleared: 0:04:29 ago

12.2.4.36 show ipv6 dhcp snooping hardware

The **show ipv6 dhcp snooping hardware** command displays internal hardware DHCP snooping status on the switch.

Command Mode

EXEC

Command Syntax

```
show ipv6 dhcp snooping hardware
```

Example

This command displays DHCP snooping hardware status.

```
switch#show ipv6 dhcp snooping hardware
DHCPv6 Snooping is enabled
DHCPv6 Snooping is enabled on following VLANs:
 2789
  Vlans enabled per Slice
    Slice: Linecard0-0
    2789
    Slice: Linecard0-1
    2789
    Slice: Linecard0-2
    2789
    Slice: Linecard0-3
    2789
```

12.2.4.37 show ipv6 dhcp snooping

The **show ipv6 dhcp snooping** command displays information about the DHCP snooping configuration.

Command Mode

EXEC

Command Syntax

```
show ipv6 dhcp snooping
```

Related Commands

- [ipv6 dhcp snooping](#)
- [show ipv6 dhcp snooping counters](#)
- [show ipv6 dhcp snooping hardware](#)
- [clear ipv6 dhcp snooping counters](#)

Example

This command displays the switch's DHCP snooping configuration.

```
switch#show ipv6 dhcp snooping
DHCPv6 Snooping is enabled
DHCPv6 Snooping is operational
DHCPv6 Snooping is configured on following VLANs:
 2789-2790
DHCPv6 Snooping is operational on following VLANs:
 2789
Insertion of Option-37 is enabled
```

12.2.4.38 show ipv6 hardware fib aggregate-address

The **show ipv6 hardware fib aggregate-address** command displays the IPv6 prefixes that are restricted from entry into the hardware routing table. The **ipv6 hardware fib aggregate-address** command configures IPv6 prefix restrictions.

Command Mode

EXEC

Command Syntax

```
show ipv6 address fib aggregate-address [ADDRESS][RESTRICTION]
```

Parameters

- **ROUTE_FILTER** filters by IPv6 address. Options include:
 - *<no parameter>* Displays all routes.
 - *ipv6_addr* Command displays only specified address.
 - *ipv6_prefix* Command displays addresses filtered by specified prefix (CIDR notation).
- **RESTRICTION** filters by route restriction.
 - *<no parameter>* displays routes restricted from the hardware routing table.
 - *software-forward* displays routes restricted from the hardware routing table.

Example

This command displays the routes that are restricted from the hardware routing table.

```
switch>show ipv6 hardware fib aggregate-address
Codes: S - Software Forwarded
S   fd77:4890:5313:aaed::/64
S   fd77:4890:5313:ffed::/64

switch>
```

12.2.4.39 show ipv6 interface

The **ipv6 interface** command displays the status of specified routed interfaces that are configured for IPv6.

Command Mode

EXEC

Command Syntax

```
show ipv6 interface [INTERFACE_NAME][INFO_LEVEL]
```

Parameters

- **INTERFACE_NAME** interfaces for which command displays status.
 - *<no parameter>* all routed interfaces.
 - **ethernet e_num** Ethernet interface specified by *e_num*.
 - **loopback l_num** Loopback interface specified by *l_num*.
 - **management m_num** Management interface specified by *m_num*.
 - **port-channel p_num** Port-Channel Interface specified by *p_num*.
 - **vlan v_num** VLAN interface specified by *v_num*.
 - **vxlan vx_num** VXLAN interface specified by *vx_num*.
- **INFO_LEVEL** amount of information that is displayed. Options include:
 - *<no parameter>* command displays data block for each specified interface.
 - **brief** command displays table that summarizes IPv6 interface data.

Example

This command displays the status of *VLAN 903*.

```
switch>show ipv6 interface vlan 903
Vlan903 is up, line protocol is up (connected)
IPv6 is enabled, link-local is fe80::21c:73ff:fe01:21e/64
Global unicast address(es):
  fd7a:629f:52a4:fe10::3, subnet is fd7a:629f:52a4:fe10::/64
Joined group address(es):
  ff02::1
  ff02::1:ff01:21e
  ff02::1:ff00:3
  ff01::2
switch>
```

12.2.4.40 show ipv6 nd ra internal state

The `ipv6 nd ra internal state` command displays the state of the IPv6 Router Advertisement (RA) daemon for the specified routable interface.

Command Mode

EXEC

Command Syntax

```
show ipv6 nd ra internal state [INTERFACE_NAME]
```

Parameters

- `INTERFACE_NAME` interfaces for which command displays status.
 - `<no parameter>` all routed interfaces.
 - `ethernet e_num` Ethernet interface specified by `e_num`.
 - `loopback l_num` Loopback interface specified by `l_num`.
 - `management m_num` Management interface specified by `m_num`.
 - `port-channel p_num` Port-Channel Interface specified by `p_num`.
 - `vlan v_num` VLAN interface specified by `v_num`.
 - `vxlan vx_num` VXLAN interface specified by `vx_num`.

Example

This command displays the IPv6 RA daemon for *VLAN interface 1243*.

```
switch>show ipv6 nd ra internal state vlan 1243
INTERFACE: Vlan3908
                ifindex : 0x00000021
                  mtu : 9212
                numIpv6Addr : 2
numPrefixToAdvertise : 0
numPrefixToSuppress : 0
                RaSuppress : 0
                RsRspSuppress : 0
raIntervalMaxMsec : 200000
raIntervalMinMsec : 0
managedConfigFlag : 0
  otherConfigFlag : 0
    raMtuSuppress : 0
      raLifetime : 1800
reacheableTime : 0
routerPreference : 0
      lastRaTime : 2012-05-01 09:22:57.020634
lastRsRspSentTime :
  nextTimeout : 171.474535 (sec)
raNotSentIntfNotReady : 0
      numRaSent : 219
      numRsRcvd : 0
numRsSuppressed : 0
      numRsRspSent : 0
numRsDroppedInvalidHopLimit : 0
numPktDroppedUnexpectedType : 0
      initialized : 1
switch>
```

12.2.4.41 show ipv6 neighbors

The **show ipv6 neighbors** command displays the IPv6 neighbor discovery cache. The command provides filters to restrict the list to a specified IPv6 address or routable interface.

Command Mode

EXEC

Command Syntax

```
show ipv6 neighbors [PORT][SOURCE][INFO_LEVEL]
```

Parameters

- PORT Filters by interface through which neighbor is accessed. Options include:
 - *<no parameter>* all routed interfaces.
 - *ethernet e_num* Ethernet interface specified by *e_num*.
 - *loopback l_num* Loopback interface specified by *l_num*.
 - *management m_num* Management interface specified by *m_num*.
 - *port-channel p_num* Port-channel interface specified by *p_num*.
 - *vlan v_num* VLAN interface specified by *v_num*.
 - *vxlan vx_num* VXLAN interface specified by *vx_num*.
- SOURCE Filters by neighbor IPv6 address. Options include:
 - *<no parameter>* all IPv6 neighbors.
 - *ipv6_addr* IPv6 address of individual neighbor.
- INFO_LEVEL amount of information that is displayed. Options include:
 - *<no parameter>* command displays the discovery cache for the specified interfaces.
 - *summary* command displays summary information only.

Example

This command displays the IPv6 neighbor discovery cache for IPv6 address *fe80::21c:73ff:fe01:5fe1*.

```
switch>show ipv6 neighbors fe80::21c:73ff:fe01:5fe1
IPv6 Address      Age  Hardware Addr      State Interface
fe80::21c:73ff:fe01:5fe1  0  001c.d147.8214  REACH Et12
fe80::21c:73ff:fe01:5fe1  0  001c.d147.8214  REACH Po999
fe80::21c:73ff:fe01:5fe1  0  001c.d147.8214  REACH V1102
fe80::21c:73ff:fe01:5fe1  0  001c.d147.8214  REACH V1103
fe80::21c:73ff:fe01:5fe1  0  001c.d147.8214  REACH V1205
fe80::21c:73ff:fe01:5fe1  0  001c.d147.8214  REACH V1207
fe80::21c:73ff:fe01:5fe1  0  001c.d147.8214  REACH V13901
fe80::21c:73ff:fe01:5fe1  0  001c.d147.8214  REACH V13902
fe80::21c:73ff:fe01:5fe1  0  001c.d147.8214  REACH V13903
fe80::21c:73ff:fe01:5fe1  0  001c.d147.8214  REACH V13904
fe80::21c:73ff:fe01:5fe1  0  001c.d147.8214  REACH V13905
fe80::21c:73ff:fe01:5fe1  0  001c.d147.8214  REACH V13996
```

12.2.4.42 show ipv6 route age

The **show ipv6 route age** command displays the IPv6 route age to the specified IPv6 address or prefix.

Command Mode

EXEC

Command Syntax

```
show ipv6 route ADDRESS age
```

Parameters

- **ADDRESS** filters routes by IPv6 address or prefix.
 - *ipv6_address* routing table entries matching specified address (A:B:C:D:E:F:G:H).
 - *ipv6_prefix* routing table entries matching specified IPv6 prefix (A:B:C:D:E:F:G:H/PL).

Example

This command displays the route age for the specified prefix.

```
switch>show ipv6 route 2001::3:0/11 age
IPv6 Routing Table - 74 entries
Codes: C - connected, S - static, K - kernel, O - OSPF, B - BGP, R - RIP,
A -
Aggregate

C 2001::3:0/11 age 00:02:34
switch>
```

12.2.4.43 show ipv6 route host

The **show ipv6 route host** command displays all host routes in the IPv6 host forwarding table. Host routes are those whose destination prefix is the entire address (prefix = /128). Each displayed host route is labeled with its purpose:

- **F** static routes from the FIB.
- **A** routes to any neighboring host for which the switch has an ARP entry.
- **R** routes defined because the IP address is an interface address.

Command Mode

EXEC

Command Syntax

```
show ipv6 route host
```

Example

This command displays all IPv6 host routes in the host forwarding table.

```
switch>show ipv6 route host
R - receive F - FIB, A - attached

F  ::1 to cpu
A  fee7:48a2:0c11:1900:400::1 on Vlan102
R  fee7:48a2:0c11:1900:400::2 to cpu
F  fee7:48a2:0c11:1a00::b via fe80::21c:73ff:fe0b:a80e on Vlan3902
R  fee7:48a2:0c11:1a00::17 to cpu
F  fee7:48a2:0c11:1a00::20 via fe80::21c:73ff:fe0b:33e on Vlan3913
F  fee7:48a2:0c11:1a00::22 via fe80::21c:73ff:fe01:5fe1 on Vlan3908
                               via fe80::21c:73ff:fe01:5fe1 on Vlan3902

switch>
```

12.2.4.44 show ipv6 route interface

The **show ipv6 route interface** command displays routing table entries on a specified routed port.

Command Mode

EXEC

Command Syntax

```
show ipv6 route [ADDRESS] interface PORT_NAME [INFO_LEVEL]
```

Parameters

ADDRESS, when present, is always listed first. All other parameters can be placed in any order.

- ADDRESS filters routes by IPv6 address or prefix.
 - *<no parameter>* all routing table entries.
 - *ipv6_address* routing table entries matching specified IPv6 address.
 - *ipv6_prefix* routing table entries matching specified IPv6 prefix (CIDR notation).
- PORT_NAME interfaces for which command displays status.
 - ethernet *e_num* Ethernet interface specified by *e_num*.
 - loopback *l_num* Loopback interface specified by *l_num*.
 - management *m_num* Management interface specified by *m_num*.
 - port-channel *p_num* Port-Channel Interface specified by *p_num*.
 - vlan *v_num* VLAN interface specified by *v_num*.
 - vxlan *vx_num* VXLAN interface specified by *vx_num*.
- INFO_LEVEL Filters entries by next hop connection.
 - *<no parameter>* filters routes whose next hops are directly connected.
 - detail displays all routes.

Example

This command displays the IPv6 routes in *VLAN interface 661*.

```
switch>show ipv6 route interface ethernet 8
IPv6 Routing Table - 77 entries
Codes: C - connected, S - static, K - kernel, O - OSPF, B - BGP, R - RIP,
A -
Aggregate

O   fd7a:629f:63af:1232::/64 [150/11]
    via fe80::823c:73ff:fe00:3640, Ethernet8
O   fd7a:629f:63af:4118::/64 [150/11]
    via fe80::823c:73ff:fe00:3640, Ethernet8
O   fd7a:629f:63af:4119::/64 [150/11]
    via fe80::823c:73ff:fe00:3640, Ethernet8
O   fd7a:629f:63af:411a::/64 [150/11]
    via fe80::823c:73ff:fe00:3640, Ethernet8
O   fd7a:629f:63af:fe78::/64 [150/11]
    via fe80::823c:73ff:fe00:3640, Ethernet8
C   fd7a:629f:63af:fe88::/64 [0/1]
    via ::, Ethernet12
O   fd7a:629f:63af:fe8c::/64 [10/20]
    via fe80::21c:73ff:fe00:3640, Ethernet8
C   fe80:0:40::/64 [0/1]
    via ::, Ethernet8
```

12.2.4.45 show ipv6 route match tag

The **show ipv6 route match tag** command displays the route tag assigned to the specified IPv6 address or prefix. Route tags are added to static routes for use by route maps.

Command Mode

EXEC

Command Syntax

```
show ipv6 route ADDRESS match tag
```

Parameters

- **ADDRESS** filters routes by IPv6 address or prefix.
 - *ipv6_address* routing table entries matching specified address (A:B:C:D:E:F:G:H)
 - *ipv6_prefix* routing table entries matching specified IPv6 prefix (A:B:C:D:E:F:G:H/PL).

Example

This command displays the route tag for the specified prefix.

```
switch>show ipv6 route 2001:0DB8::/64 match tag
IPv6 Routing Table - 74 entries
Codes: C - connected, S - static, K - kernel, O3 - OSPFv3, B - BGP, R -
RIP, A B
- BGP Aggregate, I L1 - IS-IS level 1, I L2 - IS-IS level 2, DH - DHCP,
NG -
NextHop Group Static Route, M - Martian, DP - Dynamic Policy Route, L -
VRF Leaked

C    2001:0DB8::/64 tag 0

switch>
```

12.2.4.46 show ipv6 route summary

The **show ipv6 route summary** command displays the information about the IPv6 routing table.

Command Mode

EXEC

Command Syntax

```
show ipv6 route summary
```

Example

This command displays the route source and the corresponding number of routes in the IPv6 routing table.

```
switch>show ipv6 route summary
Route Source      Number Of Routes
-----
connected         2
static            0
ospf              5
bgp               7
isis              0
internal          1
attached          0
aggregate         2

Total Routes      17
switch>
```

12.2.4.47 show ipv6 route

The **show ipv6 route** command displays IPv6 routing table entries that are in the Forwarding Information Base (FIB), including static routes, routes to directly connected networks, and dynamically learned routes. Multiple equal cost paths to the same prefix are displayed contiguously as a block, with the destination prefix displayed only on the first line.

The **show running-config** command displays all configured routes.

Command Mode

EXEC

Command Syntax

```
show ipv6 route [ADDRESS][ROUTE_TYPE][INFO_LEVEL]
```

Parameters

ADDRESS, when present, is always listed first. All other parameters can be placed in any order.

- ADDRESS filters routes by IPv6 address or prefix.
 - *<no parameter>* all routing table entries.
 - *ipv6_address* routing table entries matching specified IPv6 address.
 - *ipv6_prefix* routing table entries matching specified IPv6 prefix (CIDR notation).
- ROUTE_TYPE filters routes by specified protocol or origin.
 - *<no parameter>* all routing table entries.
 - *aggregate* entries for BGP aggregate routes.
 - *bgp* entries added through BGP protocol.
 - *connected* entries for routes to networks directly connected to the switch.
 - *kernel* entries appearing in Linux kernel but not added by EOS software.
 - *isis* entries added through IS-IS protocol.
 - *ospf* entries added through OSPF protocol.
 - *static* entries added through CLI commands.
- INFO_LEVEL Filters entries by next hop connection.
 - *<no parameter>* filters routes whose next hops are directly connected.
 - *detail* displays all routes.

Example

This command displays a route table entry for a specific IPv6 route.

```
switch>show ipv6 route fd7a:3418:52a4:fe18::/64
IPv6 Routing Table - 77 entries
Codes: C - connected, S - static, K - kernel, O - OSPF, B - BGP, R - RIP,
A -
Aggregate

O   fd7a:3418:52a4:fe18::/64 [10/20]
    via fe80::21c:73ff:fe00:1319, Vlan3601
    via fe80::21c:73ff:fe00:1319, Vlan3602
    via fe80::21c:73ff:fe00:1319, Vlan3608
    via fe80::21c:73ff:fe0f:6a80, Vlan3610
    via fe80::21c:73ff:fe00:1319, Vlan3611

switch>
```

12.2.4.48 show platform fap mroute ipv6

The **show platform fap mroute ipv6** command enables PIM Sparse Mode (PIM-SM) and IGMP (router mode) on the configuration mode interface.

Command Mode

EXEC

Command Syntax

```
show platform
```

Example

This command enables PIM sparse mode on VLAN 4 interface.

```
switch#show platform fap mroute ipv6
Jericho0 Multicast Routes:
-----
Location  GroupId Group          Source      IIF      McId      OIF
FLP/TT    FLP/TT  TT              FLP        FLP      FLP      FLP
-----
4096/2048 1/1      ff33::1:0:0:23/128 101:1::2/128  Vlan1357 21504    Vlan1044 (Et7/1)
Vlan1123 (Et9/1)
Vlan1223 (Et2/1)
Vlan1232 (Et3/1)
Vlan1337 (Et4/1)
Vlan1200 (Et8/1)
Vlan1226 (Et5/1)
Vlan1307 (Et6/1)
```

12.2.4.49 show rib route ipv6

The **show rib route ipv6** command displays a list of IPv6 Routing Information Base (RIB) routes.

Command Mode

EXEC

Command Syntax

```
show rib route ipv6 [vrf vrf_name] [PREFIX][ROUTE TYPE]
```

Parameters

- **vrf vrf_name** displays RIB routes from the specified VRF.
- **PREFIX** displays routes filtered by the specified IPv6 information. Options include:
 - **ipv6_address** displays RIB routes filtered by the specified IPv6 address.
 - **ipv6_subnet_mask** displays RIB routes filtered by the specified IPv6 address and subnet mask.
 - **ipv6_prefix** displays RIB routes filtered by the specified IPv6 prefix.
- **ROUTE TYPE** displays routes filtered by the specified route type. Options include:
 - **bgp** displays RIB routes filtered by BGP.
 - **connected** displays RIB routes filtered by connected routes.
 - **dynamicPolicy** displays RIB routes filtered by dynamic policy routes.
 - **host** displays RIB routes filtered by host routes.
 - **isis** displays RIB routes filtered by ISIS routes.
 - **ospf** displays RIB routes filtered by OSPF routes.
 - **ospf3** displays RIB routes filtered by OSPF3 routes.
 - **reserved** displays RIB routes filtered by reserved routes.
 - **route-input** displays RIB routes filtered by route-input routes.
 - **static** displays RIB routes filtered by static routes.

Examples

- This command displays IPv6 RIB BGP routes.

```
switch#show rib route ipv6 bgp
VRF name: default, VRF ID: 0xfe, Protocol: bgp
Codes: C - Connected, S - Static, P - Route Input
       B - BGP, O - Ospf, O3 - Ospf3, I - Isis
       > - Best Route, * - Unresolved Nexthop
       L - Part of a recursive route resolution loop
B      2001:10:1::/64 [200/42]
       via 2001:10:1::100 [0/1]
       via Ethernet1, directly connected
>B     2001:10:100::/64 [200/200]
       via 2001:10:1::100 [0/1]
       via Ethernet1, directly connected
>B     2001:10:100:1::/64 [200/0]
       via 2001:10:1::100 [0/1]
       via Ethernet1, directly connected
>B     2001:10:100:2::/64 [200/42]
       via 2001:10:1::100 [0/1]
       via Ethernet1, directly connected
switch#
```

- This command displays IPv6 RIB connected routes.

```
switch#show rib route ipv6 connected
VRF name: default, VRF ID: 0xfe, Protocol: connected
Codes: C - Connected, S - Static, P - Route Input
```

```

B - BGP, O - Ospf, O3 - Ospf3, I - Isis
> - Best Route, * - Unresolved Nexthop
L - Part of a recursive route resolution loop
>C 2001:10:1::/64 [0/1]
    via 2001:10:1::102, Ethernet1
>C 2001:10:2::/64 [0/1]
    via 2001:10:2::102, Ethernet2
>C 2001:10:3::/64 [0/1]
    via 2001:10:3::102, Ethernet3
switch#

```

12.3 Ingress and Egress Per-Port for IPv4 and IPv6 Counters

This feature provides support for per-interface ingress and egress packet and byte counters for both IPv4 and IPv6.

This section describes Ingress and Egress per-port for IPv4 and IPv6 counters, including configuration instructions and command descriptions. Topics covered by this chapter include:

- [Platform Compatability](#)
- [Configuration](#)
- [Show Commands](#)
- [Dedicated ARP Entry for TX IPv4 and IPv6 Counters](#)
- [Limitations](#)

12.3.1 Platform Compatability

Support for ingress and egress per-port for IPv4 and IPv6 counters is found on the following platforms:

- DCS-7280SR
- DCS-7280CR
- DCS-7500-R
- DCS-7300X
- DCS-7250X
- DCS-7050X
- DCS-7060X



Note: This feature is platform specific, packet versus bytes distinction, and the ability to count routed packets only (as opposed to counting all IPv4/v6 traffic: routed or bridged). Consult your systems engineer to check if a particular combination is supported.

12.3.2 Configuration

IPv4 and IPv6 ingress counters (count **bridged and routed** traffic, supported only on front-panel ports) can be enabled and disabled using the **hardware counter feature ip in** command:

```
[no] hardware counter feature ip in
```

For IPv4 and IPv6 ingress and egress counters that include only **routed** traffic (supported on Layer3 interfaces such as routed ports, L3 subinterfaces only):

On the DCS-7300X, DCS-7250X, DCS-7050X, and DCS-7060X platforms, IPv4 and IPv6 **packet** counters for only **routed** traffic do not require any configuration. They are collected by default. Other platforms (DCS-7280SR, DCS-7280CR and DCS-7500-R) need the feature enabled.

```
[no]hardware counter feature ip in layer3
```

```
[no]hardware counter feature ip out layer3
```

12.3.3 Show Commands

Use the `show interfaces counters ip` command to display IPv4, IPv6 packets, and octets.

```
switch#show interfaces counters ip
Interface  IPv4InOctets  IPv4InPkts  IPv6InOctets
 IPv6InPkts
Et1/1      0              0            0
0
Et1/2      0              0            0
0
Et1/3      0              0            0
0
Et1/4      0              0            0
0
...
Interface  IPv4OutOctets  IPv4OutPkts  IPv6OutOctets
 IPv6OutPkts
Et1/1      0              0            0
0
Et1/2      0              0            0
0
Et1/3      0              0            0
0
Et1/4      0              0            0
0
...
```

The output from the `show interfaces counters ip` can also be queried through SNMP via the ARISTA-IP-MIB.

To clear the the IPv4 or IPv6 counters, use the `clear counters` command

```
switch#clear counters
```

12.3.4 Dedicated ARP Entry for TX IPv4 and IPv6 Counters

IPv4/IPv6 egress Layer 3 (`hardware counter feature ip out layer3`) counting on DCS-7280SR, DCS-7280CR and DCS-7500-R platforms work, based on ARP entry of the nexthop. By default, IPv4 next hop and IPv6 next hop both resolve to the same MAC address and interface that have shared ARP entry. To differentiate the counters between IPv4 and IPv6, disable arp entry sharing with following command:

```
ip hardware fib next-hop arp dedicated
```

On the DCS-7280SR, DCS-7280CR and DCS-7500-R platforms, this command is required for IPv4 and IPv6 egress counters to operate.

12.3.5 Limitations

- Packet sizes greater than 9236 bytes are not counted by per-port IPv4 and IPv6 counters.
- Only the DCS-7260X3, DCS-7368, DCS-7300, DCS-7050SX3, DCS-7050CX3, DCS-7280SR, DCS-7280CR and DCS-7500-R platforms support the **hardware counter feature ip in** command.
- Only the DCS-7280SR, DCS-7280CR and DCS-7500-R platforms support the **hardware counter feature ip [in|out] layer3** command.

12.4 ACLs and Route Maps

The switch uses rule-based lists to control packet access to ports and to select routes for redistribution to routing domains defined by dynamic routing protocols. This section describes the construction of access control lists (ACLs), prefix lists, and route maps.

This section includes the following topics:

- [ACL, Service ACL, Route Map, Prefix List, and RACL Divergence Introduction](#)
- [Access Control Lists](#)
- [Service ACLs](#)
- [RACL Sharing on SVIs](#)
- [Route Maps](#)
- [Prefix Lists](#)
- [Port ACLs with User-Defined Fields](#)
- [ACL, Route Map, and Prefix List Commands](#)

12.4.1 ACL, Service ACL, Route Map, Prefix List, and RACL Divergence Introduction

Access control lists (ACLs), Service ACLs, route maps, and prefix lists are all processed in order, beginning with the first rule and proceeding until a match is encountered.

An access control list (ACL) is a list of rules that control the inbound flow of packets into Ethernet interfaces, subinterfaces, and port channel interfaces or the switch control plane. The switch supports the implementation of a wide variety of filtering criteria including IP and MAC addresses, TCP/UDP ports with include/exclude options without compromising its performance or feature set. Filtering syntax is industry standard.

A Service ACL is an ACL applied by a control-plane process to control connections to, or packets processed by, the agent process.

A route map is a list of rules that control the redistribution of IP routes into a protocol domain on the basis of such criteria as route metrics, access control lists, next hop addresses, and route tags. Route maps can also alter parameters of routes as they are redistributed.

A prefix list is a list of rules that defines route redistribution access for a specified IP address space. Route maps often use prefix lists to filter routes.

The RACL divergence optimizes the usage of hardware resources occupied on each forwarding ASIC by installing ACLs only on the hardware components corresponding to the member interfaces belonging to the SVIs on which ACL is applied. Hence, saving the hardware resources used and

enables RACLs to scale-up to a larger configuration. The show commands are used to display the interface mapping, TCAM entries, and TCAM utilization information.

12.4.2 Access Control Lists

These sections describe access control lists:

- [ACL Description](#)
- [ACL Configuration](#)
- [Applying ACLs](#)

12.4.2.1 ACL Description

This section describes ACL composition and function. The switch supports the following ACL types:

- IPv4
- IPv6
- Standard IPv4
- Standard IPv6
- MAC

12.4.2.1.1 ACL Structure

An ACL is an ordered list of rules that defines access restrictions for the entities (the control plane, or an interface) to which it is applied. ACLs are also used by route maps to select routes for redistribution into specified routing domains.

ACL rules specify the data to which packet contents are compared when filtering data.

- The interface forwards packets that match all commands in a permit rule.
- The interface drops packets that match all commands in a deny rule.
- The interface drops packets that do not match at least one rule.

Upon its arrival at an interface, a packet's fields are compared to the first rule of the ACL applied to the interface. Packets that match the rule are forwarded (permit rule) or dropped (deny rule). Packets that do not match the rule are compared to the next rule in the list. This process continues until the packet either matches a rule or the rule list is exhausted. The interface drops packets not matching a rule.

The sequence number designates the rule's placement in the ACL.

12.4.2.1.2 ACL Rules

ACL rules consist of a command list that is compared to inbound packet fields. When all of a rule's criteria match a packet's contents, the interface performs the action specified by the rule.

The set of available commands depend on the ACL type and the specified protocol within the rule. The following is a list of commands available for supported ACL types

IPv4 ACL Rule Parameters

All rules in IPv4 ACLs include the following criteria:

- **Protocol:** The packet's IP protocol. Valid rule inputs include:
 - Protocol name for a limited set of common protocols.
 - Assigned protocol number for all IP protocols.

- **Source Address:** The packet's source IPv4 address. Valid rule inputs include:
 - a subnet address (CIDR or address-mask). Discontiguous masks are supported.
 - a host IP address (dotted decimal notation).
 - *any* to denote that the rule matches all source addresses.
- **Destination Address:** The packet's destination IP address. Valid rule inputs include:
 - a subnet address (CIDR or address-mask). Discontiguous masks are supported.
 - a host IP address (dotted decimal notation).
 - *any* to denote that the rule matches all destination addresses.

All rules in IPv4 ACLs **may** include the following criteria:

- **Fragment:** Rules filter on the fragment bit.
- **Time-to-live:** Compares the TTL (time-to-live) value in the packet to a specified value. Valid in ACLs applied to the control plane. Validity in ACLs applied to the data plane varies by switch platform. Comparison options include:
 - Equal: Packets match if packet value equals statement value.
 - Greater than: Packets match if packet value is greater than statement value.
 - Less than: Packets match if packet value is less than statement value.
 - Not equal: Packets match if packet value does not equal statement value.

The availability of the following optional criteria depends on the specified protocol:

- **Source Ports / Destination Ports:** A rule filters on ports when the specified protocol supports IP address-port combinations. Rules provide one of these port filtering values:
 - ***any*** denotes that the rule matches all ports.
 - A list of ports that matches the packet port. Maximum list size is 10 ports.
 - Negative port list. The rule matches any port not in the list. Maximum list size is 10 ports.
 - Integer (lower bound): The rule matches any port with a number larger than the integer.
 - Integer (upper bound): The rule matches any port with a number smaller than the integer.
 - Range integers: The rule matches any port whose number is between the integers.
- **Flag bits:** Rules filter TCP packets on flag bits.
- **Message type:** Rules filter ICMP type or code.
- **Tracked:** Matches packets in existing ICMP, UDP, or TCP connections. Valid in ACLs applied to the control plane. Validity in ACLs applied to the data plane varies by switch platform.

IPv6 ACL Rule Parameters

 **Note:** When calculating the size of ACLs, be aware that Arista switches install four rules in every IPv6 ACL so that ICMPv6 neighbor discovery packets bypass the default drop rule.

All rules in IPv6 ACLs include the following criteria:

- **Protocol:** All rules filter on the packet's IP protocol field. Rule input options include:
 - Protocol name for a limited set of common protocols.
 - Assigned protocol number for all IP protocols.
- **Source Address:** The packet's source IPv6 address. Valid rule inputs include:
 - an IPv6 prefix (CIDR). Discontiguous masks are supported.
 - a host IP address (dotted decimal notation).
 - ***any*** to denote that the rule matches all addresses.
- **Destination Address:** The packet's destination IP address. Valid rule inputs include:
 - a subnet address (CIDR or address-mask). Discontiguous masks are supported.
 - a host IP address (dotted decimal notation).
 - ***any*** to denote that the rule matches all addresses.

All rules in IPv6 ACLs *may* include the following criteria:

- **Fragment:** Rules filter on the fragment bit.
- **HOP** Compares the packet's hop-limit value to a specified value. Comparison options include:
 - Equal: Packets match if packet value equals statement value.

The availability of the following optional criteria depends on the specified protocol:

- **Source Ports / Destination Ports:** A rule filters on ports when the specified protocol supports IP address-port combinations. Rules provide one of these port filtering values:
 - **any** denotes that the rule matches all ports.
 - A list of ports that matches the packet port. Maximum list size is 10 ports.
 - Negative port list. The rule matches any port not in the list. Maximum list size is 10 ports.
 - Integer (lower bound): The rule matches any port with a number larger than the integer.
 - Integer (upper bound): The rule matches any port with a number smaller than the integer.
 - Range integers: The rule matches any port whose number is between the integers.
- **Flag bits:** Rules filter TCP packets on flag bits.
- **Message type:** Rules filter ICMP type or code.
- **Tracked:** Matches packets in existing ICMP, UDP, or TCP connections. Valid in ACLs applied to the control plane. Validity in ACLs applied to the data plane varies by switch platform.

Standard IPv4 and IPv6 ACL Rule Parameters



Note: When calculating the size of ACLs, be aware that Arista switches install four rules in every IPv6 ACL so that ICMPv6 neighbor discovery packets bypass the default drop rule.

Standard ACLs filter only on the source address.

MAC ACL Rule Parameters

MAC ACLs filter traffic on a packet's layer 2 header. Criteria that MAC ACLs use to filter packets include:

- **Source Address and Mask:** The packet's source MAC address. Valid rule inputs include:
 - MAC address range (address-mask in 3x4 dotted hexadecimal notation).
 - **any** to denote that the rule matches all source addresses.
- **Destination Address and Mask:** The packet's destination MAC address. Valid rule inputs include:
 - MAC address range (address-mask in 3x4 dotted hexadecimal notation).
 - **any** to denote that the rule matches all destination addresses.
- **Protocol:** The packet's protocol as specified by its EtherType field contents. Valid inputs include:
 - Protocol name for a limited set of common protocols.
 - Assigned protocol number for all protocols.

12.4.2.1.3 Creating and Modifying Lists

The switch provides configuration modes for creating and modifying ACLs. The command that enters an ACL configuration mode specifies the name of the list that the mode modifies. The switch saves the list to the running configuration when the configuration mode is exited.

- ACLs are created and modified in ACL configuration mode.
- Standard ACLs are created and modified in Standard-ACL-configuration mode.
- MAC ACLs are created and modified in MAC-ACL-configuration mode.

Lists that are created in one mode cannot be modified in any other mode.

A sequence number designates the rule's placement in a list. New rules are inserted into a list according to their sequence numbers. A rule's sequence number can be referenced when deleting it from a list.

[ACL Configuration](#) describes procedures for configuring ACLs.

12.4.2.1.4 Implementing Access Control Lists

An access control list (ACL) is implemented by assigning the list to an Ethernet interface or subinterface, to a port channel interface, or to the control plane. The switch assigns a default ACL to the control plane unless the configuration contains a valid control-plane ACL assignment statement. Ethernet and port channel interfaces are not assigned an ACL by default. Standard ACLs are applied to interfaces in the same manner as other ACLs.

IPv4 and MAC ACLs are separately applied for inbound and outbound packets. An interface or subinterface can be assigned multiple ACLs, with a limit of one ACL per packet direction per ACL type. Egress ACLs are supported on a subset of all available switches. The control-plane does not support egress ACLs.

[Applying ACLs](#) describes procedures for applying ACLs to interfaces or the control plane.

12.4.2.1.5 ACL Rule Tracking

ACL rule tracking determines the impact of ACL rules on the traffic accessing interfaces upon which they are applied. ACLs provide two tracking mechanisms:

- ACL logging: A syslog entry is logged when a packet matches specified ACL rules.
- ACL counters: ACL counters increment when a packet matches a rule in specified ACLs.

ACL Logging

ACL rules provide a **log** option that produces a log message when a packet matches the rule. ACL logging creates a syslog entry when a packet matches an ACL rule where logging is enabled. Packets that match a logging-enabled ACL rule are copied to the CPU by the hardware. These packets trigger the creation of a syslog entry. The information provided in the entry depends on the ACL type or the protocol specified by the ACL. Hardware rate limiting is applied to packets written to the CPU, avoiding potential DoS attacks. The rate of logging is also software limited to avoid the creation of syslog lists that are too large for practical use by human operators.

[ACL Rule Tracking Configuration](#) describes procedures for configuring and enabling ACL logging.

ACL Counters

An ACL counter is assigned to each ACL rule. The activity of the ACL counters for rules within a list depend on the list's counter state. When the list is in counting state, the ACL counter of a rule increments when the rule matches a packet. When the list is in a non-counting state, the counter does not increment. A list's counter state applies to all rules in the ACL. The default state for new ACLs is non-counting.

When an ACL changes from counting state to non-counting state, or when the ACL is no longer applied to any interfaces that increment counters, counters for all rules in the list maintain their values and do not reset. When the ACL returns to counting mode or is applied to an interface that increments counters, the counter operation resumes from its most recent value.

Counters never decrement and are reset only through CLI commands.

[ACL Rule Tracking Configuration](#) describes procedures for configuring and enabling ACL counters.

12.4.2.1.6 AlgoMatch

AlgoMatch enables more flexible and scalable solutions for access control, telemetry, and enforcement networking whether the requirements are an on-premises or hybrid cloud model. By combining power-efficient and low-cost general purpose memory technology with advanced software algorithms, AlgoMatch provides greater scale, performance, and efficiency compared to common standard implementations with merchant silicon systems and TCAM.

In a typical TCAM solution, as additional lookup capacity is added, the power increases in-line with the scale. AlgoMatch utilizes power-efficient searching, only checking locations needed, and as a result lowers power draw by as much as half compared to TCAMs.

AlgoMatch utilizes a flexible and efficient packet matching algorithm with variable lookup sizes, rather than a fixed size lookup with TCAM. This enables full flow matching against source and destination criteria, or parts of the mask, and allows for multiple actions to be performed on a single packet or flow, with user defined filters for packet classification and custom actions in a single pass. A policy with multiple actions is not typically possible with a TCAM solution without using recirculation of chained lookups. However, with AlgoMatch, multiple actions can be applied in a single pass (For example, access control, telemetry, and counters) without losing either features or performance.

AlgoMatch Benefits

- Improved power efficiency: 50 percentage lower.
- Efficient Layer 4 rules: allows enhanced security policy.
- Counters: provide better visibility and flow filtering.



Note: AlgoMatch configuration and show commands are no different from security ACLs. For more information on ACL commands refer [ACL, Route Map, and Prefix List Commands](#).

12.4.2.2 ACL Configuration

Access control lists are created and modified in an ACL-configuration mode. A list can be edited only in the mode where it was created. The switch provides five configuration modes for creating and modifying access control lists:

- **ACL configuration mode** for IPv4 access control lists.
- **IPv6-ACL configuration mode** for IPv6 access control lists.
- **Std-ACL configuration mode** for Standard IPv4 access control lists.
- **Std-IPv6-ACL configuration mode** for Standard IPv6 access control lists.
- **MAC-ACL configuration mode** for MAC access control lists.

These sections describe the creation and modification of ACLs:

- [Managing ACLs](#)
- [Modifying an ACL](#)
- [ACL Rule Tracking Configuration](#)
- [Displaying ACLs](#)
- [Configuring Per-Port Per-VLAN QoS](#)
- [Displaying Per-Port Per-VLAN QoS](#)
- [On DCS-7010, DCS-7050X, DCS7250X, DCS-7300X series switches](#)
- [On DCS-7280\(E/R\), DCS7500\(E/R\) series switches](#)
- [Configuring Mirror Access Control Lists](#)

12.4.2.2.1 Managing ACLs

Creating and Opening a List

To create an ACL, enter one of the following commands, followed by the name of the list:

- [ip access-list](#) for IPv4 ACLs.
- [ipv6 access-list](#) for IPv6 ACLs.
- [ip access-list standard](#) for standard IPv4 ACLs.
- [ipv6 access-list standard](#) for standard IPv6 ACLs.
- [mac access-list](#) for MAC ACLs.

The switch enters the appropriate ACL configuration mode for the list. If the command is followed by the name of an existing ACL, subsequent commands edit that list (see [Modifying an ACL](#) for additional information).

Examples

- This command places the switch in ACL configuration mode to create an ACL named test1.

```
switch(config)#ip access-list test1
switch(config-acl-test1)#
```

- This command places the switch in Standard-ACL-configuration mode to create a Standard ACL named stest1.

```
switch(config)#ip access-list standard stest1
switch(config-std-acl-stest1)#
```

- This command places the switch in MAC-ACL configuration mode to create an MAC ACL named mtest1.

```
switch(config)#mac access-list mtest1
switch(config-mac-acl-mtest1)#
```

Saving List Modifications

ACL configuration modes are group-change modes. Changes made in a group-change mode are saved by exiting the mode. To exit the group-change mode, changes can also be discarded using the `abort` command instead of exit.

Example

- These commands enter the first three rules into a new ACL.

```
switch(config-acl-test1)#permit ip 10.10.10.0/24 any
switch(config-acl-test1)#permit ip any host 10.20.10.1
switch(config-acl-test1)#deny ip host 10.10.10.1 host 10.20.10.1
```

To view the edited list, type **show**.

```
switch(config-acl-test1)#show
IP Access List test1
 10 permit ip 10.10.10.0/24 any
 20 permit ip 10.30.10.0/24 host 10.20.10.1
 30 deny ip host 10.10.10.1 host 10.20.10.1
 40 permit ip any any
```

Because the changes were not yet saved, the ACL remains empty, as shown by [show ip access-lists](#).

```
switch(config-acl-test1)#show ip access-lists test1
switch(config-acl-test1)#
```

To save all current changes to the ACL and exit ACL configuration mode, type **exit**.

```
switch(config-acl-test1)#exit
switch(config)#show ip access-lists test1
IP Access List test1
 10 permit ip 10.10.10.0/24 any
 20 permit ip 10.30.10.0/24 host 10.20.10.1
 30 deny ip host 10.10.10.1 host 10.20.10.1
 40 permit ip any any
```

Discarding List Changes

The **abort** command exits ACL configuration mode without saving pending changes.

Example

- These commands enter the first three rules into a new ACL.

```
switch(config-acl-test1)#permit ip 10.10.10.0/24 any
switch(config-acl-test1)#permit ip any host 10.20.10.1
switch(config-acl-test1)#deny ip host 10.10.10.1 host 10.20.10.1
```

To view the edited list, type **show**.

```
switch(config-acl-test1)#show
IP Access List test1
 10 permit ip 10.10.10.0/24 any
 20 permit ip 10.30.10.0/24 host 10.20.10.1
 30 deny ip host 10.10.10.1 host 10.20.10.1
 40 permit ip any any
```

To discard the changes, enter **abort**. If the ACL existed before entering ACL-configuration mode, **abort** restores the version that existed before entering ACL-configuration mode. Otherwise, [show ip access-lists](#) shows the ACL was not created.

```
switch(config-acl-test1)#abort
switch(config)#
```

12.4.2.2.2 Modifying an ACL

An existing ACL, including those currently applied to interfaces, can be modified by entering the appropriate configuration mode for the ACL as described in [Creating and Opening a List](#). By default, while an ACL is being modified all traffic is blocked on any interface to which the ACL has been applied.

Permit All Traffic During ACL Update

Because blocking ports during ACL modifications can result in packet loss and can interfere with features such as routing and dynamic NAT, 7050X, 7060X, 7150, 7250X, 7280, 7280R, 7300X, 7320X, and 7500 series switches can be configured instead to permit all traffic on Ethernet and VLAN interfaces while ACLs applied to those interfaces are being modified. This is done with the [hardware access-list update default-result permit](#) command.

These commands add deny rules to the appropriate ACL:

- [deny \(IPv4 ACL\)](#) adds a deny rule to an IPv4 ACL.
- [deny \(IPv6 ACL\)](#) adds a deny rule to an IPv6 ACL.
- [deny \(Standard IPv4 ACL\)](#) adds a deny rule to an IPv4 standard ACL.
- [deny \(Standard IPv6 ACL\)](#) adds a deny rule to an IPv6 standard ACL.

- [deny \(MAC ACL\)](#) adds a deny rule to a MAC ACL.

These commands add permit rules to the appropriate ACL:

- [permit \(IPv4 ACL\)](#) adds a permit rule to an IPv4 ACL.
- [permit \(IPv6 ACL\)](#) adds a permit rule to an IPv6 ACL.
- [permit \(Standard IPv4 ACL\)](#) adds a permit rule to an IPv4 standard ACL.
- [permit \(Standard IPv6 ACL\)](#) adds a permit rule to an IPv6 standard ACL.
- [permit \(MAC ACL\)](#) adds a permit rule to a MAC ACL.

Adding a Rule

To append a rule to the end of a list, enter the rule without a sequence number while in ACL configuration mode for the list. The new rule's sequence number is derived by adding 10 to the last rule's sequence number.

Examples

- This command configures the switch to permit all traffic during ACL modifications on interfaces to which the ACL has been applied. The rules in modified ACLs are applied after exiting ACL configuration mode, and after the ACL rules have been populated in hardware.

```
switch(config)#hardware access-list update default-result permit
```

- These commands enter the first three rules into a new ACL.

```
switch(config-acl-test1)#permit ip 10.10.10.0/24 any
switch(config-acl-test1)#permit ip any host 10.20.10.1
switch(config-acl-test1)#deny ip host 10.10.10.1 host 10.20.10.1
```

To view the edited list, type **show**.

```
switch(config-acl-test1)#show
IP Access List test1
    10 permit ip 10.10.10.0/24 any
    20 permit ip any host 10.20.10.1
    30 deny ip host 10.10.10.1 host 10.20.10.1
```

- This command appends a rule to the ACL. The new rule's sequence number is 40.

```
switch(config-acl-test1)#permit ip any any
switch(config-acl-test1)#show
IP Access List test1
    10 permit ip 10.10.10.0/24 any
    20 permit ip any host 10.20.10.1
    30 deny ip host 10.10.10.1 host 10.20.10.1
    40 permit ip any any
```

Inserting a Rule

To insert a rule into a ACL, enter the rule with a sequence number between the existing rules' numbers.

Example

This command inserts a rule between the first two rules by assigning it the sequence number 15.

```
Switch(config-acl-test1)#15 permit ip 10.30.10.0/24 host 10.20.10.1
Switch(config-acl-test1)#show
IP Access List test1
```

```

10 permit ip 10.10.10.0/24 any
15 permit ip 10.30.10.0/24 host 10.20.10.1
20 permit ip any host 10.20.10.1
30 deny ip host 10.10.10.1 host 10.20.10.1
40 permit ip any any

```

Deleting a Rule

To remove a rule from the current ACL, perform one of these commands:

- Enter **no**, followed by the sequence number of the rule to be deleted.
- Enter **no**, followed by the rule to be deleted.
- Enter **default**, followed by the rule to be deleted.

Examples

- These equivalent commands remove rule 20 from the list.

```

switch(config-acl-test1)#no 20
switch(config-acl-test1)#no permit ip any host 10.20.10.1
switch(config-acl-test1)#default permit ip any host 10.20.10.1

```

- This ACL results from entering one of the preceding commands.

```

switch(config-acl-test1)#show
ip access list test1
    10 permit ip 10.10.10.0/24 any
    15 permit ip 10.30.10.0/24 host 10.20.10.1
    30 deny ip host 10.10.10.1 host 10.20.10.1
    40 permit ip any any

```

Resequencing Rule Numbers

Sequence numbers determine the order of the rules in an access control list. After a list editing session where existing rules are deleted and new rules are inserted between existing rules, the sequence number distribution may not be uniform. Resequencing rule numbers changes the sequence number of rules to provide a constant difference between adjacent rules. The [resequence \(ACLs\)](#) command adjusts the sequence numbers of ACL rules.

Example

The **resequence** command renumbers rules in the test1 ACL. The sequence number of the first rule is 100; subsequent rules numbers are incremented by 20.

```

switch(config-acl-test1)#show
IP Access List test1
    10 permit ip 10.10.10.0/24 any
    25 permit ip any host 10.20.10.1
    30 deny ip host 10.10.10.1 host 10.20.10.1
    50 permit ip any any
    90 remark end of list
switch(config-acl-test1)#resequence 100 20
switch(config-acl-test1)#show
IP Access List test1
    100 permit ip 10.10.10.0/24 any
    120 permit ip any host 10.20.10.1
    140 deny ip host 10.10.10.1 host 10.20.10.1
    160 permit ip any any
    180 remark end of list

```

12.4.2.2.3 ACL Rule Tracking Configuration

ACL rules provide a **log** option that produces a syslog message about the packets matching packet. ACL logging creates a syslog entry when a packet matches an ACL rule with logging enabled.

This feature is currently available on Arad switches and on 7100 series switches. On 7100 series switches, matches are logged only on ingress, not on egress.

Example

- This command creates an ACL rule with logging enabled.

```
switch(config-acl-test1)#15 permit ip 10.30.10.0/24 host 10.20.10.1 log
switch(config-acl-test1)#
```

The format of the generated syslog message depends on the ACL type and the specified protocol:

- Messages generated by a TCP or UDP packet matching an IP ACL use this format:

IPACCESS: list *acl intf filter protocol src-ip(src_port) -> dst-ip(dst_port)*

- Messages generated by ICMP packets matching an IP ACL use this format:

IPACCESS: list *acl intf filter icmp src-ip(src-port) -> dst-ip(dst-port) type= n code= m*

- Messages generated by all other IP packets matching an IP ACL use this format:

IPACCESS: list *acl intf filter protocol src-ip -> dst-ip*

- Messages generated by packets matching a MAC ACL use this format:

MACACCESS: list *acl intf filter vlan ether src_mac -> dst_mac*

- Messages generated by a TCP or UDP packet matching a MAC ACL use this format:

MACACCESS: list *acl intf filter vlan ether ip-prt src-mac src-ip : src-prt -> dst-mac dst-ip : dst-prt*

- Messages generated by any other IP packet matching a MAC ACL use this format:

MACACCESS: list *acl intf filter vlan ether src_mac src_ip -> dst_mac dst_ip*

Variables in the syslog messages display the following values:

- *acl* Name of ACL.
- *intf* Name of interface that received the packet.
- *filter* Action triggered by ACL (**denied** or **permitted**).
- *protocol* IP protocol specified by packet.
- *vlan* Number of VLAN receiving packet.
- *ether* EtherType protocol specified by packet.
- *src-ip* and *dst-ip* source and destination IP addresses.
- *src-prt* and *dst-prt* source and destination ports.
- *src-mac* and *dst-mac* source and destination MAC addresses.

ACLs provide a command that configures its counter state (counting or non-counting). The counter state applies to all rules in the ACL. The initial state for new ACLs is non-counting.

The [counters per-entry \(ACL configuration modes\)](#) command places the ACL in counting mode.

- This command places the configuration mode ACL in counting mode.

```
switch(config-acl-test1)#counters per-entry
switch(config-acl-test1)#exit
switch(config-acl-test1)#show ip access-list test1
IP Access List test1
```



```

counters per-entry
10 permit ip 10.10.10.0/24 any
20 permit ip any host 10.20.10.1
30 deny ip host 10.10.10.1 host 10.20.10.1
40 permit ip any any
50 remark end of list

```

The `clear ip access-lists counters` and `clear ipv6 access-lists counters` commands set the IP access list counters to zero for the specified IP access list.

- This command clears the ACL counter for the test1 ACL.

```

switch(config)#clear ip access-lists counters test1
switch(config)#

```

12.4.2.2.4 Displaying ACLs

ACLs can be displayed by a `show running-config` command. The `show ip access-lists` also displays ACL rosters and contents, as specified by command parameters.

When editing an ACL, the `show (ACL configuration modes)` command displays the current or pending list, as specified by command parameters.

Displaying a List of ACLs

To display the roster of ACLs on the switch, enter `show ip access-lists` with the **summary** option.

Example

- This command lists the available access control lists.

```

switch(config)#show ip access-list summary
IPV4 ACL default-control-plane-acl
    Total rules configured: 12
    Configured on: control-plane
    Active on      : control-plane

IPV4 ACL list2
    Total rules configured: 3

IPV4 ACL test1
    Total rules configured: 6

IPV4 ACL test_1
    Total rules configured: 1

IPV4 ACL test_3
    Total rules configured: 0
switch(config)#

```

Displaying Contents of an ACL

These commands display ACL contents.

- `show ip access-lists`
- `show ipv6 access-lists`
- `show mac access-lists`

Each command can display the contents of one ACL or of all ACLs of the type specified by the command:

- To display the contents of one ACL, enter `show ip access-lists` followed by the name of the ACL.
- To display the contents of all ACLs on the switch, enter the command without any options.

ACLs that are in counting mode display the number of inbound packets each rule in the list matched and the elapsed time since the last match.

Examples

- This command displays the rules in the default-control-plane-acl ACL.

```
switch#show ip access-lists default-control-plane-acl
IP Access List default-control-plane-acl [readonly]
  counters per-entry
  10 permit icmp any any
  20 permit ip any any tracked [match 1725, 0:00:00 ago]
  30 permit ospf any any
  40 permit tcp any any eq ssh telnet www snmp bgp https
  50 permit udp any any eq bootps bootpc snmp [match 993, 0:00:29
ago]
  60 permit tcp any any eq mlag ttl eq 255
  70 permit udp any any eq mlag ttl eq 255
  80 permit vrrp any any
  90 permit ahp any any
  100 permit pim any any
  110 permit igmp any any [match 1316, 0:00:23 ago]
  120 permit tcp any any range 5900 5910
```

- This command displays the rules in all ACLs on the switch.

```
switch#show ip access-lists
IP Access List default-control-plane-acl [readonly]
  counters per-entry
  10 permit icmp any any
  20 permit ip any any tracked [match 1371, 0:00:00 ago]
  30 permit ospf any any
  40 permit tcp any any eq ssh telnet www snmp bgp https
  50 permit udp any any eq bootps bootpc snmp
  60 permit tcp any any eq mlag ttl eq 255
  70 permit udp any any eq mlag ttl eq 255
  80 permit vrrp any any
  90 permit ahp any any
  100 permit pim any any
  110 permit igmp any any [match 1316, 0:00:23 ago]
  120 permit tcp any any range 5900 5910

IP Access List list2
  10 permit ip 10.10.10.0/24 any
  20 permit ip 10.30.10.0/24 host 10.20.10.1
  30 permit ip any host 10.20.10.1
  40 deny ip host 10.10.10.1 host 10.20.10.1
  50 permit ip any any

IP Access List test1
Switch(config)#
```

Displaying ACL Modifications

While editing an ACL in ACL-configuration mode, the `show (ACL configuration modes)` command provides options for displaying ACL contents.

- To display the list, as modified in ACL configuration mode, enter `show` or `show pending`.
- To display the list, as stored in *running-config*, enter `show active`.

- To display differences between the pending list and the stored list, enter **show diff**.

Examples

The examples in this section assume these ACL commands were previously entered.

These commands are stored in the configuration:

```
10 permit ip 10.10.10.0/24 any
20 permit ip any host 10.21.10.1
30 deny ip host 10.10.10.1 host 10.20.10.1
40 permit ip any any
50 remark end of list
```

The current edit session removed this command. This change is not yet stored to running-config:

```
20 permit ip any host 10.21.10.1
```

The current edit session added these commands ACL. They are not yet stored to running-config:

```
20 permit ip 10.10.0.0/16 any
25 permit tcp 10.10.20.0/24 any
45 deny pim 239.24.124.0/24 10.5.8.4/30
```

This command displays the pending ACL, as modified in ACL configuration mode.

```
switch(config-acl-test_1)#show pending
IP Access List test_1
 10 permit ip 10.10.10.0/24 any
 20 permit ip 10.10.0.0/16 any
 25 permit tcp 10.10.20.0/24 any
 30 deny ip host 10.10.10.1 host 10.20.10.1
 40 permit ip any any
 45 deny pim 239.24.124.0/24 10.5.8.4/30
 50 remark end of list
```

This command displays the ACL, as stored in the configuration.

```
switch(config-acl-test_1)#show active
IP Access List test_1
 10 permit ip 10.10.10.0/24 any
 20 permit ip any host 10.21.10.1
 30 deny ip host 10.10.10.1 host 10.20.10.1
 40 permit ip any any
 50 remark end of list
```

This command displays the difference between the saved and modified ACLs.

- Rules added to the pending list are denoted with a plus sign (+).
- Rules removed from the saved list are denoted with a minus sign (-).

```
switch(config-acl-test_1)#show diff
---
+++
@@ -1,7 +1,9 @@
  IP Access List test_1
    10 permit ip 10.10.10.0/24 any
-   20 permit ip any host 10.21.10.1
+   20 permit ip 10.10.0.0/16 any
+   25 permit tcp 10.10.20.0/24 any
    30 deny ip host 10.10.10.1 host 10.20.10.1
```

```
40 permit ip any any
+ 45 deny pim 239.24.124.0/24 10.5.8.4/30
```

12.4.2.2.5 Configuring Per-Port Per-VLAN QoS

To configure per-port per-VLAN QoS, first, configure the ACL policing for QoS, and then apply the policy-map on a single Ethernet or port-channel interfaces on a per-port per-VLAN basis. The per port per VLAN QoS allows a class-map to match traffic for a single VLAN or for a range of VLANs separated by commas. Per-port per-VLAN works with QoS-based class-maps only.

Platform Compatibility

- DCS-7010T
- DCS-7050X
- DCS-7250X
- DCS-7250X
- DCS-7280R
- DCS-7300X
- DCS-7320X
- DCS-7500R

To configure per-port per-VLAN QoS on DCS-7280(R) and DCS-7500(R), change the TCAM profile to QoS as shown below.

1. Change the TCAM profile to QoS.

```
switch#config
switch(config)#
switch(config)#hardware tcam profile qos
```

2. Create an ACL and then match the traffic packets based on the VLAN value and the VLAN mask configured in the ACL.

```
switch(config)#ip access-list acl1
switch(config-acl-acl1)#permit vlan 100 0xffff ip any any
switch(config-acl-acl1)#exit
```

3. Similarly, create a class-map and then match the traffic packets based on the range of VLAN values configured in the class-map.

```
switch(config)#class-map match-any class1
switch(config-cmap-qos-class1)#match vlan 20-40, 1000-1250, 2000
switch(config-cmap-qos-class1)#exit
```

12.4.2.2.6 Displaying Per-Port Per-VLAN QoS

The following show commands display the status, traffic hit counts, tcam profile information, and policy-maps configured on an interface.

The **show policy-map** command displays the policy-map information of the configured policy-map.

Example

```
switch#show policy-map policy1
Service-policy policy1
Class-map: class1 (match-any)
Match: ip access-group name acl1
Police cir 512000 bps bc 96000 bytes
Class-map: class-default (match-any)
```

The **show policy-map interface** command displays the policy-map configured on an interface.

Example

```
switch#show policy-map interface ethernet 1
Service-policy input: pl
Hardware programming status: Successful
Class-map: c2001 (match-any)
Match: vlan 2001 0xffff
set dscp 4
Class-map: c2002 (match-any)
Match: vlan 2002 0xffff
set dscp 8
Class-map: c2003 (match-any)
Match: vlan 2003 0xffff
set dscp 12
```

12.4.2.2.7 On DCS-7010, DCS-7050X, DCS7250X, DCS-7300X series switches

The **show policy-map policy-name counters** command displays the policy-map traffic match count for the policy-map configured.

Example

```
switch#show policy-map policy1 counters
Service-policy input: policy1
Hardware programming status: Successful
Class-map: class1 (match-any)
  Match: vlan 20-40,1000-1250
    police rate 100 mbps burst-size 100 kbytes
    Interface: Ethernet16/1
      Conformed 28621 packets, 7098008 bytes ----- packet match count

Class-map: class-default (match-any)
  Matched Packets: 19 ----- packet match count
```

The **show platform trident tcam** command displays the TCAM entries configured for each TCAM group including policy-maps and corresponding hits.

Examples

- ```
switch#show platform trident tcam
=== TCAM summary for switch Linecard0/0 ===
TCAM group 9 uses 42 entries and can use up to 1238 more.
 Mlag control traffic uses 4 entries.
 CVX traffic uses 6 entries.
 L3 Control Priority uses 23 entries.
 IGMP Snooping Flooding uses 8 entries.
 L4 MicroBfd traffic uses 1 entries.
TCAM group 13 uses 99 entries and can use up to 1181 more.
 Dot1x MAB traffic uses 1 entries.
 ACL Management uses 10 entries.
 Vxlan Traffic uses 24 entries.
 L2 Control Priority uses 11 entries.
 Storm Control Management uses 2 entries.
 ARP Inspection uses 2 entries.
 L3 Routing uses 49 entries.
TCAM group 14 uses 12 entries and can use up to 2548 more.
 Policy QOS uses 12 entries.
TCAM group 16 uses 59 entries and can use up to 1221 more.
TCAM group 67 uses 12 entries and can use up to 500 more.
```
- ```
switch#show platform trident tcam detail
=== TCAM detail for switch Linecard0/0 ===
TCAM group 9 uses 42 entries and can use up to 1238 more.
  Mlag control traffic uses 4 entries.
    589826          0 hits - MLAG - SrcPort UDP Entry
    589827          0 hits - MLAG - DstPort UDP Entry
```

```

589828          0 hits - MLAG - SrcPort TCP Entry
589829          0 hits - MLAG - DstPort TCP Entry
CVX traffic reserves 6 entries (0 used).
L3 Control Priority uses 23 entries.
589836          0 hits - URM - SelfIp UDP Entry
589837          0 hits - URM - SelfIp TCP Entry
589838          0 hits - URM - Ttl1 UDP Entry
589839          0 hits - URM - Ttl1 TCP Entry
589840          0 hits - BGP - Dst Port
589841          0 hits - BGP - Src Port
589842          0 hits - VRRP
589843          0 hits - BFD
589844          0 hits - BFD Multihop
589845          0 hits - PIM
589846          0 hits - PIM Null Register
589847          0 hits - PIM Register
589848          0 hits - OSPF - unicast
589849          71196 hits - OSPFv2 - Multicast
589850          0 hits - OSPFv3 - Multicast
589851          0 hits - OSPF Auth ESP - Multicast
589852          0 hits - OSPF Auth ESP - Unicast
589853          0 hits - IP packets with GRE type and ISIS protocol
589854          0 hits - RouterL3 Vlan Priority 6,7 Elevator
589855          0 hits - RouterL3 DSCP 48-63 Elevator
589856          0 hits - RouterL3 Priority Elevator
589857          0 hits - NextHopToCpu, Glean
589858          0 hits - L3MC Cpu OIF
IGMP Snooping Flooding reserves 8 entries (6 used).
589860          0 hits - Drop All IGMP packets
589861          0 hits - Flood link local packets
589862          0 hits - IGMP Snooping Restricted Flooding L2 from local
mlag peer
589863          0 hits - IGMP Snooping Restricted Flooding L2
589864          0 hits - IGMP Snooping Restricted Flooding L3 from local
mlag peer
589865          0 hits - IGMP Snooping Restricted Flooding L3
L4 MicroBfd traffic reserves 1 entries (0 used).
TCAM group 13 uses 99 entries and can use up to 1181 more.
Dot1x MAB traffic uses 1 entries.
851968          0 hits - Dot1xMab Rule

<-----OUTPUT OMITTED FROM EXAMPLE----->
ck338.22:14:38(config-pmap-qos-policy1)#

```

12.4.2.2.8 On DCS-7280(E/R), DCS7500(E/R) series switches

The `show platform fap [fapName] acl tcam hw` command displays the TCAM entries configured for each TCAM bank including policy-maps and corresponding traffic match.

Example

```

switch#show platform fap Arad1 acl tcam hw
=====
Arad1 Bank 0 Type: dbPdpIp, dbPdpIp6, dbPdpMpls, dbPdpNonIp, dbPdpTunnel
=====
-----
|Offs|X|PR|TT|R|QI|V6MC|DPRT|SPRT|F|DEST|V|ACT|H|
-----
|29| |4|59| | |01| | | | | | | | |3|0008f|0| |
| | |4|59| | |01| | | | | | | | |0|00000|0|
|30| |4|33| | |01| | | | | | | | |3|0008f|0|
| | |4|33| | |01| | | | | | | | |0|00000|0|
|31| |4|32| | |01| | | | | | | | |3|0008f|0|
| | |4|32| | |01| | | | | | | | |0|00000|0|
|32| |4| | | |01|ff02| | | | | | | | |3|00097|0|
| | |4| | | |01|ff02| | | | | | | | |0|00000|0|
|33| |4|06| | |01| | | |00b3| |26ffd|3|0009b|0|
| | |4|06| | |01| | | |00b3| |26ffd|0|00000|0|
|34| |4|06| | |01| | | |00b3| |26ffd|3|0009b|0|
| | |4|06| | |01| | | |00b3| |26ffd|0|00000|0|
|35| |4|3a| | |01| | | | | | | | |26ffd|3|000b3|0|
| | |4|3a| | |01| | | | | | | | |26ffd|0|00000|0|
|36| |4|3a| | |01| | | | | | | | |26ffb|3|000b3|0|
| | |4|3a| | |01| | | | | | | | |26ffb|0|00000|0|

```

37	4	11	ff	01	0ec8			3	000bb	0
	4	11	ff	01	0ec9			0	00000	0
38	4	11	ff	01	1a80			3	000bb	0
	4	11	ff	01	1a80			0	00000	0
39	4	11		01	12b0		26ffd	3	000bb	0
	4	11		01	12b0		26ffd	0	00000	0
40	4			01			26ffd	3	000c7	0
	4			01			26ffd	0	00000	0
41	4		01	3	01			3	000cb	0
	4		01	3	01			0	00000	0
42	4			01			26ffb	3	000db	0
	4			01			26ffb	0	00000	0
43	4			01			27000	3	000df	0
	4			01			27fff	0	00000	0
44	4			01			26ffe	3	000e3	0
	4			01			26ffe	0	00000	0
45	4			01			26ffa	3	000e7	0
	4			01			26ffa	0	00000	0
46	4			01			52000	3	000eb	0
	4			01			52fff	0	00000	0
47	4			01				3	00000	0
	4			01				0	00000	0

Offs	X	LEM2	LIFP	QI	DEST	PFC	TT	EEI	V	ACT	H
63	6			01		00			3	000cb	0
	6			01		01			0	00000	0
64	6	0		01					3	00187	0
	6	0		01					0	00000	0
65	6			01					3	00000	0
	6			01					0	00000	0

Offs	X	R	QI	DAHI	PT	DALO	DEST	V	ACT	H
48	2		01	0180		c2000014		3	00093	1
	2		01	0180		c2000015		0	00000	1
49	2		01	0900		2b000005		3	00093	0
	2		01	0900		2b000005		0	00000	0
50	2		01	0180		c2000002		3	0014f	0
	2		01	0180		c2000002		0	00000	0
51	2		01	0180		c2000003		3	0014f	0
	2		01	0180		c2000003		0	00000	0
52	2		01	0180		c2000021		3	00157	0
	2		01	0180		c2000021		0	00000	0
53	2		01		0a			3	0015b	1
	2		01		0a			0	00000	1
54	2		01	0100		5e900001		3	000bb	0
	2		01	0100		5e900001		0	00000	0
55	2		01	0180		c2000000		3	00163	1
	2		01	0180		c2000000		0	00000	1
56	2		01	0100		0cccccd		3	00163	0
	2		01	0100		0cccccd		0	00000	0
57	2		01	0180		c200000e		3	0016b	1
	2		01	0180		c200000e		0	00000	1
58	2		01				26ffb	3	000db	0
	2		01				26ffb	0	00000	0
59	2		01	0180		c2000000		3	000db	0
	2		01	0180		c200000f		0	00000	0
61	2		01				52000	3	000eb	0
	2		01				52fff	0	00000	0
62	2		01					3	00000	0
	2		01					0	00000	0

Offs	X	TT	QI	FOI	TT1	DEST	TT1P	PT	VX_DP	PN	F	MC	O	V	HDR	OFFSETS	ACT	H
72	1	0	01	03	1				0d	12b5	9			3	00002000000	001a7	0	
	1	0	01	03	1				0d	12b5	9			0	ffffffffffff	00000	0	
73	1	0	01	03	1				0d	12b5	9			3	00004000000	001a7	0	
	1	0	01	03	1				0d	12b5	9			0	ffffffffffff	00000	0	
74	1		01											3			00000	0
	1		01											0			00000	0

Offs	X	TT	PR	SPRT	R	QI	PN	F	MC	O	DPRT	DEST	V4_DIP	V	ACT	H	
0	0		02			01									3	00087	0
	0		02			01									0	00000	0

```

|1 |0| | | |01| | | | | |e000000d|3|0008b|0| | | |
| |0| | | |01| | | | | |e000000d|0|0000|0|
|2 |0| |59| | |01| | | | | | | |3|0008f|1|
| |0| |59| | |01| | | | | | | |0|00000|1|
|3 |0| | | | |01|1| | | | | | |3|00093|0|
| |0| | | | |01|1| | | | | | |0|00000|0|
|4 |0| | | | |01| | | | | |e0000000|3|00097|0|
| |0| | | | |01| | | | | |e00000ff|0|00000|0|
|5 |0| |06|00b3| |01| | | | |26ffd| |3|0009b|0|
| |0| |06|00b3| |01| | | | |26ffd| |0|00000|0|
|6 |0| |06| | |01| | |00b3|26ffd| |3|0009b|0|
| |0| |06| | |01| | |00b3|26ffd| |0|00000|0|
|7 |0|ff| | | |01| | | |1150|26ffd| |3|000a3|0|
| |0|ff| | | |01| | | |1150|26ffd| |0|00000|0|
|8 |0|ff| | | |01| | | |1150|26ffb| |3|000a3|0|
| |0|ff| | | |01| | | |1150|26ffb| |0|00000|0|
|9 |0|ff| |1150| |01| | | | |26ffd| |3|000a3|0|
| |0|ff| |1150| |01| | | | |26ffd| |0|00000|0|
|10 |0|ff| |1150| |01| | | | |26ffb| |3|000a3|0|
| |0|ff| |1150| |01| | | | |26ffb| |0|00000|0|
|11 |0| |01| | |01| | | | |26ffd| |3|000b3|0|
| |0| |01| | |01| | | | |26ffd| |0|00000|0|
|12 |0| |01| | |01| | | | |26ffb| |3|000b3|0|
| |0| |01| | |01| | | | |26ffb| |0|00000|0|
|13 |0|ff|11| | |01| | | |0ec8| | |3|000bb|0|
| |0|ff|11| | |01| | | |0ec9| | |0|00000|0|
|14 |0|ff|11| | |01| | | |1a80| | |3|000bb|0|
| |0|ff|11| | |01| | | |1a80| | |0|00000|0|
|15 |0| |11| | |01| | | |12b0|26ffd| |3|000bb|0|
| |0| |11| | |01| | | |12b0|26ffd| |0|00000|0|
|16 |0| | | | |01| | | | |26ffd| |3|000c7|0|
| |0| | | | |01| | | | |26ffd| |0|00000|0|
|17 |0|01| | | |1|01| | | | | | |3|000cb|0|
| |0|01| | | |1|01| | | | | | |0|00000|0|
|18 |0|01| | | |2|01| | | | |e0000000|3|000cb|0|
| |0|01| | | |2|01| | | | |ffffff|0|00000|0|
|19 |0| | | | |2|01| | |1| | |e0000000|3|000d3|0|
| |0| | | | |2|01| | |1| | |ffffff|0|00000|0|
|20 |0| | | | |1|01| | |1| | | | |3|000d3|0|
| |0| | | | |1|01| | |1| | | | |0|00000|0|
|21 |0| | | | |01| | | | |26ffb| |3|000db|0|
| |0| | | | |01| | | | |26ffb| |0|00000|0|
|22 |0| | | | |01| | | | |27000| |3|000df|0|
| |0| | | | |01| | | | |27fff| |0|00000|0|
|23 |0| | | | |01| | | | |26ffe| |3|000e3|0|
| |0| | | | |01| | | | |26fff| |0|00000|0|
|24 |0| | | | |01| | | | |26ffa| |3|000e7|0|
| |0| | | | |01| | | | |26ffa| |0|00000|0|
|25 |0| | | | |01| | | | |52000| |3|000eb|0|
| |0| | | | |01| | | | |52fff| |0|00000|0|
|26 |0| | | | |2|01| | | | |7ffff| |3|000ef|0|
| |0| | | | |2|01| | | | |7ffff| |0|00000|0|
|27 |0| | | | |2|01| | | | |54000| |3|000ef|0|
| |0| | | | |2|01| | | | |54fff| |0|00000|0|
|28 |0| | | | |01| | | | | | |3|00000|0|
| |0| | | | |01| | | | | | |0|00000|0|
-----
=====
Arad1 Bank 1 Type: dbIpQos
=====
|Offs|X|TC|CL|DPRT|SPRT|VQ|L4OPS |PP|PR|F|V4_DIP |V4_SIP |V|ACT |H|
-----
|0 |0| | | | | | | |01| | | | |3|00000|0|
| |0| | | | | | | |01| | | | |0|00000|0|
-----
<-----OUTPUT OMITTED FROM EXAMPLE----->

```

12.4.2.2.9 Configuring Mirror Access Control Lists

Access Control Lists (ACLs) are configured to permit or deny traffic between source and destination ports on Strata-based platforms. Mirror ACLs are used in mirroring traffic by matching VLAN ID of the configured ACLs. Mirror ACLs are applied for IPv4, IPv6, and MAC ACLs.

 **Note:** Mirror ACLs work in receiving direction only.

Platform Compatibility

Mirror ACLs are supported on the following platforms:

- 7050X
- 7050X2
- 7050X3
- 7060X
- 7060X2
- 7060X3
- 7260X
- 7260X3

Examples

- These commands configure ACL to permit VLAN traffic between any source and destination host.

```
switch(config)#ip access-list acl1
switch(config-acl-acl1)#permit vlan 1234 0x0 ip any any
```

- These commands configure monitor session sess1 with Ethernet 1 as source port and Ethernet 2 as destination port for an ingress ip acl_1.

```
switch(config)#monitor session sess1 source ethernet 1 rx ip access-
group acl1
switch(config)#monitor session sess1 destination ethernet 2
```

12.4.2.3 Applying ACLs

Access control lists become active when they are assigned to an interface or subinterface or to the control plane. This section describes the process of adding and removing ACL interface assignments.

Applying an ACL to an Interface

The switch must be in interface configuration mode to assign an ACL to an interface or subinterface.

- The `ip access-group` command applies the specified IP or standard IP ACL to the configuration mode interface or subinterface.
- The `ip access-group` command applies the specified IP or standard IP ACL to the control-plane traffic.
- The `mac access-group` command applies the specified MAC ACL to the configuration mode interface.

IPv4, IPv6, and MAC ACLs are separately applied for inbound and outbound packets. An interface or subinterface can be assigned with multiple ACLs, with a limit of one ACL per packet direction per ACL type. Egress ACLs are supported on a subset of all available switches. IPv6 egress ACLs have limited availability, and IPv6 egress ACLs applied to routed interfaces or subinterfaces across the same chip on the DCS-7500E and the DCS-7280E series can be shared. In addition to that, the DSCP value can match on IPv6 egress ACLs. This result in a more efficient utilization of system resources, and is particularly useful for environments with few, potentially large, IPv6 egress ACLs applied across multiple routed interfaces.

Examples

- These commands assign `test1` ACL to Ethernet interface 3, then verify the assignment.

```
switch(config)#interface ethernet 3
switch(config-if-Et3)#ip access-group test1 in
switch(config-if-Et3)#show running-config interfaces ethernet 3
```

```
interface Ethernet3
 ip access-group test1 in
 switch(config-if-Et3) #
```

- These commands place the switch in control plane configuration mode and applies the ACL assignment to the control-plane traffic.

```
switch(config) #control-plane
switch(config-cp) #ip access-group test_cp in
```

-
- This command enables shared ACLs.

```
switch(config) #hardware access-list resource sharing vlan ipv6 out
switch(config) #
```

- This command disables shared ACLs.

```
switch(config) #no hardware access-list resource sharing vlan ipv6 out
switch(config) #
```

- These commands apply an IPv4 ACL named “test_ACL” to ingress traffic on Ethernet subinterface 5.1.

```
switch(config) #interface ethernet 5.1
switch(config-if-Et5.1) #ipv4 access-group test_ACL in
switch(config-if-Et5.1) #
```

Removing an ACL from an Interface

The **no ip access-group** command removes an IP ACL assignment statement from **running-config** for the configuration mode interface. After an ACL is removed, the interface is not associated with an IP ACL.

The **no mac ip access-group** command removes a MAC ACL assignment statement from **running-config** for the configuration mode interface. After a MAC ACL is removed, the interface is not associated with an MAC ACL.

To remove an ACL from the control plane, enter the **no ip access-group** command in control plane configuration mode. Removing the control plane ACL command from **running-config** reinstates **default-control-plane-acl** as the control plane ACL.

Examples

- These commands remove the assigned IPv4 ACL from *Ethernet interface 3*.

```
switch(config) #interface ethernet 3
switch(config-if-Et3) #no ip access-group test in
switch(config-if-Et3) #
```

- These commands place the switch in control plane configuration mode and remove the ACL assignment from **running-config**, restoring **default-control-plane-acl** as the control plane ACL.

```
switch(config) #control-plane
switch(config-cp) #no ip access-group test_cp in
switch(config-cp) #
```

12.4.3 Service ACLs

These sections describe Service ACLs:

- [Service ACL Description](#)
- [Configuring Service ACLs and Displaying Status and Counters](#)

12.4.3.1 Service ACL Description

Service ACL enforcement is a feature added to a control plane service (the SSH server, the SNMP server, routing protocols, etc) that allows the switch administrator to restrict the processing of packets and connections by the control plane processes that implement that service. The control plane program run by the control plane process checks already received packets and connections against a user configurable access control list (ACL), a Service ACL. The Service ACL contains permit and deny rules matching any of the source address, destination address, and TCP or UDP ports of received packets or connections. After receiving a packet or connection, the control plane process evaluates the packet or connection against the rules of the Service ACL configured for the control plane process, and if the received packet or connection matches a deny rule the control plane process drops or closes it without further processing.

Control Plane Process Enforced Access Control enables the system administrator to restrict which systems on the network can access the services provided by the switch. Each service has its own access control list, giving the system administrator fine grained control over access to the switch's control plane services. The CLI for this uses the familiar pattern of access control lists assigned for a specific purpose, in this case for each control plane service.

12.4.3.2 Configuring Service ACLs and Displaying Status and Counters

12.4.3.2.1 SSH Server

To apply the SSH server Service ACLs for IPv4 and IPv6 traffic, use the [ip access-group \(Service ACLs\)](#) and [ipv6 access-group \(Service ACLs\)](#) commands in mgt-ssh configuration mode as shown below.

```
(config)# management ssh
(config-mgmt-ssh)# ip access-group <acl_name> [vrf <vrf_name>] in
(config-mgmt-ssh)# ipv6 access-group <acl_name> [vrf <vrf_name>] in
```

In EOS 4.19.0, all VRFs are required to use the same SSH server Service ACL. The Service ACL assigned without the **vrf** keyword is applied to all VRFs where the SSH server is enabled.

To display the status and counters of the SSH server Service ACLs, use the following commands.

```
(switch)>show management ssh ip access-list
(switch)>show management ssh ipv6 access-list
```

12.4.3.2.2 SNMP Server

To apply the SNMP server Service ACLs to restrict which hosts can access SNMP services on the switch, use the [snmp-server community](#) command as shown below.

```
(config)# snmp-server community <community-name> [view <viewname>] [ro |
rw]
<acl_name>
(config)# snmp-server community <community-name> [view <viewname>] [ro |
rw] ipv6
<ipv6_acl_name>
```

12.4.3.2.3 EAPI

To apply Service ACLs to the EOS application programming interface (EAPI) server, use the [ip access-group \(Service ACLs\)](#) and [ipv6 access-group \(Service ACLs\)](#) commands as shown below.

```
(config)#management api http-commands
(config-mgmt-api-http-cmds)#vrf <vrf_name>
(config-mgmt-api-http-cmds-vrf-<vrf>)#ip access-group <acl_name>
(config-mgmt-api-http-cmds-vrf-<vrf>)#ipv6 access-group <ipv6_acl_name>
```

To display the status and counters of the EAPI server Service ACLs, use the following commands.

```
(switch)> show management api http-commands ip access-list
(switch)> show management api http-commands ipv6 access-list
```

12.4.3.2.4 BGP

To apply Service ACLs for controlling connections to the BGP routing protocol agent, use the [ip access-group \(Service ACLs\)](#) and [ipv6 access-group \(Service ACLs\)](#) commands as shown below.

```
(config)# router bgp <asn>
(config-router-bgp)# ip access-group <acl_name>
(config-router-bgp)# ipv6 access-group <ipv6_acl_name>
(config-router-bgp)# vrf <vrf_name>
(config-router-bgp-vrf-<vrf>)# ip access-group <acl_name>
(config-router-bgp-vrf-<vrf>)# ipv6 access-group <ipv6_acl_name>
```

To display the status and counters of the BGP routing protocol Service ACLs, use the following commands.

```
(switch)> show bgp ipv4 access-list
(switch)> show bgp ipv6 access-list
```

12.4.3.2.5 UCMP auto adjust for BGP

Unequal-cost multi-path (UCMP) for BGP forwards traffic based on weight assignments for next hops of routes of ECMP traffic. The weights are programmed in the FIB. By disseminating BGP link-bandwidth extended community attribute information with BGP routes, the receiver device of all routes, programs the next hops in the FIB using the received link-bandwidth values. The percentage of interface speed is appended to the received link bandwidth extended community value of the route. The weight ratio of the traffic sent over egress ports is adjusted to forward more traffic towards the peer with higher interface speed.

Configuring UCMP auto adjust for BGP

The following command enables the weight adjustment.

This command configures the adjust auto to 62.3 percent.

```
switch(config-router-bgp)#neighbor group1 link-bandwidth adjust
auto percent 62.3
```

PERCENT is a float value between 0.0 to 100.0 and is optional.

12.4.3.2.6 OSPF

To apply Service ACLs for controlling packets processed by the OSPF routing protocol agent, use the [ip access-group \(Service ACLs\)](#) and [ipv6 access-group \(Service ACLs\)](#) commands as shown below.

```
(config)# router ospf <id>
(config-router-ospf)# ip access-group <acl_name>
(config-router-ospf)# ipv6 access-group <ipv6_acl_name>
```

When using VRFs, each per-VRF OSPF instance must be assigned its Service ACL explicitly.

To display the status and counters of the OSPF routing protocol Service ACLs, use the following commands.

```
(switch)> show ospf ipv4 access-list
(switch)> show ospf ipv6 access-list
```

12.4.3.2.7 PIM

To apply Service ACLs for controlling packets processed by the PIM routing protocol agent, use the **access-group** command as shown below.

```
(config)#router pim
(config-router-pim)#ipv4
(config-router-pim-ipv4)#access-group <acl_name>
(config-router-pim-ipv4)#vrf <vrf_name>
(config-router-pim-vrf-<vrf>)#ipv4
(config-router-pim-vrf-<vrf>-ipv4)#access-group <acl_name>
```

To display the status and counters of the PIM routing protocol Service ACLs, use the following commands.

```
(switch)> show ip pim access-list
```

12.4.3.2.8 IGMP

To apply Service ACLs for controlling packets processed by the IGMP management protocol agent, use the **ip igmp access-group** command as shown below.

```
(config)# router igmp
(config-router-igmp)# ip igmp access-group <acl_name>
(config-router-igmp)# vrf <vrf_name>
(config-router-igmp-vrf-<vrf>)# ip igmp access-group <acl_name>
```

To display the status and counters of the IGMP management protocol Service ACLs, use the following commands.

```
(switch)> show ip igmp access-list
```

12.4.3.2.9 DHCP Relay

To apply Service ACLs for controlling packets processed by the DHCP relay agent, use the **ip dhcp relay access-group** and **ipv6 dhcp relay access-group** commands as shown below.

```
(config)# ip dhcp relay access-group <acl_name> [vrf <vrf_name>]
(config)# ipv6 dhcp relay access-group <acl_name> [vrf <vrf_name>]
```

To display the status and counters of the DHCP relay agent Service ACLs, use the following commands.

```
(switch)> show ip dhcp relay access-list
(switch)> show ipv6 dhcp relay access-list
```

12.4.3.2.10 LDP

To apply Service ACLs for controlling packets and connections processed by the LDP MPLS label distribution protocol, use the [ip access-group \(Service ACLs\)](#) command as shown below.

```
(config)# mpls ldp
(config-mpls-ldp)# ip access-group <acl_name>
```

To display the status and counters of the LDP Service ACLs, use the following command.

```
(switch)> show mpls ldp access-list
```

12.4.3.2.11 LANZ

To apply Service ACLs for controlling connections accepted by the LANZ agent, use the [ip access-group \(Service ACLs\)](#) and [ipv6 access-group \(Service ACLs\)](#) commands as shown below.

```
(config)# queue-monitor streaming
(config-qm-streaming)# ip access-group <acl_name>
(config-qm-streaming)# ipv6 access-group <ipv6_acl_name>
```

To display the status and counters of the LDP Service ACLs, use the following command.

```
(switch)> show queue-monitor streaming access-lists
```

12.4.3.2.12 MPLS Ping and Traceroute

To apply Service ACLs for controlling connections accepted by the MPLS Ping agent, use the [ip access-group \(Service ACLs\)](#) and [ipv6 access-group \(Service ACLs\)](#) commands as shown below.

```
(config)# mpls ping
(config-mpls-ping)# ip access-group <acl_name> [vrf <vrf_name>]
(config-mpls-ping)# ipv6 access-group <ipv6_acl_name> [vrf <vrf_name>]
```

12.4.3.2.13 Telnet Server

To apply Service ACLs to the Telnet server, use the [ip access-group \(Service ACLs\)](#) and [ipv6 access-group \(Service ACLs\)](#) commands as shown below.

```
(config)# management telnet
(config-mgmt-telnet)# ip access-group <acl_name> [vrf <vrf_name>] in
(config-mgmt-telnet)# ipv6 access-group <ipv6_acl_name> [vrf <vrf_name>]
in
```

In EOS 4.19.0, all VRFs are required to use the same Telnet server Service ACL. The Service ACL assigned without the **vrf** keyword is applied to all VRFs where the Telnet server is enabled.

To display the status and counters of the LDP Service ACLs, use the following commands.

```
(switch)>show management telnet ip access-list
(switch)>show management telnet ipv6 access-list
```

12.4.4 RACL Sharing on SVIs

12.4.4.1 IPv4 Ingress Sharing

The IPv4 ingress sharing optimizes the utilization of hardware resources by sharing the hardware resources between different VLAN interfaces when they have same ACL attached.

Larger deployments are benefited with this function, where IPv4 ingress sharing is applied on multiple SVIs with member interfaces on same forwarding ASIC. For example, a trunk port carrying multiple VLANs and an ingress sharing is applied on all VLANs, it occupies lesser hardware resources irrespective of number of VLANs. By default, IPv4 ingress sharing is disabled on the switches.

To enable IPv4 Ingress Sharing use **no hardware access-list resource sharing vlan in** command. Note, enabling or disabling the IPv4 ingress sharing requires the restart of software agents on the switches which is a disruptive process and will impact the traffic forwarding. The **no** form of the command disables the IPv4 ingress sharing on the switch. To display the IPv4 ingress sharing information use **show platform trident** command on the switch.

12.4.4.2 IPv4 Egress Sharing

The IPv4 Egress Sharing optimizes the utilization of hardware resources by sharing TCAM entries for a group of SVIs on which IPv4 ACLs shared. The TCAM entries are shared for all the SVIs per chip, hence, saving a lot of hardware resources and enabling ACLs to scale to a larger configurations.

Larger deployments are benefited, where IPv4 Egress Sharing is applied on multiple SVIs with member interfaces on same forwarding ASIC. For example, a trunk port carrying multiple VLANs, and when Egress Sharing is applied on all VLANs it occupies lesser hardware resources irrespective of number of VLANs. By default, IPv4 Egress Sharing is enabled on the switches. However, both IPv4 Egress Sharing and uRPF cannot be enabled at the same time. Disabling IPv4 RACL sharing will allow uRPF configuration and make sure RACL configuration, non-shared mode, is configured at the same time.

To enable unicast Reverse Path Forwarding (uRPF) on the switch, the IPv4 Egress Sharing must be disabled using the **no hardware access-list resource sharing vlan ipv4 out** command.

To enable IPv4 Egress Sharing if previously disabled from the default configuration, use **hardware access-list resource sharing vlan ipv4 out** command. Note, enabling or disabling the IPv4 Egress Sharing requires the restart of software agents on the switches which is a disruptive process and will impact the traffic forwarding.

The following **show** commands can be used to verify the IPv4 Egress Sharing information on the switch.

- **show ip access-lists**
- **show vlan**
- **show platform arad acl tcam**
- **show ip route**
- **show platform arad ip route**

12.4.4.3 Configuring IPv4 Egress Sharing

Use **hardware access-list resource sharing vlan ipv4 out** command to enable the IPv4 Egress Sharing on the switch. By default, IPv4 Egress Sharing is enabled on the switch. The **no** form of the command disables the IPv4 Egress Sharing on the switch and user is allowed to configure the uRPF on the switch.

12.4.4.4 Displaying IPv4 Egress Sharing Information

Examples

- The **show ip access-lists** command displays the list of all the configured IPv4 ACLs.

```
switch#show ip access-lists summary
IPV4 ACL default-control-plane-acl [readonly]
  Total rules configured: 17
  Configured on Ingress: control-plane(default VRF)
  Active on Ingress: control-plane(default VRF)

IPV4 ACL ipAclLimitTest
  Total rules configured: 0
  Configured on Egress: V12148,2700
  Active on Egress: V12148,2700
```

- The **show vlan** command displays the list of all the member interfaces under each SVI.

```
switch#show vlan
VLAN  Name                Status    Ports
-----
 1    default              active    Cpu, Et1, Et26
2148  VLAN2148             active    Cpu, Et1, Et26
2700  VLAN2700             active    Cpu, Et18
```

- The **show platform arad acl tcam** command displays the number of TCAM entries (hardware resources) occupied by the ACL on each forwarding ASIC and the percentage of TCAM utilization per forwarding ASIC.

```
switch#show platform arad acl tcam detail
ip access-list ipAclLimitTest (Shared RACL, 0 rules, 1 entries,
  direction out,
  state success, Acl Label 2)
Fap: Arad0, Shared: true, Interfaces: V12148, V12700
Bank Offset Entries
0          0          1
Fap: Arad1, Shared: true, Interfaces: V12148
Bank Offset Entries
0          0          1
```

```
Switch#show platform arad acl tcam summary
The total number of TCAM lines per bank is 1024.
=====
Arad0:
=====
Bank  Used          Used %          Used By
  0    1              0              IP Egress PACLs/RACLs
Total Number of TCAM lines used is: 1
=====
Arad1:
=====
Bank  Used          Used %          Used By
  0    1              0              IP Egress PACLs/RACLs
Total Number of TCAM lines used is: 1
```

- The **show ip route** command displays the unicast ip routes installed in the system.

```
switch#show ip route
VRF name: default
Codes: C - connected, S - static, K - kernel,
       O - OSPF, IA - OSPF inter area, E1 - OSPF external type 1,
       E2 - OSPF external type 2, N1 - OSPF NSSA external type 1,
       N2 - OSPF NSSA external type2, B I - iBGP, B E - eBGP,
       R - RIP, I - ISIS, A B - BGP Aggregate, A O - OSPF Summary,
       NG - Nexthop Group Static Route

Gateway of last resort is not set
C 10.1.0.0/16 is directly connected, Vlan2659
C 10.2.0.0/16 is directly connected, Vlan2148
C 10.3.0.0/16 is directly connected, Vlan2700
S 172.17.0.0/16 [1/0] via 172.24.0.1, Management1
S 172.18.0.0/16 [1/0] via 172.24.0.1, Management1
S 172.19.0.0/16 [1/0] via 172.24.0.1, Management1
S 172.20.0.0/16 [1/0] via 172.24.0.1, Management1
S 172.22.0.0/16 [1/0] via 172.24.0.1, Management1
C 172.24.0.0/18 is directly connected, Management1
```

- The **show platform arad ip route** command displays the platform unicast forwarding routes.

```
switch#show platform arad ip route
Tunnel Type: M(mpls), G(gre)
-----
|                                     Routing Table                                     |
|-----|-----|-----|-----|-----|-----|-----|-----|-----|-----|
|VRF| Destination | | | Acl | | | | | |
|ECMP| FEC | Tunnel | | | | | | | |
| ID| Subnet | Cmd | Destination | VID | Label | MAC / CPU Code | | |
|Index|Index|T Value | | | | | | |
|-----|-----|-----|-----|-----|-----|-----|-----|-----|
|0| 10.0.0.0/8 | |TRAP| CoppSystemL3DstMiss|0| | - | ArpTrap | - |1031| -
|0| 10.1.0.0/16 | |TRAP| CoppSystemL3DstMiss|2659| | - | ArpTrap | - |1030| -
|0| 10.2.0.0/16 | |TRAP| CoppSystemL3DstMiss|2148| | - | ArpTrap | - |1026| -
|0| 10.3.0.0/16 | |TRAP| CoppSystemL3DstMiss|2700| | - | ArpTrap | - |1034| -
|0| 127.0.0.0/8 | |TRAP| CoppSystemL3DstMiss|0| | - | ArpTrap | - |1031| -
|0| 172.17.0.0/16 | |TRAP| CoppSystemL3DstMiss|0| | - | ArpTrap | - |1025| -
|0| 172.18.0.0/16 | |TRAP| CoppSystemL3DstMiss|0| | - | ArpTrap | - |1025| -
|0| 172.19.0.0/16 | |TRAP| CoppSystemL3DstMiss|0| | - | ArpTrap | - |1025| -
|0| 172.20.0.0/16 | |TRAP| CoppSystemL3DstMiss|0| | - | ArpTrap | - |1025| -
|0| 172.22.0.0/16 | |TRAP| CoppSystemL3DstMiss|0| | - | ArpTrap | - |1025| -
|0| 172.24.0.0/18 | |TRAP| CoppSystemL3DstMiss|0| | - | ArpTrap | - |1032| -
|0| 0.0.0.0/0 | |TRAP| CoppSystemL3LpmOver|0| | - | SlowReceive | -
|1024| | -
|0| 10.1.0.0/32* | |TRAP| CoppSystemIpBcast |0| | - | BcastReceive | -
|1027| | -
|0| 10.1.0.1/32* | |TRAP| CoppSystemIpUcast |0| | - | Receive | - |32766| -
|0| 10.1.255.1/32* | |ROUTE| Po1 |2659| 4094 | 00:1f:5d:6b:ce:45 |
| - |1035| | -
|0| 10.1.255.255/32* | |TRAP| CoppSystemIpBcast |0| | - | BcastReceive | -
|1027| | -
|0| 10.2.0.0/32* | |TRAP| CoppSystemIpBcast |0| | - | BcastReceive | -
|1027| | -
|0| 10.2.0.1/32* | |TRAP| CoppSystemIpUcast |0| | - | Receive | - |32766| -
|0| 10.2.255.1/32* | |ROUTE| Et1 |2148| 2 | 00:1f:5d:6d:54:dc |
| - |1036| | -
|0| 10.2.255.255/32* | |TRAP| CoppSystemIpBcast |0| | - | BcastReceive | -
|1027| | -
|0| 10.3.0.0/32* | |TRAP| CoppSystemIpBcast |0| | - | BcastReceive | -
|1027| | -
|0| 10.3.0.1/32* | |TRAP| CoppSystemIpUcast |0| | - | Receive | - |32766| -
|0| 10.3.255.1/32* | |ROUTE| Et18 |2700| 2 | 00:1f:5d:6b:00:01 |
| - |1038| | -
```

12.4.5 Route Maps

A route map is an ordered set of rules that control the redistribution of IP routes into a protocol domain on the basis of such criteria as route metrics, access control lists, next hop addresses, and route tags. Route maps can also alter parameters of routes as they are redistributed.

These sections describe the route map implementation:

- [Route Map Description](#) describes route maps.
- [Route Map Configuration](#) describes the route map configuration process.
- [Using Route Maps](#) describes the usage of route maps.

12.4.5.1 Route Map Description

Route maps are composed of route map statements, each of which consists of a list of match and set commands.

Route Map Statements

Route map statements are categorized by the resolution of routes that the statement filters.

- Permit statements facilitate the redistribution of matched routes.
- Deny statements prevent the redistribution of matched routes.

Route map statement elements include name, sequence number, filter type, match commands, set commands, and continue commands.

- **name** identifies the route map to which the statement belongs.
- **sequence number** designates the statement's placement within the route map.
- **filter type** specifies the route resolution. Valid types are permit and deny.
- **match commands** specify criteria that select routes that the statement is evaluating for redistribution.
- **set commands** modify route parameters for redistributed routes.
- **continue commands** prolong the route map evaluation of routes that match a statement.

Statements filter routes for redistribution. Routes that statements pass are redistributed (permit statements) or rejected (deny statements). Routes that statements fail are filtered by the next statement in the route map.

- When a statement does not contain a **match** command, the statement passes all routes.
- When a statement contains a single **match** command that lists a single object, the statement passes routes whose parameters match the object.
- When a statement contains a single **match** command that lists multiple objects, the statements passes routes whose parameters match at least one object.
- When a statement contains multiple **match** commands, the statement passes routes whose parameters match all match commands.

Set commands modify parameters for redistributed routes. **Set** commands are valid in permit statements.

Example

The following route map statement is named MAP_1 with sequence number 10. The statement matches all routes from BGP Autonomous System 10 and redistributes them with a local preference set to 100. Routes that do not match the statement are evaluated against the next statement in the route map.

```
switch#route-map MAP_1 permit 10
      match as 10
```

```
set local-preference 100
```

Route Maps with Multiple Statements

A route map consists of statements with the same name and different sequence numbers. Statements filter routes in ascending order of their sequence numbers. When a statement passes a route, the redistribution action is performed as specified by the filter type and all subsequent statements are ignored. When the statement fails the route, the statement with the smallest sequence number that is larger than the current one filters the route.

All route maps have an implied final statement that contains a single deny statement with no match command. This denies redistribution to routes that are not passed by any statement.

Example

The following route map is named *MAP_1* with two permit statements. Routes that do not match either statement are denied redistribution into the target protocol domain.

```
switch#route-map MAP_1 permit 10
  match as 10
  set local-preference 100
!
switch#route-map MAP_1 permit 20
  match metric-type type-1
  match as 100
```

[Route Map Configuration](#) describes route map configuration procedures.

Route Maps with Multiple Statements and Continue Commands

Route map statements that contain a [continue \(route map\)](#) command support additional route map evaluation of routes whose parameters meet the statement's match commands. Routes that match a statement containing a **continue** command are evaluated against the statement specified by the **continue** command.

When a route matches multiple route map statements, the filter action (deny or permit) is determined by the last statement that the route matches. The **set** commands in all statements matching the route are applied to the route after the route map evaluation is complete. Multiple set commands are applied in the same order by which the route was evaluated against the statements containing them.

Example

The following route map is named *MAP_1* with a permit statement and a deny statement. The permit statement contains a continue command. Routes that match statement 10 are evaluated against statement 20.

```
route-map MAP_2 permit 10
  match as 10
  continue 20
  set local-preference 100
!
route-map MAP_2 deny 20
  match metric-type type-1
  match as 100
```

The route is redistributed if it passes statement 10 and is rejected by statement 20. The route is denied redistribution in all other instances. The **continue** command guarantees the evaluation of all routes against both statements.

12.4.5.2 Route Map Configuration

Route maps are created and modified in route map configuration mode. These sections describe the configuration mode and its commands.

- [Route Map Creation and Editing](#)
- [Modifying Route Map Components](#)

12.4.5.2.1 Route Map Creation and Editing

Creating a Route Map Statement

To create a route map, enter [route-map](#) followed by the map name and filter type (**deny** or **permit**). The default sequence number is assigned to the statement if the command does not include a number.

Example

This command places the switch in route map configuration mode to create a route map statement named *map1* with a sequence number of 50.

```
switch(config)#route-map map1 permit 50
switch(config-route-map-map1)#
```

Editing a Route Map Statement

To edit an existing route map statement, enter [route-map](#) with the map's name and statement's number. The switch enters route map configuration mode for the statement. Subsequent [match \(route-map\)](#) and [set \(route-map\)](#) commands add the corresponding commands to the statement.

The **show** command displays contents of the existing route map.

Example

This command places the switch in route map configuration mode to edit an existing route map statement. The **show** command displays contents of all statements in the route map.

```
switch(config)#route-map MAP2
switch(config-route-map-MAP2)#show
  Match clauses:
    match as 10
    match tag 333
  Set clauses:
    set local-preference 100
switch(config-route-map-MAP2)#
```

Saving Route Map Modifications

Route map configuration mode is a group-change mode. Changes are saved by exiting the mode, either with an explicit **exit** command or by switching directly to another configuration mode. This includes switching to the configuration mode for a different route map.

Example

The first command creates the *map1* statement with sequence number of 10. The second command is not yet saved to the route map, as displayed by the **show** command.

- ```
switch(config)#route-map map1 permit
switch(config-route-map-map1)#match as 100
switch(config-route-map-map1)#show
```

```
switch(config-route-map-map1)#
```

The **exit** command saves the **match** command.

```
switch(config-route-map-map1)#exit
switch(config)#show route-map map1
route-map map1 permit 10
 Match clauses:
 match as 100
 Set clauses:
switch(config)#
```

### Discarding Route Map Modifications

The **abort** command discards all pending changes and exits route map configuration mode.

#### Example

The **abort** command discards the pending **match** command and restores the original route map.

```
switch(config)#route-map map1 permit
switch(config-route-map-map1)#match as 100
switch(config-route-map-map1)#abort
switch(config)#show route-map map1
switch(config)#
```

### 12.4.5.2.2 Modifying Route Map Components

These commands add rules to the configuration mode route map:

- **match (route-map)** adds a match rule to a route map.
- **set (route-map)** adds a set rule to a route map.

#### Inserting a Statement

To insert a new statement into an existing route map, create a new statement with a sequence number that differs from any existing statement in the map.

#### Example

This command adds statement 50 to the *Map1* route map, then displays the new route map.

```
switch(config)#route-map Map1 permit 50
switch(config-route-map-Map1)#match as 150
switch(config-route-map-Map1)#exit
switch(config)#show route-map Map1
route-map Map1 deny 10
 Match clauses:
 match as 10
 match tag 333
 Set clauses:
 set local-preference 100
route-map Map1 permit 50
 Match clauses:
 match as 150
 Set clauses:
switch(config)#
```

---

## Deleting Route Map Components

To remove a component from a route map, perform one of the following:

- To remove a command from a statement, enter **no**, followed by the command to be removed.
- To remove a statement, enter **no**, followed by the route map with the filter type and the sequence number of the statement to be removed.
- To remove a route map, enter **no** followed by the route map without a sequence number.

### 12.4.5.3 Using Route Maps

Protocol redistribution commands include a route map parameter that determines the routes to be redistributed into the specified protocol domain.

#### Example

This command uses *Map1* route map to select OSPFv2 routes for redistribution into BGP AS1.

```
switch(config)#router bgp 1
switch(config-router-bgp)#redistribute ospf route-map Map1
switch(config-router-bgp)#exit
switch(config)#
```

### 12.4.6 Prefix Lists

A prefix list is an ordered set of rules that defines route redistribution access for a specified IP address space. A prefix list rule consists of a filter action (deny or permit), an address space identifier (IPv4 subnet address or IPv6 prefix), and a sequence number.

Prefix lists are referenced by route map match commands when filtering routes for redistribution.

- [Prefix List Configuration](#) describes the prefix list configuration process.
- [Using Prefix Lists](#) describes the use of prefix lists.
- [Static Routes Redistribution into IGP](#)s describes redistribution of routes whose configured next-hops satisfy the route-map policy.

#### 12.4.6.1 Prefix List Configuration

A prefix list is an ordered set of rules that defines route redistribution access for a specified IP address space. A prefix list rule consists of a filter action (deny or permit), a network address (IPv4 subnet or IPv6 prefix), and a sequence number. A rule may also include an alternate mask size.

The switch supports IPv4 and IPv6 prefix lists. The switch is placed in a Prefix-list configuration mode to create and edit IPv4 or IPv6 prefix lists.

##### 12.4.6.1.1 IPv4 Prefix Lists

IPv4 prefix lists are created or modified by adding an IPv4 prefix list rule in the Prefix-list configuration mode. Each rule includes the name of a prefix list, in addition to the sequence number, network address, and filter action. A list consists of all rules that have the same prefix list name.

The [ip prefix-list](#) command creates a prefix list or adds a rule to an existing list. Route map match commands use prefix lists to filter routes for redistribution into OSPF, RIP, or BGP domains.

#### Creating an IPv4 Prefix List

To create an IPv4 prefix list, enter the [ip prefix-list](#) command, followed by the name of the list. The switch enters IPv4 prefix-list configuration mode for the list. If the command is followed by the name of an existing ACL, subsequent commands edit that list.

## Examples

- This command places the switch in IPv4 prefix list configuration mode to create an IPv4 prefix list named `route-one`.

```
switch(config)#ip prefix-list route-one
switch(config-ip-pfx)#
```

- These commands create four different rules for the prefix-list named `route-one`.

```
switch(config)#ip prefix-list route-one
switch(config-ip-pfx)#seq 10 deny 10.1.1.0/24
switch(config-ip-pfx)#seq 20 deny 10.1.0.0/16
switch(config-ip-pfx)#seq 30 permit 12.15.4.9/32
switch(config-ip-pfx)#seq 40 deny 1.1.1.0/24
```

To view the list, save the rules by exiting the Prefix-list command mode, then re-enter the configuration mode and type `show active`.

```
switch(config-ip-pfx)#exit
switch(config)#ip prefix-list route-one
switch(config-ip-pfx)#show active
ip prefix-list route-one
 seq 10 deny 10.1.1.0/24
 seq 20 deny 10.1.0.0/16
 seq 30 permit 12.15.4.9/32
 seq 40 deny 1.1.1.0/24
switch(config-ip-pfx)#ip prefix-list route-one
```

IPv4 prefix lists are referenced in `match (route-map)` command.

### 12.4.6.1.2 IPv6 Prefix Lists

#### Creating an IPv6 Prefix List

The switch provides IPv6 prefix-list configuration mode for creating and modifying IPv6 prefix lists. A list can be edited only in the mode where it was created.

To create an IP ACL, enter the `ipv6 prefix-list` command, followed by the name of the list. The switch enters IPv6 prefix-list configuration mode for the list. If the command is followed by the name of an existing ACL, subsequent commands edit that list.

#### Example

This command places the switch in IPv6 prefix list configuration mode to create an IPv6 prefix list named `map1`.

```
switch(config)#ipv6 prefix-list map1
switch(config-ipv6-pfx)#
```

#### Adding a Rule

To append a rule to the end of a list, enter the rule without a sequence number while in Prefix-List configuration mode for the list. The new rule's sequence number is derived by adding 10 to the last rule's sequence number.

---

## Example

These commands enter the first two rules into a new prefix list.

```
switch(config-ipv6-pfx)#permit 3:4e96:8ca1:33cf::/64
switch(config-ipv6-pfx)#permit 3:11b1:8fe4:1aac::/64
```

To view the list, save the rules by exiting the prefix-list command mode, then re-enter the configuration mode and type **show active**.

```
switch(config-ipv6-pfx)#exit
switch(config)#ipv6 prefix-list map1
switch(config-ipv6-pfx)#show active
ipv6 prefix-list map1
 seq 10 permit 3:4e96:8ca1:33cf::/64
 seq 20 permit 3:11b1:8fe4:1aac::/64
switch(config-ipv6-pfx)#
```

This command appends a rule to the end of the prefix list. The new rule's sequence number is 30.

```
switch(config-ipv6-pfx)#permit 3:1bca:1141:ab34::/64
switch(config-ipv6-pfx)#exit
switch(config)#ipv6 prefix-list map1
switch(config-ipv6-pfx)#show active
ipv6 prefix-list map1
 seq 10 permit 3:4e96:8ca1:33cf::/64
 seq 20 permit 3:11b1:8fe4:1aac::/64
 seq 30 permit 3:1bca:1141:ab34::/64
switch(config-ipv6-pfx)#
```

## Inserting a Rule

To insert a rule into a prefix list, use the [seq \(IPv6 Prefix Lists\)](#) command to enter a rule with a sequence number that is between numbers of two existing rules.

## Example

This command inserts a rule between the first two rules by assigning it the sequence number 15.

```
switch(config-ipv6-pfx)#seq 15 deny 3:4400::/64
switch(config-ipv6-pfx)#exit
switch(config)#show ipv6 prefix-list map1
ipv6 prefix-list map1
 seq 10 permit 3:4e96:8ca1:33cf::/64
 seq 15 deny 3:4400::/64
 seq 20 permit 3:11b1:8fe4:1aac::/64
 seq 30 permit 3:1bca:3ff2:634a::/64
switch(config)#
```

## Deleting a Rule

To remove a rule from the configuration mode prefix list, enter **no seq** (see [seq \(IPv6 Prefix Lists\)](#)), followed by the sequence number of the rule to be removed.

## Example

These commands remove rule 20 from the prefix list, then displays the resultant prefix list.

```
switch(config-ipv6-pfx)#no seq 20
switch(config-ipv6-pfx)#exit
```



```
switch(config)#show ipv6 prefix-list map1
ipv6 prefix-list map1
seq 10 permit 3:4e96:8ca1:33cf::/64
seq 15 deny 3:4400::/64
seq 30 permit 3:1bca:3ff2:634a::/64
switch(config)#
```

### 12.4.6.2 Using Prefix Lists

Route map match commands include an option that matches a specified prefix list.

#### Example

The *MAP\_1* route map uses a match command that references the *PL\_1* prefix list.

```
switch(config)#route-map MAP_1 permit
switch(config-route-map-MAP_1)#match ip address prefix-list PL_1
switch(config-route-map-MAP_1)#set community 500
switch(config-route-map-MAP_1)#exit
```

### 12.4.6.3 Static Routes Redistribution into IGP

Use match ip next-hop route-map, while redistributing static routes into IGPs to redistribute the static routes whose **configured** next-hops satisfies the route-map policy.

The following example applies match ip next-hop clause for static routes redistributed into IGPs for multi-agent mode as well. The following configures a static route.

```
switch(config)# ip route 10.20.30.0/24 1.2.3.4
```

The following configures a prefix-list.

```
switch (config)#ip prefix-list prefixListName
switch(config-ip-px)#permit 1.2.3.4/32
```

1.2.3.4 is a **configured** next-hop for static route 10.20.30.0/24.

The following configures a route map.

```
switch(config)#route-map routeMapName
switch(config-route-map-routeMapName)#match ip next-hop prefix-list
prefixListName
```

To redistribute static routes with 'match ip next-hop' route-map clause in IS-IS.

```
switch(config-router-isis)#redistribute static route-map routeMapName
```

Redistributed routes can be seen using the following show commands. If routes are redistributed into IS-IS then show isis database detail. If routes are redistributed into OSPFv2 then show ip ospf database detail.

```
switch #show ip route

VRF: default
Codes: C - connected, S - static, K - kernel,
 O - OSPF, IA - OSPF inter area, E1 - OSPF external type 1,
 E2 - OSPF external type 2, N1 - OSPF NSSA external type 1,
 N2 - OSPF NSSA external type2, B - BGP, B I - iBGP, B E - eBGP,
 R - RIP, I L1 - IS-IS level 1, I L2 - IS-IS level 2,
```

```

O3 - OSPFv3, A B - BGP Aggregate, A O - OSPF Summary,
NG - Nexthop Group Static Route, V - VXLAN Control Service,
DH - DHCP client installed default route, M - Martian,
DP - Dynamic Policy Route, L - VRF Leaked

Gateway of last resort is not set

...
I L2 10.20.30.0/24 [115/10] via 1.2.3.4, Ethernet1

switch #show isis database detail

IS-IS Instance: B VRF: default
IS-IS Level 1 Link State Database
 LSPID Seq Num Cksum Life IS Flags
 ...
IS-IS Level 2 Link State Database
 LSPID Seq Num Cksum Life IS Flags
 0000.0000.0001.00-00 6 10364 840 L2 <>
 ...
 Reachability : 10.20.30.0/24 Metric: 0 Type: 1 Up
 ...

```

## 12.4.7 Port ACLs with User-Defined Fields

Describes the support for specifying User-Defined Fields (UDF) in Port ACLs including IPv4, IPv6, and MAC ACLs. The purpose of the User-Defined Fields feature is to permit or deny packets based on custom offset pattern matching.

User-Defined Fields, or UDFs, are defined as part of an access-list filter and are comprised of an offset, length, pattern match and mask. This describes a single portion of any incoming packet to match the provided value upon.

UDFs may also be defined via aliases. Aliases are a way to save a UDF configuration for reuse in multiple access-lists and or access-list rules. An alias may substitute for a fully defined UDF including the offset, pattern and mask. The pattern or mask may be overridden when the alias is used in an access-list rule.

The behavior, CLI syntax and configuration of UDFs are identical to Traffic Steering UDF and Mirroring ACL UDF.

This section describes port ACLs with user-defined fields, including configuration instructions. Topics covered by this section include:

- [Platform Compatibility](#)
- [Configuration](#)
- [Syslog Messages](#)
- [Limitations](#)

### 12.4.7.1 Platform Compatibility

The following platforms support Port ACLs with user-defined fields:

- DCS-7020
- DCS-7280E
- DCS-7280SE
- DCS-7280R
- DCS-7280R2
- DCS-7280R3 (Starting in 4.23.2F)

- DCS-7500E
- DCS-7500R
- DCS-7500R2
- DCS-7500R3 (Starting in 4.23.2F)

## 12.4.7.2 Configuration

User-defined fields are specified as part of an access-list. The type of access-list however, dictates the base position of the UDF and the options available. In addition, a TCAM profile must be configured to include UDFs as part of the Port ACL feature's key.

### 12.4.7.2.1 TCAM Profile

User-Defined Fields are defined as additional fields in the Port ACL feature's key. By default, UDFs are not included in the keys for the Port ACL features. Adding a UDF to the key requires removal of different key fields to fit within the TCAM width restrictions.

 **Note:** Each UDF is either 16 bits wide or 32 bits wide.

Below are example configurations of the TCAM profile.

#### 12.4.7.2.1.1 IPv4 Port ACL

The following configurations create a new profile based on the default profile. This new profile replaces the Layer 4 port key fields with 1 16-bit UDF and 1 32-bit UDF.

```
switch(config)#hardware tcam
switch(config-hw-tcam)#profile ipv4Udf copy default
switch(config-hw-tcam-profile-ipv4Udf)#feature acl port ip
switch(config-hw-tcam-profile-ipv4Udf-feature-acl-port-ip)#no key field
 14-ops
switch(config-hw-tcam-profile-ipv4Udf-feature-acl-port-ip)#no key field
 14-src-port
switch(config-hw-tcam-profile-ipv4Udf-feature-acl-port-ip)#no key field
 14-dst-port
switch(config-hw-tcam-profile-ipv4Udf-feature-acl-port-ip)#key field
 udf-16b-1
switch(config-hw-tcam-profile-ipv4Udf-feature-acl-port-ip)#key field
 udf-32b-1
switch(config-hw-tcam-profile-ipv4Udf-feature-acl-port-ip)#exit
switch(config-hw-tcam-profile-ipv4Udf)#exit
switch(config-hw-tcam)#system profile ipv4Udf
```

#### Example-16-bit IPv4 Header Match

The following configurations match IPv4 packets based on the Identification(ID) field. Packets ingressing into **Ethernet Interface 7** with an ID equal to **1000** is forwarded. Packets with an ID different than **1000** is dropped.

```
(config)#ip access-list udfAcl
(config-acl-udfAcl)#permit ip any any payload header start offset 1
 pattern 0x03E80000 mask 0x0000FFFF
(config-acl-udfAcl)#deny ip any any
(config-acl-udfAcl)#exit
(config)#interface ethernet 7
(config-if-Et7)#
```

### 12.4.7.2.1 IPv6 Port ACL

The following configurations create a new profile based on the default profile. This new profile replaces the destination IPv6 address key field with 2 32-bit UDFs.

```
switch(config)#hardware tcam
switch(config-hw-tcam)#profile ipv6Udf copy default
switch(config-hw-tcam-profile-ipv6Udf)#feature acl port ipv6
switch(config-hw-tcam-profile-ipv6Udf-feature-acl-port-ipv6)#no key field
dst-ipv6
switch(config-hw-tcam-profile-ipv6Udf-feature-acl-port-ipv6)#key field
udf-32b-1
switch(config-hw-tcam-profile-ipv6Udf-feature-acl-port-ipv6)#key field
udf-32b-2
switch(config-hw-tcam-profile-ipv6Udf-feature-acl-port-ipv6)#exit
switch(config-hw-tcam-profile-ipv6Udf)#exit
switch(config-hw-tcam)#system profile ipv6Udf
```

### Example-32-bit IPv6 Payload Match

The following configurations match IPv6 UDP packets based on the first 32 bits of the packet payload. UDP packets ingressing into **Ethernet Interface 7** that starts with **0x1234567X** (where X can be any valid hexadecimal) in the payload are forwarded. Any other packets are dropped. The offset is set to 2 (2 x 4-byte words) to skip the UDP header.

```
(config)#ipv6 access-list udfAcl
(config-ipv6-acl-udfAcl)#permit udp any any payload offset 2 pattern
0x12345670 mask 0x0000000f
(config-ipv6-acl-udfAcl)#deny ipv6 any any
(config-ipv6-acl-udfAcl)#exit
(config)#interface ethernet 7
(config-if-Et7)#ipv6 access-group udfAcl in
```

### 12.4.7.2.1.3 Syslog Messages

When applying an ACL with UDFs to an interface, but the TCAM profile is not configured with the UDF key fields, the following Syslog displays:

```
%MATCH-6-RULE_FIELD_UNAVAILABLE: The payload field configured in the IPv6
rule in udfAcl is not present in the TCAM key.
```

When an ACL is configured with too many UDFs (see Limitations), the following Syslog displays:

```
%SAND-3-UDF_ACL_HW_RESOURCE_FULL: Hardware resources are insufficient to
program ACLs with UDF
```

### 12.4.7.3 Syslog Messages

When applying an ACL with UDFs to an interface, but the TCAM profile is not configured with the UDF key fields, the following Syslog displays:

```
%MATCH-6-RULE_FIELD_UNAVAILABLE: The payload field configured in the IPv6
rule in udfAcl is not present in the TCAM key.
```

When an ACL is configured with too many UDFs (see Limitations), the following Syslog displays:

```
%SAND-3-UDF_ACL_HW_RESOURCE_FULL: Hardware resources are insufficient to program ACLs with UDF
```

#### 12.4.7.4 Limitations

User-defined fields consume a limited set of copy resources. For each unique offset, if a pattern is specified that is masked to be > 16 bits wide, then a 32-bit resource is used. If no 32-bit resource is available, then two 16-bit resources are used, if available. Copy resources are dependent upon the number of UDF key fields added to the feature key. Each UDF key field maps to one copy resource. Using the above TCAM profile configurations:

- IPv4: 1 x 16-bit pattern + 1 x 32-bit pattern.
- IPv6: 2 x 32-bit pattern.
- MAC: 1 x 16-bit pattern + 1 x 32-bit pattern.

Other limitations include:

- Maximum offset value is 31, which is 31 4-byte words, or 124 bytes.
- UDFs only work on ingress Port ACLs.

---

## 12.4.8 ACL, Route Map, and Prefix List Commands

This section describes CLI commands that this chapter references.

### ACL Creation and Access Commands

- [hardware access-list resource sharing vlan in](#)
- [hardware access-list resource sharing vlan ipv4 out](#)
- [ip access-list](#)
- [ip access-list standard](#)
- [ipv6 access-list](#)
- [ipv6 access-list standard](#)
- [mac access-list](#)
- [system profile](#)

### ACL Implementation Commands

- [ip access-group](#)
- [ipv6 access-group](#)
- [mac access-group](#)

### Service ACL Implementation Commands

- [ip access-group \(Service ACLs\)](#)
- [ipv6 access-group \(Service ACLs\)](#)

### ACL Edit Commands

- [counters per-entry \(ACL configuration modes\)](#)
- [hardware access-list update default-result permit](#)
- [no <sequence number> \(ACLs\)](#)
- [resequence \(ACLs\)](#)
- [show \(ACL configuration modes\)](#)

### ACL Rule Commands

- [deny \(IPv4 ACL\)](#)
- [deny \(IPv6 ACL\)](#)
- [deny \(MAC ACL\)](#)
- [deny \(Standard IPv4 ACL\)](#)
- [deny \(Standard IPv6 ACL\)](#)
- [permit \(IPv4 ACL\)](#)
- [permit \(IPv6 ACL\)](#)
- [permit \(MAC ACL\)](#)
- [permit \(Standard IPv4 ACL\)](#)
- [permit \(Standard IPv6 ACL\)](#)
- [remark](#)

### ACL List Counter Commands

- [clear ip access-lists counters](#)
- [clear ipv6 access-lists counters](#)
- [hardware counter feature acl out](#)

**ACL Display Commands**

- [show ip access-lists](#)
- [show ipv6 access-lists](#)
- [show mac access-lists](#)

**Prefix List Creation and Access Commands**

- [ip prefix-list](#)
- [ipv6 prefix-list](#)

**Prefix List Edit Commands**

- [deny \(IPv6 Prefix List\)](#)
- [permit \(IPv6 Prefix List\)](#)
- [seq \(IPv6 Prefix Lists\)](#)

**Prefix List Display Commands**

- [show hardware tcam profile](#)
- [show ip prefix-list](#)
- [show ipv6 prefix-list](#)
- [show platform trident tcam](#)
- [show platform fap acl](#)
- [show platform fap acl tcam](#)
- [show platform arad acl tcam](#)
- [show platform arad acl tcam summary](#)
- [show platform arad mapping](#)
- [show platform fap acl tcam hw](#)

**Route Map Creation and Access Command**

- [route-map](#)

**Route Map Edit Commands**

- [continue \(route map\)](#)
- [description \(route map\)](#)
- [match \(route-map\)](#)
- [set \(route-map\)](#)
- [set as-path prepend](#)
- [set as-path match](#)
- [set community \(route-map\)](#)
- [set extcommunity \(route-map\)](#)

**Route Map Display Commands**

- [show route-map](#)

---

### 12.4.8.1 clear ip access-lists counters

The **clear ip access-lists counters** command sets ACL counters to zero for the specified IPv4 access control list (ACL). The **session** parameter limits ACL counter clearing to the current CLI session.

#### Command Mode

Privileged EXEC

#### Command Syntax

```
clear ip access-lists counters [ACL_NAME][SCOPE]
```

#### Parameters

- ACL\_NAME Name of ACL. Options include:
  - *<no parameter>* all ACLs.
  - *access\_list* name of ACL.
- SCOPE Session affected by command. Options include:
  - *<no parameter>* command affects counters on all CLI sessions.
  - *session* affects only current CLI session.

#### Example

This command resets all IPv4 ACL counters.

```
switch(config) #clear ip access-lists counters
switch(config) #
```



### 12.4.8.2 clear ipv6 access-lists counters

The **clear ipv6 access-lists counters** command sets ACL counters to zero for the specified IPv6 access control list (ACL). The **session** parameter limits ACL counter clearing to the current CLI session.

#### Command Mode

Privileged EXEC

#### Command Syntax

```
clear ipv6 access-lists counters [ACL_NAME][SCOPE]
```

#### Parameters

- ACL\_NAME name of ACL. Options include:
  - *<no parameter>* all IPv6 ACLs.
  - *access\_list* name of IPv6 ACL.
- SCOPE Session affected by command. Options include:
  - *<no parameter>* command affects counters on all CLI sessions.
  - *session* affects only current CLI session.

#### Example

This command resets all IPv6 ACL counters.

```
switch(config)#clear ipv6 access-lists counters
switch(config)#
```

---

### 12.4.8.3 continue (route map)

The **continue** command creates a route map statement entry that enables additional route map evaluation of routes whose parameters meet the statement's matching criteria.

A statement typically contains a [match \(route-map\)](#) and a [set \(route-map\)](#) command. The evaluation of routes whose settings are the same as **match** command parameters normally ends and the statement's **set** commands are applied to the route. Routes that match a statement containing a **continue** command are evaluated against the statement specified by the continue command.

When a route matches multiple route map commands, the filter action (deny or permit) is determined by the last statement that the route matches. The **set** commands in all statements matching the route are applied to the route after the route map evaluation is complete. Multiple set commands are applied in the same order by which the route was evaluated against the statement containing them.

The **no continue** and **default continue** commands remove the corresponding **continue** command from the configuration mode route map statement by deleting the corresponding command from **running-config**.

#### Command Mode

Route-Map Configuration

#### Command Syntax

```
continue NEXT_SEQ
no continue NEXT_SEQ
default continue NEXT_SEQ
```

#### Parameters

- **NEXT\_SEQ** Specifies next statement for evaluating matching routes. Options include:
  - *<no parameter>* Next statement in the route map, as determined by sequence number.
  - *seq\_number* Specifies the number of the next statement. Values range from 1 to 16777215.

#### Restrictions

A **continue** command cannot specify a sequence number smaller than the sequence number of its route map statement.

#### Related Command

[route-map](#) command enters route map configuration mode.

#### Example

This command creates route map map1, statement 40 with a match command, a set command, and a continue command. Routes that match the statement are subsequently evaluated against statement 100. The **set local-preference** command is applied to matching routes regardless of subsequent matching operations.

```
switch(config)#route-map map1 deny 40
switch(config-route-map-map1)#match as 15
switch(config-route-map-map1)#continue 100
switch(config-route-map-map1)#set local-preference 50
switch(config-route-map-map1)#
```

#### 12.4.8.4 counters per-entry (ACL configuration modes)

The **counters per-entry** command places the ACL in counting mode. An ACL in counting mode displays the number of instances each rule in the list matches an inbound packet and the elapsed time since the last match. The show access list commands display the statistics next to each rule in the ACL.

On the FM6000 platform, this command has no effect when used in an ACL that is part of a PBR class map.

The **no counters per-entry** and **default counters per-entry** commands place the ACL in non-counting mode.

##### Command Mode

ACL Configuration

IPv6-ACL Configuration

Std-ACL Configuration

Std-IPv6-ACL Configuration

MAC-ACL Configuration

##### Command Syntax

```
counters per-entry
```

```
no counters per-entry
```

```
default counters per-entry
```

##### Examples

- This command places the test1 ACL in counting mode.

```
switch(config)#ip access-list test1
switch(config-acl-test1)#counters per-entry
switch(config-acl-test1)#
```

- This command displays the ACL, with counter information, for an ACL in counting mode.

```
switch#show ip access-lists
IP Access List default-control-plane-acl [readonly]
 counters per-entry
 10 permit icmp any any
 20 permit ip any any tracked [match 12041, 0:00:00 ago]
 30 permit ospf any any
 40 permit tcp any any eq ssh telnet www snmp bgp https [match 11,
 1:41:07 ago]
 50 permit udp any any eq bootps bootpc snmp rip [match 78, 0:00:27
 ago]
 60 permit tcp any any eq mlag ttl eq 255
 70 permit udp any any eq mlag ttl eq 255
 80 permit vrrp any any
 90 permit ahp any any
 100 permit pim any any
 110 permit igmp any any [match 14, 0:23:27 ago]
 120 permit tcp any any range 5900 5910
 130 permit tcp any any range 50000 50100
 140 permit udp any any range 51000 51100
```

---

### 12.4.8.5 deny (IPv4 ACL)

The **deny** command adds a deny rule to the configuration mode IPv4 access control list (ACL). Packets filtered by a **deny** rule are dropped by interfaces to which the ACL is applied. Sequence numbers determine rule placement in the ACL. Sequence numbers for commands without numbers are derived by adding 10 to the number of the ACL's last rule.

The **no deny** and **default deny** commands remove the specified rule from the configuration mode ACL. The **no <sequence number> (ACLs)** command also removes the specified rule from the ACL.

#### Command Mode

ACL Configuration

#### Command Syntax

```
[SEQ_NUM] deny PROTOCOL SOURCE_ADDR [SOURCE_PORT] DEST_ADDR [DEST_PORT]
[FLAGS][MESSAGE][fragments][tracked][DSCP_FILTER][TTL_FILTER][log]
```

```
no deny PROTOCOL SOURCE_ADDR [SOURCE_PORT] DEST_ADDR [DEST_PORT][FLAGS]
[MESSAGE][fragments][tracked][DSCP_FILTER][TTL_FILTER][log]
```

```
default deny PROTOCOL SOURCE_ADDR [SOURCE_PORT] DEST_ADDR [DEST_PORT]
[FLAGS][MESSAGE][fragments][tracked][DSCP_FILTER][TTL_FILTER][log]
```



**Note:** Commands use a subset of the listed fields. Available parameters depend on specified protocol. Use CLI syntax assistance to view options for specific protocols when creating a deny rule.

#### Parameters

- SEQ\_NUM Sequence number assigned to the rule. Options include:
  - *<no parameter>* Number is derived by adding 10 to the number of the ACL's last rule.
  - *<14294967295>* Number assigned to entry.
- PROTOCOL protocol field filter. Values include:
  - ahp Authentication Header Protocol (51).
  - icmp Internet Control Message Protocol (1).
  - igmp Internet Group Management Protocol (2).
  - ip Internet Protocol v4 (4).
  - ospf Open Shortest Path First (89).
  - pim Protocol Independent Multicast (103).
  - tcp Transmission Control Protocol (6).
  - udp User datagram protocol (17).
  - vrrp Virtual Router Redundancy Protocol (112).
  - *protocol\_num* Integer corresponding to an IP protocol. Values range from 0 to 255.
- SOURCE\_ADDR and DEST\_ADDR Source and destination address filters. Options include:
  - *network\_addr* Subnet address (CIDR or address-mask).
  - any Packets from all addresses are filtered.
  - host *ip\_addr* IP address (dotted decimal notation).Subnet addresses support discontinuous masks.

- SOURCE\_PORT and DEST\_PORT Source and destination port filters. Options include:
  - any All ports
  - eq *port-1 port-2 ... port-n* A list of ports. Maximum list size is 10 ports.
  - neq *port-1 port-2 ... port-n* The set of all ports not listed. Maximum list size is 10 ports.
  - gt *port* The set of ports with larger numbers than the listed port.
  - lt *port* The set of ports with smaller numbers than the listed port.
  - range *port\_1 port\_2* The set of ports whose numbers are between the range.
- fragments Filters packets with FO bit set (indicates a non-initial fragment packet).
- FLAGS Flag bit filters (TCP packets). Use CLI syntax assistance (?) to display options.
- MESSAGE Message type filters (ICMP packets). Use CLI syntax assistance (?) to display options.
- tracked Rule filters packets in existing ICMP, UDP, or TCP connections.
  - Valid in ACLs applied to the control plane.
  - Validity in ACLs applied to data plane varies by switch platform.
- DSCP\_FILTER Rule filters packet by its DSCP value. Values include:
  - *<no parameter>* Rule does not use DSCP to filter packets.
  - dscp *dscp\_value* Packets match if DSCP field in packet is equal to *dscp\_value*.
- TTL\_FILTER Rule filters packet by its TTL (time-to-live) value. Values include:
  - ttl eq *ttl\_value* Packets match if **ttl** in packet is equal to *ttl\_value*.
  - ttl gt *ttl\_value* Packets match if **ttl** in packet is greater than *ttl\_value*.
  - ttl lt *ttl\_value* Packets match if **ttl** in packet is less than *ttl\_value*.
  - ttl neq *ttl\_value* Packets match if **ttl** in packet is not equal to *ttl\_value*.
    - Valid in ACLs applied to the control plane.
    - Validity in ACLs applied to data plane varies by switch platform.
- log Triggers an informational log message to the console about the matching packet.
  - Valid in ACLs applied to the control plane.
  - Validity in ACLs applied to data plane varies by switch platform.

### Examples

- This command appends a **deny** statement at the end of the ACL. The **deny** statement drops OSPF packets from *10.10.1.1/24* to any host.

```
switch(config)#ip access-list text1
switch(config-acl-text1)#deny ospf 10.1.1.0/24 any
switch(config-acl-text1)#
```

- This command inserts a **deny** statement with the sequence number 65. The **deny** statement drops all PIM packets.

```
switch(config-acl-text1)#65 deny pim any any
switch(config-acl-text1)#
```

## 12.4.8.6 deny (IPv6 ACL)

The **deny** command adds a deny rule to the configuration mode IPv6 access control list (ACL). Packets filtered by a **deny** rule are dropped by interfaces to which the ACL is applied. Sequence numbers determine rule placement in the ACL. Sequence numbers for commands without numbers are derived by adding 10 to the number of the ACL's last rule.

The **no deny** and **default deny** commands remove the specified rule from the configuration mode ACL. The **no <sequence number> (ACLs)** command also removes the specified rule from the ACL.

### Command Mode

IPv6-ACL Configuration

### Command Syntax

```
[SEQ_NUM] deny PROT SRC_ADDR [SRC_PT] DEST_ADDR [DEST_PT][FLAG] [MSG][hop]
[tracked][DSCP_FILTER] [log]
```

```
no deny PROT SRC_ADDR [SOURCE_PT] DEST_ADDR [DEST_PT][FLAG][MSG][hop][tracked]
[DSCP_FILTER][log]
```

```
default deny PROT SRC_ADDR [SOURCE_PT] DEST_ADDR [DEST_PT][FLAG][MSG] [hop]
[tracked][DSCP_FILTER][log]
```



**Note:** Commands use a subset of the listed fields. Available parameters depend on specified protocol. Use CLI syntax assistance to view options for specific protocols when creating a deny rule.

### Parameters

- SEQ\_NUM Sequence number assigned to the rule. Options include:
  - *<no parameter>* Number is derived by adding 10 to the number of the ACL's last rule.
  - *<1 - 4294967295>* Number assigned to entry.
- PROT Protocol field filter. Values include:
  - *icmpv6* Internet Control Message Protocol for version 6 (58).
  - *ipv6* Internet Protocol IPv6 (41).
  - *ospf* Open Shortest Path First (89).
  - *tcp* Transmission Control Protocol (6).
  - *udp* User Datagram Protocol (17).
  - *protocol\_num* Integer corresponding to an IP protocol. Values range from 0 to 255.
- SRC\_ADDR and DEST\_ADDR Source and destination address filters. Options include:
  - *ipv6\_prefix* IPv6 address with prefix length (CIDR notation).
  - *any* Packets from all addresses are filtered.
  - *host ipv6\_addr* IPv6 host address.
- SRC\_PT and DEST\_PT Source and destination port filters. Options include:
  - *any* All ports.
  - *eq port-1 port-2 ... port-n* A list of ports. Maximum list size is 10 ports.
  - *neq port-1 port-2 ... port-n* The set of all ports not listed. Maximum list size is 10 ports.
  - *gt port* The set of ports with larger numbers than the listed port.
  - *lt port* The set of ports with smaller numbers than the listed port.
  - *range port\_1 port\_2* The set of ports whose numbers are between the range.

- HOP Filters by packet's hop-limit value. Options include:
  - *<no parameter>* Rule does not use hop limit to filter packets.
  - *hop-limit eq hop\_value* Packets match if hop-limit value in packet equals *hop\_value*.
  - *hop-limit gt hop\_value* Packets match if hop-limit in packet is greater than *hop\_value*.
  - *hop-limit lt hop\_value* Packets match if hop-limit in packet is less than *hop\_value*.
  - *hop-limit neq hop\_value* Packets match if hop-limit in packet is not equal to ***hop\_value***.
- FLAG Flag bit filters (TCP packets). Use CLI syntax assistance (?) to display options.
- MSG Message type filters (ICMPv6 packets). Use CLI syntax assistance (?) to display options.
- tracked Rule filters packets in existing ICMP, UDP, or TCP connections.
  - Valid in ACLs applied to the control plane.
  - Validity in ACLs applied to data plane varies by switch platform.
- DSCP\_FILTER Rule filters packet by its DSCP value. Values include:
  - *<no parameter>* Rule does not use DSCP to filter packets.
  - *dscp dscp\_value* Packets match if DSCP field in packet is equal to *dscp\_value*.
- log Triggers an informational log message to the console about the matching packet.
  - Valid in ACLs applied to the control plane.
  - Validity in ACLs applied to data plane varies by switch platform.

### Example

This command appends a **deny** statement at the end of the ACL. The **deny** statement drops IPv6 packets from *3710:249a:c643:ef11::/64* to any host.

```
switch(config)#ipv6 access-list text1
switch(config-acl-text1)#deny ipv6 3710:249a:c643:ef11::/64 any
switch(config-acl-text1)#
```

---

### 12.4.8.7 deny (IPv6 Prefix List)

The **deny** command adds a rule to the configuration mode IPv6 prefix list. Route map match commands use prefix lists to filter routes for redistribution into OSPF, RIP, or BGP domains. Routes are denied access when they match the prefix that a **deny** statement specifies.

The **no deny** and **default deny** commands remove the specified rule from the configuration mode prefix list. The **no seq (IPv6 Prefix Lists)** command also removes the specified rule from the prefix list.

#### Command Mode

IPv6-pfx Configuration

#### Command Syntax

```
[SEQUENCE] deny ipv6_prefix [MASK]
```

#### Parameters

- SEQUENCE Sequence number assigned to the rule. Options include:
  - *<no parameter>* Number is derived by adding 10 to the number of the list's last rule.
  - *seq seq\_num* Number is specified by *seq\_num*. Value ranges from 0 to 65535.
- *ipv6\_prefix* IPv6 prefix upon which command filters routes (CIDR notation).
- MASK Range of the prefix to be matched.
  - *<no parameter>* Exact match with the subnet mask is required.
  - *eq mask\_e* Prefix length is equal to *mask\_e*.
  - *ge mask\_g* Range is from *mask\_g* to 128.
  - *le mask\_l* Range is from *subnet* mask length to *mask\_l*.
  - *ge mask\_l le mask\_g* Range is from *mask\_g* to *mask\_l*.

*mask\_e, mask\_land, and mask\_g* range from 1 to 128.

When *le* and *ge* are specified, *subnet* mask > *mask\_g*>*mask\_l*

#### Example

This command appends a **deny** statement at the end of the text1 prefix list. The **deny** statement denies redistribution of routes with the specified prefix.

```
switch(config)#ipv6 prefix-list route-five
switch(config-ipv6-pfx)#deny 3100::/64
switch(config-ipv6-pfx)#
```



### 12.4.8.8 deny (MAC ACL)

The **deny** command adds a deny rule to the configuration mode MAC access control list (ACL). Packets filtered by a deny rule are dropped by interfaces to which the ACL is applied. Sequence numbers determine rule placement in the ACL. Sequence numbers for commands without numbers are derived by adding 10 to the number of the ACL's last rule.

The **no deny** and **default deny** commands remove the specified rule from the configuration mode ACL. The **no <sequence number> (ACLs)** command also removes the specified rule from the ACL.

#### Command Mode

MAC-ACL Configuration

#### Command Syntax

```
[SEQ_NUM] deny SOURCE_ADDR DEST_ADDR [PROTOCOL][log]
```

```
no deny SOURCE_ADDR DEST_ADDR [PROTOCOL][log]
```

```
default deny SOURCE_ADDR DEST_ADDR [PROTOCOL][log]
```

#### Parameters

- SEQ\_NUM Sequence number assigned to the rule. Options include:
  - *<no parameter>* Number is derived by adding 10 to the number of the ACL's last rule.
  - *<1 - 4294967295>* Number assigned to entry.
- SOURCE\_ADDR and DEST\_ADDR Source and destination address filters. Options include:
  - *mac\_address mac\_mask* MAC address and mask.
  - any Packets from all addresses are filtered.
  - *mac\_address* specifies a MAC address in 3x4 dotted hexadecimal notation (hhhh.hhhh.hhhh).
  - *mac\_mask* specifies a MAC address mask in 3x4 dotted hexadecimal notation (hhhh.hhhh.hhhh).
  - *0* bits require an exact match to filter.
  - *1* bits filter on any value.
- PROTOCOL Protocol field filter. Values include:
  - aarp Appletalk Address Resolution Protocol (0x80f3).
  - appletalk Appletalk (0x809b).
  - arp Address Resolution Protocol (0x806).
  - ip Internet Protocol Version 4 (0x800).
  - ipx Internet Packet Exchange (0x8137).
  - lldp LLDP (0x88cc).
  - novell Novell (0x8138).
  - rarp Reverse Address Resolution Protocol (0x8035).
  - *protocol\_num* Integer corresponding to a MAC protocol. Values range from 0 to 65535
- log Triggers an informational log message to the console about the matching packet.

#### Examples

- This command appends a permit statement at the end of the ACL. The deny statement drops all aarp packets from *10.1000.0000* through *10.1000.FFFF* to any host.

```
switch(config)#mac access-list text1
switch(config-mac-acl-text1)#deny 10.1000.0000 0.0.FFFF any aarp
```

- 
- This command inserts a permit statement with the sequence number 25. The deny statement drops all packets through the interface.

```
switch(config-mac-acl-text1)#25 deny any any
```

### 12.4.8.9 deny (Standard IPv4 ACL)

The **deny** command adds a deny rule to the configuration mode standard IPv4 access control list (ACL). Standard ACL rules filter on the source field.

Packets filtered by a **deny** rule are dropped by interfaces to which the ACL is applied. Sequence numbers determine rule placement in the ACL. Sequence numbers for commands without numbers are derived by adding 10 to the number of the ACL's last rule.

The **no deny** and **default deny** commands remove the specified rule from the configuration mode ACL. The **no <sequence number> (ACLs)** command also removes the specified rule from the ACL.

#### Command Mode

Std-ACL Configuration

#### Command Syntax

```
[SEQ_NUM] deny SOURCE_ADDR [log]
```

```
no deny SOURCE_ADDR [log]
```

```
default deny SOURCE_ADDR [log]
```

#### Parameters

- SEQ\_NUM Sequence number assigned to the rule. Options include:
  - *<no parameter>* Number is derived by adding 10 to the number of the ACL's last rule.
  - *<1 - 4294967295>* Number assigned to entry.
- SOURCE\_ADDR Source address filter. Options include:
  - *network\_addr* Subnet address (CIDR or address-mask).
  - *any* Packets from all addresses are filtered.
  - *host ip\_addr* IP address (dotted decimal notation).  
Subnet addresses support discontinuous masks.
- log Triggers an informational log message to the console about the matching packet.
  - Valid in ACLs applied to the control plane.
  - Validity in ACLs applied to data plane varies by switch platform.

#### Example

This command appends a **deny** statement at the end of the ACL. The **deny** statement drops packets from *10.10.1.1/24*.

```
switch(config)#ip access-list standard text1
switch(config-std-acl-text1)#deny 10.1.1.1/24
switch(config-std-acl-text1)#
```

---

### 12.4.8.10 deny (Standard IPv6 ACL)

The **deny** command adds a deny rule to the configuration mode standard IPv6 access control list (ACL). Standard ACL rules filter on the source field.

Packets filtered by a **deny** rule are dropped by interfaces to which the ACL is applied. Sequence numbers determine rule placement in the ACL. Sequence numbers for commands without numbers are derived by adding 10 to the number of the ACL's last rule.

The **no deny** and **default deny** commands remove the specified rule from the configuration mode ACL. The **no <sequence number> (ACLs)** command also removes the specified rule from the ACL.

#### Command Mode

Std-IPv6-ACL Configuration

#### Command Syntax

```
[SEQ_NUM] deny SOURCE_ADDR
```

```
no deny SOURCE_ADDR
```

```
default deny SOURCE_ADDR
```

#### Parameters

- SEQ\_NUM Sequence number assigned to the rule. Options include:
  - *<no parameter>* Number is derived by adding 10 to the number of the ACL's last rule.
  - *<1 - 4294967295>* Number assigned to entry.
- SOURCE\_ADDR Source address filter. Options include:
  - *ipv6\_prefix* IPv6 address with prefix length (CIDR notation).
  - *any* Packets from all addresses are filtered.
  - *host ipv6\_addr* IPv6 host address.

#### Example

This command appends a **deny** statement at the end of the ACL. The **deny** statement drops packets from *2103::/64*.

```
switch(config)#ipv6 access-list standard text1
switch(config-std-acl-ipv6-text1)#deny 2103::/64
switch(config-std-acl-ipv6-text1)#
```

### 12.4.8.11 description (route map)

The **description** command adds a text string to the configuration mode route map. The string has no functional impact on the route map.

The **no description** and **default description** commands remove the text string from the configuration mode route map by deleting the corresponding **description** command from **running-config**.

#### Command Mode

Route-Map Configuration

#### Command Syntax

```
description label_text
```

```
no description
```

```
default description
```

#### Parameters

*label\_text* Character string assigned to the route map configuration.

#### Related Command

[route-map](#).

#### Example

These commands add description text to the *XYZ-1* route map.

```
switch(config)#route-map XYZ-1
switch(config-route-map-XYZ-1)#description This is the first map.
switch(config-route-map-XYZ-1)#exit
switch(config)#show route-map XYZ-1
route-map XYZ-1 permit 10
 Description:
 description This is the first map.
 Match clauses:
 Set clauses:
switch(config)#
```

---

### 12.4.8.12 hardware access-list resource sharing vlan in

The **hardware access-list resource sharing vlan in** command enables the IPv4 Ingress Sharing of hardware resources on the switch same ACL is applied on different VLANs.

The **no hardware access-list resource sharing vlan in** command disables the IPv4 Ingress Sharing of hardware resources on the switch.

#### Command Mode

Global Configuration

#### Command Syntax

```
hardware access-list resource sharing vlan in
```

```
no hardware access-list resource sharing vlan in
```

#### Guidelines

- This command is compatible only with the DCS-7010 and DCS-7050x series switches.
- Enabling IPv4 Ingress Sharing requires the restart of software agents on the platform. This is a disruptive process and impacts traffic forwarding.

Use the **show platform trident** command to verify the Ingress IPv4 Sharing information.

### 12.4.8.13 hardware access-list resource sharing vlan ipv4 out

The **hardware access-list resource sharing vlan ipv4 out** command enables the IPv4 Egress RACL TCAM sharing on the switch.

The **no hardware access-list resource sharing vlan ipv4 out** command disables the IPv4 Egress RACL TCAM sharing on the switch. By default, the IPv4 Egress RACL sharing is enabled on the switch.

#### Command Mode

Global Configuration

#### Command Syntax

```
hardware access-list resource sharing vlan ipv4 out
no hardware access-list resource sharing vlan ipv4 out
```

#### Guidelines

- This command is compatible only with the DCS-7280E and DCS-7500E series switches.
- Disabling IPv4 RACL sharing requires the restart of software agents on the platform. This is a disruptive process and impacts traffic forwarding.
- Enabling IPv4 RACL sharing, if previously disabled from the default configuration, requires the restart of software agents on the platform. This is a disruptive process and impacts traffic forwarding. Enabling IPv4 RACL sharing if uRPF is configured will disable uRPF.
- Use **show running-config all | include sharing** command to verify whether or not sharing for egress IPv4 RACLs is enabled.

#### Example

This command verifies whether IPv4 RACL sharing is enabled or disabled.

```
switch#show running-config all | include sharing
hardware access-list resource sharing vlan ipv4 out
----->It returns the following output if IPv4 RACL
sharing is enabled.
```

---

#### 12.4.8.14 hardware access-list update default-result permit

The **hardware access-list update default-result permit** command configures the switch to permit all traffic on Ethernet and VLAN interfaces with ACLs applied to them while those ACLs are being modified. Traffic is permitted when the ACL is available for modification using one of the **ip access-list** commands, and ends when the ACL configuration mode is exited and rules are populated in hardware. This command is disabled by default.

The **no hardware access-list update default-result permit** and **default hardware access-list update default-result permit** commands restore the switch to its default state (blocking traffic during ACL modifications) by removing the corresponding **hardware access-list update default-result permit** command from the *running-config*.

##### Command Mode

Global Configuration

##### Command Syntax

```
hardware access-list update default-result permit
no hardware access-list update default-result permit
default hardware access-list update default-result permit
```

##### Restrictions

This command is available on the Arista 7050X, 7060X, 7150, 7250X, 7280, 7280R, 7300X, 7320X, and 7500 series switches.

This command does not support egress ACLs.

While this command is enabled, static NAT, and ACL-based mirroring are affected during ACL updates.

##### Example

This command configures a 7150 series switch to permit all traffic on Ethernet and VLAN interfaces with ACLs applied to them while those ACLs are being modified.

```
switch(config)#hardware access-list update default-result permit
switch(config)#
```



### 12.4.8.15 hardware counter feature acl out

The **hardware counter feature acl out** command enables egress ACL hardware counters for IPv4 or IPv6, which count the number of packets hitting rules associated with egress ACLs applied to various interfaces on a switch.

The **no hardware counter feature acl out** and **default hardware counter feature acl out** commands disable or return the egress ACL hardware counters to the default state.

#### Command Mode

Global Configuration

#### Command Syntax

```
hardware counter feature acl out [OPTIONS]
```

```
no hardware counter feature acl out [OPTIONS]
```

```
default hardware counter feature acl out [OPTIONS]
```

#### Parameters

- *OPTIONS* ACL hardware counter options include:
  - ipv4 Address family IPv4.
  - ipv6 Address family IPv6.

#### Examples

- This command enables IPv4 egress ACL hardware counters.

```
switch(config)#hardware counter feature acl out ipv4
switch(config)#
```

- This command disables IPv4 egress ACL hardware counters.

```
switch(config)#no hardware counter feature acl out ipv4
switch(config)#
```

---

### 12.4.8.16 ip access-group (Service ACLs)

The `ip access-group (Service ACLs)` command configures a Service ACL to be applied by a control-plane service. The service is specified by the command mode in which the Service ACL is applied.

The `no ip access-group (Service ACLs)` and `default ip access-group (Service ACLs)` commands remove the corresponding `ip access-group (Service ACLs)` command from *running-config*.

#### Command Mode

Mgmt-SSH Configuration

Mgmt-API Configuration

Router-BGP Configuration

Router-OSPF Configuration

Router-IGMP Configuration

MPLS-LDP Configuration

Queue-Monitor-Streaming Configuration

MPLS-Ping Configuration

Mgmt-Telnet Configuration

#### Command Syntax

```
ip access-group acl_name [vrf vrf_name][in]
no ip access-group acl_name [vrf vrf_name][in]
default ip access-group acl_name [vrf vrf_name][in]
```

#### Parameters

Parameters vary by process.

- *acl\_name* Name of the Service ACL assigned to control-plane service.
- *vrf vrf\_name* Specifies the VRF in which the Service ACL is to be applied.
- *in* Specifies inbound connections or packets only (keyword required for SSH and Telnet services).

#### Example

These commands apply the Service ACL *bgpacl* to the BGP routing protocol in VRF *purple*.

```
(config)# router bgp 5
(config-router-bgp)# vrf purple
(config-router-bgp-vrf-purple)# ip access-group bgpacl
```

For additional configuration examples, see [Configuring Service ACLs and Displaying Status and Counters](#).

### 12.4.8.17 ip access-group

The **ip access-group** command applies an IPv4 or standard IPv4 access control list (ACL) to the configuration mode interface or subinterface.

The **no ip access-group** and **default ip access-group** commands remove the corresponding **ip access-group** command from *running-config*.

#### Command Mode

Interface-Ethernet Configuration

Interface-Port-Channel Configuration

Interface-VLAN Configuration

#### Command Syntax

```
ip access-group list_name DIRECTION
no ip access-group list_name DIRECTION
default ip access-group list_name DIRECTION
```

#### Parameters

- *list\_name* Name of ACL assigned to interface.
- DIRECTION Transmission direction of packets, relative to interface. Valid options include:
  - in Inbound packets.
  - out Outbound packets.

#### Restrictions

Filtering of outbound packets by ACLs is not supported on Petra platform switches.

Filtering of outbound packets by ACLs on FM6000 switches is supported on physical interfaces only (Ethernet and port channels).

ACLs on sub-interfaces are supported on DCS-7280E, DCS-7500E, DCS-7280R, and DCS-7500R.

#### Example

These commands apply the IPv4 ACL named *test2* to *Ethernet interface 3*.

```
switch(config)#interface ethernet 3
switch(config-if-Et3)#ip access-group test2 in
switch(config-if-Et3)#
```

---

### 12.4.8.18 ip access-list standard

The **ip access-list standard** command places the switch in std-ACL configuration mode, which is a group change mode that modifies a standard IPv4 access control list. The command specifies the name of the standard IPv4 ACL that subsequent commands modify, and creates an ACL if it references a nonexistent list. All group change mode edit session changes are pending until the session ends.

The **exit** command saves pending ACL changes to **running-config**, then returns the switch to global configuration mode. Pending changes are also saved by entering a different configuration mode.

The **abort** command discards pending ACL changes, returning the switch to global configuration mode.

The **no ip access-list standard** and **default ip access-list standard** commands delete the specified ACL.

#### Command Mode

Global Configuration

#### Command Syntax

```
ip access-list standard list_name
no ip access-list standard list_name
default ip access-list standard list_name
```

#### Parameters

- **list\_name** Name of standard ACL. Must begin with an alphabetic character. Cannot contain spaces or quotation marks.

#### Commands Available in std-ACL configuration mode:

- [deny \(Standard IPv4 ACL\)](#)
- [no <sequence number> \(ACLs\)](#)
- [permit \(Standard IPv4 ACL\)](#)
- [remark](#)
- [resequence \(ACLs\)](#)
- [show \(ACL configuration modes\)](#)

#### Related Commands

- [ip access-list](#) Enters ACL configuration mode for editing IPv4 ACLs.
- [show ip access-lists](#) Displays IPv4 and standard IPv4 ACLs.

#### Examples

- This command places the switch in std-ACL configuration mode to modify the **filter2** IPv4 ACL.

```
switch(config)#ip access-list standard filter2
switch(config-std-acl-filter2)#
```

- This command saves changes to **filter2** ACL, then returns the switch to global configuration mode.

```
switch(config-std-acl-filter2)#exit
switch(config)#
```

- This command discards changes to **filter2**, then returns the switch to global configuration mode.

```
switch(config-std-acl-filter2)#abort
switch(config)#
```

### 12.4.8.19 ip access-list

The **ip access-list** command places the switch in ACL configuration mode, which is a group change mode that modifies an IPv4 access control list. The command specifies the name of the IPv4 ACL that subsequent commands modify and creates an ACL if it references a nonexistent list. All changes in a group change mode edit session are pending until the end of the session.

The **exit** command saves pending ACL changes to **running-config**, then returns the switch to global configuration mode. ACL changes are also saved by entering a different configuration mode.

The **abort** command discards pending ACL changes, returning the switch to global configuration mode.

The **no ip access-list** and **default ip access-list** commands delete the specified IPv4 ACL.

#### Command Mode

Global Configuration

#### Command Syntax

```
ip access-list list_name
no ip access-list list_name
default ip access-list list_name
```

#### Parameters

- *list\_name* Name of ACL. Must begin with an alphabetic character. Cannot contain spaces or quotation marks.

#### Commands Available in ACL configuration mode:

- [deny \(IPv4 ACL\)](#)
- [no <sequence number> \(ACLs\)](#)
- [permit \(IPv4 ACL\)](#)
- [remark](#)
- [resequence \(ACLs\)](#)
- [show \(ACL configuration modes\)](#)

#### Related Commands:

- [ip access-list standard](#) Enters **std-acl configuration mode** for editing standard IP ACLs.
- [show ip access-lists](#) Displays IP and standard ACLs.

#### Examples

- This command places the switch in ACL configuration mode to modify the **filter1** IPv4 ACL.

```
switch(config)#ip access-list filter1
switch(config-acl-filter1)#
```

- This command saves changes to **filter1** ACL, then returns the switch to global configuration mode.

```
switch(config-acl-filter1)#exit
switch(config)#
```

- This command discards changes to **filter1**, then returns the switch to global configuration mode.

```
switch(config-acl-filter1)#abort
switch(config)#
```

## 12.4.8.20 ip prefix-list

The `ip prefix-list` command creates a prefix list or adds an entry to an existing list. Route map match commands use prefix lists to filter routes for redistribution into OSPF, RIP, or BGP domains.

A prefix list comprises all prefix list entries with the same label. The sequence numbers of the rules in a prefix list specify the order that the rules are applied to a route that the match command is evaluating.

The `no ip prefix-list` and `default ip prefix-list` commands delete the specified prefix list entry by removing the corresponding `ip prefix-list` statement from *running-config*. If the `no` or `default ip prefix-list` command does not list a sequence number, the command deletes all entries of the prefix list.

### Command Mode

Global Configuration

### Command Syntax

```
ip prefix-list list_name [SEQUENCE] FILTER_TYPE network_addr [MASK]
```

```
no ip prefix-list list_name [SEQUENCE]
```

```
default ip prefix-list list_name [SEQUENCE]
```

### Parameters

- *list\_name* The label that identifies the prefix list.
- SEQUENCE Sequence number of the prefix list entry. Options include
  - *<no parameter>* Entry's number is ten plus highest sequence number in current list.
  - *seq seq\_num* Number assigned to entry. Value ranges from 0 to 65535.
- FILTER\_TYPE Specifies route access when it matches IP prefix list. Options include:
  - *permit* Routes are permitted access when they match the specified subnet.
  - *deny* Routes are denied access when they match the specified subnet.
- *network\_addr* Subnet upon which command filters routes. Format is CIDR or address-mask.
- MASK Range of the prefix to be matched.
  - *<no parameter>* Exact match with the subnet mask is required.
  - *eq mask\_e* Prefix length is equal to *mask\_e*.
  - *ge mask\_g* Range is from *mask\_g* to 32.
  - *le mask\_l* Range is from *subnet* mask length to *mask\_l*.
  - *ge mask\_l le mask\_g* Range is from *mask\_g* to *mask\_l*.

*mask\_e*, *mask\_l*, and *mask\_g* range from 1 to 32. When *le* and *ge* are specified, *subnet* mask > *mask\_g* > *mask\_l*.

### Example .

- This command places the switch in IPv4 prefix list configuration mode to create an IPv4 prefix list named *route-one*.

```
switch(config)#ip prefix-list route-one
switch(config-ip-pfx)#
```

- These commands create four different rules for the prefix-list named *route-one*.

```
switch(config)#ip prefix-list route-one
switch(config-ip-pfx)#seq 10 deny 10.1.1.0/24
switch(config-ip-pfx)#seq 20 deny 10.1.0.0/16
switch(config-ip-pfx)#seq 30 permit 12.15.4.9/32
switch(config-ip-pfx)#seq 40 deny 1.1.1.0/24
```

### 12.4.8.21 ipv6 access-group (Service ACLs)

The `ipv6 access-group (Service ACLs)` command configures an IPv6 or standard IPv6 Service ACL to be applied by a control-plane service. The service is specified by the command mode in which the Service ACL is applied.

The `no ipv6 access-group (Service ACLs)` and `default ipv6 access-group (Service ACLs)` commands remove the corresponding `ipv6 access-group (Service ACLs)` command from *running-config*.

#### Command Mode

Mgmt-SSH Configuration

Mgmt-API Configuration

Router-BGP Configuration

Router-OSPF Configuration

MPLS-LDP Configuration

Queue-Monitor-Streaming Configuration

MPLS-Ping Configuration

Mgmt-Telnet Configuration

#### Command Syntax

```
ipv6 access-group ipv6_acl_name [vrf vrf_name][in]
```

```
no ipv6 access-group [ipv6_acl_name][vrf vrf_name][in]
```

```
default ipv6 access-group ipv6_acl_name [vrf vrf_name][in]
```

#### Parameters

Parameters vary by process.

- *ipv6\_acl\_name* Name of the IPv6 Service ACL assigned to control-plane service.
- *vrf vrf\_name* Specifies the VRF in which the Service ACL is to be applied.
- *in* Specifies inbound connections or packets only (keyword required for SSH and Telnet services).

#### Example

These commands apply the IPv6 Service ACL *bgpacl* to the BGP routing protocol in VRF *purple*.

```
(config)#router bgp 5
(config-router-bgp)#vrf purple
(config-router-bgp-vrf-purple)#ipv6 access-group bgpacl
```

For additional configuration examples, see [Configuring Service ACLs and Displaying Status and Counters](#).

---

### 12.4.8.22 ipv6 access-group

The **ipv6 access-group** command applies an IPv6 or standard IPv6 access control list (ACL) to the configuration mode interface.

The **no ipv6 access-group** and **default ipv6 access-group** commands remove the corresponding **ipv6 access-group** command from *running-config*.

#### Command Mode

Interface-Ethernet Configuration

Interface-Port-Channel Configuration

Interface-VLAN Configuration

#### Command Syntax

```
ipv6 access-group list_name DIRECTION
```

```
no ipv6 access-group list_name DIRECTION
```

```
default ipv6 access-group list_name DIRECTION
```

#### Parameters

- *list\_name* Name of ACL assigned to interface.
- DIRECTION Transmission direction of packets, relative to interface. Valid options include:
  - in Inbound packets.
  - out Outbound packets.

#### Examples

These commands assign the IPv6 ACL named *test2* to the *Ethernet 3 interface*.

```
switch(config)#interface ethernet 3
switch(config-if-Et3)#ipv6 access-group test2 in
switch(config-if-Et3)#
```



### 12.4.8.23 ipv6 access-list standard

The **ipv6 access-list standard** command places the switch in std-IPv6-ACL-configuration mode, which is a group change mode that modifies a standard IPv6 access control list. The command specifies the name of the standard IPv6 ACL that subsequent commands modify and creates an ACL if it references a nonexistent list. All group change mode edit session changes are pending until the session ends.

The **exit** command saves pending ACL changes to **running-config**, then returns the switch to global configuration mode. Pending changes are also saved by entering a different configuration mode.

The **abort** command discards pending ACL changes, returning the switch to global configuration mode.

The **no ipv6 access-list standard** and **default ipv6 access-list standard** commands delete the specified ACL.

#### Command Mode

Global Configuration

#### Command Syntax

```
ipv6 access-list standard list_name
no ipv6 access-list standard list_name
default ipv6 access-list standard list_name
```

#### Parameters

*list\_name* Name of ACL. Must begin with an alphabetic character. Cannot contain spaces or quotation marks.

#### Commands Available in std-IPv6-ACL configuration mode:

- [deny \(Standard IPv6 ACL\)](#)
- [no <sequence number> \(ACLs\)](#)
- [permit \(Standard IPv6 ACL\)](#)
- [remark](#)
- [resequence \(ACLs\)](#)
- [show \(ACL configuration modes\)](#)

#### Related Commands

- [ipv6 access-list](#) Enters IPv6-ACL configuration mode for editing IPv6 ACLs.
- [show ipv6 access-lists](#) Displays IPv6 and standard IPv6 ACLs.

#### Examples

- This command places the switch in Std-IPv6 ACL configuration mode to modify the *filter2* ACL.

```
switch(config)#ipv6 access-list standard filter2
switch(config-std-ipv6-acl-filter2)#
```

- This command saves changes to *filter2* ACL, then returns the switch to global configuration mode.

```
switch(config-std-ipv6-acl-filter2)#exit
switch(config)#
```

- This command discards changes to *filter2*, then returns the switch to global configuration mode.

```
switch(config-std-ipv6-acl-filter2)#abort
switch(config)#
```

---

#### 12.4.8.24 ipv6 access-list

The **ipv6 access-list** command places the switch in IPv6-ACL configuration mode, which is a group change mode that modifies an IPv6 access control list. The command specifies the name of the IPv6 ACL that subsequent commands modify and creates an ACL if it references a nonexistent list. All changes in a group change mode edit session are pending until the end of the session.

The **exit** command saves pending ACL changes to **running-config**, then returns the switch to global configuration mode. ACL changes are also saved by entering a different configuration mode.

The **abort** command discards pending ACL changes, returning the switch to global configuration mode.

The **no ipv6 access-list** and **default ipv6 access-list** commands delete the specified IPv6 ACL.

##### Command Mode

Global Configuration

##### Command Syntax

```
ipv6 access-list list_name
no ipv6 access-list list_name
default ipv6 access-list list_name
```

##### Parameters

*list\_name* Name of ACL. Must begin with an alphabetic character. Cannot contain spaces or quotation marks.

##### Commands Available in IPv6-ACL configuration mode:

- [deny \(IPv6 ACL\)](#)
- [no <sequence number> \(ACLs\)](#)
- [permit \(IPv6 ACL\)](#)
- [remark](#)
- [resequence \(ACLs\)](#)
- [show \(ACL configuration modes\)](#)

##### Related Commands

- [ipv6 access-list standard](#) Enters std-ipv6-acl configuration mode for editing standard IPv6 ACLs.
- [show ipv6 access-lists](#) Displays IPv6 and standard IPv6 ACLs.

##### Examples

- This command places the switch in IPv6-ACL configuration mode to modify the *filter1* IPv6 ACL.

```
switch(config)#ipv6 access-list filter1
switch(config-ipv6-acl-filter1)#
```

- This command saves changes to *filter1* ACL, then returns the switch to global configuration mode.

```
switch(config-ipv6-acl-filter1)#exit
switch(config)#
```

- This command discards changes to *filter1*, then returns the switch to global configuration mode.

```
switch(config-ipv6-acl-filter1)#abort
switch(config)#
```

### 12.4.8.25 ipv6 prefix-list

The **ip prefix-list** command places the switch in IPv6 prefix-list configuration mode, which is a group change mode that modifies an IPv6 prefix list. The command specifies the name of the IPv6 prefix list that subsequent commands modify and creates a prefix list if it references a nonexistent list. All changes in a group change mode edit session are pending until the end of the session.

The **exit** command saves pending prefix list changes to **running-config**, then returns the switch to global configuration mode. ACL changes are also saved by entering a different configuration mode.

The **abort** command discards pending changes, returning the switch to global configuration mode.

The **no ipv6 prefix-list** and **default ipv6 prefix-list** commands delete the specified IPv6 prefix list.

#### Command Mode

Global Configuration

#### Command Syntax

```
ipv6 prefix-list list_name
no ipv6 prefix-list list_name
default ipv6 prefix-list list_name
```

#### Parameters

- *list\_name* Name of prefix list. Must begin with an alphabetic character. Cannot contain spaces or quotation marks.

#### Commands Available in IPv6-pfx configuration mode:

- [deny \(IPv6 Prefix List\)](#).
- [permit \(IPv6 Prefix List\)](#).
- [seq \(IPv6 Prefix Lists\)](#).

#### Examples

- This command places the switch in IPv6 prefix-list configuration mode to modify the *route-five* prefix list.

```
switch(config)#ipv6 prefix-list route-five
switch(config-ipv6-pfx)#
```

- This command saves changes to the prefix list, then returns the switch to global configuration mode.

```
switch(config-ipv6-pfx)#exit
switch(config)#
```

- This command saves changes to the prefix list, then places the switch in interface-Ethernet mode.

```
switch(config-ipv6-pfx)#interface ethernet 3
switch(config-if-Et3)#
```

- This command discards changes to the prefix list, then returns the switch to global configuration mode.

```
switch(config-ipv6-pfx)#abort
switch(config)#
```

---

### 12.4.8.26 mac access-group

The `mac access-group` command applies a MAC access control list (MAC ACL) to the configuration mode interface.

The `no mac access-group` and `default mac access-group` commands remove the specified `mac access-group` command from *running-config*.

#### Command Mode

Interface-Ethernet Configuration

Interface-Port-Channel Configuration

#### Command Syntax

*list\_name* DIRECTION

*list\_name* DIRECTION

*list\_name* DIRECTION

#### Parameters

- *list\_name* Name of MAC ACL.
- DIRECTION Transmission direction of packets, relative to interface. Valid options include:
  - in Inbound packets.
  - out Outbound packets.

#### Restrictions

Filtering of outbound packets by MAC ACLs is supported only on Helix, Trident, and Trident II platform switches.

#### Example

These commands assign the MAC ACL named *mtest2* to *interface Ethernet 3* to filter inbound packets.

```
switch(config)#interface ethernet 3
switch(config-if-Et3)#mac access-group mtest2 in
switch(config-if-Et3)#
```

### 12.4.8.27 mac access-list

The **mac access-list** command places the switch in MAC-ACL configuration mode, which is a group change mode that modifies a MAC access control list. The command specifies the name of the MAC ACL that subsequent commands modify and creates an ACL if it references a nonexistent list. All changes in a group change mode edit session are pending until the end of the session.

The **exit** command saves pending ACL changes to **running-config**, then returns the switch to global configuration mode. ACL changes are also saved by entering a different configuration mode.

The **abort** command discards pending ACL changes, returning the switch to global configuration mode.

The **no mac access-list** and **default mac access-list** commands delete the specified list.

#### Command Mode

Global Configuration

#### Command Syntax

```
mac access-list list_name
no mac access-list list_name
default mac access-list list_name
```

#### Parameters

*list\_name* Name of MAC ACL. Names must begin with an alphabetic character and cannot contain a space or quotation mark.

#### Commands Available in MAC-ACL configuration mode:

- [deny \(MAC ACL\)](#)
- [no <sequence number> \(ACLs\)](#)
- [permit \(MAC ACL\)](#)
- [remark](#)
- [resequence \(ACLs\)](#)
- [show \(ACL configuration modes\)](#)

#### Examples

- This command places the switch in MAC-ACL configuration mode to modify the *mfilter1* MAC ACL.

```
switch(config)#mac access-list mfilter1
switch(config-mac-acl-mfilter1)#
```

- This command saves changes to *mfilter1* ACL, then returns the switch to global configuration mode.

```
switch(config-mac-acl-mfilter1)#exit
switch(config)#
```

- This command saves changes to *mfilter1* ACL, then places the switch in interface-Ethernet mode.

```
switch(config-mac-acl-mfilter1)#interface ethernet 3
switch(config-if-Et3)#
```

- This command discards changes to *mfilter1*, then returns the switch to global configuration mode.

```
switch(config-mac-acl-mfilter1)#abort
switch(config)#
```

---

### 12.4.8.28 match (route-map)

The **match** command creates a route map statement entry that specifies one route filtering command. When a statement contains multiple match commands, the permit or deny filter applies to a route only if its properties are equal to corresponding parameters in each **match** command. When a route properties do not equal the command parameters, the route is evaluated against the next statement in the route map, as determined by sequence number. If all statements fail to permit or deny the route, the route is denied.

The **no match** and **default match** commands remove the **match** command from the configuration mode route map statement by deleting the corresponding command from **running-config**.



**Note:** The route map configuration supports only standard ACL.

#### Command Mode

Route-Map Configuration

#### Command Syntax

```
match CONDITION
```

```
no match CONDITION
```

```
default match CONDITION
```

#### Parameters

- **CONDITION** Specifies criteria for evaluating a route. Options include:
  - **aggregate-role** Role in BGP contributor-aggregate relation. Options include:
    - **contributor** BGP aggregate's contributor.
    - **aggregate-attributes** Route map to apply against the aggregate route.
  - **as** <1 to 4294967295> BGP Autonomous System number.
  - **as-path** *path\_name* BGP Autonomous System path access list.
  - **community** NAME BGP community. Options for NAME include:
    - **listname** BGP community.
    - *listname* exact-match BGP community; list must match set that is present.
  - **extcommunity** *listname* BGP extended community. Options for NAME include:
    - *listname* BGP community.
    - *listname* exact-match BGP community; list must match set that is present.
  - **interface** INTF\_NAME Specifies an interface. Options for INTF\_NAME include:
    - **ethernet** *e\_num* Ethernet interface.
    - **loopback** *l\_num* Loopback interface.
    - **port-channel** *p\_num* Port channel interface.
    - **vlan** *v\_num* VLAN interface.
  - **invert-result** Invert sub route map result
  - **ip address** LIST IPv4 address filtered by an ACL or prefix list. LIST options include:
    - **access-list** *acl\_name* IPv4 address filtered by access control list (ACL).
    - **prefix-list** *plv4\_name* IPv4 address filtered by IP prefix list.
  - **ip next-hop prefix-list** *plv4\_name* IPv4 next-hop filtered by IP prefix list.
  - **ip resolved-next-hop prefix-list** *plv4\_name* IPv4 resolved nexthop filtered by IP prefix list.
  - **ipv6 address prefix-list** *plv6\_name* IPv6 address filtered by IPv6 prefix list.
  - **ipv6 next-hop prefix-list** *plv6\_name* IPv6 next-hop filtered by IPv6 prefix list.
  - **ipv6 resolved-next-hop prefix-list** *plv6\_name* IPv6 resolved nexthop filtered by IPv6 prefix list.
  - **local-preference** <1 to 4294967295> BGP local preference metric.
  - **metric** <1 to 4294967295> Route metric.
  - **metric-type** OSPF\_TYPE OSPF metric type. Options include:
    - **type-1** OSPF type 1 metric.
    - **type-2** OSPF type 2 metric.
  - **source-protocol** *protocol\_type* Routing protocol of route's source. Options include:
    - **bgp**
    - **connected**
    - **ospf**
    - **rip**
    - **static**
  - **tag** <1 to 4294967295> Route tag.

### Related Command

[route-map](#).

### Example

This command creates a route map match rule that filters routes from BGP AS 15.

```
switch(config)#route-map map1
switch(config-route-map-map1)#match as 15
switch(config-route-map-map1)#
```

---

### 12.4.8.29 no <sequence number> (ACLs)

The **no <sequence number>** command removes the rule with the specified sequence number from the ACL. The **default <sequence number>** command also removes the specified rule.

#### Command Mode

ACL Configuration

IPv6-ACL Configuration

Std-ACL Configuration

Std-IPv6-ACL Configuration

MAC-ACL Configuration

#### Command Syntax

no *line\_num*

default *line\_num*

#### Parameters

*line\_num* Sequence number of rule to be deleted. Values range from 1 - 4294967295.

#### Example

This command removes statement 30 from the list.

```
switch(config-acl-test1)#show IP Access List test1
 10 permit ip 10.10.10.0/24 any
 20 permit ip any host 10.20.10.1
 30 deny ip host 10.10.10.1 host 10.20.10.1
 40 permit ip any any
 50 remark end of list
switch(config-acl-test1)#no 30
switch(config-acl-test1)#show IP Access List test1
 10 permit ip 10.10.10.0/24 any
 20 permit ip any host 10.20.10.1
 40 permit ip any any
 50 remark end of list
```



### 12.4.8.30 permit (IPv4 ACL)

The **permit** command adds a permit rule to the configuration mode IPv4 access control list (ACL). Packets filtered by a permit rule are accepted by interfaces to which the ACL is applied. Sequence numbers determine rule placement in the ACL. Sequence numbers for commands without numbers are derived by adding 10 to the number of the ACL's last rule.

The **no permit** and **default permit** commands remove the specified rule from the configuration mode ACL. The **no <sequence number> (ACLs)** command also removes a specified rule from the ACL.

#### Command Mode

ACL Configuration

#### Command Syntax

```
[SEQ_NUM] permit PROTOCOL SOURCE_ADDR [SOURCE_PORT] DEST_ADDR [DEST_PORT]
[FLAGS][MESSAGE][fragments][tracked][DSCP_FILTER][TTL_FILTER][log]
```

```
no permit PROTOCOL SOURCE_ADDR [SOURCE_PORT] DEST_ADDR [DEST_PORT][FLAGS
[MESSAGE] [fragments] [tracked][DSCP_FILTER][TTL_FILTER][log]
```

```
default permit PROTOCOL SOURCE_ADDR [SOURCE_PORT] DEST_ADDR [DEST_PORT]
[FLAGS][MESSAGE][fragments][tracked][DSCP_FILTER][TTL_FILTER][log]
```

Commands use a subset of the listed fields. Available parameters depend on specified protocol. Use CLI syntax assistance to view options for specific protocols when creating a permit rule.

#### Parameters

- SEQ\_NUM Sequence number assigned to the rule. Options include:
  - *<no parameter>* Number is derived by adding 10 to the number of the ACL's last rule.
  - *<1 - 4294967295>* Number assigned to entry.
- PROTOCOL Protocol field filter. Values include:
  - ahp Authentication Header Protocol (51).
  - gre Generic Routing Encapsulation.
  - gtp GPRS Tunneling Protocol.
  - icmp Internet Control Message Protocol (1).
  - igmp Internet Group Management Protocol (2).
  - ip Any Internet Protocol v4 (4).
  - ospf Open Shortest Path First (89).
  - pim Protocol Independent Multicast (103).
  - tcp Transmission Control Protocol (6).
  - udp User datagram protocol (17).
  - vlan Enter VLAN number. Value ranges from 1 to 4094.
  - vrrp Virtual Router Redundancy Protocol (112).
  - *protocol\_num* Integer corresponding to an IP protocol. Values range from 0 to 255.
- SOURCE\_ADDR and DEST\_ADDR Source and destination address filters. Options include:
  - *network\_addr* subnet address (CIDR or address-mask).
  - any Packets from all addresses are filtered.
  - host *ip\_addr* IP address (dotted decimal notation).

Source and destination subnet addresses support discontinuous masks.

- SOURCE\_PORT and DEST\_PORT Source and destination port filters. Options include:
  - any All ports.
  - eq *port-1 port-2 ... port-n* A list of ports. Maximum list size is 10 ports.
  - neq *port-1 port-2 ... port-n* The set of all ports not listed. Maximum list size is 10 ports.
  - gt *port* The set of ports with larger numbers than the listed port.
  - lt *port* The set of ports with smaller numbers than the listed port.
  - range *port\_1 port\_2* The set of ports whose numbers are between the range.
- fragments Filters packets with FO bit set (indicates a non-initial fragment packet).
- FLAGS Flags bit filters (TCP packets). Use CLI syntax assistance (?) to display options.
- MESSAGE Message type filters (ICMP packets). Use CLI syntax assistance (?) to display options.
- tracked Rule filters packets in existing ICMP, UDP, or TCP connections.
  - Valid in ACLs applied to the control plane.
  - Validity in ACLs applied to data plane varies by switch platform.
- DSCP\_FILTER Rule filters packet by its DSCP value. Values include:
  - <no parameter> Rule does not use DSCP to filter packets.
  - dscp *dscp\_value* Packets match if DSCP field in packet is equal to *dscp\_value*.
- TTL\_FILTER Rule filters packet by its TTL (time-to-live) value. Values include:
  - ttl eq *ttl\_value* Packets match if **ttl** in packet is equal to *ttl\_value*.
  - ttl gt *ttl\_value* Packets match if **ttl** in packet is greater than *ttl\_value*.
  - ttl lt *ttl\_value* Packets match if **ttl** in packet is less than *ttl\_value*.
  - ttl neq *ttl\_value* Packets match if **ttl** in packet is not equal to *ttl\_value*.
    - Valid in ACLs applied to the control plane.
    - Validity in ACLs applied to data plane varies by switch platform.
- log Triggers an informational log message to the console about the matching packet.
  - Valid in ACLs applied to the control plane.
  - Validity in ACLs applied to data plane varies by switch platform.

### Examples

- This command appends a **permit** statement at the end of the ACL. The **permit** statement passes all OSPF packets from *10.10.1.1/24* to any host.

```
switch(config)#ip access-list text1
switch(config-acl-text1)#permit ospf 10.1.1.0/24 any
switch(config-acl-text1)#
```

- This command inserts a **permit** statement with the sequence number 25. The **permit** statement passes all PIM packets through the interface.

```
switch(config-acl-text1)#25 permit pim any any
switch(config-acl-text1)#
```

- These commands configure ACL to permit VLAN traffic between any source and destination host.

```
switch(config)#ip access-list acl1
switch(config-acl-acl1)#permit vlan 1234 0x0 ip any any
```

### 12.4.8.31 permit (IPv6 ACL)

The **permit** command adds a permit rule to the configuration mode IPv6 access control list (ACL). Packets filtered by a permit rule are accepted by interfaces to which the ACL is applied. Sequence numbers determine rule placement in the ACL. Sequence numbers for commands without numbers are derived by adding 10 to the number of the ACL's last rule.

The **no permit** and **default permit** commands remove the specified rule from the configuration mode ACL. The **no <sequence number> (ACLs)** command also removes a specified rule from the ACL.

#### Command Mode

IPv6-ACL Configuration

#### Command Syntax

```
[SEQ_NUM] permit PROT SRC_ADDR [SRC_PT] DEST_ADDR [DEST_PT][FLAG] [MSG] [HOP]
[tracked] [DSCP_FILTER] [log]
```

```
no permit PROT SRC_ADDR [SRC_PT] DEST_ADDR [DEST_PT][FLAG][MSG] [HOP][tracked]
[DSCP_FILTER][log]
```

```
default permit PROT SRC_ADDR [SRC_PT] DEST_ADDR [DEST_PT][FLAG][MSG] [HOP]
[tracked][DSCP_FILTER][log]
```



**Note:** Commands use a subset of the listed fields. Available parameters depend on specified protocol. Use CLI syntax assistance to view options for specific protocols when creating a permit rule.

#### Parameters

- SEQ\_NUM Sequence number assigned to the rule. Options include:
  - *<no parameter>* Number is derived by adding 10 to the number of the ACL's last rule.
  - *<1 - 4294967295>* Number assigned to entry.
- PROT Protocol field filter. Values include:
  - icmpv6 Internet Control Message Protocol for v6 (58).
  - ipv6 Internet Protocol IPv6 (41).
  - ospf Open Shortest Path First (89).
  - tcp Transmission Control Protocol (6).
  - udp User Datagram Protocol (17).
  - vlan Enter VLAN number. Value ranges from 1 to 4094.
  - *protocol\_num* Integer corresponding to an IP protocol. Values range from 0 to 255.
- SRC\_ADDR and DEST\_ADDR Source and destination address filters. Options include:
  - *ipv6\_prefix* IPv6 address with prefix length (CIDR notation).
  - any Packets from all addresses are filtered.
  - host *ipv6\_addr* IPv6 host address.
- SRC\_PT and DEST\_PT Source and destination port filters. Options include:
  - any All ports.
  - eq *port-1 port-2 ... port-n* A list of ports. Maximum list size is 10 ports.
  - neq *port-1 port-2 ... port-n* The set of all ports not listed. Maximum list size is 10 ports.
  - gt *port* The set of ports with larger numbers than the listed port.
  - lt *port* The set of ports with smaller numbers than the listed port.
  - range *port\_1 port\_2* The set of ports whose numbers are between the range.

- HOP Filters by packet's hop-limit value. Options include:
  - *<no parameter>* Rule does not use hop limit to filter packets.
  - *hop-limit eq hop\_value* Packets match if **hop-limit** value in packet equals *hop\_value*.
  - **hop-limit gt hop\_value** Packets match if **hop-limit** in packet is greater than *hop\_value*.
  - *hop-limit lt hop\_value* Packets match if **hop-limit** in packet is less than *hop\_value*.
  - *hop-limit neq hop\_value* Packets match if **hop-limit** in packet is not equal to *hop\_value*.
- FLAG Flag bit filters (TCP packets). Use CLI syntax assistance (?) to display options.
- MSG Message type filters (ICMPv6 packets). Use CLI syntax assistance (?) to display options.
- tracked Rule filters packets in existing ICMP, UDP, or TCP connections.
  - Valid in ACLs applied to the control plane.
  - Validity in ACLs applied to data plane varies by switch platform.
- DSCP\_FILTER Rule filters packet by its DSCP value. Values include:
  - *<no parameter>* Rule does not use DSCP to filter packets.
  - *dscp dscp\_value* Packets match if DSCP field in packet is equal to *dscp\_value*.
- log Triggers an informational log message to the console about the matching packet.
  - Valid in ACLs applied to the control plane.
  - Validity in ACLs applied to data plane varies by switch platform.

### Examples

- This command appends a **permit** statement at the end of the ACL. The **permit** statement passes all IPv6 packets with the source address *3710:249a:c643:ef11::/64* and with any destination address.

```
switch(config)#ipv6 access-list text1
switch(config-acl-text1)#permit ipv6 3710:249a:c643:ef11::/64 any
switch(config-acl-text1)#
```

- These commands configure ACL to permit VLAN traffic between any source and destination host.

```
switch(config)#ip access-list acl1
switch(config-acl-acl1)#permit ipv6 vlan 1234 0x0 ip any any
```

### 12.4.8.32 permit (IPv6 Prefix List)

The **permit** command adds a rule to the configuration mode IPv6 prefix list. Route map match commands use prefix lists to filter routes for redistribution into OSPF, RIP, or BGP domains. Routes are redistributed into the specified domain when they match the prefix that a **permit** statement specifies.

The **no permit** and **default permit** commands remove the specified rule from the configuration mode prefix list. The **no seq (IPv6 Prefix Lists)** command also removes the specified rule from the prefix list.

#### Command Mode

IPv6-pfx Configuration

#### Command Syntax

```
[SEQUENCE] permit ipv6_prefix [MASK]
```

#### Parameters

- SEQUENCE Sequence number assigned to the rule. Options include:
    - *<no parameter>* Number is derived by adding 10 to the number of the list's last rule.
    - seq *seq\_num* Number is specified by *seq\_num*. Value ranges from 0 to 65535.
  - *ipv6\_prefix* IPv6 prefix upon which command filters routes (CIDR notation).
  - MASK Range of the prefix to be matched.
    - *<no parameter>* Exact match with the subnet mask is required.
    - eq *mask\_e* Prefix length is equal to *mask\_e*.
    - ge *mask\_g* Range is from *mask\_g* to 128.
    - le *mask\_l* Range is from *subnet* mask length to *mask\_l*.
    - ge *mask\_l* le *mask\_g* Range is from *mask\_g* to *mask\_l*.
- mask\_e*, *mask\_l* and *mask\_g* range from 1 to 128.

When le and ge are specified, the prefix list size < *mask\_g*>*mask\_l*

#### Example

- This command appends a **permit** statement at the end of the text1 prefix list. The **permit** statement allows redistribution of routes with the specified prefix.

```
switch(config)#ipv6 prefix-list route-five
switch(config-ipv6-pfx)#permit 3100::/64
switch(config-ipv6-pfx)#
```

### 12.4.8.33 permit (MAC ACL)

The **permit** command adds a permit rule to the configuration mode MAC access control list packets through the interface to which the list is applied. Rule filters include protocol, source, and destination.

The **no permit** and **default permit** commands remove the specified rule from the configuration mode ACL. The **no <sequence number> (ACLs)** command also removes the specified rule from the ACL.

#### Command Mode

MAC-ACL Configuration

#### Command Syntax

```
[SEQ_NUM] permit SOURCE_ADDR DEST_ADDR [PROTOCOL][log]
```

```
no permit SOURCE_ADDR DEST_ADDR [PROTOCOL][log]
```

```
default permit SOURCE_ADDR DEST_ADDR [PROTOCOL][log]
```

#### Parameters

- SEQ\_NUM Sequence number assigned to the rule. Options include:
  - *<no parameter>* Number is derived by adding 10 to the number of the ACL's last rule.
  - *<1 - 4294967295>* Number assigned to entry.
- SOURCE\_ADDR and DEST\_ADDR Source and destination address filters. Options include:
  - *mac\_address mac\_mask* MAC address and mask.
  - any Packets from all addresses are filtered.
    - *mac\_address* Specifies a MAC address in 3x4 dotted hexadecimal notation (hhhh.hhhh.hhhh).
    - *mac\_mask* Specifies a MAC address mask in 3x4 dotted hexadecimal notation (hhhh.hhhh.hhhh).
  - 0 bits require an exact match to filter.
  - 1 bits filter on any value.
- PROTOCOL Protocol field filter. Values include:
  - aarp Appletalk Address Resolution Protocol (0x80f3).
  - appletalk Appletalk (0x809b).
  - arp Address Resolution Protocol (0x806).
  - ip Internet Protocol Version 4 (0x800).
  - ipx Internet Packet Exchange (0x8137).
  - lldp LLDP (0x88cc).
  - novell Novell (0x8138).
  - rarp Reverse Address Resolution Protocol (0x8035).
  - *protocol\_num* Integer corresponding to a MAC protocol. Values range from 0 to 65535
- log Triggers an informational log message to the console about the matching packet.

#### Examples

- This command appends a **permit** statement at the end of the ACL. The **permit** statement passes all aarp packets from 10.1000.0000 through 10.1000.FFFF to any host.

```
switch(config)#mac access-list text1
switch(config-mac-acl-text1)#permit 10.1000.0000 0.0.FFFF any aarp
switch(config-mac-acl-text1)#
```

- This command inserts a **permit** statement with the sequence number 25. The **permit** statement passes all packets through the interface.

```
switch(config-mac-acl-text1)#25 permit any any
switch(config-mac-acl-text1)#
```

---

### 12.4.8.34 permit (Standard IPv4 ACL)

The **permit** command adds a permit rule to the configuration mode standard IPv4 access control list (ACL). Standard ACL rules filter on the source field.

Packets filtered by a permit rule are accepted by interfaces to which the ACL is applied. Sequence numbers determine rule placement in the ACL. Sequence numbers for commands without numbers are derived by adding 10 to the number of the ACL's last rule.

The **no permit** and **default permit** commands remove the specified rule from the configuration mode ACL. The **no <sequence number> (ACLs)** command also removes the specified rule from the ACL.

#### Command Mode

Std-ACL Configuration

#### Command Syntax

```
[SEQ_NUM] permit SOURCE_ADDR [log]
```

```
no permit SOURCE_ADDR [log]
```

```
default permit SOURCE_ADDR [log]
```

#### Parameters

- SEQ\_NUM Sequence number assigned to the rule. Options include:
  - *<no parameter>* Number is derived by adding 10 to the number of the ACL's last rule.
  - *<1 - 4294967295>* Number assigned to entry.
- SOURCE\_ADDR Source address filter. Options include:
  - *network\_addr* Subnet address (CIDR or address-mask).
  - any Packets from all addresses are filtered.
  - *host ip\_addr* IP address (dotted decimal notation).  
Subnet addresses support discontinuous masks.
- log Triggers an informational log message to the console about the matching packet.
  - Valid in ACLs applied to the control plane.
  - Validity in ACLs applied to data plane varies by switch platform.

#### Example

This command appends a **permit** statement at the end of the ACL. The **permit** statement passes all packets with a source address of *10.10.1.1/24*.

```
switch(config)#ip access-list standard text1
switch(config-std-acl-text1)#permit 10.1.1.1/24
switch(config-std-acl-text1)#
```



### 12.4.8.35 permit (Standard IPv6 ACL)

The **permit** command adds a permit rule to the configuration mode standard IPv6 access control list. Standard ACL rules filter on the source field.

Packets filtered by a permit rule are accepted by interfaces to which the ACL is applied. Sequence numbers determine rule placement in the ACL. Sequence numbers for commands without numbers are derived by adding 10 to the number of the ACL's last rule.

The **no permit** and **default permit** commands remove the specified rule from the configuration mode ACL. The **no <sequence number> (ACLs)** command also removes the specified rule from the ACL.

#### Command Mode

Std-IPv6-ACL Configuration

#### Command Syntax

```
[SEQ_NUM] permit SOURCE_ADDR
```

```
no permit SOURCE_ADDR
```

```
default permit SOURCE_ADDR
```

#### Parameters

- SEQ\_NUM Sequence number assigned to the rule. Options include:
  - *<no parameter>* Number is derived by adding 10 to the number of the ACL's last rule.
  - *<1 - 4294967295>* Number assigned to entry.
- SOURCE\_ADDR Source address filter. Options include:
  - *ipv6\_prefix* IPv6 address with prefix length (CIDR notation).
  - any Packets from all addresses are filtered.
  - *host ipv6\_addr* IPv6 host address.

#### Example

This command appends a **permit** statement at the end of the ACL. The **permit** statement drops packets with a source address of *2103::/64*.

```
switch(config)#ipv6 access-list standard text1
switch(config-std-acl-ipv6-text1)#permit 2103::/64
switch(config-std-acl-ipv6-text1)#
```

---

### 12.4.8.36 remark

The **remark** command adds a non-executable comment statement into the pending ACL. Remarks entered without a sequence number are appended to the end of the list. Remarks entered with a sequence number are inserted into the list as specified by the sequence number.

The **default remark** command removes the comment statement from the ACL.

The **no remark** command removes the comment statement from the ACL. The command can specify the remark by content or by sequence number.

#### Command Mode

ACL Configuration

IPv6-ACL Configuration

Std-ACL Configuration

Std-IPv6-ACL Configuration

MAC-ACL Configuration

#### Command Syntax

```
remark text
```

```
line_num remark [text]
```

```
no remark text
```

```
default remark text
```

#### Parameters

- *text* The comment text.
- *line\_num* Sequence number assigned to the remark statement. Value ranges from 1 - 4294967295.

#### Example

This command appends a comment to the list.

```
switch(config-acl-test1)#remark end of list
switch(config-acl-test1)#show
IP Access List test1
 10 permit ip 10.10.10.0/24 any
 20 permit ip any host 10.20.10.1
 30 deny ip host 10.10.10.1 host 10.20.10.1
 40 permit ip any any
 50 remark end of list
```

### 12.4.8.37 resequence (ACLs)

The **resequence** command assigns sequence numbers to rules in the configuration mode ACL. Command parameters specify the number of the first rule and the numeric interval between consecutive rules.

Maximum rule sequence number is 4294967295.

#### Command Mode

ACL Configuration

IPv6-ACL Configuration

Std-ACL Configuration

Std-IPv6-ACL Configuration

MAC-ACL Configuration

#### Command Syntax

```
resequence [start_num [inc_num]]
```

#### Parameters

- *start\_num* Sequence number assigned to the first rule. Default is 10.
- *inc\_num* Numeric interval between consecutive rules. Default is 10.

#### Example

The **resequence** command renumbers the list, starting the first command at number 100 and incrementing subsequent lines by 20.

- ```
switch(config-acl-test1)#show
IP Access List test1
 10 permit ip 10.10.10.0/24 any
 20 permit ip any host 10.20.10.1
 30 deny ip host 10.10.10.1 host 10.20.10.1
 40 permit ip any any
 50 remark end of list
switch(config-acl-test1)#resequence 100 20
switch(config-acl-test1)#show
IP Access List test1
 100 permit ip 10.10.10.0/24 any
 120 permit ip any host 10.20.10.1
 140 deny ip host 10.10.10.1 host 10.20.10.1
 160 permit ip any any
 180 remark end of list
```

12.4.8.38 route-map

The **route-map** command places the switch in route map configuration mode, which is a group change mode that modifies a route map statement. The command specifies the name and number of the route map statement that subsequent commands modify and creates a route map statement if it references a nonexistent statement. All changes in a group change mode edit session are pending until the end of the session.

Route maps define commands for redistributing routes between routing protocols. A route map statement is identified by a name, filter type (permit or deny), and sequence number. Statements with the same name are components of a single route map; the sequence number determines the order in which the statements are compared to a route.

The **exit** command saves pending route map statement changes to **running-config**, then returns the switch to global configuration mode. ACL changes are also saved by entering a different configuration mode.

The **abort** command discards pending changes, returning the switch to global configuration mode.

The **no route-map** and **default route-map** commands delete the specified route map statement from **running-config**.

 **Note:** The route map configuration supports only standard ACL.

Command Mode

Global Configuration

Command Syntax

```
route-map map_name [FILTER_TYPE] [sequence_number]
no route-map map_name [FILTER_TYPE] [sequence_number]
default route-map map_name [FILTER_TYPE][sequence_number]
```

Parameters

- *map_name* Label assigned to route map. Protocols reference this label to access the route map.
- *FILTER_TYPE* Disposition of routes matching commands specified by route map statement.
 - permit Routes are redistributed when they match route map statement.
 - deny Routes are not redistributed when they match route map statement.
 - *<No parameter>* Ssigns **permit** as the *FILTER_TYPE*.

When a route does not match the route map criteria, the next statement within the route map is evaluated to determine the redistribution action for the route.

- *sequence_number* The route map position relative to other statements with the same name.
 - *<no parameter>* Sequence number of 10 (default) is assigned to the route map.
 - *<1-16777215>* Specifies sequence number assigned to route map.

Commands Available in route map configuration mode:

- [continue \(route map\)](#)
- [match \(route-map\)](#)
- [set \(route-map\)](#)

Examples

- This command creates the route map named *map1* and places the switch in route map configuration mode. The route map is configured as a permit map.

```
switch(config)#route-map map1 permit 20
switch(config-route-map-map1)#
```

- This command saves changes to *map1* route map, then returns the switch to global configuration mode.

```
switch(config-route-map-map1) #exit  
switch(config) #
```

- This command saves changes to *map1* route map, then places the switch in interface-Ethernet mode.

```
switch(config-route-map-map1) #interface ethernet 3  
switch(config-if-Et3) #
```

- This command discards changes to *map1* route map, then returns the switch to global configuration mode.

```
switch(config-route-map-map1) #abort  
switch(config) #
```

12.4.8.39 seq (IPv6 Prefix Lists)

The **no seq** command removes the rule with the specified sequence number from the ACL. The **default seq** command also removes the specified rule.

The **seq** keyword is a command option used at the beginning of [deny \(IPv6 Prefix List\)](#) and [permit \(IPv6 Prefix List\)](#) commands that places a new rule between two existing rules.

Command Mode

IPv6-pfx Configuration

Command Syntax

```
no seq line_num
```

```
default seq line_num
```

Parameters

- *line_num* Sequence number of rule to be deleted. Valid rule numbers range from 0 to 65535.

Example

These commands remove rule 20 from the *map1* prefix list, then displays the resultant list.

```
switch(config)#ipv6 prefix-list map1
switch(config-ipv6-pfx)#no seq 20
switch(config-ipv6-pfx)#exit
switch(config)#show ipv6 prefix-list map1
ipv6 prefix-list map1
seq 10 permit 3:4e96:8ca1:33cf::/64
seq 15 deny 3:4400::/64
seq 30 permit 3:1bca:3ff2:634a::/64
seq 40 permit 3:1bca:1141:ab34::/64
switch(config)#
```

12.4.8.40 set (route-map)

The **set** command specifies modifications to routes that are selected for redistribution by the configuration mode route map.

The **no set** and **default set** commands remove the specified **set** command from the configuration mode route map statement by deleting the corresponding **set** command from **running-config**.

Command Mode

Route-Map Configuration

Command Syntax

```
set CONDITION
```

```
no set CONDITION
```

```
default set CONDITION
```

Parameters

- **CONDITION** Specifies the route modification parameter and value. Options include:
 - **as-path prepend** BGP AS number that is prepended to as-path. For details, see the [set as-path prepend](#) command.
 - `<1 - 4294967295>` BGP AS number to prepend.
 - **auto** Use peer AS number for inbound and local AS for outbound to prepend.
 - **distance** `<1 - 255>` Protocol independent administrative distance.
 - **ip next-hop** `ipv4_address` Next hop IPv4 address.
 - **ip next-hop peer-address** Use BGP peering address as next hop IPv4 address.
 - **ipv6 next-hop** `ipv6_address` Next hop IPv6 address.
 - **ipv6 next-hop peer-address** Use BGP peering address as next hop IPv6 address.
 - **local-preference** `<1 - 4294967295>` BGP local preference metric.
 - **metric** `<1 - 4294967295>` Route metric.
 - **metric +** `<1 - 4294967295>` Add specified value to current route metric.
 - **metric -** `<1 - 4294967295>` Subtract specified value to current route metric.
 - **metric-type** OSPF_TYPE OSPF metric type. Options include:
 - **type-1** OSPF type 1 metric.
 - **type-2** OSPF type 2 metric.
 - **origin** O_TYPE BGP origin attribute. Options for O_TYPE include:
 - **egp** Exterior BGP route.
 - **igp** Interior BGP route.
 - **incomplete** BGP route of unknown origin.
 - **tag** `<1 - 4294967295>` Route tag.
 - **weight** `<1 - 65535>` BGP weight parameter.

Related Commands

- [route-map](#) enters route-map configuration mode.
- [set \(route-map\)](#) specifies community modifications for the redistributed routes.
- [set community \(route-map\)](#) specifies extended community modifications for the redistributed routes.

Example

This command creates a route map entry that sets the local preference metric to 100 on redistributed routes.

```
switch(config)#route-map map1
```

```
switch(config-route-map-map1)#set local-preference 100  
switch(config-route-map-map1)#
```

12.4.8.41 set as-path match

The **set as-path match** command configures the AS_PATH attribute for prefixes that are either received from a BGP neighbor or advertised to a BGP neighbor in the route map configuration mode.

The **no set as-path match** command removes the AS path specified for the BGP prefix.

Command Mode

Route-Map Configuration

Command Syntax

```
set as-path match all replacement [[none | auto] as_path]
```

```
no set as-path match all replacement [[none | auto] as_path]
```

Parameters

- **none** Replaces the AS-Path of the matching routes with a null or an empty AS-Path.
- **auto** If the specific route map is applied as an inbound policy to a corresponding BGP neighbor statement, then replace the AS_PATH of the prefixes received from this neighbor with the neighbor's AS number. If this route map is applied as an outbound policy to a corresponding neighbor statement, then replace the AS_PATH of the prefixes advertised to this neighbor with the locally configured AS number.
- **as_path** Replaces the AS-Path of the matching routes with an arbitrary AS-Path.

Examples

- This command replaces the AS-Path with the none option.

```
switch#show ip bgp neighbors 80.80.1.2 advertised-routes
BGP routing table information for VRF default
Router identifier 202.202.1.1, local AS number 200
Route status codes: s - suppressed, * - valid, > - active, # - not
  installed, E
  - ECMP head, e - ECMP
S - Stale, c - Contributing to ECMP, b - backup, L - labeled-unicast, q
  - Queued
for advertisement
Origin codes: i - IGP, e - EGP, ? - incomplete
AS Path Attributes: Or-ID - Originator ID, C-LST - Cluster List, LL
  Nexthop -
Link Local Nexthop

Network Next Hop Metric LocPref Weight Path
* > 101.101.1.0/24 80.80.1.1 - - - 200 i
* > 102.102.1.0/24 80.80.1.1 - - - 200 i
* > 103.103.1.0/24 80.80.1.1 - - - 200 302 i
* > 202.202.1.0/24 80.80.1.1 - - - 200 i
switch#configuration terminal
switch(config)#route-map foo permit 10
switch(config-route-map-foo)#set as-path match all replacement none
switch(config-route-map-foo)#exit
switch(config)#router bgp 200
switch(config-router-bgp)#neighbor 80.80.1.2 route-map foo out
switch(config-router-bgp)#end

switch#show ip bgp neighbors 80.80.1.2 advertised-routes
BGP routing table information for VRF default
Router identifier 202.202.1.1, local AS number 200
Route status codes: s - suppressed, * - valid, > - active, # - not
  installed, E
  - ECMP head, e - ECMP
```

```

S - Stale, c - Contributing to ECMP, b - backup, L - labeled-unicast, q
- Queued
for advertisement
Origin codes: i - IGP, e - EGP, ? - incomplete
AS Path Attributes: Or-ID - Originator ID, C-LST - Cluster List, LL
  Nexthop -
Link Local Nexthop

Network Next Hop Metric LocPref Weight Path
* > 101.101.1.0/24 80.80.1.1 - - - 200 i
* > 102.102.1.0/24 80.80.1.1 - - - 200 i
* > 103.103.1.0/24 80.80.1.1 - - - 200 i
* > 202.202.1.0/24 80.80.1.1 - - - 200 i

```

The AS-Path of matching prefixes are replaced with an empty or a null AS-Path. AS 302 is removed from prefix *103.103.1.0/24* as shown in the above output.

- This command replaces the AS-Path with the auto option.

```

switch(config)#route-map foo permit 10
switch(config-route-map-foo)#set as-path match all replacement auto
switch(config-route-map-foo)#end
switch#show ip bgp neighbors 80.80.1.2 advertised-routes
BGP routing table information for VRF default
Router identifier 202.202.1.1, local AS number 200
Route status codes: s - suppressed, * - valid, > - active, # - not
  installed, E
- ECMP head, e - ECMP
S - Stale, c - Contributing to ECMP, b - backup, L - labeled-unicast, q
- Queued
for advertisement
Origin codes: i - IGP, e - EGP, ? - incomplete
AS Path Attributes: Or-ID - Originator ID, C-LST - Cluster List, LL
  Nexthop -
Link Local Nexthop

Network Next Hop Metric LocPref Weight Path
* > 101.101.1.0/24 80.80.1.1 - - - 200 200 i
* > 102.102.1.0/24 80.80.1.1 - - - 200 200 i
* > 103.103.1.0/24 80.80.1.1 - - - 200 200 i
* > 202.202.1.0/24 80.80.1.1 - - - 200 200 i

```

The AS-Path of matching prefixes are replaced with the locally configured AS 200.

- This command replaces the AS-Path with another AS-Path.

```

switch(config)#route-map foo permit 10
switch(config-route-map-foo)#set as-path match all replacement 500 600
switch(config-route-map-foo)#end
switch#show ip bgp neighbors 80.80.1.2 advertised-routes
BGP routing table information for VRF default
Router identifier 202.202.1.1, local AS number 200
Route status codes: s - suppressed, * - valid, > - active, # - not
  installed, E
- ECMP head, e - ECMP
S - Stale, c - Contributing to ECMP, b - backup, L - labeled-unicast, q
- Queued
for advertisement
Origin codes: i - IGP, e - EGP, ? - incomplete
AS Path Attributes: Or-ID - Originator ID, C-LST - Cluster List, LL
  Nexthop -
Link Local Nexthop

```

```

Network Next Hop Metric LocPref Weight Path
* > 101.101.1.0/24 80.80.1.1 - - - 200 500 600 i
* > 102.102.1.0/24 80.80.1.1 - - - 200 500 600 i
* > 103.103.1.0/24 80.80.1.1 - - - 200 500 600 i
* > 202.202.1.0/24 80.80.1.1 - - - 200 500 600 i

```

The AS-Path of matching prefixes are replaced with 500 600 as configured.

- This command replaces the AS-Path with a combination of auto and an AS-Path.

```

switch(config)#route-map foo permit 10
switch(config-route-map-foo)#set as-path match all replacement auto 500
600
switch(config-route-map-foo)#end
switch#show ip bgp neighbors 80.80.1.2 advertised-routes
BGP routing table information for VRF default
Router identifier 202.202.1.1, local AS number 200
Route status codes: s - suppressed, * - valid, > - active, # - not
installed, E
- ECMP head, e - ECMP
S - Stale, c - Contributing to ECMP, b - backup, L - labeled-unicast,
q - Queued
for advertisement
Origin codes: i - IGP, e - EGP, ? - incomplete
AS Path Attributes: Or-ID - Originator ID, C-LST - Cluster List, LL
NextHop -
Link Local NextHop

Network Next Hop Metric LocPref Weight Path
* > 101.101.1.0/24 80.80.1.1 - - - 200 200 500 600 i
* > 102.102.1.0/24 80.80.1.1 - - - 200 200 500 600 i
* > 103.103.1.0/24 80.80.1.1 - - - 200 200 500 600 i
* > 202.202.1.0/24 80.80.1.1 - - - 200 200 500 600 i

```

The AS-Path of matching prefixes are replaced with the locally configured AS 200 and 500 600.

12.4.8.42 set as-path prepend

The **set as-path prepend** command adds a **set** statement to a route map to prepend one or more autonomous system (AS) numbers to the AS_PATH attribute of a BGP route.

The **no set as-path prepend** and **default set as-path prepend** commands remove the specified set statements from the route map and update all corresponding routes.

Command Mode

Route-Map Configuration

Command Syntax

```
set as-path prepend {{auto | as_number... [auto | as_number]} | last-as count}
```

```
no set as-path prepend {{auto | as_number... [auto | as_number]} | last-as count}
```

```
default set as-path prepend {{auto | as_number... [auto | as_number]} | last-as count}
```

Parameters

- **auto** Prepends the peer AS number for peer inbound route maps and the local AS number for peer outbound route maps.
- **as_number** Prepends the specified AS number. Can be entered in plain notation (values range from 1-4294967295) or in asdot notation as described in RFC 5396. In asdot notation, AS numbers from 1-65535 are entered in plain notation, and AS numbers from 65536 to 4294967295 are entered as two values separated by a dot. The first value is high-order and represents a multiple of 65536; the second value is low-order and represents a decimal integer. For example, AS number 65552 can be entered as either 65552 or 1.16 (i.e., 1*65536+16). However they are entered, AS numbers are stored internally in plain decimal notation and will appear that way in **show** outputs.
- **last-as count** Prepends the last AS number in the AS path *count* times. Values range from 1 to 15. This is mutually exclusive with the use of the **auto** keyword or the entry of one or more specified AS numbers, and is not supported in multi-agent mode.

Examples

- These commands create a route-map entry that prepends AS number 64496 and prepends either the peer or local AS number twice.

```
switch(config)#route-map map1
switch(config-route-map-map1)#set as-path prepend 64496 auto auto
switch(config-route-map-map1)#exit
switch(config)#show route-map map1
route-map map1 permit 10
  Description:
  Match clauses:
  SubRouteMap:
  Set clauses:
    set as-path prepend 64496 auto auto
switch(config)#
```

- The commands create a route-map entry that prepends AS numbers 64496, 64498, and 65552.

```
switch(config)#route-map map2
switch(config-route-map-map2)#set as-path prepend 64496 64498 1.16
switch(config-route-map-map2)#exit
switch(config)#show route-map map2
route-map map2 permit 10
  Description:
  Match clauses:
  SubRouteMap:
  Set clauses:
    set as-path prepend 64496 64498 65552
```

```
switch(config)#
```

- These commands create a route map entry that prepends the last AS number 12 times.

```
switch(config)#route-map map3
switch(config-route-map-map3)#set as-path prepend last-as 12
switch(config-route-map-map3)#exit
switch(config)#show route-map map3
route-map map3 permit 10
  Description:
  Match clauses:
  SubRouteMap:
  Set clauses:
    set as-path prepend last-as 12
switch(config)#
```

12.4.8.43 set community (route-map)

The **set community** command specifies community attribute modifications to routes that are selected for redistribution by the configuration mode route map. The **set community none** command removes community attributes from the route.

The **no set community** and **default set community** commands remove the specified community from the configuration mode route map statement by deleting the corresponding statement from the **running config**.

Command Mode

Route-Map Configuration

Command Syntax

```
set community [GSHUT | aa:nn | community-list | internet | local-as | no-advertise | no-export | none | number]
```

```
no set community [GSHUT | aa:nn | additive | community-list | delete | internet | local-as | no-advertise | no-export | none | number]
```

```
default set community [GSHUT | aa:nn | additive | community-list | delete | internet | local-as | no-advertise | no-export | none | number]
```

Parameters

- **GSHUT** Configures a graceful shutdown in BGP.
- **aa:nn** Configures the community AS and network number, separated by colon. Value ranges from 0:0 to 65535:65535.
- **community-list** A label for community list.
- **internet** Advertises route to the Internet community.
- **local-as** Advertises route only to local peers.
- **no-advertise** Does not advertise route to any peer.
- **no-export** Advertises route only within BGP AS boundary.
- **none** Does not provide any community attributes.
- **number** Configures the community number. Value ranges from 1 to 4294967040.
- **additive** Adds specified attributes to the current community.
- **delete** Removes specified attributes from the current community.

Related Commands

- [ip community-list](#)
- [route-map](#)
- [set \(route-map\)](#)
- [set community \(route-map\)](#)

Guideline

EOS does not support disabling the process of graceful shutdown community.

Example

This command advertises routes only to local peers.

```
switch(config-route-map-map1)#show active
route-map map1 permit 10
  match community instances <= 50
  set community 0:456 0:2345
switch(config-route-map-map1)#set community local-as
switch(config-route-map-map1)#ip community-list 345 permit 23
switch(config)#route-map map1
switch(config-route-map-map1)#show active
```

```
route-map map1 permit 10
  match community instances <= 50
  set community 0:456 0:2345 local-as
switch(config-route-map-map1)#
```

12.4.8.44 set extcommunity (route-map)

The **set extcommunity** command specifies extended community attribute modifications to routes that are selected for redistribution by the configuration mode route map. The **set extcommunity none** command removes extended community attributes from the route.

The **no set extcommunity** and **default set extcommunity** commands remove the specified **set extcommunity** command from the configuration mode route map statement by deleting the corresponding statement from *running-config*.

Command Mode

Route-Map Configuration

Command Syntax

```
set extcommunity COND_X [COND_2][COND_N][MOD_TYPE]
set extcommunity none
no set extcommunity COND_X[COND_2][COND_N][MOD_TYPE]
no set extcommunity none
default set extcommunity COND_X [COND_2][COND_N][MOD_TYPE]
default set extcommunity none
```

Parameters

- **COND_X** Specifies extended community route map modification. Command may contain multiple attributes. Options include:
 - **rt ASN:nn** Route target attribute (AS:network number).
 - **rt IP-address:nn** Route target attribute (IP address: network number).
 - **soo ASN:nn** Site of origin attribute (AS:network number).
 - **soo IP-address:nn** Site of origin attribute (IP address: network number).
- **MOD_TYPE** Specifies route map modification method. Options include:
 - **<no parameter>** Command replaces existing route map with specified parameters.
 - **additive** Command adds specified parameters to existing route map.
 - **delete** Command removes specified parameters from existing route map.

Related Commands

- [route-map](#) enters route map configuration mode.
- [set \(route-map\)](#) specifies attribute modifications for the redistributed routes
- [set \(route-map\)](#) specifies community modifications for the redistributed routes.

Example

This command creates a route map entry in *map1* that sets the route target extended community attribute.

```
switch(config)#route-map map1
switch(config-route-map-map1)#set extcommunity rt 10.13.2.4:100
switch(config-route-map-map1)#
```

12.4.8.45 show (ACL configuration modes)

The **show** command displays the contents of an access control list (ACL).

- **show** or **show pending** displays the list as modified in ACL configuration mode.
- **show active** displays the list as stored in running-config.
- **show comment** displays the comment stored with the list.
- **show diff** displays the modified and stored lists, with flags denoting the modified rules.

Exiting the ACL configuration mode stores all pending ACL changes to **running-config**.

Command Mode

ACL Configuration

IPv6-ACL Configuration

Std-ACL Configuration

Std-IPv6-ACL Configuration

MAC-ACL Configuration

Command Syntax

```
show
```

```
show active
```

```
show comment
```

```
show diff
```

```
show pending
```

Examples

The examples in this section assume these ACL commands are entered as specified.

These commands are stored in none:

```
10 permit ip 10.10.10.0/24 any
20 permit ip any host 10.21.10.1
30 deny ip host 10.10.10.1 host 10.20.10.1
40 permit ip any any
50 remark end of list
```

The current edit session removed this command. This change is not yet stored to none:

```
20 permit ip any host 10.21.10.1
```

The current edit session added these commands ACL. They are not yet stored to none:

```
20 permit ip 10.10.0.0/16 any
25 permit tcp 10.10.20.0/24 any
45 deny pim 239.24.124.0/24 10.5.8.4/30
```

- This command displays the ACL, as stored in the configuration.

```
switch(config-acl-test_1)#show active
IP Access List test_1
 10 permit ip 10.10.10.0/24 any
 20 permit ip any host 10.21.10.1
 30 deny ip host 10.10.10.1 host 10.20.10.1
 40 permit ip any any
 50 remark end of list
```

-
- This command displays the pending ACL, as modified in ACL configuration mode.

```
switch(config-acl-test_1)#show pending
IP Access List test_1
 10 permit ip 10.10.10.0/24 any
 20 permit ip 10.10.0.0/16 any
 25 permit tcp 10.10.20.0/24 any
 30 deny ip host 10.10.10.1 host 10.20.10.1
 40 permit ip any any
 45 deny pim 239.24.124.0/24 10.5.8.4/30
 50 remark end of list
```

- This command displays the difference between the saved and modified ACLs.
 - Rules added to the pending list are denoted with a plus sign (+).
 - Rules removed from the saved list are denoted with a minus sign (-)

```
switch(config-acl-test_1)#show diff
---
+++
@@ -1,7 +1,9 @@
IP Access List test_1
 10 permit ip 10.10.10.0/24 any
 20 permit ip any host 10.21.10.1
 20 permit ip 10.10.0.0/16 any
 25 permit tcp 10.10.20.0/24 any
 30 deny ip host 10.10.10.1 host 10.20.10.1
 40 permit ip any any
 45 deny pim 239.24.124.0/24 10.5.8.4/30
```

12.4.8.46 show hardware tcam profile

The **show hardware tcam profile** command displays the hardware specific information for the current operational TCAM profile in the running configuration.

This command is applicable to DCS-7280(E/R) and DCS-7500(E/R) series switches only.

Command Mode

EXEC

Command Syntax

```
show hardware tcam profile
```

Parameters

- *tcam* Specifies the TCAM information.
- *profile* Specifies the TCAM profile information.

Example

This command displays the current operational TCAM profile details.

```
switch#show hardware tcam profile
Configuration      Status
FixedSystem       default          default
```

12.4.8.47 show ip access-lists

The **show ip access-list** command displays the contents of IPv4 and standard IPv4 access control lists (ACLs) on the switch. Use the **summary** option to display only the name of the lists and the number of lines in each list.

Command Mode

Privileged EXEC

Command Syntax

```
show ip access-list [LIST][SCOPE]
```

Parameters

- LIST Name of lists to be displayed. Selection options include:
 - *<no parameter>* All IPv4 ACLs are displayed.
 - *list_name* Specified IPv4 ACL is displayed.
- SCOPE Information displayed. Selection options include:
 - *<no parameter>* All rules in the specified lists are displayed.
 - *summary* The number of rules in the specified lists are displayed.

Examples

- This command displays all rules in *test1* IPv4 ACL.

```
switch#show ip access-list list2
IP Access List list2
    10 permit ip 10.10.10.0/24 any
    20 permit ip any host 10.20.10.1
    30 deny ip host 10.10.10.1 host 10.20.10.1
switch#
```

- This command displays the name of, and number of rules in, each list on the switch.

```
switch#show ip access-list summary
IPV4 ACL default-control-plane-acl
    Total rules configured: 12
    Configured on: control-plane
    Active on      : control-plane

IPV4 ACL list2
    Total rules configured: 3

IPV4 ACL test1
    Total rules configured: 6

Standard IPV4 ACL test_1
    Total rules configured: 1

IPV4 ACL test_3
    Total rules configured: 0

switch#
```

- This command displays the summary and lists all the configured IPv4 ACLs.

```
switch #show ip access-lists summary
IPV4 ACL default-control-plane-acl [readonly]
    Total rules configured: 17
    Configured on Ingress: control-plane(default VRF)
    Active on Ingress: control-plane(default VRF)
```

```
IPV4 ACL ipAclLimitTest
Total rules configured: 0
Configured on Egress: V12148,2700
Active on Egress: V12148,2700
```

12.4.8.48 show ip prefix-list

The **show ip prefix-list** command displays all rules for the specified IPv4 prefix list. The command displays all IPv4 prefix list rules if a prefix list name is not specified.

Command Mode

EXEC

Command Syntax

```
show ip prefix-list [DISPLAY_ITEMS]
```

Parameters

- **DISPLAY_ITEMS** Specifies the name of prefix lists for which rules are displayed. Options include:
 - *<no parameter>* All IPv4 prefix list rules are displayed.
 - *list_name* Specifies the IPv4 prefix list for which rules are displayed.

Example

This command displays all rules in the route-one IPv4 prefix list:

```
switch(config-ip-pfx)#show ip prefix-list  
ip prefix-list route-one  
  seq 10 deny 10.1.1.0/24  
  seq 20 deny 10.1.0.0/16  
  seq 30 permit 12.15.4.9/32  
  seq 40 deny 1.1.1.0/24  
switch(config-ip-pfx)#
```

12.4.8.49 show ipv6 access-lists

The **show ipv6 access-list** command displays the contents of all IPv6 access control lists (ACLs) on the switch. Use the summary option to display only the name of the lists and the number of lines in each list.

Command Mode

Privileged EXEC

Command Syntax

```
show ipv6 access-list [LIST][SCOPE]
```

Parameters

- LIST Name of lists to be displayed. Selection options include:
 - *<no parameter>* All IPv6 ACLs are displayed.
 - *list_name* Specified IPv6 ACL is displayed.
- SCOPE Information displayed. Selection options include:
 - *<no parameter>* All rules in the specified lists are displayed.
 - *summary* The number of rules in the specified lists are displayed.

Examples

- This command displays all rules in test1 IPv6 ACL.

```
switch#show ipv6 access-list list2
IP Access List list2
    10 permit ipv6 3891:3c58:6300::/64 any
    20 permit ipv6 any host 2fe1:b468:024a::
    30 deny ipv6 host 3411:91c1:: host 4210:cc23:d2de:::
switch#
```

- This command displays the name of, and number of rules in, each list on the switch.

```
switch#show ipv6 access-list summary
IPV6 ACL list2
    Total rules configured: 3

IPV6 ACL test1
    Total rules configured: 6

IPV6 ACL test_1
    Total rules configured: 1

Standard IPV6 ACL test_3
    Total rules configured: 0
switch#
```

12.4.8.50 show ipv6 prefix-list

The **show ipv6 prefix-list** command displays all rules for the specified IPv6 prefix list. The command displays all IPv6 prefix lists if a prefix list name is not specified.

Command Mode

EXEC

Command Syntax

```
show ipv6 prefix-list [DISPLAY_ITEMS]
```

Parameters

- **DISPLAY_ITEMS** Specifies the name of prefix lists for which rules are displayed. Options include:
 - *<no parameter>* All IPv6 prefix lists are displayed.
 - *list_name* Specifies the IPv6 prefix list for which rules are displayed.

Examples

- This command displays all rules in the map1 IPv6 prefix list:

```
switch>show ipv6 prefix-list map1
ipv6 prefix-list map1
seq 10 permit 3:4e96:8ca1:33cf::/64
seq 15 deny 3:4400::/64
seq 20 permit 3:11b1:8fe4:1aac::/64
seq 30 permit 3:1bca:3ff2:634a::/64
seq 40 permit 3:1bca:1141:ab34::/64
switch>
```

- This command displays all prefix lists:

```
switch>show ipv6 prefix-list
ipv6 prefix-list map1
seq 10 permit 3:4e96:8ca1:33cf::/64
seq 15 deny 3:4400::/64
seq 20 permit 3:11b1:8fe4:1aac::/64
seq 30 permit 3:1bca:3ff2:634a::/64
seq 40 permit 3:1bca:1141:ab34::/64
ipv6 prefix-list FREDD
ipv6 prefix-list route-five
ipv6 prefix-list map2
seq 10 deny 10:1:1:1::/64 ge 72 le 80
seq 20 deny 10:1::/32
switch>
```

12.4.8.51 show mac access-lists

The **show mac access-list** command displays the contents of all MAC access control lists (ACLs) on the switch. Use the summary to display only the name of the lists and the number of lines in each list.

Command Mode

Privileged EXEC

Command Syntax

```
show mac access-lists [LIST][SCOPE]
```

Parameters

- LIST Name of lists to be displayed. Selection options include:
 - *<no parameter>* Command displays all ACLs.
 - *list_name* Command displays ACL specified by parameter.
- SCOPE Information displayed. Selection options include:
 - *<no parameter>* Command displays all rules in specified lists.
 - *summary* Command displays the number of rules in specified lists.

Examples

- This command displays all rules in *mtest2* MAC ACL.

```
switch#show mac access-list mlist2
IP Access List mlist2
    10 permit 1024.4510.F125 0.0.0 any aarp
    20 permit any 4100.4500.0000 0.FF.FFFF novell
    30 deny any any
switch#
```

- This command displays the number of rules in each MAC ACL on the switch.

```
switch#show mac access-list summary
MAC ACL mlist1
    Total rules configured: 6

MAC ACL mlist2
    Total rules configured: 3

MAC ACL mlist3
    Total rules configured: 1

MAC ACL mlist4
    Total rules configured: 0
switch#
```

12.4.8.52 show platform arad acl tcam summary

The `show platform arad tcam summary` command displays the percentage of TCAM utilization per forwarding ASIC.

Command Mode

EXEC

Command Syntax

`show platform arad acl tcam summary`

Parameter

summary Displays the ACL TCAM summary.

Example

This command displays the percentage of TCAM utilization per forwarding ASIC.

```
switch#show platform arad acl tcam summary
The total number of TCAM lines per bank is 1024.

=====
Arad3/0:
=====
  Bank      Used      Used %      Used By
   1         4         0          IP RACLs
Total Number of TCAM lines used is: 4

=====
Arad3/4:
=====
  Bank      Used      Used %      Used By
   1         2         0          IP RACLs
Total Number of TCAM lines used is: 2
```

12.4.8.53 show platform arad acl tcam

The **show platform arad acl tcam** command displays the number of TCAM entries (hardware resources) occupied by the ACL on each forwarding ASIC.

This command is applicable only on DCS-7500E, DCS-7280E series switches.

Command Mode

EXEC

Command Syntax

```
show platform arad acl tcam [scope]
```

Parameters

- *scope* Specifies the information displayed. Options include:
 - *detail* Displays the ACL TCAM details.
 - *diff* Displays the difference between hardware and shadow.
 - *hw* Displays the ACL entries from hardware.
 - *shadow* Displays the ACL entries from shadow.
 - *summary* Displays the ACL TCAM summary.

Examples

- This command displays the number of TCAM entries used by Arad0 ASIC. In this example, ACL is applied on 2 VLANs (Vl2148 and Vl2700) but number of TCAM entries occupied is only 1.

```
switch# show platform arad acl tcam detail
ip access-list ipAclLimitTest (Shared RACL, 0 rules, 1 entries,
  direction out,
  state success, Acl Label 2)
Fap: Arad0, Shared: true, Interfaces: Vl2148, Vl2700
Bank Offset Entries
0          0          1
Fap: Arad1, Shared: true, Interfaces: Vl2148
Bank Offset Entries
0          0          1
```

- This command displays the percentage of TCAM utilization per forwarding ASIC.

```
switch# show platform arad acl tcam summary
The total number of TCAM lines per bank is 1024.
=====
Arad0:
=====
Bank   Used           Used %           Used By
  0     1             0      IP Egress PACLs/RACLs
Total Number of TCAM lines used is: 1
=====
Arad1:
=====
Bank   Used           Used %           Used By
  0     1             0      IP Egress PACLs/RACLs
Total Number of TCAM lines used is: 1
```

12.4.8.54 show platform arad mapping

The **show platform arad mapping** command displays the mapping between the interfaces and the forwarding ASICs.

Command Mode

EXEC

Command Syntax

```
show platform arad chip_name mapping
```

Parameter

chip_name Specifies the Arad chip name.

Example This command displays the mapping between the interfaces and the forwarding ASICs on arad3/0 chip.

```
switch#show platform arad arad3/0 mapping
Arad3/0  Port                SysPhyPort    Voq    ( Fap,FapPort)    Xlge    Serdes
-----
          Ethernet3/1/1          34    288          (0 , 2)          n/a          (20)
.....
```

12.4.8.55 show platform fap acl tcam hw

The **show platform fap acl tcam hw** command displays the TCAM entries configured for each TCAM bank including policy-maps and corresponding traffic match.

This command is applicable only on DCS-7280(E/R), DCS-7500(E/R) series switches.

Command Mode

EXEC

Command Syntax

```
show platform fap fap_name acl tcam hw
```

Parameters

- *fap_name* Specifies the switch chip-set name.
- *acl* Specifies the Arad ACL information.
- *tcam* Specifies the Arad TCAM information.
- *hw* Specifies the ACL entries for hardware.

Example

This command displays the TCAM entries configured for each TCAM bank including policy maps and corresponding traffic matches.

```
switch#show platform fap Arad1 acl tcam hw
=====
Arad1 Bank 0 Type: dbPdpIp, dbPdpIp6, dbPdpMpls, dbPdpNonIp, dbPdpTunnel
=====
-----
|Offs|X|PR|TT|R|QI|V6MC|DPRT|SPRT|F|DEST |V|ACT |H|
-----
|29 |4|59| | |01| | | | | | | |3|0008f|0| |
| |4|59| | |01| | | | | | | |0|00000|0|
|30 |4|33| | |01| | | | | | | |3|0008f|0|
| |4|33| | |01| | | | | | | |0|00000|0|
|31 |4|32| | |01| | | | | | | |3|0008f|0|
| |4|32| | |01| | | | | | | |0|00000|0|
|32 |4| | | |01|ff02| | | | | | | |3|00097|0|
| |4| | | |01|ff02| | | | | | | |0|00000|0|
|33 |4|06| | |01| | | |00b3| |26ffd|3|0009b|0|
| |4|06| | |01| | | |00b3| |26ffd|0|00000|0|
|34 |4|06| | |01| | |00b3| | |26ffd|3|0009b|0|
-----
|Offs|X|R|QI|DAHI|PT|DALO |DEST |V|ACT |H|
-----
-----
|Offs|X|TT0|QI|FOI|TT1|DEST |TT1P |PT|VX_DP|PN|F|MC|O|V|HDR OFFSETS |ACT |H|
=====
Arad1 Bank 1 Type: dbIpQos
=====
-----
|Offs|X|TC|CL|DPRT|SPRT|VQ|L4OPS |PP|PR|F|V4_DIP |V4_SIP |V|ACT |H|
-----
|0 |0| | | | | | | | | | | | |3|00000|0|
| |0| | | | | | | | | | | | |0|00000|0|
-----
<-----OUTPUT OMITTED FROM EXAMPLE----->
```

12.4.8.56 show platform fap acl tcam

The **show platform fap tcam** command displays the number of TCAM entries (hardware resources) occupied by the ACL on each forwarding ASIC of Sand platform devices.

Command Mode

Privileged EXEC

Command Syntax

```
show platform fap acl tcam [detail | diff | hw | shadow | summary]
```

Parameter

- detail Displays the number of TCAM entries (hardware resources) occupied by the ACL on each forwarding ASIC.
- diff Displays the difference between hardware and shadow.
- hw Displays ACL entries from hardware.
- shadow Displays ACL entries from shadow.
- summary Displays the percentage of TCAM utilization per forwarding ASIC.

Example

This command displays the number of TCAM entries and other ACL TCAM detail.

```
switch#show platform fap acl tcam detail
ip access-list ipAcl0000 (RACL, 1 rules, 2 entries, direction in, state
success)
Shared: false
Interface: Vlan0002
-----
Fap: Arad3/0
Bank Offset Entries
1      0      2
Interface: Vlan0003
-----
Fap: Arad3/0
Bank Offset Entries
1      2      2
Fap: Arad3/4
Bank Offset Entries
1      0      2
```

12.4.8.57 show platform fap acl

The **show platform fap acl** command displays the ACL information of Sand platform devices.

Command Mode

Privileged EXEC

Command Syntax

```
show platform fap acl [ipkgv | l4ops | mirroring | opkgv | pmf | tcam | udf | vsicfg]
```

Parameters

- ipkgv Displays the ACL Ingress Interface Specification (IPKGV) information.
- l4ops Displays the ACL Layer 4 Options (L4OPS) information.
- mirroring Displays the mirroring ACL information.
- opkgv Displays the ACL Egress Interface Specification (OPKGV) information.
- pmf Displays the Pmf.
- tcam Displays the ACL TCAM information.
- udf Displays the ACL UDF information.
- vsicfg Displays the ACL Virtual Switch Instance (VSI) CONFIG information.

Guidelines

This command is supported on DCS-7280SE and DCS-7500E series platforms only.

Example

This command displays the brief information of all installed mirroring ACLs.

```
switch(config)#show platform fap acl mirroring

=====
Aggregate ACLs
=====

(list2:0->2) type=2; version=0
- list2 [ prio 0 ] => session 2

(list1:10->1,list3:20->3) type=0; version=13
- list3 [ prio 20 ] => session 3
- list1 [ prio 10 ] => session 1

=====
Interface-ACL Mapping
=====

Ethernet1 => (list1:10->1,list3:20->3) [ ipv4 ]
Ethernet33 => (list2:0->2) [ mac ]
```

12.4.8.58 show platform trident tcam

The **show platform trident tcam** command displays the TCAM entries configured for each TCAM group including policy maps and corresponding hits.

Command Mode

EXEC

Command Syntax

```
show platform trident tcam [acl | cpu-bound | detail | entry | mirror | pbr | pipe | qos | shared | summary]
```

Parameters

- *<no parameters>* Displays TCAM entries for each TCAM group.
- **acl** Displays the trident ACL information.
- **cpu-bound** Displays the trident cpu-bound information.
- **detail** Lists all TCAM entries.
- **entry** Displays the TCAM entry information.
- **mirror** Displays the trident Mirroring ACL information.
- **pbr** Displays the trident PBR ACL information.
- **pipe** Allows to specify a pipe for filtering.
- **qos** Displays the trident QOS information.
- **shared** Displays the ACL Sharing information.
- **summary** Displays the TCAM allocation information.

Guidelines

This command is applicable only on DCS-7010, DCS-7050/DCS-7050X, DCS7250X, DCS-7300X series switches.

Examples

- This command displays the trident mirroring ACL information.

```
switch(config)#show platform trident tcam mirror
=== Mirroring ACLs on switch Linecard0/0 ===

Session: mir-sess2

INGRESS ACL mirAcl2* uses 2 entries
Assigned to ports: Ethernet32/1
```

- This command displays detailed information for the TCAM group.

```
switch#show platform trident tcam detail
=== TCAM detail for switch Linecard0/0 ===
TCAM group 9 uses 42 entries and can use up to 1238 more.
Mlag control traffic uses 4 entries.
 589826          0 hits - MLAG - SrcPort UDP Entry
 589827          0 hits - MLAG - DstPort UDP Entry
 589828          0 hits - MLAG - SrcPort TCP Entry
 589829          0 hits - MLAG - DstPort TCP Entry
CVX traffic reserves 6 entries (0 used).
L3 Control Priority uses 23 entries.
 589836          0 hits - URM - SelfIp UDP Entry
 589837          0 hits - URM - SelfIp TCP Entry
589848          0 hits - OSPF - unicast
 589849          71196 hits - OSPFv2 - Multicast
 589850          0 hits - OSPFv3 - Multicast
 589851          0 hits - OSPF Auth ESP - Multicast
 589852          0 hits - OSPF Auth ESP - Unicast
 589853          0 hits - IP packets with GRE type and ISIS protocol
 589854          0 hits - RouterL3 Vlan Priority 6,7 Elevator
 589855          0 hits - RouterL3 DSCP 48-63 Elevator
```



```
589856          0 hits - RouterL3 Priority Elevator
589857          0 hits - NextHopToCpu, Glean
589858          0 hits - L3MC Cpu OIF
IGMP Snooping Flooding reserves 8 entries (6 used).
589864          0 hits - IGMP Snooping Restricted Flooding L3 from local
mlag peer
589865          0 hits - IGMP Snooping Restricted Flooding L3
L4 MicroBfd traffic reserves 1 entries (0 used).
TCAM group 13 uses 99 entries and can use up to 1181 more.
Dot1x MAB traffic uses 1 entries.
851968          0 hits - Dot1xMab Rule

<-----OUTPUT OMITTED FROM EXAMPLE----->

ck338.22:14:38(config-pmap-qos-policy1)#
```

12.4.8.59 show route-map

The **show route-map** command displays the contents of configured route maps.

Command Mode

EXEC

Command Syntax

```
show route-map [map_name]
```

Parameters

- *<no parameter>* Displays the content of all configured route maps
- *map_name* Displays the content of the specified route map

Example

- This command displays the *map1* route map.

```
switch(config)#show route-map map1
route-map map1 permit 10
  Description:
  Match clauses:
  SubRouteMap:
  Set clauses:
    set as-path prepend last-as 12
    set as-path prepend auto auto
```

- This command displays the **map** route map.

```
switch>show route-map map
route-map map permit 5
  Match clauses:
    match as 456
  Set clauses:
route-map map permit 10
  Match clauses:
  match ip next-hop 2.3.4.5
    match as-path path_2
  Set clauses:
    set local-preference 100
```

12.4.8.60 system profile

The **system profile** command creates a new Ternary Content-Addressable Memory (TCAM) profile in the running configuration.

The **default system profile** and **no system profile** commands delete non-default TCAM profiles from the running configuration.

Command Mode

Hardware TCAM

Command Syntax

```
system profile [profile_name| default | mirroring-acl | pbr-match-nexthop-group | qos | tap-
aggregation-default | tap-aggregation-extended | tc-counters]
```

```
default system profile
```

```
no system profile
```

Parameters

- *profile_name* Creates a profile with the specified name.
- default Creates a default profile.
- mirroring-acl Creates a mirroring-ACL profile.
- pbr-match-nexthop-group Creates a pbr-match-nexthop-group profile.
- qos Creates a Quality of Service (QoS) profile.
- tap-aggregation-default Creates a tap-aggregation-default profile.
- tap-aggregation-extended Creates a tap-aggregation-extended profile.
- tc-counters Creates a tc-counters profile.

Guideline

These commands are compatible with the DCS-7280SE and DCS-7500E series switches only.

Examples

- These commands create a mirroring-ACL profile.

```
switch(config)#hardware tcam
switch(config-hw-tcam)#system profile mirroring-acl
switch(config-hw-tcam)#show hardware tcam profile
Configuration      Status
FixedSystem        mirroring-acl     mirroring-acl
switch(config-hw-tcam)#
```

- These commands delete non-default TCAM profiles.

```
switch(config)#hardware tcam
switch(config-hw-tcam)#show hardware tcam profile
Configuration      Status
Linecard9          mirroring-acl     mirroring-acl
Linecard8          mirroring-acl     mirroring-acl
Linecard3          mirroring-acl     mirroring-acl
Linecard4          mirroring-acl     mirroring-acl
Linecard6          mirroring-acl     mirroring-acl
switch(config-hw-tcam)#default system profile
switch(config-hw-tcam)#show hardware tcam profile
Configuration      Status
Linecard9          default           default
Linecard8          default           default
Linecard3          default           default
Linecard4          default           default
Linecard6          default           default
```

```
switch(config-hw-tcam) #
```

- These commands delete TCAM profiles.

```
switch(config-hw-tcam) #show hardware tcam profile
Configuration      Status
Linecard9          tc-counters      tc-counters
Linecard8          tc-counters      tc-counters
Linecard3          tc-counters      tc-counters
Linecard4          tc-counters      tc-counters
Linecard6          tc-counters      tc-counters
switch(config-hw-tcam) #no system profile
switch(config-hw-tcam) #show hardware tcam profile
Configuration      Status
Linecard9          default          default
Linecard8          default          default
Linecard3          default          default
Linecard4          default          default
Linecard6          default          default
switch(config-hw-tcam) #
```

12.5 VARP

Virtual-ARP (VARP) allows multiple switches to simultaneously route packets from a common IP address in an active-active router configuration. Each switch is configured with the same set of virtual IP addresses on corresponding VLAN interfaces and a common virtual MAC address. In MLAG configurations, VARP is preferred over VRRP because VARP does not require traffic to traverse the peer-link to the master router as VRRP would.

A maximum of 500 virtual IP addresses can be assigned to a VLAN interface. All virtual addresses on all VLAN interfaces resolve to the same virtual MAC address.

VARP functions by having each switch respond to ARP and GARP requests for the configured router IP address with the virtual MAC address. The virtual MAC address is only for inbound packets and never used in the source field of outbound packets.

When ip routing is enabled, packets to the virtual MAC address are routed to the next hop destination.

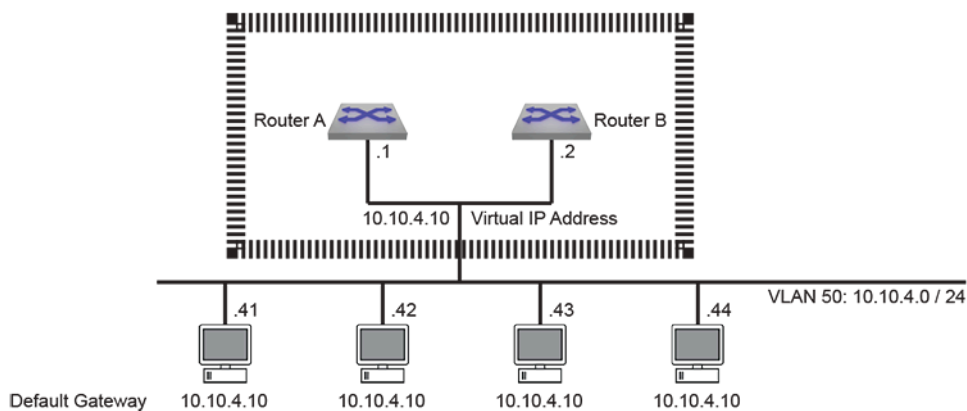

Figure 29: VARP Configuration

The following sections are included in this chapter:

- [VRRP and VARP Conceptual Overview](#)
- [VRRP and VARP Implementation Procedures](#)
- [VRRP and VARP Implementation Examples](#)

- [VRRP and VARP Configuration Commands](#)

12.5.1 VRRP and VARP Conceptual Overview

This section review the following topics:

- [VRRPv2](#)
- [VRRPv3](#)
- [VARP](#)

12.5.1.1 VRRPv2

A virtual router, also known as a virtual router group, is defined by a virtual router identifier (VRID) and a virtual IP address. A virtual routers mapping of VRID and IP address must be consistent among all switches implementing the virtual router group. A virtual routers scope is restricted to a single LAN.

A LAN may contain multiple virtual routers for distributing traffic. Each virtual router on a LAN is assigned a unique VRID. A switch may be configured with virtual routers among multiple LANs.

VRRP uses priority ratings to assign Master or Backup roles for each VRRP router configured for a virtual router group. The Master router sends periodic VRRP Advertisement messages along the LAN and forwards packets received by the virtual router to their destination. Backup routers are inactive but are available to assume Master router duties when the current Master fails.

A VRRP can be configured to allow VRRP routers with higher priority to take over Master router duties. Alternatively, the group can be configured to prevent a router from preemptively assuming the Master role. A VRRP router is always assigned the Master of any virtual router configured with the address owned by the VRRP router, regardless of the preemption prevention setting.

12.5.1.2 VRRPv3

RFC 5798 defines version 3 of the Virtual Router Redundancy Protocol (VRRP) for both IPv4 and IPv6. It is based on version 2 of VRRP, as defined in RFC 3768.

12.5.2 VRRP and VARP Implementation Procedures

This section contains the following configuration instructions:

- [VRRP Configuration for IPv4](#)
- [VRRP Configuration for IPv6](#)
- [VARP Configuration](#)

12.5.2.1 VRRP Configuration for IPv4

To implement a virtual router, it must be configured and enabled. A virtual router is typically configured before it is enabled; this ensures that the VRRP router operates as required before its priority settings immediately make it the master virtual router. Because assigning a primary address to a virtual router enables it, address assignment is normally performed after all other configuration tasks.

The `no vrrp` command removes all VRRP commands for the specified virtual router from *running-config*.

12.5.2.1.1 Virtual Router Configuration

Most configuration tasks are optional because all mandatory parameters have a default value. The following virtual router parameters are configurable:

- VRRP version (default = version 2)
- Router priority (default = 100)

- Preemption option (default is enabled)
- Advertisement timer (default = one second)
- Description (optional parameter)
- Peer authentication (optional parameter)
- Secondary IP addresses (optional parameter)

VRRP Version

The `vrrp ipv4 version` command sets the version of VRRP for the corresponding IPv4 virtual router. IPv6 version is not configurable as it only supports version 3. The version selected in a VRRP group can either be same for all group members or independent of each other. By default, Arista switches use VRRP version 2, which supports only IPv4 environments. VRRP version 3 supports both IPv4 and IPv6 environments.

Example

- This command causes VLAN 20 to use VRRP version 3.

```
switch(config)#interface vlan 20
switch(config-if-vl20)#vrrp 1 ipv4 version 3
switch(config-if-vl20)#
```

Master and Backup Router

The VRRP routers within a virtual router group determine the Master router through priority settings. Priority values range from 254 (highest priority) to 1 (lowest priority). Priority is either set by a CLI command or is assigned the default value of 100. A switch specifies priority settings for each of its virtual routers. Once set, VRRP priority level can also be changed by a tracked object. The `vrrp tracked-object` command configures the VRRP client process to track an object created by the `track` command and react if its status changes to **down**.

Preemption mode determines when a VRRP router with a higher priority rating becomes the Master router. If preemption is enabled, the VRRP router with the highest priority immediately becomes the Master router. If preemption is disabled, a VRRP router with a higher priority value does not become the Master router unless the current Master becomes unavailable; this is applicable when a new VRRP router becomes available on the LAN or VRRP routers priority value changes for the virtual router.

The `vrrp priority-level` command configures the switchs priority setting for the specified virtual router.

Example

- This command sets the priority value of 250 for the virtual router with VRID 15 on VLAN 20.

```
switch(config-if-vl20)#vrrp 15 priority-level 250
switch(config-if-vl20)#
```

The `vrrp preempt` command controls the preempt mode setting of the specified virtual router. By default, preempt mode is enabled.

Examples

- This command disables preempt mode for the virtual router 15 on VLAN 20.

```
switch(config-if-vl20)#no vrrp 15 preempt
switch(config-if-vl20)#
```

- This command enables preempt mode for the virtual router 30 on VLAN 20.

```
switch(config-if-vl20)#vrrp 30 preempt
```

```
switch(config-if-vl20) #
```

The `vrrp preempt delay` command configures a period between an event that elevates a switch to master VRRP router status and the switch's assumption of master VRRP router role. Command options configure delays during normal operation and after a switch reboot.

Advertisement Interval

The Master router sends periodic VRRP Advertisement messages to other VRRP routers. The `vrrp advertisement interval` command specifies the interval between successive advertisement message transmissions.

The advertisement interval also defines the timeout that determines when the switch assumes the Master router role. This timeout interval is three times the advertisement interval.

Example

- This command sets the advertisement interval of 10 seconds for virtual router 35 on VLAN 100.

```
switch(config-if-vl100) #vrrp 35 advertisement interval 10
switch(config-if-vl100) #
```

Description

The `vrrp session description` command associates a text string to the specified virtual router. The maximum string length is 80 characters. The string has no functional impact on the virtual router.

Example

- This command associates the text string *Laboratory Router* to virtual router 15 on VLAN 20.

```
switch(config-if-vl20) #vrrp 15 session description Laboratory Router
switch(config-if-vl20) #
```

Peer Authentication

VRRP peer authentication validates VRRP advertisement packets that the switch receives from other VRRP routers in a specified virtual router group. When a virtual router uses authentication, all VRRP routers in the group must use the same authentication parameters.

The `vrrp peer authentication` command configures virtual router authentication parameters for the specified virtual router.

Example

- This command implements plain-text authentication, using 12345 as the key, for virtual router 40 on VLAN 100.

```
switch(config-if-vl100) #vrrp 40 peer authentication text 12345
switch(config-if-vl100) #
```

Secondary Addresses

The `vrrp ipv4 secondary` command assigns a secondary IP address to a virtual router. Secondary addresses are optional; a virtual router's configuration may include more than one secondary address command. The primary and secondary address list must be identical for all switches in a virtual router group.

A primary IP address is assigned to a virtual router with the `vrrp ipv4` command ([Virtual Router Enabling and the Primary IP address](#)).

Example

- This command assigns the IP address of 10.2.4.5 as the secondary IP address for the virtual router 15 on VLAN 20

```
switch(config-if-vl20)#vrrp 15 ipv4 10.2.4.5 secondary
switch(config-if-vl20)#
```

12.5.2.1.2 Virtual Router Enabling and the Primary IP address

The **vrrp ipv4** command configures the primary IP address of the specified virtual router and enables the virtual router if the primary address is contained within the configuration mode interfaces IP address subnet. A virtual routers configuration may contain only one primary IP address assignment command; subsequent **vrrp ipv4** commands reassign the virtual routers primary IP address.

Example

- This command enables virtual router group 15 (VRID) on VLAN 20 and assigns 10.1.1.5 as the virtual routers primary address.

```
switch(config-if-vl20)#vrrp 15 ipv4 10.1.1.5
switch(config-if-vl20)#
```

12.5.2.1.3 Disabling VRRP

The **vrrp disabled** command places the switch in stopped state for the specified virtual router. While in stopped state, the switch cannot act as a Master or backup router for the virtual router group. The **no vrrp disabled** command changes the switchs virtual router state to **backup** or **master** if the virtual router is properly configured.

VRRP can also be shut down when the status of a tracked object configured by the **vrrp tracked-object** command changes to **down**.

Examples

- This command places the switch in stopped mode for virtual router 24 on VLAN 20.

```
switch(config-if-vl20)#vrrp 24 disabled
switch(config-if-vl20)#
```

- This command moves the switch out of stopped mode for virtual router 24 on VLAN 20.

```
switch(config-if-vl20)#no vrrp 24 disabled
switch(config-if-vl20)#
```

- This command configures the switch to enter stopped mode for virtual router 24 on VLAN 20 if the status of tracked object interfaceE6/48 changes to **down**.

```
switch(config-if-vl20)#vrrp 24 tracked-object interfaceE6/48 shutdown
switch(config-if-vl20)#
```

The **no vrrp** and **no vrrp ipv4** commands delete the specified virtual IP address from the interface. Additionally, the **no vrrp** command removes all residual VRRP commands for the virtual router.

Examples

- This command removes all VRRP configuration commands for virtual router 10 on VLAN 15.

```
switch(config-if-vl15)#no vrrp 10
switch(config-if-vl15)#
```

- This command disables virtual router 25 on VLAN 20 and removes the primary IP address from its configuration.

```
switch(config-if-vl20) #no vrrp 25 ipv4 10.1.1.5
switch(config-if-vl20) #
```

12.5.2.2 VRRP Configuration for IPv6

To implement a virtual router, it must be configured and enabled. A virtual router is typically configured before it is enabled; this ensures that the VRRP router operates as required before its priority settings immediately make it the master virtual router. Because assigning a primary address to a virtual router enables it, address assignment is normally performed after all other configuration tasks.

The `no vrrp` command removes all VRRP commands for the specified virtual router from *running-config*.

12.5.2.2.1 Configuring VRRP for IPv6

Specify the VRRP Version

The `vrrp ipv4 version` command sets the version of VRRP used on an interface. The version selected in a VRRP group must be the same for all group members. By default, Arista switches use VRRP version 2, which is not compatible with IPv6.

Example

- This command causes VLAN 20 to use VRRP version 3.

```
switch(config) #interface vlan 20
switch(config-if-vl20) #vrrp 1 ipv4 version 3
switch(config-if-vl20) #
```

Create a VRRP Group and Configure a Virtual IPv6 Address

The `vrrp ipv6` command assigns an IPv6 address to the interface being configured and creates a VRRP group.

Example

- These commands create VRRP group 3 and configure a virtual IPv6 address for the VRRP group on the VLAN 20 interface.

```
switch(config) #interface vlan 20
switch(config-if-vl20) #vrrp 3 ipv6 2001:db8:0:1::1
switch(config-if-vl20) #
```

Configure Tracking

The `vrrp tracked-object` command configures the VRRP client process to track an object created by the `track` command and react if its status changes to *down*.

Example

- This command causes interface VLAN 20 to disable VRRP when tracked object ETH8 changes state.

```
switch(config-if-vl20) #vrrp 1 tracked-object ETH8 shutdown
switch(config-if-vl20) #
```

Configure the Priority Level

The `vrrp priority-level` command configures the switch's priority setting for the specified virtual router.

Example

- This command sets the priority value of 250 for the virtual router with VRID 15 on VLAN 20.

```
switch(config-if-vl20)#vrrp 15 priority-level 250
switch(config-if-vl20)#
```

Configure the Preemption Mode

Preemption mode determines when a VRRP router with a higher priority rating becomes the Master router. If preemption is enabled, the VRRP router with the highest priority immediately becomes the Master router. If preemption is disabled, a VRRP router with a higher priority value does not become the Master router unless the current Master becomes unavailable; this is applicable when a new VRRP router becomes available on the LAN or VRRP routers priority value changes for the virtual router.

The `vrrp preempt` command controls the preempt mode setting of the specified virtual router. By default, preempt mode is enabled.

Example

- This command enables preempt mode for the virtual router 30 on VLAN 20.

```
switch(config-if-vl20)#vrrp 30 preempt
```

Configure the VRRP Advertisement Interval

The `ip virtual-router mac-address advertisement-interval` command specifies the interval between advertisement packets sent by the master router to the VRRP group members.

Example

- This command configures a MAC address advertisement interval of one minute (60 seconds).

```
switch(config)#interface vlan 20
switch(config-if-vl20)#ip virtual-router mac-address advertisement-
interval 60
switch(config-if-vl20)#
```

12.5.2.2.2 Verify VRRP IPv6 Configurations

Use the following commands to display the VRRP configurations and status.

Show VRRP Group

The `show vrrp` command displays information about the Virtual Router Redundancy Protocol (VRRP) groups configured on a specified interface.

Examples

- This command displays a table of information for VRRP groups on the switch.

```
switch#show vrrp interface vlan 3060 brief
Interface Id Ver Pri Time State VrIps
Vlan3060 1 3 100 3609 Master 2001::2
2001::3
Vlan3060 2 3 100 3609 Master 2002::2
2002::3
```

```
switch#
```

12.5.2.3 VARP Configuration

Implementing VARP consists of assigning virtual IP addresses to VLAN interfaces and configuring a virtual MAC address.

Virtual IP Addresses

The `ip virtual-router address` command assigns a virtual IP address to the VLAN interface being configured. Unlike VRRP, the virtual IP address does not have to be in the same subnet as the physical interface.

A virtual IPv4 address may optionally be configured with a subnet, but doing so will modify the behavior of ARP requests sent from the router. When the router sends an ARP request for an IPv4 address in a virtual subnet, the ARP request will use the virtual IPv4 address as the source IP address and the virtual MAC address as the source MAC address inside the ARP header. For virtual IP addresses configured without the subnet option, no modifications are made to outgoing ARP requests.

Examples

- These commands configure a Switch Virtual Interface (SVI) and a virtual IP address for VLAN 10.

```
switch(config)#interface vlan 10
switch(config-if-Vl10)#ip address 10.0.0.2/24
switch(config-if-Vl10)#ip virtual-router address 10.0.0.6
switch(config-if-Vl10)#ipv6 address 2001::1/64
switch(config-if-Vl10)#ipv6 virtual-router address 2001::2
switch(config-if-Vl10)#exit
switch(config)#
```

- These commands configure a Switch Virtual Interface (SVI) and a virtual IPv4 address with a subnet for VLAN 10. A static route is added to indicate that the virtual subnet is reachable through VLAN 10.

```
switch(config)#ip route 192.0.0.0/24 vlan 10
switch(config)#interface vlan 10
switch(config-if-Vl10)#ip address 10.0.0.2/24
switch(config-if-Vl10)#ip virtual-router address 192.0.0.6/24
switch(config-if-Vl10)#exit
switch(config)#
```

Virtual MAC Address

The `ip virtual-router mac-address` command assigns a virtual MAC address to the switch. The switch maps all virtual router IP addresses to this MAC address. The address is receive-only; the switch never sends packets with this address as the source.

When the destination MAC of a packet destined to a remote network matches the virtual MAC address, the MLAG peer forwards the traffic to the next hop destination. Each MLAG peer must have the same routes available, either through static configuration or learned through a dynamic routing protocol.

Example

- This command configures a virtual MAC address.

```
switch(config)#ip virtual-router mac-address 001c.7300.0099
switch(config)#
```

Show Virtual MAC Address

To display the virtual router MAC and IP addresses, enter the `show ip virtual-router` command.

Example

- This command displays the virtual router addresses assigned on the switch.

```
switch#show ip virtual-router
IP virtual router is configured with MAC address: 24cd.5a29.cc31
Interface  IP Address          Virtual IP Address  Status
Protocol
Vlan15     10.1.1.3/24          10.1.1.15           up           up
Vlan15     10.1.1.3/24          10.1.1.16           up           up
Vlan15     10.1.1.3/24          10.1.1.17           up           up
Vlan20     10.12.1.6/24         10.1.1.51           up           up
Vlan20     10.12.1.6/24         10.1.1.53           up           up
Vlan20     10.12.1.6/24         10.1.1.55           up           up
switch#
```

Show IPv6 Virtual-Router

The `show ipv6 virtual-router` command displays the virtual MAC address assigned to the switch and all virtual IPv6 addresses assigned to each VLAN interface.

Examples

- This command displays a table of information for IPv6 VRRP groups on the switch.

```
switch#show ipv6 virtual-router
IP virtual router is configured with MAC address: 001c.7300.0099
MAC address advertisement interval: 30 seconds
Interface Vlan4094
State is up
Protocol is up
IPv6 address
  2001:b8:2001::1011/64
Virtual IPv6 address
  2001:db8:ac10:fe01::
switch#
```

12.5.3 VRRP and VARP Implementation Examples

This section contains the following example set:

- [VRRP Examples](#)
- [VARP Example](#)

12.5.3.1 VRRP Examples

This section provides code that implements three VRRP configurations:

- Example 1 configures two switches in a single virtual router group. This implementation protects the LAN against the failure of one router.
- Example 2 configures two switches into two virtual routers within a single LAN. This implementation protects the LAN against the failure of one router and balances traffic between the routers.
- Example 3 configures three switches to implement virtual routers on two LANs. Each LAN contains two virtual routers. One switch is configured into four virtual routers – two on each LAN.

12.5.3.1.1 VRRP Example 1: One Virtual Router on One LAN

The network diagram displays the Example 1 network. Two switches are configured as VRRP routers to form one virtual router.

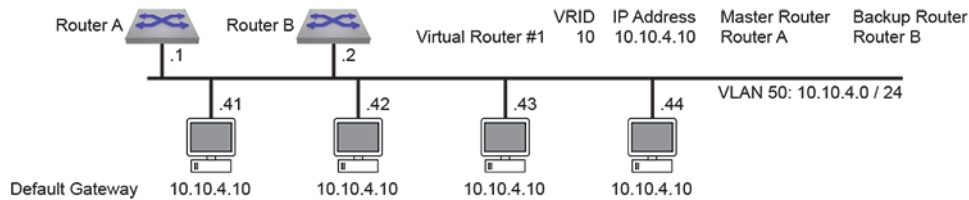

Figure 30: VRRP Example 1 Network Diagram

The following code configures the first switch (Router A) as the master router and the second switch (Router B) as a backup router for virtual router 10 on VLAN 50. Router A becomes the Master virtual router by setting its priority at 200; Router B maintains the default priority of 100. The advertisement interval is three seconds on both switches. Priority preemption is enabled by default.

Switch code that implements Router A on the first switch

```
switch-A(config)#interface vlan 50
switch-A(config-if-vl50)#ip address 10.10.4.1/24
switch-A(config-if-vl50)#no vrrp 10
switch-A(config-if-vl50)#vrrp 10 priority 200
switch-A(config-if-vl50)#vrrp 10 advertisement interval 3
switch-A(config-if-vl50)#vrrp 10 ip 10.10.4.10
switch-A(config-if-vl50)#exit
```

Switch code that implements Router B on the second switch

```
switch-B(config)#interface vlan 50
switch-B(config-if-vl50)#ip address 10.10.4.2/24
switch-B(config-if-vl50)#no vrrp 10
switch-B(config-if-vl50)#vrrp 10 advertisement interval 3
switch-B(config-if-vl50)#vrrp 10 ip 10.10.4.10
switch-B(config-if-vl50)#exit
```

12.5.3.1.2 VRRP Example 2: Two Virtual Routers on One LAN

The network diagram displays Example 2. Two switches are configured as VRRP routers to form two virtual routers on one LAN. Using two virtual routers distributes the LAN traffic between the switches.

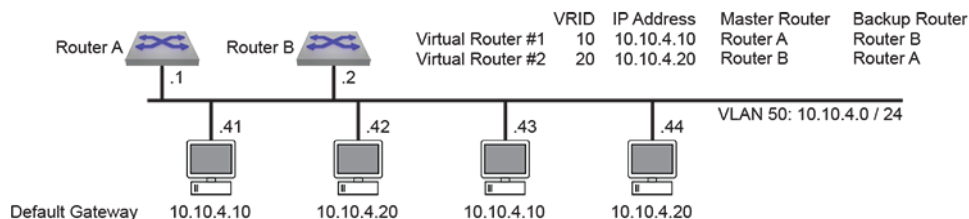

Figure 31: VRRP Example 2 Network Diagram

The following code configures two switches as a master and a backup router for two virtual routers on VLAN 50.

- Router A is the master for virtual router 10 and backup for virtual router 20.
- Router B is the master for virtual router 20 and backup for virtual router 10.

- VRRP advertisement interval is 3 seconds on virtual router 10 and 5 seconds on virtual router 20.
- Priority preemption is enabled by default for both virtual routers.

Switch code that implements Router A on the first switch

```
switch-A(config)#interface vlan 50
switch-A(config-if-vl50)#ip address 10.10.4.1/24
switch-A(config-if-vl50)#no vrrp 10
switch-A(config-if-vl50)#vrrp 10 priority 200
switch-A(config-if-vl50)#vrrp 10 advertisement interval 3
switch-A(config-if-vl50)#vrrp 10 ip 10.10.4.10
switch-A(config-if-vl50)#no vrrp 20
switch-A(config-if-vl50)#vrrp 20 advertisement interval 5
switch-A(config-if-vl50)#vrrp 20 ip 10.10.4.20
switch-A(config-if-vl50)#exit
```

Switch code that implements Router B on the second switch

```
switch-B(config)#interface vlan 50
switch-B(config-if-vl50)#ip address 10.10.4.2/24
switch-B(config-if-vl50)#no vrrp 10
switch-B(config-if-vl50)#vrrp 10 advertisement interval 3
switch-B(config-if-vl50)#vrrp 10 ip 10.10.4.10
switch-B(config-if-vl50)#no vrrp 20
switch-B(config-if-vl50)#vrrp 20 priority 200
switch-B(config-if-vl50)#vrrp 20 advertisement interval 5
switch-B(config-if-vl50)#vrrp 20 ip 10.10.4.20
switch-B(config-if-vl50)#exit
```

12.5.3.1.3 VRRP Example 3: Two Virtual Routers on Two LANs

The network diagram displays Example 3. Three switches are configured as VRRP routers to form four virtual router groups two groups on each of two LANs.

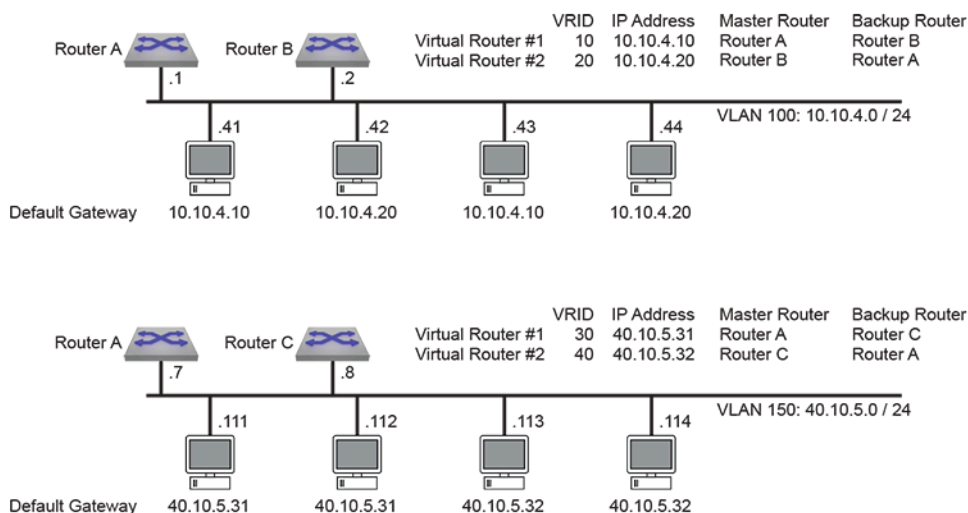

Figure 32: VRRP Example 3 Network Diagram

The following code configures the three switches as follows:

- Router A is the master for virtual router 10 and backup for virtual router 20 on VLAN 100.
- Router A is the master for virtual router 30 and backup for virtual router 40 on VLAN 150.

- Router B is the master for virtual router 20 and backup for virtual router 10 on VLAN 100.
- Router C is the master for virtual router 40 and backup for virtual router 30 on VLAN 150.
- VRRP advertisement interval is set to one second on all virtual routers.
- Priority preemption is disabled on all virtual routers.

Switch code that implements Router A on the first switch

```
switch-A(config)#interface vlan 100
switch-A(config-if-vl100)#ip address 10.10.4.1/24
switch-A(config-if-vl100)#no vrrp 10
switch-A(config-if-vl100)#vrrp 10 priority 200
switch-A(config-if-vl100)#no vrrp 10 preempt
switch-A(config-if-vl100)#vrrp 10 ip 10.10.4.10
switch-A(config-if-vl100)#vrrp 10 advertisement interval 1
switch-A(config-if-vl100)#no vrrp 20
switch-A(config-if-vl100)#no vrrp 20 preempt
switch-A(config-if-vl100)#vrrp 20 ip 10.10.4.20
switch-A(config-if-vl100)#interface vlan 150
switch-A(config-if-vl150)#ip address 40.10.5.7/24
switch-A(config-if-vl150)#no vrrp 30
switch-A(config-if-vl150)#vrrp 30 priority 200
switch-A(config-if-vl150)#no vrrp 30 preempt
switch-A(config-if-vl150)#vrrp 30 ip 40.10.5.31
switch-A(config-if-vl150)#vrrp 30 advertisement interval 1
switch-A(config-if-vl150)#no vrrp 40
switch-A(config-if-vl150)#no vrrp 40 preempt
switch-A(config-if-vl150)#vrrp 40 ip 40.10.5.32
switch-A(config-if-vl150)#exit
```

Switch code that implements Router B on the second switch

```
switch-B(config)#interface vlan 100
switch-B(config-if-vl100)#ip address 10.10.4.2/24
switch-B(config-if-vl100)#no vrrp 10
switch-B(config-if-vl100)#no vrrp 10 preempt
switch-B(config-if-vl100)#vrrp 10 ip 10.10.4.10
switch-B(config-if-vl100)#no vrrp 20
switch-B(config-if-vl100)#vrrp 20 priority 200
switch-B(config-if-vl100)#no vrrp 20 preempt
switch-B(config-if-vl100)#vrrp 20 ip 10.10.4.20
switch-A(config-if-vl100)#vrrp 20 advertisement interval 1
switch-B(config-if-vl100)#exit
```

Switch code that implements Router C on the third switch

```
switch-C(config)#interface vlan 150
switch-C(config-if-vl150)#ip address 40.10.5.8/24
switch-C(config-if-vl150)#no vrrp 30
switch-C(config-if-vl150)#no vrrp 30 preempt
switch-C(config-if-vl150)#vrrp 30 ip 40.10.5.31
switch-C(config-if-vl150)#no vrrp 40
switch-C(config-if-vl150)#vrrp 40 priority 200
switch-C(config-if-vl150)#no vrrp 40 preempt
switch-C(config-if-vl150)#vrrp 40 ip 40.10.5.32
switch-A(config-if-vl100)#vrrp 40 advertisement interval 1
switch-C(config-if-vl150)#exit
```

12.5.3.2 VARP Example

This section provides code that implements a VARP configuration. The network diagram displays the Example 1 network. Two switches in an MLAG domain are configured as VARP routers.

The following code configures 10.10.4.10 as the virtual IP address for VLAN 50, 10.24.4.1 as the virtual IP address for VLAN 70, and 001c.7300.0999 as the virtual MAC address on both switches.

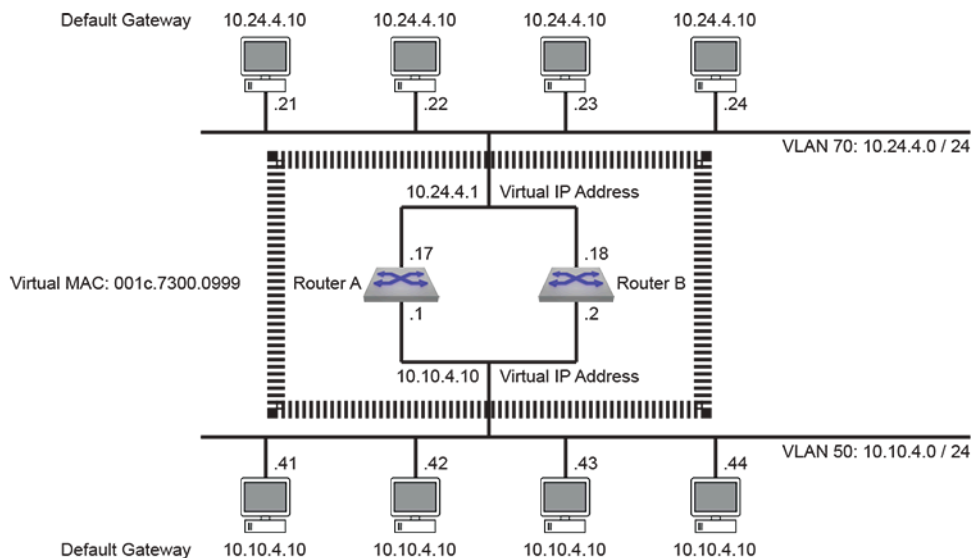

Figure 33: VARP Example Network Diagram

Switch code that implements VARP on the first switch

```
switch-A(config)#ip virtual-router mac-address 001c.7300.0999
switch-A(config)#interface vlan 50
switch-A(config-if-vl50)#ip address 10.10.4.1/24
switch-A(config-if-vl50)#ip virtual-router address 10.10.4.10
switch-A(config-if-vl50)#interface vlan 70
switch-A(config-if-vl70)#ip address 10.24.4.17/24
switch-A(config-if-vl70)#ip virtual-router address 10.24.4.1
switch-A(config-if-vl70)#exit
```

Switch code that implements VARP on the second switch

```
switch-B(config)#ip virtual-router mac-address 001c.7300.0999
switch-B(config)#interface vlan 50
switch-B(config-if-vl50)#ip address 10.10.4.2/24
switch-B(config-if-vl50)#ip virtual-router address 10.10.4.10
switch-B(config-if-vl50)#interface vlan 70
switch-B(config-if-vl70)#ip address 10.24.4.18/24
switch-B(config-if-vl70)#ip virtual-router address 10.24.4.1
switch-B(config-if-vl70)#exit
```

12.5.4 VRRP and VARP Configuration Commands

This section contains descriptions of CLI commands that support VRRP and VARP.

Global Configuration Commands

- `ip fhrp accept-mode`
- `ip virtual-router mac-address`
- `ip virtual-router mac-address advertisement-interval`

Interface Configuration Commands Ethernet, Port Channel, and VLAN Interfaces

- `ip virtual-router address`
- `ipv6 virtual-router address`
- `no vrrp`
- `vrrp advertisement interval`
- `vrrp disabled`
- `vrrp ipv4`
- `vrrp ipv4 checksum pseudo-header exclude`
- `vrrp ipv4 secondary`
- `vrrp ipv4 version`
- `vrrp ipv6`
- `vrrp mac-address advertisement-interval`
- `vrrp peer authentication`
- `vrrp preempt`
- `vrrp preempt delay`
- `vrrp priority-level`
- `vrrp session description`
- `vrrp timers delay reload`
- `vrrp tracked-object`

Privileged EXEC Commands

- `show ip virtual-router`
- `show ipv6 virtual-router`
- `show vrrp`

12.5.4.1 ip fhrp accept-mode

The **ip fhrp accept-mode** command configures the switch to permit SSH access to the VRRP Master and VARP Master router. All routers within a VRRP or VARP group should be configured consistently. By default, SSH access to the VRRP and VARP Master routers is not permitted.

The **no ip fhrp accept-mode** and **default ip fhrp accept-mode** commands restores the default SSH access availability by removing the **ip fhrp accept-mode** command from *running-config*.

Command Mode

Global Configuration

Command Syntax

ip fhrp accept-mode

no ip fhrp accept-mode

default ip fhrp accept-mode

Example

- This command configures the switch to permit SSH access to the VRRP and VARP Master routers.

```
switch(config)#ip fhrp accept-mode
switch(config)#show running-config

!
ip fhrp accept-mode
!

switch(config)#
```

12.5.4.2 ip virtual-router address

The **ip virtual-router address** command assigns a virtual IPv4 address to the VLAN interface being configured. (To assign a virtual IPv6 address to a VLAN interface, use the **ipv6 virtual-router address** command.) Unlike VRRP, the virtual IP address does not have to be in the same subnet as the physical interface.

A virtual IP address may optionally be configured with a subnet, but doing so will modify the behavior of ARP requests sent from the router. When the router sends an ARP request for an IP address in a virtual subnet, the ARP request will use the virtual IP address as the source IP address and the virtual MAC address as the source MAC address inside the ARP header. For virtual IP addresses configured without the subnet option, no modifications are made to outgoing ARP requests.

A maximum of 500 virtual IP addresses can be assigned to a VLAN interface. All virtual addresses on all VLAN interfaces resolve to the same virtual MAC address configured through the **ip virtual-router mac-address** command.

This command is typically used in MLAG configurations to create identical virtual routers on switches connected to the MLAG domain through an MLAG.

The **no ip virtual-router address** and **default ip virtual-router address** commands remove the specified virtual IP address from the configuration mode interface by deleting the corresponding **ip virtual-router address** command from **running-config**. If the command does not specify an address, all virtual IPv4 addresses are removed from the interface.

Command Mode

Interface-VLAN Configuration

Command Syntax

```
ip virtual-router address ipv4_addr
no ip virtual-router address [ipv4_addr]
default ip virtual-router address [ipv4_addr]
```

Parameters

- *ipv4_addr* IP address of router. Dotted decimal notation.

Examples

- These commands configure a Switch Virtual Interface (SVI) and a virtual IP address for VLAN 10.

```
switch(config)#interface vlan 10
switch(config-if-Vl10)#ip address 10.0.0.2/24
switch(config-if-Vl10)#ip virtual-router address 10.0.0.6
switch(config-if-Vl10)#exit
switch(config)#
```

- These commands configure a Switch Virtual Interface (SVI) and a virtual IP address with a subnet for VLAN 10. A static route is added to indicate that the virtual subnet is reachable through VLAN 10.

```
switch(config)#ip route 192.0.0.0/24 vlan 10
switch(config)#interface vlan 10
switch(config-if-Vl10)#ip address 10.0.0.2/24
switch(config-if-Vl10)#ip virtual-router address 192.0.0.6/24
switch(config-if-Vl10)#exit
switch(config)#
```

12.5.4.3 ip virtual-router mac-address advertisement-interval

The `ip virtual-router mac-address advertisement interval` command specifies the period between the transmission of consecutive gratuitous ARP requests that contain the virtual router mac address for each virtual-router IP address configured on the switch. The default period is 30 seconds.

The `no ip virtual-router mac-address advertisement-interval` command restores the default period of 30 seconds by removing the `ip virtual-router mac-address advertisement-interval` command from *running-config*.

Command Mode

Global Configuration

Command Syntax

```
ip virtual-router mac-address advertisement-interval period
no ip virtual-router mac-address advertisement-interval
default ip virtual-router mac-address advertisement-interval
```

Parameters

- *period* advertisement interval (seconds). Values range from 0 to 86400. Default is 30.

Examples

- This command configures a MAC address advertisement interval of one minute (60 seconds).

```
switch(config)#ip virtual-router mac-address advertisement-interval 60
switch(config)#
```

12.5.4.4 ip virtual-router mac-address

The **ip virtual-router mac-address** command assigns a virtual MAC address to the switch. The switch maps all virtual router IP addresses to this MAC address. The address is receive-only; the switch never sends packets with this address as the source. The virtual router is not configured on the switch until this virtual mac-address is assigned.

This command is typically used in MLAG configurations to create identical virtual routers on switches connected to the MLAG domain through an MLAG. When the destination MAC of a packet destined to a remote network matches the virtual MAC address, the MLAG peer forwards the traffic to the next hop destination. Each MLAG peer must have the same routes available, either through static configuration or learned through a dynamic routing protocol.

The **no ip virtual-router mac-address** command removes a virtual MAC address from the interface by deleting the corresponding **ip virtual-router mac-address** command from *running-config*.

Command Mode

Global Configuration

Command Syntax

```
ip virtual-router mac-address mac_addr  
no ip virtual-router mac address [mac_addr]
```

Parameters

- *mac_addr* MAC IP address (dotted hex notation). Select an address that will not otherwise appear on the switch.

Examples

- This command configures a virtual MAC address.

```
switch(config)#ip virtual-router mac-address 001c.7300.0099  
switch(config)#
```

12.5.4.5 ipv6 virtual-router address

The **ipv6 virtual-router address** command assigns a virtual IPv6 address to the VLAN interface being configured. (To assign a virtual IPv4 address to a VLAN interface, use the **ip virtual-router address** command.) Unlike VRRP, the virtual IP address does not have to be in the same subnet as the physical interface.

A maximum of 500 virtual IP addresses can be assigned to a VLAN interface. All virtual addresses on all VLAN interfaces resolve to the same virtual MAC address configured through the **ip virtual-router mac-address** command.

This command is typically used in MLAG configurations to create identical virtual routers on switches connected to the MLAG domain through an MLAG.

The **no ipv6 virtual-router address** and **default ipv6 virtual-router address** commands remove the specified virtual IPv6 address from the configuration mode interface by deleting the corresponding **ipv6 virtual-router address** command from **running-config**. If the command does not specify an address, all virtual IPv6 addresses are removed from the interface.

Command Mode

Interface-VLAN Configuration

Command Syntax

```
ipv6 virtual-router address net_addr
no ipv6 virtual-router address [net_addr]
default ipv6 virtual-router address [net_addr]
```

Parameters

- *net_addr* network IPv6 address.

Examples

- These commands configure a Switch Virtual Interface (SVI) and a virtual IPv6 address for VLAN 10.

```
switch(config)#interface vlan 10
switch(config-if-Vl10)#ipv6 address 2001:0DB8:0:1::1/64
switch(config-if-Vl10)#ipv6 virtual-router address 2001:0DB8:0:1::2
switch(config-if-Vl10)#exit
switch(config)#
```

12.5.4.6 no vrrp

The **no vrrp** command removes all VRRP configuration commands for the specified virtual router on the configuration mode interface. The **default vrrp** command also reverts VRRP configuration parameters to default settings by removing the corresponding **vrrp** commands.

Commands removed by the **no vrrp** command include:

- [vrrp advertisement interval](#)
- [vrrp disabled](#)
- [vrrp ipv4](#)
- [vrrp ipv4 secondary](#)
- [vrrp peer authentication](#)
- [vrrp preempt](#)
- [vrrp preempt delay](#)
- [vrrp priority-level](#)
- [vrrp session description](#)

Command Mode

Interface-Ethernet Configuration

Interface-Port-Channel Configuration

Interface-VLAN Configuration

Command Syntax

```
no vrrp group
```

```
default vrrp group
```

Parameters

- *group* virtual router identifier (VRID). Values range from 1 to 255.

Examples

- This command removes all VRRP configuration commands for virtual router group 10 on VLAN 15.

```
switch(config)#interface vlan 15  
switch(config-if-vl15)#no vrrp 10  
switch(config-if-vl15)#
```

12.5.4.7 show ip virtual-router

The **show ip virtual-router** command displays the virtual MAC address assigned to the switch and all virtual IP addresses assigned to each VLAN interface.

Command Mode

EXEC

Command Syntax

```
show ip virtual-router
```

Messages

- **IP virtual router is not configured** a virtual MAC address is not assigned to the switch.
- **No interface with virtual IP address** no virtual IP addresses are assigned to any VLAN interfaces.

Examples

- This command displays a table of information for VRRP groups on the switch.

```
switch#show ip virtual-router
IP virtual router is configured with MAC address: 24cd.5a29.cc31
Interface  IP Address      Virtual IP Address  Status
Protocol
Vlan15    10.1.1.3/24     10.1.1.15          up          up
Vlan15    10.1.1.3/24     10.1.1.16          up          up
Vlan15    10.1.1.3/24     10.1.1.17          up          up
Vlan20    10.12.1.6/24    10.1.1.51          up          up
Vlan20    10.12.1.6/24    10.1.1.53          up          up
Vlan20    10.12.1.6/24    10.1.1.55          up          up
switch#
```

- This command generates a response that indicates a virtual MAC address is not assigned to the switch.

```
switch#show ip virtual-router
IP virtual router is not configured
switch#
```

12.5.4.8 show ipv6 virtual-router

The **show ipv6 virtual-router** command displays the virtual MAC address assigned to the switch and all virtual IPv6 addresses assigned to each VLAN interface.

Command Mode

EXEC

Command Syntax

```
show ipv6 virtual-router
```

Messages

- **IPv6 virtual router is not configured** a virtual MAC address is not assigned to the switch.
- **No interface with virtual IPv6 address** no virtual IPv6 addresses are assigned to any VLAN interfaces.

Examples

- This command displays a table of information for IPv6 VRRP groups on the switch.

```
switch#show ipv6 virtual-router
IP virtual router is configured with MAC address: 001c.7300.0099
MAC address advertisement interval: 30 seconds
Interface Vlan4094
  State is up
  Protocol is up
  IPv6 address
    2001:b8:2001::1011/64
  Virtual IPv6 address
    2001:db8:ac10:fe01::
switch#
```

12.5.4.9 show vrrp

The **show vrrp** command displays information about the Virtual Router Redundancy Protocol (VRRP) groups configured on a specified interface. Parameter options control the amount and formatting of the displayed information.

Command Mode

Privileged EXEC

Command Syntax

```
show vrrp [INFO_LEVEL] [STATES]
```

```
show vrrp INTF GROUP_NUM [INFO_LEVEL] [STATES]
```

```
show vrrp GROUP_NUM INTF_GROUP [INFO_LEVEL] [STATES]
```

Parameters

- INTF specifies the VRRP groups for which the command displays status. When the parameter is omitted or specifies only an interface, the group list is filtered by the STATES parameter.
 - <no parameter> specified groups on all interfaces.
 - **interface ethernet** *e_num* specified groups on Ethernet interface.
 - **interface loopback** *l_num* specified groups on loopback interface.
 - **interface management** *m_num* specified groups on management interface.
 - **interface port-channel** *p_num* specified groups on port channel interface.
 - **interface vlan** *v_num* specified groups on VLAN interface.
 - **interface vxlan** *vx_num* specified groups on VXLAN interface.
- GROUP_NUM the VRRP ID number of the group for which the command displays status.
 - <no parameter> all groups on specified interface.
 - *vrid_num* virtual router identifier (VRID). Value ranges from 1 to 255.
- INFO_LEVEL Specifies format and amount of displayed information. Options include:
 - <no parameter> displays a block of data for each VRRP group.
 - **brief** displays a single table that lists information for all VRRP groups.
- STATES Specifies the groups, by VRRP router state, that are displayed. Options include:
 - <no parameter> displays data for groups in the master or backup states.
 - **all** displays all groups, including groups in the stopped and interface down states.

Examples

- This command displays a table of information for VRRP groups on the switch.

```
switch#show vrrp brief
Interface Id  Ver  Pri  Time  State  VrIps
Vlan1006  3    2   100 3609  Master 127.38.10.2
Vlan1006  4    3   100 3609  Master 127.38.10.10
Vlan1010  1    2   100 3609  Master 128.44.5.3
Vlan1014  2    2   100 3609  Master 127.16.14.2
switch>
```

- This command displays data blocks for all VRRP groups on VLAN 46, regardless of the VRRP state.

```
switch#show vrrp interface vlan 1006 all
Vlan1010 - Group 1
  VRRP Version 2
  State is Stopped
  Virtual IPv4 address is 128.44.5.3
  Virtual MAC address is 0000.5e00.0101
```

```
Mac Address Advertisement interval is 30s
VRRP Advertisement interval is 1s
Preemption is enabled
Preemption delay is 0s
Preemption reload delay is 0s
Priority is 100
Master Router is 0.0.0.0
Master Advertisement interval is 1s
Skew time is 0.609s
Master Down interval is 3.609s
switch#
```

- This command displays data for all VRRP group 2 on VLAN 1014.

```
switch#show vrrp interface vlan 1014 group 2
Vlan1006 - Group 2
  VRRP Version 2
  State is Master
  Virtual IPv4 address is 127.38.10.2
  Virtual MAC address is 0000.5e00.0103
  Mac Address Advertisement interval is 30s
  VRRP Advertisement interval is 1s
  Preemption is enabled
  Preemption delay is 0s
  Preemption reload delay is 0s
  Priority is 100
  Master Router is 127.38.10.1 (local), priority is 100
  Master Advertisement interval is 1s
  Skew time is 0.609s
  Master Down interval is 3.609s
switch#
```

12.5.4.10 vrrp advertisement interval

The **vrrp advertisement interval** command configures the interval between successive advertisement messages that the switch sends to VRRP routers in the specified virtual router group. The switch must be the groups Master virtual router to send advertisement messages. The advertisement interval must be configured identically on all physical routers in the virtual router group.

The advertisement interval also influences the timeout interval that defines when the virtual router becomes the master virtual router. When preemption is enabled, the virtual router becomes the master when three times the advertisement interval elapses after the switch detects master router priority conditions.

The **no vrrp advertisement interval** and **default vrrp advertisement interval** commands restore the default advertisement interval of one second for the specified virtual router by removing the corresponding **vrrp advertisement interval** command from running-config. The **no vrrp** command also removes the **vrrp advertisement interval** command for the specified virtual router.

Command Mode

Interface-Ethernet Configuration

Interface-Port-Channel Configuration

Interface-VLAN Configuration

Command Syntax

```
vrrp group advertisement interval adv_time  
no vrrp group advertisement interval  
default vrrp group advertisement interval
```

Parameters

- *group* virtual router identifier (VRID). Values range from 1 to 255.
- *adv_time* advertisement interval (seconds). Values range from 1 to 255. Default value is 1.

Example

- This command sets the advertisement interval of five seconds for the virtual router 35 on VLAN 100.

```
switch(config)#interface vlan 100  
switch(config-if-vl100)#vrrp 35 advertisement interval 5  
switch(config-if-vl100)#
```

12.5.4.11 vrrp disabled

The **vrrp disabled** command places the switch in stopped state for the specified virtual router. While in stopped state, the switch cannot act as a Master or backup router for the virtual router group.

The **no vrrp disabled** and **default vrrp disabled** commands remove the corresponding **vrrp disabled** command from **running-config**. This changes the switch's virtual router state to **backup** or **master** if the virtual router is properly configured.

Command Mode

Interface-Ethernet Configuration

Interface-Port-Channel Configuration

Interface-VLAN Configuration

Command Syntax

```
vrrp group disabled
```

```
no vrrp group disabled
```

```
default vrrp group disabled
```

Parameters

- *group* virtual router identifier (VRID). Values range from 1 to 255.

Example

- These commands place the switch in stopped mode for virtual router 24 on VLAN 20.

```
switch(config)#interface vlan 20  
switch(config-if-vl20)#vrrp 24 disabled  
switch(config-if-vl20)#
```

- This command moves the switch out of stopped mode for virtual router 24 on VLAN 20.

```
switch(config-if-vl20)#no vrrp 24 disabled  
switch(config-if-vl20)#
```

12.5.4.12 vrrp ipv4 checksum pseudo-header exclude

This command excludes the pseudo-header in IPv4 VRRPv3 checksum calculation on the VRRP group on the configuration mode interface of the switch and supports IPv4 VRRPv3 interoperability.

The **no** form of the command deletes the **vrrp ipv4 checksum pseudo-header exclude** configuration from the Ethernet interface on the switch.

The **exit** command returns the switch to global configuration mode.

Command Mode

Interface-Ethernet Configuration

Interface-Port-Channel Configuration

Interface-VLAN Configuration

Command Syntax

```
vrrp group ipv4 checksum pseudo-header exclude
```

```
no vrrp group ipv4 checksum pseudo-header exclude
```

Parameter

- *group* virtual router identifier (VRID). Values range from 1 to 255.

Example

- This command excludes the pseudo-header in IPv4 VRRPv3 checksum calculation on VRRP group 1 on interface Ethernet 1.

```
switch(config-if-Et1)#vrrp 1 ipv4 checksum pseudo-header exclude
```

12.5.4.13 vrrp ipv4 secondary

The **vrrp ipv4 secondary** command assigns a secondary IP address to the specified virtual router. Secondary IP addresses are an optional virtual router parameter. A virtual router may contain multiple secondary address commands. The IP address list must be identical for all VRRP routers in a virtual router group.

The virtual router is assigned a primary IP address with the **vrrp ipv4** command.

The **no vrrp ipv4 secondary** and **default vrrp ipv4 secondary** commands remove the secondary IP address for the specified VRRP virtual router by deleting the corresponding **vrrp ipv4 secondary** statement from running-config. The **no vrrp** command also removes all **vrrp ipv4 secondary** commands for the specified virtual router.

Command Mode

Interface-Ethernet Configuration

Interface-Port-Channel Configuration

Interface-VLAN Configuration

Command Syntax

```
vrrp group ipv4 ipv4_addr secondary
```

```
no vrrp group ipv4 ipv4_addr secondary
```

```
default vrrp group ipv4 ipv4_addr secondary
```

Parameters

- *group* virtual router identifier (VRID). Values range from 1 to 255.
- *ipv4_addr* secondary IPv4 address of the virtual router.

Related Commands

- [vrrp ipv4](#)

Example

- This command assigns the IP address of 10.2.4.5 as the secondary IP address for the virtual router with VRID of 15 on VLAN 20

```
switch(config)#interface vlan 20  
switch(config-if-vl20)#vrrp 15 ipv4 10.2.4.5 secondary  
switch(config-if-vl20)#
```

12.5.4.14 vrrp ipv4 version

The **vrrp ipv4 version** command enables VRRP on the configuration mode interface and configures the VRRP version for the specified VRRP virtual router.

The **no vrrp ipv4 version** and **default vrrp ipv4 version** commands restore the default VRRP version to VRRPv2 by removing the corresponding **vrrp ipv4 version** statement from **running-config**.

Command Mode

Interface-Ethernet Configuration

Interface-Port-Channel Configuration

Interface-VLAN Configuration

Command Syntax

```
vrrp group ipv4 version VERSION_NUMBER
```

```
no vrrp group ipv4 version
```

```
default vrrp group ipv4 version
```

Parameters

- *group* virtual router identifier (VRID). Values range from 1 to 255.
- *VERSION_NUMBER* Specifies VRRP version that the switch uses. Default value is 2 (VRRPv2). Options include:
 - **2** VRRP v2 supports IPv4 environment.
 - **3** VRRP v3 supports IPv4 and IPv6 environment.

Examples

- This command enables VRRPv3 for IPv6 on interface Ethernet 3.

```
switch#(config)#interface ethernet 3  
switch#(config-if-Et3)#vrrp 1 ipv4 version 3  
switch#
```

- This command removes VRRPv3 from interface Ethernet 3 and reverts to the default VRRPv2.

```
switch#(config)#interface ethernet 3  
switch#(config-if-Et3)#no vrrp 1 ipv4 version  
switch#(config-if-Et3)#
```

12.5.4.15 vrrp ipv4

The **vrrp ipv4** command configures the primary IP address for the specified VRRP virtual router. The command also activates the virtual router if the primary address is contained in the interfaces subnet. A VRRP virtual routers configuration may contain only one primary IP address assignment command; subsequent **vrrp ipv4** commands replace the existing primary address assignment.

The **vrrp ipv4 secondary** command assigns a secondary IP address to the VRRP virtual router.

The **no vrrp ipv4** and **default vrrp ipv4** commands disable the VRRP virtual router and deletes the primary IP address by removing the corresponding **vrrp ipv4** statement from **running-config**. The **no vrrp** command also removes the **vrrp ipv4** command for the specified virtual router.

Command Mode

Interface-Ethernet Configuration

Interface-Port-Channel Configuration

Interface-VLAN Configuration

Command Syntax

```
vrrp group ipv4 ipv4_address
```

```
no vrrp group ipv4 ipv4_address
```

```
default vrrp group ipv4 ipv4_address
```

Parameters

- *group* virtual router identifier (VRID). Values range from 1 to 255.
- *ipv4_address* IPv4 address of the virtual router.

Related Commands

- [vrrp ipv4 secondary](#)

Example

- This command enables virtual router 15 on VLAN 20 and designates 10.1.1.5 as the virtual routers primary address.

```
switch(config)#interface vlan 20  
switch(config-if-vl20)#vrrp 15 ipv4 10.1.1.5  
switch(config-if-vl20)#
```

12.5.4.16 vrrp ipv6

The **vrrp ipv6** command configures the IPv6 address for the specified VRRP virtual router. The command also activates the virtual router if the primary address is contained in the interfaces subnet.

The **no vrrp ipv6** and **default vrrp ipv6** commands disable the VRRP virtual router and delete the IPv6 address by removing the corresponding **vrrp ipv6** statement from **running-config**. The **no vrrp** command also removes the **vrrp ipv6** command for the specified virtual router.

Command Mode

Interface-Ethernet Configuration

Interface-Port-Channel Configuration

Interface-VLAN Configuration

Command Syntax

```
vrrp group ip ipv6_address
```

```
no vrrp group ip ipv6_address
```

```
default vrrp group ip ipv6_address
```

Parameters

- *group* virtual router identifier (VRID). Values range from 1 to 255.
- *ipv6_address* IPv6 address of the virtual router.

Example

- This command enables address 2001:db8:0:1::1 for IPv6 VRRP on VLAN 20.

```
switch(config)#interface vlan 20  
switch(config-if-vl20)#vrrp 3 ipv6 2001:db8:0:1::1  
switch(config-if-vl20)#
```

- This command disables VRRPv3 on VLAN 20 from virtual router 3.

```
switch(config)#interface vlan 20  
switch(config-if-vl20)#no vrrp 3 ipv6 2001:db8:0:1::1  
switch(config-if-vl20)#
```

12.5.4.17 vrrp mac-address advertisement-interval

The `vrrp mac-address advertisement-interval` command specifies the interval between advertisement packets sent by the master router to the VRRP group members.

The `vrrp mac-address advertisement-interval 0`, `no vrrp mac-address advertisement-interval` and `default vrrp mac-address advertisement-interval` commands disable the feature by removing the `vrrp mac-address advertisement-interval` command from *running-config*.

Command Mode

Interface-Ethernet Configuration

Interface-Port-Channel Configuration

Interface-VLAN Configuration

Command Syntax

```
vrrp group mac-address advertisement-interval period
```

```
no vrrp group mac-address
```

```
default vrrp group mac-address
```

Parameters

- *group* virtual router identifier (VRID). Values range from 1 to 255.
- *period* interval in which the master router sends advertisement packets (seconds). Value ranges from 0 to 3600. Selecting 0 as the interval disables this feature.

Example

- This command specifies the interval between advertisement packets sent to the members of VRRP group 3 on VLAN 20.

```
switch(config)#interface vlan 20
switch(config-if-vl20)#vrrp 3 mac-address advertisement-interval 60
switch(config-if-vl20)#
```

- This command disables the feature on VLAN 20.

```
switch(config)#interface vlan 20
switch(config-if-vl20)#no vrrp 3 mac-address advertisement-interval
switch(config-if-vl20)#
```

12.5.4.18 vrrp peer authentication

The **vrrp peer authentication** command configures parameters the switch uses to authenticate virtual router packets it receives from other VRRP routers in the group.

The **no vrrp peer authentication** and **default vrrp peer authentication** commands disable VRRP peer authentication of packets from the specified virtual router by removing the corresponding **vrrp peer authentication** command from running-config. The **no vrrp** command also removes the **vrrp peer authentication** command for the specified virtual router.

Command Mode

Interface-Ethernet Configuration

Interface-Port-Channel Configuration

Interface-VLAN Configuration

Command Syntax

```
vrrp group peer authentication AUTH_PARAMETER
```

```
no vrrp group peer authentication
```

```
default vrrp group peer authentication
```

Parameters

- *group* virtual router identifier (VRID). Values range from 1 to 255.
- AUTH_PARAMETER encryption level and authentication key used by router. Options include:
 - **text** *text_key* plain-text authentication, *text_key* is text.
 - *text_key* plain-text authentication, *text_key* is text.
 - **ietf-md5 key-string 0** *text_key* IP authentication of MD5 key hash, *text_key* is text.
 - **ietf-md5 key-string** *text_key* IP authentication of MD5 key hash, *text_key* is text.
 - **ietf-md5 key-string 7** *coded_key* IP authentication of MD5 key hash, *coded_key* is MD5 hash.

Guidelines

This command is applicable to VRRPv2 which supports IPv4 addresses only.

Examples

- This command implements plain-text authentication, using 12345 as the key, for virtual router 40 on VLAN 100.

```
switch(config)#interface vlan 100
switch(config-if-vl100)#vrrp 40 peer authentication text 12345
switch(config-if-vl100)#
```

- This command implements ietf-md5 authentication, using 12345 as the key.

```
switch(config-if-vl100)#vrrp 40 peer authentication ietf-md5 key-string
0 12345
switch(config-if-vl100)#
```

- This command implements ietf-md5 authentication, using 12345 as the key. The key is entered as the MD5 hash equivalent of the text string.

```
switch(config-if-vl100)#vrrp 40 peer authentication ietf-md5 key-string
7
EA3TUPxdddFCLYT8mb+kxw==
switch(config-if-vl100)#
```

12.5.4.19 vrrp preempt delay

The `vrrp preempt delay` command specifies the interval between a VRRP preemption event and the point when the switch becomes the master VRRP router. A preemption event is any event that results in the switch having the highest virtual router priority setting while preemption is enabled. The `vrrp preempt` command enables preemption for a specified virtual router.

The command configures two delay periods:

- **minimum** time delays master VRRP takeover when VRRP is fully implemented.
- **reload** time delays master VRRP takeover after VRRP is initialized following a switch reload (boot). The switch bypasses the reload time to become the VRRP master immediately if it senses there are no other active switches in the virtual router group.

Running-config maintains separate delay statements for **minimum** and **reload** parameters. Commands may list both parameters. Commands that list one parameter do not affect the omitted parameter. Values range from 0 to 3600 seconds (one hour). The default delay is zero seconds for both parameters.

The `no vrrp preempt delay` and `default vrrp preempt delay` commands reset the specified delay to the default of zero seconds. Commands that do not list either parameter resets both periods to zero. The `no vrrp` command also removes all `vrrp preempt delay` commands for the specified virtual router.

Command Mode

Interface-Ethernet Configuration

Interface-Port-Channel Configuration

Interface-VLAN Configuration

Command Syntax

```
vrrp group preempt delay [MINIMUM_INTERVAL] [RELOAD_INTERVAL]
```

```
no vrrp group preempt delay [DELAY_TYPE]
```

```
default vrrp group preempt delay [DELAY_TYPE]
```

Parameters

- *group* virtual router identifier (VRID). Values range from 1 to 255.
- MINIMUM_INTERVAL period between preempt event and takeover of master VRRP router role.
 - <no parameter> minimum delay is not altered by command.
 - **minimum** *min_time* delay during normal operation (seconds). Values range from 0 to 3600.
- RELOAD_INTERVAL period after reboot-VRRP initialization and takeover of master VRRP router role.
 - <no parameter> reload delay is not altered by command.
 - **reload** *reload_time* delay after reboot (seconds). Values range from 0 to 3600.
- DELAY_TYPE delay type that is reset to default value.
 - <no parameter> reload and minimum delays are reset to default.
 - **minimum** minimum delay is reset to default.
 - **reload** reload delay is reset to default.

(DELAY_TYPE parameter is only used in `no vrrp preempt delay` and `default vrrp preempt delay` commands).

Related Commands

- `vrrp preempt`

Examples

-
- This command sets the minimum preempt time of 90 seconds for virtual router 20 on VLAN 40.

```
switch(config)#interface vlan 40  
switch(config-if-vl40)#vrrp 20 preempt delay minimum 90  
switch(config-if-vl40)#
```

- This command sets the minimum and reload preempt time to zero for virtual router 20 on VLAN 40.

```
switch(config-if-vl40)#no vrrp 20 preempt delay  
switch(config-if-vl40)#
```

12.5.4.20 vrrp preempt

The `vrrp preempt` command controls a virtual routers preempt mode setting. When preempt mode is enabled, if the switch has a higher priority it will preempt the current master virtual router. When preempt mode is disabled, the switch can become the master virtual router only when a master virtual router is not present on the subnet, regardless of VRRP priority level settings. By default, preempt mode is enabled.

The `no vrrp preempt` and `default vrrp preempt` commands disable preempt mode for the specified virtual router; the `default vrrp preempt` command stores a corresponding `no vrrp preempt` statement in *running-config*. The `vrrp preempt` command enables preempt mode by removing the corresponding `no vrrp preempt` statement from running-config.

The `no vrrp` command also enables preempt mode by removing the `no vrrp preempt` command for the specified virtual router.

Command Mode

Interface-Ethernet Configuration

Interface-Port-Channel Configuration

Interface-VLAN Configuration

Command Syntax

```
vrrp group preempt
```

```
no vrrp group preempt
```

```
default vrrp group preempt
```

Parameters

- `group` virtual router identifier (VRID). Values range from 1 to 255.

Related Commands

- [vrrp preempt delay](#)

Examples

- This command disables preempt mode for virtual router 20 on VLAN 40.

```
switch(config)#interface vlan 40
switch(config-if-vl40)#no vrrp 20 preempt
switch(config-if-vl40)#
```

- This command enables preempt mode for virtual router 20 on VLAN 40.

```
switch(config-if-vl40)#vrrp 20 preempt
switch(config-if-vl40)#
```

12.5.4.21 vrrp priority-level

The **vrrp priority-level** command configures the switch's priority setting for a VRRP virtual router. Priority values range from 1 to 254. The default value is 100.

The router with the highest VRRP priority level setting for a group becomes the master virtual router for that group. The master virtual router controls the IP address and is responsible for forwarding traffic sent. The **vrrp preempt** command controls the time when a switch can become the master virtual router.

The **no vrrp priority-level** and **default vrrp priority-level** commands restore the default priority of 100 to the virtual router on the configuration mode interface by removing the corresponding **vrrp priority-level** command from *running-config*. The **no vrrp** command also removes the **vrrp priority-level** command for the specified virtual router.

Command Mode

Interface-Ethernet Configuration

Interface-Port-Channel Configuration

Interface-VLAN Configuration

Command Syntax

```
vrrp group priority-level level
```

```
no vrrp group priority-level level
```

```
default vrrp group priority-level level
```

Parameters

- *group* virtual router identifier (VRID). Values range from 1 to 255.
- *level* priority setting for the specified virtual router. Values range from 1 to 254.

Examples

- This command sets the virtual router priority value of 250 for virtual router group 45 on VLAN 20.

```
switch(config)#interface vlan 20  
switch(config-if-vl20)#vrrp 45 priority-level 250  
switch(config-if-vl20)#
```

12.5.4.22 vrrp session description

The **vrrp session description** command associates a text string to a VRRP virtual router on the configuration mode interface. The string has no functional impact on the virtual router. The maximum length of the string is 80 characters.

The **no vrrp session description** and **default vrrp session description** commands remove the text string association from the VRRP virtual router by deleting the corresponding **vrrp session description** command from *running-config*. The **no vrrp** command also removes the **vrrp session description** command for the specified virtual router.

Command Mode

Interface-Ethernet Configuration

Interface-Port-Channel Configuration

Interface-VLAN Configuration

Command Syntax

```
vrrp group session description label_text
```

```
no vrrp group session description
```

```
default vrrp group session description
```

Parameters

- *group* virtual router identifier (VRID). Values range from 1 to 255.
- *label_text* text that describes the virtual router. Maximum string length is 80 characters.

Example

- This command associates the text string Laboratory Router to virtual router 15 on VLAN 20.

```
switch(config)#interface vlan 20  
switch(config-if-vl20)#vrrp 15 session description Laboratory Router  
switch(config-if-vl20)#
```

12.5.4.23 vrrp timers delay reload

The `vrrp timers delay reload` command delays the time for VRRP initialization after a system reboot.

The `no vrrp timers delay reload` and `default vrrp timers delay reload` commands restore the default value of 0 by deleting the `vrrp timers delay reload` statement from *running-config*.

Command Mode

Interface-Ethernet Configuration

Interface-Port-Channel Configuration

Interface-VLAN Configuration

Command Syntax

```
vrrp group timers delay reload [INTERVAL]
```

```
no vrrp group timers delay reload
```

```
default vrrp group timers delay reload
```

Parameters

- INTERVAL The number of seconds for the delay (seconds). Options include:
 - <no parameter> Default value of 0 seconds.
 - <0 to 3600> Ranges between 0 and 60 minutes.

Example

- These commands configure the VRRP reload delay interval to 15 minutes.

```
switch(config)#interface vlan 100  
switch(config-if-Vl100)#vrrp 2 timers delay reload 900  
switch(config-if-Vl100)#
```

- These commands removes the VRRP reload delay interval.

```
switch(config)#interface vlan 100  
switch(config-if-Vl100)#no vrrp 2 timers delay reload  
switch(config-if-Vl100)#
```

12.5.4.24 vrrp tracked-object

The `vrrp tracked-object` command configures the VRRP client process on the configuration mode interface to track the specified tracked object and react when its status changes to **down**. The tracked object is created by the `track` command.

The `no vrrp tracked-object` and `default vrrp tracked-object` commands cause the VRRP client process to stop tracking the specified tracked object by removing the corresponding `vrrp tracked-object` command from *running-config*.

Command Mode

Interface-Ethernet Configuration

Interface-Port-Channel Configuration

Interface-VLAN Configuration

Command Syntax

```
vrrp group tracked-object object_name ACTION amount
```

```
no vrrp group tracked-object object_name ACTION
```

```
default vrrp group tracked-object object_name ACTION
```

Parameters

- *group* virtual router identifier (VRID). Values range from 1 to 255.
- *object_name* name of tracked object.
- *amount* amount to decrement VRRP priority level. Values range from 1 to 254.
- **ACTION** The action that VRRP is to take when the tracked objects status changes to **down**. Options include:
 - **decrement** decrease VRRP priority level by *amount*.
 - **shutdown** shut down VRRP on the configuration mode interface.

If both **decrement** and **shutdown** are configured on the same interface for the same VRRP group, then VRRP will be shut down on the interface if the tracked object is down.

Related Commands

- [track](#)

Example

- This command causes Ethernet interface 5 to disable VRRP when tracked object ETH8 changes state.

```
switch(config-if-Et5)#vrrp 1 tracked-object ETH8 shutdown
switch(config-if-Et5)#
```

12.6 OpenFlow

This section describes Arista's OpenFlow implementation. Topics in this section include:

- [OpenFlow Introduction](#)
- [OpenFlow Description](#)
- [OpenFlow Configuration](#)
- [OpenFlow Command Descriptions](#)

12.6.1 OpenFlow Introduction

Arista EOS supports OpenFlow 1.0 controlled by OpenFlow controllers for filtering and redirecting traffic.

12.6.2 OpenFlow Description

OpenFlow is a programmable network protocol that manages and directs traffic among Ethernet switches, routers, and wireless access points over the network in support of Software-Defined Networking (SDN) applications.

OpenFlow can be used for traffic flow management in metro, WAN, and data center networks, and also security management in enterprise and campus data center applications, and other applications with the appropriate use of OpenFlow controllers.

12.6.2.1 OpenFlow Controller

The Arista device supports an active controller connection for which the Arista device will initiate (seek) the TCP connection to a given OpenFlow Controller address.

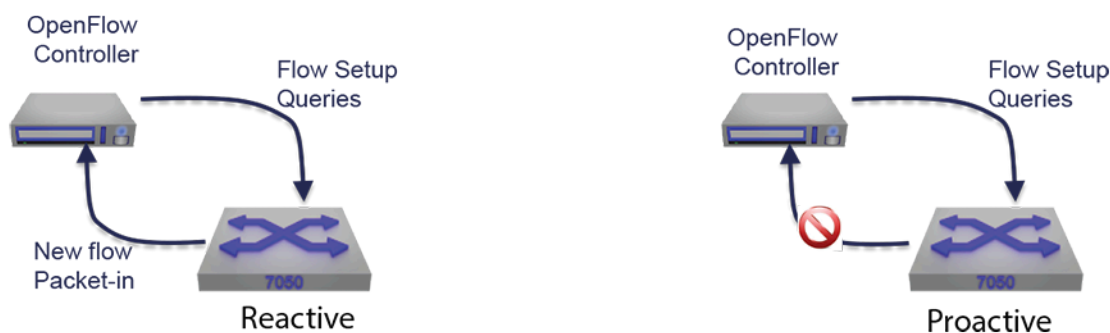

Figure 34: Reactive and proactive modes

The controller can be any standard OpenFlow controller.

Switch consists of three parts:

- A flow table, to tell the switch how to process the flow.
- A channel that connects the switch to a remote controller, allowing commands and packets to be sent between a controller and the switch.
- The OpenFlow Protocol, which provides a way for a controller to communicate with a switch.

An OpenFlow-enabled device supports an OpenFlow Client (control plane software), which communicates with an OpenFlow Controller using the OpenFlow protocol. The OpenFlow Controller runs on a server or a server cluster. OpenFlow-enabled devices support the abstraction of a flow table, which is manipulated by the OpenFlow Controller. A flow is a collection of packets where some selected header fields match particular values for those fields. The flow table is sorted by flow priority, which is defined by the controller.

Flow table

Forwarding decisions for incoming packets are decided by a simple lookup on its flow-table entries. Packets that don't match any flow entry are dropped by default. Every flow entry in the flow-table contains:

- Header fields to match against packets: Each entry contains a specific value, or ANY, which matches any value.

Ingress Port	Ether Source	Ether Dst	Ether Type	VLAN Id	IP Proto	Src Port	Dst Port
--------------	--------------	-----------	------------	---------	----------	----------	----------

- Counters to update for matching packet: These counters are used for statistics purposes, in order to keep track of the number of packets and bytes for each flow and the time that has elapsed since the flow initiation.
- Actions to apply to matching packets: The action specifies the way in which the packets of a flow will be processed. An action can be one of the following: 1) forward the packet to a given port or ports, after optionally rewriting some header fields, 2) drop the packet 3) forward the packet to the controller.

Channel

The channel is the interface that connects each OpenFlow switch to a controller. Through this interface the controller exchanges messages with the switches in order to configure and manage them

12.6.2.2 OpenFlow Modes

Bind modes

The switch can be configured to divide traffic entering the switch in either of two ways:

- By interface, so that only packets arriving on certain interfaces are processed by OpenFlow (interface bind mode, the default).
- By VLAN, so that only packets associated with certain VLAN IDs are processed by OpenFlow (VLAN bind mode).

Other packets are forwarded normally according to the MAC address table, filtered by ACLs, mirrored to other ports.

 **Note:** The hybrid mode of operation is experimental.

The switch can also be configured to apply a limited set of OpenFlow actions to any packets, regardless of ingress interface or VLAN, as well as forward the packets normally (monitor bind mode).

Interface bind mode

When the switch is configured in interface bind mode, the ingress interface of a packet is processed according to entries in the OpenFlow table.

Only interfaces bound to OpenFlow are mapped to OpenFlow ports and exposed to the controller via features reply and port status messages. Output actions in flow table entries and in packet out messages can refer only to mapped ports. Use the [show openflow ports](#) command to see which interfaces the switch maps to OpenFlow ports and exposes to the controller.

- In OpenFlow configuration mode, use the [bind mode \(OpenFlow\)](#) command to select interface bind mode.
- In the OpenFlow configuration mode, use the [bind interface](#) command to bind one or more interfaces to OpenFlow.

When an interface is bound to OpenFlow, certain switch functions are disabled on the interface, including spanning tree protocol (STP). The OpenFlow controller and application must ensure that flow table entries do not allow traffic to loop in the network.

Only Ethernet and Port-Channel interfaces can be bound to OpenFlow. If an Ethernet interface is configured as a member of a LAG, attempting to bind the interface to OpenFlow has no effect. However, the Port-Channel interface of which it is a member may itself be bound to OpenFlow.

VLAN bind mode

When a packet arrives at a switch interface, the switch assigns it a VLAN for internal processing, based on the switchport configuration of the ingress interface and on the packet's VLAN tag (if any). If the switch is configured in VLAN bind mode, the internal VLAN determines whether the packet is processed according to entries in the OpenFlow table and whether the packet is matched by a given entry in the OpenFlow table. After the switch has processed the packet, the switchport configuration of each potential egress interface controls whether the packet is transmitted tagged with the internal VLAN ID, transmitted untagged, or filtered.

Several configuration commands affect whether packets received on a given interface are processed by OpenFlow, and whether packets directed to an interface via an OpenFlow output action are transmitted or filtered:

Use the VLAN configuration mode command to create the VLANs to be accepted by the switch and processed by OpenFlow.

In the interface configuration mode, use switchport commands to configure the interface as either an access port or a trunk port. For an access port, set the VLAN to an OpenFlow VLAN; for a trunk port, configure which OpenFlow VLANs are allowed.

In OpenFlow configuration mode, use the [bind mode \(OpenFlow\)](#) command to select VLAN bind mode, and use the [bind vlan \(OpenFlow\)](#) command to bind one or more VLANs to OpenFlow.

Untagged packet processing in VLAN bind mode

The OpenFlow protocol also allows a flow table entry to explicitly match untagged packets, or to strip the VLAN tag from matched packets. Since the switch actually assigns a VLAN internally to packets received without a tag, the OpenFlow function on the switch must be configured with a single "native" VLAN ID in order to make sense of such flow entries. When an OpenFlow native VLAN is configured:

- A flow table entry defined to match untagged packets actually matches packets whose internal VLAN is the OpenFlow native VLAN.
- A flow table entry with a strip VLAN tag action actually sets the packet's internal VLAN to the OpenFlow native VLAN.
- Packets sent to the controller via a packet-in message are sent untagged if they are assigned to the native VLAN, and tagged otherwise.
- Untagged packets received from the controller via a packet-out message are assigned to the native VLAN.

In contrast, when no OpenFlow native VLAN is configured:

- Flow table entries defined to match untagged packets or with a strip VLAN tag action are rejected.
- All packets sent to the controller via a packet-in message are sent tagged.
- Untagged packets received from the controller via a packet-out message are dropped.

There is no explicit command to configure the OpenFlow native VLAN. To configure a VLAN as the OpenFlow native VLAN:

- Use the VLAN configuration mode command.
- Every interface handling the OpenFlow traffic, in interface configuration mode, uses switchport commands to configure the interface as either an access port or a trunk port. For an access port, set the access VLAN to N; for a trunk port, either set the native VLAN to N or configure the interface to drop untagged frames.
- In OpenFlow configuration mode, use the [bind vlan \(OpenFlow\)](#) command to assign VLAN N to OpenFlow.

Configuring two interfaces as access ports with different OpenFlow-bound VLANs, or as trunk ports with different native OpenFlow-bound VLANs, violates these constraints and causes the OpenFlow function to behave as no OpenFlow native VLAN is configured.

Use the `show openflow` command to see whether an OpenFlow native VLAN has been configured.

Spanning Tree Protocol in VLAN bind mode

STP can operate on OpenFlow-bound VLANs. The switch default STP configuration is one multiple spanning tree (MST) instance containing all VLANs, including OpenFlow-bound VLANs. When STP is configured on OpenFlow-bound VLANs, packets received from or sent to blocked ports are dropped, regardless of the rules defined in the OpenFlow flow table.

For some applications, you may want to disable STP on OpenFlow-bound VLANs. Before doing so, be sure that the OpenFlow controller and application is configured properly to manage multiple redundant paths through the network without allowing traffic to loop.

To ensure proper operation of STP on the switch and to support OpenFlow applications that inter-operate with STP, OpenFlow forwards inbound STP packets both to the spanning tree agent on the switch and to the OpenFlow controller as packet-in messages. This behavior overrides any flow table entries that might otherwise match STP packets, and is not configurable.

Monitor bind mode

Unlike interface and VLAN bind modes, monitor bind mode is tailored for specific applications. The switch both forwards traffic normally and selectively mirrors packets under OpenFlow control.

When the switch is configured in monitor bind mode, all traffic entering the switch is forwarded normally, regardless of ingress interface or internal VLAN. All Ethernet and Port-Channel interfaces are mapped to OpenFlow ports and exposed to the controller (except LAG members and mirror destination ports). In this mode, the entire switch is bound to OpenFlow, and OpenFlow processing is applied to packets in addition to the normal forwarding behavior.

Currently the only actions that can be performed on packets in monitor bind mode are:

- Output normally
- Copy to mirror destination port

In monitor bind mode, the default action taken on packets that are not matched by any flow table entry is output normally. The switch rejects flow entries not conforming to these restrictions.

Routing Between the OpenFlow and Non-OpenFlow Domain

The switch can be configured to perform standard IP routing of traffic processed by OpenFlow. From the controller's point of view, the switch appears to have a virtual port 40000 (OpenFlowRouter) in addition to the physical ports.

Packets sent out the OpenFlowRouter port can undergo standard IP routing into a different IP subnet. After routing, those packets can either exit the switch or be processed by OpenFlow again.

12.6.2.2.1 Port mapping

For switches that support QSFP+ modules, a 40G interface can be configured as four 10G ports. These Ethernet interfaces are mapped to OpenFlow ports according to the formula $\text{port} = M * 200 + N$ for EthernetM/N. For example, interface Ethernet1/1 is mapped to OpenFlow port 201; Ethernet1/2 to OpenFlow port 202, Ethernet16/1 to OpenFlow port 3201, Ethernet16/2 to OpenFlow port 3202, and so on.

When IP routing is configured, the OpenFlow Router interface is mapped to OpenFlow port 40000.

Port-Channel (LAG) interfaces are mapped to OpenFlow ports according to the formula $\text{port} = 40000 + N$ for Port-ChannelN. For example, interface Port-Channel23 is mapped to OpenFlow port 40023.

The OpenFlow virtual ports all and flood refer to all Ethernet interfaces on the switch, but normal VLAN egress policies apply: a packet tagged with a given OpenFlow-bound VLAN (or untagged, if a native OpenFlow VLAN is configured) will egress a given interface only if the interface is configured to handle

traffic for that VLAN. If an interface is not configured to handle traffic for any OpenFlow-bound VLAN, then no packets sent to all or flood will egress on that interface.

12.6.2.2.2 Queue mapping

All multicast transmit queues that are configured to be mapped from a QoS traffic class are mapped to OpenFlow. OpenFlow-mapped queues can be used by the enqueue action in flow table entries and are included in queue stats reply messages. By default, all the multicast queues 0 to 3 are mapped.

Use the `show qos maps` command to view the current mapping of traffic class to multicast transmit queue, and use the `qos map traffic-class to mc-tx-queue` configuration command to modify it. If no traffic class is mapped to a given multicast transmit queue, the queue will not be mapped to OpenFlow and will be unavailable for use by the enqueue action.

12.6.2.2.3 Table size

The switch supports one flow table. OpenFlow packet processing is performed in hardware; software forwarding (via the switch CPU) is not supported.

The switch advertises the table size for the I2-match profile. This should be taken as an approximation, as other switch features such as ACLs can consume hardware resources shared with OpenFlow. If the controller attempts to add a flow entry but there are insufficient resources to implement it in hardware, the switch returns an error message.

12.6.2.2.4 Match fields

A flow table entry can specify an exact value or wildcard for any of the following fields:

- L2 source and destination addresses
- VLAN ID (and untagged packets, if the native OpenFlow VLAN is configured)
- VLAN priority
- L2 frame type
- IPv4 source and destination addresses with subnet masking
- IPv4 TOS/DSCP field
- IPv4 protocol
- TCP/UDP source and destination port numbers

Matching the IPv4 source or destination address within an ARP message is not supported, nor is matching the ARP opcode.

12.6.2.2.5 Actions

In VLAN and interface bind modes, the following flow entry actions are supported:

- Copy packet on ingress to a mirror destination port (vendor-specific extension)
- Set L2 source and destination addresses
- Set VLAN ID
- Strip VLAN tag (if the native OpenFlow VLAN is configured)
- Set VLAN priority
- Set IPv4 TOS/DSCP
- Output or enqueue to physical port (see [OpenFlow Limitations](#) for restrictions on multiple output actions)
- Output or enqueue to all or flood (see [OpenFlow Limitations](#))
- Output to controller (buffering not supported; entire packet contents are always sent)
- Drop (no action)
- Copy packet on egress to a mirror destination port (vendor-specific extension)

In monitor bind mode, only the following actions are supported:

- Copy packet on ingress to a mirror destination port (vendor-specific extension)
- Output per normal forwarding (this action is required in every flow entry)
- Copy packet on egress to a mirror destination port (vendor-specific extension)

12.6.2.3 OpenFlow Limitations

Consider the following when using OpenFlow:

- OpenFlow is supported on both the 7050 and 7050X series of switches.
- OpenFlow Hybrid mode is not supported.
- Output to an ingress port is silently dropped. Flow table entries with an output to ingress port action are accepted by the switch, but matching packets are not actually forwarded via the ingress port. (But for packet-out, the output to ingress port action is supported.)
- Output/enqueue actions must follow modify actions. The switch will return an error if a modify action follows an output/enqueue action.
- Each action can be performed at most once. The switch will return an error if the same action appears more than once. Output and enqueue actions may appear at most once per port.
- Support output to only one queue. The switch will return an error if multiple enqueue actions appear with different queue ids, or if both enqueue and output actions appear.
- Packet is sent at most once per port even if there are overlapping output or enqueue actions. For example, the switch will accept a rule with actions output to all ports and output to a specific port 12, but will transmit the packet on port 12 only once even though it is contained in both actions.
- Flow entry priority is always respected, even for exact-match flow entries. The switch does not force exact-match flow entries to be processed at the highest priority.
- For packet-out messages, only output actions are supported (to a physical port, or to all, flood, or ingress port). The switch will return an error if a packet-out message is received with any other action.
- The switch-to-controller connection is plain TCP. The switch does not support encrypted TLS connections to the controller.
- Matching source and destination IP and operation code in ARP packets is not supported. Flow entries with matching the ARP Ethernet type are accepted by the switch, but the source and destination IP and protocol (opcode) match field values are ignored (i.e. the fields are wildcarded).
- A flow mod message with modify or modify_strict command does not modify the cookie value of existing flow entries. If the modify is treated as an add, however, the new entry will be assigned the specified cookie value.
- Matching all 802.3 packets without SNAP headers is not supported. The switch does not treat a dl_type value of 0x5ff as special.
- The port_mod message is not supported. It is not possible to modify the behavior of physical ports via the port_mod message. In particular, the no_flood port_config bit cannot be used to exclude ports from the flood virtual output port set.
- Changing the list of controllers causes the current controller connection to be dropped. When the OpenFlow feature is enabled and the list of controllers is changed in any fashion (e.g. by adding or deleting a controller), the current controller connection will be dropped.
- When adding a large number of flow table entries, add higher-priority entries before lower-priority entries. Due to hardware limitations, the switch will take much longer to add a new flow entry if the table already contains many entries with lower priority.

12.6.3 OpenFlow Configuration

By default, the OpenFlow feature is disabled on Arista devices. You must first enable the OpenFlow feature on the device. These sections describe OpenFlow configuration tasks:

- [Configuration Procedures](#)

- [Enabling Basic OpenFlow](#)
- [Optional OpenFlow Commands](#)
- [Displaying OpenFlow Configurations](#)

12.6.3.1 Configuration Procedures

Use the OpenFlow configuration mode commands to configure the following basic parameters:

- [openflow](#) : places the switch in OpenFlow configuration mode.
- [controller \(OpenFlow\)](#) : set the controller IP address and port
- [bind interface \(OpenFlow\)](#) : bind interfaces to OpenFlow
- [shutdown \(Openflow\)](#) : enable or disable OpenFlow

12.6.3.2 Enabling Basic OpenFlow

Configure the management interface. Assign an IP address to the interface and set the default gateway IP address, allowing the OpenFlow function on the switch establish a TCP connection with the OpenFlow controller.

The following commands turn on OpenFlow pointing to a controller, ready to receive flow setup messages to be programmed in hardware for all traffic.

- The [openflow](#) command places the switch in OpenFlow configuration mode.

```
switch(config)#openflow
switch(config-OpenFlow)#
```

- The [controller \(OpenFlow\)](#) command points to the primary OpenFlow controller. Others can be configured as a standby list.

```
switch(config)#OpenFlow
switch(config-OpenFlow)#controller tcp:15.16.15.16:6633
switch(config-OpenFlow)#
```

- The [bind vlan \(OpenFlow\)](#) command dictates what VLAN or interfaces are tied to OpenFlow. Since hybrid mode is not supported, Arista recommends binding all VLANs or all interfaces to OpenFlow.

```
switch(config)#openflow
switch(config-openflow)#controller tcp:1.2.3.4:6633
switch(config-openflow)#bind mode vlan
switch(config-openflow)#bind vlan 1
```

- The [shutdown \(Openflow\)](#) command determines if the configuration takes effect or not. The following command enables OpenFlow on the switch.

```
switch(config-OpenFlow)#no shutdown
switch(config-OpenFlow)#
```

12.6.3.3 Optional OpenFlow Commands

Keepalive

The [keepalive \(OpenFlow\)](#) command allows you to set the interval for switch to controller keepalives (default of 10 seconds scales best for large scale multi-node OpenFlow switch networks). After three consecutive reply (from the controller) misses, the switch will try to connect to the second configured controller, if configured.

```
switch(config-OpenFlow)#keepalive
```

```
switch(config-OpenFlow) #
```

Profile

The `profile (OpenFlow)` command determines the type of flows. To double flow table size (in case all flows are L2 only), setting a profile of l2-match is best suited. Default is full-match (includes L3/4 field match).

```
switch(config-OpenFlow) #profile l2-match
switch(config-OpenFlow) #
```

Default-action

The `default-action (OpenFlow)` command tells the Arista OpenFlow agent the action that needs to be taken for packets (drop or send-to-controller) that don't match any existing flows programmed locally on the hardware.

```
switch(config-OpenFlow) #default-action drop
switch(config-OpenFlow) #
```

12.6.3.4 Displaying OpenFlow Configurations

Show commands display the state of OpenFlow running on the Arista switch.

- The `show openflow` command displays the configuration state of the OpenFlow feature and the flows that are actively installed in the hardware of the Arista switch.

```
switch(config)# show openflow
OpenFlow configuration: Enabled
DPID: 0x0000001c73111a92
Description: sw3-Arista
Controllers:
  configured: tcp:172.22.28.228:6633
  connected: tcp:172.22.28.228:6633
  connection count: 3
  keepalive period: 10 sec
Flow table state: Enabled
Flow table profile: full-match
Bind mode: VLAN
  VLANs: 1-2
  native VLAN: 1
IP routing state: Disabled
Shell command execution: Disabled
Total matched: 7977645 packets
```

- The `show openflow flows` command shows the default flow that is installed when OpenFlow is enabled.

```
switch(config)# show OpenFlow flows
Flow flow000000000000000000000005:
  priority: 100
  cookie: 45035996453121666 (0xa000000ab1ae82)
  match:
    ingress interface: Ethernet3
    Ethernet type: IPv4
    source IPv4 address: 10.0.0.0/255.255.255.0
  actions:
    output interfaces: Ethernet11
  matched: 0 packets, 0 bytes
Flow __default__:
```

```
priority: -1
cookie: 0 (0x0)
match:
actions:
  output to controller
matched: 5519922 packets, 433188045 bytes
```

12.6.4 OpenFlow Commands

OpenFlow Global Configuration Mode

- [openflow](#)

Openflow Configuration Commands

- [bind interface \(OpenFlow\)](#)
- [bind mode \(OpenFlow\)](#)
- [bind vlan \(OpenFlow\)](#)
- [controller \(OpenFlow\)](#)
- [default-action \(OpenFlow\)](#)
- [description \(OpenFlow\)](#)
- [keepalive \(OpenFlow\)](#)
- [profile \(OpenFlow\)](#)
- [routing recirculation-interface \(OpenFlow\)](#)
- [routing vlan \(OpenFlow\)](#)
- [shell-command allowed \(OpenFlow\)](#)
- [shutdown \(Openflow\)](#)

OpenFlow Display and Clear Commands

- [clear openflow statistics](#)
- [show openflow](#)
- [show openflow flows](#)
- [show openflow ports](#)
- [show openflow profiles](#)
- [show openflow queues](#)
- [show openflow statistics](#)

12.6.4.1 bind interface (OpenFlow)

When the switch is configured in interface bind mode, the ingress interface of a packet determines whether the packet is processed according to entries in the OpenFlow table or forwarded normally by the switch.

Only interfaces bound to OpenFlow are mapped to OpenFlow ports and exposed to the controller via features reply and port status messages. Output actions in flow table entries and in packet out messages can refer only to mapped ports. Use the **show openflow ports** command to see which interfaces the switch maps to OpenFlow ports and exposes to the controller.

In the OpenFlow configuration mode, use the **bind mode interface** command to select the interface bind mode.

When an interface is bound to OpenFlow, certain switch functions are disabled on the interface, including spanning tree protocol (STP). The OpenFlow controller and application must ensure that flow table entries do not allow traffic to loop in the network.

Only Ethernet and Port-Channel interfaces can be bound to OpenFlow. If an Ethernet interface is configured as a member of a LAG, attempting to bind the interface to OpenFlow has no effect. However, the Port-Channel interface of which it is a member may itself be bound to OpenFlow.

The **no bind interface** and **default bind interface** commands revert the specified list configuration to its default by removing the corresponding **bind interface** command from *running-config*.

Command Mode

OpenFlow Configuration

Command Syntax

```
bind interface INTF
no bind interface [INTF]
default bind interface [INTF]
```

Parameters

- INTF Interface that are tied to OpenFlow. Options include:
 - **ethernet** *e_range* Ethernet interfaces specified by *e_range*.
 - **port-channel** *p_range* port channel interfaces specified by *p_range*.

Valid *e_range* and *p_range* formats include number, range, or comma-delimited list of numbers and ranges.

Example

- This command binds Ethernet 1 to OpenFlow.

```
switch(config)# openflow
switch(config-openflow)#bind interface ethernet 1
```

12.6.4.2 bind mode (OpenFlow)

The **bind mode** command controls the way packets are divided on ingress between OpenFlow processing and normal switch processing.

The switch can be configured to divide traffic entering the switch in the following ways:

- **Interface bind mode:** Packets entering the switch from certain interfaces are only processed by OpenFlow according to flow table entries; packets entering from other interfaces are forwarded normally. (interface bind mode is the default).
- **VLAN bind mode:** Only packets associated with certain VLAN IDs are processed by OpenFlow.
- **Monitor bind mode:** All packets are forwarded normally, and are also processed by OpenFlow; a restricted set of actions are applied to packets matching a flow table entry.

Other packets are forwarded normally according to the MAC address table, filtered by ACLs, mirrored to other ports.

The switch can also be configured to apply a limited set of OpenFlow actions to any packets, regardless of ingress interface or VLAN, as well as forward the packets normally (monitor bind mode).

The **no bind mode** and **default bind mode** commands revert the specified list configuration to its default by removing the corresponding **bind mode** command from *running-config*.

Command Mode

Open flow Configuration

Command Syntax

```
bind mode METHOD
```

```
no bind mode
```

```
default bind mode
```

Parameters

- **METHOD** bind interfaces to OpenFlow. Options include:
 - **interface** Only packets arriving on certain interfaces are processed by OpenFlow.
 - **monitor** All packets are forwarded normally, and are also processed by OpenFlow.
 - **vlan** Only packets associated with certain VLAN IDs are processed by OpenFlow.

Example

- In this example, packets received without VLAN tags are assigned to the default VLAN 1 upon entering the switch and are processed by OpenFlow. All VLAN-tagged packets are dropped.

```
switch#enable
switch#configure
switch(config)#interface et1-48
switch(config-if-Et1-48)#switchport mode access
switch(config-if-Et1-48)#switchport access vlan 1
switch(config-if-Et1-48)#exit
switch(config)#openflow
switch(config-openflow)#controller tcp:1.2.3.4:6633
switch(config-openflow)#bind mode vlan
switch(config-openflow)#bind vlan 1
```

12.6.4.3 bind vlan (OpenFlow)

The **bind vlan** command adds one or more VLAN IDs to the set of VLANs that are processed by OpenFlow in VLAN bind mode. The VLANs must be created separately using the VLAN configuration mode commands.

If you specify a nonexistent VLAN with the **bind vlan** command, the binding will be stored in the running configuration but will not take effect until the VLAN is created.

A range of VLANs may be passed to the **bind vlan** command to add more than one at a time.

The number of VLANs that may be bound to OpenFlow depends on available hardware resources, which are shared with other features including IP routing and ACLs. On the 7050 Series switches the maximum number is 1024.

Use the **show openflow** command to verify which VLANs are bound to OpenFlow; this command reflects the actual hardware state rather than the configuration.

The **no bind vlan** and **default bind vlan** commands removes one or more VLANs from the set of VLANs that are processed by OpenFlow in VLAN bind mode.

Command Mode

OpenFlow Configuration

Command Syntax

```
bind vlan [v_range]
```

```
no bind vlan [v_range]
```

```
default bind vlan [v_range]
```

Parameters

- **v_range** VLAN list. VLAN numbers range from 1 to 4094.

Examples

- These command bind VLANs 1 and 2 to OpenFlow.

```
switch(config-openflow) #bind mode vlan  
switch(config-openflow) #bind vlan 1,2
```

12.6.4.4 clear openflow statistics

The `clear openflow statistics` command resets the flow statistics for OpenFlow.

Command Mode

Privileged EXEC

Command Syntax

```
clear openflow statistics
```

Example

- This command resets the OpenFlow counters.

```
switch #clear openflow statistics  
switch#
```

12.6.4.5 controller (OpenFlow)

The **controller** command adds the address of an OpenFlow controller to which the switch should connect. The parameter must take the form `tcp:1.2.3.4:6633` where 1.2.3.4 is the IP address of the controller and 6633 is the TCP port number.

The **controller** command may be used multiple times to add multiple controllers. The switch will attempt to connect to the first controller in the list of controllers. If the connection attempt fails, or the current connection terminates, the switch will try the next controller in that list, and so on. If the switch cannot connect to the last controller in the list, it will retry with the first controller in the list.

The order in which controllers are added is the order that the switch uses to establish controller connections. This ordering can be seen in the output of the `show openflow` command.

The **no controller** command either removes the specified controller from the list of controllers if a controller address is given as a parameter, or removes all controllers from the list of controllers if **no** parameter is given. If there are no controllers remaining after this command is executed, the OpenFlow function is effectively disabled.



Note: Adding or removing a controller will cause the current controller connection to be dropped. The switch will then attempt to connect to the first controller in the list of controllers, then second controller, and so on.

The **no controller** and **default controller** commands delete s the **controller** statement from *running-config*.

Command Mode

OpenFlow Configuration

Command Syntax

```
controller tcp:ip_address:tcp_port
```

```
no controller tcp:ipaddress:tcp_port
```

```
default controller tcp:ipaddress:tcp_port
```

Parameters

- **ip_address** ip address used for OpenFlow. Dotted decimal location.
- **tcp_port** name of the TCP port used for OpenFlow. Value ranges from 0 to 65535.

Example

- These commands enable OpenFlow and sets the controller for an OpenFlow instance.

```
switch(config)#openflow
switch(config-OpenFlow)#controller tcp:1.2.3.4:6633
```

12.6.4.6 default-action (OpenFlow)

The **default-action** command sets the action for the default flow table entry. This entry is automatically added by the switch. It has the lowest priority, and matches packets that are not matched by any other entry.

Use **default-action drop** to change the default entry's action to drop packets instead of sending them to the controller. (Note: In this mode, the switch deviates from the OpenFlow specification.)

The **no default-action** command restores the default entry's action to send packets to the controller.

Command Mode

OpenFlow Configuration

Command Syntax

```
default-action ACTION_TYPE
```

```
no default-action
```

```
default default-action
```

Parameters

- **ACTION_TYPE** Action for the default flow table entry. Options include:
 - **controller** Sets the default entry's action to send packets to the controller.
 - **drop** Changes the default entry's action to drop packets instead of sending them to the controller.

Example

- This command sets the default entry's action to drop packets instead of sending them to the controller.

```
switch(config)#openflow  
switch(config-OpenFlow)#default-action drop
```

12.6.4.7 description (OpenFlow)

The **description** command allows overriding the switch description string (normally the switch hostname) sent to the controller.

The **no description** and **default description** commands remove the description text for the switch hostname from *running-config*.

Command Mode

OpenFlow Configuration

Command Syntax

```
description label_text
```

```
no description
```

```
default description
```

Parameters

- **label_text** character string up to 256 characters assigned to describe the switch.

Examples

- These commands add the description test to the switch

```
switch(config-openflow) #description test  
switch(config-openflow) #
```

12.6.4.8 keepalive (OpenFlow)

The **keepalive** command alters how often the switch sends an OpenFlow echo request to the currently connected controller (every 10 seconds by default). If an echo reply is not received after three successive echo requests, the switch disconnects from the controller. It then attempts to establish a new controller connection depending on the controller configuration.

The **no keepalive** command restores the default keepalive period by removing the **keepalive** command from the *running-config*.

Command Mode

OpenFlow Configuration

Command Syntax

```
keepalive keep_alive_time
```

```
no keepalive
```

```
default keepalive
```

Parameters

- **keep_alive_time** keepalive period, in seconds. Value ranges from 1 to 100000. Default value is 10 seconds.

Example

- This command sets the keepalive time for OpenFlow to 30 seconds.

```
switch(config)#openflow
switch(config-openflow)#keepalive 30
switch(config-openflow)#
```

12.6.4.9 openflow

The **openflow** command places the switch in OpenFlow configuration mode.

The **no openflow** and **default openflow** commands delete the openflow configuration mode statements from **running-config**.

OpenFlow configuration mode is not a group change mode; **running-config** is changed immediately upon entering commands. Exiting OpenFlow configuration mode does not affect **running-config**. The **exit** command returns the switch to global configuration mode.

Command Mode

Global Configuration

Command Syntax

```
openflow
```

```
no openflow
```

```
default openflow
```

Commands Available in OpenFlow Configuration Mode

- [bind interface \(OpenFlow\)](#)
- [bind mode \(OpenFlow\)](#)
- [bind vlan \(OpenFlow\)](#)
- [controller \(OpenFlow\)](#)
- [default-action \(OpenFlow\)](#)
- [description \(OpenFlow\)](#)
- [keepalive \(OpenFlow\)](#)
- [profile \(OpenFlow\)](#)
- [routing recirculation-interface \(OpenFlow\)](#)
- [routing vlan \(OpenFlow\)](#)
- [shell-command allowed \(OpenFlow\)](#)
- [shutdown \(Openflow\)](#)

Examples:

- This command places the switch in OpenFlow configuration mode:

```
switch(config)#openflow  
switch(config-openflow)#
```

- This command returns the switch to global management mode:

```
switch(config-openflow)#exit  
switch(config)#
```

12.6.4.10 profile (OpenFlow)

The **profile** command sets an alternate flow table profile. Use the [show openflow profiles](#) command to see the flow table profiles supported by the switch.

The **no profile** and **default profile** commands restores the default flow table profile by removing the profile command from the from **running-config**.

Command Mode

OpenFlow Configuration

Command Syntax

```
profile FIELD_TYPE
```

```
no profile
```

```
default profile
```

Parameters

- **FIELD_TYPE** Profiles supported by the switch for the active bind mode. Options include:
 - **full-match** Supports matching the full set of OpenFlow match fields.
 - **l2-match** Supports matching only a subset but with a larger maximum number of flow table entries.

Example

- This command advertises the table size for the full-match flow table profile.

```
switch# (config-openflow) #profile full-match  
switch# (config-openflow) #
```

12.6.4.11 routing recirculation-interface (OpenFlow)

The **routing recirculation-interface** command designates a switch interface to recirculate routed OpenFlow traffic for a second pass of processing. Exactly one recirculation interface must be configured to use routing, regardless of the number of VLANs being routed.

Any Ethernet or Port-Channel interface can be used for OpenFlow routing recirculation.

When an interface is configured for OpenFlow routing recirculation:

- The switch programs the hardware into a special MAC loopback mode, so the interface cannot be used to carry normal traffic.
- The link LED turns green and the recirculation function works even if a transceiver is not present or a cable is not inserted.
- The link speed is forced to the maximum.
- Interface configuration commands such as `switchport` and `shutdown` are ineffective, although they are preserved in the running configuration and become effective again when the interface is no longer configured for OpenFlow routing recirculation.

The **routing recirculation-interface** and **default routing recirculation-interface** commands revert the configuration to its default by removing the corresponding **routing recirculation-interface** command from *running-config*.

Command Mode

OpenFlow Configuration

Command Syntax

```
bind interface INTF
no bind interface [INTF]
default bind interface [INTF]
```

Parameters

- **INTF** Options include:
 - **ethernet** *e_range* Ethernet interfaces specified by *e_range*.
 - **port-channel** *p_range* port channel interfaces specified by *p_range*.

Valid *e_range* and *p_range* formats include number, range, or comma-delimited list of numbers and ranges.

Example

- This command recirculates traffic routed to and from VLAN 1 via the routed transit VLAN 401.

```
switch(config-openflow) #bind mode vlan
switch(config-openflow) #bind vlan 1
switch(config-openflow) #routing recirculation-interface et48
switch(config-openflow) #routing vlan 1 routed-vlan 401
switch(config-openflow) #enable
```

12.6.4.12 routing vlan (OpenFlow)

The **routing vlan** command enables IP routing of traffic processed by OpenFlow for a specific VLAN.

The **no routing vlan** and **default routing vlan** command disables IP routing of traffic processed by OpenFlow for a VLAN.

Command Mode

OpenFlow Configuration

Command Syntax

```
routing vlan VLAN_ID routed-vlan vlan_transit
```

```
no routing vlan VLAN_ID
```

```
default routing vlan VLAN_ID
```

Parameters

- **VLAN_ID** Options include
 - **v_num** The full form of the command is **routing vlan 123 routed-vlan 456**, where 123 is the VLAN of the OpenFlow traffic to be routed, and 456 is a (non-OpenFlow-bound) VLAN configured for standard IP routing.
 - **untagged** To route untagged OpenFlow traffic. use the command **routing vlan untagged routed-vlan 456**.

Examples

- This command associates the VLAN with an untagged VLAN 22 to match during the OpenFlow pass.

```
switch(config-openflow)#routing vlan untagged routed-vlan 22
```

12.6.4.13 shell-command allowed (OpenFlow)

The **shell-command allowed** command allows the controller to run shell or CLI vendor extension commands on the switch.

When this extension is enabled, the switch will execute any CLI command sent by the controller, bypassing normal access controls, so enable it only if the controller is trusted.

The **no shell-command allowed** and **default shell-command allowed** commands disables the corresponding **shell-command allowed** from the *running-config*.

Command Mode

OpenFlow Configuration

Command Syntax

```
shell-command allowed
```

```
no shell-command allowed
```

```
default shell-command allowed
```

Example

- This command allows the controller to run arbitrary CLI commands on the switch.

```
switch(config)#openflow  
switch(config-openflow)#shell-command allowed  
switch(config-openflow)#
```

12.6.4.14 show openflow flows

The **show openflow flows** command displays the contents of the flow table, showing each entry with its match rules, actions, packet counters, and timeouts.

The default flow table entry is automatically created by the switch. It always has the lowest priority, and matches packets that are not matched by any other entry. The default entry's action is to send the packet to the controller.

Command Mode

EXEC

Command Syntax

```
show openflow flows
```

Example

- This command displays the contents of the flow table.

```
switch# show openflow flows
Flow flow00000000000000000002:
priority: 0
cookie: 0 (0x0)
idle timeout: 60.0 sec
match:
ingress interface: Ethernet2
source Ethernet address: 00:a9:87:65:43:21
destination Ethernet address: 00:12:34:56:78:9a
untagged/native VLAN ID
VLAN PCP: 0
Ethernet type: IPv4
source IPv4 address: 10.0.1.1
destination IPv4 address: 10.0.1.2
IPv4 TOS: 0
IPv4 protocol: ICMP
source TCP/UDP port or ICMP type: 8
destination TCP/UDP port or ICMP code: 0
actions:
output interfaces: OpenFlowRouter
matched: 4 packets, 408 bytes
Flow __default__:
priority: -1
cookie: 0 (0x0)
match:
actions:
output to controller
switch#
```

12.6.4.15 show openflow ports

The **show openflow ports** command displays the mapping between OpenFlow port number and switch interface.

In interface bind mode, all OpenFlow-bound interfaces (except routed ports and LAG members) are mapped to OpenFlow ports and exposed to the controller.

In VLAN bind mode, Ethernet and Port-Channel interfaces (except routed ports and LAG members) configured to carry traffic for one or more OpenFlow-bound VLANs are mapped to OpenFlow ports and exposed to the controller.

In monitor bind mode, all Ethernet and Port-Channel interfaces (except routed ports and LAG members) are mapped to OpenFlow ports and exposed to the controller.

Command Mode

EXEC

Command Syntax

```
show openflow ports
```

Example

- This command displays which interfaces the switch maps to OpenFlow ports.

```
switch# show openflow ports  
Port 1: Ethernet1  
Port 15: Ethernet15  
switch#
```

12.6.4.16 show openflow profiles

The **show openflow profiles** command displays the flow table profiles supported by the switch for the active bind mode. For each profile, it shows:

- Which fields can be matched by a flow table entry and which can be wildcarded
- Which actions are supported for matched packets (in monitor bind mode, only normal and mirror actions are supported)
- The maximum number of entries that can be added to the flow table

The hardware resources available to OpenFlow are shared with other switch features like ACLs, so the actual maximum number of flow entries may be lower than the number shown by [show openflow profiles](#) command.

On Series 7050 switches, two profiles are available: the full-match profile supports matching the full set of OpenFlow match fields with a maximum of 750 flow table entries, while the I2-match profile supports matching only a subset but with a larger maximum number of flow table entries (1500).

Command Mode

EXEC

Command Syntax

```
show openflow profiles
```

Example

- This command displays the flow table profiles.

```
switch#show openflow profiles
full-match:
  Match fields:
    ingress interface
    source Ethernet address
    destination Ethernet address
    VLAN ID
    VLAN PCP
    Ethernet type
    source IPv4 address
    destination IPv4 address
    IPv4 TOS
    IPv4 protocol
    source TCP/UDP port or ICMP type
    destination TCP/UDP port or ICMP code
  Wildcard fields:
    ingress interface
    source Ethernet address
    destination Ethernet address
    VLAN ID
    VLAN PCP
    Ethernet type
    source IPv4 address
    destination IPv4 address
    IPv4 TOS
    IPv4 protocol
    source TCP/UDP port or ICMP type
    destination TCP/UDP port or ICMP code
  Actions:
    copy ingress to mirror dest interfaces
    forward normally
    copy egress to mirror dest interfaces
  Table size: 750 entries max
```

```
12-match:
  Match fields:
    ingress interface
    source Ethernet address
    destination Ethernet address
    VLAN ID
    VLAN PCP
    Ethernet type
  Wildcard fields:
    ingress interface
    source Ethernet address
    destination Ethernet address
    VLAN ID
    VLAN PCP
    Ethernet type
    source IPv4 address
    destination IPv4 address
    IPv4 TOS
    IPv4 protocol
    source TCP/UDP port or ICMP type
    destination TCP/UDP port or ICMP code
  Actions:
    copy ingress to mirror dest interfaces
    forward normally
    copy egress to mirror dest interfaces
  Table size: 1500 entries max
switch#
```

12.6.4.17 show openflow queues

The **show openflow queues** command displays the queues exposed to the OpenFlow controller for each switch interface, and packet and byte counters for each queue.

Command Mode

EXEC

Command Syntax

```
show openflow queues
```

Example

- This command displays the packet and byte counters for each queue on the active OpenFlow interfaces.

```
switch#show openflow queues
Port 1 (Ethernet1):
  Queue 0: 0 packets (0 bytes) transmitted, 0 dropped
  Queue 1: 0 packets (0 bytes) transmitted, 0 dropped
  Queue 2: 0 packets (0 bytes) transmitted, 0 dropped
  Queue 3: 0 packets (0 bytes) transmitted, 0 dropped
Port 15 (Ethernet15):
  Queue 0: 0 packets (0 bytes) transmitted, 0 dropped
  Queue 1: 0 packets (0 bytes) transmitted, 0 dropped
  Queue 2: 0 packets (0 bytes) transmitted, 0 dropped
  Queue 3: 0 packets (0 bytes) transmitted, 0 dropped
switch#
```

12.6.4.18 show openflow statistics

The **show openflow statistics** command displays statistics sampled every 5 seconds over the past 5 minutes:

- Number of entries in the flow table
- Number of flow_mod, packet_out and packet_in messages processed in the 5-second interval
- Number of packet_out messages dropped in the 5-second interval (the OpenFlow agent starts dropping packet_out messages when the transmit queue of the controller TCP connection exceeds 50% of capacity)

Command Mode

EXEC

Command Syntax

```
show openflow statistics
```

Example

- This command displays statistics sampled every 5 seconds.

```
switch# show openflow statistics
          table      messages processed last 5 sec      dropped
          entries   (flow_mod) (packet_out) (packet_in) last 5 sec
2013-08-16 14:48:06      4           0           0           0           0
2013-08-16 14:48:01      4           2           2           2           0
2013-08-16 14:47:56      0           0           2           2           0
2013-08-16 14:47:51      4           0           0           0           0
2013-08-16 14:47:46      4           0           0           0           0
2013-08-16 14:47:41      4           0           0           0           0
2013-08-16 14:47:36      4           0           0           0           0
2013-08-16 14:47:31      4           2           2           2           0
2013-08-16 14:47:26      0           0           0           0           0
2013-08-16 14:47:21      4           0           0           0           0
2013-08-16 14:47:16      4           0           0           0           0
2013-08-16 14:47:11      4           0           0           0           0
2013-08-16 14:47:06      4           0           0           0           0
2013-08-16 14:47:01      4           2           2           2           0
2013-08-16 14:46:56      4           2           2           2           0
2013-08-16 14:46:51      4           0           0           0           0
2013-08-16 14:46:46      0           0           0           0           0
2013-08-16 14:46:41      4           0           2           2           0
2013-08-16 14:46:36      4           0           2           2           0
2013-08-16 14:46:31      4           0           0           0           0
2013-08-16 14:46:26      4           0           0           0           0
2013-08-16 14:46:21      4           2           2           2           0
2013-08-16 14:46:16      4           2           2           2           0
2013-08-16 14:46:11      4           0           2           2           0
2013-08-16 14:46:06      0           0           0           0           0
2013-08-16 14:46:01      0           0           0           0           0
2013-08-16 14:45:56      0           0           0           0           0
2013-08-16 14:45:51      0           0           0           0           0
2013-08-16 14:45:46      0           0           0           0           0
2013-08-16 14:45:41      0           0           0           0           0
2013-08-16 14:45:36      0           0           0           0           0
2013-08-16 14:45:31      0           0           0           0           0
2013-08-16 14:45:26      0           0           0           0           0
2013-08-16 14:45:21      4           0           0           0           0
switch#
```

12.6.4.19 show openflow

The **show openflow** command shows the effective OpenFlow configuration parameters.

Command Mode

EXEC

Command Syntax

```
show openflow
```

Example

- This command displays the actual hardware state of OpenFlow.

```
switch# show openflow
OpenFlow configuration: Enabled
DPID: 0x000000123456789a
Description: My awesome OpenFlow switch
Controllers:
configured: tcp:1.2.3.4:6633 tcp:5.6.7.8:6633
connected: tcp:1.2.3.4:6633
attempted connection count: 24
successful connection count: 1
keepalive period: 10 sec
Flow table state: Enabled
Flow table profile: full-match
Bind mode: interface
interfaces: Ethernet2, Ethernet4, Ethernet6, Ethernet8
IP routing state: Enabled
recirculation interface: Ethernet44
VLAN untagged: routed to/from VLAN 3636
Shell command execution: Disabled
Total matched: 4601 packets
switch#
```

12.6.4.20 shutdown (Openflow)

The **shutdown** command, in OpenFlow mode, disables OpenFlow on the switch. OpenFlow is disabled by default.

The **no shutdown** and **default shutdown** commands re-enable OpenFlow by removing the **shutdown** command from *running-config*.

Command Mode

Openflow Configuration

Command Syntax

```
shutdown
```

```
no shutdown
```

```
default shutdown
```

Example

- These commands enable OpenFlow on the switch.

```
switch(config)#openflow
switch(config-openflow)#no shutdown
switch(config-openflow)#
```

- This command disables OpenFlow.

```
switch(config-openflow)#shutdown
```

12.7 DirectFlow

This section describes Arista's DirectFlow implementation. Topics in this section include:

- [Introduction](#)
- [DirectFlow Configuration](#)
- [DirectFlow Feature Interactions](#)
- [DirectFlow Commands](#)

12.7.1 Introduction

Like OpenFlow, DirectFlow exposes the underlying forwarding ASICs capabilities through a programmable interface like EAPI or the standard CLI.

Unlike OpenFlow, DirectFlow works in conjunction with all other aspects of standard L2/L3 bridging or forwarding, and DirectFlow traffic is subject to the standard packet processing pipeline within the ASIC. You can think of DirectFlow as a stage in packet processing that processes traffic after ingress checks and before any egress actions.

This feature enables you to configure flows that consist of a matching criteria and actions, and to modify how traffic is processed (for example, by overriding the L2 lookup decision or rewriting a mac address or VLAN).

Features like MAC learning, STP state checks, ingress or egress VLAN membership checks on ports, ACLs, QoS and other features are all respected by DirectFlow. Traffic that doesn't match any programmed flow is processed normally while traffic that matches programmed flows is now subject to the actions specified in the flows.

DirectFlow and OpenFlow are mutually exclusive and you can run only one of the two at any given time.

How DirectFlow is different from OpenFlow

There is no default flow matching all traffic, so traffic not matched by other rules is forwarded as normal. This means the configuration/ controller/ application doesn't consume TCAM space programming flows for normal forwarding.

DirectFlow works with other features and so the user can use ACL, rate limiting, STP etc. in their network as normal and not build all of that into the application used to inject flows.

DirectFlow flows can be configured from the CLI or using EAPI, giving users the option of using flow based forwarding without an external controller. This is especially useful where the number of flows is small and static, for example, to process a small subset of the traffic in a different manner to the normal L2/L3 pipeline.

Unlike OpenFlow which requires the switch support OUTPUT NORMAL or re-circulate a packet in order to send a packet from the OpenFlow domain to non-OpenFlow domain, there is just one domain with DirectFlow.

12.7.1.1 DirectFlow Flows

Similar to OpenFlow, you can define a relative priority between flows and define idle or hard timeouts for the flow. DirectFlow also enables you to insert a flow entry that matches on specified criteria, and define actions to be taken on traffic that matches the specified matching conditions. You can define flows to match on TCP flags, IPv6 source and destination addresses, input ports, and more.

For more information, see:

- [DirectFlow Non-persistent Flows](#)
- [Supported matches](#)
- [Supported actions](#)

12.7.1.1.1 DirectFlow Non-persistent Flows

DirectFlow enables you to configure flows that are not visible in the startup or running configurations and do not persist over a reboot. This feature is designed to be used for flows that are configured by a custom agent using the EOS SDK or eAPI and age out (expire) after a specified time period.

For example, if you are using a custom agent that reacts to traffic sent to the CPU (the redirect to CPU action), and you want to use a flow that will drop all matching traffic for 5 minutes, the agent can program a non-persistent flow that expires after a hard timeout of 300 seconds.

Using a non-persistent flow for this purpose ensures that other administrator actions (for example, saving the configuration) do not result in the flow being resurrected on startup or reverting to the saved configuration. It also removes the need for the agent to delete the expired flow.

 **Note:** By default, all DirectFlow flows are persistent. You must use the `no persistent` command to configure a non-persistent flow.

12.7.1.1.2 Supported matches

DirectFlow supports all matches supported on EOS with OpenFlow 1.0.

This includes matches on VLAN, ether type, source or destination MAC address, COS, source or destination IP address, IP protocol, IP TOS, L4 source, destination ports, ICMP type, and code.

In addition, DirectFlow also allows matching on:

- TCP flags

- IPv6 source address
- IPv6 destination address
- Traffic injected from the CPU
- Input port

DirectFlow also permits re-using the same flow on multiple input ports, saving valuable TCAM space.

12.7.1.1.3 Supported actions

DirectFlow supports all actions supported on EOS with OpenFlow 1.0, including:

- Setting the source or destination MAC address
- VLAN
- COS
- IP TOS
- Transmit queue
- Output port list and mirroring traffic pre-modification (ingress mirror) and post-modification (egress mirror).
- Redirect to CPU

The redirect to CPU action is useful in cases in which a custom agent is running on EOS and you want to trap specific traffic (matching traffic) and send the trapped traffic to the agent.

12.7.2 DirectFlow Configuration

Consider the following when using DirectFlow.

- DirectFlow takes effect **ONLY** after exiting the individual flow configuration sub-mode.
- Match criteria are connected with Boolean AND operators i.e. they must **all** match for the condition to be true and action to be taken.
- CLI is automatically set to match the ethertype to IP if IP fields (such as source or destination address or L4 ports) are chosen as part of other match/ action commands.
- In a single flow, only the following fields can be matched along with IPv6 source and destination addresses:
 - VLAN priority
 - VLAN ID
 - EtherType
 - Source interface
 - Class of Service (CoS)

12.7.2.1 Commands Used to Enable DirectFlow, Configure and Display Flows

A number of different commands are provided for the DirectFlow feature. The different commands enable you to enter the DirectFlow configuration mode, enable DirectFlow, configure flows, and display configured flows.

 **Note:** ALL match criteria specified in a flow definition must match in the packet for the actions specified to be applied to the traffic.

Enter the DirectFlow Configuration Mode

The `directflow` command places the switch in DirectFlow configuration mode.

```
switch(config) #directflow
switch(config-directflow) #
```

Enable DirectFlow

The `shutdown (DirectFlow)` command determines if the configuration takes effect or not. To enable DirectFlow, enter the following command.

```
switch(config-directflow) #no shutdown
```

Create the Flow

The `flow (DirectFlow)` command creates a new flow entry. It must be unique or it will be overwritten by an existing entry.

```
switch(config-directflow) #flow Test-1
switch(config-directflow-Test-1) #
```

Create the DirectFlow Match Criteria

The `match (DirectFlow-flow mode)` command allows you to configure a rule or a flow which match on L2, L3, L4 fields of a packet and specify a certain action to either modify, drop or redirect the packet.

```
switch(config-directflow-Test-1) #match ethertype ip
switch(config-directflow-Test-1) #match source ip 10.10.10.10
```

Action Set

The `action set (DirectFlow-flow mode)` command allows you to configure a packet to be routed out a layer three interface using a DirectFlow entry.

```
switch(config-directflow-Test-1) #action egress mirror ethernet 7
switch(config-directflow-Test-1) #action set destination mac 0000.aaaa.bbb
b
```

Finalize the Flow

DirectFlow flows do not take effect until you exit the configuration sub-mode for the specified flow. Use the `exit` command to finalize the flow and put it into effect.

```
switch(config-directflow-Test-1) #exit
switch(config-directflow) #
```

Redirect to CPU

The `action output interface cpu (DirectFlow-flow mode)` command allows you to configure flows so that traffic that matches the matching conditions specified in the flow is redirected to the CPU.

```
switch(config) #directflow
switch(config-directflow) #flow redirect-http-cpu
switch(config-directflow-redirect-http-cpu) #match ip protocol tcp
switch(config-directflow-redirect-http-cpu) #match destination port 80
switch(config-directflow-redirect-http-cpu) #action output interface cpu
```

Configuring a Non-persistent Flow

DirectFlow flows are persistent by default. Use the `no persistent` command to configure non-persistent flows.

```
switch (config) #directflow
switch (config-directflow) #flow example-non-persistent
switch (config-directflow-example-non-persistent) #match input interface
    ethernet
    25
switch (config-directflow-example-non-persistent) #action drop
switch (config-directflow-example-non-persistent) #no persistent
switch (config-directflow-example-non-persistent) #timeout hard 300
```

Display details for configured flows

The `detail` option of the `show directflow flows` command enables you to display the details of configured flows. You can use this command to verify that a non-persistent flow is deleted after the timeout period configured for the flow has elapsed.

The following example shows the use of this command to view the configuration of a non-persistent flow before the timeout period has elapsed, and a second time, after the timeout period has expired.

The initial use of the command displays the flow configuration (before the timeout expires).

```
switch (config-directflow) #show directflow flows example-non-persistent
    detail
Flow example-non-persistent: (Flow programmed)
  persistent: False
  priority: 0
  hard timeout: 300
  idle timeout: 0
  match:
    ingress interface:
      Et25
  actions:
    drop
  matched: 0 packets, 0 bytes
```

The second use of the command displays the flow details (after the timeout expires). The output shows that the flow is no longer programmed.

```
switch (config-directflow) #show directflow flows example-non-persistent
    detail
Flow example-non-persistent: (Flow not programmed)
  persistent: False
  priority: 0
  hard timeout: 300
  idle timeout: 0
  match:
    ingress interface:
      Et25
  actions:
    drop
  matched: 0 packets, 0 bytes
```

12.7.3 DirectFlow Feature Interactions

DirectFlow flow entries can have one of the following actions:

- A set of egress ports for sending a matched packet

- Copy to CPU
- Redirect to CPU
- Drop
- No specified action (in this case, the traffic is output normally).

The only exception is the ingress or egress mirroring action, where the DirectFlow entry causes the packet to be mirrored.

When the ingress or egress packets are mirrored, the original traffic is sent out normally.

Bridging Features

- DirectFlow entries have precedence over all entries in the MAC table, including static MAC entries and static MAC drop entries. Packets that do not match DirectFlow entries are forwarded based on the MAC address table.
- VLANs: DirectFlow entries can modify the VLAN of a packet. MAC learning takes place in the original VLAN for DirectFlow entries that modify the VLAN. The modified packet will be subject to VLAN membership checks on the egress port. If a packet has no VLAN tag, DirectFlow assumes it came in on the native VLAN for the ingress interface. A VLAN override causes the packet to obey the VLAN rules on the egress port.
- Q-in-Q: Q-in-Q is supported as DirectFlow entries match only on the outer tag.
- Counters: All packets that match DirectFlow entries cause interface counters to increment as usual.

Spanning Tree

DirectFlow runs alongside MSTP, RSTP, and PVST. DirectFlow entries do not match on packets that ingress an STP discarding port. DirectFlow entries that cause a packet to be forwarded out an STP discarding port will result in the packets being dropped on egress.

When STP is enabled, BPDUs will always be trapped to the CPU. When STP is disabled, BPDUs will be subject to DirectFlow entries and not be copied to the CPU by default.

LLDP, LAGs, and LACP

- LLDP packets are always trapped to the CPU. DirectFlow entries can never match LLDP packets.
- LAGs are fully supported, and can be part of a match criteria and part of an output action to an interface.
- LACP packets are always trapped to CPU. DirectFlow entries can never match LACP packets.

sFlow

sFlow is unaffected by DirectFlow.

IGMP Snooping

IGMP control packets are trapped to the CPU when IGMP Snooping is enabled. DirectFlow entries can match IGMP Snooping control traffic and override the trap to CPU.

Link-local-multicast packets are flooded in hardware in the VLAN via a TCAM entry. DirectFlow entries can match link-local-multicast packets and change the flooding behavior. As DirectFlow entries have to specify output interfaces or drop, the action will conflict and so matching DirectFlow entries will get precedence.

When IGMP snooping is enabled, unknown IPV4 multicast packets are flooded to the multicast-router ports in the VLAN. If DirectFlow entries match unknown IPV4 multicast packets, they will override the flooding behavior.

Data packets in groups under IGMP snooping control are sent to the group members through a MAC table entry. Matching DirectFlow entries override the MAC table entries.

ACLs

DirectFlow entries are lower priority than any configured Port ACLs (ingress). Packets coming in on a port that match DirectFlow entries obey any configured ACL on that port, and will only apply to packets that have a **permit** action.

DirectFlow entries are higher priority than any configured RACLs. Packets coming in on an L3 interface that match DirectFlow entries ignore any RACLs configured on that interface.

DirectFlow entries are lower priority than any configured Egress ACLs.

12.7.3.1 Layer Three Features and DirectFlow

DirectFlow runs alongside IP routing. If a packet is routed out a layer three interface using a DirectFlow entry, the actions associated with the entry will have to specify the new source MAC and destination MAC for the packet, as well as the physical port or LAG. If there are no output ports specified in an entry, packets that match that entry will be dropped.

Unicast Routing

When unicast routing is enabled, DirectFlow entries that match take precedence for all packets that would have been otherwise been routed. The three exceptions are the ingress mirror, egress mirror and copy-to-CPU actions where the packets will be routed normally in addition to the action being performed. Routed packets that do not match DirectFlow entries are forwarding based on the L3 lookup.

Multicast Routing

When multicast routing is enabled, DirectFlow entries that match take precedence for all packets that would have otherwise been multicast routed. The packets are not replicated based on the hardware multicast tables, but are forwarded strictly according to the actions specified by the DirectFlow entry. The entry can specify a set of output interfaces, which will result in the packet being replicated based on the DirectFlow entry.

12.7.3.2 Displaying DirectFlow Configurations

To [show directflow flows](#) command displays the contents of the flow table, showing each entry with its match rules, actions, and packet counters.

- This example shows the status of a default (persistent) flow.

```
switch(config-directflow)#show directflow flows
Flow Test1:
priority: 0
match:
  ingress interface: Ethernet1
    ethertype ip
  source ip address: 10.10.10.10
actions:
  output mirror: Ethernet2
matched: 0 packets, 0 bytes
switch(config-directflow)#
```

- This example shows the status of a non-persistent flow. The flow will be deleted once 5 minutes have elapsed.

```
switch(config-directflow)#show directflow flows example-non-persistent
Flow example-non-persistent:
  persistent: False
  priority: 0
  hard timeout: 300
```



```
idle timeout: 0
match:
  ingress interface:
    Et25
actions:
  drop
matched: 0 packets, 0 bytes
```

12.7.4 DirectFlow Commands

DirectFlow Global Configuration Mode

- [directflow](#)

DirectFlow Configuration Command

- [action drop \(DirectFlow-flow mode\)](#)
- [action mirror \(DirectFlow-flow mode\)](#)
- [action output \(DirectFlow-flow mode\)](#)
- [action output interface cpu \(DirectFlow-flow mode\)](#)
- [action set \(DirectFlow-flow mode\)](#)
- [flow \(DirectFlow\)](#)
- [match \(DirectFlow-flow mode\)](#)
- [persistent](#)
- [priority \(DirectFlow-flow mode\)](#)
- [shutdown \(DirectFlow\)](#)
- [timeout \(DirectFlow-flow mode\)](#)

DirectFlow and Clear Commands

- [show directflow](#)
- [show directflow flows](#)

12.7.4.1 action drop (DirectFlow-flow mode)

The **action drop** command configures packets that match an entry to be dropped.

The **no action drop** and **default action drop** commands remove the statement from the DirectFlow **configuration mode**.

Command Mode

Directflow-flow Configuration

Command Syntax

```
action drop
```

```
no action drop
```

```
default action drop
```

Example

- This command sets the action for packets from Test-1 to be dropped.

```
switch(config-directflow-Test-1)#action drop  
switch#
```

12.7.4.2 action mirror (DirectFlow-flow mode)

The **action mirror** command can be used to ingress or egress mirror traffic to a mirror destination. This requires a mirror destination to be setup on the switch. If a packet comes in or goes out an interface that is part of another mirror session, then the destination for that destination as well as the DirectFlow destination will receive a copy of the packet.

The **no action mirror** and **default action mirror** commands remove the statement from DirectFlow **configuration mode**.

Command Mode

Directflow-flow Configuration

Command Syntax

```
action DIRECTION mirror INT_NAME
no action DIRECTION mirror INT_NAME
default action DIRECTION mirror INT_NAME
```

Parameters

- **DIRECTION** transmission direction of traffic to be mirrored.
 - **ingress** mirrors before any rewrites.
 - **egress** mirrors after rewrites.
- **INT_NAME** Source interface for the mirroring session.
 - **ethernet** *e_range* Ethernet interfaces specified by *e_range*.
 - **port-channel** *p_range* Port channel interfaces specified by *p_range*.

Example

- This command configures mirror traffic to Ethernet 2.

```
switch(config-directflow)# flow Test1
switch(config-directflow-Test1)#match ethertype ip
switch(config-directflow-Test1)#match source ip 10.10.10.10
switch(config-directflow-Test1)#action egress mirror ethernet
2
switch(config-directflow-Test1)#
```

12.7.4.3 action output (DirectFlow-flow mode)

The **action output** command configures an Ethernet or port channel interface as the output of a specified port mirroring session.

The **no action output** and **default action output** commands remove the statement from DirectFlow **configuration mode**.

Command Mode

Directflow-flow Configuration

Command Syntax

```
action output DESTINATION
```

```
no action output DESTINATION
```

```
default action output DESTINATION
```

Parameters

- **DESTINATION** transmission direction of traffic to be mirrored.
 - **all** mirrors transmitted and received traffic.
 - **flood** mirrors received traffic only.
 - **interface ethernet** *e_range* Ethernet interfaces specified by *e_range*.
 - **interface port-channel** *p_range* Port channel interfaces specified by *p_range*.
 - **nexthop vrf** *vrf_name ip_addr*. If the next hop is reachable in the default VRF, the default VRF does not need to be specified.

Example

- This command configures Ethernet interface 7 as the output for the mirroring session.

```
switch(config-directflow-Test1)#action output
interface ethernet 7
switch(config-directflow-Test1)#
```

- The following commands configure a flow redirecting all traffic from 10.10.1.2 to 10.30.1.2 next hop assuming an appropriately configured TCAM profile.

```
switch(config-directflow)#flow flow-sip-10_10_1_2-redirect-
to-10_30_1_2
switch(config-directflow-Test1)#match ethertype ip
switch(config-directflow-Test1)#match source ip 10.10.1.2
switch(config-directflow-Test1)#action output nexthop
10.30.1.2
switch(config-directflow-Test1)#
```

12.7.4.4 action output interface cpu (DirectFlow-flow mode)

The **action output interface cpu** command configures the action (other commands are used to define the traffic matching conditions).

The **no action output interface cpu** and **default action output** commands remove the statement from DirectFlow configuration mode.

Command Mode

Directflow-flow Configuration

Command Syntax

```
action output DESTINATION
```

```
no action output DESTINATION
```

```
default action output DESTINATION
```

Parameters

- **DESTINATION** transmission direction of traffic to be mirrored.
 - **all** mirrors transmitted and received traffic.
 - **flood** mirrors received traffic only.
 - **interface cpu** Ethernet interfaces specified by *e_range*.

Example

- This command configures Ethernet interface 7 as the output for the mirroring session.

```
switch(config-directflow-Test1)#action output  
interface ethernet 7  
switch(config-directflow-Test1)#
```

- These commands configure the action to redirect traffic matching the flow to the CPU and the matching conditions for the flow.

```
switch (config)#directflow  
switch (config-directflow)#flow redirect-http-cpu  
switch (config-directflow-redirect-http-cpu)#match ip protocol  
tcp  
switch (config-directflow-redirect-http-cpu)#match destination  
port 80  
switch (config-directflow-redirect-http-cpu)#action output  
interface cpu
```

12.7.4.5 action set (DirectFlow-flow mode)

The **action set** command allows you to configure a packet to be routed out a layer three interface using a DirectFlow entry. The actions associated with the entry will have to specify the new source MAC and destination MAC for the packet, as well as the physical port or LAG. If there are no output ports specified in an entry, packets that match that entry will be dropped.

The **no action set** and **default action set** commands remove **action set** statement from DirectFlow **configuration mode**.

Command Mode

Directflow-flow Configuration

Command Syntax

```
action set CONDITION
```

```
no action set CONDITION
```

```
default action set CONDITION
```

Parameters

- **CONDITION** specifies parameter and value. Options include:
 - **cos** <0 to 7> cost of service.
 - **destination mac** *mac_addr* Dotted hex notation.
 - **ip tos** <0 to 255> Type of service.
 - **source mac** *mac_addr* Dotted hex notation.
 - **traffic-class** <0 to 7> Dotted hex notation.
 - **vlan** <0 to 4094> Number of VLAN.

The **no action set** and **default action set** commands require only the **CONDITION** type without a specific condition value.

Example

- These commands change the destination MAC of the frame.

```
switch(config-directflow)#flow Test1
switch(config-directflow-Test1)#action egress mirror ethernet
7
switch(config-directflow-Test1)#action set destination mac
0000.aaaa.bbbb
```

12.7.4.6 directflow

The **directflow** command places the switch in DirectFlow configuration mode.

The **no directflow** and **default directflow** commands delete the DirectFlow configuration mode statements from running-config.

DirectFlow configuration mode is not a group change mode; **running-config** is changed immediately upon entering commands. Exiting OpenFlow configuration mode does not affect **running-config**. The **exit** command returns the switch to global configuration mode.

Command Mode

Global Configuration

Command Syntax

```
directflow
```

```
no directflow
```

```
default directflow
```

Commands Available in DirectFlow-Flow configuration mode:

- [flow \(DirectFlow\)](#)
- [shutdown \(DirectFlow\)](#)

Example

- This command places the switch in DirectFlow configuration mode:

```
switch(config)#directflow  
switch(config-directflow)#
```

- This command returns the switch to global management mode:

```
switch(config-directflow)#exit  
switch(config)#
```

12.7.4.7 flow (DirectFlow)

The **flow** command places the switch in flow configuration mode.

The **flow** command specifies the name of the flow that subsequent commands modify and creates a newflow definition if it references a nonexistent flow. All changes in a flow configuration mode edit session are pending until the session ends:

- The **exit** command saves pending changes to **running-config** and returns the switch to DirectFlow configuration mode. Changes are also saved by entering a different configuration mode.
- The **abort** command discards pending changes, returning the switch to DirectFlow configuration mode.

The **no flow** and **default flow** commands delete the specified role by removing the role and its statements from **running-config**.

Command Mode

DirectFlow Configuration

Command Syntax

```
flow flow_name
```

```
no flow flow_name
```

```
default flow flow_name
```

Parameters

- **flow_name** Name of flow.

Commands Available in DirectFlow-Flow configuration mode:

- [action drop \(DirectFlow-flow mode\)](#)
- [action mirror \(DirectFlow-flow mode\)](#)
- [action output \(DirectFlow-flow mode\)](#)
- [action set \(DirectFlow-flow mode\)](#)
- [match \(DirectFlow-flow mode\)](#)

12.7.4.8 match (DirectFlow-flow mode)

The **match** command allows you to configure a rule or a flow which could match on L2, L3, L4 fields of a packet and specify a certain action to modify, drop or redirect the packet.

All traffic ingressing on the switch will be matched against the flows installed. In cases where none of the packets match, normal switching or routing behavior will take over. When multiple entries match a packet, precedence is given to the entry that was installed first.

The **no match** and **default match** commands remove the **match** statement from the configuration mode.

Command Mode

Directflow-flow Configuration

Command Syntax

```
match CONDITION
```

```
no match CONDITION
```

```
default match CONDITION
```

Parameters

- **CONDITION** specifies criteria for evaluating a route. Options include:
 - **cos** <0 to 7> cost of service.
 - **destination ip** *ipv4_sub* destination IPv4 subnet. L3 fields valid only if ethertype is IP (0x0800).
 - **destination mac** *mac_addr* Add to the existing community. Dotted hex notation.
 - **destination mac** *mac_addr mask mac_mask* Add to the sting community. Dotted hex notation.
 - **destination port** *0 to 65535* Fields accepted only if protocol is TCP| UDP
 - **ethertype** *0 to 65535* Layer 4 destination port.
 - **ethertype ARP** Layer 4 destination port.
 - **ethertype IP** Layer 4 destination port.
 - **icmp code** *0 to 255* Fields accepted only if protocol is ICMP
 - **icmp type** <0 to 255> Fields accepted only if protocol is ICMP
 - **input interface ethernet** *e_num* Ethernet interface specified by *e_num*.
 - **input interface port-channel** *p_num* Port channel interface specified by *p_num*.
 - **ip protocol** *0 to 255* Type of service.
 - **ip protocol icmp** L3 fields valid only if ethertype is IP (0x0800).
 - **ip protocol tcp** L3 fields valid only if ethertype is IP (0x0800).
 - **ip protocol udp** L3 fields valid only if ethertype is IP (0x0800).
 - **ip tos** <0 to 255> L3 fields valid only if ethertype is IP (0x0800).
 - **source ip** *ipv4_subnet* L3 fields valid only if ethertype is IP (0x0800).
 - **source mac** *mac_addr* Add to the existing community. Dotted hex notation.
 - **source mac** *mac_addr mask mac_mask* Add to the sting community. Dotted hex notation.
 - **source port** *0 to 65535* Fields accepted only if protocol is TCP| UDP
 - **tcp flag ack** Layer 4 destination port.
 - **tcp flag fin** Layer 4 destination port.
 - **tcp flag psh** Layer 4 destination port.
 - **tcp flag rst** Layer 4 destination port.
 - **tcp flag syn** Layer 4 destination port.
 - **tcp flag urg** Layer 4 destination port.
 - **tcp flag urg** Layer 4 destination port
 - **vlan** < 1 to 4094 > **mask** < 1 to 4095 > Number of VLAN.

The **no match** and **default match** commands require only the **CONDITION** type without a specific condition value.

Example

- This command creates the rules to match on Ethertype IP and Source IP 10.10.10.10.

```
switch(config-directflow)# flow Test1
switch(config-directflow-Test1)#persistent
switch(config-directflow-Test1)#match ethertype ip
switch(config-directflow-Test1)#match source ip 10.10.10.10
```

12.7.4.9 persistent

DirectFlow flows are persistent by default. Once finalized, they appear in the running configuration, and if saved to **startup config** they will persist over a reboot. The **no** form of the **persistent** command prevents the flow from showing up in **running config**, ensuring that it will not persist over a reboot.

Command Mode

Directflow-flow Configuration

Command Syntax

```
no persistent
```

Example

- These commands create and enable a non-persistent DirectFlow flow.

```
switch(config)#directflow
switch(config-directflow)#flow example-non-persistent
switch(config-directflow-example-non-persistent)#match input
interface ethernet
25
switch(config-directflow-example-non-persistent)#action drop
switch(config-directflow-example-non-persistent)#no
persistent
switch(config-directflow-example-non-persistent)#timeout hard
300
switch(config-directflow-example-non-persistent)#exit
switch(config-directflow)#
```

12.7.4.10 priority (DirectFlow-flow mode)

The **priority** command sets the priority for the flow match rules. Each flow-table entry has an optional priority field, with a higher number indicating a higher priority. Flows with the same priority may be loaded in any order, and the order may be changed at any time. If multiple entries match a packet, precedence is given to the entry that was installed first.

Priority numbers range from 0 to 65535. The default is 0. The higher priority rules match first.

The **no priority** and **default priority** commands remove **priority** statement from the DirectFlow **configuration mode**.

Command Mode

Directflow-flow Configuration

Command Syntax

```
priority priority_value
```

```
no priority
```

```
default priority
```

Parameters

- **priority_value** priority xxx. Value ranges from 0 to 65535. Default is 0.

Example

- These commands assign the priority of 150 to flow Test-1.

```
switch(config-directflow-Test-1) #priority 150  
switch(config-directflow-Test-1) #
```

12.7.4.11 show directflow flows

The **show directflow flows** command displays the contents of the flow table, showing each entry with its match rules, actions, and packet counters. Including the name of a specific flow limits the output to information about the specified flow.

Command Mode

EXEC

Command Syntax

```
show directflow flows [flow_name [counters|detail]]
```

Parameters

- **flow_name** name of flow for which to display information. If no flow name is entered, command displays information for all flows.
- **counters** displays DirectFlow counters for the specified flow.
- **detail** displays detailed information for the specified flow.

Examples:

- This command displays the contents of the flow table.

```
switch# show directflow flows
Flow test3:
  persistent: True
  priority: 0
  priorityGroupType: default
  tableType: ifp
  hard timeout: 0
  idle timeout: 0
  match:
    Ethernet type: 0x86dd
    source IPv6 address: fcaa::ffff:ffff:ffff:ffff
:ffff:ffff:ffff:ffff
  actions:
    output interfaces:
      Et32
    source: config
  matched: 0 packets, 0 bytes
Flow test2:
  persistent: True
  priority: 0
  priorityGroupType: default
  tableType: ifp
  hard timeout: 0
  idle timeout: 0
  match:
    Ethernet type: IPv4
    source IPv4 address: 10.1.2.12/255.255.255.255
    IPv4 protocol: TCP
    destination TCP/UDP port or ICMP type: 8080
  actions:
    output interfaces:
      Et3/1
    source: config
  matched: 0 packets, 0 bytes
Flow test1:
  persistent: True
  priority: 0
  priorityGroupType: default
  tableType: ifp
```

```

hard timeout: 0
idle timeout: 0
match:
  ingress interface:
    Et1/1
actions:
  output interfaces:
    Et2/1
source: config
matched: 0 packets, 0 bytes
switch>

```

- This command displays information about flow test-1.

```

switch# show directflow flows test-1
Flow test1:
  persistent: True
  priority: 0
  priorityGroupType: default
  tableType: ifp
  hard timeout: 0
  idle timeout: 0
  match:
    ingress interface:
      Et1/1
  actions:
    output interfaces:
      Et2/1
  source: config
  matched: 0 packets, 0 bytes
switch>

```

- This command displays detailed information for flow test-1.

```

switch# show directflow flows test-1 detail
switch>show directflow flows test1 detail
Flow test1: (Flow programmed)
  persistent: True
  priority: 0
  priorityGroupType: default
  tableType: ifp
  hard timeout: 0
  idle timeout: 0
  match:
    ingress interface:
      Et1/1
  actions:
    output interfaces:
      Et2/1
  source: config
  matched: 0 packets, 0 bytes
switch>

```

- This command displays counters for flow test-1.

```

switch# show directflow flows test-1 counters
Flow Name      Source      Matched packets  Matched bytes
-----
test1          config      0                 0
switch>

```

12.7.4.12 show directflow

The **show directflow** command displays summary information for DirectFlow. With the **counters** or **details** options, it displays counters or details for all flows configured on the switch.

Command Mode

EXEC

Command Syntax

```
show directflow [counters|details]
```

Example

- This command displays summary information for DirectFlow.

```
switch# show directflow
DirectFlow configuration: Enabled
Total matched: 0 packets
Total programmed flows: 3 flows
switch#
```

- This command displays counters for all DirectFlow flows configured on the switch.

```
switch# show directflow counters
Flow Name          Source          Matched packets
-----          -
test3              config          0
                  0
test2              config          0
                  0
test1              config          0
                  0

Total matched packets: 0
switch>
```

- This command displays details for all DirectFlow flows configured on the switch.

```
switch# show directflow detail
Flow test3: (Flow programmed)
persistent: True
priority: 0
priorityGroupType: default
tableType: ifp
hard timeout: 0
idle timeout: 0
match:
  Ethernet type: 0x86dd
  source IPv6 address: fcaa::/ffff:ffff:ffff:ffff
:ffff:ffff:ffff:ffff
actions:
  output interfaces:
    Et32
  source: config
  matched: 0 packets, 0 bytes
Flow test2: (Flow programmed)
persistent: True
priority: 0
priorityGroupType: default
tableType: ifp
```



```
hard timeout: 0
idle timeout: 0
match:
  Ethernet type: IPv4
  source IPv4 address: 10.1.2.12/255.255.255.255
  IPv4 protocol: TCP
  destination TCP/UDP port or ICMP type: 8080
actions:
  output interfaces:
    Et3/1
  source: config
  matched: 0 packets, 0 bytes
Flow test1: (Flow programmed)
persistent: True
priority: 0
priorityGroupType: default
tableType: ifp
hard timeout: 0
idle timeout: 0
match:
  ingress interface:
    Et1/1
actions:
  output interfaces:
    Et2/1
  source: config
  matched: 0 packets, 0 bytes
Flows: 3 programmed, 0 rejected
switch#
```

12.7.4.13 shutdown (DirectFlow)

The **shutdown** command, in DirectFlow mode, disables DirectFlow on the switch. DirectFlow is disabled by default.

The **no shutdown** command re-enables DirectFlow.

Command Mode

Directflow Configuration

Command Syntax

```
shutdown
```

```
no shutdown
```

```
default shutdown
```

Example

- These commands enable DirectFlow on the switch.

```
switch(config)#directflow  
switch(config-directflow)#no shutdown  
switch(config-directflow)#
```

- This command disables DirectFlow Flow.

```
switch(config-directflow-Test1)#shutdown
```

12.7.4.14 timeout (DirectFlow-flow mode)

The **timeout** command, in DirectFlow mode, configures the connection timeout period for connection sessions. The connection timeout period defines the interval between a user's most recently entered command and an automatic connection shutdown. Automatic connection timeout is disabled by setting the idle-timeout to zero, which is the default setting.

Command Mode

Directflow-flow Configuration

Command Syntax

```
no priority
no timeout hard
no timeout idle
```

Parameters

- **idle** session idle timeout length.
 - 0 Automatic connection timeout is disabled
 - <1-4294967295> Automatic timeout period (seconds).
- **hard** session hard timeout length.
 - 0 Automatic connection timeout is disabled.
 - <1-4294967295> Automatic timeout period (seconds).

Example

- These commands enable a hard timeout period of 5 seconds on the switch.

```
switch(config)#directflow
switch(config-directflow-Test1)#timeout hard 5
switch(config-directflow-Test1)#
```

- These commands enable DirectFlow on the switch.

```
switch(config)#directflow
switch(config-directflow-Test1)#no timeout hard
switch(config-directflow-Test1)#
```

12.8 Decap Groups

These sections describe the Decap groups:

- [Decap Groups Description](#)
 - [Decap Groups Configuration](#)
 - [Decap Commands](#)

12.8.1 Decap Groups Description

The decap group is a data structure that receives encapsulated packets and extracts the payload. The switch then processes or forwards the extracted payload as required. Although packets cannot be transmitted through decap groups, nexthop groups can be used to create a packet's reverse path. Decap groups support payload extraction of packets received from Generic Routing Encapsulation (GRE) and IP-in-IP tunnels.

Decap groups have these limitations:

- Tunnels are terminated using destination IP address; source IP address has no influence.
- Packets matching a decap group are not processed through their ingress interface and VLAN.
- During a tunnel termination, ingress ACL filter each decap group packet's inner header.
- Packet counters are not available.
- VRF is not supported.

Decap groups are defined by their tunnel type and decap IP address:

- **Tunnel type** specifies the tunnel protocol that the switch uses to extract payload.
- **Decap IP address** specifies the IP address where the switch receives decap group packets.

Decap groups support Generic Routing Encapsulation (GRE) and IP-in-IP tunnels.

12.8.1.1 Decap Groups Configuration

Decap groups are configured in decap-group configuration mode. The decap-group configuration mode is not a group change mode; the running-config is changed immediately upon entering commands. However, when exiting, the decap-group configuration mode does not affect running-config. The `exit` command returns the switch to global configuration mode.

- The static CLI entry for the incoming label is specified by the `mpls static` command.
- The tunnel type is specified by the `tunnel type (Decap Group)` command.
- The Decap IP address is specified by the `tunnel decap-ip (Decap Group)` command.
- The locally configured IP addresses are added to the Layer 3 interfaces using the `tunnel decap-interface (Decap Group)` command for a specified decap group.

Decap groups do not define a default destination address or tunnel type and is not functional until both parameters are configured. A decap group can contain multiple tunnel decap-ip statements.

Example:

- This command defines a static CLI entry for the incoming-label.

```
switch(config)#mpls static top-label 3400 ethernet 3/3/3
10.14.4.4 pop payload-type ipv4
```

- This command creates a decap group named DC-1 and configures the group to terminate packets from GRE tunnel packets with the destination IP address of 10.14.3.2

```
switch(config)#ip decap-group DC-1
switch(config-dg-DC-1)#tunnel type gre
switch(config-dg-DC-1)#tunnel decap-ip 10.14.3.2
switch(config-dg-DC-1)#show active
ip decap-group DC-1
    tunnel type gre
    tunnel decap-ip 10.14.3.2
switch(config-dg-DC-1)#end
switch(config)#
```

12.8.1.2 Decap Commands

Decap Configuration Commands

- `ip decap-group`
- `tunnel decap-interface (Decap Group)`
- `tunnel decap-ip (Decap Group)tunnel type (Decap Group)`

Decap Show Command

- `show ip decap-group`

12.8.1.2.1 ip decap-group

The **ip decap-group** command places the switch in decap-group configuration mode, through which decap groups are created or modified. A decap group is a data structure that defines a method of extracting the payload from an encapsulated packet that the switch receives on a specified IP address.

Decap groups do not specify a default IP address group or tunnel type. These parameters must be explicitly configured before a decap group can function.

Decap-group configuration mode is not a group change mode; the running-config is changed immediately upon entering commands. Exiting the decap-group configuration mode does not affect running-config. The **exit** command returns the switch to global configuration mode.

The **no ip decap-group** and **default ip decap-group** commands delete previously configured commands in the specified **decap-group** mode.

Command Mode

Global Configuration

Command Syntax

```
ip decap-group group_name
no ip decap-group group_name
default ip decap-group group_name
```

Parameters

- *group_name* Decap group name.

Commands Available in Decap-group Configuration Mode

- [tunnel decap-ip \(Decap Group\)](#) Specifies the IP address of packets handled by the decap group.
- [tunnel type \(Decap Group\)](#) Specifies the tunnel protocol for extracting payload.
- [show ip decap-group](#)

Examples:

- This command creates a decap group named DC-1.

```
switch(config)#ip decap-group DC-1
switch(config-dg-DC-1)#
```

- This command exits decap-group mode for the DC-1 decap group.

```
switch(config-dg-DC-1)#exit
switch(config)#
```

- This command delete the decap group named DC-1.

```
switch(config)#no ip decap-group DC-1
switch(config)#
```

12.8.1.2.2 show ip decap-group

The `show ip decap-group` command displays the IP decap groups that are available in the switch.

Command Mode

Global Configuration

Command Syntax

`show ip decap-group [decap-group name | dynamic] Parameters`

- **decap-group name** The decap group name.
- **dynamic** Displays the dynamic entries only.

Related Commands

- [show ip decap-group](#)
- [tunnel decap-ip \(Decap Group\)](#)
- [tunnel type \(Decap Group\)](#)

Example:

This command displays the IP decap groups that are available in a switch.

```
switch(config)#show ip decap-group
NOTE: "D" column indicates dynamic entries
D | Name | Type | Info | Version | Addr Type
--|-----|-----|-----|-----|-----
* | d1 | GRE | 1.2.3.4 | | |
* | d2 | IP-in-IP | Ethernet12/3 | IPv4 | primary
| gre-with-intf | GRE | | | | |
| ipip-with-decapall | IP-in-IP | all | IPv4 | all
| ipip-with-decapall | IP-in-IP | all | IPv6 | all
| ipip-with-intf | IP-in-IP | Ethernet11/3 | IPv6 | all
| ipip-with-intf | IP-in-IP | Ethernet11/3 | IPv4 | primary
* | ipip-with-ip | IP-in-IP | 1001::1 | IPv6 | |
* | ipip-with-ip | IP-in-IP | 1.1.1.1 | IPv4 | |
| p1 | GRE | 100.100.100.100 | | |
| p2 | UNKNOWN | | | |
```

12.8.1.2.3 tunnel decap-interface (Decap Group)

The **tunnel decap-interface** command adds all locally configured IP addresses to the specific Layer 3 interface per decap group.

The **no tunnel decap-interface** command and the **default tunnel decap-interface** command restores the default state by removing the locally added IP addresses from the decap group.

Command Mode

Decap-Group Configuration

Command Syntax

```
tunnel decap-interface { Ethernet | Loopback | Management | Port-Channel | Tunnel | Vlan | Vxlan | all }
```

```
no tunnel decap-interface { Ethernet | Loopback | Management | Port-Channel | Tunnel | Vlan | Vxlan | all }
```

```
default tunnel decap-interface
```

```
{ Ethernet | Loopback | Management | Port-Channel | Tunnel | Vlan | Vxlan | all }
```

Parameters

- **Ethernet *e_num*** Ethernet interface specified by *e_num*. The Ethernet port number ranges from **1** to **36**.
- **Loopback *l_num*** Loopback interface specified by *l_num*. The loopback interface number ranges from **0** to **1000**.
- **Management *m_num*** Management interface specified by *m_num*. The management port number ranges from **1** to **1**.
- **Port-channel *p_num*** Port-channel interface specified by *p_num*. Options include:
 - **Port-channel** interface number. The port-channel interface number ranges from **1** to **2000**.
 - **Port-channel** sub interface number. The port-channel sub interface number **<1-2000>**, **<1-4094>**.
- **tunnel *t_num*** Tunnel interface specified by *t_num*. The tunnel interface number ranges from **0** to **255**.
- **vlan *v_num*** VLAN interface specified by *v_num*. The VLAN interface number ranges from **1** to **4094**.
- **vxlan *vx_num*** VXLAN interface specified by *vx_num*. The VXLAN tunnel interface number ranges from **1** to **1**.
- **all *address-family*** This parameter configures all L3 interfaces as a decap interface.

Related Commands

- [ip decap-group](#)
- [tunnel type \(Decap Group\)](#)
- [show ip decap-group](#)

Example:

These commands add locally configured IP addresses to the Ethernet interface *1/1* for the *dg1* decap group.

```
switch(config)#ip decap-group dg1
switch(config-dg-dg1)#tunnel decap-interface Ethernet1/1

switch(config-dg-dg1)#show active
ip decap-group dg1
tunnel type ipip
```



```
tunnel decap-interface Ethernet1/1  
tunnel decap-interface all address-family ipv6 address all
```

12.8.1.2.4 tunnel decap-ip (Decap Group)

The **tunnel decap-ip** command specifies the IP address of packets that are handled by the configuration mode decap group. A decap group is a data structure that defines a method of extracting the payload from an encapsulated packet that the switch receives on a specified IP address.

Decap groups do not define a default decap-ip address. A decap group is not functional until an IP address is specified. Decap groups can contain only one tunnel decap-ip statement; subsequent commands replace any previously configured statements.

Command Mode

Decap-Group Configuration

Command Syntax

```
tunnel decap-ip ipv4_address
```

Parameters

- *ipv4_addr* An IPv4 address.

Related Commands

- [ip decap-group](#) places the switch in decap-group configuration mode.
- [tunnel type \(Decap Group\)](#) specifies the tunnel protocol for extracting payload.
- [show ip decap-group](#)

Guidelines

A decap group does not specify a default IP address group or tunnel type. These parameters must be explicitly configured before a decap group can function.

Example:

These commands configure *10.14.3.2* as the decap-IP address for the *DC-1* decap group.

```
switch(config)#ip decap-group DC-1
switch(config-dg-DC-1)#tunnel decap-ip 10.14.3.2
switch(config-dg-DC-1)#show active
ip decap-group DC-1
    tunnel decap-ip 10.14.3.2
switch(config-dg-DC-1)#
```

12.8.1.2.5 tunnel type (Decap Group)

The **tunnel type** command specifies the tunnel protocol for extracting payload from encapsulated packets that arrive on the IP address specified for the configuration mode decap group. Supported tunnel protocols include GRE (General Routing Encapsulation) and IP-in-IP.

Decap groups do not define a default tunnel type. A decap group is not functional until an IP address is specified. Decap groups can contain only one tunnel decap-ip statement; subsequent commands replace any previously configured statements.

Command Mode

Decap-group Configuration

Command Syntax

```
tunnel type gre
```

Related Commands

- [ip decap-group](#) places the switch in decap-group configuration mode.
- [tunnel decap-ip \(Decap Group\)](#) specifies the IP address of packets handled by the decap group.
- [show ip decap-group](#)

Guidelines

A decap group does not specify a default IP address group or tunnel type. These parameters must be explicitly configured before a decap group can function.

Example:

This command configures decap group DC-1 to terminate packets from GRE tunnel packets.

```
switch(config)#ip decap-group DC-1
switch(config-dg-DC-1)#tunnel type gre
switch(config-dg-DC-1)#show active
ip decap-group DC-1
    tunnel type gre
switch(config-dg-DC-1)#
```

12.9 Nexthop Groups

These sections describe the Nexthop groups:

- [Nexthop Group Description](#)
- [Nexthop Group Configuration](#)
- [Nexthop Group Commands](#)

12.9.1 Nexthop Group Description

Each routing table entry provides the next hop address to its specified destination. A nexthop address is the address of the next device on the path to the entry's specified destination.

A nexthop group is a data structure that defines a list of nexthop addresses and a tunnel type for packets routed to the specified address. When an IP route statement specifies a nexthop group as the nexthop address, the switch configures a static route with a nexthop group member as the nexthop address and encapsulates packets forwarded to that address as required by the group's tunnel type.

The nexthop group size is a configurable parameter that specifies the number of entries that the group contains. Group entries that are not explicitly configured are filled with drop routes. The switch uses ECMP hashing to select the address within the nexthop group when forwarding packets. When a packet's hash selects a drop route, the packet is dropped.

Nexthop groups are supported on Trident platform switches and subject to the following restrictions:

- Each switch can support 512 IPv4 or IPv6 Tunnels
- Nexthop groups can contain 256 nexthops.
- The switch supports 1024 nexthop groups.
- Multiple routes can share a tunnel.
- Tunnels do not support IP multicast packets.

Nexthop groups support IP-in-IP tunnels. The entry IP address family within a particular nexthop group cannot be mixed, i.e. either they are all IPv4 or they are all IPv6 entries.

12.9.2 Nexthop Group Configuration

Nexthop groups are configured and modified in `nexthop-group` configuration mode. After a group is created, it is associated to a static route through an `ip route nexthop-group` statement.

These tasks are required to configure a nexthop group and apply it to a static route.

- [Creating and Editing Nexthop Groups](#)
- [Configuring a Group's Encapsulation Parameters](#)
- [Configuring the Group's Size](#)
- [Creating Nexthop Group Entries](#)
- [Displaying Nexthop Groups](#)
- [Applying a Nexthop Group to a Static Route](#)

Creating and Editing Nexthop Groups

Nexthop groups are created by a `nexthop-group` command that specifies a group that isn't already configured. The switch enters `nexthop-group` configuration mode for the new group. `Nexthop-group` mode is also accessible for modifying existing groups. When in `nexthop-group` configuration mode, the `show active` command displays the group's configuration.

- This command creates a nexthop group named NH-1.

```
switch(config)#nexthop-group NH-1
switch(config-nexthop-group-NH-1)#
```

- These commands enter `nexthop-group` configuration mode for the group named NH3, then displays the previously configured group parameters.

```
switch(config)#nexthop-group NH3
switch(config-nexthop-group-NH3)#show active
nexthop-group NH3
  size 4
  ttl 10
  entry 0 tunnel-destination 10.14.21.3
  entry 1 tunnel-destination 10.14.21.5
  entry 2 tunnel-destination 10.14.22.5
  entry 3 tunnel-destination 10.14.22.6
switch(config-nexthop-group-NH3)#
```

Configuring a Group's Encapsulation Parameters

Packets in static routes that are associated with the nexthop group are encapsulated to support the group's tunnel type. Nexthop groups support IP-in-IP tunnels. The group also defines the source IP address and TTL field contents that are included in the packet encapsulation.

- This command configures the TTL setting to 32 for nexthop group NH-1 encapsulation packets.

```
switch(config)#nexthop-group NH-1
switch(config-nexthop-group-NH-1)#ttl 32
switch(config-nexthop-group-NH-1)#show active
  nexthop-group NH-1
    size 128
    ttl 32
switch(config-nexthop-group-NH-1)#
```

The address is inserted in the encapsulation source IP fields is specified by [tunnel-source \(Nexthop Group\)](#).

- These commands create loopback interface 100, assign an IP address to the interface, then specifies that address as the tunnel source for packets designated by nexthop-group NH-1.

```
switch(config)#interface loopback 100
switch(config-if-Lo100)#ip address 10.1.1.1/32
switch(config-if-Lo100)#exit
switch(config)#nexthop-group NH-1
switch(config-nexthop-group-NH-1)#tunnel-source intf loopback
  100
switch(config-nexthop-group-NH-1)#show active
  nexthop-group NH-1
    size 256
    ttl 32
    tunnel-source intf Loopback100
switch(config-nexthop-group-NH-1)#
```

Configuring IP-in-IP Encapsulation

Through IP-in-IP encapsulation, IP packets matching a static Nexthop-Group route are encapsulated within an IP-in-IP tunnel and forwarded.

- This command configures a static Nexthop-Group route and an IP-in-IP Nexthop-Group for IP-in-IP encapsulation.

```
switch(config)#ip route 124.0.0.1/32 nexthop-group abc
switch(config)#nexthop-group abc type ip-in-ip
switch(config-nexthop-group-abc)#size 512
switch(config-nexthop-group-abc)#tunnel-source 1.1.1.1
switch(config-nexthop-group-abc)#entry 0 tunnel-destination
  1.1.1.2
switch(config-nexthop-group-abc)#entry 1 tunnel-destination
  10.1.1.1
switch(config-nexthop-group-abc)#ttl 64
```

```
switch(config-nexthop-group-abc) #
```

Configuring the Group's Size

The group's size specifies the number of entries in the group. A group can contain up to 256 entries, which is the default size. The group's size is specified by [size \(Nexthop Group\)](#).

- This command configures the nexthop group NH-1 to contain 128 entries.

```
switch(config) #nexthop-group NH-1
switch(config-nexthop-group-NH-1) #size 128
switch(config-nexthop-group-NH-1) #show active
nexthop-group NH-1
  size 128
  ttl 64
switch(config-nexthop-group-NH-1) #
```

Creating Nexthop Group Entries

Each entry specifies a nexthop address that is used to forward packets. A nexthop group contains one entry statement for each nexthop address. The group's size specifies the number of entry statements the group may contain. Each entry statement is assigned an index number to distinguish it from other entries within the group; entry index numbers range from zero to the group size minus one.

Nexthop group entries are configured by [entry \(Nexthop Group\)](#).

- These commands set the nexthop group size at four entries, then create three entries. Packets that are hashed to the fourth entry are dropped.

```
switch(config) #nexthop-group NH-1
switch(config-nexthop-group-NH-1) #size 4
switch(config-nexthop-group-NH-1) #entry 0 tunnel-destination
  10.13.4.4
switch(config-nexthop-group-NH-1) #entry 1 tunnel-destination
  10.15.4.22
switch(config-nexthop-group-NH-1) #entry 2 tunnel-destination
  10.15.5.37
switch(config-nexthop-group-NH-1) #show active
nexthop-group NH-1
  size 4
  ttl 64
  entry 0 tunnel-destination 10.13.4.4
  entry 1 tunnel-destination 10.15.4.22
  entry 2 tunnel-destination 10.15.5.37
switch(config-nexthop-group-NH-1) #
```

- These commands configure a nexthop group with three IPv6 nexthop entries.

```
switch(config) #nexthop-group nhg-v6-mpls type ip
switch(config-nhg-v6-mpls) #size 3
switch(config-nhg-v6-mpls) #entry 0 nexthop 2002::6401:1
switch(config-nhg-v6-mpls) #entry 1 nexthop 2002::6404:1
switch(config-nhg-v6-mpls) #entry 2 nexthop 2002::6404:2
switch(config-nhg-v6-mpls) #
```

- These commands configure an IPv4 route to point to the nexthop group `nhg-v6-mpls`. (Both IPv4 routes and IPv6 routes can point to this nexthop group.)

```
switch#ip route 100.5.0.0/16 Nexthop-Group nhg-v6-mplsp
switch#
```

Displaying Nexthop Groups

The `show nexthop-group` command displays a group's configured parameters.

- This command displays the properties of the nexthop group named NH-1.

```
switch>show nexthop-group NH-1
Name           Id      type      size  ttl  sourceIp
NH-1           4      ipInIp    256   64   0.0.0.0
switch>
```

Applying a Nexthop Group to a Static Route

The `ip route nexthop-group` associates a nexthop group with a specified destination address and configures the encapsulation method for packets tunneled to that address.

This command creates a static route in the default VRF, using the nexthop group of NH-1 to determine the next hop address.

```
switch(config)#ip route 10.17.252.0/24 nexthop-group NH-1
switch(config)#
```

The `show ip route` command displays the routing table for a specified VRF. Routes that utilize a nexthop group entry are noted with a route type code of NG.

This command displays a routing table that contains a static route with its nexthop specified by a nexthop group.

```
switch>show ip route
Codes: C - connected, S - static, K - kernel,
       O - OSPF, IA - OSPF inter area, E1 - OSPF external type 1,
       E2 - OSPF external type 2, N1 - OSPF NSSA external type 1,
       N2 - OSPF NSSA external type2, B I - iBGP, B E - eBGP,
       R - RIP, I - ISIS, A B - BGP Aggregate, A O - OSPF
Summary,
       NG - Nexthop Group Static Route

Gateway of last resort is not set

C      10.3.3.1/32 is directly connected, Loopback0
C      10.9.1.0/24 is directly connected, Ethernet51/3
C      10.10.10.0/24 is directly connected, Ethernet51/1
S      10.20.0.0/16 [20/0] via 10.10.10.13, Ethernet51/1
C      10.10.11.0/24 is directly connected, Ethernet3
NG     10.10.3.0/24 [1/0] via ng-test1, 5
```

```
C 10.17.0.0/20 is directly connected, Management1
S 10.17.0.0/16 [1/0] via 10.17.0.1, Management1
S 10.18.0.0/16 [1/0] via 10.17.0.1, Management1
S 10.19.0.0/16 [1/0] via 10.17.0.1, Management1
S 10.20.0.0/16 [1/0] via 10.17.0.1, Management1
S 10.22.0.0/16 [1/0] via 10.17.0.1, Management1
```

```
switch>
```

12.9.3 Nexthop Group Commands

Nexthop Commands

- [entry \(Nexthop Group\)](#)
- [ip route nexthop-group](#)
- [nexthop-group](#)
- [size \(Nexthop Group\)](#)
- [ttl \(Nexthop Group\)](#)
- [tunnel-source \(Nexthop Group\)](#)

Nexthop Show Command

- [show nexthop-group](#)

12.9.3.1 entry (Nexthop Group)

The **entry** command defines a nexthop entry in the configuration mode nexthop group. Each nexthop entry specifies a nexthop IP address for static routes to which the nexthop group is assigned. The group size ([size \(Nexthop Group\)](#)) specifies the quantity of entries a group contains. Each entry is created by an individual command. Entries within a group are distinguished by an index number.

The **no entry** and **default entry** commands delete the specified nexthop group entry, as referenced by index number, by removing the corresponding **entry** statement from *running-config*.

Command Mode

Nexthop-group Configuration

Command Syntax

```
entry index tunnel-destination ipv4_address
```

```
no entry index
```

```
default entry index
```

Parameters

- **index** Entry index. Values range from **0** to **group-size - 1**.
- **ipv4_address** Nexthop IPv4 address.

group-size is the group's entry capacity, as specified by the [size \(Nexthop Group\)](#) command.

Example:

- These commands sets the nexthop group size at 4 entries, then creates three nexthop entries. Packets that are hashed to the fourth entry are dropped.

```
switch(config)#nexthop-group NH-1
switch(config-nexthop-group-NH-1)#size 4
switch(config-nexthop-group-NH-1)#entry 0 tunnel-destination
10.13.4.4
switch(config-nexthop-group-NH-1)#entry 1 tunnel-destination
10.15.4.22
switch(config-nexthop-group-NH-1)#entry 2 tunnel-destination
10.15.5.37
switch(config-nexthop-group-NH-1)#show active
nexthop-group NH-1
  size 4
  ttl 64
  entry 0 tunnel-destination 10.13.4.4
  entry 1 tunnel-destination 10.15.4.22
  entry 2 tunnel-destination 10.15.5.37
switch(config-nexthop-group-NH-1)#
```

12.9.3.2 ip route nexthop-group

The `ip route nexthop-group` command creates a static route. The destination is a network segment. The nexthop address is one of the IP addresses that comprise the specified nexthop group. Packets forwarded as a result of this command are encapsulated as specified by the tunnel-type parameter of the specified nexthop group.

When multiple routes exist to a destination prefix, the route with the lowest administrative distance takes precedence. When a route created through this command has the same administrative distance as another static route (ECMP), the route that was created earliest has preference; *running-config* stores static routes in the order that they are created.

By default, the administrative distance assigned to static routes is 1. Assigning a higher administrative distance to a static route configures it to be overridden by dynamic routing data. For example, a static route with a distance value of 200 is overridden by OSPF intra-area routes, which have a default distance of 110.

The `no ip route nexthop-group` and `default ip route nexthop-group` commands delete the specified route by removing the corresponding `ip route nexthop-group` command from *running-config*. `ip route nexthop-group` statements for an IP address in multiple VRFs must be removed separately.

A `no ip route` or `default ip route` command without a nexthop parameter deletes all corresponding `ip route nexthop-group` statements. Deleting a user-defined VRF also deletes its static routes.

Command Mode

Global Configuration

Command Syntax

```
ip route [VRF_INST dest_net nexthop-group nhgp_name [dist][TAG_OPTION][RT_NAME]
no ip route [VRF_INST] dest_net [nexthop-group nhgroup_name][distance]
default ip route [VRF_INST] dest_net [nexthop-group nhgroup_name][distance]
```

Parameters

- **VRF_INST** Specifies the VRF instance being modified.
 - **<no parameter>** Changes are made to the default VRF.
 - **vrf vrf_name** Changes are made to the specified VRF.
- **dest_net** Destination IPv4 subnet (CIDR or address-mask notation).
- **nhgp_name** Name of nexthop group.
- **dist** Administrative distance assigned to route. Options include:
 - **<no parameter>** Route assigned default administrative distance of one.
 - **<1-255>** The administrative distance assigned to route.
- **TAG_OPTION** Static route tag. Options include:
 - **<no parameter>** Assigns default static route tag of 0.
 - **tag t_value** Static route tag value. **t_value** ranges from 0 to 4294967295.
- **RT_NAME** Associates descriptive text to the route. Options include:
 - **<no parameter>** No text is associated with the route.
 - **name descriptive_text** The specified text is assigned to the route.

Related Commands

- [ip route](#) creates a static route that specifies the nexthop address without using nexthop groups.

Example:

This command creates a static route in the default VRF, using the nexthop group of **NH-1** to determine the next hop address.

- ```
switch(config)#ip route 10.17.252.0/24 nexthop-group NH-1
switch(config)#
```

### 12.9.3.3 nexthop-group

The **nexthop-group** command places the switch in nexthop-group configuration mode, through which nexthop groups are created or modified. The command also specifies the tunnel protocol for extracting payload from encapsulated packets that arrive through an IP address upon which the group is applied.

A nexthop group is a data structure that defines a list of nexthop addresses and the encapsulation process for packets routed to the specified address. The command either accesses an existing nexthop group configuration or creates a new group if it specifies a non-existent group. Supported tunnel protocols include IP ECMP and IP-in-IP.

Nexthop-group configuration mode is not a group change mode; **running-config** is changed immediately upon entering commands. Exiting nexthop-group configuration mode does not affect **running-config**. The **exit** command returns the switch to global configuration mode.

The **no nexthop-group** and **default nexthop-group** commands delete previously configured commands in the specified **nexthop-group** mode. When the command does not specify a group, it removes all nexthop-groups. When the command specifies a tunnel type without naming a group, it removes all nexthop-groups of the specified type.

#### Command Mode

Global Configuration

#### Command Syntax

```
nexthop-group group_name type TUNNEL_TYPE
no nexthop-group [group_name] [type TUNNEL_TYPE]
default nexthop-group [group_name] [typeTUNNEL_TYPE]
```

#### Parameters

- **group\_name** Nexthop group name.
- **TUNNEL\_TYPE** Tunnel protocol of the nexthop-group. Options include:
  - **ip** ECMP nexthop.
  - **ip-in-ip** IP in IP tunnel.
  - **gre** Encapsulates the Layer 3 protocols over IP networks.
  - **mpls-over-gre** Tunnels MPLS over a non-MPLS network.
    - entry Nexthop Group Entry Config.
    - size Nexthop Group Entry Size.
    - tos Tunnel encapsulation IP type of service.
    - ttl Tunnel encapsulation TTL value.
    - tunnel-source Source Interface or Address.

#### Commands Available in Nexthop-group Configuration Mode

- [entry \(Nexthop Group\)](#)
- [size \(Nexthop Group\)](#)
- [ttl \(Nexthop Group\)](#)
- [tunnel-source \(Nexthop Group\)](#)

#### Restrictions

Tunnel type availability varies by switch platform.

#### Examples

- This command creates a nexthop group named NH-1 that specifies ECMP nexthops.

```
switch(config)#nexthop-group NH-1 type ip
```

---

```
switch(config-nexthop-group-NH-1)#
```

- This command exits nexthop-group mode for the NH-1 nexthop group.

```
switch(config-nexthop-group-NH-1)#exit
switch(config)#
```

- These commands creates a nexthop group NH-2 of type MPLS over GRE.

```
switch(config)#nexthop-group NH-2 type mpls-over-gre
switch(config-nexthop-group-NH-2)#tunnel-source 11.1.1.1
switch(config-nexthop-group-NH-2)#ttl 32
switch(config-nexthop-group-NH-2)#tos 20
switch(config-nexthop-group-NH-2)#entry 0 push label-stack 16000
 tunnel-destination 11.1.1.2
switch(config)#ip route 100.1.1.1/32 Nexthop-Group NH-2
```

Counters for nexthop group may be enabled using the following command

```
switch(config)#hardware counter feature nexthop
```

### 12.9.3.4 show nexthop-group

The **show nexthop-group** command displays properties of the specified nexthop group.

#### Command Mode

EXEC

#### Command Syntax

```
show nhgroup_name[VRF_INST]
```

#### Parameters

- **nhgroup\_name** Name of the group displayed by command.
- **VRF\_INST** Specifies the VRF instance for which data is displayed.
  - **<no parameter>** Context-active VRF.
  - **vrf vrf\_name** Specifies the name of VRF instance. System default VRF is specified by **default**.

#### Related Commands

- [show nexthop-group](#) Places the switch in the nexthop-group configuration mode to create a new group or modify an existing group.

#### Example

This command displays the nexthop group information.

```
switch>show nexthop-group
switch(config)#show nexthop-group
 Id 107
 Type mplsOverGre
 Size 1 (auto size enabled, programmed size 1)
 TTL 32
 Source IP 11.1.1.1
 Entries (left most label is the top of the stack)
 0 push label-stack 16000 tunnel-destination 11.1.1.2
 Tunnel destination directly connected, Ethernet1
 00:00:aa:aa:aa:aa, Ethernet1

With nexthop group counter enabled
switch(config)#show nexthop-group
 Id 1
 Type mplsOverGre
 Size 1 (auto size enabled, programmed size 1)
 TTL 64
 Source IP 0.0.0.0
 Entries (left most label is the top of the stack)
 0 push label-stack 16000 tunnel-destination 1.1.1.2
 Tunnel destination directly connected, Ethernet1
 00:00:aa:aa:aa:aa, Ethernet1
 0 packets, 0 bytes

switch(config)#show nexthop-group summary
Number of Nexthop Groups configured: 1
Number of unprogrammed Nexthop Groups: 0

 Nexthop Group Type Configured

 MPLS over GRE 1

 Nexthop Group Size Configured

 1 1
```

---

### 12.9.3.5 size (Nexthop Group)

The **size** command configures the quantity of nexthop entries in the configuration mode nexthop group. Each entry specifies a nexthop IP address for static routes to which the group is assigned. Entries are configured with the [entry \(Nexthop Group\)](#) command. The default size is 256 entries.

The **no size** and **default size** commands restore the size of the configuration mode nexthop group to its default of 256 by removing the corresponding **size** command from **running-config**.

#### Command Mode

Nexthop-group Configuration

#### Command Syntax

```
size entry_size
```

```
no size entry_size
```

```
default size entry_size
```

#### Parameters

- **entry\_size** Group size (entries). Value ranges from 1 to 255. Default value is 256.

#### Example:

This command configures the nexthop group NH-1 to contain 128 entries.

```
switch(config)#nexthop-group NH-1
switch(config-nexthop-group-NH-1)#size 128
switch(config-nexthop-group-NH-1)#show active
 nexthop-group NH-1
 size 128
 ttl 64
switch(config-nexthop-group-NH-1)#
```



### 12.9.3.6 ttl (Nexthop Group)

The `ttl` command specifies the number entered into the TTL (time to live) encapsulation field of packets that are transmitted to the address designated by the configuration mode nexthop group. The default TTL value is 64.

The `no ttl` and `default ttl` commands restore the default TTL value written into TTL fields for the configuration mode nexthop group by deleting the corresponding `ttl` command from **running-config**.

#### Command Mode

Nexthop-group Configuration

#### Command Syntax

```
ttl hop_expiry
```

```
no ttl hop_expiry
```

```
default ttl hop_expiry
```

#### Parameters

- **hop\_expiry** Period that the packet remains valid (seconds or hops) Value ranges from 1 to 64.

#### Restrictions

This command is available only to Nexthop groups for tunnels of type **IP-in-IP**, **GRE**, **MPLS**, and **MPLS over GRE**.

#### Related Commands

- [nexthop-group](#) places the switch in Nexthop-group configuration mode.

#### Examples:

- This command configures the ttl setting to 32 for nexthop group NH-1 packets.

```
switch(config)#nexthop-group NH-1
switch(config-nexthop-group-NH-1)#ttl 32
switch(config-nexthop-group-NH-1)#show active
nexthop-group NH-1
 size 128
 ttl 32
switch(config-nexthop-group-NH-1)#
```

- This command restores the default ttl setting for nexthop group NH-1 packets.

```
switch(config-nexthop-group-NH-1)#no ttl
switch(config-nexthop-group-NH-1)#show active nexthop-group
NH-1
 size 128
 ttl 64
switch(config-nexthop-group-NH-1)#
```

### 12.9.3.7 tunnel-source (NextHop Group)

The **tunnel-source** command specifies the address that is entered into the source IP address encapsulation field of packets that are transmitted as designated by the configuration mode nexthop group. The command may directly specify an IP address or specify an interface from which an IP address is derived. The default source address IP address is **0.0.0.0**.

The **no tunnel-source** and **default tunnel-source** commands remove the source IP address setting from the configuration mode nexthop group by deleting the **tunnel-source** command from **running-config**.

#### Command Mode

NextHop-group Configuration

#### Command Syntax

```
tunnel-source SOURCE
```

```
no tunnel-source SOURCE
```

```
default tunnel-source SOURCE
```

#### Parameters

- **SOURCE** IP address or derivation interface. Options include:
  - **ipv4\_addr** An IPv4 address.
  - **intf ethernet e\_num** Ethernet interface specified by **e\_num**.
  - **intf loopback l\_num** Loopback interface specified by **l\_num**.
  - **intf management m\_num** Management interface specified by **m\_num**.
  - **intf port-channel p\_num** Port-channel interface specified by **p\_num**.
  - **intf vlan v\_num** VLAN interface specified by **v\_num**.

#### Restrictions

This command is available only to NextHop groups for tunnels of type **ip-in-ip**.

#### Related Commands

- [nexthop-group](#) Places the switch in NextHop-group configuration mode.

#### Example:

These commands create **loopback interface 100**, assign an IP address to the interface, then specifies that address as the tunnel source for packets designated by nexthop-group **NH-1**.

```
switch(config)#interface loopback 100
switch(config-if-Lo100)#ip address 10.1.1.1/32
switch(config-if-Lo100)#exit

switch(config)#nexthop-group NH-1
switch(config-nexthop-group-NH-1)#tunnel-source intf loopback 100
switch(config-nexthop-group-NH-1)#show active nexthop-group NH-1
 size 256
 ttl 64
 tunnel-source intf Loopback100
switch(config-nexthop-group-NH-1)#show nexthop-group NH-1
Name Id type size ttl sourceIp
NH-1 2 ipInIp 256 64 10.1.1.1
```

```
switch(config-nexthop-group-NH-1) #
```

## 12.10 Global Knob to Set MTU for all Layer 3 Interfaces

- Global Layer 3 Maximum Transfer Unit (MTU) feature provides a CLI command to set the MTU value for all Layer 3 interfaces.
- The default value for global Layer 3 MTU and for each interface Layer 3 MTU is 1500.
- Any interface which has an MTU configured is not affected by the global L3 MTU.
- When the global L3 MTU is changed, any existing interfaces which are using the default are updated to use the new MTU. Any additional interfaces which are configured in the future will also use the new default MTU.

The related sections are:

- [Platform Compatibility](#)
- [Global Knob to Set MTU for all Layer 3 Interfaces Configuration](#)
- [Show Commands](#)
- [Troubleshooting](#)
- [Limitations](#)

### 12.10.1 Platform Compatibility

Global knob to set MTU for all Layer 3 interfaces is available on all platforms.

### 12.10.2 Global Knob to Set MTU for all Layer 3 Interfaces Configuration

The global L3 `mtu` command is under *interface-defaults sub-mode*. In this example, the MTU value is set to 1600.

```
(config)#interface defaults
(config-interface-defaults)#mtu 1600
```

### 12.10.3 Show Commands

Use the `show interface` command to display the current MTU value applied on the selected interface. In the following example, interfaces *Ethernet1*, *Ethernet2*, and *Ethernet3* are selected for display.

```
(config)#interface Ethernet3
(config-if-Et3)#no switchport
(config-if-Et3)#mtu 1600
(config-if-Et3)#interface defaults
(config-interface-defaults)#mtu 1700
(config-interface-defaults)#show interfaces Ethernet1
...
 IP MTU 1700 bytes (default) , BW 10000000 kbit
...
(config-interface-defaults)#show interfaces Ethernet2
...
```

```
IP MTU 1700 bytes (default) , BW 10000000 kbit
...
(config-interface-defaults)#show interfaces Ethernet3
...
IP MTU 1600 bytes , BW 10000000 kbit
...
```

In this example,

- switch **Ethernet3** from Layer 2 to Layer 3 and explicitly set its MTU to **1600**.
- enter the **interface-defaults sub-mode**, set global L3 MTU to **1700**.
- the **show interface** command states **Ethernet1** and **Ethernet2** are using global L3 MTU value, while **Ethernet3** are using its local MTU value.
- the **(default)** in the output indicates whether or not the interface is using global L3 MTU.

## 12.10.4 Troubleshooting

The following are troubleshooting elements for the Global knob to set MTU for all Layer 3 interfaces feature:

- For Ethernet interfaces, traces are found in the trace file for the platform agent.
- For Port-Channel interfaces, traces are found in the trace file for the **Lag** agent.
- For VLAN interfaces, traces are found in the trace file for the **Ebra** agent.

## 12.10.5 Limitations

The following are limitations for the Global knob to set MTU for all Layer 3 interfaces feature:

- Only Ethernet, Port-Channel, and VLAN interfaces are supported.
- Other interface types, such as Management, Loopback, VXLAN, and Tunnel, are not supported.

## 12.11 Support for L3 MTU on 7280R3/7500R3/7800R3

Support for Layer 3 Maximum Transmission Unit (MTU) on 7280R3/7500R3/7800R3 switches includes the following:

- Enforces the MTU for Layer 3 packets on 7280R3/7500R3/7800R3 switches. The MTU can be set on any SVI and the MTU of that specific SVI is enforced when the packets egress out of a trunk port. This behavior is not supported on 7280E/R/R2 and 7500E/R/R2 line cards.
- MTU enforcement is done after adding all of the encapsulation headers in the Egress packet. For example, if an interface is configured with an MTU value of 1500 and the packet size is larger than 1500 with all encapsulation headers added, the packet is considered MTU violated. In 7280E/R/R2 and 7500E/R/R2 line cards, MTU is enforced before adding encapsulation headers.
- Actual MTU configured in hardware is MTU configured in the CLI + 18 bytes. 18 bytes is added to accommodate the L2 header. If the outgoing packet is untagged, the actual MTU configured in hardware is the MTU configured in the CLI + four (4) bytes.

### 12.11.1 Layer 3 MTU Platform Compatibility

Layer3 MTU is supported on the following platforms:

- DCS-7280R3
- DCS-7500R3
- DCS-7800R3

## 12.11.2 Layer 3 MTU Configuration

You can configure Layer 3 MTU on Layer 3 interfaces and SVI's using the `mtu` command within interface configuration mode.

This command sets the MTU size of **1492** bytes on *interface ethernet 1/1*.

```
(config)#interface ethernet 1/1
(config-if-Et1/1)#mtu 1492
```

MTU is independently configurable on all routable interfaces. The switch supports MTU sizes ranging from 68 to 9214 bytes. The default MTU size is 1500 bytes.

The `no mtu` and `default mtu` commands restore the interface's MTU to the default value by removing the corresponding `mtu` command from *running-config*.

## 12.11.3 Layer 3 MTU Show Commands

The `show interfaces` command displays the MTU configured on the L3 interface. In this example, Ethernet 1/1 interface is selected to display. "IP MTU" represents the Layer 3 MTU of the interface.

```
switch(config-if-Et9/1)#show interfaces ethernet 1/1
...
 IP MTU 1600 bytes , BW 100000000 kbit
 Full-duplex, 100Gb/s over 4 lanes, auto negotiation: off, uni-
link: n/a
...
```

## 12.11.4 L3 MTU Syslog Messages

The following message are added to Syslog if the number of unique MTU values exceeds three (3) in the switch.

```
%SAND-3-ROUTING_MTU_CONFIG_ERROR: Failed to program MTU
on Interface Ethernet1/2. The number of unique MTU values
configured on routed interfaces exceeds the maximum supported
(\x03)
```

Only three (3) unique MTU values are supported on a switch. If the number of unique MTU values exceeds three (3), the additional MTU configuration is not applied in the hardware.

## 12.11.5 L3 MTU Troubleshooting

Layer 3 MTU is implemented in `SandFapNi` and `SandL3Unicast` agents. Check `SandFapNi` and `SandL3Unicast` agent logs and qt files for MTU related messages.

To verify the MTU configured on the kernel interface, use the following bash command:

```
#ifconfig et1_1
et1_1: flags=4163<UP,BROADCAST,RUNNING,MULTICAST> mtu 1600
...
```

### 12.11.6 L3 MTU Limitations

The following limitations apply to support of Layer 3 MTU:

- Only three (3) unique MTU values can be configured on a switch. If the number of unique MTU values exceeds three (3), additional unique MTU definitions will not be enforced on an interface.
  - When the number of unique MTU values becomes less than three (3) (after unconfiguring MTU on some interfaces), MTU on interfaces that are previously unprogrammed, are not reprogrammed automatically. CLI commands `no mtu` followed by `mtu <>` must be called to program MTU on an interface.
- When the startup configuration has more than three (3) unique MTU values defined on different interfaces of the switch, there is no guarantee which unique MTU values will be active when the switch is rebooted.
- L3 MTU is not enforced on Multicast packets for Jericho2 based platforms.

## IP Services

---

The Internet Protocol Services (IP Services) chapter contains the following section(s):

- [CloudVision eXchange \(CVX\)](#)

### 13.1 CloudVision eXchange (CVX)

CloudVision eXchange (CVX) provides a single access point for real-time provisioning, orchestration and integration with third-party controllers. CVX aggregates and distributes operational state information across a set of EOS switches to support applications that provide network services. See the *CloudVision User Guide*, <https://www.arista.com/en/support/product-documentation>, for additional information.

Topics in this section include:

- [Upgrading CVX](#)
- [CVX Overview](#)
- [CVX Services](#)
- [Deploying CVX](#)
- [CVX Configuration](#)
- [CVX Secure out-of-band Connection](#)
- [CVX High Availability](#)
- [CVX VIP](#)
- [CVX Command Descriptions](#)

#### 13.1.1 Upgrading CVX

You can upgrade CVX from a previous version to the current version by performing a few simple tasks. You can use the following procedure to upgrade any previous version of CVX to the current version.

##### Requirements

Make sure you follow these requirements during the upgrade process.

- If you have CVP, CVX and client switches in your environment, make sure you upgrade each component in the following order:
- Upgrade CVP first
- Upgrade the CVX cluster.
- Upgrade the client switches. The reason for this is to ensure backward compatibility.
- You must upgrade the CVX cluster before you upgrade the client switches.
- If the CVX cluster is a 3 node cluster, make sure that only one node of the cluster is down at any one time during the upgrade process. (The order in which you upgrade the nodes does not matter.)

##### Pre-requisites

Before you begin the upgrade, make sure that:

- You perform a backup to ensure that you can restore data if needed.
- You download the latest version of CVX from Arista's Software Download page (<https://www.arista.com/en/support/software-download>).

---

Complete the following steps to upgrade CVX.

1. Login to the cluster to be upgraded. (You can login to any node.)
2. Upgrade the node. You must deploy a new image to perform the upgrade.
3. Wait for the node you are upgrading to rejoin the cluster. Once the node has rejoined, go to the next step. (The node automatically rejoins the cluster as a follower node.)
4. Repeat steps **1 through 3** to upgrade the two remaining nodes one node at a time. It does not matter the order in which you upgrade the remaining nodes.

## 13.1.2 CVX Overview

A CVX deployment includes CVX and a set of CVX clients to which CVX provides services. CVX is not part of the data plane, nor does it receive data-path traffic. All CVX components exist as agents that run on EOS instances.

For more information, see:

- [System Requirements](#)
- [CVX Infrastructure](#)
- [CVX Features](#)
- [CVX Clients](#)

### 13.1.2.1 System Requirements

Certain hardware and software is required to be able to use CloudVision eXchange in your CloudVision virtual appliance implementation.

The CloudVision eXchange should be installed on a single system along with CloudVision Portal.

The following table lists the minimum hardware and software required to use CloudVision eXchange.

#### Required Hardware

The hardware required to use the CloudVision eXchange are:

- CPU: 4 cores (base), 8 cores (recommended)
- RAM: 4G (base), 8G (recommended)
- Disk: 4G

#### Required Software

The software required to use the CloudVision eXchange are:

- EOS switches: Recommend 4.16.8M or later

 **Note:** It is a best practice and highly recommended that the version of CVX should match the version running on the switches.

- CloudVision Portal: version 2016.1

(CloudVision Portal software is required if you want to use it in conjunction with CloudVision eXchange. If you plan to use only CloudVision eXchange, CloudVision Portal software is not required.)

 **Note:** CVX supports live vMotion.

### 13.1.2.2 CVX Infrastructure

CVX provides a single integration point into network-wide services running across CVX clients. CVX is typically deployed as an EOS instance running on a VM (vEOS). The CVX infrastructure consists of a CVX instance functioning as a server and a set of CVX clients. The CVX server uses a heartbeat keepalive (KA) mechanism to maintain contact with its clients.

When de-configuring or shutting down CVX, client services should be shut down first.



### 13.1.2.3 CVX Features

CVX manages communications among the network CVX clients, and provides an integration point for services to those clients. CVX also discovers the physical network topology by aggregating topology information it receives from its client devices.

### 13.1.2.4 CVX Clients

CVX client is the agent that allows a switch to interact with a CVX server to access CVX services. Enabling the CVX client includes providing the IP address or host name of the device running CVX. The CVX client can then access services that are enabled on the CVX server.

The CVX client must be enabled to access the CVX server and the services it offers. Individual services may require additional configuration statements.

Services should be shut down or de-configured on clients before shutting down or de-configuring CVX. CVX-controlled switch features may continue to run after shutting down CVX if they are not explicitly shut down or de-configured prior to shutting down CVX.

## 13.1.3 CVX Services

CVX services are applications that run on top of the CVX infrastructure, and are accessed by CVX clients through the CVX server. All CVX services are maintained by version level; client switches negotiate the version they use when connecting to the server. This allows multiple switches that run different EOS versions to connect to the same CVX server.

The following sections briefly describe some of the services available to CVX clients through CVX:

- [OpenStack Service](#)
- [VXLAN Control Service](#)
- [Hardware Switch Controller \(HSC\) Service](#)
- [Network Topology Service](#)

### 13.1.3.1 OpenStack Service

The OpenStack service on CVX allows the networking component of an OpenStack deployment (also known as Neutron) to share state with CVX.

When deployed, this integration allows CVX to send state about the logical networks created in the OpenStack cloud to the CVX clients that configure the network.

More information on OpenStack software can be found in its online documentation at <http://docs.openstack.org/>.

### 13.1.3.2 VXLAN Control Service

The VXLAN control service allows hardware VXLAN tunnel end points (VTEPs) to share state with each other in order to establish VXLAN tunnels without the need for a multicast control plane. Configuration is required both on the client switches and in CVX.

### 13.1.3.3 Hardware Switch Controller (HSC) Service

Traffic between virtual machines which share a physical host (or between virtual machines and the rest of the network) is forwarded by virtual switches. The management and configuration of virtual switches uses the Open vSwitch Database (OVSDB) management protocol, as described in RFC 7047.

The hardware switch controller (HSC) service provides an integration point between OVSDB controllers and the VXLAN control service, allowing exchange of state information among virtual and hardware switches.

### 13.1.3.4 Network Topology Service

The network topology service gathers information from CVX clients to provide a view of the physical topology of the network. Aggregated information gathered by the network topology service is used by other CVX services, and can be viewed on the CVX server.

### 13.1.4 Deploying CVX

CloudVision Exchange (CVX) can be deployed on KVM and ESXi. The required EOS version and Aboot version vary depending on whether you are deploying CVX on KVM or ESXi.

For the detailed steps to use to deploy CVX, see:

- [Deploying CVX on Kernel-based Virtual Machine \(KVM\)](#)
- [Deploying CVX on VMware ESXi](#)

#### 13.1.4.1 Deploying CVX on Kernel-based Virtual Machine (KVM)

Complete the following steps to install CVX on Ubuntu/KVM. Once the installation is complete, you can begin the CVX configuration process.

 **Note:** Make sure you select versions of EOS and Aboot that meet the minimum requirements for CVX. The supported versions are:

- EOS (version 4.16.8M or later)
- `Aboot-veos-serial-8.0.0.iso` (located in the vEOS section of the download)

#### Pre-requisites

Before you begin the procedure, make sure that:

- Install **qemu-kvm**, **libvirt\***, and all related dependencies using yum (RHEL7/CentOS7) and apt-get (Ubuntu).
- Two bridges are configured for use by the KVM VM, and that you have the names of the bridges. (Steps are included in the procedure to add bridges, if they are not already configured.)

 **Note:** The bridges must be configured to persist (**brctl** commands do not persist across reboots). You can use Network Manager (or another application available to you) to complete this configuration.

- You have both **generateXmlForKvm.py** and **cvpTemplate.xml**. They are required to complete the procedure. You can find them in the CVP tarball for Ubuntu.

Complete the following steps to install CVX.

1. Download the Aboot and EOS files from: <https://www.arista.com/en/support/software-download/>.
2. Use **sudo su** to acquire superuser privileges, which are required to complete some of the installation steps.
3. Confirm that KVM is running on the server by entering the following command:

```
virsh -c qemu:///system listAb
```

The command output should match this example:

```
Id Name State

$
```

4. If the output does not look correct (previous step) go to for additional assistance: <https://help.ubuntu.com/community/KVM/Installation>.

- Use the following command to convert the **vmdk** file to **qcow2**: `qemu-img convert EOS_4_16_8M.vmdk -O qcow2 EOS.qcow2`

 **Note:** Step 6 and 7 are required if you do not already have 2 bridges defined in different subnets. If the bridges exist, go directly to step 8.

- Use **brctl** to add bridges for the KVM VM to use (br1 and br2 can be any names you choose).

```
brctl addbr br1
brctl addbr br2
```

**ifconfig** can be used to identify Ethernet ports to be bridged. Once you identify the ports, add them to the bridges.

#### Example

```
brctl addif br1 enx803f5d086eae
```

- Confirm that the bridges are up using **brctl show**.

- Enter: `ifconfig br1 up`
- And: `ifconfig br2 up`

 **Note:** The following step uses a number of input parameters (the number required vary depending on your server setup). To ensure the command executes successfully, we recommend that you type it into a scratch pad and edit as needed before typing it into the Linux Terminal.

- Use the following command to generate **cvx.xml**, which will be used to setup the CVX VM.

```
generateXmlForKvm.py
```

#### Example

```
python generateXmlForKvm.py -n cvx --device-bridge br1 --cluster-bridge
br2 -e /usr/bin/kvm -i cvpTemplate.xml -c /home/myname/Downloads/Abo
ot-veos-serial-8.0.0.iso -x /home/myname/Downloads/EOS.qcow2 -b 8192 -p
2 -t
```

```
-n cvx: VM name.
--device-bridge br1: This is the name you gave the bridge - br1 or
anything else.
--cluster-bridge br2: Cluster bridge if clustering servers.
-i cvpTemplate.xml: Path to XML file input template.
-k: VM ID number used by virsh. If not entered, a random number is
assigned.
-b 8192: 8G of RAM.
-p 2: # of CPU cores.
-c: Path to Aboot file.
-x: Path to qcow2 file created in step 3.
-t: This parameter indicates the file defined by -x is for CVX.
-e â€˜~/usr/bin/kvm: Ubuntu path to KVM.
(for RHEL KVM this is: -e â€˜~/usr/libexec/qemu-kvm)
-o: XML file used by virsh to define the KVM VM.
```

- Run the following commands:

```
virsh define cvx.xml
virsh start cvx
virsh console cvx
```

- (Optional) To configure CVX to start automatically, enter:

```
virsh autostart cvx
```

You are now ready to begin the CVX configuration (see [CVX Configuration](#) ).

### 13.1.4.2 Deploying CVX on VMware ESXi

Complete the following steps to install CVX on ESXi. Once the installation is complete, you can begin the CVX configuration process.



**Note:** Make sure you select versions of EOS that meet the minimum requirements for CVX. The supported version is EOS (version **4.21.0** or later).

Complete the following steps to install CVX.

1. Go to: <https://www.arista.com>.
2. Select **Support > Software Download**.
3. From the software download page, expand **Active Releases > 4.21 > EOS-4.21.0F** to download **EOS-4.21.0F.vmdk**.
4. Load the files you downloaded into a filestore location within the VMware vSphere environment.

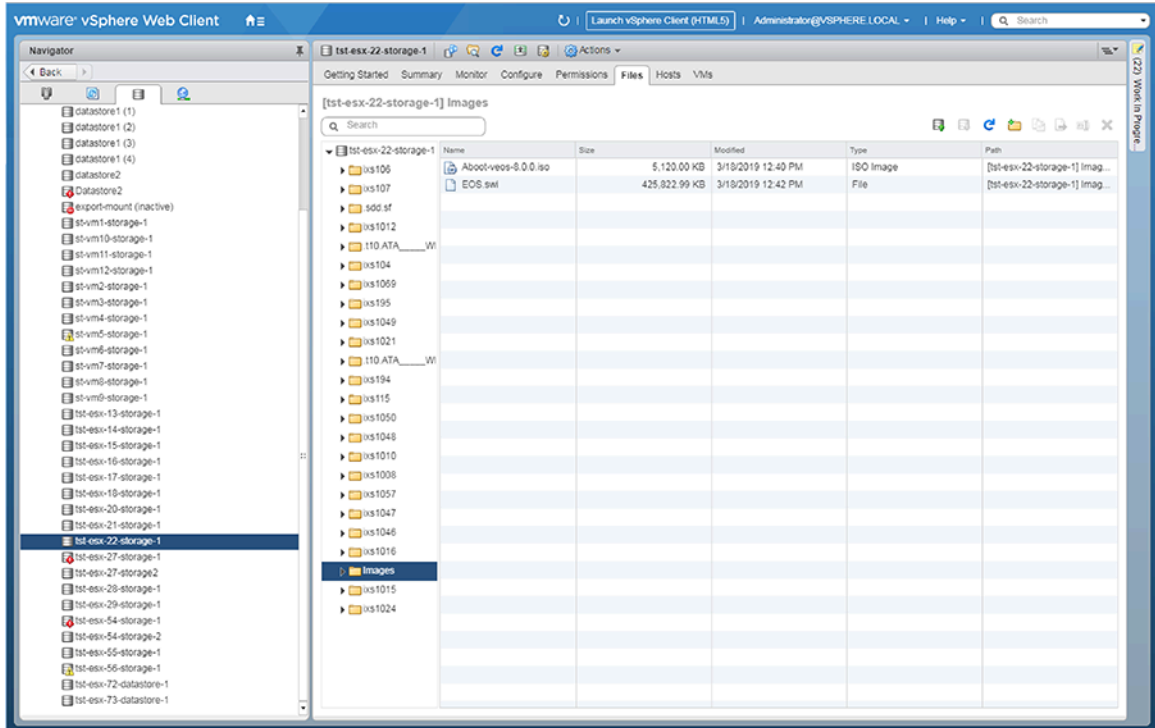
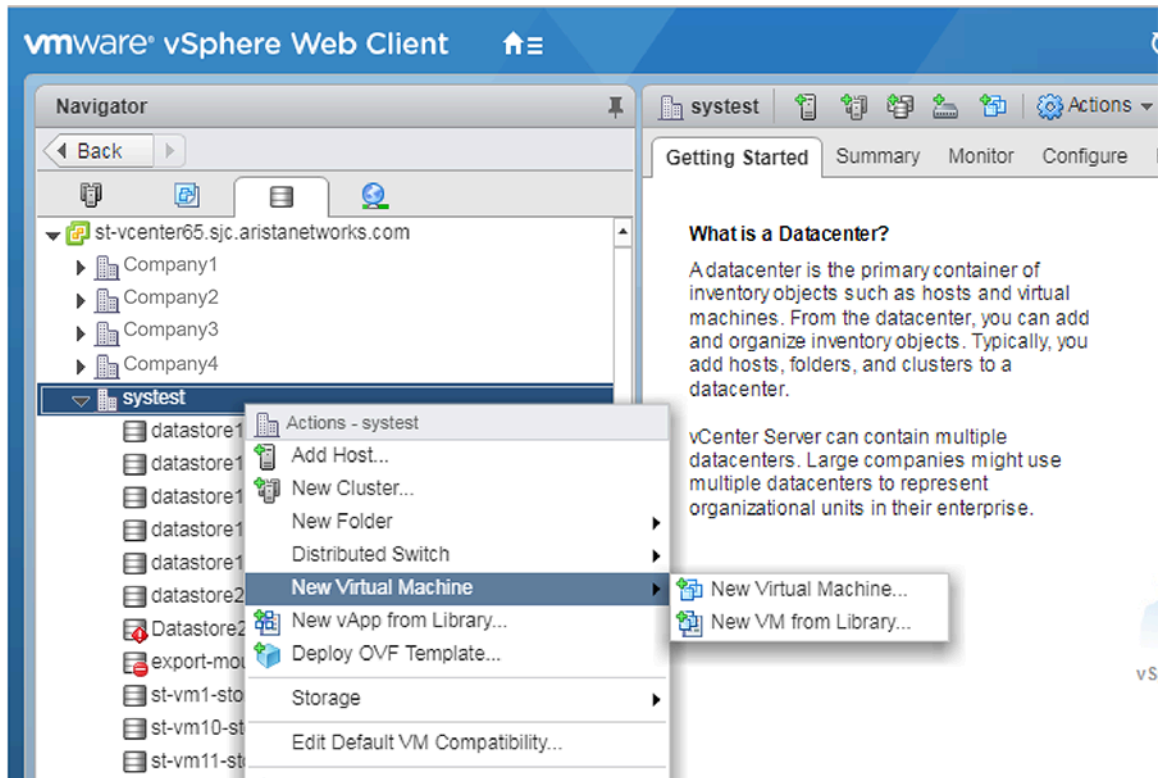

Figure 35: Loading the files into the VMware vSphere environment

- Right-click the **filestore location** you selected, and choose **New Virtual Machine**.



**Figure 36: Selecting New Virtual Machine**

The New Virtual Machine dialog appears.

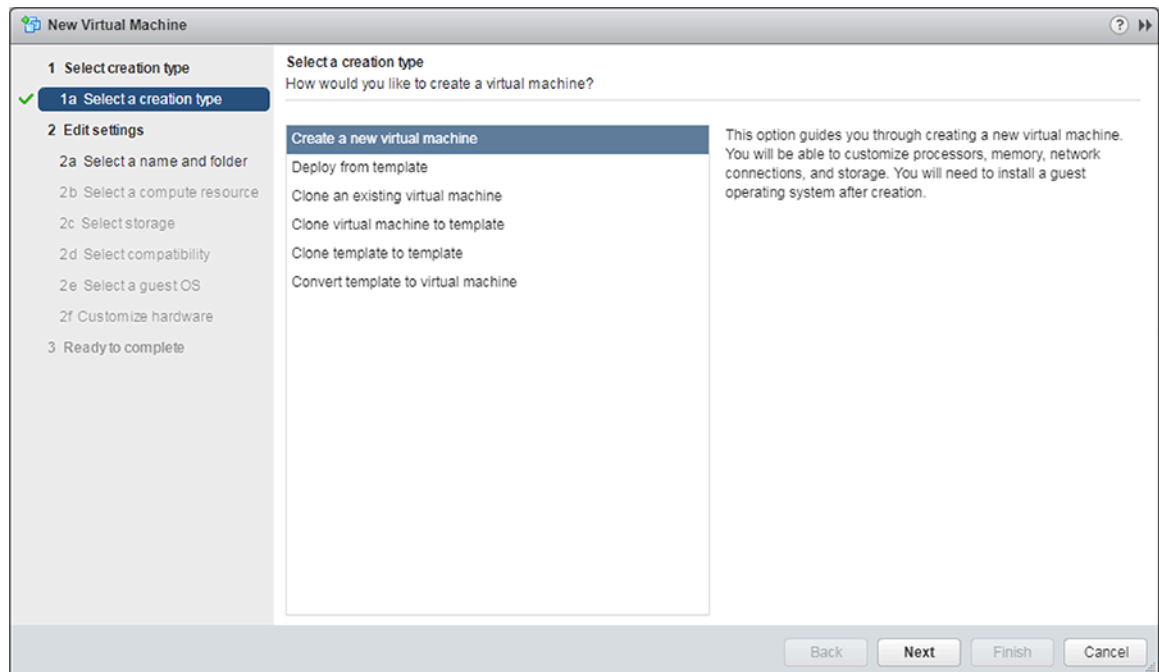

**Figure 37: New Virtual Machine dialog**

6. In the New Virtual Machine dialog, select **Create a new virtual machine**, then click **Next**.  
The dialog refreshes, showing options for the new Virtual Machine.  
New Virtual Machine dialog (naming and selecting the location)

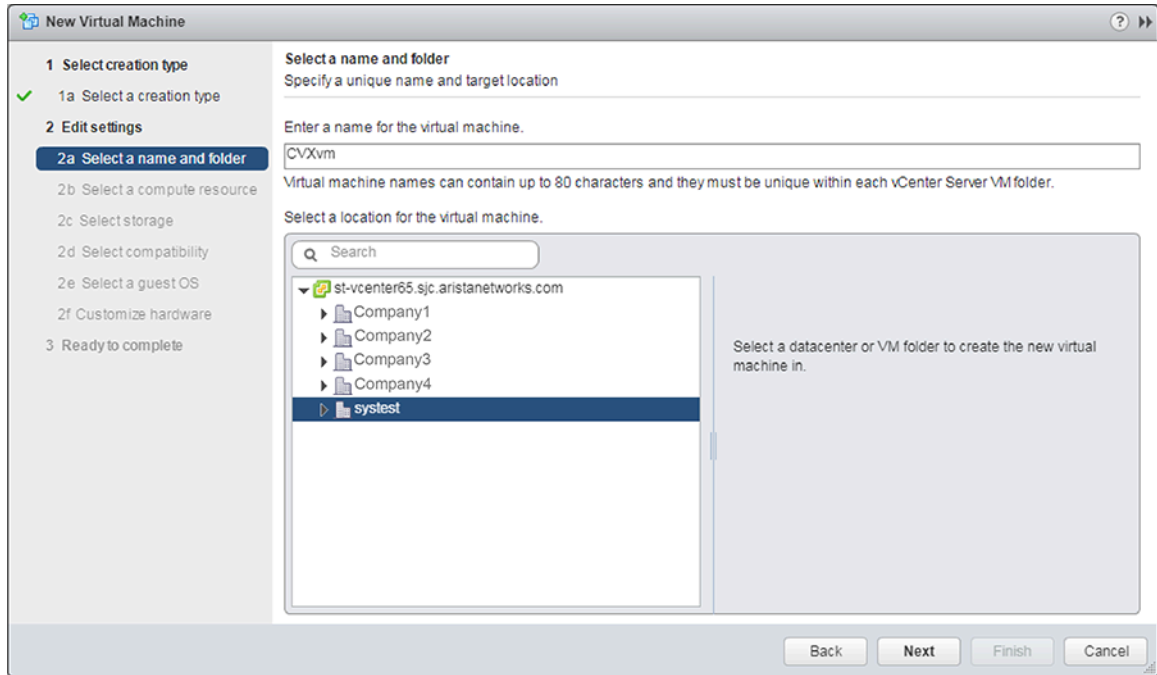

**Figure 38: New Virtual Machine dialog (naming and selecting the location)**

- The dialog refreshes, showing options for selecting the datastore.
7. Enter a **name** for the new Virtual Machine.
  8. Select a **location** for the new Virtual Machine, then click **Next**.

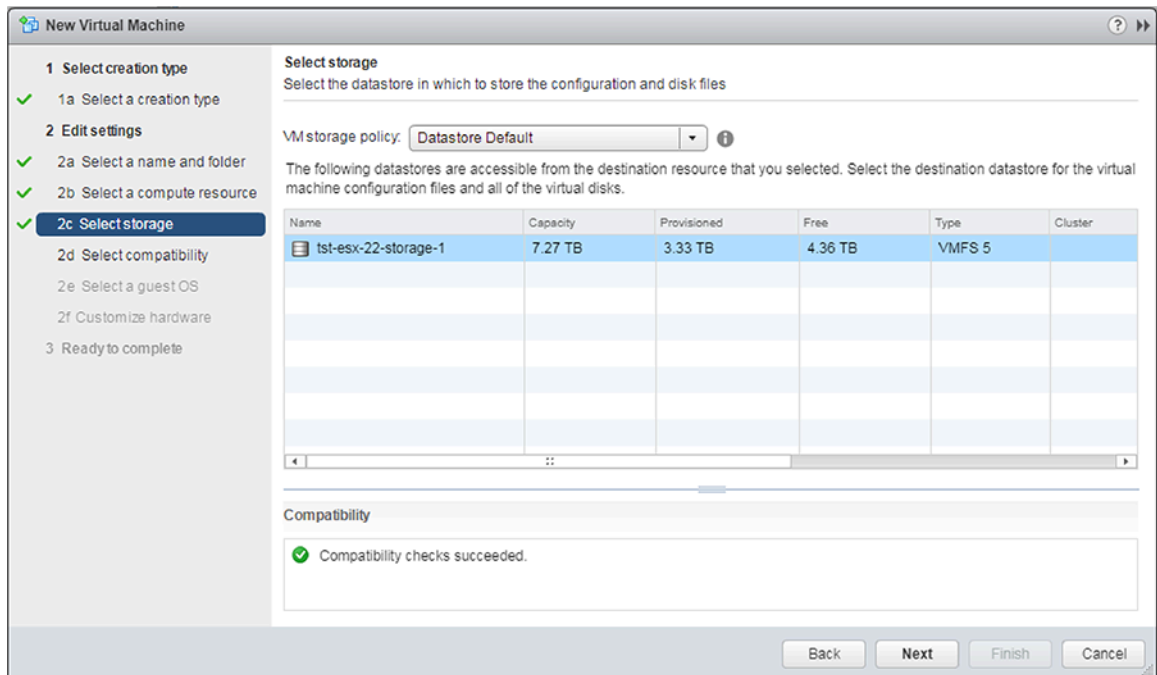

**Figure 39: New Virtual Machine dialog (selecting the datastore)**

9. Select the **datastore** for the new Virtual Machine configuration files and all of the virtual disks.

- Click **Next**.

The dialog refreshes, showing operating system selection options.

10. Click **Next**.

The dialog refreshes, showing compatibility options.

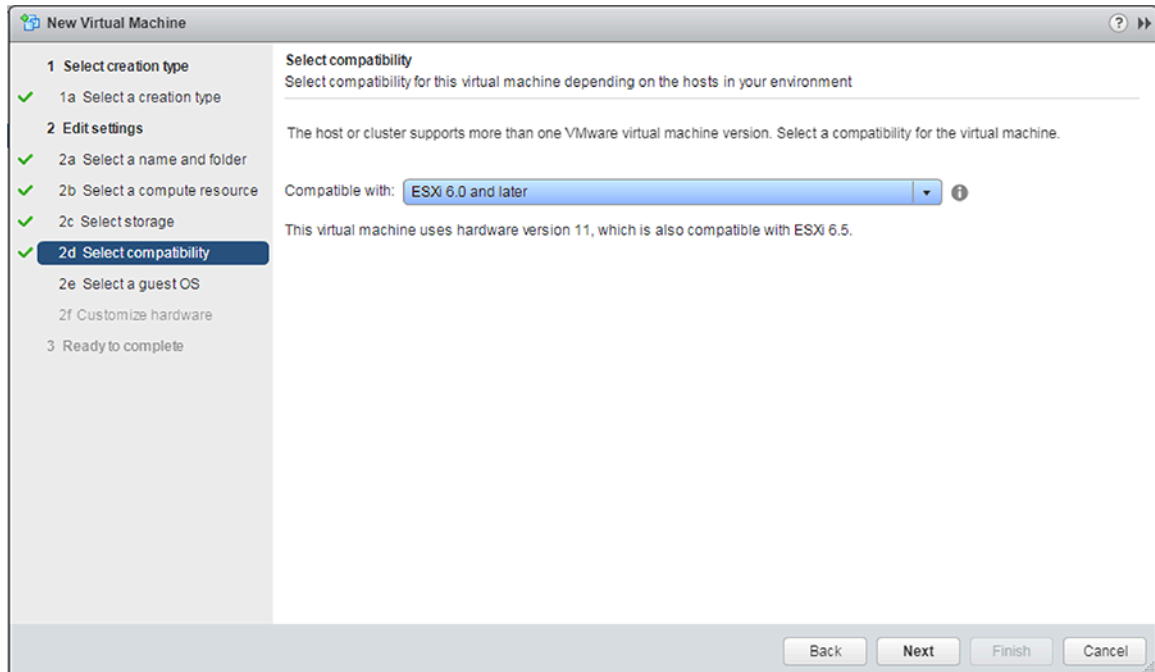

**Figure 40: New Virtual Machine dialog (compatibility options)**

11. Using the Compatible with menu, select the **ESXi compatibility** for the new Virtual Machine.



**Note:** When adding the VMDK to ESX6, it treats this as sparse by default, whereas in ESX 5 it is thick. Converting the vEOS VMDK file from thin to thick would allow it to boot properly in ESX6: `vmkfstools -i vEOS-lab-4.18.5M.vmdk -d eagerzeroedthick vEOS-lab-4.18.5M-thick.vmdk`.

Go to <https://eos.arista.com/> and refer to the following topics for the issue and solution:

- Tip for Arista vEOS on VMware ESX 6
- Common Issues When Deploying CVX 4.18.2F on vCenter 6 or 6.5



**Note:** If the VM keeps rebooting and showing "This is not a bootable disk. Insert a bootable floppy and press any key to try again", then go to <https://eos.arista.com/> and refer to the **Common Issues When Deploying CVX 4.18.2F on vCenter 6 or 6.5** topic.

12. Click **Next**.

The dialog refreshes, showing operating system selection options.

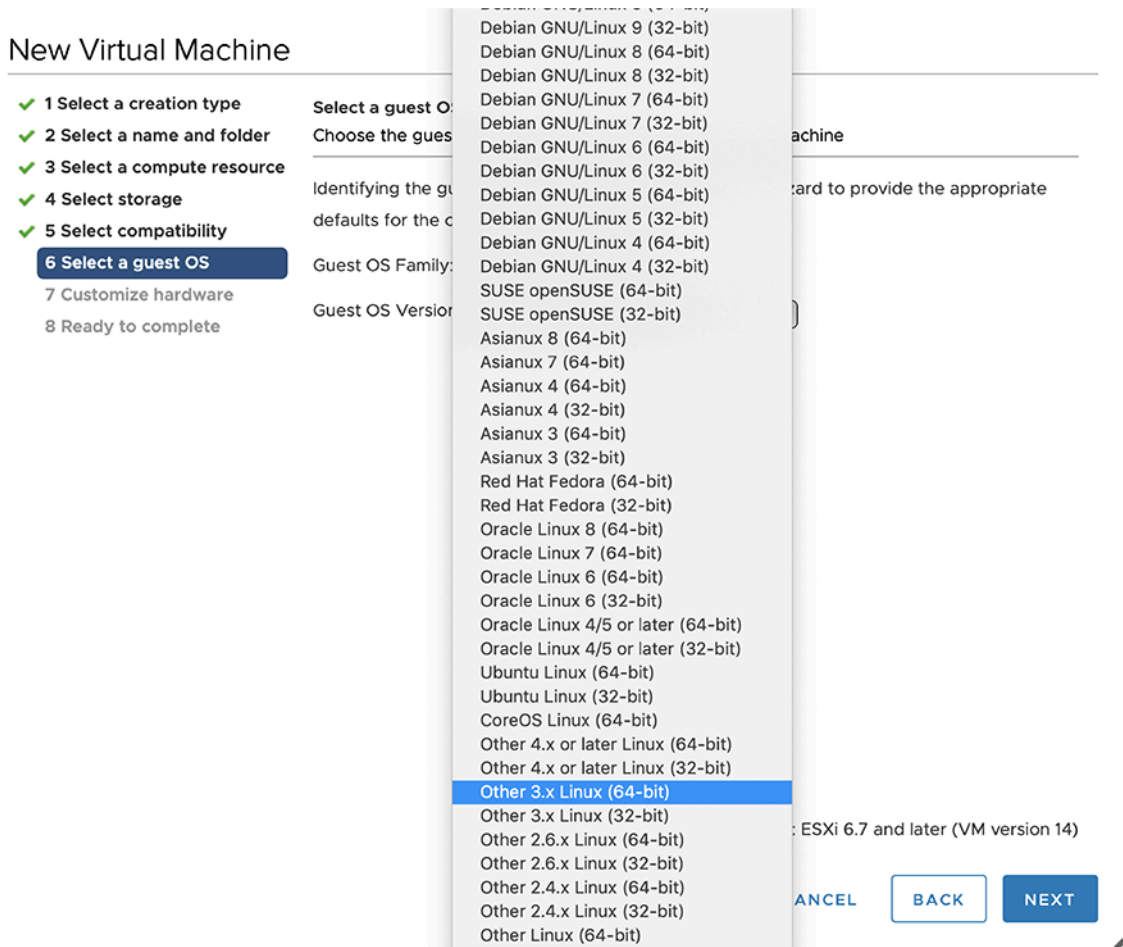

**Figure 41: New Virtual Machine dialog (operating system options)**

13. Using the Guest OS Family menu, choose **Linux**.

14. Using the Guest OS Version menu, choose **Other Linux (64-Âbit)**.



15. Click **Next**.

The dialog refreshes, showing options for customizing hardware.

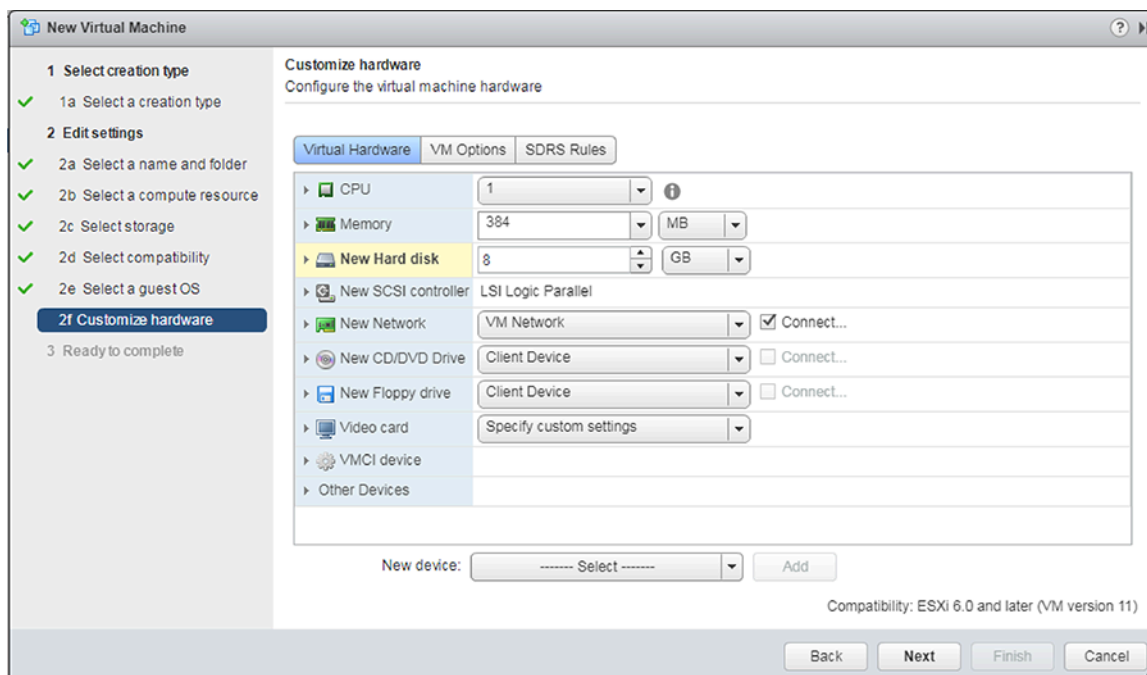

**Figure 42: New Virtual Machine dialog (hardware configuration options)**

## 16. Change the default settings for the following options:

|                           |                                                                                                                                                                                                              |
|---------------------------|--------------------------------------------------------------------------------------------------------------------------------------------------------------------------------------------------------------|
| <b>CPU</b>                | Set to <b>4</b> (number of CPUs)                                                                                                                                                                             |
| <b>Memory</b>             | Set to <b>8 GB</b>                                                                                                                                                                                           |
| <b>New Hard Disk</b>      | Delete the current setting (leave this option empty).                                                                                                                                                        |
| <b>New Network</b>        | Specify connection to Network LAN segment with connectivity to CVX client devices (the Management LAN). Choose VMXNET3 network adapter type. This connection is used for CVX client / server communications. |
| <b>Existing Hard Disk</b> | Specify the <b>EOS-4.21.0F.vmdk</b> you downloaded in step 3.                                                                                                                                                |

## 17. (Optional) Delete the floppy drive and SCSI controller.

18. Click **Next**.

You are now ready to begin the CVX configuration (see [CVX Configuration](#)).

### 13.1.5 CVX Configuration

CVX, its clients, and its services, are independently configured. These sections describe configuration processes for each:

- [Ports Used by CVX](#)
- [CVX Server Configuration](#)
- [CVX Client Configuration](#)
- [CVX Client Services Configuration](#)

#### 13.1.5.1 Ports Used by CVX

CVX uses the following ports:

- Controller database (Controllerdb): Port 9979
- Client-server out-of-band connection: Port 50003
- CVX cluster peer out-of-band connection: Port 50004

 **Note:** All of these connections are TCP.

### 13.1.5.2 CVX Server Configuration

#### Enabling CVX on the CVX Server

CVX parameters for the server infrastructure are configured in **CVX configuration** mode. CVX configuration mode is not a group-change mode; **running-config** is changed when commands are entered, and exiting the mode does not modify **running-config**. The **cvx** command places the switch in **CVX configuration** mode.

CVX is disabled by default. The **no shutdown (cvx)** command enables CVX on the switch.

#### Example

These commands enter CVX-configuration mode and enable CVX.

```
switch(config)#cvx
switch(config-cvx)#no shutdown
switch(config-cvx)#
```

#### CVX Heartbeat Configuration

CVX synchronizes with its client devices by exchanging heartbeat signals. The heartbeat transmission frequency and timeout period determine when a client's access to the server is disrupted.

The interval between heartbeat messages that the server transmits is specified by the **heartbeat-interval (cvx)** command. The CVX timeout period is specified by the **heartbeat-timeout (cvx)** command. When CVX does not receive a subsequent heartbeat message from a CVX client before the timeout expiry, the server discontinues CVX services to that client.

Best practices dictate that CVX and its client applications configure identical heartbeat interval and heartbeat timeout values.

#### Example

These commands configure a CVX heartbeat interval of 30 seconds and a server heartbeat timeout period of 90 seconds.

```
switch(config-cvx)#heartbeat-interval 30
switch(config-cvx)#heartbeat-timeout 90
switch(config-cvx)#
```

#### Disabling CVX on the CVX Server

 **Note:** Before disabling or de-configuring CVX on the CVX server, CVX client services should be explicitly disabled or shut down. Failure to disable or de-configure services prior to disabling or de-configuring CVS may result in CVX features continuing to run after CVX shutdown.

When disabling the CVX service, service VXLAN configuration may be retained or erased. Be sure to disable or shut down client services prior to disabling the CVX service.

#### Examples

- These commands shut down the CVX service while retaining the CLI configuration for service VXLAN.

```
localhost(config)#cvx
localhost(config-cvx)#service vxlan
```

```
localhost(config-cvx-vxlan)#shutdown
```

- These commands shut down the CVX service and also erase service VXLAN CLI configuration.

```
localhost(config-cvx-vxlan)#
localhost(config)#cvx
localhost(config-cvx)#no service vxlan
```

### 13.1.5.3 CVX Client Configuration

This section describes the CVX client configuration and commands that enable CVX services. Most commands for the configuration of the CVX client infrastructure are accessed in Management-CVX configuration mode.

- Enabling CVX on the CVX Client

CVX client parameters are configured in **Management-CVX configuration** mode. Management-CVX configuration mode is not a group-change mode; running-config is changed when commands are entered, and exiting the mode does not modify running-config. The **management cvx** command places the switch in **Management-CVX configuration** mode.

CVX client is disabled by default. The **no shutdown (Management-CVX)** command enables CVX client on the switch.

For the CVX network topology service to create an inventory of all CVX clients, ensure that LLDP is enabled on each client switch using the **lldp run** command.

#### Example

These commands enter **Management-CVX-configuration** mode and enable the CVX client.

```
switch(config)#lldp run
switch(config)#management cvx
switch(config-mgmt-cvx)#no shutdown
switch(config-mgmt-cvx)#
```

- **CVX Client Heartbeat Configuration**

A CVX client synchronizes and maintains contact with CVX by exchanging heartbeat signals. The heartbeat transmission frequency and timeout period define when communication with CVX will be considered down.

The interval between heartbeat messages that the CVX client transmits is configured by the **heartbeat-interval (Management-CVX)** command.

The CVX client timeout period is specified by the **heartbeat-timeout (Management-CVX)** command. When a CVX client does not receive a subsequent heartbeat message from CVX within this timeout period, the client assumes that services provided by CVX are no longer available.

Best practices dictate that a CVX client's heartbeat interval and heartbeat timeout values are identical to those of the CVX server to which it connects.

#### Example

This command configures a CVX client heartbeat interval of 30 seconds and client timeout period of 90 seconds.

```
switch(config-mgmt-cvx)#heartbeat-interval 30
switch(config-mgmt-cvx)#heartbeat-timeout 90
switch(config-mgmt-cvx)#
```

### Connecting the CVX Client to a Server

---

The **server host (Management-CVX)** command identifies the location of the CVX server that the client accesses. The **source-interface (Management-CVX)** command specifies the interface from which the client derives the IP address it uses as the source in CVX packets that it transmits. And the **no shutdown (Management-CVX)** command enables CVX on the client switch.

### Example

These commands configure the switch as a CVX client, connecting to a CVX server at IP address **10.1.1.14** and using IP address **10.24.24.1** as the source address for its outbound packets.

```
switch(config)#interface loopback 5
switch(config-if-Lo5)#ip address 10.24.24.1/24
switch(config-if-Lo5)#management cvx
switch(config-mgmt-cvx)#server host 10.1.1.14
switch(config-mgmt-cvx)#source-interface loopback 5
switch(config-mgmt-cvx)#no shutdown
switch(config-mgmt-cvx)#
```

## 13.1.5.4 CVX Client Services Configuration

Switches running EOS must be configured as CVX clients to access the network services running on CVX. Individual services may require additional configuration.

Refer to the following for information regarding the services available to a CVX client.

- [Configuring OpenStack Service](#)
- [Configuring VXLAN Control Service](#)
- [Configuring Hardware Switch Controller Service \(HSC\)](#)
- [Configuring Network Topology Service](#)

### 13.1.5.4.1 Configuring OpenStack Service

The OpenStack service is enabled from CVX-OpenStack configuration mode, which is accessed by the **service openstack** command. The **no shutdown (CVX-OpenStack)** command enables CVX OpenStack services on the CVX server. Additional configuration is necessary to deploy OpenStack; <http://docs.openstack.org/>.

#### Example

- These commands enable the CVX-OpenStack service.

```
switch(config-cvx)#service openstack
switch(config-cvx-openstack)#no shutdown
switch(config-cvx-openstack)#
```

### 13.1.5.4.2 Configuring VXLAN Control Service

The VXLAN control service is enabled on CVX by the **no shutdown (CVX-VXLAN)** command and on the client switches by enabling CVX and configuring the VXLAN as a controller client. When VXLAN control service is enabled, CVX functions as a VXLAN controller for its clients.

For information about configuring VXLAN on the client switch, see the VXLAN chapter of the *User Manual*.

#### Examples

- These commands enable VXLAN control service on the CVX server.

```
switch(config-cvx)#service vxlan
switch(config-cvx-vxlan)#no shutdown
```

```
switch(config-cvx-vxlan) #
```

- These commands enable VXLAN Control Service on the CVX client. (This example assumes that the VXLAN has already been configured on the client switch. For information about configuring VXLAN, see the VXLAN chapter of the *User Manual*).

```
switch(config) #interface vxlan 1
switch(config-if-Vx1) #vxlan controller-client
```

### 13.1.5.4.3 Configuring Hardware Switch Controller Service (HSC)

The hardware switch controller (HSC) service is enabled on the CVX server by the `no shutdown (CVX-HSC)` command.

#### Certificate Requirements for CVX Interoperability with VMware NSX 6.2.2 and higher

The certificate type needs to be changed from MD5 to SHA512 for use with VMware NSX 6.2.2. Complete the following steps to make the change.

1. At the EOS prompt of CVX, use the following commands.

```
switch(config) #cvx
switch(config-cvx) #service hsc
switch(config-cvx-hsc) #shut
```

2. Acquire superuser privileges and edit the default.

```
switch(config) #bash
switch(config) #sudo su
switch(config) #vi /usr/bin/ovs-pki
```

3. Find and replace **default\_md** with **sha512** (from **md5**).

```
default_md =md5
default_md =sha512
```

4. Delete all files and folders from `/persist/secure/openvswitch/`.

```
cd /persist/secure/openvswitch/
bash-4.1#sudo rm -r *
```

5. Generate the new certificate.

```
[admin@CVX ~]$ exit
logout
CVX(config-cvx-hsc) #no sh
CVX(config-cvx-hsc) #end
```

6. Verify the change using the command:

```
CVX#show nsx status
```

#### Example

These commands enable the CVX-HSC service.

```
switch(config) #cvx
switch(config-cvx) #no shutdown
switch(config-cvx) #service hsc
```

```
switch(config-cvx-hsc)#no shutdown
```

The HSC service sends flood lists to each VTEP through CVX. Some controllers (such as VMware NSX's Service Nodes) implement replication nodes for head-end replication of unknown packets. For these controllers, BUM packets should be sent to a single replication node (send-to-any replication), and the flood list sent by the HSC service is a list of replication nodes. Other controllers (such as Nuage VSP) require each VTEP to perform its own head-end replication. For these, BUM packets should be sent to every known VTEP, and the flood list sent by the HSC service is the list of VTEPs.

The default behavior is to use a send-to-any replication list of VTEPs. If the required behavior is send-to-all replication of, use the all option of the `vtep (CVX-HSC)` command.

### Example

This command configures the CVX-HSC service to use send-to-any replication.

```
switch(config-cvx-hsc)#vtep flood list type all
switch(config-cvx-hsc)#
```

 **Note:** HSC also makes use of the VXLAN control service; ensure that VXLAN control service is enabled and properly configured (see [VXLAN Control Service](#) for details).

HSC also requires a connection to an OVSDB controller. Configure the IP address or host name of the controller using the `manager` command.

### Example

This command configures the CVX-HSC service to connect to an OVSDB controller at IP address **192.168.2.5**, using the default port **6632**.

```
switch(config-cvx-hsc)#manager 192.163.2.5
switch(config-cvx-hsc)#
```

Having established a connection to the OVSDB controller, the HSC service will publish the inventory of switches managed by CVX to OVSDB. For the inventory to succeed, LLDP must be enabled on each CVX client switch with the `lldp run` command.

 **Note:** LLDP is enabled by default on Arista switches.

### Example

This command enables LLDP.

```
switch(config)#lldp run
switch(config)#
```

#### 13.1.5.4.4 Configuring Network Topology Service

A network topology agent runs on each Arista switch whether or not the switch is connected to a CVX server. It requires no configuration. The network topology service on the CVX server is also enabled by default and requires no configuration.

To view the aggregated topology information, use the `show network physical-topology` command on the switch running the CVX server instance.

### Examples

- This command displays all visible hosts.

```
switch#show network physical-topology hosts
Unique Id Hostname
```

```

001c.7385.be69 cvx287.sjc.aristanetworks.com
0000.6401.0000 cvc1
0000.6402.0000 cvc2
0000.6403.0000 cvc3
0000.6404.0000 cvc4
bcf6.85bd.8050 dsj14-rack14-tor1
```

- This command displays all connections in the topology.

```
switch#show network physical-topology neighbors
cvx287.sjc.aristanetworks.com
Interface Neighbor Intf Neighbor Host

Ethernet1 Ethernet7 cvc4
Ethernet2 Ethernet7 cvc2
Ethernet9 Ethernet7 cvc1
Ethernet10 Ethernet7 cvc3
Management1 27 dsj14-rack14-tor1

OUTPUT OMITTED FROM EXAMPLE
 dsj14-rack14-tor1

Interface Neighbor Intf Neighbor Host

27 Management1 cvx287.sjc.aristanetwork
```

### 13.1.6 CVX Secure out-of-band Connection

This feature adds support for securing out-of-band connection between CVX server and CVX clients by SSL/TLS transport protocol. SSL/TLS is an application-layer protocol that provides secure transport between client and server through a combination of authentication, encryption and data integrity. SSL/TLS uses certificates and private-public key pairs to provide this security. We will use the term SSL to mean SSL/TLS.

By default, CVX server and CVX clients communicate over insecure transport (there is no authentication and encryption between CVX server and CVX clients). This poses the possibility of security risks, such as communicating with untrusted CVX server and CVX clients, or eavesdropping CVX server/client communications. This feature can be used to secure the out-of-band connection between CVX server and CVX clients.

 **Note:** The CVX client-server out-of-band connection uses port 50003. The CVX cluster peer out-of-band connection uses port 50004. These are TCP ports.

For more information, see:

- [Configuring the CVX Secure out-of-band Connection](#)
- [Show Commands](#)

#### 13.1.6.1 Configuring the CVX Secure out-of-band Connection

This feature uses SSL certificate and key management infrastructure for managing certificates, keys and SSL profiles. For more information regarding this infrastructure see *SSL Certificate and Key Management* in the *Arista Users Guide*.

1. On CVX server, copy the server certificate and key and also the CA certificate to verify CVX clients.

```
switch(config)#!Copy the PEM encoded certificate and RSA key files for
CVX server
switch(config)#!Lets call them server.crt and server.key
switch(config)#copy <url> certificate:server.crt
```

```
switch(config)#copy <url> sslkey:server.key
switch(config)#!Copy the PEM encoded CA certificate to verify the
certificate of CVX clients.Lets call it ca.crt
switch(config)#copy <url> certificate:ca.crt
```

2. On CVX server, configure SSL profile with the certificates and key as below. Lets call the SSL profile as serverssl.

```
switch(config)#management security
switch(config-mgmt-security)#ssl profile serverssl
switch(config-mgmt-sec-ssl-profile-serverssl)#certificate server.crt
key server.key
switch(config-mgmt-sec-ssl-profile-serverssl)#!You can trust multiple
CA certificates
switch(config-mgmt-sec-ssl-profile-serverssl)#trust certificate ca.crt
```



**Note:** If you are using intermediate certificates to build a 'Chain of Trust' (such as **server.crt -> intermediate1.crt -> intermediate2.crt -> ca.crt**), then you need to configure the intermediate certificates as part of the SSL profile using the following commands:

```
switch(config-mgmt-sec-ssl-profile-serverssl)#chain certificate
intermediate1.crt
switch(config-mgmt-sec-ssl-profile-serverssl)#chain certificate
intermediate2.crt
```

3. On CVX server, configure to use the serverssl SSL profile. With this configuration, the CVX server starts listening on a secure port. The CVX server will continue to listen on the default port. i.e., the CVX server will accept connections from CVX clients over both SSL and default non-SSL transports. During a SSL negotiation, the CVX server will authenticate itself to the CVX clients by presenting server.crt and it verifies the authenticity of the CVX client by checking if the CVX client certificate is signed by the trusted certificate ca.crt.

```
switch(config)#cvx
switch(config-cvx)#ssl profile serverssl
```

4. On CVX client, copy the client certificate and key and also the CA certificate to verify CVX server.

```
switch(config)#!Copy PEM encoded certificate and RSA key files for CVX
client
switch(config)#!Lets call them client.crt and client.key
switch(config)#copy <url> certificate:client.crt
switch(config)#copy <url> sslkey:client.key
switch(config)#!Copy PEM encoded CA certificate used to verify the
switch(config)#!certificate of CVX server. Lets call it ca.crt
switch(config)#copy <url> certificate:ca.crt
```



**Note:** If you are using intermediate certificates to build a 'Chain of Trust' (such as **client.crt -> intermediate1.crt -> intermediate2.crt -> ca.crt**), then you need to configure the intermediate certificates as part of the SSL profile using the following commands:

```
switch(config-mgmt-sec-ssl-profile-clientssl)#chain certificate
intermediate1.crt
switch(config-mgmt-sec-ssl-profile-clientssl)#chain certificate
intermediate2.crt
```

5. On CVX client, configure SSL profile with the certificates and key as below. Lets call the SSL profile as clientssl.

```
switch(config)#management security
switch(config-mgmt-security)#ssl profile clientssl
```



```
switch(config-mgmt-sec-ssl-profile-clientssl)#certificate client.crt
key client.key
switch(config-mgmt-sec-ssl-profile-clientssl)#!You can trust multiple
CA certificates
switch(config-mgmt-sec-ssl-profile-clientssl)#trust certificate ca.crt
```

6. On CVX client, configure to use the SSL profile clientssl. With this configuration, the CVX client will connect to the secure port of the CVX server over SSL transport. During SSL negotiation, the CVX client will authenticate itself to the CVX server by presenting client.crt and it verifies the authenticity of the CVX server by checking if the CVX server certificate is signed by the trusted certificate ca.crt.

```
switch(config)#management cvx
switch(config-mgmt-cvx)#ssl profile clientssl
```

### 13.1.6.2 Show Commands

For information regarding show commands of SSL certificate, key and profile, please refer to *SSL Certificate and Key Management*.

To show the SSL profile status on CVX server, use the **show cvx** command.

```
switch#show cvx

CVX Server
Status: Enabled
UUID: bebl9142-dfaa-11e4-b996-001c73105347
Heartbeat interval: 20.0
Heartbeat timeout: 60.0
SSL profile: serverssl
Status: Enabled
```

The Enabled SSL status means that the SSL profile is enabled for CVX server and the CVX clients can connect to CVX server over SSL transport. If there are any errors, then the status will show Disabled and the reason will be listed. In Disabled state, the CVX clients won't be able to connect to CVX server over SSL transport.

To show the SSL connection status of CVX clients on CVX server, use the **show cvx connections** command.

```
switch#show cvx connections

Switch 00:1c:73:10:53:48
Hostname: sq302
Status: up
Last heartbeat sent: 0:00:04 ago
Last heartbeat received: 0:00:10 ago
Clock offset: -0.00201620385865
Out-of-band connection: SSL secured
In-band connection: Not secured (SSL not supported)
```

The out-of-band connection shows as SSL secured, which means that the CVX client has connected to CVX server over SSL transport. The in-band connection is another connection between CVX server and CVX client. The SSL is not yet supported for this connection and hence it shows as SSL not supported. There is already some level of protection for the in-band connection. The CVX server and CVX client opens up the access to in-band connection only if the out-of-band connection is successful. Since the out-of-band connection is configured to use SSL, the in-band connection access is granted only for authentic CVX client and CVX server.

---

To show SSL profile status and connection status on CVX client, use the `show management cvx` command.

```
switch#show management cvx

CVX Client
Status: Enabled
Last connected time: 2015-04-14 11:16:19
Connection status: Connected
 Out-of-band connection: SSL secured
 In-band connection: Not secured (SSL not supported)
Negotiated version: 2
Controller UUID: 0e7dee2e-e2cf-11e4-880f-001c73105347
Controller: 127.0.0.1
Last heartbeat sent: 0:00:00 ago
Last heartbeat received: never
Clock offset: 0.0
SSL profile: clientssl
Status: Enabled
```

The Enabled SSL status means that the SSL profile is enabled and the CVX client can connect to CVX server over SSL transport. If there are any errors, then the status will show as Disabled and the reason will be listed. In Disabled state, the CVX client won't be able to connect to the CVX server.

Similar to the CVX server, the out-of-band connection shows as SSL secured and the SSL is not yet supported for in-band connection.

The possible reasons for Disabled SSL status on CVX server and CVX client are:

- **SSL profile does not exist:** If the SSL profile configured under CVX server/client is not configured under management security, you will see this message. Configure the SSL profile with required certificates and key under management security.
- **Invalid SSL profile:** If the SSL profile configured under CVX server/client is in invalid state, you will see this message. Check `show management security ssl profile <name>` command to see the errors on the SSL profile and fix them.
- **Trusted certificates not configured in SSL profile:** If the SSL profile configured under CVX server/client does not have trusted certificates configured, you will see this message. Please configure trusted CA certificates in the SSL profile.
- **Certificate not configured in SSL profile:** If the SSL profile configured under CVX server/client does not have certificate key pair configured, you will see this message. Please configure certificate and key pair in the SSL profile.

**Diffie-Hellman parameters not yet ready:** When EOS is booted, a Diffie-Hellman parameters file is auto generated by the system if one does not exist. This Diffie-Hellman parameters file is used for symmetric key exchange during SSL negotiation. Only the CVX server uses this file and hence this message can be seen only on `show cvx` command output. If the file is not yet generated, you will see this message. When the file is ready, this message automatically goes away and the SSL profile will become Enabled.

### 13.1.7 CVX High Availability

CVX provides high availability by enabling you to use multiple (redundant) CVX Controllers in the same cluster. Each Controller in the cluster has its own dedicated machine so that if a Controller fails, the failure is isolated to a single machine.

Within a cluster, one of the Controllers is a primary (leader), and the other Controllers are backup (follower) Controllers. If the primary Controller fails, one of the backup Controllers automatically assumes the role of the primary Controller.

CVX high availability does not prevent or compromise the detection of software failures or link failures that may cause Controllers to be unreachable on the network.

The configuration that is required to ensure CVX is set up for high availability involves:

- [Configuring the CVX cluster.](#)
- [Configuring the CVX clients.](#)

For more information, see:

- [CVX Clusters](#)
- [Handling of CVX Controller Failures](#)
- [CVX Support for EOS Failure Modes](#)
- [Client Interaction](#)
- [Service Agents Interaction](#)
- [Leader Election](#)
- [Configuring CVX Clusters for High Availability](#)
- [Configuring CVX Clients for High Availability](#)

### 13.1.7.1 CVX Clusters

CVX clusters are sets of CVX Controllers (usually 3 Controllers). Within a cluster, each Controller runs on its own dedicated machine, and all of the Controllers run the same version of CVX. Each Controller in the cluster functions as either the primary (leader) Controller, or a backup (follower) Controller.

One of the CVX Controllers is elected by the group of Controllers to be the primary Controller. Once a Controller is elected to be the primary, the other Controllers in the cluster are automatically assigned the role of backup Controllers. Cluster members maintain an out-of-band connection amongst themselves, which is used for the leader election protocol.

CVX Controllers in a cluster that are not the primary Controller always function as backup Controllers. Within the same cluster, only one CVX Controller can assume the role of a primary at any time.

For more information, see:

- [Required Number of Controllers to Support High Availability](#)
- [Cluster Configuration Options](#)

#### 13.1.7.1.1 Required Number of Controllers to Support High Availability

A cluster must have enough Controllers so that in the case of a failure of the primary Controller, there are enough remaining Controllers for the election process to be completed. The election process is used by clusters to select a new primary Controller in the case of failure.

 **Note:** The number of Controllers for a cluster is **3** (one primary and two backup Controllers).

#### Examples

In a cluster with only **two** Controllers (one primary and one backup), a simple majority of backup Controllers does not exist after a failure of the primary Controller. A simple majority of two backup Controllers is required for the leader election process.

Related Topics

- [Cluster Configuration Options](#)
- [Handling of CVX Controller Failures](#)
- [CVX Support for EOS Failure Modes](#)
- [Client Interaction](#)
- [Service Agents Interaction](#)
- [Leader Election](#)

#### 13.1.7.1.2 Cluster Configuration Options

---

You can configure the cluster for high availability using either of the following modes:

- Cold followers mode - Only the Controllerdb of the primary (leader) CVX Controller mounts from the client switches.
- Warm followers mode - The Controllerdb of every (all) CVX Controllers in the cluster mount from the client switches.

#### **Advantages and disadvantages of the modes**

The advantage of the warm follower mode is that if the primary CVX Controller fails, the switchover to the new primary is faster than a switchover in cold follower mode. The reason for this is that the state of the new primary does not have to be rebuilt from scratch. The disadvantage of the warm follower mode is that serialization from the switch is slower compared to cold follower mode.

#### **Related Topics**

- [Required Number of Controllers to Support High Availability](#)
- [Handling of CVX Controller Failures](#)
- [CVX Support for EOS Failure Modes](#)
- [Client Interaction](#)
- [Service Agents Interaction](#)
- [Leader Election](#)

### **13.1.7.2 Handling of CVX Controller Failures**

CVX Controllers can fail because of hardware or software faults. Because EOS agents are designed to be software fault-tolerant, an agent that fails is automatically restarted and resumes operation statefully. The most recent saved state in Sysdb for the agent is used to restore the state of the agent.

Unlike software failures, hardware failures are not handled by EOS. CVX handles hardware failures through the use of redundant backup (follower) CVX Controllers that run on their own dedicated machine. Within a cluster, any backup Controller can assume the role of the primary (leader) Controller.

 **Note:** In the event of a network partition, the partition with a majority of the Controllers elects a leader from its Controllers, and the minority partition relinquishes any leadership it might have had.

#### **Related Topics**

- [CVX Clusters](#)
- [CVX Support for EOS Failure Modes](#)
- [Client Interaction](#)
- [Service Agents Interaction](#)
- [Leader Election](#)

### **13.1.7.3 CVX Support for EOS Failure Modes**

CVX supports both EOS failure modes that apply when a CVX Controller fails. The EOS failure modes are:

- Fail-stop
- Fail-recover

Because CVX supports both EOS failure modes, a failed CVX Controller can rejoin the cluster if the following failures occur:

- A crash of the agent or machine running CVX.
- The CVX controller or dedicated machine it runs on is removed (partitioned) from the cluster.

#### **Related Topics**

- [Handling of CVX Controller Failures](#)
- [CVX Clusters](#)
- [Client Interaction](#)
- [Service Agents Interaction](#)
- [Leader Election](#)

#### 13.1.7.4 Client Interaction

Client switches maintain an out-of-band connection to all members of the cluster. The connection is used to determine liveness and for communications. The connection is also used to signal a change in leadership (switchover) to the client switches. Switchovers that are changes in leadership within a cluster are executed similarly to CVX Graceful Reboot switchovers.

The ControllerClient agent on the switch is responsible for maintaining liveness with the Controllers and for exchanging metadata. The ControllerClient agent registers with all cluster members. Each Controller's ControllerStatus has an additional flag to record whether the Controller is a leader within the cluster.

If there is more than one leader, the switch automatically waits until only one Controller is designated as the leader in the cluster. Once a single Controller is designated as the leader, the switch executes a graceful switchover to the new leader Controller.

##### Related Topics

- [Handling of CVX Controller Failures](#)
- [CVX Clusters](#)
- [CVX Support for EOS Failure Modes](#)
- [Client Interaction](#)
- [Service Agents Interaction](#)
- [Leader Election](#)

#### 13.1.7.5 Service Agents Interaction

One change to Service Agents is required to support CVX high availability. Service Agents must be modified to include the leader flag (this flag identifies the leader CVX Controller in the cluster). On a leader switchover, Service Agents are deactivated on the old leader Controller and activated on the new leader Controller. The client switches will perform a graceful switchover to the new leader Controller.

##### Related Topics

- [Handling of CVX Controller Failures](#)
- [CVX Clusters](#)
- [CVX Support for EOS Failure Modes](#)
- [Client Interaction](#)
- [Leader Election](#)

#### 13.1.7.6 Leader Election

Leader election is an internal, system-run process that is essential to CVX high availability. The leader election process is used to safely elect a new leader Controller within a cluster following the failure of the current leader Controller, or a network configuration change that results in the loss of the current leader Controller in the cluster.

The leader election process is designed to ensure stability of leader Controllers within clusters. The process is based on an algorithm that provides the mechanism for the backup (follower) Controllers to elect (by consensus), the new leader Controller in the cluster.

### 13.1.7.7 Configuring CVX Clusters for High Availability

Configuring CVX clusters for high availability is a simple process that involves pointing each cluster member to the other cluster members using the peer host command. The objective of this task is to successfully register each cluster member with the other cluster members. Successful registration of the cluster members with each other ensures that the members can communicate with each other to elect a new leader member if the original leader member fails.

Once you complete the process, the cluster members will be successfully registered with each other. In addition, the cluster members will automatically elect a leader member and assign the leader to that member. The non-leader members are automatically assigned the role of follower.

#### Requirements

The requirements for setting up clusters for high availability are:

- The number of CVX Controllers in a cluster is **3**.
- An **odd number** of CVX instances (CVX Controllers) are required to form a cluster.

 **Note:** If an even number of CVX Controllers are configured in a cluster, a CVX instance will automatically refuse to participate in the cluster.

- All cluster members must point to each other. This is essential for clusters to operate normally. (The steps required to complete this task are included in the following procedure.)

#### Procedure

 **Note:** This procedure provides configuration examples for each step. The example cluster used throughout the procedure contains 3 cluster members (named *cvx1*, *cvx2*, and *cvx3*). The IP addresses of the cluster members are:

- *cvx1* (10.0.0.1)
- *cvx2* (10.0.0.2)
- *cvx3* (10.0.0.3).

Complete the following steps to configure clusters for high availability.

1. Using the peer host command, configure one of the cluster members to point to every other cluster member.

This example shows the configuration of cluster member **cvx1** to point to the other cluster members (*cvx2* and *cvx3*).

```
cvx1(config-cvx)#peer host 10.0.0.2 (connects cvx1 to cvx2)
cvx1(config-cvx)#peer host 10.0.0.3 (connects cvx1 to cvx3)
```

2. Use the `sh cvx` command to check the **Mode** and **Peer registration state** status values for cluster member *cvx1*. The status values should be:

- **Mode** = *Cluster*
- **Peer registration state** = *Connecting*

 **Note:** **Mode** automatically changes from Standalone to Cluster when configuring a CVX cluster. This is because the presence of multiple CVX peers causes the Mode to change to Cluster.

**Peer registration state** remains in Connecting status after you configure the first cluster member. This is because the two peers must register with each other for the registration of the two members to be successful.

- Using the `peer host` command, configure peer cluster member `cvx2` to point to every other cluster member.

This example shows the configuration of cluster member `cvx2` to point to the other cluster members (`cvx1` and `cvx3`).

```
cvx2(config-cvx)#peer host 10.0.0.1 (connects cvx2 to cvx1)
cvx2(config-cvx)#peer host 10.0.0.3 (connects cvx2 to cvx3)
```

- Use the `sh cvx` command to check the **Peer registration state** settings for `cvx1`. This is done to verify that peers `cvx1` and `cvx2` are successfully registered with each other.

```
cvx1(config-cvx)#sh cvx
```

### Example

This example shows the output of the `sh cvx` command for `cvx1`. The **Peer registration state** setting of Registration Complete for peer `cvx2` indicates a successful registration between `cvx1` and `cvx2`.

```
cvx1(config-cvx)#sh cvx

CVX Server
 Status: Enabled
 UUID: 6c208fba-7324-11e5-8fef-1d98cdd3b27a
 Mode: Cluster
 Heartbeat interval: 20.0
 Heartbeat timeout: 60.0
 Cluster Status
 Name: default
 Role: Standby
 Leader: 10.0.0.2
 Peer timeout: 10.0
 Last leader switchover timestamp: 0:00:03 ago
 Peer Status for 10.0.0.3
 Peer registration state: Connecting
 Peer service version compatibility : Version mismatch
 Peer Status for 10.0.0.2
 Peer Id : 02-01-63-02-00-00
 Peer registration state: Registration complete
 Peer service version compatibility : Version ok
```

- Using the `peer host` command, configure peer cluster member `cvx3` to point to every other cluster member.

This example shows the configuration of cluster member `cvx3` to point to the other cluster members (`cvx1` and `cvx2`).

```
cvx3(config-cvx)#peer host 10.0.0.1 (connects cvx3 to cvx1)
cvx3(config-cvx)#peer host 10.0.0.2 (connects cvx3 to cvx2)
```

6. Use the `sh cvx` command to check the **Peer registration state** settings for `cvx1`. This is done to verify that peers `cvx1` and `cvx3` are successfully registered with each other.

```
cvx1(config-cvx)#sh cvx
```

### Example

This example shows the output of the `sh cvx` command for `cvx1`. The **Peer registration state** setting of Registration Complete for peer `cvx3` indicates a successful registration between `cvx1` and `cvx3`.

```
cvx1(config-cvx)#sh cvx

CVX Server
 Status: Enabled
 UUID: 6c208fba-7324-11e5-8fef-1d98cdd3b27a
 Mode: Cluster
 Heartbeat interval: 20.0
 Heartbeat timeout: 60.0
Cluster Status
 Name: default
 Role: Standby
 Leader: 10.0.0.2
 Peer timeout: 10.0
 Last leader switchover timestamp: 0:05:37 ago
 Peer Status for 10.0.0.3
 Peer Id : 02-01-63-03-00-00
 Peer registration state: Registration complete
 Peer service version compatibility : Version ok
 Peer Status for 10.0.0.2
 Peer Id : 02-01-63-02-00-00
 Peer registration state: Registration complete
 Peer service version compatibility : Version ok
```

### Next Step

You are now ready to configure the CVX clients for high availability (see [Configuring CVX Clients for High Availability](#)).

## 13.1.7.8 Configuring CVX Clients for High Availability

Configuring CVX clients for high availability is a simple process that involves pointing each CVX client to every CVX cluster member using the server host command. The objective of this task is to successfully establish connections between each CVX client and every CVX cluster member. The connections are essential to ensure that the CVX clients are aware of the current status of each cluster member.



**Note:** If a CVX client is not pointing to every cluster member, or if it is pointing to a CVX instance (Controller) that is not part of the cluster, the client may not be aware of leadership changes in the cluster, or may become confused about which cluster member is currently the leader. Either of these scenarios can result in unexpected errors.

Once you complete the process, the CVX clients will have established connections with each cluster member (the Connection status for each Controller should be Established). In addition, the clients will be aware of which CVX instance (Controller) is currently the leader in the cluster.

### Procedure



**Note:** This procedure provides configuration examples for each step. The example CVX client used throughout the procedure is named `cvc1`. The IP addresses of the cluster members are `10.0.0.1` (`cvx1`), `10.0.0.2` (`cvx2`), and `10.0.0.3` (`cvx3`).



Complete the following steps to configure CVX clients for high availability.

1. Using the server host command, configure each of the CVX clients to point to every cluster member.

This example shows the configuration of client **cvc1** to point to all of the cluster members (the addresses of the cluster members are *10.0.0.1*, *10.0.0.2*, and *10.0.0.3*).

```
cvcl1(config-mgmt-cvx)#server host 10.0.0.1 (connects cvcl1 to cluster
member 10.0.0.1)
cvcl1(config-mgmt-cvx)#server host 10.0.0.2 (connects cvcl1 to cluster
member 10.0.0.2)
cvcl1(config-mgmt-cvx)#server host 10.0.0.3 (connects cvcl1 to cluster
member 10.0.0.3)
```

2. Use the sh man cvx command to check the status of client **cvc1**.

The Connection status for each cluster member should be Established. In addition, the client is also aware that cluster member *10.0.0.3* is the current Master.

```
cvcl1(config-mgmt-cvx)#sh man cvx

CVX Client
Status: Enabled
Source interface: Inactive (Not configured)
Controller cluster name: default
Controller status for 10.0.0.1
Connection status: established
 Out-of-band connection: Not secured
 In-band connection: Not secured (SSL not supported)
Negotiated version: 2
Controller UUID: 6c208fba-7324-11e5-8fef-1d98cdd3b27a
Last heartbeat sent: 0:00:07 ago
Last heartbeat received: 0:00:07 ago
Controller status for 10.0.0.3
Master since 0:03:34 ago
Connection status: established
 Out-of-band connection: Not secured
 In-band connection: Not secured (SSL not supported)
Negotiated version: 2
Controller UUID: c64954b8-7324-11e5-9f33-51f8b016cae8
Last heartbeat sent: 0:00:14 ago
Last heartbeat received: 0:00:14 ago
Controller status for 10.0.0.2
Connection status: established
 Out-of-band connection: Not secured
 In-band connection: Not secured (SSL not supported)
Negotiated version: 2
Controller UUID: 6a0dbf2c-7324-11e5-94f3-ff17a8a1cdc8
Last heartbeat sent: 0:00:05 ago
Last heartbeat received: 0:00:05 ago
```

### 13.1.8 CVX VIP

CVX VIP provides the virtual IP address that actively follows the master controller of the CVX cluster.

The virtual IP address of the CVX HA Cluster is configured on a macvlan interface setup on top of a physical management interface of the master controller. The virtual IP and virtual MAC needs to be provided by the customer as part of the controller configuration. This information is available to all controllers as each cluster member has to be configured manually by the user on all controllers.

---

The macvlan interface created should be designated as ``Management0``. ``Management0`` is currently used for the ManagementActive interface on modular switches. Without explicit configuration of VIP and VMAC, CVX VIP functionality will not work in the CVX HA cluster.

Customers can pick the VMAC from a pool of MAC addresses reserved for use with CVX clusters. The OUI pool, 00:1C:73:00:00:AA – 00:1C:73:00:00:FF has been reserved for this purpose.

The macvlan interface is setup if all of the following conditions are met:

- VMAC is configured by the user
- The controller instance is a leader
- There are more than one controller instances
- The controller is not being run on a modular system
- [CVX VIP](#)
- [Data Replication](#)
- [SSH Host Key Tagging](#)

### 13.1.8.1 Configuring VIP

All CLI commands applicable to the management interface of the controller will be allowed on ``Management0``, with the exception of Layer 1 / phy level commands. So auto-negotiation or flow control cannot be configured on the ``Management0`` interface. Instead these commands can only be run on the physical management interfaces. This makes sense as the phy-level configuration really depends on what the interface is physically wire.

To configure VMAC/VIP

```
CVX(config)#interface management 0
CVX(config-if-Ma0)# mac-address 00:1C:72:00:00:FF
CVX(config-if-Ma0)# ip address 10.0.0.2
```

### 13.1.8.2 Data Replication

At EOS boot time, SSH host keys and Diffie-Hellman parameters are automatically generated and persistently stored on each controller. Multiple SSL profiles / keys / certificates might also be created and used by various agents on the controllers. Since these information contribute to the identity of the master, they will need to follow the master controller for all time.

In case of a controller switchover, the newly elected master controller will need to use the same SSH host keys & SSL profiles / keys / certificates to retain its identity and prevent any kind of network security alarms from being tripped. For example, if an SSH client notices that the host key has changed, it will normally flag an error warning the user of a possible man-in-the-middle type attack. Hence, this data will be replicated from the master to slaves.

### 13.1.8.3 SSH Host Key Tagging

SSH host keys are tagged with the chassis MAC address to deal with key regeneration issues when a supervisor module is moved from one chassis to another. This behavior will cause regeneration issues if we replicate the SSH host keys across the cluster resulting in the key fingerprint seen by management tools to be different.

To mitigate this, in addition to the chassis MAC address, the host keys would now be tagged with VMAC of the CVX HA cluster. If CVX VIP and VMAC are configured, SshHostKeysAgent will not regenerate keys if tagged VMAC and configured VMAC are the same, even if there is a mismatch between the chassis MAC and tagged MAC.

## 13.1.9 CVX Command Descriptions

### CVX Server Commands

- [cvx](#)
- [heartbeat-interval \(CVX\)](#)
- [heartbeat-timeout \(CVX\)](#)
- [port \(CVX\)](#)
- [show cvx](#)
- [shutdown \(CVX\)](#)

### CVX Client Commands

- [management cvx](#)
- [heartbeat-interval \(Management-CVX\)](#)
- [heartbeat-timeout \(Management-CVX\)](#)
- [server host \(Management-CVX\)](#)
- [source-interface \(Management-CVX\)](#)
- [shutdown \(Management-CVX\)](#)

### CVX OpenStack Commands

- [name-resolution force \(CVX-OpenStack\)](#)
- [name-resolution interval \(CVX-OpenStack\)](#)
- [service openstack](#)
- [shutdown \(CVX-OpenStack\)](#)

### CVX VXLAN Control Service Commands

- [resync-period](#)
- [service vxlan](#)
- [shutdown \(CVX-VXLAN\)](#)
- [vtep \(CVX-VXLAN\)](#)

### CVX Hardware Switch Controller (HSC) Commands

- [manager](#)
- [ovsdb-shutdown](#)
- [shutdown \(CVX-HSC\)](#)
- [vtep \(CVX-HSC\)](#)

### CVX Network Topology Service Commands

- [lldp run](#)
- [show network physical-topology](#)

### Related Topics

- [CVX Overview](#)
- [CVX Services](#)
- [Deploying CVX](#)
- [CVX Configuration](#)
- [CVX Secure out-of-band Connection](#)
- [CVX High Availability](#)

---

### 13.1.9.1 cvx

CVX (CloudVision eXtension) aggregates and shares status across a network of physical switches running EOS. CVX services provide visibility and coordinate activities across a network of switches that are configured as CVX clients.

The **cvx** command enters CVX configuration mode. CVX configuration mode is not a group-change mode; **running-config** is changed immediately upon entering commands. Exiting CVX configuration mode does not affect **running-config**. The **exit** command returns the switch to global configuration mode.

The **no cvx** and **default cvx** commands restore all CVX server defaults by deleting all CVX configuration mode statements from running-config.

#### Command Mode

Global Configuration

#### Command Syntax

```
cvx
no cvx
default cvx
```

#### Commands Available in CVX Configuration Mode

- port (CVX)
- service openstack
- service vxlan
- shutdown (CVX)
- heartbeat-interval (CVX)
- heartbeat-timeout (CVX)

#### Example

- These commands enter CVX-configuration mode and display the CVX configuration.

```
switch(config)#cvx
switch(config-cvx)#show active all

cvx
 shutdown
 port 9979
 heartbeat-interval 20
 heartbeat-timeout 60
 no service vxlan
 service openstack
 shutdown
 name-resolution interval 21600
switch(config-cvx)#
```

### 13.1.9.2 heartbeat-interval (CVX)

The **heartbeat-interval** command configures the interval between heartbeat messages that the switch sends as a CVX server. Heartbeat messages are part of the keepalive mechanism between CVX and the CVX clients to which it connects.

The **no heartbeat-interval** and **default heartbeat-interval** commands restore the heartbeat interval to the default setting by removing the **heartbeat-interval** command from **running-config**.

#### Command Mode

CVX Configuration

#### Command Syntax

```
heartbeat-interval period
no heartbeat-interval
default heartbeat-interval
```

#### Parameters

- **period** Interval duration (seconds). Value ranges from 5 through 60. Default value is 20.

#### Related Commands

- **cvx**
- **heartbeat-timeout (CVX)**

#### Guidelines

Heartbeat messages flow independently in both directions between CVX and clients. When a client stops receiving heartbeat messages from the server within a specified period, the client assumes that the CVX server is no longer functioning.

Best practices dictate that CVX and its client applications configure identical heartbeat interval values.

#### Examples

- This command configures a CVX server heartbeat interval of 30 seconds:

```
switch(config)#cvx
switch(config-cvx)#heartbeat-interval 30
switch(config-cvx)#
```

---

### 13.1.9.3 heartbeat-interval (Management-CVX)

The `heartbeat-interval` command configures the interval between heartbeat messages that the switch sends as a CVX client. Heartbeat messages are part of the keepalive mechanism between the CVX client and the CVX server to which it connects.

The `no heartbeat-interval` and `default heartbeat-interval` commands revert the heartbeat interval to the default setting by removing the `heartbeat-interval` command from *running-config*.

#### Command Mode

Mgmt-CVX Configuration

#### Command Syntax

```
heartbeat-interval period
no heartbeat-interval
default heartbeat-interval
```

#### Parameters

period: Interval duration (seconds). Value ranges from 5 through 60. Default value is 20.

#### Guidelines

Heartbeat messages flow independently in both directions between CVX and clients. When the server stops receiving heartbeat messages from a client within a specified period, the server assumes that the device it is no longer functioning as a CVX client.

Best practices dictate that the CVX client's heartbeat interval value is identical to that of its CVX server.

#### Related Commands

- [management cvx](#) places the switch in **Mgmt-CVX configuration** mode.
- [heartbeat-timeout \(Management-CVX\)](#) specifies the CVX client timeout interval.

#### Example

These commands configure a CVX client heartbeat interval of 30 seconds:

```
switch(config)#management cvx
switch(config-mgmt-cvx)#heartbeat-interval 30
switch(config-mgmt-cvx)#
```

### 13.1.9.4 heartbeat-timeout (CVX)

The `heartbeat-timeout` command specifies the CVX timeout period. When a CVX server does not receive consecutive heartbeat messages from a CVX client within the heartbeat timeout period, the server discontinues providing CVX services to the client device. The default timeout period is 60 seconds.

The `no heartbeat-timeout` and `default heartbeat-timeout-timeout` commands restore the heartbeat timeout to the default setting by removing the `heartbeat-timeout` command from running-config.

#### Command Mode

CVX Configuration

#### Command Syntax

```
heartbeat-timeout period
```

```
no heartbeat-timeout
```

```
default heartbeat-timeout
```

#### Related Commands

- `cvx` places the switch in CVX configuration mode.
- `heartbeat-interval (CVX)` specifies the CVX heartbeat interval.

#### Parameters

- `period`: heartbeat timeout interval (seconds). Value ranges from 15 to 10800. Default value is 60.

#### Guidelines

Best practices dictate that CVX and its client applications configure identical heartbeat timeout values.

#### Examples

- These commands set the CVX timeout period to 90 seconds.

```
switch(config)#cvx
switch(config-cvx)#heartbeat-timeout 90
switch(config-cvx)#
```

---

### 13.1.9.5 heartbeat-timeout (Management-CVX)

The `heartbeat-timeout` command specifies the CVX client timeout period. When a CVX client does not receive consecutive heartbeat messages from a CVX server within the period specified by this command, the client assumes that its connection to CVX is disrupted. The default timeout period is 60 seconds.

The `no heartbeat-timeout` and `default heartbeat-timeout` commands restore the CVX client heartbeat timeout to the default setting by removing the `heartbeat-timeout` command from *running-config*.

#### Command Mode

Mgmt-CVX Configuration

#### Command Syntax

```
heartbeat-timeout period
no heartbeat-timeout
default heartbeat-timeout
```

#### Parameters

period: heartbeat timeout interval (seconds). Value ranges from 15 to 10800. Default value is 60

#### Guidelines

Best practices dictate that the CVX client's heartbeat timeout value is identical to that of its CVX server.

#### Related Commands

- [management cvx](#) places the switch in Mgmt-cvx configuration mode.
- [heartbeat-interval \(Management-CVX\)](#) specifies the CVX client heartbeat interval.

#### Example

These commands set the CVX client timeout period to 90 seconds.

```
switch(config) #management cvx
switch(config-mgmt-cvx) #heartbeat-timeout 90
switch(config-mgmt-cvx) #
```



### 13.1.9.6 lldp run

The `lldp run` command enables LLDP on the Arista switch.

#### Command Mode

Global Configuration

#### Command Syntax

```
lldp run
no lldp run
default lldp run
```

#### Examples

- This command enables LLDP globally on the Arista switch.

```
switch(config)# lldp run
switch(config)#
```

- This command disables LLDP globally on the Arista switch.

```
switch(config)# no lldp run
switch(config)#
```

---

### 13.1.9.7 management cvx

The **management cvx** command places the switch in **mgmt-CVX configuration** mode to configure CVX client parameters.

**Mgmt-CVX** configuration mode is not a group-change mode; **running-config** is changed immediately upon entering commands. Exiting mgmt-CVX configuration mode does not affect running-config. The **exit** command returns the switch to global configuration mode.

The **no management cvx** and **default management cvx** commands delete all mgmt-CVX configuration mode statements from running-config.

#### Command Mode

Global Configuration

#### Command Syntax

```
management cvx
no management cvx
default management cvx
exit
```

#### Commands Available in Mgmt-CVX Configuration Mode

- heartbeat-interval (Management-CVX)
- heartbeat-timeout (Management-CVX)
- server host (Management-CVX)
- source-interface (Management-CVX)
- shutdown (Management-CVX)

#### Examples

- This command places the switch in mgmt-CVX configuration mode:

```
switch(config)#management cvx
switch(s1)(config-mgmt-cvx)#
```

- This command returns the switch to global management mode:

```
switch(config-mgmt-cvx)#exit
switch(config)#
```

### 13.1.9.8 manager

The **manager** command configures the IP address of the OVSDB controller for the HSC service, allowing CVX to connect to the controller.

The **no manager** and **default manager** commands remove the HSC manager configuration from **running-config**.

#### Command Mode

CVX-HSC Configuration

#### Command Syntax

```
manager ip_address [port]
```

#### Parameters

**ip\_address** IP address of the HSC manager.

**port connection port.** Values range from 1 to 65535; default value is 6632.

#### Related Commands

- **service hsc** places the switch in CVX-HSC configuration mode.

#### Example

- These commands point the HSC service to a controller at IP address *192.168.2.5* using the default port *6632*.

```
switch(config)#cvx
switch(config-cvx)#service hsc
switch(config-cvx-hsc)#manager 192.163.2.5
switch(config-cvx-hsc)#
```

---

### 13.1.9.9 name-resolution force (CVX-OpenStack)

The **name-resolution force** command initiates an OpenStack controller function that communicates with the OpenStack Keystone and Nova services to update names of VMs and tenants mapped by the local OpenStack instance.

The OpenStack controller accesses the Keystone and Nova services in response to various triggering events (such as the creation of a new tenant, network or VM), and also at a regular interval configured by the **name-resolution interval (CVX-OpenStack)** command (default interval 6 hours). The **name-resolution force** command is used to force an immediate update without waiting for a triggering event.

#### Command Mode

CVX-OpenStack Configuration

#### Command Syntax

```
name-resolution force
```

#### Related Commands

- **service openstack** places the switch in CVX-OpenStack configuration mode.
- **name-resolution interval (CVX-OpenStack)** sets the interval for automatic Keystone updates.

#### Example

- These commands update the OpenStack instance immediately with data from the Keystone service.

```
switch(config)#cvx
switch(config-cvx)#service openstack
switch(config-cvx-openstack)#name-resolution force
switch(config-cvx-openstack)#
```

### 13.1.9.10 name-resolution interval (CVX-OpenStack)

The **name-resolution interval** command specifies the period between consecutive requests that the OpenStack controller sends to the Keystone service for VM and tenant name updates. Keystone is OpenStack's authentication and authorization service.

The default period is 21600 seconds (6 hours).

The **name-resolution force (CVX-OpenStack)** command performs an immediate update, as opposed to waiting for the periodic update.

#### Command Mode

CVX-OpenStack Configuration

#### Command Syntax

```
name-resolution interval period
```

#### Parameters

**period:** Keystone identity service polling interval (seconds).

#### Related Command

**service openstack** places the switch in **CVX-OpenStack** configuration mode.

#### Example

These commands set the name resolution interval period at five hours.

```
switch(config)#cvx
switch(config-cvx)#service openstack
switch(config-cvx-openstack)#name-resolution interval 18000
switch(config-cvx-openstack)#
```

---

### 13.1.9.11 ovsdb-shutdown

The **ovsdb-shutdown** command shuts down the OVSDB server.

The **no ovsdb-shutdown** and **default ovsdb-shutdown** commands enable the OVSDB server by removing the ovsdb-shutdown command from running-config.

#### Command Mode

CVX-HSC Configuration

#### Command Syntax

```
ovsdb-shutdown
```

```
no ovsdb-shutdown
```

```
default ovsdb-shutdown
```

#### Related Commands

- **service hsc** places the switch in **CVX-HSC configuration** mode.

#### Example

- These commands shut down the OVSDB server used by the HSC service.

```
switch(config) #cvx
switch(config-cvx) #service hsc
switch(config-cvx-hsc) #ovsdb-shutdown
switch(config-cvx-hsc) #
```

### 13.1.9.12 port (CVX)

The **port** command specifies the TCP port number the CVX server listens on. The default port number is **9979**.

The **no port** and **default port** commands restore the default port number by removing the port statement from **running-config**.

#### Command Mode

CVX Configuration

#### Command Syntax

```
port port_number
```

```
no port
```

```
default port
```

#### Parameters

- *port\_number*: TCP port number. Value ranges from 1 to 65535.

#### Related Commands

- **cvx** places the switch in **CVX configuration** mode.

#### Example

- These commands configure **9500** as the CVX server port.

```
switch#config
switch(config)#cvx
switch(config-cvx)#port 9500
switch(config-cvx)#
```

- These commands restore the default port (9979) as the CVX server port.

```
switch(config-cvx)#no port
switch(config-cvx)#
```

---

### 13.1.9.13 resync-period

The **resync-period** command configures the grace period for completion of synchronization between the VXLAN control service and clients after a CVX restart. Arista recommends leaving the grace period set to its default of 300 seconds.

The **no resync-period** command disables VXLAN control service graceful restart. The **default resync-period** command resets the grace period to its default of 300 seconds.

#### Command Mode

CVX-VXLAN Configuration

#### Command Syntax

```
resync-period seconds
no resync-period
default resync-period
```

#### Parameters

- *seconds*: synchronization grace period in seconds. Values range from 30 to 4800; default is 300.

#### Examples

- These commands reset the VXLAN control service synchronization grace period to 300 seconds.

```
switch(config)#cvx
switch(config-cvx)#service vxlan
switch(config-cvx-vxlan)#default resync-period
switch(config-cvx-vxlan)#
```



### 13.1.9.14 server host (Management-CVX)

The **server host** command configures the IP address or host name of the CVX server to which the CVX client device connects. The configuration of this address is required for the switch to function as a CVX client. By default, no CVX host address is specified.

The **no server host** and **default server host** commands remove the CVX host address assignment by removing the server host statement from running-config.

#### Command Mode

Mgmt-CVX Configuration

#### Command Syntax

```
server host host
```

```
no server host
```

```
default server host
```

#### Parameters

- host: IPv4 address (in dotted decimal notation) or FQDN host name of the CVX server.

#### Related Commands

- `management cvx` places the switch in **Mgmt-CVX configuration** mode.

#### Examples

- This command specifies *10.1.1.14* as the address of the server to which the CVX client connects.

```
switch(config)#management cvx
switch(config-mgmt-cvx)#server host 10.1.1.14
switch(config-mgmt-cvx)#
```

---

### 13.1.9.15 service hsc

The **service hsc** command enters **CVX-HSC configuration** mode where the hardware switch controller (HSC) service is enabled and configured.

CVX-HSC configuration mode is not a group change mode; **running-config** is changed immediately upon entering commands. Exiting **CVX-HSC configuration** mode does not affect **running-config**. The **exit** command returns the switch to global configuration mode.

#### Command Mode

CVX Configuration

#### Command Syntax

```
service hsc
```

#### Commands Available in CVX-HSC Configuration Mode

- manager
- ovssdb-shutdown
- shutdown (CVX-HSC)
- vtep (CVX-HSC)

#### Related Commands

- **cvx** places the switch in CVX configuration mode.

#### Example

- These commands enter **CVX-HSC configuration** mode.

```
switch(config)#cvx
switch(config-cvx)#service hsc
switch(config-cvx-hsc)#
```

### 13.1.9.16 service openstack

The `service openstack` command places the switch in CVX-OpenStack configuration mode.

In order to integrate Arista switches into an OpenStack managed cloud network, OpenStack needs to interact with CVX to configure and maintain VLANs on appropriate physical switch ports that connect to hosts where the VMs reside.

CVX-OpenStack configuration mode is not a group change mode; **running-config** is changed immediately upon entering commands. Exiting **CVX-OpenStack** configuration mode does not affect **running-config**. The `exit` command returns the switch to global configuration mode.

#### Command Mode

CVX Configuration

#### Command Syntax

```
service openstack
```

#### Commands Available in CVX-OpenStack Configuration Mode

- `name-resolution force` (CVX-OpenStack)
- `name-resolution interval` (CVX-OpenStack)
- `shutdown` (CVX-OpenStack)

#### Related Commands

- `cvx` places the switch in CVX configuration mode.

#### Example

- These commands places the switch in **CVX-OpenStack** configuration mode.

```
switch(config)#cvx
switch(config-cvx)#service openstack
switch(config-cvx-openstack)#
```

---

### 13.1.9.17 service vxlan

The `service vxlan` command enters **CVX-VXLAN configuration** mode where the VXLAN control service is enabled and configured.

CVX-VXLAN configuration mode is not a group change mode; *running-config* is changed immediately upon entering commands. Exiting **CVX-VXLAN configuration** mode does not affect running-config. The `exit` command returns the switch to global configuration mode.

#### Command Mode

CVX Configuration

#### Command Syntax

```
service vxlan
```

#### Commands Available in CVX-VXLAN Configuration Mode

- `resync-period`
- `shutdown (CVX-VXLAN)`
- `vtep (CVX-VXLAN)`

#### Related Commands

- `cvx` places the switch in CVX configuration mode.

#### Example

- These commands enter **CVX-VXLAN configuration** mode.

```
switch(config) #cvx
switch(config-cvx) #service vxlan
switch(config-cvx-vxlan) #
```

### 13.1.9.18 show cvx

The **show cvx** command displays the enable status and current configuration of CVX.

#### Command Mode

EXEC

#### Command Syntax

```
show cvx
```

#### Example

- This command displays status and configuration of CVX.

```
switch(config)#cvx
cvx
no shutdown
heartbeat-interval 30
heartbeat-timeout 90
switch(config-cvx)#dis
switch>show cvx
CVX Server
Status: Enabled
UUID: 75ce27ce-cc04-11e4-a404-233646319a2c
Heartbeat interval: 30.0
Heartbeat timeout: 90.0
switch>
```

### 13.1.9.19 show network physical-topology

The **show network physical-topology** command displays the network topology discovered through CVX.

#### Command Mode

EXEC

#### Command Syntax

```
show network physical-topology hosts|neighbors
```

#### Parameters

- *hosts* Displays all hosts visible in the topology.
- *neighbors* Displays all connections in the network topology. Table is sorted by host name, and can be optionally filtered by host.

#### Example

- This command displays all visible hosts.

```
switch#show network physical-topology hosts

Unique Id Hostname

001c.7385.be69 cvx287.sjc.aristanetworks.com
0000.6401.0000 cvc1
0000.6402.0000 cvc2
0000.6403.0000 cvc3
0000.6404.0000 cvc4
bcf6.85bd.8050 dsj14-rack14-tor1
```

- This command displays all connections in the topology.

```
switch#show network physical-topology neighbors

cvx287.sjc.aristanetworks.com

Interface Neighbor Intf Neighbor Host

Ethernet1 Ethernet7 cvc4
Ethernet2 Ethernet7 cvc2
Ethernet9 Ethernet7 cvc1
Ethernet10 Ethernet7 cvc3
Management1 27 dsj14-rack14-tor1

OUTPUT OMITTED FROM EXAMPLE
dsj14-rack14-tor1

Interface Neighbor Intf Neighbor Host

27 Management1 cvx287.sjc.aristanetwork
```

### 13.1.9.20 shutdown (CVX)

The **shutdown** command, in cvx mode, disables or enables the switch as a CVX server. By default, CVX is disabled on the switch.

The **no shutdown** command enables the switch as a CVX server. The `shutdown` and **default shutdown** commands disable the switch as a CVX server by removing the **no shutdown** command from running-config.



**Note:** Be sure to de-configure or shut down all CVX client services before disabling CVX; failure to do so may result in CVX client services continuing to run after CVX has been disabled.

#### Command Mode

CVX Configuration

#### Command Syntax

```
shutdown
```

```
no shutdown
```

```
default shutdown
```

#### Related Commands

- `cvx` places the switch in CVX configuration mode.

#### Example

- These commands enable the switch as a CVX server.

```
switch#config
switch(config)#cvx
switch(config-cvx)#no shutdown
switch(config-cvx)#
```

- This command disables CVX on the switch.

```
switch(config-cvx)#shutdown
switch(config-cvx)#
```

---

### 13.1.9.21 shutdown (CVX-HSC)

The **shutdown** command, in **CVX-HSC configuration** mode, disables or enables the CVX hardware switch controller (HSC) service on the switch. HSC is disabled by default.

When a CVX server enables HSC, its clients (hardware VTEPs) are able to share state to establish VXLAN tunnels without the need for a multicast control plane. Configuration is also required on the client switches.

The **no shutdown** command enables the HSC service; the **shutdown** and **default shutdown** commands disable the HSC service.

#### Command Mode

CVX-VXLAN Configuration

#### Command Syntax

```
shutdown
```

```
no shutdown
```

```
default shutdown
```

#### Related Commands

- **service hsc** places the switch in CVX-HSC configuration mode.

#### Example

- These commands enable the HSC service.

```
switch(config)#cvx
switch(config-cvx)#service hsc
switch(config-cvx-hsc)#no shutdown
switch(config-cvx-hsc)#
```

- These commands disable the HSC service.

```
switch(config)#cvx
switch(config-cvx)#service hsc
switch(config-cvx-hsc)#shutdown
switch(config-cvx-hsc)#
```



### 13.1.9.22 shutdown (Management-CVX)

The **shutdown** command, in **mgmt-cvx** mode, disables or enables CVX client services on the switch. CVX services are disabled by default.

The **no shutdown** command enables CVX client services. The **shutdown** and **default shutdown** commands disable CVX client services by removing the corresponding no shutdown command from running-config.

#### Command Mode

Mgmt-CVX Configuration

#### Command Syntax

```
shutdown
```

```
no shutdown
```

```
default shutdown
```

#### Related Commands

- `management cvx` places the switch in **Mgmt-cvx configuration** mode.

#### Example

- These commands enable CVX client services.

```
switch(config)#management cvx
switch(config-mgmt-cvx)#no shutdown
switch(config-mgmt-cvx)#
```

- This command disables CVX client services.

```
switch(config-mgmt-cvx)#shutdown
switch(config-mgmt-cvx)#
```

---

### 13.1.9.23 shutdown (CVX-OpenStack)

The **shutdown** command, in **cvx-openstack** configuration mode, disables or enables CVX-OpenStack on the switch. CVX-OpenStack is disabled by default.

When a CVX server enables OpenStack services, its clients are accessible to the OpenStack network controller (Neutron). Integrating Arista switches into an OpenStack-managed cloud network requires OpenStack to interact with CVX to configure and maintain VLANs on appropriate physical switch ports that connect to the hosts where the VMs reside.

The **no shutdown** command enables CVX-OpenStack. The **shutdown** and **default shutdown** commands disable CVX-OpenStack by removing the corresponding no shutdown command from running-config.

#### Command Mode

CVX-OpenStack Configuration

#### Command Syntax

```
shutdown
```

```
no shutdown
```

```
default shutdown
```

#### Related Commands

- **service openstack** places the switch in **CVX-OpenStack configuration** mode.

#### Example

- These commands enable CVX-OpenStack.

```
switch(config)#cvx
switch(config-cvx)#service openstack
switch(config-cvx-openstack)#no shutdown
switch(config-cvx-openstack)#
```

- These commands disable CVX-OpenStack.

```
switch(config-cvx-openstack)#
switch(config-cvx-openstack)#shutdown
switch(config-cvx-openstack)#
```

### 13.1.9.24 shutdown (CVX-VXLAN)

The **shutdown** command, in **CVX-VXLAN configuration** mode, disables or enables the CVX VXLAN control service on the switch. VXLAN control service is disabled by default.

When a CVX server enables VXLAN control service, its clients (hardware VTEPs) are able to share state to establish VXLAN tunnels without the need for a multicast control plane. Configuration is also required on the client switches.

The **no shutdown** command enables the VXLAN control service. The **shutdown** and **default shutdown** commands disable the VXLAN control service.

#### Command Mode

CVX-VXLAN Configuration

#### Command Syntax

```
shutdown
```

```
no shutdown
```

```
default shutdown
```

#### Related Commands

- **service vxlan** places the switch in CVX-VXLAN configuration mode.

#### Example

- These commands enable VXLAN control service.

```
switch(config)#cvx
switch(config-cvx)#service vxlan
switch(config-cvx-vxlan)#no shutdown
switch(config-cvx-vxlan)#
```

- These commands disable VXLAN control service

```
switch(config)#cvx
switch(config-cvx)#service vxlan
switch(config-cvx-vxlan)#shutdown
switch(config-cvx-vxlan)#
```

---

### 13.1.9.25 source-interface (Management-CVX)

The **source-interface** command specifies the interface from where the IPv4 address is derived for use as the source for outbound CVX packets that the switch sends as a CVX client. There is no default source interface assignment.

The **no source-interface** and **default source-interface** commands remove the source interface assignment for the CVX client by deleting the source-interface statement from **running-config**.

#### Command Mode

Mgmt-CVX Configuration

#### Command Syntax

```
source-interface INT_NAME
```

```
no source-interface
```

```
default source-interface
```

#### Parameters

**INT\_NAME**: Interface type and number. Options include:

- **ethernet** *e\_num*: Ethernet interface specified by *e\_num*.
- **loopback** *l\_num*: Loopback interface specified by *l\_num*.
- **management** *m\_num*: Management interface specified by *m\_num*.
- **port-channel** *p\_num*: Port-Channel Interface specified by *p\_num*.
- **vlan** *v\_num*: VLAN interface specified by *v\_num*.

#### Related Commands

- management cvx places the switch in **Mgmt-CVX configuration** mode.

#### Example

- These commands configure the CVX client to use the IP address *10.24.24.1* as the source address for its outbound packets.

```
switch#config
switch(config)#interface loopback 5
switch(config-if-Lo5)#ip address 10.24.24.1/24
switch(config-if-Lo5)#exit
switch(config)#management cvx
switch(config-mgmt-cvx)#source-interface loopback 5
switch(config-mgmt-cvx)#
```

### 13.1.9.26 vtep (CVX-HSC)

The HSC service sends flood lists to each VTEP through CVX. Some controllers (such as VMware NSX's Service Nodes) implement replication nodes for head-end replication of unknown packets. For these controllers, BUM packets should be sent to a single replication node (send-to-any replication), and the flood list sent by the HSC service is a list of replication nodes. Other controllers (such as Nuage VSP) require each VTEP to perform its own head-end replication. For these, BUM packets should be sent to every known VTEP, and the flood list sent by the HSC service is the list of VTEPs.

The default behavior is to use a send-to-any replication list of VTEPs. If the required behavior is send-to-all replication of, use the all option of the `vtep` command in **CVX-HSC configuration** mode.

#### Command Mode

CVX-HSC Configuration

#### Command Syntax

```
vtep flood list type all | any
```

```
no vtep flood list type
```

```
default vtep flood list type
```

#### Parameters

- all: send-to-all replication; flood list is the list of VTEPs.
- any: send-to-any replication; flood list is a list of replication nodes. This is the default setting.

#### Example

These commands configure the HSC to use send-to-all replication.

```
switch(config)#cvx
switch(config-cvx)#service hsc
switch(config-cvx-hsc)#vtep flood list type all
switch(config-cvx-hsc)#
```

### 13.1.9.27 vtep (CVX-VXLAN)

The OVSDB management protocol includes provisions for control-plane MAC learning, which allows MAC addresses to be distributed among VTEPs without using the data plane. Some controllers (such as VMware NSX) take advantage of this facility; others (such as Nuage VSP) do not. By default, CVX uses control-plane MAC learning.

To switch to data plane MAC learning, use the **vtep** command in CVX-VXLAN configuration mode, as shown below.

#### Command Mode

CVX-VXLAN Configuration

#### Command Syntax

```
vtep mac-learning control-plane|data-plane
```

#### Related Commands

- **service vxlan** places the switch in **CVX-VXLAN configuration** mode.

#### Example

- These commands configure CVX to use data-plane MAC address learning.

```
switch(config) #cvx
switch(config-cvx) #service vxlan
switch(config-cvx-vxlan) #vtep mac-learning data-plane
switch(config-cvx) #
```

## Routing Protocols

---

The Routing Protocols chapter contains the following sections:

- [Routing Information Protocol \(RIP\)](#)
- [Open Shortest Path First – Version 2](#)
- [Open Shortest Path First – Version 3](#)
- [IS-IS](#)
- [Border Gateway Protocol \(BGP\)](#)
- [Maintenance Mode](#)
- [Bidirectional Forwarding Detection](#)

### 14.1 Routing Information Protocol (RIP)

This chapter contains the following sections.

- [RIP Conceptual Overview](#)
- [Running RIP on the Switch](#)
- [Configuring RIP on Multiple VRFs](#)
- [RIP Commands](#)

#### 14.1.1 RIP Conceptual Overview

Routing Information Protocol (RIP) is a routing protocol typically used as an interior gateway protocol (IGP). RIP uses hop counts only to determine the shortest path to a destination. To avoid loops, RIP limits its paths to a maximum of 15 hops, making it an ineffective protocol for large networks. RIP Version 2 supports Classless Inter-Domain Routing (CIDR) and uses IP multicast at address 224.0.0.9 to share the routing table with adjacent routers.

RIP sends updates whenever there is a change in the network topology and periodic updates when there are no changes. Receiving switches update their routing table whenever the update includes topology changes. Because RIP transmits the entire routing table every 30 seconds, RIP updates can generate heavy traffic loads in large or complicated networks.

Each switch also sends a list of distance-vectors to each of its neighbors periodically. The distance-vector is the metric RIP uses to express the cost of a route, and it describes the number of hops required to reach a destination. Each hop is typically assigned a hop count value of 1, and the router adds 1 to the metric when it receives a routing update and adds the network to its routing table.

To remove dead routes from its routing table, RIP marks a route for deletion if the router does not receive an advertisement for it within the expiration interval, then removes it from the routing table after the deletion interval.

---

## 14.1.2 Running RIP on the Switch

### 14.1.2.1 Accessing RIP Configuration Mode and Enabling RIP

#### 14.1.2.1.1 RIP Configuration Mode

The `router rip` command places the switch in router-RIP configuration mode to configure Routing Information Protocol (RIP) routing.

##### Example

This command places the switch in router-RIP configuration mode.

```
switch(config)#router rip
switch(config-router-rip)#
```

Using the `router rip` command puts the switch in router-RIP configuration mode, but does not enable RIP on the switch.

#### 14.1.2.1.2 Enabling RIP

Routing Information Protocol (RIP) is disabled on the switch by default. The `no shutdown (RIP)` command in router-RIP configuration mode will enable RIP.

##### Example

This command enables RIP on the switch.

```
switch(config-router-rip)#no shutdown
switch(config-router-rip)#
```

Issuing this command enables RIP, but to send and receive RIP route updates and to route packets via RIP you must also specify interfaces on which RIP will run by using the `network (RIP)` command.

#### 14.1.2.1.3 Disabling RIP

You can disable RIP in two ways. The `shutdown (RIP)` command disables RIP on the switch but maintains all user-entered router-RIP configuration statements in the *running-config*. The `no router rip` command disables RIP and removes all user-entered router-RIP configuration statements from the *running-config*.

##### Examples

- This command disables RIP on the switch and removes all user-entered router-RIP configuration.

```
switch(config)#no router rip
switch(config)#
```

- This command disables RIP on the switch, but preserves all user-entered router-RIP configuration.

```
switch(config-router-rip)#shutdown
switch(config-router-rip)#
```

#### 14.1.2.2 Configuring RIP

Issuing the `no shutdown (RIP)` command in router-RIP configuration mode enables RIP, but to run RIP on an interface you must specify a RIP network by using the `network (RIP)` command.



You can also configure the redistribution of routes learned from other protocols, set the default metric and administrative distance for redistributed routes, configure the timing of various RIP events, and configure specific interfaces to send RIP update packets by broadcast instead of multicast.

#### 14.1.2.2.1 Specifying RIP Networks

The `network (RIP)` command identifies networks on which RIP will run and also specifies which routes RIP will accept into its routing table. You can issue the `network (RIP)` command multiple times to build up a list of RIP networks. No RIP networks are configured by default, so in order to route packets and send and receive RIP updates you must specify one or more RIP networks.

To disable RIP on a specific network, use the `no network (RIP)` command.

##### Examples

- This command enables RIP on `10.168.1.1/24`.

```
switch(config-router-rip) network 10.168.1.1/24
switch(config-router-rip) #
```

- This command disables RIP on `10.168.1.1/24`.

```
switch(config-router-rip) #no network 10.168.1.1/24
switch(config-router-rip) #
```

#### 14.1.2.2.2 Redistributing Routes Learned from Other Protocols into RIP

To enable route import from a specified protocol into RIP, use the `redistribute (RIP)` command. Additionally, you can apply a route map to the incoming routes to filter which routes are added to the RIP routing table. All connected routes are redistributed into RIP by default.

##### Example

This command redistributes all routes learned from OSPF into RIP.

```
switch(config-router-rip) #redistribute OSPF
switch(config-router-rip) #
```

#### 14.1.2.2.3 Configuring RIP Timers

When RIP is running on the switch, it sends unsolicited route updates and deletes expired routes at regular intervals. To configure the timing of those events, use the `timers (RIP)` command. The command takes three parameters: the update interval, the route expiration time, and the route deletion time.

The update interval is the amount of time in seconds that the switch waits between sending unsolicited RIP route updates to its neighbors. The route expiration time is how long the switch waits before marking an unadvertised route for deletion (the counter resets whenever an advertisement for the route is received). And the route deletion time is how long the switch waits between marking a route for deletion and removing it from the routing table. During the deletion interval, the switch continues to forward packets on the route.

##### Example

This command sets the update interval to 60 seconds, expiration time to 90 seconds, and deletion time to 150 seconds.

```
switch(config-router-rip) #timers 60 90 150
switch(config-router-rip) #
```

---

#### 14.1.2.2.4 Configuring an Interface to Transmit Broadcast RIP Updates

By default, the switch uses RIP version 2 and multicasts RIP update packets from all participating interfaces. To reconfigure a specific interface to send updates as broadcast packets, use the [rip v2 multicast disable](#) command in the configuration mode for the interface.

##### Example

The following commands configure RIP version 2 broadcasting on interface Ethernet 5.

```
switch(config)#interface ethernet5
switch(config-if-Et5)#rip v2 multicast disable
switch(config-if-Et5)#exit
switch(config)#
```

#### 14.1.2.3 Displaying RIP Information

##### 14.1.2.3.1 Displaying RIP Routes

To see a listing of the RIP routes in the switch's routing table, use the [show ip rip database](#) command. (You can also display similar information using the RIP option in the [show ip route](#) command.)

##### Examples

- This command displays all active rip routes.

```
switch>show ip rip database
10.168.11.0/24 directly connected, Et4
10.168.13.0/24
[1] via 10.168.14.2, 00:00:25, Et4
[2] via 10.168.15.2, 00:00:20, Et1
10.168.13.0/24
[1] via 10.168.14.2, 00:00:25, Et3
```

- ```
switch>show ip rip database 10.168.13.0/16
10.168.13.0/24
[1] via 10.168.14.2, 00:00:25, Et4
[2] via 10.168.15.2, 00:00:20, Et1
```

This command submits a query for RIP route information for a network.

14.1.2.3.2 Displaying RIP Route Gateways

To see information about the switch's RIP route gateways, use the [show ip rip neighbors](#) command. The output displays the IPv4 address, the last heard time of the gateway, and characteristic flags applying to the gateway.

Example

This command displays information about all the gateways of RIP routes.

```
switch>show ip rip neighbors
Gateway      Last-Heard    Bad-Packets    Bad-Routes    Flags
10.2.12.33   00:00:15
                                SRC, TRSTED,
                                ACPTED, RJCTED,
                                Q_RJCTED, AUTHFAIL
```

14.1.3 Configuring RIP on Multiple VRFs

VRF support for Routing Information Protocol (RIP) allows instances of RIP on multiple non-default VRFs on the same router. By default, all interfaces belong to the default VRF until VRF forwarding is executed.

The `vrf instance` and `vrf (Interface mode)` commands configure a non-default VRF, enable routing in it, and configure the network command under the configuration router RIP for the prefix to which the interface belongs.

The `router rip vrf` command places the switch in router-RIP configuration mode to configure a RIP routing instance in a non-default VRF.

Examples

- These commands configure a non-default VRF and enable unicast routing in it.

```
switch(config)#vrf instance test
switch(config-vrf-test)#exit
switch(config)#ip routing vrf test
switch(config)#
```

- This command configures a RIP instance in a non-default VRF.

```
switch(config)#router rip vrf test
switch(config-router-rip-router-rip-vrf-test)#no shutdown
switch(config-router-rip)#exit
switch(config)#
```

- This command configures an interface as part of a non-default VRF by configuring the network command under the configuration router RIP for the prefix to which the interface belongs.

```
switch(config)#interface Ethernet 3 / 1
switch(config-if-Et3/1)#no switchport
switch(config-if-Et3/1)#ip address 1.0.0.1/24
switch(config-if-Et3/1)#vrf test
switch(config-if-Et3/1)#network 1.0.0.1
switch(config-if-Et3/1)#exit
switch(config)#
```

14.1.4 RIP Commands

Global Configuration Commands

- `router rip`
- `router rip vrf`

Interface Configuration Commands

- `rip v2 multicast disable`

Router-RIP Configuration Mode

- `distance (RIP)`
- `distribute-list (RIP)`
- `metric default`
- `network (RIP)`
- `redistribute (RIP)`
- `shutdown (RIP)`
- `timers (RIP)`

Display Commands – EXEC Mode

- `show ip rip database`
- `show ip rip neighbors`

14.1.4.1 distance (RIP)

The **distance** command assigns an administrative distance to routes that the switch learns through RIP. Routers use administrative distances to select a route when two protocols provide routing information to the same destination. Distance values range from 1 to 255; lower distance values correspond to higher reliability. The default RIP distance value is 120.

The **no distance** and **default distance** commands restore the administrative distance default value of 120 by removing the **distance** command from **running-config**.

Command Mode

Router-RIP Configuration

Command Syntax

```
distance distance_value
```

```
no distance
```

```
default distance
```

Parameters

distance_value distance assigned to RIP routes. Values range from 1 to 255.

Example

These commands assign an administrative distance of 75 to RIP routes.

```
switch(config)# router rip  
switch(config-router-rip)# distance 75  
switch(config-router-rip)#
```

14.1.4.2 distribute-list (RIP)

The **distribute-list** command allows users to filter out routes that are received or sent out. The distribute-list command influences which routes the router installs into its routing table and advertises to its neighbors.

Configuration Notes:

- Only one inbound distribute-list is allowed per interface.
- Only one outbound distribute-list is allowed per interface.
- Only one globally-defined inbound distribute-list is allowed.
- Only one globally-defined outbound distribute-list is allowed.
- Not all match clauses in a route-map are supported using RIP routes filtering. These match clauses for distribute-lists are supported:
 - `match ip address access-list`
 - `match ip address prefix-list`
- The **distribute-list** command does not enforce the specified route-map to contain only supported match clauses.
- Permit or deny can be specified in both prefix/access list and route-map configurations. The following rules apply when filtering routes:
 - Routes permitted by the prefix/access lists are treated as matched.
 - Matched routes are filtered based on the permit or deny option configured for the route-map clause.
 - Unmatched routes are further evaluated by the next route-map clause.
 - If a route does not match any clause in a route-map, it is denied.
 - If the route-map given in the **distribute-list** command is not configured, then all routes are permitted.
 - When multiple inbound (or outbound) distribute-lists are configured, only the most specific one is applied.

The **no distribute-list** and **default distribute-list** commands remove the corresponding **distribute-list** command from *running-config*.

Command Mode

Router-RIP Configuration

Command Syntax

```
distribute-list DIRECTION MAP [INTF]
```

```
no distribute-list DIRECTION MAP [INTF]
```

```
default distribute-list DIRECTION MAP [INTF]
```

Parameters

- **DIRECTION** direction specifies if distribute-list is applied on inbound or outbound traffic. Valid options include:
 - `in` specifies inbound as the direction the distribute-list is applied.
 - `out` specifies outbound as the direction the distribute-list is applied.
- **MAP** specifies route map that assigns attribute values to the network. Options include:
 - `<no parameter>` attributes are not assigned through a route map.
 - `route-map map_name` attributes listed by specified route map are assigned to the network.

- INTF interface to be configured. Options include:
 - ethernet *e_num* Ethernet interface.
 - loopback *l_num* Loopback interface.
 - port-channel *p_num* Port channel interface.
 - vlan *v_num* VLAN interface.

Examples

- The following commands demonstrate that an access-list or prefix-list can be used within a route-map for use in a distribute-list.

```
switch(config)#ip prefix-list 8to24 seq 5 permit 0.0.0.0/0 ge 8 le 24
switch(config)#route-map myRouteMap permit 10
switch(config-route-map-myRouteMap)#match ip address prefix-list 8to24
switch(config-route-map-myRouteMap)#exit
switch(config)#
switch(config)#router rip
switch(config-router-rip)#distribute-list in route-map myRouteMap
switch(config-router-rip)#
```

- These commands suppress routes advertised on a particular interface.

```
switch(config)#ip prefix-list 2 seq 10 deny 30.1.1.0/24
switch(config)#route-map myRmOut permit 10
switch(config-route-map-myRmOut)#match ip address prefix-list 2
switch(config-route-map-myRouteMap)#exit
switch(config)#router rip
switch(config-router-rip)#distribute-list out route-map myRmOut
```

14.1.4.3 metric default

The **metric default** command specifies the metric value assigned to RIP routes learned from other protocols. All routes imported into RIP receive the default metric unless a matching route-map exists for the route. The route metric of 0 is assigned to redistributed connected and static routes. The default metric values range from 0 to 16 with a default value of 1.

The **no metric default** and **default metric default** commands remove the **metric default** command from *running-config* and returns the metric value to its default value of 1.

Command Mode

Router-RIP Configuration

Command Syntax

```
metric default metric_value
```

```
no metric default
```

```
default metric default
```

Parameters

metric_value default metric value assigned. Values range from 0 to 16; default is 1.

Example

This command sets the default metric value to 5.

```
switch(config)#router rip
switch(config-router-rip)#metric default 5
switch(config-router-rip)#
```

14.1.4.4 network (RIP)

The **network** command specifies which network the switch runs Routing Information Protocol (RIP), and also specifies which routes will be accepted into the RIP routing table. Multiple network commands can be issued to create a network list on which RIP runs.

The switch enables RIP on all interfaces in the specified network.

The **no network** and **default network** commands disable RIP on the specified network by removing the corresponding **network** command from *running-config*.

Command Mode

Router-RIP Configuration

Command Syntax

```
network NETWORK_ADDRESS
no network NETWORK_ADDRESS
default network NETWORK_ADDRESS
```

Parameters

- **NETWORK_ADDRESS** network IP address. Entry formats include the following:
 - *ipv4_subnet* IPv4 subnet (CIDR notation).
 - *ipv4_addr mask wildcard_mask* IP address and wildcard-mask.

Examples

- This command enables RIP on *10.168.1.1/24*.

```
switch(config)#router rip
switch(config-router-rip)#network 10.168.1.1/24
switch(config-router-rip)#
```

- This command also enables RIP on *10.168.1.1/24*.

```
switch(config-router-rip)#network 10.168.1.1 mask 0.0.0.255
switch(config-router-rip)#
```

14.1.4.5 redistribute (RIP)

The **redistribute** command enables the importing of routes from a specified routing domain to RIP.

- **connected** by default, RIP redistributes all connected routes that are established when IP is enabled on an interface. The route-map parameter facilitates the exclusion of connected routes from redistribution by specifying a route map that denies the excluded routes.
- **BGP, OSPF, and IP static routes** by default, routes are not redistributed. The **redistribute** command without the route-map parameter facilitates the redistribution of all routes from the specified source.

The **no redistribute** and **default redistribute** commands reset the default route redistribution setting by removing the **redistribute** statement from *running-config*.

Command Mode

Router-RIP Configuration

Command Syntax

```
redistribute connected ROUTE_MAP
redistribute ROUTE_TYPE [ROUTE_MAP]
no redistribute connected ROUTE_MAP
no redistribute ROUTE_TYPE
default redistribute connected ROUTE_MAP
default redistribute ROUTE_TYPE
```

Parameters

- **ROUTE_TYPE** source from which routes are redistributed. Options include:
 - **BGP** routes from a BGP domain.
 - **OSPF** routes from an OSPF domain.
 - **OSPF match external** routes external to RIP, but imported from OSPF.
 - **OSPF match internal** OSPF routes that are internal to the AS.
 - **static** IP static routes.
- **ROUTE_MAP** route map that determines the routes that are redistributed. Options include:
 - *<no parameter>* all routes are redistributed.
 - **route-map map_name** only routes in the specified route map are redistributed.

Example

These commands redistribute OSPF routes into RIP.

```
switch(config)#router rip
switch(config-router-rip)#redistribute OSPF
switch(config-router-rip)#
```

14.1.4.6 rip v2 multicast disable

The **rip v2 multicast disable** command specifies the transmission of Routing Information Protocol (RIP) Version 2 update packets from the configuration mode interface as broadcast to 255.255.255.255.

The **no rip v2 multicast disable** and **default rip v2 multicast disable** commands specify the transmission of update packets as multicast to 224.0.0.9 if the configuration mode interface is multicast capable. Updates are broadcast if the interface is not multicast capable.

Command Mode

Interface-Ethernet Configuration

Interface-Port-Channel Configuration

Interface-VLAN Configuration

Command Syntax

```
rip v2 multicast disable
no rip v2 multicast disable
default rip v2 multicast disable
```

Example

The following example configures version 2 broadcasting on *interface Ethernet 5*.

```
switch(config)#interface ethernet 5
switch(config-if-Et5)#rip v2 multicast disable
switch(config-if-Et5)#exit
switch(config)#
```

14.1.4.7 router rip vrf

The **router rip** command places the switch in router-RIP configuration mode to configure an RIP routing instance in the non-default VRF.

The **no router rip vrf** and **default router rip vrf** commands disable an RIP routing instance in the non-default VRF, and remove all user-entered **router-rip** configuration statements from **running-config**. To disable RIP without removing configuration statements, use the [shutdown \(RIP\)](#) command.

The **exit** command returns the switch to global configuration mode.

Command Mode

Global Configuration

Command Syntax

```
router rip vrf [RIP_INSTANCE]
no router rip vrf [RIP_INSTANCE]
default router rip vrf [RIP_INSTANCE]
```

Parameters

RIP_INSTANCE configure a RIP VRF instance in the non-default VRF.

Examples

- This command configures a RIP instance in the non-default VRF.

```
switch(config)#router rip vrf test
switch(config-router-rip-router-rip-vrf-test)#no shutdown
switch(config-router-rip)#exit
switch(config)#
```

- This command disables a RIP instance in the non-default VRF.

```
switch(config)#no router rip vrf test
switch(config)#
```

14.1.4.8 router rip

The **router rip** command places the switch in router-rip configuration mode to configure the Routing Information Protocol (RIP) routing process. Router-rip configuration mode is not a group change mode; **running-config** is changed immediately upon command entry. The **exit** command does not affect **running-config**.

The **no router rip** and **default router rip** commands disable RIP and remove all user-entered **router-rip** configuration statements from **running-config**. To disable RIP without removing configuration statements, use the **shutdown (RIP)** command.

The **exit** command returns the switch to global configuration mode.

Command Mode

Global Configuration

Command Syntax

```
router rip
```

```
no router rip
```

```
default router rip
```

Commands Available in router-rip Configuration Mode

- [distance \(RIP\)](#)
- [network \(RIP\)](#)
- [redistribute \(RIP\)](#)
- [shutdown \(RIP\)](#)
- [timers \(RIP\)](#)

Example

This command places the switch in router-rip configuration mode.

```
switch(config)#router rip
switch(config-router-rip)#
```

14.1.4.9 show ip rip database

The **show ip rip database** command displays information about routes in the Routing Information Base. The default command displays active routes and learned routes not used in deference to higher priority routes from other protocols.

This command has the following forms:

- default (no arguments): information about all RIP routes.
- IPv4 address and mask: information about the referenced addresses.
- **active**: information about routes not superseded by routes from other protocols.

Command Mode

EXEC

Command Syntax

```
show ip rip database [FILTER]
```

Parameters

FILTER routing table entries that the command displays. Values include.:

- *<no parameter>* displays all routing table entries.
- **active** displays all active routing table entries.
- *net_addr* subnet address (CIDR or address-mask). Command displays entries in this subnet.

Examples

- This command displays all active rip routes.

```
switch>show ip rip database active
10.168.11.0/24 directly connected, Et4
10.168.13.0/24
[1] via 10.168.14.2, 00:00:25, Et4
[2] via 10.168.15.2, 00:00:20, Et1
10.168.13.0/24
[1] via 10.168.14.2, 00:00:25, Et3
```

- This command submits a query for RIP route information for a network.

```
switch>show ip rip database 10.168.13.0/16
10.168.13.0/24
[1] via 10.168.14.2, 00:00:25, Et4
[2] via 10.168.15.2, 00:00:20, Et1
```

- This command returns information for all RIP routes.

```
switch>show ip rip database
10.1.0.0/255.255.255.0
[1] via 10.8.31.15, 00:00:21, Et2, holddown
10.2.0.0/255.255.255.0
[1] via 10.8.31.15, 00:00:21, Et2, holddown
10.3.0.0/255.255.255.0
[1] via 10.8.31.15, 00:00:21, Et2, inactive
10.212.0.0/255.255.255.0
[1] via 10.8.31.15, 00:00:21, Et2, active
10.214.0.0/255.255.255.0
[1] via 10.8.12.17, 00:00:30, Et4, active
```

14.1.4.10 show ip rip neighbors

The **show ip rip neighbors** command displays information about all RIP route gateways. The output displays the IPv4 address, the last heard time of the gateway, and characteristic flags applying to the gateway.

Command Mode

EXEC

Command Syntax

```
show ip rip neighbors
```

Example

The **show ip rip neighbors** command displays information about all gateways of RIP routes.

```
switch>show ip rip neighbors
Gateway      Last-Heard      Bad-Packets      Bad-Routes      Flags
10.2.12.33   00:00:15
                                     SRC, TRSTED,
                                     ACCEPTED, RJCTED,
                                     Q_RJCTED, AUTHFAIL
```

14.1.4.11 shutdown (RIP)

The **shutdown** command disables RIP on the switch without modifying the RIP configuration. RIP is disabled by default.

The **no shutdown** command enables RIP. The **default shutdown** command disables RIP.

Command Mode

Router-RIP Configuration

Command Syntax

```
shutdown
```

```
no shutdown
```

```
default shutdown
```

Examples

- This command disables RIP on the switch.

```
switch(config)#router rip  
switch(config-router-rip)#shutdown  
switch(config-router-rip)#
```

- This command enables RIP on the switch.

```
switch(config-router-rip)#no shutdown  
switch(config-router-rip)#
```

14.1.4.12 timers (RIP)

The **timers** command configures the update interval, the expiration time, and the deletion time for routes received and sent through RIP. The command requires value declaration of all values.

- The update time is the interval between unsolicited route responses.
- The expiration time is initialized when a route is established and any time an update is received for the route.
- The deletion time is initialized when the expiration time elapses and the route is invalid. It is retained in the routing table until deletion time expiry.

The **no timers** and **default timers** commands return the timer values to their default values by removing the **timers** command from **running-config**.

Command Mode

Router-RIP Configuration

Command Syntax

```
timers update_time expire_time deletion_time
```

```
no timers
```

```
default timers
```

Parameters

- *update_time* Default is 30 seconds
- *expire_time* Default is 180 seconds.
- *deletion_time* Default is 120 seconds.

Parameter values are in seconds and range from **5** to **2147483647**.

Example

This command sets the update (60 seconds), expiration (90 seconds), and deletion (150 seconds) times.

```
switch(config)#router rip
switch(config-router-rip)#timers 60 90 150
switch(config-router-rip)#
```

14.2 Open Shortest Path First – Version 2

Open Shortest Path First (OSPF) is a link-state routing protocol that operates within a single autonomous system. OSPF version 2 is defined by RFC 2328.

This section contains the following topics:

[OSPFv2 Introduction](#)

[OSPFv2 Conceptual Overview](#)

[Configuring OSPFv2](#)

[OSPFv2 Configuration Examples](#)

[OSPFv2 Commands](#)

14.2.1 OSPFv2 Introduction

This section contains the following topics:

-
- [Supported Features](#)
 - [Features Not Supported](#)

14.2.1.1 Features Not Supported

The following OSPFv2 functions are not supported in the current version:

- NBMA, demand circuit, and P2MP interfaces
- OSPFv2 MIB support

14.2.1.2 Supported Features

Arista switches support the following OSPFv2 functions:

- A single OSPFv2 instance
- Intra- and inter-area routing
- Type 1 and 2 external routing
- Broadcast and P2P interfaces
- Stub areas
- Not so stubby areas (NSSA) (RFC 3101)
- MD5 Authentication
- Redistribution of static, IP, and BGP routes into OSPFv2 with route map filtering
- Opaque LSAs (RFC 2370)
- Graceful restart (RFC 3623)
- [OSPF Routes over GRE Tunnels](#)

14.2.1.3 OSPFv2 Conceptual Overview

This section contains the following topics:

- [Storing Link States](#)
- [Topology](#)
- [Link Updates](#)
- [OSPFv2 Route Redistribution Instance](#)
- [OSPFv2 Multiple Instances Support](#)
- [OSPF Routes over GRE Tunnels](#)
- [OSFP-Line System](#)

14.2.1.3.1 Storing Link States

OSPFv2 is a dynamic, link-state routing protocol, where links represent interfaces or routable paths. Dynamic routing protocols calculate the most efficient path between locations based on bandwidth and device status.

A link state advertisement (LSA) is an OSPFv2 packet that communicates a router's topology to other routers. The link state database (LSDB) stores an areas topology database and is composed of LSAs received from other routers. Routers update the LSDB by storing LSAs from other routers.

14.2.1.3.2 Topology

An autonomous system (AS) is the IP domain within which a dynamic protocol controls the routing of traffic. In OSPFv2, an AS is composed of areas, which define the LSDB computation boundaries. All routers in an area store identical LSDBs. Routers in different areas exchange updates without storing the entire database, reducing information maintenance on large, dynamic networks.

An AS shares internal routing information from its areas and external routing information from other processes to inform routers outside the AS about routes the network can access. Routers that advertise routes on other ASs commit to carry data to the IP space on the route.

OSPFv2 defines these routers:

- Internal router (IR) a router whose interfaces are contained in a single area. All IRs in an area maintain identical LSDBs.
- Area border router (ABR) a router that has interfaces in multiple areas. ABRs maintain one LSDB for each connected area.
- Autonomous system boundary router (ASBR) a gateway router connecting the OSPFv2 domain to external routes, including static routes and routes from other autonomous systems.

[OSPFv2 Router Types](#) displays the OSPFv2 router types.

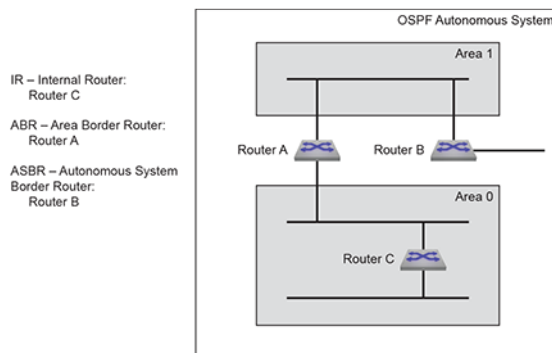

Figure 43: OSPFv2 Router Types

OSPFv2 areas are assigned a number between 0 and 4,294,967,295 (2³² - 1). Area numbers are often expressed in dotted decimal notation, similar to IP addresses.

Each AS has a backbone area, designated as area 0, that connects to all other areas. The backbone receives routing information from all areas, then distributes it to the other areas as required.

OSPFv2 area types include:

- Normal area accepts intra-area, inter-area, and external routes. The backbone is a normal area.
- Stub area does not receive router advertisements external to the AS. Stub area routing is based on a default route.
- Not-so-stubby-area (NSSA) may import external routes from an ASBR, does not receive external routes from the backbone, and does not propagate external routes to other areas.

14.2.1.3.3 Link Updates

Routers periodically send hello packets to advertise status and establish neighbors. A router's hello packet includes IP addresses of other routers from which it received a hello packet within the time specified by the router dead interval. Routers become neighbors when they detect each other in their hello packets if they:

- share a common network segment.
- are in the same area.
- have the same hello interval, dead interval, and authentication parameters.

Neighbors form adjacencies to exchange LSDB information. A neighbor group uses hello packets to elect a Designated Router (DR) and Backup Designated Router (BDR). The DR and BDR become adjacent to all other neighbors, including each other. Only adjacent neighbors share database information.

[OSPFv2 Neighbors](#) illustrates OSPFv2 neighbors.

If Routers A, B, and C have the same Hello interval, Dead interval, and authentication parameters, then

Area 1 – Router A and Router B are neighbors.

Area 0 – Router A, Router B, and Router C are neighbors.

Area 2 – Router C has no neighbors.

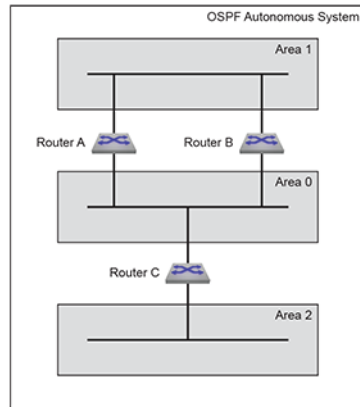

Figure 44: OSPFv2 Neighbors

The DR is the central contact for database exchanges. Switches send database information to their DR, which relays the information to the other neighbors. All routers in an area maintain identical LSDBs. Switches also send database information to their BDR, which stores this data without distributing it. If the DR fails, the BDR distributes LSDB information to its neighbors.

OSPFv2 routers distribute LSAs by sending them on all of their active interfaces. The router will generate an LSA for a network defined and active on a passive interface but will not transmit this LSA on the passive interface as no adjacencies are formed.

When a router's LSDB is changed by an LSA, it sends the changes to the DR and BDR for distribution to the other neighbors. Routing information is updated only when the topology changes.

Routers use Dijkstra's algorithm to calculate the shortest path to all known destinations, based on cumulative route cost. The cost of an interface indicates the transmission overhead and is usually inversely proportional to its bandwidth.

14.2.1.3.4 OSPFv2 Route Redistribution Instance

OSPFv2 Route Redistribution is used for redistributing OSPFv2 leaked and non-leaked routes from one instance to another when multiple OSPFv2 instances are configured. The OSPFv2 Route Redistribution is supported on all platforms in the multi-agent routing mode.

14.2.1.3.5 OSPFv2 Multiple Instances Support

EOS Release 4.22.1F adds support for multiple OSPFv2 instances to be configured in the default VRF. OSPFv2 Multiple Instances Support provides isolation and allows segregating and dividing the link state database based on the interface.

Basic OSPFv2 functionality along with redistribution of OSPFv2 routes (all instances) into BGP and default information originate always is available forward from the **EOS Release 4.22.1F**.

Support for graceful restart and BFD with multiple OSPFv2 instances was added in the **EOS Release 4.23.1**.

14.2.1.3.5.1 OSPFv2 Multiple Instances Support Platform Compatibility

OSPFv2 Multiple Instances Support is supported on all platforms.

14.2.1.3.6 OSPF Routes over GRE Tunnels

This feature introduces the support for OSPF routes over GRE tunnels under default as well as non-default VRFs. The feature is disabled by default.

14.2.1.3.6.1 Platform Compatability

The following platforms support OSPF routes over GRE tunnels:

- DCS-7050X
- DCS-7050X2
- DCS-7250X
- DCS-7300
- DCS-7060X
- DCS-7060X2
- DCS-7260X3
- CCS-720XP (Beginning in **EOS Release 4.22.1F**)
- DCS-7050SX3 (Beginning in **EOS Release 4.22.1F**)
- DCS-7010T (Beginning in **EOS Release 4.23.0F**)
- 7368 (Beginning in **EOS Release 4.23.1F**)
- CloudEOS DPDK mode (MODE=sfe in /mnt/flash/veos-config)
- Beginning in **EOS Release 4.24.1F**
 - DCS-7020
 - *Not supported on DCS-7020SRG*
 - DCS-7280R
 - DCS-7280R2
 - DCS-7500R Linecards
 - DCS-7500R2 Linecards
- Beginning in **EOS Release 4.25.1F**
 - DCS-7280R3
 - *Not supported on DCS-7280CR3MK*
 - DCS-7500R3 Linecards
 - DCS-7800R3 Linecards
- Beginning in **EOS Release 4.25.2F**
 - *Not supported on DCS-7250X, DCS7010T, DCS-7280*

14.2.1.3.6.2 Limitations

The platform does not support any arbitrarily created TCAM profile. When the TCAM profile cannot be programmed, the show command prints **ERROR** in the status column.

14.2.1.3.7 OSFP-Line System

Line system commands are used to apply configuration and query the status of OSFP-LS modules in EOS.

Platform Compatibility

Line system commands are supported on all platforms.

14.2.1.3.7.1 Configuring OSFP-Line System

OSFP-LS modules are enabled by default on insertion. Users who wish to disable any aspect of OSFP-LS modules should use the commands described in this section.

To configure an OSFP-LS module, the user must enter the line system configuration mode.

```
switch#conf
switch(config)#line system
```

```
switch(config-ls) #
```

Within the line system configuration mode, the user can enter a port configuration mode. The port number used as the command parameter is the front-panel port number where the OSFP-LS module is inserted. The user can enter the port configuration mode using a port range, similarly to how a user might configure a range of interfaces.

Example

```
switch(config-ls)#port 10
switch(config-ls-port10)#port 10,19
switch(config-ls-port10,19)#show running section line system
line system
  port 10
  !
  port 19
```

A user can revert the port's line system configurations to default values by using `no|default port X`.

Example

```
switch(config-ls-port10,19)#no port 19
switch(config-ls)#show running section line system
line system
  port 10
```

Line system port numbers are limited to any valid front-panel port numbers on the platform. For fixed systems, this means 1 to the highest front-panel port number, and on modular systems the linecard/port convention is used (For example, port 10 on Linecard4 would be port 4/10). Line system port numbers are accepted regardless of the front-panel port being physically capable of housing an OSFP-LS module.

Line system port commands is configured before a line system module is inserted. The commands take no effect until a line system module is installed. Similarly, on modular systems, line system port commands is issued for prospective ports in an empty linecard slot. The commands will take no effect until a linecard is installed in the empty slot with a line system, after which the commands will apply to the port.

Booster and Pre-amp Configuration

The OSFP-LS has two configurable optical paths:

- The booster, which is the outgoing amplifier from the local ports to the line port.
- The pre-amp, which is the line-to-local incoming amplifier.

booster|pre-amp disabled

Users can power-down the amplifier specified in the configuration command. The configuration can be undone using either the `no` or **default** prefix.

Example

```
switch(config-ls-port10)#booster disabled
switch(config-ls-port10)#pre-amp disabled
switch(config-ls-port10)#show running-config section line system
line system
  port 10
    booster disabled
    pre-amp disabled
switch(config-ls-port10)#no booster disabled
switch(config-ls-port10)#default pre-amp disabled
switch(config-ls-port10)#show running-config section line system
```

```
line system
  port 10
```

booster|pre-amp transmitter disabled

Alternatively, users can disable the transmitter only for a given optical path. This can be thought of as shuttering the laser, as opposed to turning off the amplifier. The configuration can be undone using either the no or **default** prefix.

Example

```
switch(config-ls-port10)#booster transmitter disabled
switch(config-ls-port10)#pre-amp transmitter disabled
switch(config-ls-port10)#show running-config section line system
line system
  port 10
    booster transmitter disabled
    pre-amp transmitter disabled
switch(config-ls-port10)#show running-config section line system
line system
  port 10
```

14.2.1.3.7.2 Show Commands

- **show line system [port RANGE] status**

This command displays module status. The OSFP-LS is compliant to the Common Management Interface Specification (CMIS), and implements various CMIS-defined status flags. Data path 1 reflects the outgoing booster path and data path 2 reflects the incoming pre-amp path.

Example

```
switch(config-ls-port10,19)#show line system status
```

Change	Current State	Changes	Last
-----	-----	-----	
Port 10			
Transceiver	AMP-ZR	3	
0:23:03 ago			
Transceiver SN	XDG203505010		
Presence	present		
Adapters	none		
Bad EEPROM checksums		0	
never			
Resets		0	
0:23:08 ago			
Interrupts		0	
never			
Data path firmware fault	ok	0	
never			
Module firmware fault	ok	0	
never			
Temperature high alarm	ok	0	
never			
Temperature high warn	ok	0	
never			
Temperature low alarm	ok	0	
never			
Temperature low warn	ok	0	
never			
Voltage high alarm	ok	0	
never			

Voltage high warn	ok	0
never		
Voltage low alarm	ok	0
never		
Voltage low warn	ok	0
never		
Module state	ready	2
0:22:59 ago		
Data path 1 state	initialized	12
0:16:35 ago		
Data path 2 state	initialized	12
0:16:35 ago		
Data path 3 state	unknown	0
never		
Data path 4 state	unknown	0
never		
Data path 5 state	unknown	0
never		
Data path 6 state	unknown	0
never		
Data path 7 state	unknown	0
never		
Data path 8 state	unknown	0
never		
Booster		
Operational speed	400Gbps	
RX LOS	ok	0
never		
TX fault	ok	0
never		
RX CDR LOL	ok	0
never		
TX power high alarm	ok	0
never		
TX power high warn	ok	0
never		
TX power low alarm	alarm	3
0:16:37 ago		
TX power low warn	warn	3
0:16:37 ago		
TX bias high alarm	ok	0
never		
TX bias high warn	ok	0
never		
TX bias low alarm	ok	0
never		
TX bias low warn	ok	0
never		
RX power high alarm	ok	0
never		
RX power high warn	ok	0
never		
RX power low alarm	ok	2
0:16:35 ago		
RX power low warn	ok	2
0:16:35 ago		
TX LOS		
Host lane 1	ok	0
never		
Host lane 2	ok	0
never		
Host lane 3	ok	0
never		

Host lane 4	ok	0
never		
Host lane 5	ok	0
never		
Host lane 6	ok	0
never		
Host lane 7	ok	0
never		
Host lane 8	ok	0
never		
TX CDR LOL		
Host lane 1	ok	0
never		
Host lane 2	ok	0
never		
Host lane 3	ok	0
never		
Host lane 4	ok	0
never		
Host lane 5	ok	0
never		
Host lane 6	ok	0
never		
Host lane 7	ok	0
never		
Host lane 8	ok	0
never		
TX adaptive input EQ fault		
Host lane 1	ok	0
never		
Host lane 2	ok	0
never		
Host lane 3	ok	0
never		
Host lane 4	ok	0
never		
Host lane 5	ok	0
never		
Host lane 6	ok	0
never		
Host lane 7	ok	0
never		
Host lane 8	ok	0
never		
Pre-amp		
Operational speed	50Gbps	
RX LOS	ok	0
never		
TX fault	ok	0
never		
RX CDR LOL	ok	0
never		
TX power high alarm	ok	0
never		
TX power high warn	ok	0
never		
TX power low alarm	alarm	3
0:16:37 ago		
TX power low warn	warn	3
0:16:37 ago		
TX bias high alarm	ok	0
never		
TX bias high warn	ok	0
never		

TX bias low alarm	ok	0
never		
TX bias low warn	ok	0
never		
RX power high alarm	ok	0
never		
RX power high warn	ok	0
never		
RX power low alarm	ok	2
0:16:35 ago		
RX power low warn	ok	2
0:16:35 ago		

Some lines of output do not apply to the OSFP-LS modules (**For example, Operational speed, RX CDR LOL**). These lines of output should be ignored. The fields of interest are **Module state, Data path 1 state, and Data path 2 state**. Under normal operating conditions, **Module state** will read **ready** and the **Data path state** fields will read either **initialized or activated**. Initialized means that the module is ready to operate but is receiving no signal to amplify. Activated means that the amplifier is active.

- **show line system [port RANGE] dom thresholds**

This command reports DOM information reported by the OSFP-LS module. This includes standard fields such as temperature and voltage. In addition to standard DOM fields, the OSFP-LS also monitors the laser temperature for each of its amplifiers. The reported RX power reflects the total RX power seen on that path. TX bias current monitoring is not supported on these modules and should be ignored.

Example

```
switch# show line system port 10 dom thresholds
Ch: Channel, mA: milliamperes, dBm: decibels (milliwatts),
C: Celsius, V: Volts, NA or N/A: not applicable.

Port 10
Last update: 0:00:04 ago

                                High Alarm  High Warn
Low Warn  Low Alarm
                                Value     Threshold  Threshold
Threshold  Threshold  Unit Indicator
-----
Temperature                                32.83      70.00      65.00
0.00      -5.00      C
Voltage                                3.29       3.47       3.37
3.23      3.14      V
Booster
TX bias current                                N/A        N/A        N/A
N/A        N/A      mA
Optical TX power (line)                        -3.58      7.96       7.50
-9.03     -15.06     dBm
Optical RX power (local)                       -28.24     -16.23     -17.26
-30.00    -33.01     dBm
Laser Temperature                                43.55      80.00      75.00
-5.00     -10.00     C
Pre-amp
TX bias current                                N/A        N/A        N/A
N/A        N/A      mA
Optical TX power (local)                        -3.38      7.96       7.50
-9.03     -15.06     dBm
Optical RX power (line)                       -15.42      5.77       4.77
-28.24    -30.97     dBm
```

Laser Temperature	43.54	80.00	75.00
-5.00 -10.00 C			

14.2.1.3.7.3 Troubleshooting

If an OSFP-LS does not appear to be working, the important outputs to fetch are `show line system dom thresholds` and `show line system status` for both OSFP-LS modules involved.

In `show line system status`, the expected output for both **Data path 1 state** and **Data path 2 state** is `activated`. If it is anything else, users should refer to `show line system dom thresholds`. If the datapath states report `activated` but the links are still down, users should consider L1 debugging steps on the connected ZR modules.

For `show line system dom thresholds`, if there are any alarms asserted, the most common reason is that fiber on either the duplex LC connector or the CS connector is not inserted properly. Users should check the fiber connections first on all OSFP-LS involved.

Take the following output for example. The booster RX power is healthy, but the booster TX power reads 0.00 dBm. This suggests that the OSFP-LS is receiving input into its booster but is not amplifying the signal to healthy levels. On the pre-amp side, notice that the pre-amp RX and TX powers are -30.00 dBm. The TX side can be explained by the pre-amp not receiving any signal, and the RX side suggests that the peer's TX is disabled or that the fiber is broken or inserted improperly.

```

Port 19
Last update: 0:00:00 ago

```

Warn	Low Alarm	Unit	Indicator	Value	High Alarm Threshold	High Warn Threshold	Low
0.00	-5.00	C		35.94	70.00	65.00	
3.23	3.14	V		3.29	3.47	3.37	
Booster							
N/A	N/A	mA		N/A	N/A	N/A	
-0.00	-6.03	dBm	WARN	-0.00	16.99	16.53	
-20.97	-23.98	dBm		-19.51	-7.20	-8.23	
5.00	0.00	C		34.09	75.00	70.00	
Pre-amp							
N/A	N/A	mA		N/A	N/A	N/A	
-0.00	-6.03	dBm	ALARM	-30.00	16.99	16.53	
-19.21	-21.94	dBm	ALARM	-30.00	14.80	13.80	
5.00	0.00	C		34.11	75.00	70.00	

If problems persist, users should also consider reseating and cleaning the fiber on the connected ZR modules. If there are any ZR modules connected, the booster input/RX power should read higher than -30.00 dBm.

14.2.1.3.7.4 Limitations

- Currently, the `show active` command does not work in the line system configuration mode. As a workaround, consider using `show running-config` section line system instead.

14.2.1.4 Configuring OSPFv2

These sections describe basic OSPFv2 configuration steps:

- [Configuring the OSPFv2 Instance](#)
- [Configuring OSPFv2 Areas](#)
- [OSPFv2 Area Filter by Prefix-List](#)
- [IPv4 Unnumbered Interfaces](#)
- [Configuring Interfaces for OSPFv2](#)
- [Enabling OSPFv2](#)
- [OSPFv2 Multiple Instances Support Configuration](#)
- [OSPF Routes over GRE Tunnels Configuration](#)
- [Displaying OSPFv2 Status](#)

14.2.1.4.1 Configuring the OSPFv2 Instance

14.2.1.4.1.1 Entering OSPFv2 Configuration Mode

The `router ospf` command places the switch in router-ospf configuration mode and creates an OSPFv2 instance if one was not previously created. The switch only supports one OSPFv2 instance and all OSPFv2 configuration commands apply to this instance.

When an OSPFv2 instance is already configured, the command must specify its process ID. Any attempt to define additional instances will fail and generate errors.

The process ID is local to the router and is used to identify the running OSPFv2 process. Neighbor OSPFv2 routers can have different process ID's.

Example

This command places the switch in router-ospf configuration mode and, if not previously created, creates an OSPFv2 instance with a process ID of 100.

```
switch(config)#router ospf 100
switch(config-router-ospf)#
```

14.2.1.4.1.2 Defining the Router ID

The router ID is a 32-bit number assigned to a router running OSPFv2. This number uniquely labels the router within an Autonomous System. Status commands identify the switch through the router ID.

The switch sets the router ID to the first available alternative in the following list:

1. The `router-id` command.
2. The loopback IP address, if a loopback interface is active on the switch.
3. The highest IP address on the router.



Note: When configuring VXLAN on an MLAG, always manually configure the OSPFv2 router ID to prevent the switch from using the common VTEP IP address as the router ID.

The `router-id (OSPFv2)` command configures the router ID for an OSPFv2 instance.

Example

This command assigns 10.1.1.1 as the OSPFv2 router ID.

```
switch(config-router-ospf) #router-id 10.1.1.1
switch(config-router-ospf) #
```

14.2.1.4.1.3 Global OSPFv2 Parameters

These router-ospf configuration mode commands define OSPFv2 behavior.

LSA Overload

The **max-lsa (OSPFv2)** command specifies the maximum number of LSAs allowed in an LSDB database and configures the switch behavior when the limit is approached or exceeded. An LSA overload condition triggers these actions:

- **Warning:** the switch logs OSPF MAXLSA WARNING if the LSDB contains a specified percentage of the LSA maximum.
- **Temporary shutdown:** when the LSDB exceeds the LSA maximum, OSPFv2 is disabled and does not accept or acknowledge new LSAs. The switch re-starts OSPFv2 after a specified period (the default is five minutes).
- **Permanent shutdown:** the switch permanently disables OSPFv2 after performing a specified number of temporary shutdowns (the default is five). This state usually indicates the need to resolve a network condition that consistently generates excessive LSA packets.

OSPFv2 is re-enabled with a **router ospf** command.

The LSDB size restriction is removed by setting the LSA limit to zero.

 **Note:** if OSPFv2 has entered permanent shutdown, it can also be restarted by increasing the LSA limit to a value larger than the number of LSAs in the database. Setting the max-LSA value to zero will also restart OSPFv2, and will disable overload protection.

Example

- This command configures the OSPFv2 maximum LSA count to 20,000 and triggers these actions:
 - The switch logs an OSPF MAXLSA WARNING if the LSDB has 8,000 LSAs (40% of 20,000).
 - The switch temporarily disables OSPFv2 for 10 minutes if the LSDB contains 20,000 LSAs.
 - The switch permanently disables OSPFv2 after four temporary OSPFv2 shutdowns.
 - The shutdown counter resets if the LSDB contains less than 20,000 LSAs for 20 minutes.

```
switch(config-router-ospf) #max-lsa 20000 40 ignore-time 10 ignore-count
4 reset-time 20
switch(config-router-ospf) #
```

Logging Adjacency Changes

The **log-adjacency-changes (OSPFv2)** command configures the switch to log OSPFv2 link-state changes and transitions of OSPFv2 neighbors into the up or down state.

Examples

- This command configures the switch to log transitions of OSPFv2 neighbors into the up or down state.

```
switch(config-router-ospf) #log-adjacency-changes
switch(config-router-ospf) #
```

- This command configures the switch to log all OSPFv2 link-state changes.

```
switch(config-router-ospf) #log-adjacency-changes detail
```

```
switch(config-router-ospf) #
```

OSPF RFC Compatibility

RFC 2328 and RFC 1583 specify different methods for calculating summary route metrics. The `compatible (OSPFv2)` command allows the selective disabling of compatibility with RFC 2328.

Example

This command sets the OSPF compatibility list with RFC 1583.

```
switch(config) #router ospf 6
switch(config-router-ospf) #compatible rfc1583
switch(config-router-ospf) #
```

Administrative Distance

The `distance ospf (OSPFv2)` command configures the administrative distance for intra-area, inter-area, or external OSPF routes. To configure the administrative distance for multiple route types, the command must be entered multiple times. Administrative distances compare dynamic routes configured by different protocols. The default administrative distance for all routes is 110.

 **Note:** OSPF links will flap if the administrative distance value is adjusted while OSPF is running, whether it is adjusted by entering the `distance ospf` command directly through the CLI or by applying a configuration file that contains the command.

Example

This command configures an administrative distance of 95 for OSPFv2 intra-area routes, and will cause links to flap if issued while OSPF is running.

```
switch(config-router-ospf) #distance ospf intra-area 95
switch(config-router-ospf) #
```

Passive Interfaces

The `passive-interface <interface> (OSPFv2)` command prevents the transmission of hello packets on the specified interface. Passive interfaces drop all adjacencies and do not form new adjacencies. Passive interfaces send LSAs but do not receive them. The router does not send or process OSPFv2 packets received on passive interfaces. The router advertises the passive interface in the router LSA.

The `no passive-interface` command re-enables OSPFv2 processing on the specified interface.

Examples

- This command configures VLAN 2 as a passive interface.

```
switch(config-router-ospf) #passive-interface vlan 2
switch(config-router-ospf) #
```

- This command configures VLAN 2 as an active interface.

```
switch(config-router-ospf) #no passive-interface vlan 2
switch(config-router-ospf) #
```

Redistributing Connected Routes

Redistributing connected routes causes the OSPFv2 instance to advertise all connected routes on the switch as external OSPFv2 routes. Connected routes are routes that are established when IPv4 is enabled on an interface.

Example

The `redistribute (OSPFv2) connected` command converts connected routes to OSPFv2 external routes.

```
switch(config-router-ospf) #redistribute connected
switch(config-router-ospf) #
```

Redistributing Static Routes

Redistributing static routes causes the OSPFv2 instance to advertise all static routes on the switch as external OSPFv2 routes. The switch does not support redistributing individual static routes.

Examples

- The `redistribute (OSPFv2) static` command converts the static routes to OSPFv2 external routes.

```
switch(config-router-ospf) #redistribute static
switch(config-router-ospf) #
```

- The `no redistribute (OSPFv2)` command stops the advertising of the static routes as OSPFv2 external routes.

```
switch(config-router-ospf) #no redistribute static
switch(config-router-ospf) #
```

Filtering Routes with Distribute Lists

An OSPF distribute list uses a route map or prefix list to filter specific routes from incoming OSPF LSAs; this filtering occurs after SPF calculation. The filtered routes are not installed on the switch, but are still included in LSAs sent by the switch. An OSPF router instance can have one distribute list configured.

If a prefix list is used, destination prefixes that do not match the prefix list will not be installed. If a route map is used, routes may be filtered based on address, next hop, or metric. OSPF external routes may also be filtered by metric type or tag.

The `distribute-list in` command specifies the filter to be used and applies it to the OSPF instance.

Example

These commands configure a prefix-list named `dist_list1` in OSPF instance 5 to filter certain routes from incoming OSPF LSAs.

```
switch(config) #router ospf 5
switch(config-router-ospf) #distribute-list prefix-list dist_list1 in
switch(config-router-ospf) #
```

14.2.1.4.1.4 Configuring OSPFv2 Route Redistribution

Use the `redistribute ospf instance` command to redistribute either the non-leaked routes, or both leaked and non-leaked routes. This command is configured under the `router-ospf` mode.

Example

- The **leaked** clause includes both internal and external routes.

```
switch(config-router-ospf)#redistribute ospf instance include leaked
<cr>
Options:
  include      Include leaked routes
  match        Routes learned by the OSPF protocol
  route-map    Specify which route map to use
```

- The **match** clause allows matching on the different OSPFv2 route types.

```
switch(config-router-ospf)#redistribute ospf instance match external
<cr>
Options:
  external      OSPF routes learned from external sources
  internal      OSPF routes learned from internal sources
  nssa-external OSPF routes learned from external NSSA sources
```

- The following command redistributes the OSPFv2 external routes from all other OSPFv2 instances in the same VRF into the given instance

```
switch(config-router-ospf)#redistribute ospf instance match external
```

- The following command redistributes the OSPFv2 internal leaked and non-leaked routes from all other instances in all VRFs into the given instance.

```
switch(config-router-ospf)#redistribute ospf instance include leaked
match internal
```

- Matching based on the OSPFv2 instance ID is supported in the route-map.

```
switch(config)#route-map rm1 permit 10
switch(config-route-map-rm1)#match ospf instance 3
```

- The following command redistributes the OSPFv2 external routes from the OSPFv2 instance with ID 3 in the same VRF into the given instance.

```
switch(config-router-ospf)#redistribute ospf instance match external
route-map rm1
```

Show Commands

- The `show ip ospf database external` command is used to verify if the AS-External LSAs are created in the instance for the redistributed route and advertised into the OSPFv2 domain.
- The `show route-map` command is used to display the details of a configured route-map.

14.2.1.4.2 Configuring OSPFv2 Areas

OSPFv2 areas are configured through area commands. The switch must be in router-ospf configuration mode, as described in [Entering OSPFv2 Configuration Mode](#), to run area commands.

Areas are assigned a 32-bit number that is expressed in decimal or dotted-decimal notation. When an OSPFv2 instance configuration contains multiple areas, the switch only configures areas associated with its interfaces.

14.2.1.4.2.1 Configuring the Area Type

The **area (OSPFv2)** commands specifies the area type, refer [OSPFv2 Commands](#) section for the **area** commands. The switch supports three area types:

- Normal area: Area that accepts intra-area, inter-area, and external routes. The backbone area (area 0) is a normal area.
- Stub area: Area that does not advertise external routes. External routes are reached through a default summary route (0.0.0.0). Networks with no external routes do not require stub areas.
- NSSA (Not So Stubby Area): ASBRs advertise external LSAs directly connected to the area. External routes from other areas are not advertised and are reached through a default summary route.

The default area type is normal.

Examples

- This command configures area 45 as a stub area.

```
switch(config-router-ospf) #area 45 stub
switch(config-router-ospf) #
```

- This command configures area 10.92.148.17 as an NSSA.

```
switch(config-router-ospf) #area 10.92.148.17 NSSA
switch(config-router-ospf) #
```

14.2.1.4.2.2 Blocking All Summary Routes from Flooding the NSSA

The **area nssa no-summary (OSPFv2)** command configures the router to not import type-3 summary LSAs into the not-so-stubby area (NSSA) and injects a default summary route (0.0.0.0/0) into the NSSA to reach the inter-area prefixes.

Example

This command directs the device not to import type-3 summary LSAs into the NSSA area and injects a default summary route (0.0.0.0/0) into the NSSA area.

```
switch(config) #router ospf 6
switch(config-router-ospf) #area 1.1.1.1 nssa no-summary
switch(config-router-ospf) #
```

14.2.1.4.2.3 Assigning Network Segments to the Area

Assigning Routes to an Area

The **network area (OSPFv2)** command assigns the specified network segment to an OSPFv2 area. The network can be entered in CIDR notation or by an address and wildcard mask.

The switch zeroes the host portion of the specified network address e.g. 1.2.3.4/24 converts to 1.2.3.0/24 and 1.2.3.4/16 converts to 1.2.0.0/16

Example

Each of these equivalent commands assign the network segment 10.1.10.0/24 to area 0.

```
switch(config-router-ospf) #network 10.1.10.0 0.0.0.255 area 0
switch(config-router-ospf) #
switch(config-router-ospf) #network 10.1.10.0/24 area 0
switch(config-router-ospf) #
```

In each case, *running-config* stores the command in CIDR (prefix) notation.

Summarizing Routes

By default, ABRs create a summary LSA for each route in an area and advertise them to adjacent routers. The `area range (OSPFv2)` command aggregates routing information, allowing the ABR to advertise multiple routes with one LSA. The `area range (OSPFv2)` command can be used to suppress route advertisements.

Examples

- Two `network area` command assigns subnets to an area. The `area range (OSPFv2)` command summarizes the addresses, which the ABR advertises in a single LSA.

```
switch(config-router-ospf) #network 10.1.25.80 0.0.0.240 area 5
switch(config-router-ospf) #network 10.1.25.112 0.0.0.240 area 5
switch(config-router-ospf) #area 5 range 10.1.25.64 0.0.0.192
switch(config-router-ospf) #
```

- The `network area` command assigns a subnet to an area, followed by an `area range (OSPFv2)` command that suppresses the advertisement of that subnet.

```
switch(config-router-ospf) #network 10.12.31.0 0.0.0.255 area 5
switch(config-router-ospf) #area 5 range 10.12.31.0 0.0.0.255 not-
advertise
switch(config-router-ospf) #
```

14.2.1.4.2.4 Configuring Area Parameters

These router-ospf configuration mode commands define OSPFv2 behavior in a specified area.

Default Summary Route Cost

The `area default-cost (OSPFv2)` command specifies the cost of the default summary route that ABRs send into a stub area or NSSA. Summary routes, also called inter-area routes, originate in areas different than their destination.

Example

This command configures a cost of 15 for the default summary route in area 23.

```
switch(config-router-ospf) #area 23 default-cost 15
switch(config-router-ospf) #
```

Filtering Type 3 LSAs

The `area filter (OSPFv2)` command prevents an area from receiving Type 3 (Summary) LSAs from a specified subnet. Type 3 LSAs are sent by ABRs and contain information about one of its connected areas.

Example

This command prevents the switch from entering Type 3 LSAs originating from the 10.1.1.2/24 subnet into its area 2 LSDB.

```
switch(config-router-ospf) #area 2 filter 10.1.1.2/24
switch(config-router-ospf) #
```

14.2.1.4.3 OSPFv2 Area Filter by Prefix-List

The `ospf area <area_id> filter` command configures the set of prefixes to be filtered for multi-agent routing and the `ribd` routing protocols. Area filters are used to prevent specific prefixes from being announced by an area as Type 3 summary LSAs in an OSPFv2 Area Border Router (ABR).

Examples

The following configures a prefix-list filter to permit two prefixes and deny all others.

```
switch(config)# ip prefix-list type3Permit
switch(config-ip-pfx)# ip seq 10 permit 10.0.1.0/24
switch(config-ip-pfx)# ip seq 20 permit 10.0.2.0/24
switch(config-ip-pfx)# ip seq 30 deny 10.0.0.0/0
switch(config-ip-pfx)# exit
```

The following applies the filter to the backbone area.

```
switch(config)# router ospf 1
switch(config-router-ospf)# area 0 filter prefix-list type3Permit
```

The following configures a prefix-list to deny a list of prefixes and permit all others.

```
switch(config)# ip prefix-list type3Deny
switch(config-ip-pfx)# ip seq 10 deny 10.0.1.0/24
switch(config-ip-pfx)# ip seq 20 deny 10.0.2.0/24
switch(config-ip-pfx)# exit
```

The following applies the filter.

```
switch(config)# router ospf 1
switch(config-router-ospf)# area 1.1.1.1 filter prefix-list type3Deny
```

Show commands

The following displays the output of `show ip ospf` with the area filter listed.

```
switch# show ip ospf
Area 3.3.3.3
  Number of interface in this area is 2
  It is a normal area
  Traffic engineering is disabled
  Area has None authentication
  SPF algorithm executed 1 times
  Number of LSA 1. Checksum Sum 53568
  Number of opaque link LSA 0. Checksum Sum 0
  Number of opaque area LSA 0. Checksum Sum 0
  Area ranges are
    3.3.0.0/16 Cost 0 Advertise
    3.30.0.0/16 Cost 0 Advertise
  Area filter prefix-list type3Permit
```

14.2.1.4.4 IPv4 Unnumbered Interfaces

The `ip address unnumbered <lendingIntf>` command specifies a lending interface from which many interfaces may borrow the same address, reducing the number of unique IPv4 addresses needed. A lending interface is a loopback interface. Only one borrowing interface is referenced to one lender at a time even though multiple loopbacks may be used as lending interfaces. Unnumbered

interfaces may reference the same or different lending interfaces. Any IPv4 routed interface is configurable as unnumbered interface and is referenced to one lending interface.

The following configures an unnumbered borrowing interface.

```
switch(config)# interface Ethernet1
switch(config-if-Et1)# ip address unnumbered Loopback1
```

OSPF configuration

To enable OSPF on an unnumbered interface, configure the area and set the network type to point-to-point under the *interface config mode*.

```
switch(config-if-Et1)# ip ospf area 1
switch(config-if-Et1)# ip ospf network point-to-point
```



Note: The `network` command under *router ospf* configuration mode is not supported for the configuration of unnumbered interfaces. You must specify the area and `network point-to-point` command in the config context of the unnumbered interface.

Enabling OSPF on the lending interface in the same area as the borrowing interfaces is recommended. For different unnumbered interfaces in different areas, configure them to use different loopbacks.

```
switch(config)# interface loopback 1
switch(config-if-Lo1)# ip address 1.1.1.1/32
switch(config-if-Lo1)# ip ospf area 1
```

ISIS configuration

To enable ISIS on an unnumbered interface, configure the area and set the network type to point-to-point under the *interface config mode*.

```
switch(config-if-Et1)# isis enable inst1
switch(config-if-Et1)# isis network point-to-point
```

Enabling ISIS on the lending interface in the same area as the borrowing interfaces is recommended.

```
switch(config)# interface loopback 1
switch(config-if-Lo1)# ip address 1.1.1.1/32
switch(config-if-Et1)# isis enable inst1
switch(config-if-Et1)# isis network point-to-point
```

Show commands

The same IP address that may be in use on multiple interfaces at the same time, and is displayed as shown below.

The following displays the output of `show ip interface brief`. In this example Ethernet2-5 are all unnumbered and borrowing from loopback1.

```
switch(config-if-Et2)# show ip interface brief

Address
Interface      IP Address      Status      Protocol      MTU
Owner
-----
-----
Ethernet1      1.1.2.1/24      up          up            1500
```

Ethernet2 Lo1	1.1.1.1/32	up	up	1500
Ethernet3 Lo1	1.1.1.1/32	up	up	1500
Ethernet4 Lo1	1.1.1.1/32	up	up	1500
Ethernet5 Lo1	1.1.1.1/32	up	up	1500
Loopback1	1.1.1.1/32	up	up	65535

The following displays OSPF with two adjacencies with the same peer via Ethernet 2 and Ethernet 3. The same Neighbor ID is listed for both interfaces. IS-IS behaves similarly.

```
switch(config-if-Et2)# show ip ospf neighbor
Neighbor ID      Instance VRF      Pri State      Dead Time
Address          Interface
2.2.1.1         1      default  0  FULL      00:00:36
2.2.1.1         Ethernet3
2.2.1.1         1      default  0  FULL      00:00:34
2.2.1.1         Ethernet2
```

Limitations

- Configuring the addresses on the lending loopbacks as /32 is recommended. In order to resolve routes via an unnumbered peer, the /32 address is required. Configuring a lending loopback as /32 and enabling OSPF/ISIS on it propagates that prefix.
- Use only loopback interfaces as a lending interface.
- Enable only one IGP on a lending loopback interface. For multiple IGPs enable each on a different loopback.
- Configure only one BFD multi-hop session per loopback.
- SSO is not supported for BFD multihop sessions over unnumbered interfaces.
- OSPFv3 does not support unnumbered interface addressing.

14.2.1.4.5 Configuring Interfaces for OSPFv2

OSPFv2 interface configuration commands specify transmission parameters for routed ports and SVIs that handle OSPFv2 packets.

14.2.1.4.5.1 Configuring Authentication

OSPFv2 authenticates packets through passwords configured on VLAN interfaces. Interfaces connecting to the same area can authenticate packets if they have the same key. By default, OSPFv2 does not authenticate packets.

OSPFv2 supports simple password and message digest authentication:

- Simple password authentication: A password is assigned to an area. Interfaces connected to the area can authenticate packets by enabling authentication and specifying the area password.
- Message digest authentication: Each interface is configured with a key (password) and key-id pair. When transmitting a packet, the interface generates a string, using the MD5 algorithm, based on the OSPFv2 packet, key, and key ID, then appends that string to the packet.

Message digest authentication supports uninterrupted transmissions during key changes by allowing each interface to have two keys with different key IDs. When a new key is configured on an interface, the router transmits OSPFv2 packets for both keys. Once the router detects that all neighbors are using the new key, it stops sending the old one.

Implementing authentication on an interface is a two step process:

1. Enabling authentication.
2. Configuring a key (password).

To configure simple authentication on a VLAN interface:

1. Enable simple authentication with the `ip ospf authentication` command.

```
switch(config-if-vl12) #ip ospf authentication
```

2. Configure the password with the `ip ospf authentication-key` command.

```
switch(config-if-vl12) #ip ospf authentication-key 0 code123
```

The **running-config** stores the password as an encrypted string, using a proprietary algorithm. To configure Message-Digest authentication on a VLAN interface:

1. Enable Message-Digest authentication with the `ip ospf authentication message-digest` command.

```
switch(config-if-vl12) #ip ospf authentication message-digest
```

2. Configure the key ID and password with the `ip ospf message-digest-key` command.

```
switch(config-if-vl12) #ip ospf message-digest-key 23 md5 0 code123
```

The **running-config** stores the password as an encrypted string, using a proprietary algorithm. The key ID (23) is between keywords **message-digest-key** and **md5**.

14.2.1.4.5.2 Configuring Intervals

Interval configuration commands determine OSPFv2 packet transmission characteristics for the specified VLAN interface and are entered in interface-vlan configuration mode.

Hello Interval

The hello interval specifies the period between consecutive hello packet transmissions from an interface. Each OSPFv2 neighbor should specify the same hello interval, which should not be longer than any neighbors dead interval.

The `ip ospf hello-interval` command configures the hello interval for the configuration mode interface. The default is 10 seconds.

Example

This command configures a hello interval of 30 seconds for VLAN 2.

```
switch(config-if-Vl2) #ip ospf hello-interval 30
switch(config-if-Vl2) #
```

Dead Interval

The dead interval specifies the period that an interface waits for an OSPFv2 packet from a neighbor before it disables the adjacency under the assumption that the neighbor is down. The dead interval should be configured identically on all OSPFv2 neighbors and be longer than the hello interval of any neighbor.

The `ip ospf dead-interval` command configures the dead interval for the configuration mode interface. The default is 40 seconds.

Example

This command configures a dead interval of 120 seconds for VLAN 4.

```
switch(config-if-V14) #ip ospf dead-interval 120
switch(config-if-V14) #
```

Retransmit Interval

Routers that send OSPFv2 advertisements to an adjacent router expect to receive an acknowledgment from that neighbor. Routers that do not receive an acknowledgment will retransmit the advertisement. The retransmit interval specifies the period between retransmissions.

The `ip ospf retransmit-interval` command configures the LSA retransmission interval for the configuration mode interface. The default retransmit interval is 5 seconds.

Example

This command configures a retransmit interval of 15 seconds for VLAN 3.

```
switch(config-if-V13) #ip ospf retransmit-interval 15
switch(config-if-V13) #
```

Transmission Delay

The transmission delay is an estimate of the time that an interface requires to transmit a link-state update packet. OSPFv2 adds this delay to the age of outbound packets to more accurately reflect the age of the LSA when received by a neighbor. The default transmission delay is one second.

The `ip ospf transmit-delay` command configures the transmission delay for the configuration mode interface.

Example

This command configures a transmission delay of 5 seconds for VLAN 6.

```
switch(config-if-V16) #ip ospf transmit-delay 5
switch(config-if-V16) #
```

14.2.1.4.5.3 Configuring Interface Parameters

Interface Cost

The OSPFv2 interface cost (or metric) reflects the overhead of sending packets across the interface. The cost is typically inversely proportional to the bandwidth of the interface. The default cost is 10.

The `ip ospf cost` command configures the OSPFv2 cost for the configuration mode interface.

Example

This command configures a cost of 15 for VLAN 2.

```
switch(config-if-V12) #ip ospf cost 15
switch(config-if-V12) #
```

Router Priority

Router priority determines preference during designated router (DR) and backup designated router (BDR) elections. Routers with higher priority numbers have preference over other routers. Routers with a priority of zero cannot be elected as a DR or BDR.

The `ip ospf priority` command configures router priority for the configuration mode interface. The default priority is 1.

Examples

- This command configures a router priority of 15 for VLAN 8.

```
switch(config-if-Vl8)#ip ospf priority 15
switch(config-if-Vl8)#
```

- This command restores the router priority of 1 for VLAN 7.

```
switch(config-if-Vl7)#no ip ospf priority
switch(config-if-Vl7)#
```

14.2.1.4.6 Enabling OSPFv2

14.2.1.4.6.1 Disabling OSPFv2

The switch can disable OSPFv2 operations without disrupting the OSPFv2 configuration.

- `shutdown (OSPFv2)` disables all OSPFv2 activity.
- `ip ospf disabled` disables OSPFv2 activity on a VLAN interface.

The `no shutdown` and `no ip ospf disabled` commands resume OSPFv2 activity.

Examples

- This command disables OSPFv2 activity on the switch.

```
switch(config-router-ospf)#shutdown
switch(config-router-ospf)#
```

- This command resumes OSPFv2 activity on the switch.

```
switch(config-router-ospf)#no shutdown
switch(config-router-ospf)#
```

- This command disables OSPFv2 activity on VLAN 5.

```
switch(config-if-Vl5)#ip ospf disabled
switch(config-if-Vl5)#
```

14.2.1.4.6.2 IPv4 Routing

OSPFv2 requires that IPv4 routing is enabled on the switch. When IP routing is not enabled, entering OSPFv2 configuration mode generates a message.

Examples

- This message is displayed if, when entering router-ospf configuration mode, IP routing is not enabled.

```
switch(config)#router ospf 100
! IP routing not enabled
switch(config-router-ospf)#
```

- This command enables IP routing on the switch.

```
switch(config)#ip routing
switch(config)#
```

14.2.1.4.7 OSPFv2 Multiple Instances Support Configuration

The existing OSPFv2 configuration commands remain unchanged and are used for configuring multiple OSPFv2 instances. Each OSPFv2 instance in the default VRF is identified by a unique instance ID.

```
router ospf [ id vrf | general ]
```

14.2.1.4.7.1 Redistribute Configuration

Configuring the `redistribute ospf` command under the `config-router-bgp` mode with multiple OSPFv2 instances configured redistributes routes from all OSPFv2 instances into BGP.

These commands redistribute OSPFv2 routes into the BGP domain.

```
switch(config)#router bgp 1
switch(config-router-bgp)#redistribute OSPF
switch(config-router-bgp)#
```

14.2.1.4.7.2 Special Cases

Route Selection in case of Ties between Instances

When the same prefix happens to be learned in multiple instances with the same metric, route-type are used as the first criteria to tie break:

O > O IA > N1 > N2 > E1 > E2

```
Codes: O - OSPF, IA - OSPF inter area, E1 - OSPF external type 1,
       E2 - OSPF external type 2, N1 - OSPF NSSA external type 1,
       N2 - OSPF NSSA external type2
```

When routes have identical route-type as well, the route with the lowest nexthop IP address is selected.

 **Note:** An ECMP route is not created in this case.

Overlapping Network Statements Configured

The CLI does not guard against overlapping network statements configured in different instances. This state is a misconfiguration.

14.2.1.4.7.3 OSPFv2 Multiple Instances Limitations

- OSPFv2 Multiple Instances is available only with the multi-agent routing protocol model.
- Only one interface can only have one instance of OSPFv2 running at any point in time.
- All the OSPFv2 instances must be in the default VRF.
- Multiple OSPFv2 instances can not be connected to the same network or configured with interfaces in the same area. In particular, multiple OSPFv2 instances may not be connected to the same instance on another router, in the same area.

- The following features are not supported with multiple OSPFv2 instances:
 - Redistributing routes from a specific OSPFv2 instance into BGP.
 - Redistribution of routes into an OSPFv2 instance.
 - Per interface area configuration.
 - Passive interface configuration.
 - SNMP.
 - Summary address.
 - Service ACL.
 - Max Metric with `on-startup` configuration.

14.2.1.4.8 OSPF Routes over GRE Tunnels Configuration

The following commands may be employed in the router OSPF mode:

- `tunnel routes`
- `no tunnel routes`
- `default tunnel routes`

To enable OSPFv2 over GRE tunnels, use the following commands:

```
switch(config)#router ospf 6
switch(config-router-ospf)#tunnel routes
switch(config-router-ospf)#
```

To disable OSPFv2 routes over GRE tunnels, use the following commands:

```
switch(config)#router ospf 6
switch(config-router-ospf)#no tunnel routes
switch(config-router-ospf)#
```

To enable the default OSPFv2 routes over GRE tunnels, use the following commands:

```
switch(config)#router ospf 6
switch(config-router-ospf)#default tunnel routes
switch(config-router-ospf)#
```

14.2.1.4.8.1 TCAM Profile Configuration

On DCS-7020, DCS-7280R/R2, or DCS-7500R/R2, enabling OSPF routes over GRE tunnels requires the system TCAM profile to have “Tunnel IPv4” feature enabled so that control packets such as OSPF hellos received over GRE tunnel interfaces are appropriately classified. This can be achieved by creating a user defined TCAM profile as described below.

The user defined TCAM profile can be created either manually from scratch or by copying from an existing TCAM profile. The system TCAM profile must have the feature **tunnel ipv4** for the OSPFv2 over GRE tunnel interfaces to work. This is applicable regardless of whether the TCAM profile is copied from an existing profile or created from scratch.

14.2.1.4.8.2 User Defined PMF (or TCAM) Profiles

This section describes a set of CLI commands to create user defined PMF (or TCAM) profile. The profile is composed of a set of TCAM features, with each feature having customized lookup key, actions and packet types to hit.

All TCAM profile CLIs are under **hardware tcam** mode.

```
(config)#hardware tcam
```

```
(config-hw-tcam) #
```

There are two ways to create a TCAM profile. The recommended way is to create a profile based on an existing one. In this example, a copy of the profile *newprofile1* is created.

```
(config) #hardware tcam
(config-hw-tcam) #profile newprofile1 copy default
(config-hw-tcam-profile-newprofile1) #
```

The other way is to create one profile from scratch. In this example, the profile *newprofile2* is created.

```
(config) #hardware tcam
(config-hw-tcam) #profile newprofile2
(config-hw-tcam-profile-newprofile2) #
```

To remove a profile, use the `no profile` command similar to the following. In this example, the profile *newprofile2* is removed.

```
(config) #hardware tcam
(config-hw-tcam) #no profile newprofile2
```

Features can be turned on and off in the new profile. In this example, the feature *acl port ipv6* is turned on.

```
(config-hw-tcam-profile-<profile>) #feature acl port ipv6
```

Features can be turned on and off in the new profile. In this example, the feature *acl port ipv6* is turned off.

```
(config-hw-tcam-profile-<profile>) #no feature acl port ipv6
```

The features are described by hierarchical CLI tokens. For example, IPv4 port ACL is represented by *feature acl port ip* and IPv6 port ACL is represented by *feature acl port ipv6*. Under each feature mode, there are various fields that can be modified.

- **packet**

This describes packet types that the feature will be applied on.

```
(config-hw-tcam-profile-<profile>-feature-<feature>) #[no]packetpacket
header tokens
forwarding<bridged|routed|mpls>[multicast] [decap]
```

The packet header is described a series of CLI packet header tokens after **packet** token. It starts from the outer most header after Ethernet. For example, a regular IPv4 packet is *packet ipv4* and a vxlan packet is *packet ipv4 vxlan eth ipv4*. The **forwarding** token indicates the forwarding type of the packet. **multicast** indicates if the packet is a multicast packet. Lastly, **decap** indicates if the packet is decapsulated after a tunnel.

- **key field**

This describes the TCAM key format for the feature. The CLI can add or delete fields that are used to build the key.

```
(config-hw-tcam-profile-<profile>-feature-<feature>)
#[no]keyfield field
```

All supported key fields can be found with `key field ?`

- **key size**

This describes the TCAM key size limit. If too many key fields are added to the feature so that the key size goes beyond the limit, a Syslog will be issued. The default key size limit is **320**.

```
(config-hw-tcam-profile-<profile>-feature-<feature>)#[no]key size
limit size
```

- **action**

This describes the action to take if a TCAM entry is hit.

```
(config-hw-tcam-profile-<profile>-feature-<feature>)#[no]action action
```

The supported actions can be found through **action ?**.

- **sequence**

This describes the programming order of each feature. Changing the order may affect the programming status of a profile. The default sequence is **0**.

```
(config-hw-tcam-profile-<profile>-feature-<feature>)
#[no]sequence sequence
```

The profile is saved after exiting the feature mode. To use the newly defined profile, a CLI is available to apply the profile to the system globally.

```
(config)#hardware tcam
(config-hw-tcam)#system profile newprofile1
```

14.2.1.4.9 Displaying OSPFv2 Status

This section describes OSPFv2 **show** commands that display OSPFv2 status. General switch methods that provide OSPFv2 information include pinging routes, viewing route status (**show ip route** command), and viewing the configuration (**show running-config** command).

14.2.1.4.9.1 OSPFv2 Summary

The **show ip ospf** command displays general OSPFv2 configuration information and operational statistics.

Example

- This command displays general OSPFv2 information.

```
switch#show ip ospf
Routing Process "ospf 1" with ID 10.168.103.1
Supports opaque LSA
Maximum number of LSA allowed 12000
Threshold for warning message 75%
Ignore-time 5 minutes, reset-time 5 minutes
Ignore-count allowed 5, current 0
It is an area border router
Hold time between two consecutive SPFs 5000 msec
SPF algorithm last executed 00:00:09 ago
Minimum LSA interval 5 secs
Minimum LSA arrival 1000 msec
Number of external LSA 0. Checksum Sum 0x000000
Number of opaque AS LSA 0. Checksum Sum 0x000000
Number of LSA 27.
Number of areas in this router is 3. 3 normal 0 stub 0 nssa
Area BACKBONE(0.0.0.0)
```

```

Number of interfaces in this area is 2
It is a normal area
Area has no authentication
SPF algorithm executed 153 times
Number of LSA 8. Checksum Sum 0x03e13a
Number of opaque link LSA 0. Checksum Sum 0x000000
Area 0.0.0.2
Number of interfaces in this area is 1
It is a normal area
Area has no authentication
SPF algorithm executed 153 times
Number of LSA 11. Checksum Sum 0x054e57
Number of opaque link LSA 0. Checksum Sum 0x000000
Area 0.0.0.3
Number of interfaces in this area is 1
It is a normal area
Area has no authentication
SPF algorithm executed 5 times
Number of LSA 6. Checksum Sum 0x02a401
Number of opaque link LSA 0. Checksum Sum 0x000000

```

The output lists configuration parameters and operational statistics and status for the OSPFv2 instance, followed by a brief description of the areas located on the switch.

14.2.1.4.9.2 Viewing OSPFv2 on the Interfaces

The `show ip ospf interface` command displays OSPFv2 information for switch interfaces configured for OSPFv2. Different command options allow the display of either all interfaces or a specified interface. The command can also be configured to display complete information or a brief summary.

Examples

- This command displays complete OSPFv2 information for VLAN 1.

```

switch#show ip ospf interface vlan 1
Vlan1 is up, line protocol is up (connected)
Internet Address 10.168.0.1/24, Area 0.0.0.0
Process ID 1, Router ID 10.168.103.1, Network Type BROADCAST, Cost: 10
Transmit Delay is 1 sec, State BDR, Priority 1
Designated Router is 10.168.104.2
Backup Designated router is 10.168.103.1
Timer intervals configured, Hello 10, Dead 40, Retransmit 5
Neighbor Count is 1
MTU is 1500
switch#

```

The display indicates the switch is an ABR by displaying a neighbor count, the Designated Router, and Backup Designated Router.

- This command displays a summary of interface information for the switch.

```

switch#show ip ospf interface brief
InterfacePIDAreaIP AddressCostStateNbrs
Loopback010.0.0.010.168.103.1/2410DR0
Vlan110.0.0.010.168.0.1/2410BDR1
Vlan210.0.0.210.168.2.1/2410BDR1
Vlan310.0.0.310.168.3.1/2410DR0
switch#

```

Configuration information includes the Process ID (PID), area, IP address, and cost. OSPFv2 operational information includes the Designated Router status and number of neighbors.

14.2.1.4.9.3 Viewing the OSPFv2 Database

The `show ip ospf database <link state list>` command displays the LSAs in the LSDB for the specified area. If no area is listed, the command displays the contents of the database for each area on the switch. The database command provides options to display subsets of the LSDB database, a summary of database contents, and the link states that comprise the database.

Examples

- This command displays LSDB contents for area 2.

```
switch#show ip ospf 1 2 database

OSPF Router with ID(10.168.103.1) (Process ID 1)

Router Link States (Area 0.0.0.2)

Link IDADV RouterAgeSeq#Checksum Link count
10.168.103.110.168.103.100:29:080x80000031 0x001D5F 1
10.168.104.210.168.104.200:29:090x80000066 0x00A49B 1

Net Link States (Area 0.0.0.2)

Link IDADV RouterAgeSeq#Checksum
10.168.2.110.168.103.100:29:080x80000001 0x00B89D

Summary Net Link States (Area 0.0.0.2)

Link IDADV RouterAgeSeq#Checksum
10.168.0.010.168.103.100:13:200x80000028 0x0008C8
10.168.0.010.168.104.200:09:160x80000054 0x00A2FF
10.168.3.010.168.104.200:24:160x80000004 0x00865F
10.168.3.010.168.103.100:24:200x80000004 0x002FC2
10.168.103.010.168.103.100:14:200x80000028 0x0096D2
10.168.103.010.168.104.200:13:160x80000004 0x00364B
10.168.104.010.168.104.200:08:160x80000055 0x002415
10.168.104.010.168.103.100:13:200x80000028 0x00EF6E
switch#
```

- This command displays an LSDB content summary for area 2.

```
switch#show ip ospf 1 2 database database-summary

OSPF Router with ID(10.168.103.1) (Process ID 1)

Area 0.0.0.2 database summary
LSA TypeCount
Router2
Network1
Summary Net8
Summary ASBR0
Type-7 Ext0
Opaque Area0
Subtotal11

Process 1 database summary
LSA TypeCount
Router2
Network1
Summary Net8
Summary ASBR0
Type-7 Ext0
Opaque Area0
```

```
Type-5 Ext0
Opaque AS0
Total11
switch#
```

- This command displays the router Link States contained in the area 2 LSDB.

```
switch#show ip ospf 1 2 database router

OSPF Router with ID(10.168.103.1) (Process ID 1)

Router Link States (Area 0.0.0.2)

LS age: 00:02:16
Options: (E DC)
LS Type: Router Links
Link State ID: 10.168.103.1
Advertising Router: 10.168.103.1
LS Seq Number: 80000032
Checksum: 0x1B60
Length: 36
Number of Links: 1

Link connected to: a Transit Network
(Link ID) Designated Router address: 10.168.2.1
(Link Data) Router Interface address: 10.168.2.1
Number of TOS metrics: 0
TOS 0 Metrics: 10

LS age: 00:02:12
Options: (E DC)
LS Type: Router Links
Link State ID: 10.168.104.2
Advertising Router: 10.168.104.2
LS Seq Number: 80000067
Checksum: 0xA29C
Length: 36
Number of Links: 1

Link connected to: a Transit Network
(Link ID) Designated Router address: 10.168.2.1
(Link Data) Router Interface address: 10.168.2.2
Number of TOS metrics: 0
TOS 0 Metrics: 10
switch#
```

14.2.1.4.9.4 Viewing OSPFv2 Neighbors

The `show ip ospf neighbor` command displays information about the routers that are neighbors to the switch. Command options allow the display of summary or detailed information about the neighbors for all areas and interfaces on the switch. The command also allows the display of neighbors for individual interfaces or areas. The ***adjacency-changes*** option displays the interfaces adjacency changes.

Examples

- This command displays the switch's neighbors.

```
switch#show ip ospf neighbor
Neighbor ID Pri State Dead Time Address Interface
10.168.104.21 FULL/DR 00:00:35 10.168.0.2 Vlan1
```

```
10.168.104.28FULL/BDR00:00:3110.168.2.2Vlan2
switch#
```

- This command displays details about the neighbors to VLAN 2.

```
switch#show ip ospf neighbor vlan 2 detail
Neighbor 10.168.104.2, interface address 10.168.2.2
In the area 0.0.0.2 via interface Vlan2
Neighbor priority is 8, State is FULL, 13 state changes
Adjacency was established 000:01:25:48 ago
DR is 10.168.2.1 BDR is 10.168.2.2
Options is E
Dead timer due in 00:00:34
switch#
```

- This command displays the adjacency changes to VLAN 2.

```
switch#show ip ospf neighbor vlan 2 adjacency-changes
[08-04 08:55:32] 10.168.104.2, interface Vlan2 adjacency established
[08-04 09:58:51] 10.168.104.2, interface Vlan2 adjacency dropped:
interface went
down
[08-04 09:58:58] 10.168.104.2, interface Vlan2 adjacency established
[08-04 09:59:34] 10.168.104.2, interface Vlan2 adjacency dropped:
interface went
down
[08-04 09:59:42] 10.168.104.2, interface Vlan2 adjacency established
[08-04 10:01:40] 10.168.104.2, interface Vlan2 adjacency dropped: nbr
did not
list our router ID
[08-04 10:01:46] 10.168.104.2, interface Vlan2 adjacency established
switch#
```

The `show ip ospf neighbor state` command displays the state information for OSPF neighbors on a per-interface basis.

Example

This command displays OSPF information for neighboring routers that are fully adjacent.

```
switch#show ip ospf neighbor state full
Neighbor ID   VRF    Pri  State          Dead Time   Address          Interface
Test1         default 1    FULL/BDR       00:00:35   10.17.254.105   Vlan3912
Test2         default 1    FULL/BDR       00:00:36   10.17.254.29    Vlan3910
Test3 default    1    FULL/DR        00:00:35   10.25.0.1       Vlan101
Test4         default 1    FULL/DROTHER   00:00:36   10.17.254.67    Vlan3908
Test5         default 1    FULL/DROTHER   00:00:36   10.17.254.68    Vlan3908
Test6         default 1    FULL/BDR       00:00:32   10.17.254.66    Vlan3908
Test7         default 1    FULL/DROTHER   00:00:34   10.17.36.4      Vlan3036
Test8         default 1    FULL/BDR       00:00:35   10.17.36.3      Vlan3036
Test9         default 1    FULL/DROTHER   00:00:31   10.17.254.13    Vlan3902
Test10        default 1    FULL/BDR       00:00:37   10.17.254.11    Vlan3902
Test11        default 1    FULL/DROTHER   00:00:33   10.17.254.163   Vlan3925
Test12        default 1    FULL/DR        00:00:37   10.17.254.161   Vlan3925
Test13        default 1    FULL/DROTHER   00:00:31   10.17.254.154   Vlan3923
Test14        default 1    FULL/BDR       00:00:39   10.17.254.156   Vlan3923
Test15        default 1    FULL/DROTHER   00:00:33   10.17.254.35    Vlan3911
Test16        default 1    FULL/DR        00:00:34   10.17.254.33    Vlan3911
Test17 default    1    FULL/DR        00:00:36   10.17.254.138   Ethernet12
Test18        default 1    FULL/DR        00:00:37   10.17.254.2     Vlan3901
switch>
```

The `show ip ospf neighbor summary` command displays a single line of summary information for each OSPFv2 neighbor.

Example

This command displays the summary information for the OSPFv2 neighbors.

```
switch#show ip ospf neighbor summary
```



```

OSPF Router with (Process ID 1) (VRF default)
0 neighbors are in state DOWN
0 neighbors are in state GRACEFUL RESTART
2 neighbors are in state INIT
0 neighbors are in state LOADING
0 neighbors are in state ATTEMPT
18 neighbors are in state FULL
0 neighbors are in state EXCHANGE
0 neighbors are in state 2 WAYS
0 neighbors are in state EXCH START
switch>

```

14.2.1.4.9.5 Viewing OSPFv2 Routes

The **show ip routes** command provides an OSPFv2 option.

Examples

- This command displays all of a switch's routes.

```

switch#show ip route
Codes: C - connected, S - static, K - kernel, O - OSPF, B - BGP

Gateway of last resort:
S0.0.0.0/0 [1/0] via 10.255.255.1
C10.255.255.0/24 is directly connected, Management1
C10.168.0.0/24 is directly connected, Vlan1
C10.168.2.0/24 is directly connected, Vlan2
O10.168.3.0/24 [110/20] via 10.168.0.1
O10.168.103.0/24 [110/20] via 10.168.0.1
C10.168.104.0/24 is directly connected, Loopback0
switch#

```

- This command displays the switch's OSPFv2 routes.

```

switch#show ip route ospf
Codes: C - connected, S - static, K - kernel, O - OSPF, B - BGP

O10.168.3.0/24 [110/20] via 10.168.0.1
O10.168.103.0/24 [110/20] via 10.168.0.1
switch#

```

Use the **ping** command to determine the accessibility of a route.

Example

This command pings an OSPFv2 route.

```

switch#ping 10.168.0.1
PING 10.168.0.1 (10.168.0.1) 72(100) bytes of data.
80 bytes from 10.168.0.1: icmp_seq=1 ttl=64 time=0.148 ms
80 bytes from 10.168.0.1: icmp_seq=2 ttl=64 time=0.132 ms
80 bytes from 10.168.0.1: icmp_seq=3 ttl=64 time=0.136 ms
80 bytes from 10.168.0.1: icmp_seq=4 ttl=64 time=0.137 ms
80 bytes from 10.168.0.1: icmp_seq=5 ttl=64 time=0.136 ms

--- 10.168.0.1 ping statistics ---
5 packets transmitted, 5 received, 0% packet loss, time 7999ms
rtt min/avg/max/mdev = 0.132/0.137/0.148/0.015 ms
switch#

```

14.2.1.4.9.6 Viewing OSPFv2 SPF Logs

The `show ip ospf spf-log` command displays when and how long the switch took to run a full SPF calculation for OSPF.

Example

This command displays the SPF information for OSPF.

```
switch#show ip ospf spf-log
OSPF Process 172.26.0.22
When      Duration(msec)
13:01:34  1.482
13:01:29  1.547
13:01:24  1.893
13:00:50  1.459
13:00:45  1.473
13:00:40  2.603
11:01:49  1.561
11:01:40  1.463
11:01:35  1.467
11:01:30  1.434
11:00:54  1.456
11:00:49  1.472
11:00:44  1.582
15:01:49  1.575
15:01:44  1.470
15:01:39  1.679
15:01:34  1.601
15:00:57  1.454
15:00:52  1.446
15:00:47  1.603
switch>
```

14.2.1.4.9.7 Viewing OSPFv2 multiple Instances Support

The `show ip ospf` commands will take an instance ID filter to get the information for a particular OSPFv2 instance. If no instance ID is specified in the show query, information for all the active OSPFv2 instances are shown.

The `show ip ospf` commands will also display instance ID along with router ID either in the output headers or as a separate column.

Sample output for the `show ip ospf` command with two OSPFv2 instances with ID 1 and 2.

```
switch#show ip ospf
OSPF instance 1 with ID 1.1.1.1 VRF default
  Supports opaque LSA
  Maximum number of LSA allowed 12000
  Threshold for warning message 75%
  Ignore-time 5 minutes, reset-time 5 minutes
  Ignore-count allowed 5, current 0
  It is not an autonomous system boundary router and is not an
  area border router
  ...
OSPF instance 2 with ID 2.2.2.2 VRF default
  Supports opaque LSA
  Maximum number of LSA allowed 12000
  Threshold for warning message 75%
  Ignore-time 5 minutes, reset-time 5 minutes
  Ignore-count allowed 5, current 0
```

```

It is not an autonomous system boundary router and is not an
area border router
...

```

Sample output for the **show ip ospf** command with Graceful Restart enabled for two OSPFv2 instances with ID **10** and **11**.

```

switch#show ip ospf
OSPF instance 10 with ID 2.2.2.2 VRF default
  Supports opaque LSA
  Maximum number of LSA allowed 12000
  Threshold for warning message 75%
  Ignore-time 5 minutes, reset-time 5 minutes
  ...
  Graceful-restart is configured, grace-period 120 seconds
  State: In progress, expires in 113 seconds
  Graceful-restart-helper mode is enabled
  ...
OSPF instance 11 with ID 3.3.3.3 VRF default
  Supports opaque LSA
  Maximum number of LSA allowed 12000
  Threshold for warning message 75%
  Ignore-time 5 minutes, reset-time 5 minutes
  ...
  Graceful-restart is configured, grace-period 120 seconds
  State: In progress, expires in 113 seconds
  Graceful-restart-helper mode is enabled
  ...

```

Sample output for the **show ip ospf neighbor detail** command.

```

switch#show ip ospf neighbor
Neighbor ID   Instance  VRF      Pri  State      Dead Time  Address  Interface
2.2.2.2      1         default  1    FULL/DR    00:00:38  10.1.1.2 Ethernet1
4.4.4.4      2         default  1    FULL/DR    00:00:36  40.1.1.2 Ethernet4

switch#show ip ospf neighbor 2.2.2.2 detail
Neighbor 2.2.2.2, instance 1, VRF default, interface address 10.1.1.1

  In area 0.0.0.0 interface Ethernet1

  Neighbor priority is 1, State is FULL, 7 state changes

  Adjacency was established 00:38:48 ago

  Current state was established 00:38:48 ago

  DR IP Address 10.1.1.2 BDR IP Address 10.1.1.1

  Options is E

  Dead timer is due in 00:00:35

  Inactivity timer deferred 0 times

  LSAs retransmitted 1 time to this neighbor

  Graceful-restart-helper mode is Inactive

```

```
Graceful-restart attempts: 0
```

Sample output for `show ip ospf neighbor detail` with BFD enabled.

```
switch#show ip ospf neighbor 2.2.2.2 detail
Neighbor 3.3.3.3, instance 10, VRF default, interface address
1.0.0.1
  In area 1.2.3.4 interface Ethernet1
  Neighbor priority is 1, State is FULL, 7 state changes
  Adjacency was established 22:03:05 ago
  Current state was established 22:03:05 ago
  DR IP Address 1.0.0.1 BDR IP Address 1.0.0.2
  Options is E
  Dead timer is due in 00:00:34
  Inactivity timer deferred 0 times
  LSAs retransmitted 1 time to this neighbor
Bfd request is sent and the state is Down
  Graceful-restart-helper mode is Inactive
  Graceful-restart attempts: 0
Neighbor 6.6.6.6, instance 10, VRF default, interface address
1.0.1.1
  In area 1.2.3.4 interface Ethernet5
  Neighbor priority is 1, State is FULL, 7 state changes
  Adjacency was established 22:03:10 ago
  Current state was established 22:03:10 ago
  DR IP Address 1.0.1.1 BDR IP Address 1.0.1.2
  Options is E
  Dead timer is due in 00:00:30
  Inactivity timer deferred 0 times
  LSAs retransmitted 2 times to this neighbor
Bfd request is sent and the state is Down
  Graceful-restart-helper mode is Inactive
  Graceful-restart attempts: 0
Neighbor 4.4.4.4, instance 12, VRF default, interface address
1.0.3.1
  In area 1.2.3.4 interface Ethernet2
  Neighbor priority is 1, State is FULL, 7 state changes
  Adjacency was established 22:03:10 ago
  Current state was established 22:03:10 ago
  DR IP Address 1.0.3.1 BDR IP Address 1.0.3.2
  Options is E
  Dead timer is due in 00:00:32
  Inactivity timer deferred 0 times
  LSAs retransmitted 1 time to this neighbor
  Graceful-restart-helper mode is Inactive
  Graceful-restart attempts: 0
```

The CAPI outputs for OSPFv2 show commands are already indexed by instance ID and will remain unchanged.

The `show ip route` and `show ip route ospf` commands show routes from all OSPFv2 instances with no mention of instance ID. For example,

11.1.1.0/24 is learned from instance **100** and **12.1.1.0/24** from instance **200**.

```
switch#show ip route
```

```

VRF: default
Codes: C - connected, S - static, K - kernel,
       O - OSPF, IA - OSPF inter area, E1 - OSPF external type 1,
       E2 - OSPF external type 2, N1 - OSPF NSSA external type 1,
       N2 - OSPF NSSA external type2, B I - iBGP, B E - eBGP,
       R - RIP, I L1 - IS-IS level 1, I L2 - IS-IS level 2,
       O3 - OSPFv3, A B - BGP Aggregate, A O - OSPF Summary,
       NG - Nexthop Group Static Route, V - VXLAN Control
Service,
       DH - DHCP client installed default route, M - Martian,
       DP - Dynamic Policy Route, L - VRF Leaked

Gateway of last resort is not set

O E2    11.1.1.0/24 [110/1] via 20.1.1.2, Ethernet3
C       10.1.1.0/24 is directly connected, Ethernet1
C       20.1.1.0/24 is directly connected, Ethernet3
O       12.1.1.0/24 [110/20] via 10.1.1.2, Ethernet1

switch#show ip route ospf

VRF: default
Codes: C - connected, S - static, K - kernel,
       O - OSPF, IA - OSPF inter area, E1 - OSPF external type 1,
       E2 - OSPF external type 2, N1 - OSPF NSSA external type 1,
       N2 - OSPF NSSA external type2, B I - iBGP, B E - eBGP,
       R - RIP, I L1 - IS-IS level 1, I L2 - IS-IS level 2,
       O3 - OSPFv3, A B - BGP Aggregate, A O - OSPF Summary,
       NG - Nexthop Group Static Route, V - VXLAN Control
Service,
       DH - DHCP client installed default route, M - Martian,
       DP - Dynamic Policy Route, L - VRF Leaked

O E2    11.1.1.0/24 [110/1] via 20.1.1.2, Ethernet3
O       12.1.1.0/24 [110/20] via 10.1.1.2, Ethernet1

```

The **show ip route summary** command displays the cumulative counts of OSPFv2 routes across all instances.

```

switch#show ip route summary

VRF: default
Route Source                                Number Of Routes
-----
connected                                    2
static (persistent)                          0
static (non-persistent)                      0
VXLAN Control Service                        0
static nexthop-group                          0
ospf                                         9
  Intra-area: 2 Inter-area: 5 External-1: 0 External-2: 2
  NSSA External-1: 0 NSSA External-2: 0
ospfv3                                        0
bgp                                           0
  External: 0 Internal: 0
isis                                          0
  Level-1: 0 Level-2: 0
rip                                           0

```

```

internal          9
attached         1
aggregate        0
dynamic policy   0

Total Routes          14

Number of routes per mask-length:
/8: 2      /24: 3      /32: 9

```

14.2.1.4.9.8 Displaying OSPF Routes over GRE Tunnel Status

A show command is available to list the TCAM profile status on each linecard.

```

(config)#show hardware tcam profile
Configuration      Status FixedSystem      newprofile1      newprofile1

```

If the profile cannot be programmed, the Status column will print **ERROR**. See [Limitations](#) for additional information. The content of a PMF profile can be displayed with

```

(config)#show hardware tcam profile [<profile>] detail

```

Example

```

(config-hw-tcam)#show hardware tcam profile newprofile1 detail
Profile newprofile1 [ FixedSystem ]
Feature             mpls
-----
Key size            160
Actions             drop, redirect, set-ecn
Packet type         ipv4 mpls ipv4 forwarding mpls decap
                   ipv4 mpls ipv6 forwarding mpls decap
                   mpls ipv4 forwarding mpls
                   mpls ipv6 forwarding mpls
                   mpls non-ip forwarding mpls

Feature             acl vlan ipv6
-----
Key size            320
Key fields          dst-ipv6, ipv6-next-header, l4-dst-port, l4-src-
port,
                   src-ipv6-high, src-ipv6-low, tcp-control
Actions             count, drop, mirror, redirect
Packet type         ipv6 forwarding routed
...

```

Note that the profile contains all the features that are untouched after copying from the base profile.

Example

This example demonstrates how to create a new profile to match on **vlan** field in MAC ACL.

```

(config-hw-tcam)#profile macvlan copy default

```

```
(config-hw-tcam-profile-macvlan)#feature acl port mac
(config-hw-tcam-profile-macvlan-feature-acl-port-mac)#key field
vlan
(config-hw-tcam-profile-macvlan-feature-acl-port-mac)#exit
(config-hw-tcam-profile-macvlan)#exit
Saving new profile 'macvlan'
(config-hw-tcam)#system profile macvlan
```

14.2.1.5 OSPFv2 Configuration Examples

This section describes the commands required to configure three OSPFv2 topologies.

- [OSPFv2 Configuration Example 1](#)
- [OSPFv2 Configuration Example 2](#)
- [OSPFv2 Configuration Example 3](#)

14.2.1.5.1 OSPFv2 Configuration Example 1

The OSPF Autonomous System in example 1 contains two areas that are connected through two routers. The backbone area also contains an internal router that connects two subnets.

14.2.1.5.1.1 Example 1 Topology

[OSPFv2 Example 1](#) displays the Example 1 topology. Two ABRs connect area 0 and area 1 Router A and Router B. Router C is an internal router that connects two subnets in area 0.

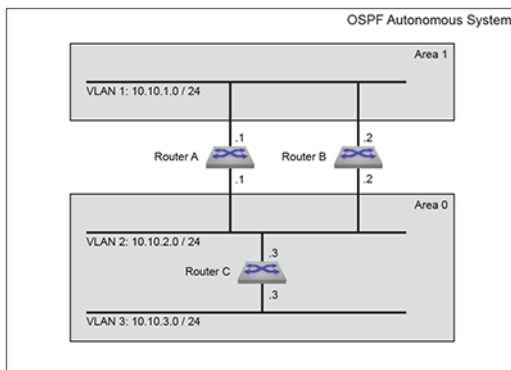

Figure 45: OSPFv2 Example 1

Area 1 Configuration

Area 1 contains one subnet that is accessed by Router A and Router B.

- Router A: The subnet 10.10.1.0/24 is accessed through VLAN 1.
- Router B: The subnet 10.10.1.0/24 is accessed through VLAN 1.
- Each router uses simple authentication, with password abcdefgh.
- Designated Router (DR): Router A.
- Backup Designated Router (BDR): Router B.
- Each router defines an interface cost of 10.
- Router priority is not specified for either router on area 1.

Area 0 ABR Configuration

Area 0 contains one subnet that is accessed by ABRs Router A and Router B.

- Router A: The subnet 10.10.2.0/24 is accessed through VLAN 2.
- Router B: The subnet 10.10.2.0/24 is accessed through VLAN 2.
- Designated Router (DR): Router B.
- Backup Designated Router (BDR): Router A.
- Each router uses simple authentication, with password ijklmnop.
- Each router defines an interface cost of 20.
- Each router defines a retransmit-interval of 10.
- Each router defines a transmit-delay of 2.
- Router priority is specified such that Router B will be elected as the Designated Router.

Area 0 IR Configuration

Area 0 contains one internal router that connects two subnets.

- Router C: The subnet 10.10.2.0/24 is accessed through VLAN 2.
- Router C: The subnet 10.10.3.0/24 is accessed through VLAN 3.
- The subnet 10.10.2.0/24 link is configured as follows:
 - Interface cost of 20.
 - Retransmit-interval of 10.
 - Transmit-delay of 2.
- The subnet 10.10.3.0/24 link is configured as follows:
 - Interface cost of 20.
 - Dead interval of 80 seconds.

14.2.1.5.1.2 Example 1 Code

This code configures the OSPFv2 instances on the three switches.

1. Configure the interface addresses.

a. Router A interfaces:

```
switch-A(config)#interface vlan 1
switch-A(config-if-vl1)#ip address 10.10.1.1/24
switch-A(config-if-vl1)#interface vlan 2
switch-A(config-if-vl2)#ip address 10.10.2.1/24
```

b. Router B interfaces:

```
switch-B(config)#interface vlan 1
switch-B(config-if-vl1)#ip address 10.10.1.2/24
switch-B(config-if-vl1)#interface vlan 2
switch-B(config-if-vl2)#ip address 10.10.2.2/24
```

c. Router C interfaces:

```
switch-C(config)#interface vlan 2
switch-C(config-if-vl2)#ip address 10.10.2.3/24
switch-C(config-if-vl2)#interface vlan 3
switch-C(config-if-vl3)#ip address 10.10.3.3/24
```

2. Configure the interface OSPFv2 parameters.

a. Router A interfaces:

```
switch-A(config-if-vl2)#interface vlan 1
switch-A(config-if-vl1)#ip ospf authentication-key abcdefgh
switch-A(config-if-vl1)#ip ospf cost 10
```



```

switch-A(config-if-vl1)#ip ospf priority 6
switch-A(config-if-vl1)#interface vlan 2
switch-A(config-if-vl2)#ip ospf authentication-key ijklmnop
switch-A(config-if-vl2)#ip ospf cost 20
switch-A(config-if-vl2)#ip ospf retransmit-interval 10
switch-A(config-if-vl2)#ip ospf transmit-delay 2
switch-A(config-if-vl2)#ip ospf priority 4

```

b. Router B interfaces:

```

switch-B(config-if-vl2)#interface vlan 1
switch-B(config-if-vl1)#ip ospf authentication-key abcdefgh
switch-B(config-if-vl1)#ip ospf cost 10
switch-B(config-if-vl1)#ip ospf priority 4
switch-B(config-if-vl1)#interface vlan 2
switch-B(config-if-vl2)#ip ospf authentication-key ijklmnop
switch-B(config-if-vl2)#ip ospf cost 20
switch-B(config-if-vl2)#ip ospf retransmit-interval 10
switch-B(config-if-vl2)#ip ospf transmit-delay 2
switch-B(config-if-vl2)#ip ospf priority 6

```

c. Router C interfaces:

```

switch-C(config-if-vl3)#interface vlan 2
switch-C(config-if-vl2)#ip ospf cost 20
switch-C(config-if-vl2)#ip ospf retransmit-interval 10
switch-C(config-if-vl2)#ip ospf transmit-delay 2
switch-C(config-if-vl2)#interface vlan 3
switch-C(config-if-vl3)#ip ospf cost 20
switch-C(config-if-vl3)#ip ospf dead-interval 80

```

3. Attach the network segments to the areas.

a. Router A interfaces:

```

switch-A(config-if-vl2)#router ospf 1
switch-A(config-router-ospf)#router-id 169.10.0.1
switch-A(config-router-ospf)#network 10.10.1.0/24 area 1
switch-A(config-router-ospf)#network 10.10.2.0/24 area 0

```

b. Router B interfaces:

```

switch-B(config-if-vl2)#router ospf 1
switch-B(config-router-ospf)#router-id 169.10.0.2
switch-B(config-router-ospf)#network 10.10.1.0/24 area 1
switch-B(config-router-ospf)#network 10.10.2.0/24 area 0

```

c. Router C interfaces:

```

switch-C(config-if-vl3)#router ospf 1
switch-C(config-router-ospf)#router-id 169.10.0.3
switch-C(config-router-ospf)#network 10.10.2.0/24 area 0
switch-C(config-router-ospf)#network 10.10.3.0/24 area 0

```

14.2.1.5.2 OSPFv2 Configuration Example 2

The AS in example 2 contains three areas. Area 0 connects to the other areas through different routers. The backbone area contains an internal router that connects two subnets. Area 0 is normal; the other areas are stub areas.

14.2.1.5.2.1 Example 2 Topology

OSPFv2 Example 2 displays the Example 2 topology. One ABR (Router B) connects area 0 and area 10.42.110.0; another ABR (router C) connects area 0 and area 36.56.0.0. Router A is an internal router that connects two subnets in area 0.

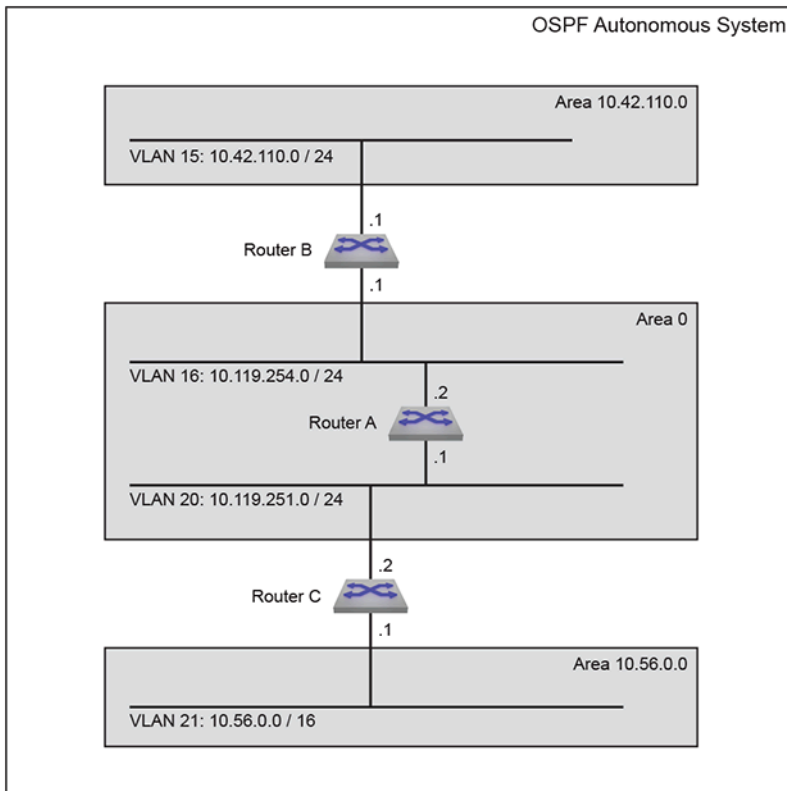

Figure 46: OSPFv2 Example 2

Area 10.42.110.0 Configuration

Area 10.42.110.0 contains one subnet that is accessed by Router B.

- Router B: The subnet 10.42.110.0 is accessed through VLAN 15.
- Router B uses simple authentication, with password abcdefgh.
- Each router defines a interface cost of 10.

Area 10.56.0.0 Configuration

Area 10.56.0.0 contains one subnet that is accessed by Router C.

- Router C: The subnet 10.56.0.0 is accessed through VLAN 21.
- Router C uses simple authentication, with password ijklmnop.
- Each router defines a interface cost of 20.

Area 0 ABR Configuration

Area 0 contains two subnets. ABR Router B connects one subnet to area 10.42.110.0. ABR Router C connects the other subnet to area 10.56.0.0.

- Router B: The subnet 10.119.254.0/24 is accessed through VLAN 16.
- Router C: The subnet 10.119.251.0/24 is accessed through VLAN 20.
- Designated Router (DR): Router B.

- Backup Designated Router (BDR): Router C.
- Each ABR uses simple authentication, with password ijklmnop
- Each router defines an interface cost of 20.
- Each router defines a retransmit-interval of 10.
- Each router defines a transmit-delay of 2.

Area 0 IR Configuration

Area 0 contains two subnets connected by an internal router.

- Router A: The subnet 10.119.254.0/24 is accessed through VLAN 16.
- Router A: The subnet 10.119.251.0/24 is accessed through VLAN 20.
- The subnet 10.42.110.0 is configured as follows:
 - Interface cost of 10.
- The subnet 10.56.0.0/24 is configured as follows:
 - Interface cost of 20.
 - Retransmit-interval of 10.
 - Transmit-delay of 2.

14.2.1.5.2.2 Example 2 Code

1. Configure the interface addresses.

a. Router A interfaces:

```
switch-A(config)#interface vlan 16
switch-A(config-if-vl16)#ip address 10.119.254.2/24
switch-A(config-if-vl16)#interface vlan 20
switch-A(config-if-vl20)#ip address 10.119.251.1/24
```

b. Router B interfaces:

```
switch-B(config)#interface vlan 15
switch-B(config-if-vl15)#ip address 10.42.110.1/24
switch-B(config-if-vl15)#interface vlan 16
switch-B(config-if-vl16)#ip address 10.119.254.1/24
```

c. Router C interfaces:

```
switch-C(config)#interface vlan 20
switch-C(config-if-vl20)#ip address 10.119.251.2/24
switch-C(config-if-vl20)#interface vlan 21
switch-C(config-if-vl21)#ip address 10.56.0.1/24
```

2. Configure the interface OSPFv2 parameters.

a. Router A interfaces:

```
switch-A(config-if-vl20)#interface vlan 16
switch-A(config-if-vl16)#ip ospf cost 10
switch-A(config-if-vl16)#interface vlan 20
switch-A(config-if-vl20)#ip ospf cost 20
switch-A(config-if-vl20)#ip ospf retransmit-interval 10
switch-A(config-if-vl20)#ip ospf transmit-delay 2
```

b. Router B interfaces:

```
switch-B(config-if-vl16)#interface vlan 15
switch-B(config-if-vl15)#ip ospf authentication-key abcdefgh
```

```

switch-B(config-if-vl15)#ip ospf cost 10
switch-B(config-if-vl15)#interface vlan 16
switch-B(config-if-vl16)#ip ospf authentication-key ijklmnop
switch-B(config-if-vl16)#ip ospf cost 20
switch-B(config-if-vl16)#ip ospf retransmit-interval 10
switch-B(config-if-vl16)#ip ospf transmit-delay 2
switch-B(config-if-vl16)#ip ospf priority 6

```

c. Router C interfaces:

```

switch-C(config-if-vl21)#interface vlan 20
switch-C(config-if-vl20)#ip ospf authentication-key ijklmnop
switch-C(config-if-vl20)#ip ospf cost 20
switch-C(config-if-vl20)#ip ospf retransmit-interval 10
switch-C(config-if-vl20)#ip ospf transmit-delay 2
switch-C(config-if-vl20)#ip ospf priority 4
switch-C(config-if-vl20)#interface vlan 21
switch-C(config-if-vl21)#ip ospf authentication-key ijklmnop
switch-C(config-if-vl21)#ip ospf cost 20
switch-C(config-if-vl21)#ip ospf dead-interval 80

```

3. Attach the network segments to the areas.

a. Router A interfaces:

```

switch-A(config-if-vl20)#router ospf 1
switch-A(config-router-ospf)#router-id 10.24.1.1
switch-A(config-router-ospf)#network 10.119.254.0/24 area 0
switch-A(config-router-ospf)#network 10.119.251.0/24 area 0
switch-A(config-router-ospf)#area 0 range 10.119.251.0 0.0.7.255

```

b. Router B interfaces:

```

switch-B(config-if-vl16)#router ospf 1
switch-B(config-router-ospf)#router-id 10.24.1.2
switch-B(config-router-ospf)#area 10.42.110.0 stub
switch-B(config-router-ospf)#network 10.42.110.0/24 area 10.42.110.0
switch-B(config-router-ospf)#network 10.119.254.0/24 area 0

```

c. Router C interfaces:

```

switch-C(config-if-vl21)#router ospf 1
switch-C(config-router-ospf)#router-id 10.24.1.3
switch-C(config-router-ospf)#area 10.56.0.0 stub 0
switch-C(config-router-ospf)#network 10.119.251.0/24 area 0
switch-C(config-router-ospf)#network 10.56.0.0/24 area 36.56.0.0

```

14.2.1.5.3 OSPFv2 Configuration Example 3

The AS in example 3 contains two areas that connect through one ABR.

- Area 0: Backbone area contains two internal routers that connect three subnets, one ASBR, and one ABR that connects to Area 1.
- Area 1: NSSA contains one internal router, one ASBR, and one ABR that connects to the backbone.

14.2.1.5.3.1 Example 3 Topology

[OSPFv2 Example 3](#) displays the Example 3 topology. One ABR connects area 0 and area 1. Router C is an ABR that connects the areas. Router A is an internal router that connects two subnets in area 1.

Router D and Router E are internal routers that connect subnets in area 0. Router B and Router F are ASBRs that connect static routes outside the AS to area 1 and area 0, respectively.

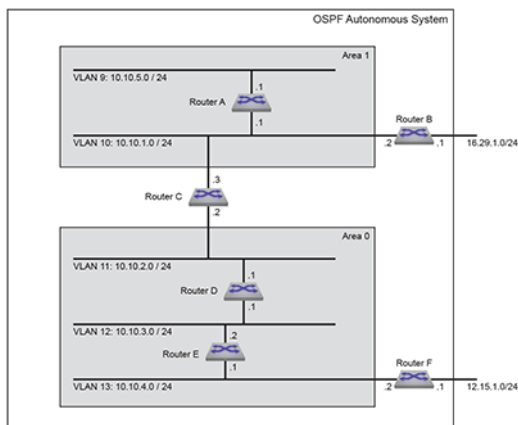

Figure 47: OSPFv2 Example 3

Area 0 ABR Configuration

ABR Router C connects one area 0 subnet to an area 1 subnet.

- Router C: The subnet 10.10.2.0/24 is accessed through VLAN 11.
- Authentication is not configured on the interfaces.
- All interface OSPFv2 parameters are set to their default values.

Area 0 IR Configuration

Area 0 contains two internal routers, each of which connects two of the three subnets in the area.

- Router D: The subnet 10.10.2.0/24 is accessed through VLAN 11.
- Router D: The subnet 10.10.3.0/24 is accessed through VLAN 12.
- Router E: The subnet 10.10.3.0/24 is accessed through VLAN 12.
- Router E: The subnet 10.10.4.0/24 is accessed through VLAN 13.
- All interface OSPFv2 parameters are set to their default values.

Area 0 ASBR Configuration

ASBR Router F connects one area 0 subnet to an external subnet.

- Router F: The subnet 10.10.4.0/24 is accessed through VLAN 13.
- Router F: The subnet 12.15.1.0/24 is accessed through VLAN 14.
- All interface OSPFv2 parameters are set to their default values.

Area 1 ABR Configuration

ABR Router C connects one area 0 subnet to area 1.

- Router C: The subnet 10.10.1.0/24 is accessed through VLAN 10.
- Authentication is not configured on the interface.
- All interface OSPFv2 parameters are set to their default values.

Area 1 IR Configuration

Area 1 contains one internal router that connects two subnets in the area.

- Router A: The subnet 10.10.1.0/24 is accessed through VLAN 10.
- Router A: The subnet 10.10.5.0/24 is accessed through VLAN 9.

- All interface OSPFv2 parameters are set to their default values.

Area 1 ASBR Configuration

ASBR Router B connects one area 1 subnet to an external subnet.

- Router B: The subnet 10.10.1.0/24 is accessed through VLAN 10.
- Router B: The subnet 16.29.1.0/24 is accessed through VLAN 15.
- All interface OSPFv2 parameters are set to their default values.

14.2.1.5.3.2 Example 3 Code

1. Configure the interfaces.

a. Router A interfaces:

```
switch-A(config)#interface vlan 10
switch-A(config-if-vl10)#ip address 10.10.1.1/24
switch-A(config-if-vl10)#interface vlan 9
switch-A(config-if-vl11)#ip address 10.10.5.1/24
```

b. Router B interfaces:

```
switch-B(config)#interface vlan 10
switch-B(config-if-vl10)#ip address 10.10.1.2/24
switch-B(config-if-vl10)#interface vlan 15
switch-B(config-if-vl18)#ip address 16.29.1.1/24
```

c. Router C interfaces:

```
switch-C(config)#interface vlan 10
switch-C(config-if-vl10)#ip address 10.10.1.3/24
switch-C(config-if-vl10)#interface vlan 11
switch-C(config-if-vl11)#ip address 10.10.2.2/24
```

d. Router D interfaces:

```
switch-D(config)#interface vlan 11
switch-D(config-if-vl11)#ip address 10.10.2.1/24
switch-D(config)#interface vlan 12
switch-D(config-if-vl12)#ip address 10.10.3.1/24
```

e. Router E interfaces:

```
switch-E(config)#interface vlan 12
switch-E(config-if-vl12)#ip address 10.10.3.2/24
switch-E(config)#interface vlan 13
switch-E(config-if-vl13)#ip address 10.10.4.1/24
```

f. Router F interfaces:

```
switch-F(config)#interface vlan 13
switch-F(config-if-vl13)#ip address 10.10.4.2/24
switch-F(config)#interface vlan 14
switch-F(config-if-vl14)#ip address 12.15.1.1/24
```

2. Attach the network segments to the areas.

a. Router A interfaces:

```
switch-A(config-if-vl10)#router ospf 1
switch-A(config-router-ospf)#router-id 170.21.0.1
```

```
switch-A(config-router-ospf)#area 1 NSSA  
switch-A(config-router-ospf)#network 10.10.1.0/24 area 1
```

b. Router B interfaces:

```
switch-B(config-if-vl10)#router ospf 1  
switch-B(config-router-ospf)#router-id 170.21.0.2  
switch-B(config-router-ospf)#area 1 NSSA  
switch-B(config-router-ospf)#network 10.10.1.0/24 area 1
```

c. Router C interfaces:

```
switch-C(config-if-vl11)#router ospf 1  
switch-C(config-router-ospf)#router-id 170.21.0.3  
switch-C(config-router-ospf)#area 1 NSSA  
switch-C(config-router-ospf)#network 10.10.1.0/24 area 1  
switch-C(config-router-ospf)#network 10.10.2.0/24 area 0
```

d. Router D interfaces:

```
switch-D(config-if-vl12)#router ospf 1  
switch-D(config-router-ospf)#router-id 170.21.0.4  
switch-D(config-router-ospf)#network 10.10.2.0/24 area 0  
switch-D(config-router-ospf)#network 10.10.3.0/24 area 0
```

e. Router E interfaces:

```
switch-E(config-if-vl13)#router ospf 1  
switch-E(config-router-ospf)#router-id 170.21.0.5  
switch-E(config-router-ospf)#network 10.10.3.0/24 area 0  
switch-E(config-router-ospf)#network 10.10.4.0/24 area 0
```

f. Router F interfaces:

```
switch-F(config-if-vl14)#router ospf 1  
switch-F(config-router-ospf)#router-id 170.21.0.6  
switch-F(config-router-ospf)#network 10.10.4.0/24 area 0  
switch-F(config-router-ospf)#redistribute static
```

14.2.1.6 OSPFv2 Commands

Global Configuration Mode

- ip ospf router-id output-format hostnames
- line system
- router ospf

Interface Configuration Mode

- interface Tunnel
- ip ospf area
- ip ospf authentication
- ip ospf authentication-key
- ip ospf cost
- ip ospf dead-interval
- ip ospf disabled
- ip ospf hello-interval
- ip ospf message-digest-key
- ip ospf network point-to-point
- ip ospf priority
- ip ospf retransmit-interval
- ip ospf transmit-delay
- tunnel routes

Router-OSPFv2 Configuration Mode

- adjacency exchange-start threshold (OSPFv2)
- area default-cost (OSPFv2)
- area filter (OSPFv2)
- area nssa (OSPFv2)
- area nssa default-information-originate (OSPFv2)
- area nssa no-summary (OSPFv2)
- area not-so-stubby lsa type-7 convert type-5 (OSPFv2)
- area range (OSPFv2)
- area stub (OSPFv2)
- auto-cost reference-bandwidth (OSPFv2)
- compatible (OSPFv2)
- default-information originate (OSPFv2)
- distance ospf (OSPFv2)
- dn-bit-ignore (OSPFv2)
- log-adjacency-changes (OSPFv2)
- max-lsa (OSPFv2)
- max-metric router-lsa (OSPFv2)
- maximum-paths (OSPFv2)
- network area (OSPFv2)
- no area (OSPFv2)
- passive-interface default (OSPFv2)
- passive-interface <interface> (OSPFv2)
- point-to-point routes (OSPFv2)
- redistribute (OSPFv2)

- redistribute ospf instance
- router-id (OSPFv2)
- shutdown (OSPFv2)
- summary-address
- timers lsa rx min interval (OSPFv2)
- timers lsa tx delay initial (OSPFv2)
- timers spf delay initial (OSPFv2)

TCAM Profile Configuration Mode

- packet
- system profile

Display and Clear Commands

- clear ip ospf neighbor
- show hardware tcam profile
- show ip ospf
- show ip ospf border-routers
- show ip ospf database database-summary
- show ip ospf database <link state list>
- show ip ospf database <link-state details>
- show ip ospf interface
- show ip ospf interface brief
- show ip ospf lsa-log
- show ip ospf neighbor
- show ip ospf neighbor adjacency-changes
- show ip ospf neighbor state
- show ip ospf neighbor summary
- show ip ospf request queue
- show ip ospf retransmission queue
- show ip ospf spf-log
- show line system [port RANGE] dom thresholds
- show line system [port RANGE] status

14.2.1.6.1 auto-cost reference-bandwidth (OSPFv2)

The **auto-cost reference-bandwidth** command is a factor in the formula that calculates the default OSPFv2 cost for Ethernet interfaces.

$$\text{OSPFv2-cost} = (\text{auto-cost value} * 1 \text{ Mbps}) / \text{interface bandwidth}$$

The switch uses a minimum OSPFv2-cost of one. The switch rounds down all non-integer results.

On a 10G Ethernet interface:

- if auto-cost = 100, then OSPFv2-cost = 100 Mbps / 10 Gbps = 0.01, and the default cost is set to 1.
- if auto-cost = 59000, then OSPFv2-cost = 59000 Mbps / 10 Gbps = 5.9, and the default cost is set to 5.

The **no auto-cost reference-bandwidth** and **default auto-cost reference-bandwidth** command removes the **auto-cost reference-bandwidth** command from **running-config**. When this parameter is not set, the default cost for Ethernet interfaces is the default **ip ospf cost** value of 10.

Command Mode

Router-OSPF Configuration

Command Syntax

```
auto-cost reference-bandwidth rate
no auto-cost reference-bandwidth rate
default auto-cost reference-bandwidth rate
```

Parameter

rate Values range from 1 to 4294967 . Default is 100.

Example

To configure a default cost of 20 on 10G Ethernet interfaces:

1. Calculate the required auto-cost value:
$$\text{auto-cost} = (\text{OSPFv2-cost} * \text{interface bandwidth}) / 1 \text{ Mbps} = (20 * 10000 \text{ Mbps}) / 1 \text{ Mbps} = 200000$$
2. Configure this value as the auto-cost reference-bandwidth.

```
switch(config)#router ospf 6
switch(config-router-ospf)#auto-cost reference-bandwidth 200000
switch(config-router-ospf)#
```

14.2.1.6.2 adjacency exchange-start threshold (OSPFv2)

The **adjacency exchange-start threshold** command sets the exchange-start options for an OSPF instance.

The **no adjacency exchange-start threshold** and **default adjacency exchange-start threshold** command resets the default by removing the corresponding a **adjacency exchange-start threshold** command from *running-config*.

Command Mode

Router-OSPF Configuration

Command Syntax

```
default adjacency exchange-start threshold
adjacency exchange-start threshold peers
no adjacency exchange-start threshold
```

Parameters

peers Value ranges from 1 4294967295. Default value is 10.

Example

This command sets the adjacency exchange start threshold to 20045623.

```
switch(config)#router ospf 6
switch(config-router-ospf)#adjacency exchange-start threshold 20045623
switch(config-router-ospf)#
```

14.2.1.6.3 area default-cost (OSPFv2)

The **area default-cost** command specifies the cost for the default summary routes sent into a specified area. The default-cost is set to 10.

The **no area default-cost** and **default area default-cost** command resets the default-cost value of the specified area to 10 by removing the corresponding **area default-cost** command from **running-config**. The **no area (OSPFv2)** command removes all area commands for the specified area from **running-config**, including the **area default-cost** command.

Command Mode

Router-OSPF Configuration

Command Syntax

```
area area_id default-cost def_cost
no area area_id default-cost def_cost
default area area_id default-cost def_cost
```

Parameters

- *area_id* Area number. <0 to 4294967295> or <0.0.0.0 to 255.255.255.255> **running-config** stores value in dotted decimal notation.
- *def_cost* Value ranges from 1 to 65535. Default value is 10.

Example

This command configures a cost of 15 for default summary routes that an ABR sends into area 23.

```
switch(config)#router ospf 6
switch(config-router-ospf)#area 23 default-cost 15
switch(config-router-ospf)#
```

14.2.1.6.4 area filter (OSPFv2)

The **area filter** command prevents an area from receiving Type 3 Summary LSAs from a specified subnet.

The **no area filter** and **default area filter** commands remove the specified **area filter** command from **running-config**. The **no area** command (see **no area (OSPFv2)**) removes all area commands for the specified area from **running-config**, including **area filter** commands.

Command Mode

Router-OSPF Configuration

Command Syntax

```
area area_id filter net_addr
no area area_id filter net_addr
default area area_id filter net_addr
```

Parameters

- *area_id* Area number. <0 to 4294967295> or <0.0.0.0 to 255.255.255.255> **running-config** stores value in dotted decimal notation.
- *net_addr* Network IP address. Entry formats include address-prefix (CIDR) and address-mask. **running-config** stores value in CIDR notation.

Example

This command prevents the switch from entering Type 3 LSAs originating from the 10.1.1.0/24 subnet into its area 2 LSDB.

```
switch(config)#router ospf 6  
switch(config-router-ospf)#area 2 filter 10.1.1.0/24  
switch(config-router-ospf)#
```

14.2.1.6.5 area not-so-stubby lsa type-7 convert type-5 (OSPFv2)

The `area not-so-stubby lsa type-7 convert type-5` command configures the switch to always translate Type-7 link-state advertisement (LSAs) to Type-5 LSAs.

The `no area not-so-stubby lsa type-7 convert type-5` and `no area not-so-stubby lsa type-7 convert type-5` commands allow LSAs to be translated dynamically by removing the `no area not-so-stubby lsa type-7 convert type-5` command from *running-config*.

Command Mode

Router-OSPF Configuration

Command Syntax

```
area area_id not-so-stubby lsa type-7 convert type-5
no area area_id not-so-stubby lsa type-7 convert type-5
default area area_id not-so-stubby lsa type-7 convert type-5
```

Parameters

- *area_id* Area number.
 - Valid formats: integer <1 to **4294967295**> or dotted decimal <**0.0.0.1** to **255.255.255.255**>
 - Area 0 (or 0.0.0.0) is not configurable; it is always **normal**.
 - *running-config* stores value in dotted decimal notation.

Example

This command configures the switch to always translate Type-7 link-state advertisement (LSAs) to Type-5 LSAs.

```
switch(config-router-ospf) #area 3 not-so-stubby lsa type-7 convert type-5
switch(config-router-ospf) #
```

14.2.1.6.6 area nssa (OSPFv2)

The **area nssa** command configures an OSPFv2 area as a not-so-stubby area (NSSA). All routers in an AS must specify the same area type for identically numbered areas.

NSSA ASBRs advertise external LSAs that are part of the area, but do not advertise external LSAs from other areas.

Areas are **normal** by default; area type configuration is required only for stub NSSA areas. Area 0 is always a normal area and cannot be configured through this command.

The **no area nssa** command configures the specified area as a normal area by removing the specified **area nssa** command from **running-config**.

Command Mode

Router-OSPF Configuration

Command Syntax

```
area area_id nssa [TYPE]
```

```
no area area_id nssa [TYPE]
```

```
default area area_id nssa [TYPE]
```

Parameters

- *area_id* All parameters except *area_id* can be placed in any order.
 - Valid formats: integer <1 to **4294967295**> or dotted decimal <**0.0.0.1** to **255.255.255.255**>
 - Area 0 (or 0.0.0.0) is not configurable; it is always normal.
 - **running-config** stores value in dotted decimal notation.
- TYPE Area type. Values include:
 - <*no parameter*>
 - nssa-only

Example

This command configures area 3 as a NSSA area.

```
switch(config-router-ospf) #area 3 nssa nssa-only  
switch(config-router-ospf) #
```

14.2.1.6.7 area nssa default-information-originate (OSPFv2)

The **default area nssa default-information-originate** command sets default route origination for the NSSA, allowing the redistribute policy to advertise a default route if one is present. The resulting OSPF behavior depends on the presence of an installed static default route and on whether static routes are redistributed in OSPF (using the [redistribute \(OSPFv2\)](#) command). The **no area nssa default-information-originate** command disables advertisement of the default route for the NSSA regardless of the redistribute policy. See [Advertisement of Default Route](#) for details.

Areas are **normal** by default; area type configuration is required only for stub and NSSA areas. Area 0 is always a normal area and cannot be configured through this command.

Default route origination is configured differently for different area types and supports three area types:

- Normal areas: advertisement of the default route is configured for all normal areas using the [default-information originate \(OSPFv2\)](#) command.
- Stub areas: the default route is automatically advertised in stub areas and cannot be configured.
- Not So Stubby Areas (NSSAs): advertisement of the default route is configured per area using the [area nssa default-information-originate \(OSPFv2\)](#) or [area nssa no-summary \(OSPFv2\)](#) command.

Table 69: Advertisement of Default Route

Static Default Route Installed	Redistribute Static	Command Form	Advertise in ABR	Advertise in ASBR
no	no	default or no	no	no
no	no	standard	yes	no
no	yes	default	yes	yes
no	yes	no	no	no
no	yes	standard	yes	no
yes	no	default or no	no	no
yes	no	standard	yes	yes
yes	yes	default	yes	yes
yes	yes	no	no	no
yes	yes	standard	yes	yes

Command Mode

Router-OSPF Configuration

Command Syntax

```
area area_id nssa default-information-originate [VALUE][TYPE][EXCL]
```

```
no area area_id nssa default-information-originate
```

```
default area area_id nssa default-information-originate
```

Parameters

- *area_id* All parameters except *area_id* can be placed in any order.
 - Valid formats: integer <1 to 4294967295> or dotted decimal <0.0.0.1 to 255.255.255.255>
 - Area 0 (or 0.0.0.0) is not configurable; it is always **normal**.
 - **running-config** stores value in dotted decimal notation.
- VALUE Values include:
 - <no parameter> Default value of 1.
 - metric <1-65535>
- TYPE Values include:
 - <no parameter>.
 - metric-type <1-2>
- EXCL Values include:
 - <no parameter>.
 - **nssa-only**

Example

This command configures area 3 as an NSSA and generates a type 7 default LSA within the NSSA.

```
switch(config-router-ospf) #area 3 nssa default-information-originate
nssa-only
switch(config-router-ospf) #
```

14.2.1.6.8 area nssa no-summary (OSPFv2)

The **area nssa no-summary** command configures the switch stop importing type-3 summary LSAs into the not-so-stubby area and sets the default summary route into the NSSA in order to reach the inter-area prefixes.

The **no area nssa no-summary** and **default area nssa no-summary** commands allow type-3 summary LSAs into the NSSA area.

The **no area nssa** and **default area nssa** commands configure the specified area as a normal area.

Command Mode

Router-OSPF Configuration

Command Syntax

```
area area_id nssa no-summary
no area area_id nssa no-summary
default area area_id nssa no-summary
```

Parameters

- *area_id* Area number.
 - Valid formats: integer <1 to 4294967295> or dotted decimal <0.0.0.1 to 255.255.255.255>
 - Area 0 (or 0.0.0.0) is not configurable; it is always normal.
 - **running-config** stores value in dotted decimal notation.

Examples

- This command directs the device not to import type-3 summary LSAs into the NSSA area

```
switch(config) #router ospf 6
switch(config-router-ospf) #area 1.1.1.1 nssa no-summary
```

```
switch(config-router-ospf) #
```

- This command directs the device to import type-3 summary LSAs into the NSSA area.

```
switch(config) #router ospf 6  
switch(config-router-ospf) #no area 1.1.1.1 nssa no-summary  
switch(config-router-ospf) #
```

14.2.1.6.9 area range (OSPFv2)

The **area range** command configures OSPF area border routers (ABRs) to consolidate or summarize routes, to set the cost setting routes, and to suppress summary route advertisements.

The **no area (OSPFv2)** command removes all area commands for the specified area from **running-config**.

Command Mode

Router-OSPF Configuration

Command Syntax

```
area area_id range net_addr [ADVERTISE_SETTING][COST_SETTING]
```

```
no area area_id range net_addr [ADVERTISE_SETTING][COST_SETTING]
```

```
default area area_id range net_addr [ADVERTISE_SETTING][COST_SETTING]
```

Parameters

- *area_id* Area number. <0 to 4294967295> or <0.0.0.0 to 255.255.255.255> **running-config** stores value in dotted decimal notation.
- *net_addr*
- ADVERTISE_SETTING Values include
 - <no parameter>
 - **advertise**
 - **not-advertise**
- Values include
 - <no parameter>
 - **cost range_cost** Value ranges from 1 to 65535.

Examples

- The **network area** command assigns two subnets to an area. The **area range** command summarizes the addresses, which the ABR advertises in a single LSA.

```
switch(config)#router ospf 6
switch(config-router-ospf)#network 10.1.25.80 0.0.0.240 area 5
switch(config-router-ospf)#network 10.1.25.112 0.0.0.240 area 5
switch(config-router-ospf)#area 5 range 10.1.25.64 0.0.0.192
switch(config-router-ospf)#
```

- The **network area** command assigns a subnet to an area, followed by an **area range** command that suppresses the advertisement of that subnet.

```
switch(config-router-ospf)#network 10.12.31.0/24 area 5
switch(config-router-ospf)#area 5 range 10.12.31.0/24 not-advertise
switch(config-router-ospf)#
```

14.2.1.6.10 area stub (OSPFv2)

The **area stub** command sets the area type of an OSPF area to **stub**. All devices in an AS must specify the same area type for identically numbered areas.

The **no area stub** command remove the specified stub area from the OSPFv2 instance by deleting all **area stub** commands from **running-config** for the specified area.

The **no area stub command** configure the specified area as a normal area.

Command Mode

Router-OSPF Configuration

Command Syntax

```
area area_id stub [summarize]
```

```
no area area_id stub [summarize]
```

```
default area area_id stub [summarize]
```

Parameters

- *area_id* Area number.
 - Valid formats: integer <1 to **4294967295**> or dotted decimal <**0.0.0.1** to **255.255.255.255**>
 - Area 0 (or 0.0.0.0) is not configurable; it is always normal.
 - **running-config** stores value in dotted decimal notation.
- summarize Area type. Values include:
 - <*no parameter*>
 - no-summary

Examples

- These commands configure area 45 as a stub area.

```
switch(config)#router ospf 3  
switch(config-router-ospf)#area 45 stub  
switch(config-router-ospf)#
```

- This command configures area 10.92.148.17 as a stub area.

```
switch(config-router-ospf)#area 10.92.148.17 stub  
switch(config-router-ospf)#
```

14.2.1.6.11 clear ip ospf neighbor

The `clear ip ospf` command clears the neighbors statistics per interface.

Command Mode

Privileged EXEC

Command Syntax

```
clear ip ospf [PROCESS_ID] neighbor [LOCATION][VRF_INSTANCE]
```

Parameters

- PROCESS_ID OSPFv2 process ID. Values include:
 - *<no parameter>*
 - *<1 to 65535>*
- LOCATION IP Address or interface peer group name. Values include:
 - *** clears all OSPF IPv4 neighbors.
 - *ipv4_addr*
 - *ethernet e_num*
 - *loopback l_num*
 - *port-channel p_num*
 - *vlan v_num*
- VRF_INSTANCE Specifies the VRF instance.
 - *vrf vrf_name* configures the *vrf_name* instance.

Examples

- This command resets all OSPF neighbor statistics.

```
switch#clear ip ospf neighbor *
switch#
```

- This command resets the OSPF neighbor statistics for the specified Ethernet 3 interface.

```
switch#clear ip ospf neighbor ethernet 3
switch#
```

14.2.1.6.12 compatible (OSPFv2)

The **compatible** command allows the selective disabling of compatibility with RFC 2328.

The **no compatible** and **default compatible** commands reverts OSPF to RFC 2328 compatible and removes the compatible statement from running-config.

Command Mode

Router-OSPF Configuration

Command Syntax

```
compatible rfc1583
```

```
no compatible rfc1583
```

```
default compatible rfc1583
```

Example

- This command sets the OSPF compatibility list with RFC 1583.

```
switch(config)#router ospf 6  
switch(config-router-ospf)#compatible rfc1583  
switch(config-router-ospf)#
```

- This command disables RFC 1583 compatibility.

```
switch(config)#router ospf 6  
switch(config-router-ospf)# no compatible rfc1583  
switch(config-router-ospf)#
```

14.2.1.6.13 default-information originate (OSPFv2)

The **default-information originate** command enables default route origination for normal areas. The user may configure the metric value and metric type used in LSAs. The **always** option will cause the ASBR to create and advertise a default route whether or not one is configured.

The **no default-information originate** command prevents the advertisement of the default route. The **default default-information originate** command enables default route origination with default values (metric type 2, metric=1).

Command Mode

Router-OSPF Configuration

Command Syntax

```
default-information originate [FORCE][VALUE][TYPE][MAP]
```

```
no default-information originate
```

```
default default-information originate
```

Parameters

All parameters can be placed in any order.

- **FORCE** Advertisement forcing option. Values include:
 - *<no parameter>*
 - **always**
- **VALUE** Values include:
 - *<no parameter>*
 - **metric <1-65535>**
- **TYPE** Values include:
 - *<no parameter>*
 - **metric-type <1-2>**
- **MAP** Sets attributes in the LSA based on a route map. Values include:
 - *<no parameter>*
 - **route-map *map_name***.

Examples

- These commands will always advertise the OSPFv2 default route regardless of whether the switch has a default route configured.

```
switch(config)#router ospf 1
switch((config-router-ospf)#default-information originate always
switch(config-router-ospf)#show active
router ospf 1
  default-information originate always
```

- These commands advertise a default route with a metric of 100 and an external metric type of 1 if a default route is configured.

```
switch(config)#router ospf 1
switch((config-router-ospf)#default-information originate metric 100
metric-type 1
```

14.2.1.6.14 distance ospf (OSPFv2)

The `distance ospf` command specifies the administrative distance for intra-area, inter-area, or external OSPF routes. The command must be issued separately for each route type being configured. The default administrative distance for all routes is 110.

The `no distance ospf` and `default distance ospf` commands remove the corresponding `distance ospf` command from *running-config*, returning the OSPFv2 administrative distance setting for the specified route type to the default value of 110.

 **Note:** OSPF links will flap if the administrative distance value is adjusted while OSPF is running, whether it is adjusted by entering the `distance ospf` command directly through the CLI or by applying a configuration file that contains the command.

Command Mode

Router-OSPF Configuration

Command Syntax

```
distance ospf [external|inter-area|intra-area]
```

```
no distance ospf [external|inter-area|intra-area]
```

```
default distance ospf [external|inter-area|intra-area]
```

Parameters

- `external` Sets administrative distance for external routes.
- `inter-area` Sets administrative distance for inter-area routes.
- `intra-area` Sets administrative distance for intra-area routes.
- `distance` Values range from 1 to 255. Default value is 110 for all types.

Example

This command configures an administrative distance of 85 for all OSPFv2 intra-area routes on the switch. If issued while OSPF is running, this command will cause OSPF links to flap.

```
switch(config)#router ospf 6  
switch(config-router-ospf)#distance ospf intra-area 85  
switch(config-router-ospf)#
```

14.2.1.6.15 distribute-list in

A distribute list uses a route map or prefix list to filter specific routes from incoming OSPF LSAs. Filtering occurs after SPF calculation. The filtered routes are not installed on the switch, but are still included in LSAs sent by the switch. The **distribute-list in** command creates a distribute list in the configuration mode OSPF instance.

If a prefix list is used, destination prefixes that do not match the prefix list will not be installed. If a route map is used, routes may be filtered based on address, next hop, or metric. OSPF external routes may also be filtered by metric type or tag.

The **no distribute-list in** and **default distribute-list in** commands remove the **distribute-list in** command from *running-config*.

Command Mode

Router-OSPF Configuration

Command Syntax

```
distribute-list {prefix-list | route-map} list_name in
no distribute-list {prefix-list | route-map}
default distribute-list {prefix-list | route-map}
```

Parameters

- **prefix-list** Specifies a prefix-list as the filter.
- **route-map** Specifies a route-map as the filter.
- **list_name** The name of the prefix-list or route-map used to filter routes from incoming LSAs.

Related Commands

[area filter \(OSPFv2\)](#)

[redistribute \(OSPFv2\)](#)

Example

These commands configure a prefix list named `dist_list1` in OSPF instance 5 to filter certain routes from incoming OSPF LSAs.

```
switch(config) #router ospf 5
switch(config-router-ospf) #distribute-list prefix-list dist_list1 in
switch(config-router-ospf) #
```

14.2.1.6.16 dn-bit-ignore (OSPFv2)

The **dn-bit-ignore** command results in the DN bit in Type 3 Summary LSAs to be ignored during the shortest path first (SPF) calculations.

The **no dn-bit-ignore** and **default dn-bit-ignore** commands result in the DN bit in Type 3 Summary LSAs to not be ignored during SPF calculations.

Command Mode

Router-OSPF Configuration

Command Syntax

```
dn-bit-ignore
```

```
no dn-bit-ignore
```

```
default dn-bit-ignore
```

Examples

- This command ignores the DN bit.

```
switch(config)#router ospf 6  
switch(config-router-ospf)#dn-bit-ignore  
switch(config-router-ospf)#
```

- This command causes the DN bit not to be ignored.

```
switch(config)#router ospf 6  
switch(config-router-ospf)#no dn-bit-ignore  
switch(config-router-ospf)#
```

14.2.1.6.17 interface Tunnel

OSPF packets by default are sent with Time to Live (TTL) value 1. This may not work in tunnel scenarios where the peer tunnel end point could be more than one hop away. It is recommended to explicitly configure TTL on the tunnel interface. TTL configuration is allowed only if **path-mtu-discovery** is configured.

Command Mode

Configuration mode

Command Syntax

```
interface Tunnel Tunnel No
```

Parameters

Tunnel No

Example

```
(config)#interface Tunnel Tunnel No  
(config-if-Tu0)#tunnel path-mtu-discovery  
(config-if-Tu0)#tunnel ttl TTL value
```

14.2.1.6.18 ip ospf area

The `ip ospf area` command enables OSPFv2 on an interface and associates the area to the interface.

The `no ip ospf area` and `default ip ospf area` commands disable OSPFv2 on the configuration mode interface and remove the configured area from the system.

 **Note:** The per interface configuration has precedence over the OSPF Configuration mode. In other words, the area configured by the `ip ospf area` command has precedence over the area configured by the `network area` command.

Command Mode

Interface-Ethernet Configuration

Interface-Loopback Configuration

Interface-Port-Channel Configuration

Interface-VLAN Configuration

Command Syntax

```
ip ospf area area_id
```

```
no ip ospf area area_id
```

```
default ip ospf area area_id
```

Parameters

area_id The area ID. The valid values are **0** to **4294967295** or a decimal range between **0.0.0.0** and **255.255.255.255**.

Example

These commands enable OSPFv2 on the `et2` interface and associates area identifier `1.1.1.1` to the interface.

```
switch(config)#Interface ethernet 2  
switch(config-if-Et2)# ip address 1.0.0.1/24  
switch(config-if-Et2)# ip ospf area 1.1.1.1  
router ospf 1
```

14.2.1.6.19 ip ospf authentication

The **ip ospf authentication** command enables OSPFv2 authentication for the configuration mode interface..

The **no ip ospf authentication** and **default ip ospf authentication** commands disable OSPFv2 authentication on the configuration mode interface by removing the corresponding **ip ospf authentication** command from *running-config*.

Command Mode

Interface-Ethernet Configuration

Interface-Port-Channel Configuration

Interface-VLAN Configuration

Command Syntax

```
ip ospf authentication [METHOD]
```

```
no ip ospf authentication
```

```
default ip ospf authentication
```

Parameters

- METHOD OSPFv2 authentication method. Options include:
 - *<no parameter>*
 - message-digest

Examples

- This command enables simple authentication on VLAN 12.

```
switch(config)#interface vlan 12  
switch(config-if-vl12)#ip ospf authentication  
switch(config-if-vl12)#
```

- This command enables message-digest authentication on VLAN 12.

```
switch(config-if-vl12)#ip ospf authentication message-digest  
switch(config-if-vl12)#
```

14.2.1.6.20 ip ospf authentication-key

The `ip ospf authentication-key` command configures the OSPFv2 authentication password for the configuration mode interface.

The `no ip ospf authentication-key` and `default ip ospf authentication-key` commands removes the OSPFv2 authentication password from the configuration mode interface by removing the corresponding `ip ospf authentication-key` command from *running-config*.

Command Mode

Interface-Ethernet Configuration

Interface-Port-Channel Configuration

Interface-VLAN Configuration

Command Syntax

```
ip ospf authentication-key [ENCRYPT_TYPE] key_text
```

```
no ip ospf authentication-key
```

```
default ip ospf authentication-key
```

Parameters

- ENCRYPT_TYPE Encryption level of the *key_text* parameter. Values include:
 - *<no parameter>* the *key_text* is in clear text.
 - **0** *key_text* is in clear text. Equivalent to *<no parameter>*.
 - **7** *key_text* is MD5 encrypted.
- *key_text* the authentication-key password.

Example

This command specifies a password in clear text.

```
switch(config)#interface vlan 12
switch(config-if-Vl12)#ip ospf authentication-key 0 code123
switch(config-if-Vl12)#show active
interface Vlan12
    ip ospf authentication-key 7 baY1lFzVbcx4yHq1IhmMdw==
switch(config-if-Vl12)#
```

The *running-config* stores the password as an encrypted string.

14.2.1.6.21 ip ospf cost

The `ip ospf cost` command configures the OSPFv2 cost for the configuration mode interface. The default cost depends on the interface type:

- Ethernet: determined by the `auto-cost reference-bandwidth (OSPFv2)` command.
- Port channel: 10.
- VLAN: 10.

The `no ip ospf cost` and `default ip ospf cost` commands restore the default OSPFv2 cost for the configuration mode interface by removing the corresponding `ip ospf cost` command from *running-config*.

Command Mode

Interface-Ethernet Configuration

Interface-Loopback Configuration

Interface-Port-Channel Configuration

Interface-VLAN Configuration

Command Syntax

```
ip ospf cost interface_cost
```

```
no ip ospf cost
```

```
default ip ospf cost
```

Parameters

interface_cost Value ranges from 1 to 65535; default is 10.

Example

This command configures a cost of 15 for VLAN 2.

```
switch(config)#interface vlan 2  
switch(config-if-Vl2)#ip ospf cost 15  
switch(config-if-Vl2)#
```

14.2.1.6.22 ip ospf dead-interval

The **ip ospf dead-interval** command configures the dead interval for the configuration mode interface.

The **no ip ospf dead-interval** and **default ip ospf dead-interval** commands restore the default dead interval of 40 seconds on the configuration mode interface by removing the corresponding **ip ospf dead-interval** command from *running-config*.

Command Mode

Interface-Ethernet Configuration

Interface-Port-Channel Configuration

Interface-VLAN Configuration

Command Syntax

```
ip ospf dead-interval time
```

```
no ip ospf dead-interval
```

```
default ip ospf dead-interval
```

Parameters

time Value ranges from 1 to 8192; default is 40.

Example

This command configures a dead interval of 120 seconds for VLAN 4.

```
switch(config)#interface vlan 4  
switch(config-if-Vl4)#ip ospf dead-interval 120  
switch(config-if-Vl4)#
```

14.2.1.6.23 ip ospf disabled

The **ip ospf disabled** command disables OSPFv2 on the configuration mode interface without disrupting the OSPFv2 configuration. When OSPFv2 is enabled on the switch, the it is also enabled by default on all interfaces.

The OSPFv2 instance is disabled on the entire switch with the **shutdown (OSPFv2)** command.

The **no ip ospf disabled** and **default ip ospf disabled** commands enable OSPFv2 on the configuration mode interface by removing the corresponding **ip ospf disabled** command from *running-config*.

Command Mode

Interface-Ethernet Configuration

Interface-Port-Channel Configuration

Interface-VLAN Configuration

Command Syntax

```
ip ospf disabled
```

```
no ip ospf disabled
```

```
default ip ospf disabled
```

Examples

- This command shuts down OSPFv2 activity on VLAN 5.

```
switch(config)#interface vlan 5
switch(config-if-V15)#ip ospf disabled
switch(config-if-V15)#
```

- This command resumes OSPFv2 activity on VLAN 5.

```
switch(config-if-V15)#no ip ospf disabled
switch(config-if-V15)#
```

14.2.1.6.24 ip ospf hello-interval

The **ip ospf hello-interval** command configures the OSPFv2 hello interval for the configuration mode interface.

The same hello interval should be specified for Each OSPFv2 neighbor, and should not be longer than any neighbors dead interval.

The **no ip ospf hello-interval** and **default ip ospf hello-interval** commands restore the default hello interval of 10 seconds on the configuration mode interface by removing the **ip ospf hello-interval** command from *running-config*.

Command Mode

Interface-Ethernet Configuration

Interface-Port-Channel Configuration

Interface-VLAN Configuration

Command Syntax

```
ip ospf hello-interval time
```

```
no ip ospf hello-interval
```

```
default ip ospf hello-interval
```

Parameter

time Hello interval (seconds). Values range from 1 to 8192; default is 10.

Example

This command configures a hello interval of 30 seconds for VLAN 2.

```
switch(config)#interface vlan 2  
switch(config-if-V12)#ip ospf hello-interval 30  
switch(config-if-V12)#
```

14.2.1.6.25 ip ospf message-digest-key

The **ip ospf message-digest-key** command configures a message digest authentication key for the configuration mode interface.

The **no ip ospf message-digest-key** and **default ip ospf message-digest-key** commands remove the message digest authentication key for the specified key ID on the configuration mode interface by deleting the corresponding **ip ospf message-digest-key** command from **running-config**.

Command Mode

Interface-Ethernet Configuration

Interface-Port-Channel Configuration

Interface-VLAN Configuration

Command Syntax

```
ip ospf message-digest-key key_id md5 ENCRYPT_TYPE key_text
```

```
no ip ospf message-digest-key key_id
```

```
default ip ospf message-digest-key key_id
```

Parameters

- *key_id* Key ID number. Value ranges from 1 to 255.
- ENCRYPT_TYPE Encryption level of the *key_text* parameters. Values include:
 - *<no parameter>*
 - **0** *key_text*
 - **7** *key_text*
- *key_text* message key (password).

Example

This command configures *code123* as the MD5 key with a corresponding key ID of 23.

```
switch(config)#interface vlan 12  
switch(config-if-vl12)#ip ospf message-digest-key 23 md5 0 code123  
switch(config-if-vl12)#
```

The **running-config** stores the password as an encrypted string.

14.2.1.6.26 ip ospf network point-to-point

The **ip ospf network point-to-point** command sets the configuration mode interface as a point-to-point link. By default, interfaces are configured as broadcast links.

The **no ip ospf network** and **default ip ospf network** commands set the configuration mode interface as a broadcast link by removing the corresponding **ip ospf network** command from *running-config*.

Command Mode

Interface-Ethernet Configuration

Interface-Port-Channel Configuration

Interface-VLAN Configuration

Command Syntax

```
ip ospf network point-to-point
```

```
no ip ospf network
```

```
default ip ospf network
```

Examples

- These commands configure Ethernet interface 10 as a point-to-point link.

```
switch(config)#interface ethernet 10  
switch(config-if-Et10)#ip ospf network point-to-point  
switch(config-if-Et10)#
```

- This command restores Ethernet interface 10 as a broadcast link.

```
switch(config-if-Et10)#no ip ospf network  
switch(config-if-Et10)#
```

14.2.1.6.27 ip ospf retransmit-interval

The **ip ospf retransmit-interval** command configures the link state advertisement retransmission interval for the interface.

The **no ip ospf retransmit-interval** and **default ip ospf retransmit-interval** commands restore the default retransmission interval of 5 seconds on the configuration mode interface by removing the corresponding **ip ospf retransmit-interval** command from *running-config*.

Command Mode

Interface-Ethernet Configuration

Interface-Port-Channel Configuration

Interface-VLAN Configuration

Command Syntax

```
ip ospf retransmit-interval period
no ip ospf retransmit-interval
default ip ospf retransmit-interval
```

Parameters

period Retransmission interval (seconds). Value ranges from 1 to 8192; default is 5.

Example

This command configures a retransmission interval of 15 seconds for VLAN 3.

```
switch(config)#interface vlan 3
switch(config-if-Vl3)#ip ospf retransmit-interval 15
switch(config-if-Vl3)#
```

14.2.1.6.28 ip ospf router-id output-format hostnames

The `ip ospf router-id output-format hostnames` command causes the switch to display DNS names in place of numeric OSPFv2 router IDs in all OSPFv2 show commands, including:

- `show ip ospf`
- `show ip ospf border-routers`
- `show ip ospf database <link state list>`
- `show ip ospf database database-summary`
- `show ip ospf database <link-state details>`
- `show ip ospf interface`
- `show ip ospf neighbor`
- `show ip ospf request queue`
- `show ip ospf retransmission queue`

The `no ip ospf router-id output-format hostnames` and `default ip ospf router-id output-format hostnames` commands remove the `ip ospf router-id output-format hostnames` command from *running-config*, restoring the default behavior of displaying OSPFv2 router IDs by their numeric value.

Command Mode

Global Configuration

Command Syntax

```
ip ospf router-id output-format hostnames
no ip ospf router-id output-format hostnames
default ip ospf router-id output-format hostnames
```

Example

This command programs the switch to display OSPFv2 router IDs by the corresponding DNS name in subsequent show commands.

```
switch(config)#ip ospf router-id output-format hostnames
switch(config)#
```

14.2.1.6.29 ip ospf transmit-delay

The **ip ospf transmit-delay** command configures the transmission delay for OSPFv2 packets over the configuration mode interface.

The **no ip ospf transmit-delay** and **default ip ospf transmit-delay** commands restore the default transmission delay (one second) on the configuration mode interface by removing the corresponding **ip ospf transmit-delay** command from **running-config**.

Command Mode

Interface-Ethernet Configuration

Interface-Port-Channel Configuration

Interface-VLAN Configuration

Command Syntax

```
ip ospf transmit-delay trans
no ip ospf transmit-delay
default ip ospf transmit-delay
```

Parameters

trans LSA transmission delay (seconds). Value ranges from 1 to 8192; default is 1.

Example

This command configures a transmission delay of 5 seconds for VLAN 6.

```
switch(config)#interface vlan 6
switch(config-if-Vl6)#ip ospf transmit-delay 5
switch(config-if-Vl6)#
```

14.2.1.6.30 ip ospf priority

The **ip ospf priority** command configures OSPFv2 router priority for the configuration mode interface..

The **no ip ospf priority** and **default ip ospf priority** commands restore the default priority (1) on the configuration mode interface by removing the corresponding **ip ospf priority** command from **running-config**.

Command Mode

Interface-Ethernet Configuration Interface-Port-Channel Configuration Interface-VLAN Configuration

Command Syntax

```
ip ospf priority priority_level
no ip ospf priority
default ip ospf priority
```

Parameters

priority_level priority level. Value ranges from 0 to 255. Default value is 1.

Examples

- This command configures a router priority of 15 for VLAN 8.

```
switch(config)#interface vlan 8
switch(config-if-Vl8)#ip ospf priority 15
```

```
switch(config-if-Vl8) #
```

- This command restores the router priority of 1 for VLAN 7.

```
switch(config) #interface vlan 7  
switch(config-if-Vl7) #no ip ospf priority  
switch(config-if-Vl7) #
```

14.2.1.6.31 line system

The **line system** command places the switch in the OSPF - Line System configuration mode.

The **no line system** command removes the Line System configurations from the **running-config**.

Command Mode

Global Configuration Mode

Command Syntax

```
line system
```

```
no line system
```

Parameters

- The following parameters are allowed to be configured under LS mode.
 - **port <number>** Transceiver slot number. Value ranges from 1 - 66.
 - The following parameters are allowed under **LS port mode**:
 - booster Booster settings
 - pre-amp Pre-amp settings

Example

- This command places the switch in the OSPF Line System configuration mode.

```
switch#conf
switch(config)#line system
switch(config-ls)#
```

14.2.1.6.32 log-adjacency-changes (OSPFv2)

The **log-adjacency-changes** command enables syslog messages to be sent when it detects OSPFv2 link state changes or when it detects that a neighbor has gone up or down. Log message sending is enabled by default.

The **default log-adjacency-changes** command restores the default state by removing the **log-adjacency-changes** statement from *running-config*.

The default option (sending a message only when a neighbor goes up or down) is active when running-config does not contain any form of the command. Entering the command in any form replaces the previous command state in *running-config*.

The **no log-adjacency-changes** disables link state change syslog reporting.

The **default log-adjacency-changes** command restores the default state by removing the **log-adjacency-changes detail** or **no log-adjacency-changes** statement from *running-config*.

Command Mode

Router-OSPF Configuration

Command Syntax

```
log-adjacency-changes detail
no log-adjacency-changes
default log-adjacency-changes
```

Examples

- This command configures the switch to send a syslog message when a neighbor goes up or down.

```
switch(config)#router ospf 6
switch(config-router-ospf)#log-adjacency-changes
switch(config-router-ospf)#
```

- After entering the command, **show active** does not display a **log-adjacency-changes** statement.

```
switch(config-router-ospf)#show activerouter ospf 1
switch(config-router-ospf)#
```

- This command configures the switch to send a syslog message when it detects any link state change.

```
switch(config-router-ospf)#log-adjacency-changes detail
switch(config-router-ospf)#
```

- After entering the command, **show active** displays a **log-adjacency-changes detail** command.

```
switch(config-router-ospf)#show active router ospf 1
log-adjacency-changes detail
switch(config-router-ospf)#
```

14.2.1.6.33 maximum-paths (OSPFv2)

The **maximum-paths** command controls the number of parallel routes that OSPFv2 supports. The default maximum is 16 paths.

The **no maximum-paths** and **default maximum-paths** commands restore the maximum number of parallel routes that OSPFv2 supports on the switch to the default value of 16 by placing the **maximum-paths 16** statement in *running-config*.

Command Mode

Router-OSPF Configuration

Command Syntax

```
maximum-paths paths
```

```
no maximum-paths
```

```
default maximum-paths
```

Parameters

- *paths* Maximum number of parallel routes.

Value ranges from 1 to the number of interfaces available per ECMP group, which is platform dependent.

- Arad: Value ranges from 1 to 128. Default value is 128.
 - FM6000: Value ranges from 1 to 32. Default value is 32.
 - PetraA: Value ranges from 1 to 16. Default value is 16.
 - Trident: Value ranges from 1 to 32. Default value is 32.
 - Trident II: Value ranges from 1 to 128. Default value is 128.

Example

This command configures the maximum number of OSPFv2 parallel paths to 12.

```
switch(config)#router ospf 6  
switch(config-router-ospf)#maximum-paths 12  
switch(config-router-ospf)#
```

14.2.1.6.34 max-lsa (OSPFv2)

The `max-lsa` command specifies the maximum number of LSAs allowed in the LSDB. Setting the limit to zero removes the LSDB restriction and disables LSA overload actions. Actions triggered by LSDB overload conditions include:

- **Warning:** the switch logs OSPF MAXLSAWARNING if the LSDB contains a specified percentage of the LSA maximum.
- **Temporary shutdown:** when the LSDB exceeds the LSA maximum, OSPFv2 is disabled and does not accept or acknowledge new LSAs. The switch re-starts OSPFv2 after a specified period (the default is five minutes).
- **Permanent shutdown:** the switch permanently disables OSPFv2 after performing a specified number of temporary shutdowns (the default is five). This state usually indicates the need to resolve a network condition that consistently generates excessive LSA packets.

The `no max-lsa` and `default max-lsa` commands restore all LSA overload parameters to their default settings.

 **Note:** if OSPFv2 has entered permanent shutdown, it can also be restarted by increasing the LSA limit to a value larger than the number of LSAs in the database. Setting the max-LSA value to zero will also restart OSPFv2, and will disable overload protection.

Command Mode

Router-OSPF Configuration

Command Syntax

```
max-lsa lsa_num [WARNING] [IGNORE_TIME] [IGNORE_COUNT] [RESET]
```

```
no max-lsa
```

```
default max-lsa
```

Parameters

- *lsa_num* Maximum number of LSAs. Value ranges from 0 to 100,000.
 - **0** Disables overload protection.
 - **1 to 100000** Specifies maximum value; default value is 12,000.
- **WARNING** Warning threshold, as a percentage of the maximum number of LSAs (% of *lsa_num*).
 - *<no parameter>* Default of 75%.
 - *percent* Ranges from 25 to 99.
- **IGNORE_TIME** Temporary shutdown period (minutes). Options include:
 - *<no parameter>* Default value of 5 minutes.
 - *ignore-time period* Value ranges from 1 to 60.
- **IGNORE_COUNT** Number of temporary shutdowns required to trigger a permanent shutdown.
 - *<no parameter>* Default value of 5.
 - *ignore-count episodes* Ranges from 1 to 20.
- **RESET** Period of not exceeding LSA limit required to reset temporary shutdown counter to zero.
 - *<no parameter>* Default value of 5 minutes
 - *reset-time r_period* Ranges from 1 to 60.

Example

This command defines an LSA limit of 8,000 and other parameters.

```
switch(config-router-ospf) #max-lsa 8000 40 ignore-time 6 ignore-count 3
reset-time 20
switch(config-router-ospf) #
```

14.2.1.6.35 max-metric router-lsa (OSPFv2)

The **max-metric router-lsa** command configures OSPF to include the maximum value in LSA metric fields to keep other network devices from using the switch as a preferred intermediate SPF hop.

The **no max-metric router-lsa** and **default max-metric router-lsa** commands disable the advertisement of a maximum metric.

Command Mode

Router-OSPF Configuration

Command Syntax

```
max-metric router-lsa [EXTERNAL][STUB][STARTUP][SUMMARY]
no max-metric router-lsa [EXTERNAL][STUB][STARTUP][SUMMARY]
default max-metric router-lsa [EXTERNAL][STUB][STARTUP][SUMMARY]
```

Parameters

All parameters can be placed in any order.

- **EXTERNAL** Advertised metric value. Values include:
 - *<no parameter>* Default value of 1.
 - **external-lsa** <1 to 16777215> Default value is **0xFF0000**.
- **STUB** Advertised metric type. Values include:
 - *<no parameter>* Default value of 2.
 - **include-stub**
- **STARTUP** Limit scope of LSAs. Values include:
 - *<no parameter>*
 - **on-startup**
 - **on-startup wait-for-bgp**
 - **on-startup** <5 to 86400>

wait-for-bgp or an **on-start** time value is not included in **no** and **default** commands.

- **SUMMARY** Advertised metric value. Values include:
 - *<no parameter>*
 - **summary-lsa**
 - **summary-lsa** <1 to 16777215>

Example

This command configures OSPF to include the maximum value in LSA metric fields until BGP has converged:

```
switch(config-router-ospf) #max-metric router-lsa on-startup wait-for-bgp
switch(config-router-ospf) #
```

14.2.1.6.36 network area (OSPFv2)

The **network area** command assigns the specified IPv4 subnet to an OSPFv2 area.

The **no network area** and **default network area** commands delete the specified network area assignment by removing the corresponding **network area** command from *running-config*.

Command Mode

Router-OSPF Configuration

Command Syntax

```
network ipv4_subnet area area_id
no network ipv4_subnet area area_id
default network ipv4_subnet area area_id
```

Parameters

- *ipv4_subnet* IPv4 subnet. Entry formats include address-prefix (CIDR) or address-wildcard mask. *running-config* stores value in CIDR notation.
- *area_id* Area number. <0 to 4294967295> or <0.0.0.0 to 255.255.255.255> *running-config* stores value in dotted decimal notation.

Example

These equivalent commands each assign the subnet 10.1.10.0/24 to area 0.

```
switch(config-router-ospf) #network 10.1.10.0 0.0.0.255 area 0
switch(config-router-ospf) #
switch(config-router-ospf) #network 10.1.10.0/24 area 0
switch(config-router-ospf) #
```

14.2.1.6.37 no area (OSPFv2)

The `no area <type>` command removes the corresponding `area <type>` command from *running-config*:

- `no/default area not-so-stubby` `lsa type-7` `convert type-5` commands remove the `translate type7 always` parameter without changing the area type.
- `no/default area nssa` , `no/default area stub`, and `no/default area stub no-summary` commands restore the areas type to **normal**. [OSPFv2 Commands](#)
- `no/default area default-information-originate` command removes all area commands for the specified area from *running-config*
- `no/default area` command removes all area commands for the specified area from *running-config*
- `no/default area` command removes all area commands for the specified area from *running-config*

Command Mode

Router-OSPF Configuration

Command Syntax

```
no area area_id [TYPE]
```

```
default area area_id [TYPE]
```

Parameters

- *area_id* area number.
 - Valid formats: integer <1 to **4294967295**> or dotted decimal <**0.0.0.1** to **255.255.255.255**>
 - Area 0 (or 0.0.0.0) is not configurable; it is always **normal**.
 - *Running-config* stores value in dotted decimal notation.
- TYPE Area type. Values include:
 - `nssa`
 - `nssa translate type7 always`
 - **stub**
 - `stub no-summary`

Examples

- These commands remove area 1 from the running configuration.

```
switch(config)#router ospf 6
switch(config-router-ospf)#no area 1
switch(config-router-ospf)#
```

- These commands remove area 10.92.148.17 as an NSSA.

```
switch(config-router-ospf)#no area 10.92.148.17 nssa
switch(config-router-ospf)#
```

14.2.1.6.38 packet

This describes packet types that the feature is applied on.

Command Mode

system-feature-source-profile (*config-hw-tcam-profile-profile-feature-feature*)

Command Syntax

packet *packet header tokens* forwarding< bridged | routed | mpls >[multicast][decap]

Parameters

- **packet header tokens** The packet header is described as a series of CLI packet header tokens after the **packet** token. It starts from the outer most header after Ethernet. For example, a regular IPv4 packet is **packet ipv4** and a VXLAN packet is **packet ipv4 vxlan eth ipv4**.
- **forwarding** The **forwarding** token indicates the forwarding type of the packet.
 - **bridged**
 - **routed**
 - **mpls**
 - **multicast** Indicates if the packet is a multicast packet.
 - **decap** Indicates if the packet is decapsulated after a tunnel.

Guidelines

On DCS-7020, DCS-7280R/R2 or DCS-7500R/R2, enabling OSPF routes over GRE tunnels requires the system TCAM profile to have “Tunnel IPv4” feature enabled so that control packets such as OSPF hellos received over GRE tunnel interfaces are appropriately classified. This can be achieved by creating a user defined TCAM profile.

The user defined TCAM profile may be created either manually from scratch or by copying from an existing TCAM profile. The system TCAM profile must have the feature **tunnel ipv4** for OSPFv2 over GRE tunnel interfaces to work. This is applicable regardless of whether the TCAM profile is copied from an existing profile or created from scratch.

To create a user defined TCAM profile.

```
(config)#hardware tcam
(config-hw-tcam)#profile profilename copy default
(config-hw-tcam-profile-profile)#feature tunnel ipv4 copy system-feature-source-profile
```

The following steps are optional if the feature is added by copying from system-feature-source-profile.

- Set the packet types for the feature as follows to match GRE tunnelled ipv4 routed unicast and multicast packets.

```
(config-hw-tcam-profile-profile-feature-feature)#packet ipv4 non-vxlan forwarding routed decap
(config-hw-tcam-profile-profile-feature-feature)#packet ipv4 non-vxlan forwarding routed multicast decap
```

- Specify the qualifiers to match on.

```
(config-hw-tcam-profile-profile-feature-feature)#key field inner-dst-ip inner-ip-protocol inner-14-dst-port inner-14-src-port inner-ttl
```

- Set the key size limit to **160**.

```
(config-hw-tcam-profile-profile-feature-feature)#key size limit 160
```

```
(config-hw-tcam-profile-profile-feature-feature)#exit
```

It maybe necessary to disassociate some features which are not applicable to GRE encapsulated packets from the GRE TCAM program to make room for the **tunnel ipv4** feature.

Related Commands

- [system profile](#)
- [interface Tunnel](#)
- [show hardware tcam profile](#)

Example

14.2.1.6.39 passive-interface default (OSPFv2)

The **passive-interface default** command configures all interfaces as OSPFv2 passive by default. The switch advertises the passive interface as part of the router LSA.

The **passive-interface <interface> (OSPFv2)** configures the OSPFv2 active-passive status for a specific interface:

- When **passive-interface default** is not set, all interfaces are OSPFv2 active by default and passive interfaces are denoted by **passive-interface <interface>** statements in **running-config**.
- When **passive-interface default** is set, all interfaces are OSPFv2 passive by default and active interfaces are denoted by **no passive-interface <interface>** statements in **running-config**.

The **no passive-interface** and **default passive-interface** commands configures all interfaces as OSPFv2 active by default by removing the **passive-interface default** statement from **running-config**.

Command Mode

Router-OSPF Configuration

Command Syntax

```
passive-interface default
no passive-interface default
default passive-interface default
```

Examples

- This command configures the default interface setting as OSPFv2 passive. This command also removes all **passive-interface <interface>** statements from **running-config**.

```
switch(config)#router ospf 6
switch(config-router-ospf)#passive-interface default
switch(config-router-ospf)#
```

- This command configures the default interface setting as OSPFv2 active. This command also removes all **no passive-interface <interface>** statements from **running-config**.

```
switch(config-router-ospf)#no passive-interface default
switch(config-router-ospf)#
```

14.2.1.6.40 passive-interface <interface> (OSPFv2)

The **passive-interface** command disables OSPFv2 on an interface range. The switch advertises the passive interface as part of the LSA.

The default OSPFv2 interface activity is configured by the **passive-interface default (OSPFv2)** command:

- When **passive-interface default** is not set, all interfaces are OSPFv2 active by default and passive interfaces are denoted by **passive-interface <interface>** statements in *running-config*.
- When **passive-interface default** is set, all interfaces are OSPFv2 passive by default and active interfaces are denoted by **no passive-interface <interface>** statements in *running-config*.

The **no passive-interface** command enables OSPFv2 on the specified interface range. The **default passive-interface** command sets the interface to the default interface activity setting by removing the corresponding **passive-interface** or **no passive-interface** statement from *running-config*.

Command Mode

Router-OSPF Configuration

Command Syntax

```
passive-interface INTERFACE_NAME
no passive-interface INTERFACE_NAME
default passive-interface INTERFACE_NAME
```

Parameters

- INTERFACE_NAME Interface to be configured. Options include:
 - ethernet *e_range*
 - port-channel *p_range*
 - vlan *v_range*
 - vxlan *vx_range*

Examples

- These commands configure Ethernet interfaces 2 through 5 as passive interfaces.

```
switch(config)#router ospf 6
switch(config-router-ospf)#passive-interface ethernet 2-5
switch(config-router-ospf)#
```

- This command configures VLAN interfaces 50-54, 61, 68, and 102-120 as passive interfaces.

```
switch(config-router-ospf)#passive-interface vlan 50-54,61,68,102-120
switch(config-router-ospf)#
```

- This command configures VLAN 2 as an active interface.

```
switch(config-router-ospf)#no passive-interface vlan 2
switch(config-router-ospf)#
```

14.2.1.6.41 point-to-point routes (OSPFv2)

The **point-to-point routes** command enables the switch to maintain a local routing information base (RIB) to store information it learns from its neighbors.

The **no point-to-point routes** and **default point-to-point routes** commands program the switch to include point-to-point links in its RIB by removing the **point-to-point routes** command from running-config.

Command Mode

Router-OSPF Configuration

Command Syntax

```
point-to-point routes
```

```
no point-to-point routes
```

```
default point-to-point routes
```

Examples

- This command configures the switch to optimize the local RIB by not including point-to-point routes.

```
switch(config)#router ospf 6
switch(config-router-ospf)#no point-to-point routes
switch(config-router-ospf)#
```

- This command configures the switch to include point-to-point routes.

```
switch(config-router-ospf)#point-to-point routes
switch(config-router-ospf)#
```

14.2.1.6.42 redistribute (OSPFv2)

The **redistribute** command enables the advertising of all specified routes on the switch into the OSPFv2 domain as external routes.

The **no redistribute** and **default redistribute** commands remove the corresponding **redistribute** command from **running-config**, disabling route redistribution for the specified route type.

Command Mode

Router-OSPF Configuration

Command Syntax

```
redistribute ROUTE_TYPE [ROUTE_MAP]
```

```
no redistribute ROUTE_TYPE [ROUTE_MAP]
```

```
default redistribute ROUTE_TYPE [ROUTE_MAP]
```

Parameters

- ROUTE_TYPE Source from which routes are redistributed. Options include:
 - connected routes that are established when IPv4 is enabled on an interface.
 - BGP routes from a BGP domain.
 - RIP routes from a RIP domain.
 - static IP static routes.
- ROUTE_MAP Route map that determines the routes that are redistributed. Options include:
 - *<no parameter >*
 - *route-map map_name*

Examples

- The **redistribute static** command starts the advertising of static routes as OSPFv2 external routes.

```
switch(config)#router ospf 6  
switch(config-router-ospf)#redistribute static  
switch(config-router-ospf)#
```

- The **no redistribute bgp** command stops the advertising of BGP routes as OSPFv2 external routes.

```
switch(config-router-ospf)#no redistribute bgp  
switch(config-router-ospf)#
```

14.2.1.6.43 redistribute ospf

Redistributing connected routes causes the OSPFv2 instance to advertise all connected routes on the switch as external OSPFv2 routes. Connected routes are routes that are established when IPv4 is enabled on an interface.

Command Mode

```
config-router-bgp
```

Command Syntax

```
redistribute ospf [ include [ leaked ] | match [ external | internal | nssa-external ] | route-map  
word ]
```

```
no redistribute ospf [ match [ external | internal | nssa-external ]
```

```
default redistribute ospf [ match [ external | internal | nssa-external ]
```

Parameters

- **include** Include following routes while redistributing.
 - **leaked** Include leaked routes of this protocol while redistributing.
- **match** Routes learned by the OSPF protocol.
 - **external** OSPF routes learned from external sources.
 - **internal** OSPF routes learned from internal sources.
 - **nssa-external** OSPF routes learned from external NSSA sources.
- **route-map** Name a router map.
 - **word** Route map name.

Example

Use the following commands to redistribute OSPFv2 routes into the BGP domain.

```
switch(config)#router bgp 1  
switch(config-router-bgp)#redistribute OSPF  
switch(config-router-bgp)#
```

14.2.1.6.44 redistribute ospf instance

The **redistribute ospf instance** command redistributes either the non-leaked routes, or both leaked and non-leaked routes. The **exit** command returns the switch to global configuration mode.

Command Mode

Router-OSPF Configuration

Command Syntax

```
redistribute ospf instance [OPTIONS]
```

Parameters

- include Include leaked routes.
 - *leaked* OSPF leaked routes.
- match Routes learned by the OSPF protocol.
 - external OSPF routes learned from external sources.
 - internal OSPF routes learned from internal sources.
 - nssa-external OSPF routes learned from external NSSA sources

Examples

- This command redistributes the OSPFv2 external routes from all other OSPFv2 instances in the same VRF into the given instance.

```
switch(config-router-ospf)#redistribute ospf instance match external
```

- This command redistributes the OSPFv2 internal leaked and non-leaked routes from all other instances in all VRFs into the given instance.

```
switch(config-router-ospf)#redistribute ospf instance include leaked  
match internal
```

14.2.1.6.45 router ospf

The **router ospf** command places the switch in router-ospf configuration mode. The switch will create a process ID for the new instance if one does not already exist. The **exit** command returns the switch to global configuration mode.

The **show ip ospf** command displays the process ID of the OSPFv2 instances configured on the switch.

The **no router ospf** and **default router ospf** commands delete the specified OSPFv2 instance.

Router-ospf configuration mode is not a group change mode; **running-config** is changed immediately upon entering commands. Exiting router-ospf configuration mode does not affect **running-config**. The **exit** command returns the switch to global configuration mode.

Refer to Router-OSPFv2 Configuration Mode for a list of commands available in router-ospf configuration mode.

Command Mode

Global Configuration

Command Syntax

```
router ospf process_id [VRF_INSTANCE]
no router ospf process_id [VRF_INSTANCE]
default router ospf process_id [VRF_INSTANCE]
```

Parameters

- *process_id* OSPFv2 process ID. Values range from 1 to 65535.
- VRF_INSTANCE
 - *<no parameter>* Configures the default VRF instance.
 - *vrf vrf_name* Configures the *vrf_name* instance.

Examples

- This command creates an OSPFv2 instance with process ID 145 in the main VRF.

```
switch(config)#router ospf 145
switch(config-router-ospf)#
```

- This command deletes the specified OSPFv2 instance.

```
switch(config)#no router ospf 145
switch(config)#
```

14.2.1.6.46 router-id (OSPFv2)

The **router-id** command assigns a router ID for an OSPFv2 instance. This number uniquely identifies the router within an Autonomous System. Status commands use the router ID to identify the switch.

The switch sets the router ID to the first available alternative in the following list:

1. The **router-id** command.
2. The loopback IP address, if a loopback interface is configured on the switch.
3. The highest IP address present on the router.

 **Note:** When configuring VXLAN on an MLAG, always manually configure the OSPFv2 router ID to prevent the switch from using the common VTEP IP address as the router ID.

The **no router-id** and **default router-id** commands remove the router ID command from *running-config*; the switch uses the loopback or highest address as the router ID.

Command Mode

Router-OSPF Configuration

Command Syntax

```
router-id [identifier]
```

```
no router-id [identifier]
```

```
default router-id [identifier]
```

Parameters

identifier Value ranges from 0.0.0.0 to 255.255.255.255.

Example

This command assigns 10.5.4.2 as the router ID for the OSPFv2 instance.

```
switch(config)#router ospf 6  
switch(config-router-ospf)#router-id 10.5.4.2  
switch(config-router-ospf)#
```

14.2.1.6.47 show hardware tcam profile

Use the **show hardware tcam profile** command to verify that the user-defined-tcam profile is applied correctly without errors on the DCS-7020, DCS-7280R/R2, or DCS-7500R/R2 platforms.

This command is applicable the following platforms:

- DCS-7280E
- DCS-7280R
- DCS-7280R2
- DCS-7020R
- DCS-7500E
- DCS-7500R
- DCS-7500R2

Command Mode

EXEC

Command Syntax

```
show hardware tcam profile [profile] detail
```

Parameters

- **tcam** Specifies the TCAM information.
- **profile** *profile* Specifies the TCAM profile information.
- **detail** Displays detailed tcam profile information.

Example

This example displays the detailed tcam profile information for profile named **newprofile1**.

```
(config-hw-tcam)#show hardware tcam profile newprofile1 detail
Profile newprofile1 [ FixedSystem ]
Feature          mpls
-----
Key size         160
Actions          drop, redirect, set-ecn
Packet type      ipv4 mpls ipv4 forwarding mpls decap
                 ipv4 mpls ipv6 forwarding mpls decap
                 mpls ipv4 forwarding mpls
                 mpls ipv6 forwarding mpls
                 mpls non-ip forwarding mpls

Feature          acl vlan ipv6
-----
Key size         320
Key fields       dst-ipv6, ipv6-next-header, l4-dst-port, l4-src-port,
                 src-ipv6-high, src-ipv6-low, tcp-control
Actions          count, drop, mirror, redirect
Packet type      ipv6 forwarding routed
...
```

14.2.1.6.48 show ip ospf border-routers

The **show ip ospf border-routers** command displays the internal OSPFv2 routing table entries to area border routers (ABRs) and autonomous system boundary routers (ASBRs) for each of the OSPFv2 areas.

Command Mode

EXEC

Command Syntax

```
show ip ospf border-routers [VRF_INSTANCE]
```

Parameters

- VRF_INSTANCE Specifies the VRF instance.
 - *<no parameter>* displays information from all VRFs, or from context-active VRF if set.
 - *vrf vrf_name* displays information from the specified VRF.

Example

This command displays the ABRs and ASBRs.

```
switch#show ip ospf border-routers
OSPF Process 10.17.0.42, VRF default

Router ID      Area          Type
10.17.0.1      0.0.0.0      ASBR
switch>
```

14.2.1.6.49 show ip ospf database database-summary

The **show ip ospf database database-summary** command displays the number of link state advertisements in the OSPFv2 database.

Command Mode

EXEC

Command Syntax

```
show ip ospf [AREA] database database-summary [VRF_INSTANCE]
```

Parameters

- VRF_INSTANCE Specifies the VRF instance.
 - *<no parameter>* displays information from all VRFs, or from context-active VRF if set.
 - *vrf vrf_name* displays information from the specified VRF.
- AREA areas for which command displays data. Specifying an individual area requires entering the process ID where the area is located. Options include:
 - *<no parameter>*
 - *process_id*
 - *process_id area_id*
 - *process_id* input range: <1 to 65535>
 - *area_id* input range: <0 to 4294967295> or <0.0.0.0 to 255.255.255.255>

Example

This command displays the LSDB content summary for area 0.

```
switch#show ip ospf 1 0 database database-summary

LSA Type      Count
Router        18
Network       21
Summary Net   59
Summary ASBR  4
Type-7 Ext    0
Opaque Area   0
Type-5 Ext    4238
Opaque AS     0
Total         4340

switch>
```

14.2.1.6.50 show ip ospf database <link state list>

The **show ip ospf database <link state list>** command displays the OSPFv2 link state advertisements that originate on a specified switch.

Command Mode

EXEC

Command Syntax

```
show ip ospf [AREA] database [ROUTER] [VRF_INSTANCE]
```

Parameters

- AREA Areas for which command displays data. Specifying an individual area requires entering the process ID where the area is located. Options include:
 - *<no parameter>*
 - *process_id*
 - *process_id area_id*
 - *process_id* value ranges from 1 to 65535.
 - *area_id* is entered in decimal or dotted decimal notation.
- ROUTER Router or switch for which the command provides data. Options include:
 - *<no parameter>*
 - *adv-router [a.b.c.d]*
 - *self-originate*
- VRF_INSTANCE Specifies the VRF instance.
 - *<no parameter>* displays information from all VRFs, or from context-active VRF if set.
 - *vrf vrf_name* displays information from the specified VRF.

Example

This command displays OSPFv2 LSAs that originate at the router with a router ID of 10.26.0.31.

```
switch#show ip ospf database adv-router 10.26.0.31

OSPF Router with ID(10.26.0.23) (Process ID 1) (VRF default)

10.26.0.3110.26.0.319180x80002b4a0x13153

Type-5 AS External Link States

Link IDADV RouterAgeSeq#Checksum
10.24.238.23810.26.0.316780x800003d20x8acf0
10.24.238.24410.26.0.316780x800003d20x4e060
10.24.238.22410.26.0.316780x800003d20x17510
<-----OUTPUT OMITTED FROM EXAMPLE----->

Type 11 Opaque LSDB

TypeLink IDADV RouterAgeSeq# Checksum
switch>
```

14.2.1.6.51 show ip ospf database <link-state details>

The **show ip ospf database <link-state details>** command displays details of the specified link state advertisements.

Command Mode

EXEC

Command Syntax

```
show ip ospf [AREA] database LINKSTATE_TYPE linkstate_id [ROUTER] [VRF_INSTANCE]
```

Parameters

- AREA Areas for which command displays data. Specifying an individual area requires entering the process ID where the area is located. Options include:
 - <no parameter>
 - process_id
 - process_id area_id
 - process_id input range: <1 to 65535>
 - area_id input range: <0 to 4294967295> or <0.0.0.0 to 255.255.255.255>
- LINKSTATE_TYPE Link state types. Parameter options include:
 - detail Displays all link states.
 - router
 - network
 - summary
 - asbr-summary
 - external
 - nssa-external
 - opaque-link
 - opaque-area
 - opaque-as
- linkstate_id Network segment described by the LSA (dotted decimal notation).

Value depends on the LSA type.

- ROUTER Router or switch for which the command provides data. Options include:
 - <no parameter>
 - adv-router [a.b.c.d]
 - self-originate
- VRF_INSTANCE Parameter has no effect; this command displays information about the specified process and area regardless of VRF.
 - <no parameter> displays information from all VRFs, or from context-active VRF if set.
 - vrf vrf_name displays information from the specified VRF.

Examples

- This command displays the router link states contained in the area 2 LSDB.

```
switch#show ip ospf 1 2 database router
OSPF Router with ID(10.168.103.1) (Process ID 1) (VRF default)
Router Link States (Area 0.0.0.2)
LS age: 00:02:16
Options: (E DC)
```

```

LS Type: Router Links
Link State ID: 10.168.103.1
Advertising Router: 10.168.103.1
LS Seq Number: 80000032
Checksum: 0x1B60
Length: 36
Number of Links: 1

Link connected to: a Transit Network
(Link ID) Designated Router address: 10.168.2.1
(Link Data) Router Interface address: 10.168.2.1
Number of TOS metrics: 0
TOS 0 Metrics: 10

LS age: 00:02:12
Options: (E DC)
LS Type: Router Links
Link State ID: 10.168.104.2
Advertising Router: 10.168.104.2
LS Seq Number: 80000067
Checksum: 0xA29C
Length: 36
Number of Links: 1

Link connected to: a Transit Network
(Link ID) Designated Router address: 10.168.2.1
(Link Data) Router Interface address: 10.168.2.2
Number of TOS metrics: 0
TOS 0 Metrics: 10
switch>

```

- This command displays link state database (LSDB) contents for area 2.

```

switch#show ip ospf 1 2 database

OSPF Router with ID(10.168.103.1) (Process ID 1) (VRF default)

Router Link States (Area 0.0.0.2)

Link IDADV RouterAgeSeq#Checksum Link count
10.168.103.110.168.103.100:29:080x80000031 0x001D5F 1
10.168.104.210.168.104.200:29:090x80000066 0x00A49B 1

Net Link States (Area 0.0.0.2)

Link IDADV RouterAgeSeq#Checksum
10.168.2.110.168.103.100:29:080x80000001 0x00B89D

Summary Net Link States (Area 0.0.0.2)

Link IDADV RouterAgeSeq#Checksum
10.168.0.010.168.103.100:13:200x80000028 0x0008C8
10.168.0.010.168.104.200:09:160x80000054 0x00A2FF
10.168.3.010.168.104.200:24:160x80000004 0x00865F
10.168.3.010.168.103.100:24:200x80000004 0x002FC2
10.168.103.010.168.103.100:14:200x80000028 0x0096D2
10.168.103.010.168.104.200:13:160x80000004 0x00364B
10.168.104.010.168.104.200:08:160x80000055 0x002415
10.168.104.010.168.103.100:13:200x80000028 0x00EF6E
switch>

```

14.2.1.6.52 show ip ospf interface brief

The `show ip ospf interface brief` command displays a summary of OSPFv2 information.

Command Mode

EXEC

Command Syntax

```
show ip ospf [PROCESS_ID] interface brief [VRF_INSTANCE]
```

Parameters

- PROCESS_ID OSPFv2 process ID. Values include:
 - *<no parameter>*
 - *<1 to 65535>*
- VRF_INSTANCE Specifies the VRF instance.
 - *<no parameter>* displays information from all VRFs, or from context-active VRF if set.
 - *vrf vrf_name* displays information from the specified VRF.

Related Command

[show ip ospf interface](#)

Example

This command displays a summary of interface information for the switch.

```
switch#show ip ospf interface brief
InterfacePIDAreaIP AddressCostStateNbrs
Loopback010.0.0.010.168.103.1/2410DR0
Vlan110.0.0.010.168.0.1/2410BDR1
Vlan210.0.0.210.168.2.1/2410BDR1
Vlan310.0.0.310.168.3.1/2410DR0
switch>
```

14.2.1.6.53 show ip ospf interface

The **show ip ospf interface** command displays interface information that is related to OSPFv2.

Command Mode

EXEC

Command Syntax

```
show ip ospf [PROCESS_ID] interface [INTERFACE_NAME][VRF_INSTANCE]
```

Parameters

- PROCESS_ID OSPFv2 process ID. Values include:
 - *<no parameter>*
 - *<1 to 65535>*
- INTERFACE_NAME Interface type and number. Values include
 - *<no parameter>*
 - ethernet *e_num*
 - loopback *l_num*
 - port-channel *p_num*
 - vlan *v_num*
- VRF_INSTANCE Specifies the VRF instance.
 - *<no parameter>* displays information from all VRFs, or from context-active VRF if set.
 - *vrf vrf_name* displays information from the specified VRF.

Related Command

[show ip ospf interface brief](#)

Example

This command displays complete OSPFv2 information for VLAN 1.

```
switch#show ip ospf interface vlan 1
Vlan1 is up, line protocol is up (connected)
Internet Address 10.168.0.1/24, VRF default, Area 0.0.0.0
Process ID 1, Router ID 10.168.103.1, Network Type BROADCAST, Cost: 10
Transmit Delay is 1 sec, State BDR, Priority 1
Designated Router is 10.168.104.2
Backup Designated router is 10.168.103.1
Timer intervals configured, Hello 10, Dead 40, Retransmit 5
Neighbor Count is 1
MTU is 1500
switch>
```

14.2.1.6.54 show ip ospf lsa-log

The `show ip ospf lsa-log` command displays log entries when LSA update messages are sent or received for OSPF.

Command Mode

EXEC

Command Syntax

```
show ip ospf [PROCESS_ID] ospf-log
```

Parameters

- PROCESS_ID OSPFv2 process ID. Values include:
 - *<no parameter>*
 - *<1 to 65535>*

Example

This command displays log entries when LSA update messages are sent or received for OSPF.

```
switch#show ip ospf lsa-log
OSPF Process 3.3.3.3, LSA Throttling Log:
[04:21:09] type 1: 3.3.3.3/32 [3.3.3.3], event 1, backed off, new hold
value 2000 msec
[04:21:08] type 1: 3.3.3.3/32 [3.3.3.3], event 2, backoff restarted, new
hold value 900 msec
[04:21:00] type 1: 3.3.3.3/32 [3.3.3.3], event 1, backed off, new hold
value 3000 msec
[04:21:00] type 1: 3.3.3.3/32 [3.3.3.3], event 4, maxwait value changed,
new hold value 3000 msec
/* Here the maxwait value was changed to 3000 from earlier 32000, this is
not part of the log */
[04:20:42] type 1: 3.3.3.3/32 [3.3.3.3], event 1, backed off, new hold
value 32000 msec
[04:20:10] type 1: 3.3.3.3/32 [3.3.3.3], event 1, backed off, new hold
value 32000 msec
[04:19:54] type 1: 3.3.3.3/32 [3.3.3.3], event 1, backed off, new hold
value 16000 msec
[04:19:46] type 1: 3.3.3.3/32 [3.3.3.3], event 1, backed off, new hold
value 8000 msec
[04:19:42] type 1: 3.3.3.3/32 [3.3.3.3], event 1, backed off, new hold
value 4000 msec
[04:19:40] type 1: 3.3.3.3/32 [3.3.3.3], event 1, backed off, new hold
value 2000 msec
[04:19:39] type 1: 3.3.3.3/32 [3.3.3.3], event 2, backoff restarted, new
hold value 900 msec
[04:19:22] type 1: 4.4.4.4/32 [4.4.4.4], event 3, discarded, was early by
995 msec
[04:19:22] type 1: 3.3.3.3/32 [3.3.3.3], event 0, backoff started, new
hold value 1000 msec
switch#
```

14.2.1.6.55 show ip ospf neighbor adjacency-changes

The **show ip ospf neighbor adjacency-changes** command displays the OSPFv2 neighbor adjacency change log for specified interfaces.

Command Mode

EXEC

Command Syntax

```
show ip ospf neighbor [INTERFACE_NAME][NEIGHBOR] adjacency-changes  
[VRF_INSTANCE]
```

Parameters

- INTERFACE_NAME Interface type and number. Values include:
 - *<no parameter>*
 - ethernet *e_num*
 - loopback *l_num*
 - port-channel *p_num*
 - vlan *v_num*
- NEIGHBOR OSPFv2 neighbor. Options include:
 - *<no parameter>*
 - *ipv4_addr*
 - *host_name*
- VRF_INSTANCE Specifies the VRF instance.
 - *<no parameter>* displays information from all VRFs, or from context-active VRF if set.
 - *vrf vrf_name* displays information from the specified VRF.

Example

This command displays the adjacency changes to VLAN 2.

```
switch#show ip ospf neighbor vlan 2 adjacency-changes  
[08-04 08:55:32] 10.168.104.2, interface Vlan2 adjacency established  
[08-04 09:58:51] 10.168.104.2, interface Vlan2 adjacency dropped:  
  interface went  
down  
[08-04 09:58:58] 10.168.104.2, interface Vlan2 adjacency established  
[08-04 09:59:34] 10.168.104.2, interface Vlan2 adjacency dropped:  
  interface went  
down  
[08-04 09:59:42] 10.168.104.2, interface Vlan2 adjacency established  
[08-04 10:01:40] 10.168.104.2, interface Vlan2 adjacency dropped: nbr did  
  not  
list our router ID  
[08-04 10:01:46] 10.168.104.2, interface Vlan2 adjacency established  
switch>
```

14.2.1.6.56 show ip ospf neighbor state

The `show ip ospf neighbor state` command displays the state information on OSPF neighbors on a per-interface basis.

Command Mode

EXEC

Command Syntax

```
show ip ospf neighbor state STATE_NAME [VRF_INSTANCE]
```

Parameters

- STATE_NAME Output filtered by the devices OSPF state. Options include valid OSPF states:
 - 2-ways
 - attempt
 - down
 - exch-start
 - exchange
 - full
 - graceful-restart
 - init
 - loading
- VRF_INSTANCE Specifies the VRF instance.
 - *<no parameter>* displays information from all VRFs, or from context-active VRF if set.
 - *vrf vrf_name* displays information from the specified VRF.

Example

This command displays OSPF information for neighboring routers that are fully adjacent.

```
switch#show ip ospf neighbor state full
Neighbor ID   VRF      Pri   State          Dead Time   Address      Interface
Test1         default  1     FULL/BDR       00:00:35   10.17.254.105  Vlan3912
Test2         default  1     FULL/BDR       00:00:36   10.17.254.29  Vlan3910
Test3         default  1     FULL/DR        00:00:35   10.25.0.1     Vlan101
Test4         default  1     FULL/DROTHER   00:00:36   10.17.254.67  Vlan3908
Test5         default  1     FULL/DROTHER   00:00:36   10.17.254.68  Vlan3908
Test6         default  1     FULL/BDR       00:00:32   10.17.254.66  Vlan3908
Test7         default  1     FULL/DROTHER   00:00:34   10.17.36.4    Vlan3036
Test8         default  1     FULL/BDR       00:00:35   10.17.36.3    Vlan3036
Test9         default  1     FULL/DROTHER   00:00:31   10.17.254.13  Vlan3902
Test10        default  1     FULL/BDR       00:00:37   10.17.254.11  Vlan3902
Test11        default  1     FULL/DROTHER   00:00:33   10.17.254.163 Vlan3925
Test12        default  1     FULL/DR        00:00:37   10.17.254.161 Vlan3925
Test13        default  1     FULL/DROTHER   00:00:31   10.17.254.154 Vlan3923
Test14        default  1     FULL/BDR       00:00:39   10.17.254.156 Vlan3923
Test15        default  1     FULL/DROTHER   00:00:33   10.17.254.35  Vlan3911
Test16        default  1     FULL/DR        00:00:34   10.17.254.33  Vlan3911
Test17        default  1     FULL/DR        00:00:36   10.17.254.138 Ethernet12
Test18        default  1     FULL/DR        00:00:37   10.17.254.2   Vlan3901
switch>
```

14.2.1.6.57 show ip ospf neighbor summary

The **show ip ospf neighbor summary** command displays a single line of summary information for each OSPFv2 neighbor.

Command Mode

EXEC

Command Syntax

```
show ip ospf [PROCESS_ID] neighbor summary [VRF_INSTANCE]
```

Parameters

- PROCESS_ID OSPFv2 process ID. Values include:
 - *<no parameter>*
 - *<1 to 65535>*
- VRF_INSTANCE Specifies the VRF instance.
 - *<no parameter>* displays information from all VRFs, or from context-active VRF if set.
 - *vrf vrf_name* displays information from the specified VRF.

Example

This command displays the summary information for the OSPFv2 neighbors.

```
switch#show ip ospf neighbor summary
OSPF Router with (Process ID 1) (VRF default)
0 neighbors are in state DOWN
0 neighbors are in state GRACEFUL RESTART
2 neighbors are in state INIT
0 neighbors are in state LOADING
0 neighbors are in state ATTEMPT
18 neighbors are in state FULL
0 neighbors are in state EXCHANGE
0 neighbors are in state 2 WAYS
0 neighbors are in state EXCH START
switch>
```

14.2.1.6.58 show ip ospf neighbor

The **show ip ospf neighbor** command displays OSPFv2 neighbor information for specified interfaces.

Command Mode

EXEC

Command Syntax

```
show ip ospf [PROCESS_ID] neighbor [INTERFACE_NAME] [NEIGHBOR] [DATA]
[VRF_INSTANCE]
```

Parameters

- PROCESS_ID OSPFv2 process ID. Values include:
 - *<no parameter>*
 - *<1 to 65535>*
- INTERFACE_NAME Interface type and number. Values include:
 - *<no parameter>*
 - ethernet *e_num*
 - loopback *l_num*
 - port-channel *p_num*
 - vlan *v_num*
- NEIGHBOR OSPFv2 neighbor. Options include:
 - *<no parameter>*
 - *ipv4_addr*
- DATA Type of information the command displays. Values include:
 - *<no parameter>*
 - detail
- VRF_INSTANCE Specifies the VRF instance.
 - *<no parameter>* displays information from all VRFs, or from context-active VRF if set.
 - *vrf vrf_name* displays information from the specified VRF.

Examples

- This command displays the switches neighbors.

```
switch#show ip ospf neighbor
Neighbor IDVRFPriStateDead TimeAddressInterface
10.168.104.2default1FULL/DR00:00:3510.168.0.2Vlan1
10.168.104.2default8FULL/BDR00:00:3110.168.2.2Vlan2
switch>
```

- This command displays details about the neighbors to VLAN 2.

```
switch#show ip ospf neighbor vlan 2 detail
Neighbor 10.168.104.2, VRF default, interface address 10.168.2.2
In the area 0.0.0.2 via interface Vlan2
Neighbor priority is 8, State is FULL, 13 state changes
Adjacency was established 00:01:25:48 ago
DR is 10.168.2.1 BDR is 10.168.2.2
Options is E
Dead timer due in 00:00:34
switch>
```

14.2.1.6.59 show ip ospf request queue

The **show ip ospf request queue** command displays a list of all OSPFv2 link state advertisements (LSAs) requested by a router.

Command Mode

EXEC

Command Syntax

```
show ip ospf request queue [VRF_INSTANCE]
```

Parameters

VRF_INSTANCE Specifies the VRF instance.

- *<no parameter>* displays information from all VRFs, or from context-active VRF if set.
- *vrf vrf_name* displays information from the specified VRF.

Example

This command displays an LSA request list.

```
switch#show ip ospf request queue
Neighbor 10.168.104.2 vrf default interface: 10.168.0.2 address vlan1
Type LS ID ADV RTR Seq No Age Checksum
Neighbor 10.168.104.2 vrf default interface: 10.168.2.2 address vlan2
Type LS ID ADV RTR Seq No Age Checksum
switch>
```

14.2.1.6.60 show ip ospf retransmission queue

The **show ip ospf retransmission queue** command displays a list of all OSPFv2 link state advertisements (LSAs) waiting to be re-sent.

Command Mode

EXEC

Command Syntax

```
show ip ospf retransmission queue [VRF_INSTANCE]
```

Parameters

- VRF_INSTANCE Specifies the VRF instance.
 - *<no parameter>* displays information from all VRFs, or from context-active VRF if set.
 - *vrf vrf_name* displays information from the specified VRF.

Example

This command displays an empty retransmission list.

```
switch#show ip ospf retransmission queue
Neighbor 10.168.104.2 vrf default interface vlan1 address 10.168.0.2
LSA retransmission not currently scheduled. Queue length is 0

TypeLink IDADV RouterAgeSeq# Checksum
Neighbor 10.168.104.2 vrf default interface vlan2 address 10.168.2.2
LSA retransmission not currently scheduled. Queue length is 0

TypeLink IDADV RouterAgeSeq# Checksum
switch>
```

14.2.1.6.61 show ip ospf spf-log

The `show ip ospf spf-log` command displays when and how long the switch took to run a full SPF calculation for OSPF.

Command Mode

EXEC

Command Syntax

```
show ip ospf [PROCESS_ID] ospf-log
```

Parameters

- PROCESS_ID OSPFv2 process ID. Values include:
 - *<no parameter>*
 - **<1 to 65535>**

Example

This command displays the SPF information for OSPF.

```
switch#show ip ospf spf-log
OSPF Process 172.26.0.22
When      Duration(msec)
13:01:34  1.482
13:01:29  1.547
13:01:24  1.893
13:00:50  1.459
13:00:45  1.473
13:00:40  2.603
11:01:49  1.561
11:01:40  1.463
11:01:35  1.467
11:01:30  1.434
11:00:54  1.456
11:00:49  1.472
11:00:44  1.582
15:01:49  1.575
15:01:44  1.470
15:01:39  1.679
15:01:34  1.601
15:00:57  1.454
15:00:52  1.446
15:00:47  1.603
switch>
```

14.2.1.6.62 show ip ospf

The `show ip ospf` command displays OSPFv2 routing information

Command Mode

EXEC

Command Syntax

```
show ip ospf [PROCESS_ID][VRF_INSTANCE]
```

Parameters

- PROCESS_ID OSPFv2 process ID. Values include:
 - `<no parameter>`
 - `<1 to 65535>`
- VRF_INSTANCE Specifies the VRF instance.
 - `<no parameter>` configures the default VRF instance.
 - `vrf vrf_name` configures the `vrf_name` instance.

Example

This command displays configuration parameters, operational statistics, status of the OSPFv2 instance, and a brief description of the areas on the switch.

```
switch#show ip ospf
Routing Process "ospf 1" with ID 10.168.103.1 VRF default
Supports opaque LSA
Maximum number of LSA allowed 12000
Threshold for warning message 75%
Ignore-time 5 minutes, reset-time 5 minutes
Ignore-count allowed 5, current 0
It is an area border router
Hold time between two consecutive SPFs 5000 msec
SPF algorithm last executed 00:00:09 ago
Minimum LSA interval 5 secs
Minimum LSA arrival 1000 msec
Number of external LSA 0. Checksum Sum 0x000000
Number of opaque AS LSA 0. Checksum Sum 0x000000
Number of LSA 27.
Number of areas in this router is 3. 3 normal 0 stub 0 nssa
Area BACKBONE(0.0.0.0)
Number of interfaces in this area is 2
It is a normal area
Area has no authentication
SPF algorithm executed 153 times
Number of LSA 8. Checksum Sum 0x03e13a
Number of opaque link LSA 0. Checksum Sum 0x000000
Area 0.0.0.2
Number of interfaces in this area is 1
It is a normal area
Area has no authentication
SPF algorithm executed 153 times
Number of LSA 11. Checksum Sum 0x054e57
Number of opaque link LSA 0. Checksum Sum 0x000000
Area 0.0.0.3
Number of interfaces in this area is 1
It is a normal area
Area has no authentication
SPF algorithm executed 5 times
Number of LSA 6. Checksum Sum 0x02a401
Number of opaque link LSA 0. Checksum Sum 0x000000
```

14.2.1.6.63 show line system dom thresholds

The **show line system [port RANGE] dom thresholds** command reports DOM information reported by the OSFP-LS module. This includes standard fields such as temperature and voltage. In addition to standard DOM fields, the OSFP-LS also monitors the laser temperature for each of its amplifiers. The reported RX power reflects the total RX power seen on that path. TX bias current monitoring is not supported on these modules and should be ignored.

Command Mode

EXEC

Command Syntax

```
show line system [port RANGE] dom thresholds]
```

Example

This command displays the DOM information reported by the OSFP-LS module.

```
switch# show line system port 10 dom thresholds
Ch: Channel, mA: milliamperes, dBm: decibels (milliwatts),
C: Celsius, V: Volts, NA or N/A: not applicable.

Port 10
Last update: 0:00:04 ago
```

Warn	Low Alarm	Value	High Alarm Threshold	High Warn Threshold	Low
Temperature		32.83	70.00	65.00	
0.00	-5.00	C			
Voltage		3.29	3.47	3.37	
3.23	3.14	V			
Booster					
TX bias current		N/A	N/A	N/A	
N/A	N/A	mA			
Optical TX power (line)		-3.58	7.96	7.50	
-9.03	-15.06	dBm			
Optical RX power (local)		-28.24	-16.23	-17.26	
-30.00	-33.01	dBm			
Laser Temperature		43.55	80.00	75.00	
-5.00	-10.00	C			
Pre-amp					
TX bias current		N/A	N/A	N/A	
N/A	N/A	mA			
Optical TX power (local)		-3.38	7.96	7.50	
-9.03	-15.06	dBm			
Optical RX power (line)		-15.42	5.77	4.77	
-28.24	-30.97	dBm			
Laser Temperature		43.54	80.00	75.00	
-5.00	-10.00	C			

14.2.1.6.64 show line system status

The **show line system [port RANGE] status** command displays module status. The OSFP-LS is compliant to the Common Management Interface Specification (CMIS), and implements various CMIS-defined status flags. Data path 1 reflects the outgoing booster path and data path 2 reflects the incoming pre-amp path.

Command Mode

EXEC

Command Syntax

```
show line system [port RANGE] status
```

Example

This command displays the displays module status.

```
switch(config-ls-port10,19)#show line system status
Current State      Changes      Last
Change            -----      -
-----
Port 10
  Transceiver      AMP-ZR      3
0:23:03 ago
  Transceiver SN   XDG203505010
  Presence         present
  Adapters         none
  Bad EEPROM checksums 0      never
  Resets          0
0:23:08 ago
  Interrupts      0      never
  Data path firmware fault ok      0      never
  Module firmware fault ok      0      never
  Temperature high alarm ok      0      never
  Temperature high warn ok      0      never
  Temperature low alarm ok      0      never
  Temperature low warn ok      0      never
  Voltage high alarm ok      0      never
  Voltage high warn ok      0      never
  Voltage low alarm ok      0      never
  Voltage low warn ok      0      never
  Module state    ready      2
0:22:59 ago
  Data path 1 state initialized 12
0:16:35 ago
  Data path 2 state initialized 12
0:16:35 ago
  Data path 3 state unknown      0      never
  Data path 4 state unknown      0      never
  Data path 5 state unknown      0      never
  Data path 6 state unknown      0      never
  Data path 7 state unknown      0      never
  Data path 8 state unknown      0      never
Booster
  Operational speed 400Gbps
  RX LOS            ok      0      never
  TX fault         ok      0      never
  RX CDR LOL       ok      0      never
  TX power high alarm ok      0      never
  TX power high warn ok      0      never
  TX power low alarm alarm      3
0:16:37 ago
```

TX power low warn	warn	3	
0:16:37 ago			
TX bias high alarm	ok	0	never
TX bias high warn	ok	0	never
TX bias low alarm	ok	0	never
TX bias low warn	ok	0	never
RX power high alarm	ok	0	never
RX power high warn	ok	0	never
RX power low alarm	ok	2	
0:16:35 ago			
RX power low warn	ok	2	
0:16:35 ago			
TX LOS			
Host lane 1	ok	0	never
Host lane 2	ok	0	never
Host lane 3	ok	0	never
Host lane 4	ok	0	never
Host lane 5	ok	0	never
Host lane 6	ok	0	never
Host lane 7	ok	0	never
Host lane 8	ok	0	never
TX CDR LOL			
Host lane 1	ok	0	never
Host lane 2	ok	0	never
Host lane 3	ok	0	never
Host lane 4	ok	0	never
Host lane 5	ok	0	never
Host lane 6	ok	0	never
Host lane 7	ok	0	never
Host lane 8	ok	0	never
TX adaptive input EQ fault			
Host lane 1	ok	0	never
Host lane 2	ok	0	never
Host lane 3	ok	0	never
Host lane 4	ok	0	never
Host lane 5	ok	0	never
Host lane 6	ok	0	never
Host lane 7	ok	0	never
Host lane 8	ok	0	never
Pre-amp			
Operational speed	50Gbps		
RX LOS	ok	0	never
TX fault	ok	0	never
RX CDR LOL	ok	0	never
TX power high alarm	ok	0	never
TX power high warn	ok	0	never
TX power low alarm	alarm	3	
0:16:37 ago			
TX power low warn	warn	3	
0:16:37 ago			
TX bias high alarm	ok	0	never
TX bias high warn	ok	0	never
TX bias low alarm	ok	0	never
TX bias low warn	ok	0	never
RX power high alarm	ok	0	never
RX power high warn	ok	0	never
RX power low alarm	ok	2	
0:16:35 ago			
RX power low warn	ok	2	
0:16:35 ago			

Some lines of output do not apply to the OSFP-LS modules (**For example, Operational speed, RX CDR LOL**). These lines of output should be ignored. The fields of interest are Module state, **Data path**

1 state, and Data path 2 state. Under normal operating conditions, **Module state** will read ready and the **Data path state** fields will read either **initialized or activated**. Initialized means that the module is ready to operate but is receiving no signal to amplify. Activated means that the amplifier is active.

14.2.1.6.65 shutdown (OSPFv2)

The **shutdown** command disables OSPFv2 on the switch. OSPFv2 is disabled on individual interfaces with the **shutdown (OSPFv2)** command.

The **no shutdown** and **default shutdown** commands enable the OSPFv2 instance by removing the **shutdown** statement from the OSPF block in *running-config*.

Command Mode

Router-OSPF Configuration

Command Syntax

```
shutdown
```

```
no shutdown
```

```
default shutdown
```

Examples

- This command disables OSPFv2 activity on the switch.

```
switch(config)#router ospf 6  
switch(config-router-ospf)#shutdown  
switch(config-router-ospf)#
```

- This command resumes OSPFv2 activity on the switch.

```
switch(config-router-ospf)#no shutdown  
switch(config-router-ospf)#
```

14.2.1.6.66 summary-address

The **summary-address** command allows aggregation of external routes advertised by an OSPF ASBR. It is used to aggregate AS External and NSSA External LSAs.

The **default summary-address** and **no summary-address** commands delete the current **summary-address** configurations.

Command Mode

Router Configuration Mode

Command Syntax

```
summary-address {ip_address subnet_mask | ip_prefix} [attribute_map WORD | not_advertise | tag]
```

```
default summary-address {ip_address summary_mask | ip_prefix}
```

```
no summary-address {ip_address summary_mask | ip_prefix}
```

Parameters

- *ip_address subnet_mask* IPv4 subnet in dotted decimal notation.
- *ip_prefix* IPv4 subnet in CIDR notation.
- *attribute_map WORD* allows using a route-map to set the attributes to be advertised in the LSA. Options include:
 - set metric
 - set metric-type
 - set tag
- *not_advertise* suppresses the advertisement of contributing external prefixes by the router
- *tag* allows setting the tag in the advertised external LSA. The tag value ranges from 0 to 4294967295. The default value is zero.

Guidelines

This feature reduces the size of External LSDB in OSPF, does not impact inter area and intra area LSAs. This command installs a Null0 route in FIB when at least one contributor is present.

Restriction

Only OSPF redistributed routes are aggregated.

Example

This command advertises an external LSA for 50.0.0.0/16 prefix if at least one BGP contributing route is present which falls in the subnet 50.0.0.0/16.

 **Note:** The **show** commands display aggregation of BGP prefixes 50.0.0.0/24 and 50.0.1.0/24 into one OSPF AS External LSA for 50.0.0.0/16 prefix. A route-map is to set metric and tag for the advertised LSA.

```
switch(config)#router ospf 5
switch(config-router-ospf)#redistribute bgp
switch(config-router-ospf)#summary-address 50.0.0.0/16 attribute-map
BGP_AGGR
switch(config-router-ospf)#exit
switch(config)#show ip route bgp

VRF: default
Codes: C - connected, S - static, K - kernel,
       O - OSPF, IA - OSPF inter area, E1 - OSPF external type 1,
       E2 - OSPF external type 2, N1 - OSPF NSSA external type 1,
       N2 - OSPF NSSA external type2, B I - iBGP, B E - eBGP,
       R - RIP, I L1 - IS-IS level 1, I L2 - IS-IS level 2,
```

```

O3 - OSPFv3, A B - BGP Aggregate, A O - OSPF Summary,
NG - Nexthop Group Static Route, V - VXLAN Control Service,
DH - DHCP client installed default route, M - Martian,
DP - Dynamic Policy Route

B E    50.0.0.0/24 [200/0] via 3.0.0.12, Ethernet3
B E    50.0.1.0/24 [200/0] via 3.0.0.12, Ethernet3
switch(config)#show running-config
...
route-map BGP_AGGR permit 10
    set metric 42
    set tag 19
...
router ospf 1
    router-id 1.0.0.10
    redistribute bgp
    max-lsa 12000
    summary-address 50.0.0.0/16 attribute-map BGP_AGGR

switch(config)#show ip ospf database external

                OSPF Router with ID(1.0.0.10) (Process ID 1) (VRF
default)

                Type-5 AS External Link States

LS Age: 9
Options: (E DC)
LS Type: AS External Links
Link State ID: 50.0.0.0
Advertising Router: 1.0.0.10
LS Seq Number: 0x80000001
Checksum: 0x2c0c
Length: 36
Network Mask: 255.255.0.0
    Metric Type: 2
    Metric: 42
    Forwarding Address: 0.0.0.0
    External Route Tag: 19

switch(config)#show ip route aggregate

VRF: default
Codes: C - connected, S - static, K - kernel,
O - OSPF, IA - OSPF inter area, E1 - OSPF external type 1,
E2 - OSPF external type 2, N1 - OSPF NSSA external type 1,
N2 - OSPF NSSA external type2, B I - iBGP, B E - eBGP,
R - RIP, I L1 - IS-IS level 1, I L2 - IS-IS level 2,
O3 - OSPFv3, A B - BGP Aggregate, A O - OSPF Summary,
NG - Nexthop Group Static Route, V - VXLAN Control Service,
DH - DHCP client installed default route, M - Martian,
DP - Dynamic Policy Route

A O    50.0.0.0/16 is directly connected, Null0

```

14.2.1.6.67 system profile

Use the **system profile** command to apply the user defined TCAM profile to the system.

Command Mode

hardware tcam mode

Command Syntax

```
system profile profilename
```

Parameters

profilename Name of the selected system profile.

Example

```
(config-hw-tcam) #system profile profilename
```

14.2.1.6.68 timers lsa rx min interval (OSPFv2)

The `timers lsa rx min interval` command sets the minimum interval for acceptance of identical link-state advertisements (LSAs) from OSPFv2 neighbors.

The `no timers lsa rx min interval` and `default timers lsa rx min interval` commands restore the minimum interval to the default of one second by removing the `timers lsa rx min interval` command from *running-config*.

Command Mode

Router-OSPF Configuration

Command Syntax

```
timers lsa rx min interval lsa_time
no timers lsa rx min interval
default timers lsa rx min interval
```

Parameter

lsa_time Minimum time (in milliseconds) after which the switch will accept an identical LSA from OSPFv2 neighbors. Default is 1000 (1 second).

Example

This command sets the minimum LSA arrival interval to ten milliseconds.

```
switch(config)#router ospf 6
switch(config-router-ospf)#timers lsa rx min interval 10
switch(config-router-ospf)#
```

14.2.1.6.69 timers lsa tx delay initial (OSPFv2)

The `timers lsa tx delay initial` command sets the rate-limiting values for OSPF link-state advertisement generation.

The `no timers lsa tx delay initial` and `default timers throttle lsa all` commands restore the defaults by removing the `timers lsa tx delay initial` command from *running-config*.

Command Mode

Router-OSPF Configuration

Command Syntax

```
timers lsa tx delay initial initial_delay min_hold max_wait
```

```
no timers lsa tx delay initial
```

```
default timers lsa tx delay initial
```

Parameters

- *initial_delay* Value ranges from 0 to 600000 (ms). Default is 1000.
- *min_hold* Value ranges from 0 to 600000 (ms). Default is 5000.
- *max_wait* Value ranges from 0 to 600000 (ms). Default is 5000.

Example

This command sets the rate-limiting values for OSPF link-state advertisements to 10 milliseconds.

```
switch(config) #router ospf 6  
switch(config-router-ospf) #timers lsa tx delay initial 10  
switch(config-router-ospf) #
```

14.2.1.6.70 timers spf delay initial (OSPFv2)

The purpose of SPF throttling is to delay shortest path first (SPF) calculations when network topology is changing rapidly. The `timers spf delay initial` command controls the intervals at which the switch will perform SPF calculations. The command sets three values:

- **Initial delay:** how long the switch waits to perform an SPF calculation after a topology change in a network that has been stable throughout the hold interval. Because a topology change often causes several link state updates to be sent, the initial delay is configured to allow the network to settle before the switch performs an SPF calculation. If an additional topology change occurs during the initial interval, the SPF calculation still takes place after the expiration of the initial delay period and no other change is made to the throttle timers.
- **Hold interval:** this is an additional wait timer which scales to slow SPF calculations during periods of network instability. If a network change occurs during the hold period, an SPF calculation is scheduled to occur at the expiration of the hold interval. Subsequent hold intervals are doubled if further topology changes occur during a hold interval until either the hold interval reaches its configured maximum or no topology change occurs during the interval. If the next topology change occurs after the expiration of the hold interval, the hold interval is reset to its configured value and the SPF calculation is scheduled to take place after the initial delay.
- **Maximum interval:** the maximum time the switch will wait after a topology change before performing an SPF calculation.

The `no timers spf delay initial` and `default timers spf delay initial` commands restore the default OSPFv2 SPF calculation intervals by removing the `timers spf delay initial` command from *running-config*.

Command Mode

Router-OSPF Configuration

Command Syntax

```
timers spf delay initial initial_delay hold_interval max_interval
no timers spf
default timers spf
```

Parameters

- *initial_delay* Initial delay between a topology change and SPF calculation. Value ranges from 0 to 65535000 (ms). Default is 0 (ms).
- *hold_interval* Additional wait time after SPF calculation to allow the network to settle. If a topology change occurs during the hold interval, another SPF calculation is scheduled to occur after the hold interval expires. The next hold interval is doubled if topology changes occur during the hold interval. If doubling exceeds the maximum value, the maximum value is used instead. Value ranges from 0 to 65535000 (ms). Default is 5000 (ms).
- *max_interval* Maximum hold interval before the switch will perform an SPF calculation. Value ranges from 0 to 65535000 (ms). Default is 5000 (ms).

Example

These commands set the SPF timers on the switch.

```
switch(config)#router ospf 6
switch(config-router-ospf)#timers spf 5 100 20000
switch(config-router-ospf)#
```

14.2.1.6.71 tunnel routes

Use the **tunnel routes** command or the **default** form of the command to enable OSPFv2 routes over GRE tunnels. The tunnel routes are enabled, by default. Use the **no** form of the command to disable the tunnel routes.

Command Mode

Router OSPF configuration (config-router-ospf)

Command Syntax

```
tunnel routes
```

```
no tunnel routes
```

```
default tunnel routes
```

Examples

- To enable OSPFv2 routes over GRE Tunnels.

```
switch(config)#router ospf 6  
switch(config-router-ospf)#tunnel routes  
switch(config-router-ospf)#
```

- To disable OSPFv2 routes over GRE Tunnels.

```
switch(config)#router ospf 6  
switch(config-router-ospf)#no tunnel routes  
switch(config-router-ospf)#
```

- To enable the default OSPFv2 routes over GRE Tunnels.

```
switch(config)#router ospf 6  
switch(config-router-ospf)#default tunnel routes  
switch(config-router-ospf)#
```

14.3 Open Shortest Path First – Version 3

Open Shortest Path First (OSPF) is a link-state routing protocol that operates within a single autonomous system. OSPF version 3 is defined by RFC 5340.

This chapter contains the following sections.

- [OSPFv3 Introduction](#)
- [OSPFv3 Conceptual Overview](#)
- [Configuring OSPFv3](#)
- [OSPFv3 Configuration Examples](#)
- [OSPFv3 Commands](#)

14.3.1 OSPFv3 Introduction

OSPFv3 is based on OSPF version 2 and includes enhancements that utilize IPv6 features. However, OSPFv3 is configured and operates independently of any implementation of OSPFv2 on the switch. OSPFv2 features that OSPFv3 implements include:

- Packet types
- Neighbor discovery and adjacency formation mechanisms
- LSA aging and flooding
- SPF calculations

- DR election procedure
- Multiple area support
- Router-ID (32 bits)

The following list describes the OSPFv3 differences and enhancements from OSPFv2:

- IPv6 128-bit addresses
- Use of link-local addresses
- OSPFv3 runs over links instead of subnets
- Support flood pacing

Arista switches support the following OSPFv3 functions:

- A single OSPFv3 instance for each VRF
- Intra- and inter-area routing
- Type 1 and 2 external routing
- Broadcast and P2P interfaces
- Stub areas
- Redistribution of static and connected routes into OSPFv3

14.3.2 OSPFv3 Conceptual Overview

This section contains the following topics:

- [Storing Link States](#)
- [Topology](#)
- [Link Updates](#)
- [OSPFv3 Security](#)
- [Flood Pacing](#)

14.3.2.1 Storing Link States

OSPFv3 is a dynamic, link-state routing protocol, where links represent routable paths. Dynamic routing protocols calculate the most efficient path between locations based on bandwidth and device status.

A link state advertisement (LSA) is an OSPFv3 packet that communicates a router's topology to other routers. The link state database (LSDB) stores an area's topology database and is composed of LSAs received from other routers. Routers update the LSDB by storing LSAs from other routers.

14.3.2.2 Topology

An autonomous system (AS) is the IP domain within which a dynamic protocol controls the routing of traffic. In OSPFv3, an AS is composed of areas, which define the LSDB computation boundaries. All routers in an area store identical LSDBs. Routers in different areas exchange updates without storing the entire database, reducing information maintenance on large, dynamic networks.

An AS shares internal routing information from its areas and external routing information from other processes to inform routers outside the AS about routes the network can access. Routers that advertise routes on other ASs commit to carry data to the IP space on the route.

OSPFv3 defines these routers:

- Internal router (IR) a router whose interfaces are contained in a single area. All IRs in an area maintain identical LSDBs.
- Area border router (ABR) a router that has interfaces in multiple areas. ABRs maintain one LSDB for each connected area.
- Autonomous system boundary router (ASBR) a gateway router connecting the OSPFv3 domain to external routes, including static routes and routes from other autonomous systems.

[OSPFv3 Router Types](#) displays the OSPFv3 router types.

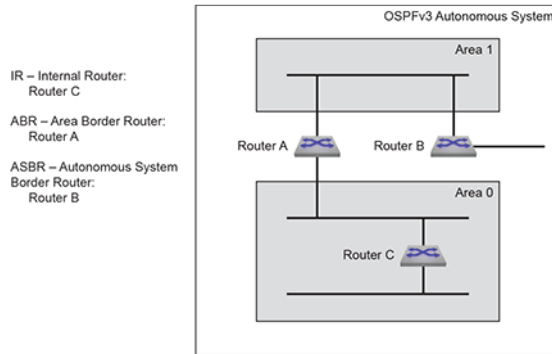

Figure 48: OSPFv3 Router Types

OSPFv3 areas are assigned a number between 0 and 4,294,967,295. Area numbers are often expressed in dotted decimal notation, similar to IP addresses.

Each AS has a backbone area, designated as area 0, that connects to all other areas. The backbone receives routing information from all areas, then distributes it to the other areas as required.

OSPFv3 area types include:

- Normal area accepts intra-area, inter-area, and external routes. The backbone is a normal area.
- Stub area does not receive router advertisements external to the AS. Stub area routing is based on a default route.

14.3.2.3 Link Updates

Routers periodically send hello packets to advertise status and establish neighbors. A router's hello packet includes IP addresses of other routers from which it received a hello packet within the time specified by the router dead interval. Routers become neighbors when they detect each other in their hello packets if they:

- share a common network segment.
- are in the same area.
- have the same hello interval, dead interval, and authentication parameters.

Neighbors form adjacencies to exchange LSDB information. A neighbor group uses hello packets to elect a Designated Router (DR) and Backup Designated Router (BDR). The DR and BDR become adjacent to all other neighbors, including each other. Only adjacent neighbors share database information.

[OSPFv3 Neighbors](#) illustrates OSPFv3 neighbors.

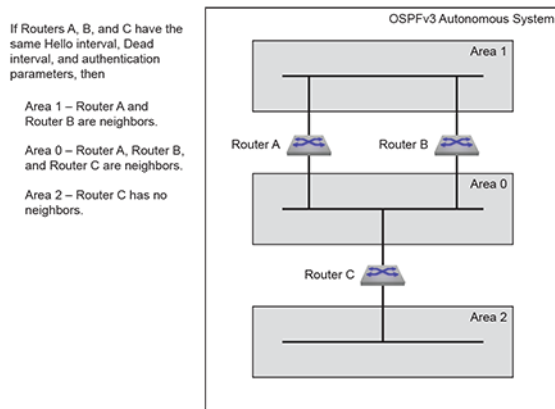

Figure 49: OSPFv3 Neighbors

The DR is the central contact for database exchanges. Switches send database information to their DR, which relays the information to the other neighbors. All routers in an area maintain identical LSDBs. Switches also send database information to their BDR, which stores this data without distributing it. If the DR fails, the BDR distributes LSDB information to its neighbors.

OSPFv3 routers distribute LSAs by sending them on all of their active interfaces. The router does not send hello packets from passive interfaces preventing adjacencies. The router does not process any OSPFv2 packets received on a passive interface.

When a router's LSDB is changed by an LSA, it sends the changes to the BDR and DR for distribution to the other neighbors. Routing information is updated only when the topology changes.

Routing devices use Dijkstra's algorithm to calculate the shortest path to all known destinations, based on cumulative route cost. The cost of an interface indicates the transmission overhead and is usually inversely proportional to its bandwidth.

14.3.2.4 OSPFv3 Security

The OSPFv3 protocol relies on the IPsec Authentication Header (AH) and Encapsulating Security Payload (ESP) header to provide data integrity, authentication and confidentiality. Transport mode provides IPsec to OSPFv3 packets.

The IPsec SA has Security Policy Index (SPI), HMAC algorithm, and a secret key as parameters. These parameters are used to compute Integrity Check Value (ICV), that is used to authenticate peers. When authentication is enabled, all corresponding peers must use same SA parameters to clear OSPFv3 ICV verification. SA can be configured at both area and interface levels.



Note: On the same area or interface, EOS allows security configuration with either AH or ESP but not both. We can have one area or interface configured with AH and another with ESP.

14.3.2.4.1 OSPFv3 Authentication

While sending OSPFv3 packets, the HMAC-MD5 or SHA algorithm hash is inserted in the IPsec header and the packet is sent over the wire for peer authentication.

While receiving OSPFv3 packets, the computed hash is verified with the one present in the IPsec header. If it fails, OSPFv3 packets are discarded.

14.3.2.4.2 OSPFv3 Encryption

ESP provides confidentiality to OSPFv3 packets. When confidentiality is enabled, ESP encrypts the sent data and decrypts the received data. OSPFv3 packets that are not encapsulated with security payload are discarded.

OSPFv3 encryption uses algorithms of Triple Data Encryption Standard (3DES) and Advanced Encryption Standard (AES). 3DES uses a 192 bit key, whereas the AES key length varies by 128, 192 and 256 bits.

14.3.2.5 Flood Pacing

OSPFv3 flood pacing allows configuring the minimum interval between the transmission of consecutive Link State (LS) update packets in a network. Flood pacing provides the following benefits:

- Prevents the rapid drain of flood queue by sending consecutive LSU packets with a delay
- Helps mitigate high CPU or socket buffer utilization issues that occur when a switch instantly floods a large number of LSAs
- When LSDB is updated frequently, an incremented flood pacing interval scales down LSA flooding



Note: A high flood pacing interval may lead to convergence delays in large OSPF LSDBs.

14.3.3 Configuring OSPFv3

These sections describe basic OSPFv3 configuration steps:

- [Configuring an OSPFv3 Instance](#)
- [Configuring OSPFv3 Areas](#)
- [Configuring Interfaces for OSPFv3](#)
- [Enabling OSPFv3](#)
- [Configuring OSPFv3 Security](#)
- [Configuring OSPFv3 Flood Pacing](#)
- [Displaying OSPFv3 Status](#)

14.3.3.1 Configuring an OSPFv3 Instance

14.3.3.1.1 Entering OSPFv3 Configuration Mode

OSPFv3 configuration commands apply to the specified OSPFv3 instance. To perform OSPFv3 configuration commands, the switch must be in router-OSPFv3 configuration mode. The `ipv6 router ospf` command places the switch in router-OSPFv3 configuration mode, creating an OSPFv3 instance if OSPFv3 was not previously instantiated on the switch. If no VRF is specified, the OSPFv3 instance is in the default VRF. To instantiate or configure OSPFv3 on a non-default VRF, specify that VRF when using the `ipv6 router ospf` command.

The process ID identifies the OSPFv3 instance and is local to the router. Neighbor OSPFv3 routers can have different process IDs. OSPFv3 instances configured in different VRFs on the switch must have different process IDs.

The switch supports one OSPFv3 instance for each VRF. When an OSPFv3 instance already exists, the `ipv6 router ospf` command must specify its process ID (and VRF, if it is not configured in the default VRF). Attempts to define additional instances in the same VRF will generate errors. The `show ipv6 ospf` command displays information about OSPFv3 instances, including their process IDs.

Example

This command places the switch in router-OSPFv3 configuration mode for the default VRF. If OSPFv3 was not previously instantiated in the default VRF, the command creates an OSPFv3 instance in the default VRF with a process ID of 9.

```
switch(config)#ipv6 router ospf 9
switch(config-router-ospf3)#show active
ipv6 router ospf 9
switch(config-router-ospf3)#
```

14.3.3.1.2 Defining the Router ID

The router ID is a 32-bit number assigned to a router running OSPFv3. This number uniquely labels the router within an Autonomous System. Status commands identify the switch through the router ID. When configuring OSPFv3 instances in multiple VRFs, each should have a different router ID.

 **Note:** A router ID is required to run OSPF, and Arista recommends setting the router ID manually for the following reasons: 1) If there are no IPv4 addresses configured on the switch, a manually configured router ID is required. 2) The router ID also does not change if the interface status or IP address changes, which can cause confusion if the ID has been selected automatically.

The switch sets the router ID to the first available alternative in the following list:

1. The `router-id` command.
2. The loopback IPv6 address, if a loopback interface is active on the switch.
3. The highest IPv6 address on the router.

 **Note:** When configuring VXLAN on an MLAG, always manually configure the OSPFv3 router ID to prevent the switch from using the common VTEP IP address as the router ID.

The `router-id (OSPFv3)` command configures the router ID for an OSPFv3 instance.

Example

This command assigns 15.1.1.1 as the OSPFv3 router ID.

```
switch(config-router-ospf3)#router-id 15.21.4.9
switch(config-router-ospf3)#show active
ipv6 router ospf 9
  router-id 15.21.4.9
switch(config-router-ospf3)#
```

14.3.3.1.3 Global OSPFv3 Parameters

These router-OSPFv3 configuration mode commands define OSPFv3 behavior for the OSPFv3 instance under which they are used.

Logging Adjacency Changes

The `log-adjacency-changes (OSPFv3)` command configures the switch to log OSPFv3 link-state changes and transitions of OSPFv3 neighbors into the up or down state.

Examples

- This command configures the switch to log transitions of OSPFv3 neighbors into the up or down state.

```
switch(config-router-ospf3)#log-adjacency-changes
switch(config-router-ospf3)#
```

- This command configures the switch to log all OSPFv3 link-state changes.

```
switch(config-router-ospf3)#log-adjacency-changes detail
switch(config-router-ospf3)#
```

Intra-Area Distance

The `distance ospf intra-area (OSPFv3)` command configures the administrative distance for routes contained in a single OSPFv3 area. Administrative distances compare dynamic routes configured by different protocols. The default administrative distance for intra-area routes is 10.

Example

This command configures an administrative distance of 90 for OSPFv3 intra-area routes.

```
switch(config-router-ospf3) #distance ospf intra-area 90
switch(config-router-ospf3) #show active
ipv6 router ospf 9
    distance ospf intra-area 90
switch(config-router-ospf3) #
```

Passive Interfaces

The **passive-interface (OSPFv3)** command prevents the transmission of hello packets on the specified interface. Passive interfaces drop all adjacencies and do not form new adjacencies. Although passive interfaces do not send or receive LSAs, other interfaces may generate LSAs for the network segment. The router does not send OSPFv3 packets from a passive interface or process OSPFv3 packets received on a passive interface. The router advertises the passive interface in the router LSA.

The **no passive-interface** command re-enables OSPFv3 processing on the specified interface.

Examples

- This command configures VLAN 200 as a passive interface.

```
switch(config-router-ospf3) #passive-interface vlan 200
switch(config-router-ospf3) #show active
ipv6 router ospf 9
    passive-interface Vlan200
switch(config-router-ospf3) #
```

- This command configures VLAN 200 as an active interface.

```
switch(config-router-ospf3) #no passive-interface vlan 200
switch(config-router-ospf3) #show active
ipv6 router ospf 9
switch(config-router-ospf3) #
```

Redistributing Connected Routes

Redistributing connected routes causes the OSPFv3 instance to advertise all connected routes on the switch as external OSPFv3 routes. Connected routes are routes that are established when IPv6 is enabled on an interface.

Example

The **redistribute (OSPFv3) connected** command converts connected routes to OSPFv3 external routes.

```
switch(config-router-ospf3) #redistribute connected
switch(config-router-ospf3) #show active
ipv6 router ospf 9
    redistribute connected
switch(config-router-ospf3) #
```

Redistributing Static Routes

Redistributing static routes causes the OSPFv3 instance to advertise all static routes on the switch as external OSPFv3 routes. The switch does not support redistributing individual static routes.

Example

The `redistribute (OSPFv3) static` command converts static routes to OSPFv3 external routes.

```
switch(config-router-ospf3)#redistribute static
switch(config-router-ospf3)#show active
ipv6 router ospf 9
    redistribute static
switch(config-router-ospf3)#
```

14.3.3.2 Configuring OSPFv3 Areas

OSPFv3 areas are configured through area commands. The switch must be in router-OSPFv3 configuration mode, as described in [Entering OSPFv3 Configuration Mode](#), to run area commands.

Areas are assigned a 32-bit number that is expressed in decimal or dotted-decimal notation. When an OSPFv3 instance configuration contains multiple areas, the switch only configures areas associated with its interfaces.

14.3.3.2.1 Configuring the Area Type

The `no area (OSPFv3)` command specifies the area type. The switch supports three area types:

- Normal area: Area that accepts intra-area, inter-area, and external routes. The backbone area (area 0) is a normal area.
- Stub area: Area where external routes are not advertised. External routes are reached through a default summary route (0.0.0.0) inserted into stub areas. Networks with no external routes do not require stub areas.

The default area type is normal.

Example

These commands configure area 200 as a NSSA area and 300 as a stub area.

```
switch(config)#ipv6 router ospf 9
switch(config-router-ospf3)#area 200 nssa
switch(config-router-ospf3)#area 300 stub
switch(config-router-ospf3)#show active
ipv6 router ospf 9
    area 0.0.0.200
    area 0.0.1.44 stub
switch(config-router-ospf3)#
```

14.3.3.2.2 Configuring Area Parameters

These router-OSPFv3 configuration mode commands define OSPFv3 behavior in a specified area.

Default Summary Route Cost

The `area default-cost (OSPFv3)` command specifies the cost of the default summary route that ABRs send into a stub area or NSSA. Summary routes, also called inter-area routes, originate in areas different than their destination. When the `area default-cost` command is not configured for an area, the default-cost of that area is set to 10.

Example

This command configures a cost of 25 for the default summary route in area 0.0.1.194 (450).

```
switch(config-router-ospf3)#area 450 default-cost 25
switch(config-router-ospf3)#show active
```

```
ipv6 router ospf 9
  area 0.0.1.194 default-cost 25
```

Area Stub

The **area stub (OSPFv3)** command configures the area type of an OSPFv3 area. All routers in an AS must specify the same area type for identically numbered areas.

Stub areas are areas in which external routes are not advertised. To reach these external routes, the stub area uses a default summary route (0.0.0.0). Networks without external routes do not require stub areas.

Areas are **normal** by default; area type configuration is required only for stub NSSA areas. Area 0 is always a normal area and cannot be configured through this command.

Examples

- This command configures area 45 as a stub area.

```
switch(config)#ipv6 router ospf 3
switch(config-router-ospf3)#area 45 stub
switch(config-router-ospf3)#
```

- This command configures area 10.92.148.17 as a stub area.

```
switch(config-router-ospf3)#area 10.92.148.17 stub
switch(config-router-ospf3)#
```

Area Range

The **area range (OSPFv3)** command is used by OSPFv3 area border routers (ABRs) to consolidate or summarize routes, to configure a cost setting for those routes, and to suppress summary route advertisements.

By default, an ABR creates a summary LSA for each route in an area and advertises that LSA to adjacent areas. The **area range (OSPFv3)** command aggregates routing information on area boundaries, allowing the ABR to use one summary LSA to advertise multiple routes.

Examples

- These commands consolidate and summarize routes at an area boundary 1.

```
switch(config)#ipv6 router ospf 1
switch(config-router-ospf3)#area 1 range 2001:0DB8:0:1::/64
switch(config-router-ospf3)#
```

- These commands change the address range status to DoNotAdvertise. Neither one of the individual intra-area routes falling under range or the ranged prefix is advertised as summary LSA.

```
switch(config)#ipv6 router ospf 1
switch(config-router-ospf3)#area 1 range 2001:0DB8:0:1::/64 not-
advertise
switch(config-router-ospf3)#
```

14.3.3.3 Configuring Interfaces for OSPFv3

OSPFv3 interface configuration commands enable OSPFv3 on an interface, assign the interface to an area, and specify transmission parameters for routed ports and SVIs that handle OSPFv3 packets.

14.3.3.3.1 Assigning an Interface to an Area

The `ipv6 ospf area` command enables OSPFv3 on the configuration mode interface and associates the specified area to the interface. Each routed interface can be associated with one OSPFv3 area; subsequent `ipv6 ospf area` commands that designate a different area on an interface replace any existing command for the interface.

Example

These commands enable OSPFv3 instance 9 on VLAN interface 200 and associate area 0 to the interface.

```
switch(config)#interface vlan 200
switch(config-if-Vl200)#ipv6 ospf 9 area 0
switch(config-if-Vl200)#show active
interface Vlan200
    ipv6 ospf 9 area 0.0.0.0
switch(config-if-Vl200)#
```

14.3.3.3.2 Configuring Intervals

Interval configuration commands determine OSPFv3 packet transmission characteristics for a specified VLAN interface. Interval configuration commands are entered in vlan-interface configuration mode.

Hello Interval

The hello interval specifies the period between consecutive hello packet transmissions from an interface. Each OSPFv3 neighbor should specify the same hello interval, which should not be longer than any neighbors dead interval.

The `ospfv3 hello-interval` command configures the hello interval for the configuration mode interface. The default is 10 seconds.

Example

These commands configure a hello interval of 45 seconds for VLAN 200.

```
switch(config)#interface vlan 200
switch(config-if-Vl200)#ospfv3 hello-interval 45
switch(config-if-Vl200)#show active
interface Vlan200
    ospfv3 hello-interval 45
switch(config-if-Vl200)#
```

Dead Interval

The dead interval specifies the period that an interface waits for an OSPFv3 packet from a neighbor before it disables the adjacency under the assumption that the neighbor is down. The dead interval should be configured identically on all OSPFv3 neighbors and be longer than the hello interval of any neighbor.

The `ospfv3 dead-interval` command configures the dead interval for the configuration mode interface. The default is 40 seconds.

Example

This command configures a dead interval of 75 seconds for VLAN 200.

```
switch(config)#interface vlan 200
switch(config-if-Vl200)#ospfv3 dead-interval 75
switch(config-if-Vl200)#show active
```

```
interface Vlan200
  ospfv3 dead-interval 75
switch(config-if-Vl200) #
```

Retransmission Interval

Routers that send OSPFv3 advertisements to an adjacent router expect to receive an acknowledgment from that neighbor. Routers that do not receive an acknowledgment will retransmit the advertisement. The retransmission interval specifies the period between retransmissions.

The `ospfv3 ipv6 retransmit-interval` command configures the LSA retransmission interval for the configuration mode interface. The default retransmission interval is 5 seconds.

Example

This command configures a retransmission interval of 25 seconds for VLAN 200.

```
switch(config) #interface vlan 200
switch(config-if-Vl200) #ospfv3 ipv6 retransmit-interval 25
switch(config-if-Vl200) #show active
interface Vlan200
  ospfv3 ipv6 retransmit-interval 25
switch(config-if-Vl200) #
```

Transmission Delay

The transmission delay is an estimate of the time that an interface requires to transmit a link-state update packet. OSPFv3 adds this delay to the age of outbound packets to more accurately reflect the age of the LSA when received by a neighbor.

The `ospfv3 transmit-delay` command configures the transmission delay for the configuration mode interface. The default transmission delay is one second.

Example

This command configures a transmission delay of 10 seconds for VLAN 200.

```
switch(config) #interface vlan 200
switch(config-if-Vl200) #ospfv3 transmit-delay 10
switch(config-if-Vl200) #show active
interface Vlan200
  ospfv3 transmit-delay 10
switch(config-if-Vl200) #
```

14.3.3.3 Configuring Interface Parameters

Interface Cost

The OSPFv3 interface cost reflects the overhead of sending packets across the interface. The cost is typically assigned to be inversely proportional to the bandwidth of the interface. The `ospfv3 cost` command configures the OSPFv3 cost for the configuration mode interface. The default cost is 10.

Example

This command configures a cost of 50 for VLAN 200.

```
switch(config) #interface vlan 200
switch(config-if-Vl200) #ospfv3 cost 50
switch(config-if-Vl200) #show active
interface Vlan200
  ospfv3 cost 50
```

```
switch(config-if-Vl200) #
```

Router Priority

Router priority determines preference during designated router (DR) and backup designated router (BDR) elections. Routers with higher priority numbers have preference over other routers. Routers with a priority of zero cannot be elected as a DR or BDR.

The `ospfv3 priority` command configures router priority for the configuration mode interface. The default priority is 1.

Example

This command configures a router priority of 128 for VLAN 200.

```
switch(config) #interface vlan 200
switch(config-if-Vl200) #ospfv3 priority 128
switch(config-if-Vl200) #show active
interface Vlan200
    ospfv3 priority 128
switch(config-if-Vl200) #
```

14.3.3.4 Enabling OSPFv3

14.3.3.4.1 IP Routing

OSPFv3 requires that IPv6 unicast routing is enabled on the switch. When IP routing is not enabled, entering OSPFv3 configuration mode generates a message.

Examples

- This message is displayed if, when entering router-OSPFv3 configuration mode, IPv6 unicast routing is not enabled.

```
switch(config) #ipv6 router ospf 9
! IPv6 routing not enabled
switch(config-router-ospf3) #
```

- This command enables IP routing on the switch.

```
switch(config) #ipv6 unicast-routing
```

14.3.3.4.2 Disabling OSPFv3

The `shutdown (OSPFv3)` disables OSPFv3 operations on the switch without disrupting the OSPFv3 configuration. To disable OSPFv3 on an interface, remove the `ipv6 ospf area` statement for the corresponding interface.

The `no shutdown` command resumes OSPFv3 activity.

Examples

- This command disables OSPFv3 activity on the switch.

```
switch(config) #ipv6 router ospf 9
switch(config-router-ospf3) #shutdown
switch(config-router-ospf3) #show active
ipv6 router ospf 9
    shutdown
```

```
switch(config-router-ospf3) #
```

- This command resumes OSPFv3 activity on the switch.

```
switch(config-router-ospf3) #no shutdown
switch(config-router-ospf3) #show active
ipv6 router ospf 9
switch(config-router-ospf3) #
```

14.3.3.5 Configuring OSPFv3 Security

You can configure OSPFv3 security for either an area or an interface, or both, using either an Authentication Header (AH) or an Encapsulating Security Payload (ESP).

When OSPFv3 security is configured on an area, the configured settings apply to all interfaces in that area. Interface-specific configuration overrides configuration on the area to which the interface belongs.

14.3.3.5.1 Configuring OSPFv3 Authentication

Configuring OSPFv3 Authentication for Areas

The `area authentication ipsec spi` command configures OSPFv3 authentication on an area.

Example

This command configures OSPFv3 authentication on an area with MD5 hash algorithm.

```
switch(config) #ipv6 router ospf 9
switch(config-router-ospf3) #area 0.0.0.0 authentication ipsec spi 34 md5
0 8FD6158BFE81ADD961241D8E4169D411
switch(config-router-ospf3) #show active
ipv6 router ospf 9
    area 0.0.0.0 authentication ipsec spi 34 md5 7 $1$cNpqrQ1l1cz
qdvKazKLtYVr6I7+R3niuWouDKKYCFNs4/XOWG/Iap5Q==
switch(config-router-ospf3) #
```

Configuring OSPFv3 Authentication for Interfaces

The `ospfv3 authentication ipsec spi` command configures OSPFv3 authentication on an interface.

Example

This command configures OSPFv3 authentication on an interface with MD5 hash algorithm.

```
switch(config-if-Et9) #ospfv3 authentication ipsec spi 3456 md5 0
8FD6158BFE81ADD961241D8E4169D411
switch(config-if-Et9) #show active
interface Ethernet9
    no switchport
    ospfv3 authentication ipsec spi 3456 md5 7 $1$xtmcMSPzEn+Njp8Lb4qryVV
OjKcjsrYuv6dxl0+nSwKQdaiRt2RPTQ==
switch(config-if-Et9) #
```

14.3.3.5.2 Configuring OSPFv3 Encryption

Configuring OSPFv3 Encryption for Areas

The `area encryption ipsec spi` command configures OSPFv3 security on an area.

Example

This command configures OSPFv3 security on an area with 3DES-CBC encryption and MD5 hash algorithm.

```
switch(config)#ipv6 router ospf 9
switch(config-router-ospf3)#area 0.0.0.0 encryption ipsec spi 5678 esp
3des-cbc md5 passphrase 0 8FD6158BFE81ADD961241D8E4169D411
switch(config-router-ospf3)#show active
ipv6 router ospf 9
    area 0.0.0.0 encryption ipsec spi 5678 esp 3des-cbc md5 passphrase 7
    $1$cNpcrQ1lczqdvKAZKLtYVr6I7+R3niuWouDKKYCFNs4/XOWG/Iap5Q==
switch (config-router-ospf3)#
```

Configuring OSPFv3 Encryption for Interfaces

The **ospfv3 encryption ipsec spi** command configures OSPFv3 security on an interface.

Example

This command configures OSPFv3 security on an interface with 3DES-CBC encryption and SHA1 algorithm.

```
switch(config)#interface ethernet 9
switch(config-if-Et9)#ospfv3 encryption ipsec spi 345 esp 3des-cbc sha1
passphrase 0 2fd4e1c67a2d28fced849ee1bb76e7391b93eb12
switch(config-if-Et9)#show active
interface Ethernet9
    no switchport
    ospfv3 encryption ipsec spi 345 esp 3des-cbc sha1 passphrase 7
    $1$VmUkWk6IL2S343bR3BbH0RhgvxHhwBpFvB4VXKNOOQF7HJBp5VvXTfBaVYbgCkWU
switch(config-if-Et9)#
```

14.3.3.6 Configuring OSPFv3 Flood Pacing

Flood pacing can be configured for global OSPFv3 instances and address families. The **timers pacing flood** command configures OSPFv3 flood pacing.

Examples

- This command configures OSPFv3 flood pacing timer to 50 ms in the global OSPFv3 instance.

```
switch(config)#ipv6 router ospf 9
switch(config-router-ospf3)#timers pacing flood 50
switch(config-router-ospf3)#show ipv6 ospf
Routing Process "ospfv3 9" with ID 13.13.13.13 and Instance 0 VRF
default
    FIPS mode disabled
    It is not an autonomous system boundary router and is not an area
border router
    Minimum LSA arrival interval 1000 msec
    Initial LSA throttle delay 1000 msec
    Minimum hold time for LSA throttle 5000 msec
    Maximum wait time for LSA throttle 5000 msec
    Interface flood pacing timer 50 msec
    It has 0 fully adjacent neighbors
    Number of areas in this router is 1. 1 normal, 0 stub, 0 nssa
    Number of LSAs 1
    Initial SPF schedule delay 0 msec
    Minimum hold time between two consecutive SPFs 5000 msec
    Current hold time between two consecutive SPFs 5000 msec
    Maximum wait time between two consecutive SPFs 5000 msec
    SPF algorithm last executed 21d19h ago
    No scheduled SPF
```

```

Adjacency exchange-start threshold is 20
Maximum number of next-hops supported in ECMP is 32
Number of backbone neighbors is 0
Graceful-restart is not configured
Graceful-restart-helper mode is enabled
Area 0.0.0.0
  Number of interface in this area is 0
  It is a normal area
  SPF algorithm executed 2 times

```

- This command configures OSPFv3 flood pacing timer to 50 ms for ipv4 address family.

```

switch(config)#router ospfv3
switch(config-router-ospfv3)#address-family ipv4
switch(config-router-ospfv3-af)#timers pacing flood 50
switch(config-router-ospfv3-af)#show ospfv3
OSPFv3 address-family ipv4
Routing Process "ospfv3" with ID 11.1.11.1 and Instance 64 VRF default
  FIPS mode disabled
  It is not an autonomous system boundary router and is not an area
  border router
  Minimum LSA arrival interval 1000 msec
  Initial LSA throttle delay 1000 msec
  Minimum hold time for LSA throttle 5000 msec
  Maximum wait time for LSA throttle 5000 msec
  Interface flood pacing timer 50 msec
  It has 0 fully adjacent neighbors
  Number of areas in this router is 1. 1 normal, 0 stub, 0 nssa
  Number of LSAs 1
  Initial SPF schedule delay 0 msec
  Minimum hold time between two consecutive SPF's 5000 msec
  Current hold time between two consecutive SPF's 5000 msec
  Maximum wait time between two consecutive SPF's 5000 msec
  SPF algorithm last executed 00:01:05 ago
  No scheduled SPF
  Adjacency exchange-start threshold is 20
  Maximum number of next-hops supported in ECMP is 32
  Number of backbone neighbors is 0
  Graceful-restart is not configured
  Graceful-restart-helper mode is enabled
  Area 0.0.0.0
    Number of interface in this area is 0
    It is a normal area
    SPF algorithm executed 2 times

```

14.3.3.7 Displaying OSPFv3 Status

This section describes OSPFv3 **show** commands that display OSPFv3 status. General switch methods that provide OSPFv3 information include pinging routes, viewing route status (**show ip route** command), and viewing the configuration (**show running-config** command).

14.3.3.7.1 OSPFv3 Summary

The **show ipv6 ospf** command displays general OSPFv3 configuration information, operational statistics and status for the OSPFv3 instance, followed by a brief description of the areas configured on the switch.

Example

- This command displays OSPFv3 routing process information.

```

switch(config-router-ospf3)#show ipv6 ospf

```

```

Routing Process "ospfv3 1" with ID 1.1.1.1 and Instance 0 VRF default
  It is not an autonomous system boundary router and is not an area
  border router
  Minimum LSA arrival interval 1000 msec
  Initial LSA throttle delay 1000 msec
  Minimum hold time for LSA throttle 5000 msec
  Maximum wait time for LSA throttle 5000 msec
  Interface flood pacing timer 50 msec
  It has 0 fully adjacent neighbors
  ...
  Graceful-restart is not configured
  Graceful-restart-helper mode is enabled

```

14.3.3.7.2 Viewing OSPFv3 on the Interfaces

The `show ipv6 ospf interface` command displays OSPFv3 information for switch interfaces configured for OSPFv3. Different command options allow the display of either all interfaces or a specified interface. The command can also be configured to display complete information or a brief summary.

Example

This command displays OSPFv3 information for interfaces where OSPFv3 is enabled.

```

switch#show ipv6 ospf interface
Ethernet17 is up
  Interface Address fe80::48c:73ff:fe00:1319%Ethernet12, Area 0.0.0.0
  Network Type Broadcast, Cost 10
  Transmit Delay is 1 sec, State Backup DR, Priority 1
  Designated Router is 10.37.0.37
  Backup Designated Router is 10.37.0.23
  Timer intervals configured, Hello 10, Dead 40, Retransmit 5
  Neighbor Count is 1
Vlan31 is up
  Interface Address fe80::48c:73ff:fe00:1319%Vlan31, Area 0.0.0.0
  Network Type Broadcast, Cost 10
  Transmit Delay is 1 sec, State Backup DR, Priority 1
  Designated Router is 10.37.0.22
  Backup Designated Router is 10.37.0.23
  Timer intervals configured, Hello 10, Dead 40, Retransmit 5
  Neighbor Count is 1
Vlan32 is up
  Interface Address fe80::48c:73ff:fe00:1319%Vlan32, Area 0.0.0.0
  Network Type Broadcast, Cost 10
  Transmit Delay is 1 sec, State DR Other, Priority 1
  Designated Router is 10.37.0.11
  Backup Designated Router is 10.37.0.22
  Timer intervals configured, Hello 10, Dead 40, Retransmit 5
  Neighbor Count is 2
switch#

```

14.3.3.7.3 Viewing the OSPFv3 Database

The `show ipv6 ospf database <link state list>` command displays the LSAs in the LSDB for the specified area. If no area is listed, the command displays the contents of the database for each area on the switch. The database command provides options to display subsets of the LSDB database, a summary of database contents, and the link states that comprise the database.

Example

This command displays the OSPFv3 database of link state advertisements (LSAs).

```
switch#show ipv6 ospf database
Routing Process "ospf 9":

  AS Scope LSDB

Type          Link ID      ADV Router  Age         Seq#        Checksum
AEX           0.0.0.5     10.37.0.37  15 0x80000005 0x00be82
AEX           0.0.0.9     10.37.0.22  1747 0x8000002b 0x00df56
AEX           0.0.0.3     10.37.0.46  599 0x8000002d 0x00651d

Area 0.0.0.0 LSDB

Type          Link ID      ADV Router  Age         Seq#        Checksum
RTR           0.0.0.0     10.37.0.32  234 0x80000031 0x00585a
NTW           0.0.0.26    10.37.0.32  271 0x80000005 0x005609
NAP           0.0.0.26    10.37.0.32  274 0x80000005 0x00964c

Interface vlan3911 LSDB

Type          Link ID      ADV Router  Age         Seq#        Checksum
LNK           0.0.0.38    10.37.0.22  267 0x80000005 0x00a45a
LNK           0.0.0.23    10.37.0.23  270 0x8000002c 0x005b7e

Interface vlan3902 LSDB

Type          Link ID      ADV Router  Age         Seq#        Checksum
LNK           0.0.0.17    10.37.0.11  1535 0x8000002b 0x007120
LNK           0.0.0.37    10.37.0.22  7 0x8000002b 0x00ce23
LNK           0.0.0.22    10.37.0.23  250 0x8000002d 0x00c350

switch#
```

14.3.3.7.4 Viewing OSPFv3 Neighbors

The `show ipv6 ospf neighbor` command displays information about the routers that are neighbors to the switch. Command options allow the display of summary or detailed information about the neighbors to all areas and interfaces on the switch. The command also allows for the display of neighbors to individual interfaces or areas. The **adjacency-changes** option displays the interfaces adjacency changes.

Example

This command displays the switch's neighbors.

```
switch#show ipv6 ospf neighbor
Routing Process "ospf 9":
Neighbor 10.37.0.37 priority is 1, state is Full
  In area 0.0.0.0 interface et12
  DR is 10.37.0.37 BDR is 10.37.0.23
  Options is 0
  Dead timer is due in 37 seconds
Neighbor 10.37.0.22 priority is 1, state is Full
  In area 0.0.0.0 interface vlan3911
  DR is 10.37.0.22 BDR is 10.37.0.23
  Options is 0
  Dead timer is due in 31 seconds
Neighbor 10.37.0.22 priority is 1, state is Full
  In area 0.0.0.0 interface vlan3902
  DR is 10.37.0.11 BDR is 10.37.0.22
  Options is 0
```



```

Dead timer is due in 31 seconds
Neighbor 10.37.0.22 priority is 1, state is Full
In area 0.0.0.0 interface vlan3908
DR is 10.37.0.22 BDR is 10.37.0.21
Options is 0
Dead timer is due in 39 seconds

switch#

```

14.3.3.7.5 Viewing OSPFv3 Routes

The `show ipv6 routes` command provides an OSPFv3 option.

Example

This command displays the switch's OSPFv3 routes.

```

switch#show ipv6 route ospf
IPv6 Routing Table - 43 entries
Codes: C - connected, S - static, K - kernel, O - OSPF, B - BGP, R - RIP,
A -
Aggregate

O   fd7a:3279:81a4:1112::/64 [150/11]
    via fe80::21c:41ff:fe00:d120, Ethernet12
O   fd7a:3279:81a4:1114::/64 [150/11]
    via fe80::21c:41ff:fe00:d120, Ethernet12
O   fd7a:3279:81a4:1124::/64 [10/20]
    via fe80::21c:41ff:fe01:5fe1, Vlan3901
    via fe80::21c:41ff:fe01:5fe1, Vlan3902
    via fe80::21c:41ff:fe01:5fe1, Vlan3908
O   fd7a:3279:81a4:1a00::25/128 [150/11]
    via fe80::21c:41ff:fe00:d120, Ethernet12
O   fd7a:3279:81a4:1a00::28/128 [150/11]
    via fd7a:3279:81a4:fe40::5, Vlan3908

```

14.3.4 OSPFv3 Configuration Examples

This section describes the commands required to configure three OSPFv3 topologies.

14.3.4.1 OSPFv3 Configuration Example 1

The AS in Example 1 contains two areas that are connected through two routers. The backbone area also contains an internal router that connects two links.

14.3.4.1.1 Example 1 Topology

[OSPFv3 Example 1](#) displays the Example 1 topology. Two ABRs connect area 0 and area 1 Router A and Router B. Router C is an internal router that connects two links in area 0. Area 0 is normal; area 1 is stub.

Figure 50: OSPFv3 Example 1

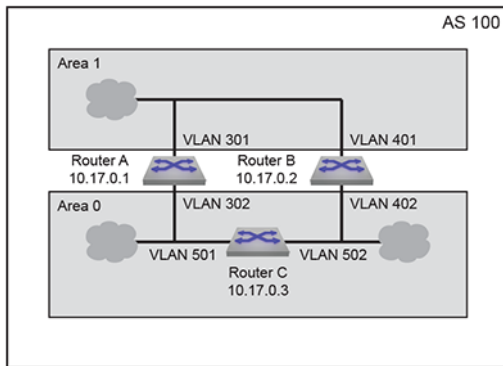

Area 1 Configuration

Area 1 contains links to ABRs Router A and Router B.

- Router A is accessed through VLAN 301.
- Router B is accessed through VLAN 401.
- Designated Router (DR): Router A.
- Backup Designated Router (BDR): Router B.
- Each router defines an interface cost of 10.
- Router priority is not specified for either router on area 1.

Area 0 ABR Configuration

Area 0 contains links to ABRs Router A and Router B.

- Router A is accessed through VLAN 302.
- Router B is accessed through VLAN 402.
- Designated Router (DR): Router B.
- Backup Designated Router (BDR): Router A.
- Each router defines an interface cost of 20.
- Each router defines a retransmit-interval of 10.
- Each router defines a transmit-delay of 2.
- Router priority is specified such that Router B will be elected as the Designated Router.

Area 0 IR Configuration

Area 0 contains two links to an internal router.

- Router C is accessed through VLAN 501 and VLAN 502.
- VLAN 501 is configured as follows:
 - Interface cost of 20.
 - Retransmit-interval of 10.
 - Transmit-delay of 2.
- VLAN 502 is configured as follows:
 - Interface cost of 20.
 - Dead interval of 80 seconds.

14.3.4.1.2 Example 1 Code

This code configures the OSPFv3 instances on the three switches.

1. Configure the areas and router IDs.

- a. Router A OSPFv3 instance configuration:

```
switch-A(config)#ipv6 router ospf 100  
switch-A(config-router-ospfv3)#area 1 stub  
switch-A(config-router-ospfv3)#router-id 10.17.0.1
```

- b. Router B OSPFv3 instance configuration:

```
switch-B(config)#ipv6 router ospf 100  
switch-B(config-router-ospfv3)#area 1 stub  
switch-B(config-router-ospfv3)#router-id 10.17.0.2
```

- c. Router C OSPFv3 instance configuration: interfaces:

```
switch-C(config)#ipv6 router ospf 100  
switch-C(config-router-ospfv3)#router-id 10.17.0.3
```

2. Configure the interface OSPFv3 area and transmission parameters.

- a. Router A interfaces:

```
switch-A(config)#interface vlan 301  
switch-A(config-if-Vl301)#ipv6 ospf 100 area 1  
switch-A(config-if-Vl301)#ospfv3 cost 10  
switch-A(config-if-Vl301)#ospfv3 priority 6  
switch-A(config-if-Vl301)#exit  
switch-A(config)#interface vlan 302  
switch-A(config-if-Vl302)#ipv6 ospf 100 area 0  
switch-A(config-if-Vl302)#ospfv3 cost 20  
switch-A(config-if-Vl302)#ospfv3 ipv6 retransmit-interval 10  
switch-A(config-if-Vl302)#ospfv3 transmit-delay 2  
switch-A(config-if-Vl302)#ospfv3 priority 4
```

- b. Router B interfaces:

```
switch-B(config)#interface vlan 401  
switch-B(config-if-Vl401)#ipv6 ospf 100 area 1  
switch-B(config-if-Vl401)#ospfv3 cost 10  
switch-B(config-if-Vl401)#ospfv3 priority 4  
switch-B(config-if-Vl401)#exit  
switch-B(config)#interface vlan 402  
switch-B(config-if-Vl402)#ipv6 ospf 100 area 0  
switch-B(config-if-Vl402)#ospfv3 cost 20  
switch-B(config-if-Vl402)#ospfv3 ipv6 retransmit-interval 10  
switch-B(config-if-Vl402)#ospfv3 transmit-delay 2  
switch-B(config-if-Vl402)#ospfv3 priority 6
```

- c. Router C interfaces:

```
switch-C(config)#interface vlan 501  
switch-C(config-if-Vl501)#ipv6 ospf 100 area 0  
switch-C(config-if-Vl501)#ospfv3 cost 20  
switch-C(config-if-Vl501)#ospfv3 ipv6 retransmit-interval 10  
switch-C(config-if-Vl501)#ospfv3 transmit-delay 2  
switch-C(config-if-Vl501)#exit  
switch-C(config)#interface vlan 502  
switch-C(config-if-Vl502)#ipv6 ospf 100 area 0  
switch-C(config-if-Vl502)#ospfv3 cost 20  
switch-C(config-if-Vl502)#ospfv3 dead-interval 80
```

14.3.4.2 OSPFv3 Configuration Example 2

The AS in Example 2 contains three areas. Area 0 connects to the other areas through different routers and contains an internal router connecting two links. Area 0 is normal; the other areas are stub areas.

14.3.4.2.1 Example 2 Topology

OSPFv3 Example 2 displays the Example 2 topology. One ABR (Router B) connects area 0 and area 1; another ABR (router C) connects area 0 and area 2. Router A is an internal router that connects two links in area 0.

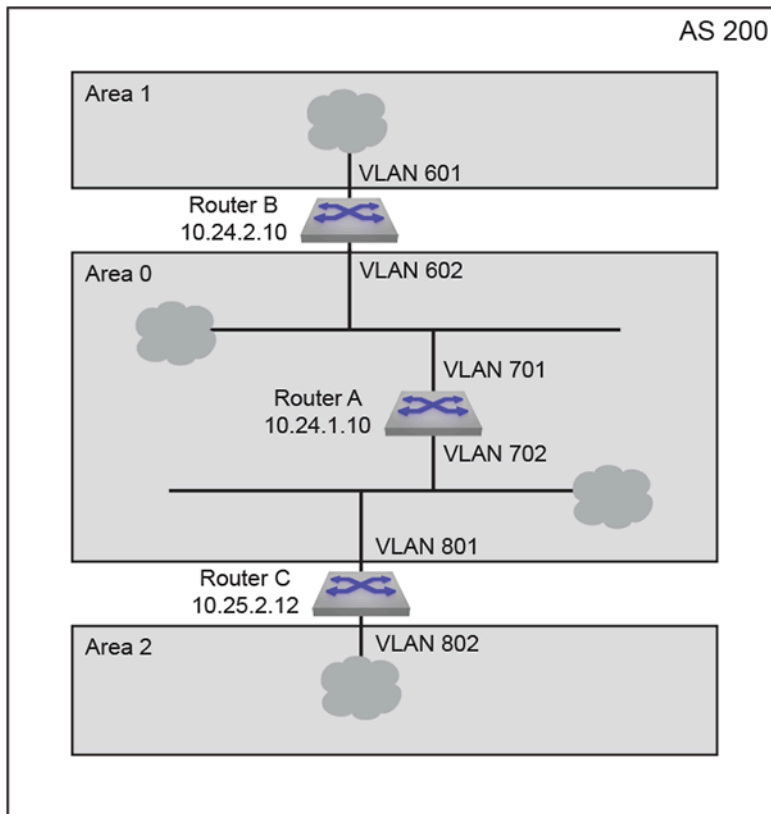

Figure 51: OSPFv3 Example 2

Area 1 Configuration

Area 1 contains one link that is accessed by Router B.

- Router B is accessed through VLAN 601.
- The router defines a interface cost of 10.

Area 2 Configuration

Area 2 contains one link that is accessed by Router C.

- Router C is accessed through VLAN 802.
- The router defines a interface cost of 20.

Area 0 ABR Configuration

One ABR Router B link connects area 1 to area 0. One ABR Router C link connects area 0 to area 2.

- Router B is accessed through VLAN 602.
- Router C is accessed through VLAN 801.
- Designated Router (DR): Router B.
- Backup Designated Router (BDR): Router C.
- Each router defines an interface cost of 20.
- Each router defines a retransmit-interval of 10.
- Each router defines a transmit-delay of 2.

Area 0 IR Configuration

Area 0 contains links connected by an internal router.

- Router A is accessed through VLAN 701 and 702.
- The VLAN 701 link is configured as follows:
 - Interface cost of 10.
- The VLAN 702 link is configured as follows:
 - Interface cost of 20.
 - Retransmit-interval of 10.
 - Transmit-delay of 2.

14.3.4.2.2 Example 2 Code

1. Configure the areas and router IDs.

a. Router A OSPFv3 instance configuration:

```
switch-A(config)#ipv6 router ospf 200
switch-A(config-router-ospfv3)#router-id 10.24.1.10
```

b. Router B OSPFv3 instance configuration:

```
switch-B(config)#ipv6 router ospf 200
switch-B(config-router-ospfv3)#area 1 stub
switch-B(config-router-ospfv3)#router-id 10.24.2.10
```

c. Router C OSPFv3 instance configuration:

```
switch-C(config)#ipv6 router ospf 200
switch-C(config-router-ospfv3)#area 1 stub
switch-C(config-router-ospfv3)#router-id 10.25.2.12
```

2. Configure the interface OSPFv3 area and transmission parameters.

a. Router A interfaces:

```
switch-A(config)#interface vlan 701
switch-A(config-if-Vl701)#ipv6 ospf 200 area 0
switch-A(config-if-Vl701)#ospfv3 cost 10
switch-A(config-if-Vl701)#exit
switch-A(config)#interface vlan 702
switch-A(config-if-Vl702)#ipv6 ospf 200 area 0
switch-A(config-if-Vl702)#ospfv3 cost 20
switch-A(config-if-Vl702)#ospfv3 ipv6 retransmit-interval 10
switch-A(config-if-Vl702)#ospfv3 transmit-delay 2
```

b. Router B interfaces:

```
switch-B(config)#interface vlan 601
switch-B(config-if-Vl601)#ospfv3 200 area 1
```

```

switch-B(config-if-Vl601)#ospfv3 cost 10
switch-B(config-if-Vl601)#exit
switch-B(config)#interface vlan 602
switch-B(config-if-Vl602)#ospfv3 200 area 0
switch-B(config-if-Vl602)#ospfv3 cost 20
switch-B(config-if-Vl602)#ospfv3 ipv6 retransmit-interval 10
switch-B(config-if-Vl602)#ospfv3 transmit-delay 2
switch-B(config-if-Vl602)#ospfv3 priority 6

```

c. Router C interfaces:

```

switch-C(config)#interface vlan 801
switch-C(config-if-Vl801)#ospfv3 200 area 0
switch-C(config-if-Vl801)#ospfv3 cost 20
switch-C(config-if-Vl801)#ospfv3 ipv6 retransmit-interval 10
switch-C(config-if-Vl801)#ospfv3 transmit-delay 2
switch-C(config-if-Vl801)#exit
switch-C(config)#interface vlan 802
switch-C(config-if-Vl802)#ospfv3 200 area 2
switch-C(config-if-Vl802)#ospfv3 cost 20
switch-C(config-if-Vl802)#ospfv3 dead-interval 80

```

14.3.4.3 OSPFv3 Configuration Example 3

The AS in Example 3 contains two areas that connect through one ABR. Each area also contains an ASBR that connects static routes to the AS.

14.3.4.3.1 Example 3 Topology

[OSPFv3 Example 3](#) displays the Example 3 topology. One ABR connects area 0 and area 1. Router C is an ABR that connects the areas. Router A is an internal router that connects two links in area 1. Router D and Router E are internal routers that connect links in area 0. Router B and Router F are ASBRs that connect static routes outside the AS to area 1 and area 0, respectively.

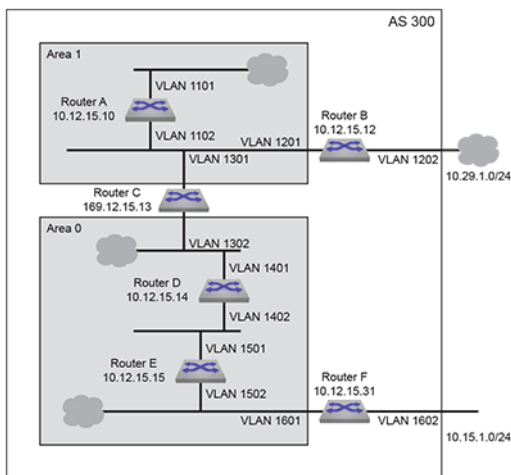

Figure 52: OSPFv3 Example 3

Area 0 ABR Configuration

ABR Router C connects one area 0 link to an area 1 link.

- Router C is accessed through VLAN 1302.
- All interface OSPFv3 parameters are set to their default values.

Area 0 IR Configuration

Area 0 contains two internal routers, each of which connects two of the three links in the area.

- Router D is accessed through VLAN 1401 and VLAN 1402.
- Router E is accessed through VLAN 1501 and VLAN 1502.
- All interface OSPFv3 parameters are set to their default values.

Area 0 ASBR Configuration

ASBR Router F connects one area 0 link to an external link.

- Router F is accessed through VLAN 1601.
- Router F connects to the external AS through VLAN 1602.
- All interface OSPFv3 parameters are set to their default values.

Area 1 ABR Configuration

ABR Router C connects one area 0 link to an area 1 link.

- Router C is accessed by area 1 through VLAN 1301.
- Router C is accessed by area 0 through VLAN 1302.
- All interface OSPFv3 parameters are set to their default values.

Area 1 IR Configuration

Area 1 contains one internal router that connects two links in the area.

- Router A is accessed through VLAN 1101 and VLAN 1102.
- All interface OSPFv3 parameters are set to their default values.

Area 1 ASBR Configuration

ASBR Router B connects one area 1 link to an external link.

- Router B is access through VLAN 1201.
- Router B connects to the external AS through VLAN 1202.
- All interface OSPFv3 parameters are set to their default values.

14.3.4.3.2 Example 3 Code

1. Configure the areas and router IDs.
 - a. Router A OSPFv3 instance configuration:

```
switch-A(config)#ipv6 router ospf 300
switch-A(config-router-ospfv3)#router-id 10.12.15.10
switch-A(config-router-ospfv3)#area 1 stub
```

- b. Router B OSPFv3 instance configuration:

```
switch-B(config)#ipv6 router ospf 300
switch-B(config-router-ospfv3)#router-id 10.12.15.12
switch-B(config-router-ospfv3)#area 1 stub
```

- c. Router OSPFv3 instance configuration:

```
switch-C(config)#ipv6 router ospf 300
switch-C(config-router-ospfv3)#router-id 10.12.15.13
```

```
switch-C(config-router-ospfv3)#area 1 stub
```

d. Router D OSPFv3 instance configuration:

```
switch-D(config)#ipv6 router ospf 300  
switch-D(config-router-ospfv3)#router-id 10.12.15.14
```

e. Router E OSPFv3 instance configuration:

```
switch-E(config)#ipv6 router ospf 300  
switch-E(config-router-ospfv3)#router-id 10.12.15.15
```

f. Router F OSPFv3 instance configuration:

```
switch-F(config)#ipv6 router ospf 300  
switch-F(config-router-ospfv3)#router-id 10.12.15.31
```

2. Configure the interfaces.

a. Router A interfaces:

```
switch-A(config)#interface vlan 1101  
switch-A(config-if-Vl1101)#ospfv3 300 area 1  
switch-A(config-if-Vl1101)#exit  
switch-A(config)#interface vlan 1102  
switch-A(config-if-Vl1102)#ospfv3 300 area 1
```

b. Router B interfaces:

```
switch-B(config)#interface vlan 1201  
switch-B(config-if-Vl1201)#ospfv3 300 area 1  
switch-B(config-if-Vl1201)#exit
```

c. Router C interfaces:

```
switch-C(config)#interface vlan 1301  
switch-C(config-if-Vl1301)#ospfv3 300 area 1  
switch-C(config-if-Vl1301)#exit  
switch-C(config)#interface vlan 1302  
switch-C(config-if-Vl1302)#ospfv3 300 area 0
```

d. Router D interfaces:

```
switch-D(config)#interface vlan 1401  
switch-D(config-if-Vl1401)#ospfv3 300 area 0  
switch-D(config-if-Vl1401)#exit  
switch-D(config)#interface vlan 1402  
switch-D(config-if-Vl1402)#ospfv3 300 area 0
```

e. Router E interfaces:

```
switch-E(config)#interface vlan 1501  
switch-E(config-if-Vl1501)#ospfv3 300 area 0  
switch-E(config-if-Vl1501)#exit  
switch-E(config)#interface vlan 1502  
switch-E(config-if-Vl1502)#ospfv3 300 area 0
```

f. Router F interfaces:

```
switch-F(config)#interface vlan 1601  
switch-F(config-if-Vl1601)#ospfv3 300 area 0  
switch-F(config-if-Vl1601)#exit
```

14.3.5 OSPFv3 Commands

Global Configuration Mode

- `clear ospfv3 ipv6 force-spf`
- `ipv6 router ospf`

Interface Configuration Mode

- `ipv6 ospf area`
- `ospfv3 authentication ipsec spi`
- `ospfv3 cost`
- `ospfv3 dead-interval`
- `ospfv3 encryption ipsec spi`
- `ospfv3 hello-interval`
- `ospfv3 ipv6 retransmit-interval`
- `ospfv3 network`
- `ospfv3 priority`
- `ospfv3 transmit-delay`

Router-OSPFv3 Configuration Mode

- `adjacency exchange-start threshold (OSPFv3)`
- `area authentication ipsec spi`
- `area default-cost (OSPFv3)`
- `area encryption ipsec spi`
- `area nssa (OSPFv3)`
- `area nssa default-information-originate (OSPFv3)`
- `area not-so-stubby lsa type-7 convert type-5 (OSPFv3)`
- `area range (OSPFv3)`
- `area stub (OSPFv3)`
- `default-information originate (OSPFv3)`
- `default-metric (OSPFv3)`
- `distance ospf intra-area (OSPFv3)`
- `log-adjacency-changes (OSPFv3)`
- `max-metric router-lsa (OSPFv3)`
- `maximum-paths (OSPFv3)`
- `no area (OSPFv3)`
- `passive-interface (OSPFv3)`
- `redistribute (OSPFv3)`
- `router-id (OSPFv3)`
- `shutdown (OSPFv3)`
- `timers`
- `timers lsa rx min interval (OSPFv3)`
- `timers lsa tx delay initial (OSPFv3)`
- `timers spf delay initial (OSPFv3)`

Display Commands

- `show ipv6 ospf`
- `show ipv6 ospf border-routers`

-
- show ipv6 ospf database
 - show ipv6 ospf database<link-state details>
 - show ipv6 ospf database <link state list>
 - show ipv6 ospf database link
 - show ipv6 ospf database link if-name
 - show ipv6 ospf database link if-type
 - show ipv6 ospf interface
 - show ipv6 ospf lsa-log
 - show ipv6 ospf neighbor
 - show ipv6 ospf neighbor state
 - show ipv6 ospf neighbor summary
 - show ipv6 ospf spf-log
 - show ospfv3

14.3.5.1 adjacency exchange-start threshold (OSPFv3)

The **adjacency exchange-start threshold** command sets the exchange-start options for an OSPF instance.

The **no adjacency exchange-start threshold** and **default adjacency exchange-start threshold** command resets the default by removing the corresponding **adjacency exchange-start threshold** command from *running-config*.

Command Mode

Router-OSPFv3 Configuration

Command Syntax

```
adjacency exchange-start threshold peers
no adjacency exchange-start threshold
default adjacency exchange-start threshold
```

Parameters

peers Value ranges from 1 4294967295. Default value is 10.

Example

This command sets the adjacency exchange start threshold to 156923.

```
switch(config)#ipv6 router ospf 3
switch(config-router-ospf3)#adjacency exchange-start threshold 156923
switch(config-router-ospf3)#
```

14.3.5.2 area authentication ipsec spi

The `area authentication ipsec spi` command configures OSPFv3 authentication on an area.

The `default area authentication` and `no area authentication` commands delete the OSPFv3 authentication on an area.

Command Mode

Router-OSPFv3 Configuration

Command Syntax

```
area area_id authentication ipsec spi spi_value {md5|sha1} {0 unencrypted_key | 7 hidden_key | KEY}
```

```
area area_id authentication ipsec spi spi_value {md5|sha1} passphrase {0 unencrypted_key | 7 hidden_key | LINE}
```

```
no area area_id authentication ipsec spi spi_value {md5| sha1} passphrase {0 unencrypted_key | 7 hidden_key | LINE}
```

```
default area area_id authentication ipsec spi spi_value {md5| sha1} passphrase {0 unencrypted_key | 7 hidden_key | LINE}
```

Parameters

- **area** *area_id* configures OSPF area ID in either IP address or decimal formats. The value for decimal format ranges from 0 to 4294967295.
- **spi** *spi_value* configures the IPsec Security Parameter Index. The value ranges from 0 to 4294967295.
- **md5** configures HMAC-MD5 hash algorithm.
- **sha1** configures HMAC-SHA1 algorithm.
- **0 unencrypted_key** configures either a 192 bit 3DES key or 128/192/256 bit AES key in an unencrypted format.
- **7 encrypted_key** configures either a 192 bit 3DES key or 128/192/256 bit AES key in an encrypted format.
- **KEY** configures either a 128 bit MD5 key or a 140 bit SHA1 key.
- **passphrase** configures passphrase for authentication and encryption. Options include:
 - **0 unencrypted_passphrase** configures an unencrypted key.
 - **7 encrypted_passphrase** configures an encrypted key.
 - **LINE** uses passphrase string to derive keys for authentication and encryption.

Related Commands

- [ospfv3 authentication ipsec spi](#)
- [area encryption ipsec spi](#)

Guidelines

Passphrase and key value are exclusive. MD5 and SHA1 keys are derived from the configured passphrase.

Restriction

On the same area, EOS allows security configuration with either AH or ESP but not both. We can have one area configured with AH and another with ESP.

Examples

- This command configures OSPFv3 authentication on an area with MD5 hash algorithm.

```
switch(config)#ipv6 router ospf 9
```

```
switch(config-router-ospf3)#area 0.0.0.0 authentication ipsec spi 34
md5 0 8FD6158BFE81ADD961241D8E4169D411
switch(config-router-ospf3)#show active
ipv6 router ospf 9
    area 0.0.0.0 authentication ipsec spi 34 md5 7 $1$cNpcrQ11cz
qdvKAZkLtYVr6I7+R3niuWouDKKYCFNs4/XOWG/Iap5Q==
switch(config-router-ospf3)#
```

- This command configures OSPFv3 authentication on an area with SHA1 algorithm.

```
switch(config)#ipv6 router ospf 9
switch(config-router-ospf3)#area 0.0.0.0 authentication ipsec spi 5789
sha1 passphrase 7 $1$Ab754G00HbG11IKq1C171yUKscUlpFTpvcQxQIhjJm1OUzGJD
h4bLWxSdKHvWm06
switch(config-router-ospf3)#show active
ipv6 router ospf 9
    area 0.0.0.0 authentication ipsec spi 5789 sha1 passphrase 7
Ab754G00HbG11IKq1C171yUKscUlpFTpvcQxQIhjJm1OUzGJDh4bLWxSdKHvWm06
switch(config-router-ospf3)#
```

- This command deletes the OSPFv3 authentication on an area.

```
switch(config)#ipv6 router ospf 9
switch(config-router-ospf3)#show active
ipv6 router ospf 9
    area 1.1.1.1 authentication ipsec spi 2437 md5 7 cNpcrQ11czqdv
KAZkLtYVr6I7+R3niuWouDKKYCFNs4/XOWG/Iap5Q==
    area 0.0.0.0 authentication ipsec spi 5789 sha1 passphrase 7
Ab754G00HbG11IKq1C171yUKscUlpFTpvcQxQIhjJm1OUzGJDh4bLWxSdKHvWm06
switch(config-router-ospf3)#no area 0.0.0.0 authentication
switch(config-router-ospf3)#show active
ipv6 router ospf 9
    area 1.1.1.1 authentication ipsec spi 2437 md5 7 cNpcrQ11czqdv
KAZkLtYVr6I7+R3niuWouDKKYCFNs4/XOWG/Iap5Q==
switch(config-router-ospf3)#
```

14.3.5.3 area default-cost (OSPFv3)

The `area default-cost` command sets the cost for the default summary routes sent into an area. When the `area default-cost` command is not configured for an area, the default-cost of that area is set to 10.

The `no area default-cost` and `default area default-cost` command resets the default-cost value of the specified area to 10 by removing the corresponding `area default-cost` command from *running-config*. The `no area (OSPFv3)` command removes all area commands for the specified area from *running-config*, including the `area default-cost` command.

Command Mode

Router-OSPFv3 Configuration

Command Syntax

```
area area_id default-cost def_cost
no area area_id default-cost
default area area_id default-cost
```

Parameters

- *area_id* area number. <0 to 4294967295> or <0.0.0.0 to 255.255.255.255> *Running-config* stores value in dotted decimal notation.
- *def_cost* Values range from 1 to 65535.

Example

These commands configure a cost of 15 for default summary routes that an ABR sends into area 100.

```
switch(config)#ipv6 router ospf 9
switch(config-router-ospf3)#area 100 default 15
switch(config-router-ospf3)#show active
ipv6 router ospf 9
  area 0.0.0.100 default-cost 15
switch(config-router-ospf3)#
```

14.3.5.4 area encryption ipsec spi

The `area encryption ipsec spi` command configures OSPFv3 security on an area.

The `default area encryption` and `no area encryption` commands delete the OSPFv3 security on an area.

Command Mode

Router-OSPFv3 Configuration

Command Syntax

```
area area_id encryption ipsec spi spi_value esp{3des-cbc| aes-128-cbc | aes-192-cbc
| aes-256-cbc}{ 0 unencrypted_key | 7 encrypted_key}{ md5| sha1}{ 0 unencrypted_key | 7
encrypted_key | KEY}
```

```
area area_id encryption ipsec spi spi_value esp null{md5 | sha1} { 0 unencrypted_key | 7
encrypted_key | KEY}
```

```
area area_id encryption ipsec spi spi_value esp{3des-cbc | aes-128-cbc | aes-192-cbc |
aes-256-cbc | null} {md5 | sha1} { 0 unencrypted_key | 7 encrypted_key | LINE}
```

```
no area area_id encryption
```

```
default area area_id encryption
```

Parameters

- `area area_id` configures OSPF area ID in either IP address or decimal formats. The value for decimal format ranges from 0 to 4294967295.
- `spi spi_value` configures the value for IPsec Security Parameter Index. The value ranges from 0 to 4294967295.
- `3des-cbc` configures ESP with 3DES-CBC encryption.
- `aes-128-cbc` configures ESP with AES-128-CBC encryption.
- `aes-192-cbc` configures ESP with AES-192-CBC encryption.
- `aes-256-cbc` configures ESP with AES-256-CBC encryption.
- `null` configures ESP with null encryption.
- `0 unencrypted_key` configures either a 192 bit 3DES key or 128/192/256 bit AES key in an unencrypted format.
- `7 encrypted_key` configures either a 192 bit 3DES key or 128/192/256 bit AES key in an encrypted format.
- `KEY` configures either a 128 bit MD5 key or a 140 bit SHA1 key.
- `md5` configures HMAC-MD5 hash algorithm.
- `sha1` configures HMAC-SHA1 algorithm.
- `passphrase` configures passphrase for authentication and encryption. Options include:
 - `0 unencrypted_passphrase` configures an unencrypted key.
 - `7 encrypted_passphrase` configures an encrypted key.
 - `LINE` uses passphrase string to derive keys for authentication and encryption.

Related Commands

- [area authentication ipsec spi](#)
- [ospfv3 encryption ipsec spi](#)

Guidelines

Passphrase and **key** values are exclusive. **MD5** and **SHA1** keys are derived from the configured passphrase.

Restriction

On the same area, EOS allows security configuration with either AH or ESP but not both. We can have one area configured with AH and another with ESP.

Examples

- This command configures OSPFv3 security on an area with 3DES-CBC encryption and MD5 hash algorithm.

```
switch(config)#ipv6 router ospf 9
switch(config-router-ospf3)#area 0.0.0.0 encryption ipsec spi 5678 esp
3des-cbc md5 passphrase 0
8FD6158BFE81ADD961241D8E4169D411
switch(config-router-ospf3)#show active
ipv6 router ospf 9
  area 0.0.0.0 encryption ipsec spi 5678 esp 3des-cbc md5 passphrase
  7
  $1$cNpcrQ11czqdvKazKLtYVr6I7+R3niuWouDKKYCFNs4/XOWG/Iap5Q==
switch (config-router-ospf3)#
```

- This command deletes the OSPFv3 security on an area.

```
switch(config)#ipv6 router ospf 9
switch(config-router-ospf3)#show active
ipv6 router ospf 9
  area 0.0.0.0 encryption ipsec spi 5678 esp 3des-cbc md5 passphrase
  7
  $1$cNpcrQ11czqdvKazKLtYVr6I7+R3niuWouDKKYCFNs4/XOWG/Iap5Q==
switch(config-router-ospf3)#no area 0.0.0.0 encryption
switch(config-router-ospf3)#show active
ipv6 router ospf 9
switch(config-router-ospf3)#
```

14.3.5.5 area not-so-stubby lsa type-7 convert type-5 (OSPFv3)

The `area not-so-stubby lsa type-7 convert type-5` command configures the switch to always translate Type-7 link-state advertisement (LSAs) to Type-5 LSAs.

The `no area not-so-stubby lsa type-7 convert type-5` and `no area not-so-stubby lsa type-7 convert type-5` commands allow LSAs to be translated dynamically by removing the `no area not-so-stubby lsa type-7 convert type-5` command from **running-config**.

Command Mode

Router-OSPFv3 Configuration

Command Syntax

```
area area_id not-so-stubby lsa type-7 convert type-5
```

```
no area area_id not-so-stubby lsa type-7 convert type-5
```

```
default area area_id not-so-stubby lsa type-7 convert type-5
```

Parameters

- *area_id*
 - Valid formats: integer <1 to **4294967295**> or dotted decimal <**0.0.0.1** to **255.255.255.255**>
 - Area 0 (or 0.0.0.0) is not configurable; it is always normal.
 - **Running-config** stores value in dotted decimal notation.

Example

These commands configure the switch to always translate Type-7 link-state advertisement (LSAs) to Type-5 LSAs.

```
switch(config)#ipv6 router ospf 3  
switch(config-router-ospf3)#area 3 not-so-stubby lsa type-7 convert  
type-5  
switch(config-router-ospf)#
```

14.3.5.6 area nssa (OSPFv3)

The **area nssa** command configures an OSPFv3 area as a not-so-stubby area (NSSA). All routers in an AS must specify the same area type for identically numbered areas.

NSSA ASBRs advertise external LSAs that are part of the area, but do not advertise external LSAs from other areas.

Areas are **normal** by default; area type configuration is required only for stub NSSA areas. Area 0 is always a normal area and cannot be configured through this command.

The **no area nssa** command configures the specified area as a normal area by removing the specified **area nssa** command from **running-config**.

Command Mode

Router-OSPFv3 Configuration

Command Syntax

```
area area_id nssa[TYPE]
```

```
no area area_id nssa[TYPE]
```

```
default area area_id nssa[TYPE]
```

Parameters

- *area_id*
 - Valid formats: integer <1 to **4294967295**> or dotted decimal <**0.0.0.1** to **255.255.255.255**>
 - Area 0 (or 0.0.0.0) is not configurable; it is always normal.
 - **Running-config** stores value in dotted decimal notation.
- TYPE

Values include:

- <no parameter>
- **nssa-only**

Example

This command configures area 3 as a NSSA area.

```
switch(config)#ipv6 router ospf 1  
switch(config-router-ospf3)#area 3 nssa nssa-only  
switch(config-router-ospf3)#
```

14.3.5.7 area nssa default-information-originate (OSPFv3)

The `area nssa default-information-originate` command sets an area as an NSSA and the generation of a type 7 default LSA is created if a default route exists in the routing table.

The switch supports three area types:

Areas are **normal** by default; area type configuration is required only for stub NSSA areas. Area 0 is always a normal area and cannot be configured through this command.

The `no area` and `default area` commands remove the specified area from the OSPFv3 instance by deleting all `area` commands from *running-config* for the specified area, including the `area default-cost (OSPFv3)` command.

The `no area stub` and `default area stub` commands configure the specified area as a normal area.

Command Mode

Router-OSPFv3 Configuration

Command Syntax

```
area area_id nssa default-information-originate [VALUE][TYPE][EXCL]
no area area_id nssa default-information-originate [VALUE][TYPE][EXCL]
default area area_id nssa default-information-originate [VALUE][TYPE][EXCL]
```

Parameters

All parameters except *area_id* can be placed in any order.

- *area_id*
 - Valid formats: integer <1 to 4294967295> or dotted decimal <0.0.0.1 to 255.255.255.255>
 - Area 0 (or 0.0.0.0) is not configurable; it is always normal.
 - *Running-config* stores value in dotted decimal notation.
- VALUE Values include:
 - <no parameter>
 - **metric** <1-65535>
- TYPE Values include:
 - <no parameter>
 - **metric-type** <1-2>
- EXCL Values include:
 - <no parameter>
 - **nssa-only**

Examples

- These commands sets area 1 as NSSA only and generates a type 7 default LSA if a default route exists in the routing table.

```
switch(config-router-ospf3)#area 3 nssa default-information-originate
nssa-only
switch(config-router-ospf3)#
```

- These commands generates a type 7 default route.

```
switch(config-router-ospf3)#area 3 nssa default-information-originate
switch(config-router-ospf3)#
```

14.3.5.8 area range (OSPFv3)

The **area range** command is used by OSPFv3 area border routers to summarize routes.

The **no area range** and **default area range** commands remove the area-range by deleting the corresponding **area range** command from *running-config*.

Command Mode

Router-OSPFv3 Configuration

Command Syntax

```
area area_id range net_addr [ADVERTISE_SETTING] [COST_SETTING]
```

```
no area area_id range net_addr [ADVERTISE_SETTING] [COST_SETTING]
```

```
default area area_id range net_addr [ADVERTISE_SETTING] [COST_SETTING]
```

Parameters

- *area_id* <0 to 4294967295> or <0.0.0.0 to 255.255.255.255>
- *net_addr*
- ADVERTISE_SETTING specifies the LSA advertising activity. Values include
 - <no parameter>
 - **advertise**
 - **not-advertise**
- COST_SETTING Values include
 - <no parameter>
 - **cost** *range_cost* Value ranges from 1 to 65535.

Examples

- These commands summarize routes at an area boundary 1.

```
switch(config)#ipv6 router ospf 1  
switch(config-router-ospf3)#area 1 range 2001:0DB8:0:1::/64  
switch(config-router-ospf3)#
```

- These commands modify the address range status to DoNotAdvertise.

```
switch(config)#ipv6 router ospf 1  
switch(config-ospf6-router)#area 1 range 2001:0DB8:0:1::/64 not-  
advertise  
switch(config-ospf6-router)#
```

14.3.5.9 area stub (OSPFv3)

The **area stub** command configures the area type of an OSPFv3 area.

Areas are **normal** by default;.

The **no area stub** command configures the specified area as a normal area.

Command Mode

Router-OSPFv3 Configuration

Command Syntax

```
area area_id stub
```

```
no area area_id stub
```

```
default area area_id stub
```

Parameters

- *area_id*
 - Valid formats: integer <1 to **4294967295**> or dotted decimal <**0.0.0.1** to **255.255.255.255**>
 - Area 0 (or 0.0.0.0) is not configurable; it is always **normal**.
 - **Running-config** stores value in dotted decimal notation.

Examples

- This command configures area 45 as a stub area.

```
switch(config)#ipv6 router ospf 3  
switch(config-router-ospf3)#area 45 stub  
switch(config-router-ospf3)#
```

- This command configures area 10.92.148.17 as a stub area.

```
switch(config-router-ospf3)#area 10.92.148.17 stub  
switch(config-router-ospf3)#
```

14.3.5.10 clear ospfv3 ipv6 force-spf

The `clear ospfv3 ipv6 force-spf` command starts the SPF algorithm without clearing the OSPF database.

Command Mode

Privileged EXEC

Command Syntax

```
clear ospfv3 ipv6 force-spf [VRF_INSTANCE]
```

Parameters

- VRF_INSTANCE Values include:
 - *<no parameter>* Action is performed in the default VRF.
 - *vrf vrf_name* Action is performed in the specified VRF.

Example

This command restarts the SPF algorithm in the default VRF without first clearing the OSPFv3 database.

```
switch(config)#clear ospfv3 ipv6 force-spf  
switch(config)#
```

14.3.5.11 default-information originate (OSPFv3)

The **default-information originate** command generates a default external route into an OSPF domain.

The **no default-information originate** and **default default-information originate** command removes the configuration from the *running-config*.

Command Mode

Router-OSPFv3 Configuration

Command Syntax

```
default-information originate [DURATION][VALUE][TYPE][MAP]
```

```
no default-information originate
```

```
default default-information originate
```

Parameters

All parameters can be placed in any order.

- DURATION Values include:
 - *<no parameter>*
 - always
- VALUE Values include:
 - *<no parameter>*
 - metric <1-65535>
- TYPE Values include:
 - *<no parameter>*
 - metric-type <1-2>
- MAP Values include:
 - *<no parameter>*
 - route-map *map_name*

Examples

- These commands will advertise the OSPFv3 default route regardless of whether the switch has a default route configured.

```
switch(config)#ipv6 router ospf 1
switch(config-router-ospf3)#default-information originate always
switch(config-router-ospf3)#show active
ipv6 router ospf 1
    default-information originate always
```

- These commands configures OSPF area 1 as metric of 100 for the default route with an external metric type of Type 1.

```
switch(config)#ipv6 router ospf 1
switch(config-router-ospf3)#default-information originate metric 100
metric-type 1
switch(config-router-ospf3)#show active
ipv6 router ospf 1
    default-information originate metric 100 metric-type 1
switch(config-router-ospf3)#
```

14.3.5.12 default-metric (OSPFv3)

The **default-metric** command sets default metric value for routes redistributed into the OSPFv3 domain.

The **no default-metric** and **default default-metric** commands restores the default metric to its default value of 10 by removing the **default-metric** command from **running-config**.

Command Mode

Router-OSPFv3 Configuration

Command Syntax

```
default-metric def_metric
```

```
no default-metric
```

```
default default-metric
```

Parameter

def_metric Values range from 1 to 65535. Default value is 10.

Example

These commands configure a default metric of 30 for routes redistributed into OSPFv3.

```
switch(config)#ipv6 router ospf 9
switch(config-router-ospf3)#default-metric 30
switch(config-router-ospf3)#show active
ipv6 router ospf 9
    default-metric 30
switch(config-router-ospf3)#
```

14.3.5.13 distance ospf intra-area (OSPFv3)

The **distance ospf intra-area** command sets the administrative distance for routes in a single OSPFv3 area. The default is 110.

The **no distance ospf intra-area** and **default distance ospf intra-area** commands remove the **distance ospf intra-area** command from **running-config**, returning the OSPFv3 intra-area distance setting to the default value of 110.

Command Mode

Router-OSPFv3 Configuration

Command Syntax

```
distance ospf intra-area distance
no distance ospf intra-area
default distance ospf intra-area
```

Parameter

distance Values range from 1 to 255. Default is 110.

Example

This command configures a distance of 90 for all OSPFv3 intra-area routes on the switch.

```
switch(config)#ipv6 router ospf 9
switch(config-router-ospf3)#distance ospf intra-area 90
switch(config-router-ospf3)#show active
ipv6 router ospf 9
    distance ospf intra-area 90
switch(config-router-ospf3)#
```

14.3.5.14 ipv6 ospf area

The `ipv6 ospf area` command enables OSPFv3 on the interface and associates the area to the interface.

OSPFv3 areas are configured in by `no area (OSPFv3)` commands in router-OSPFv3 configuration mode

The `no ipv6 ospf area` and `default ipv6 ospf area` commands disable OSPFv3 on the configuration mode interface by removing the corresponding `ipv6 ospf area` command from **running-config**.

Command Mode

Interface-Ethernet Configuration

Interface-Loopback Configuration

Interface-Port-Channel Configuration

Interface-VLAN Configuration

Command Syntax

```
ipv6 ospf process_id [area area_id]
```

```
no ipv6 ospf process_id [area area_id]
```

```
default ipv6 ospf process_id [area area_id]
```

Parameters

- *process_id* Values range from 1 to 65535.
- *area_id*
 - Valid formats: integer <0 to 4294967295> or dotted decimal <0.0.0.0 to 255.255.255.255>
 - **Running-config** stores value in dotted decimal notation.

Example

These commands enable OSPFv3 on VLAN interface 200 and associates area 0 to the interface.

```
switch(config)#interface vlan 200
switch(config-if-Vl200)#ipv6 ospf 9 area 0
switch(config-if-Vl200)#show active
interface Vlan200
    ipv6 ospf 9 area 0.0.0.0
switch(config-if-Vl200)#
```

14.3.5.15 ipv6 router ospf

The `ipv6 router ospf` command places the switch in router-OSPFv3 configuration mode and creates an OSPFv3 instance if one does not already exist. Note that each OSPFv3 instance on the switch must have a unique process ID. A router ID for the new instance will be created if one does not already exist.

The `show ipv6 ospf` command displays the router ID of each OSPFv3 instance configured on the switch.

The `no ipv6 router ospf` and `default ipv6 router ospf` command deletes the OSPFv3 instance.

Refer to the [Router-OSPFv3 Configuration Mode](#) command for a list of commands available in router-OSPFv3 configuration mode.

Command Mode

Global Configuration

Command Syntax

```
ipv6 router ospf process_id [VRF_INSTANCE]
no ipv6 router ospf process_id [VRF_INSTANCE]
default ipv6 router ospf process_id [VRF_INSTANCE]
```

Parameters

- *process_id* Values range from 1 to 65535.
- VRF_INSTANCE Values include:
 - *<no parameter>* OSPF instance is in the default VRF.
 - *vrf vrf_name* OSPF instance is the specified VRF.

Examples

- This command creates an OSPFv3 instance in the default VRF with process ID 9.

```
switch(config)#ipv6 router ospf 9
switch(config-router-ospf3)#show active
ipv6 router ospf 9
switch(config-router-ospf3)#
```

- This command deletes the OSPFv3 instance.

```
switch(config)#no ipv6 router ospf 9
switch(config)#
```

14.3.5.16 log-adjacency-changes (OSPFv3)

The **log-adjacency-changes** command enables syslog messages to be sent when it detects OSPFv3 link state changes or when it detects that a neighbor has gone up or down. Log message sending is enabled by default.

The **default log-adjacency-changes** command restores the default state by removing the **log-adjacency-changes** statement from **running-config**.

The default option (sending a message only when a neighbor goes up or down) is active when **running-config** does not contain any form of the command. Entering the command in any form replaces the previous command state in **running-config**.

The **no log-adjacency-changes** disables link state change syslog reporting.

The **default log-adjacency-changes** command restores the default state by removing the **log-adjacency-changes detail** or **no log-adjacency-changes** statement from **running-config**.

Command Mode

Router-OSPFv3 Configuration

Command Syntax

```
log-adjacency-changes [INFO_LEVEL]
```

```
no log-adjacency-changes
```

```
default log-adjacency-changes
```

Parameters

- INFO_LEVEL Options include
 - *<no parameter>* Sends messages when a neighbor goes up or down.
 - **detail** Sends messages for all neighbor state changes.

Example

This command configures the switch to send a syslog message when a neighbor state changes.

```
switch(config)#ipv6 router ospf 9
switch(config-router-ospf3)#log-adjacency-changes
switch(config-router-ospf3)#show active
ipv6 router ospf 9
    log-adjacency-changes
switch(config-router-ospf3)#
```

14.3.5.17 maximum-paths (OSPFv3)

The **maximum-paths** command sets the maximum number of parallel routes that OSPFv3 supports on the switch.

The **no maximum-paths** command restores the maximum number of parallel routes that OSPFv3 supports on the switch to the default value of 16 by removing the maximum-paths command from **running-config**.

Command Mode

Router-OSPFv3 Configuration

Command Syntax

```
maximum-paths paths
```

```
no maximum-paths
```

```
default maximum-paths
```

Parameters

- *paths* Value range is platform dependent:
 - Arad: Value ranges from 1 to 128. Default value is 128.
 - FM6000: Value ranges from 1 to 32. Default value is 32.
 - PetraA: Value ranges from 1 to 16. Default value is 16.
 - Trident: Value ranges from 1 to 32. Default value is 32.
 - Trident II: Value ranges from 1 to 128. Default value is 128.

Example

This command configures the maximum number of OSPFv3 parallel paths to 12.

```
switch(config)#ipv6 router ospf 9  
switch(config-router-ospf3)#maximum-paths 12  
switch(config-router-ospf3)#
```

14.3.5.18 max-metric router-lsa (OSPFv3)

The **max-metric router-lsa** command configures OSPF to include the maximum value in LSA metric fields to keep other network devices from using the switch as a preferred intermediate SPF hop.

The **no max-metric router-lsa** and **default max-metric router-lsa** commands disable the advertisement of a maximum metric.

Command Mode

Router-OSPFv3 Configuration

Command Syntax

```
max-metric router-lsa[EXTERNAL][STUB][STARTUP][SUMMARY]
no max-metric router-lsa[EXTERNAL][STUB][STARTUP][SUMMARY]
default max-metric router-lsa[EXTERNAL][STUB][STARTUP][SUMMARY]
```

Parameters

All parameters can be placed in any order.

- EXTERNAL Values include:
 - *<no parameter>* Default value of 1.
 - external-lsa
 - external-lsa <1 to 16777215> The default value is 0xFF0000.
- STUB Values include:
 - *<no parameter>* Default value of 2.
 - include-stub
- STARTUP Values include:
 - *<no parameter>*
 - on-startup
 - on-startup wait-for-bgp
 - on-startup <5 to 86400>

wait-for-bgp or an **on-start** time value is not included in **no** and **default** commands.

- SUMMARY Values include:
 - *<no parameter>* Metric is set to the default value of 1.
 - summary-lsa
 - summary-lsa <1 to 16777215>

Example

This command configures OSPFv3 to include the maximum value in LSA metric fields until BGP has converged:

```
switch(config-router-ospf3) #max-metric router-lsa on-startup wait-for-bgp
switch(config-router-ospf3) #
```

14.3.5.19 no area (OSPFv3)

The no **area** command removes all area configuration commands for the specified OSPFv3 area. Commands removed by the no area command include:

- area
- nssa
- range
- stub

Area settings can be removed individually; refer to the command description page of the desired command for details.

Command Mode

Router-OSPFv3 Configuration

Command Syntax

```
no area area_id[TYPE]
```

```
default area area_id[TYPE]
```

Parameters

- *area_id* area number.
 - Valid formats: integer <1 to **4294967295**> or dotted decimal <**0.0.0.1** to **255.255.255.255**>
 - Area 0 (or 0.0.0.0) is not configurable; it is always **normal**.
 - **Running-config** stores value in dotted decimal notation.
- *TYPE* area type. Values include:
 - nssa
 - nssa translate type7 always
 - stub
 - stub no-summary

Example

This command remove the area 1 stub configuration.

```
switch(config)#ipv6 router ospf 9  
switch(config-router-ospf3)#no area 1 stub  
switch(config-router-ospf3)#
```

14.3.5.20 ospfv3 transmit-delay

The `ospfv3 transmit-delay` command configures the transmission delay for OSPFv3 packets.

The `no ospfv3 transmit-delay` and `default ospfv3 transmit-delay` commands restore the default transmission delay of one second on the configuration mode interface by removing the corresponding `ospfv3 transmit-delay` command from *running-config*.

Command Mode

Interface-Ethernet Configuration

Interface-Loopback Configuration

Interface-Port-Channel Configuration

Interface-VLAN Configuration

Command Syntax

```
ospfv3 transmit-delay trans
```

```
no ospfv3 transmit-delay
```

```
default ospfv3 transmit-delay
```

Parameter

trans Value ranges from 1 to 65535; default is 1.

Guideline

Arista devices also support the legacy `ipv6 ospf transmit-delay` command in certain software releases of the EOS.

Example

This command configures a transmission delay of 10 seconds for VLAN 200.

```
switch(config)#interface vlan 200
switch(config-if-Vl200)#ospfv3 transmit-delay 10
switch(config-if-Vl200)#show active
interface Vlan200
    ospfv3 transmit-delay 10
switch(config-if-Vl200)#
```

14.3.5.21 ospfv3 authentication ipsec spi

The `ospfv3 authentication ipsec spi` command configures OSPFv3 authentication on an interface.

The `default ospfv3 authentication` and `no ospfv3 authentication` commands delete the OSPFv3 authentication on an interface.

Command Mode

Interface-Ethernet Configuration

Command Syntax

```
ospfv3 authentication ipsec spi spi_value {md5 | sha1}{0 unencrypted_key | 7 hidden_key | KEY}
```

```
ospfv3 authentication ipsec spi spi_value {md5 | sha1} passphrase{ 0 unencrypted_passphrase | 7 hidden_passphrase | LINE}
```

```
no ospfv3 authentication
```

```
default ospfv3 authentication
```

Parameters

- `spi spi_value` configures IPsec Security Parameter Index. The value ranges from 0 to 4294967295.
- `md5` configures HMAC-MD5 hash algorithm.
- `sha1` configures HMAC-SHA1 algorithm.
- `0 unencrypted_key` configures either a 192 bit 3DES key or 128/192/256 bit AES key in an unencrypted format.
- `7 encrypted_key` configures either a 192 bit 3DES key or 128/192/256 bit AES key in an encrypted format.
- `KEY` configures either a 128 bit MD5 key or a 140 bit SHA1 key.
- `passphrase` configures passphrase for authentication and encryption. Options include:
 - `0 unencrypted_passphrase` configures an unencrypted passphrase.
 - `7 encrypted_passphrase` configures an encrypted passphrase.
 - `LINE` uses passphrase string to derive keys for authentication and encryption.

Related Commands

- [area authentication ipsec spi](#)
- [ospfv3 encryption ipsec spi](#)

Guidelines

Passphrase and **key** values are exclusive. **MD5** and **SHA1** keys are derived from the configured passphrase. Arista devices also support the legacy `ipv6 ospf authentication ipsec spi` command in certain software releases of the EOS.

Restriction

On the same interface, EOS allows security configuration with either AH or ESP but not both. We can have one interface configured with AH and another with ESP.

Examples

- This command configures OSPFv3 authentication on an interface with MD5 hash algorithm.

```
switch(config)#interface ethernet 9
switch(config-if-Et9)#ospfv3 authentication ipsec spi 3456 md5 0
8FD6158BFE81ADD961241D8E4169D411
switch(config-if-Et9)#show active
interface Ethernet9
```

```
no switchport
ospfv3 authentication ipsec spi 3456 md5 7 $1$xtmcMSPzEn+Njp8Lb4qryVV
OjKcjsrYuv6dx10+nSwKQdaiRt2RPTQ==
switch(config-if-Et9)#
```

- This command configures OSPFv3 authentication on an interface with SHA1 algorithm.

```
switch(config)#interface ethernet 9
switch(config-if-Et9)#ospfv3 authentication ipsec spi 987 sha1 7
$1$VmUkWk6IL2S343bR3BbH0RhgvxHhwBpfvB4VXKNOOQF7HJBp5VvXTfBaVYbgCkWU
switch(config-if-Et9)#show active
interface Ethernet9
no switchport
ospfv3 authentication ipsec spi 987 sha1 7
$1$VmUkWk6IL2S343bR3BbH0RhgvxHhwBpfvB4VXKNOOQF7HJBp5VvXTfBaVYbgCkWU
switch(config-if-Et9)#
```

- This command deletes the OSPFv3 authentication on an interface.

```
switch(config)#interface ethernet 9
switch(config-if-Et9)#show active
interface Ethernet9
no switchport
ospfv3 authentication ipsec spi 3456 md5 7 $1$xtmcMSPzEn+Njp8Lb4qryVV
OjKcjsrYuv6dx10+nSwKQdaiRt2RPTQ==
switch(config-if-Et9)#no ospfv3 authentication
switch(config-if-Et9)#show active
interface Ethernet9
no switchport
switch(config-if-Et9)#
```

14.3.5.22 ospfv3 cost

The `ospfv3 cost` command sets the OSPFv3 cost for the interface. The default OSPFv3 cost is 10.

The `no ospfv3 cost` and `default ospfv3 cost` commands restore the default cost of 10 for the configuration mode interface by removing the corresponding `ospfv3 cost` command from **running-config**.

Command Mode

Interface-Ethernet Configuration

Interface-Loopback Configuration

Interface-Port-Channel Configuration

Interface-VLAN Configuration

Command Syntax

```
ospfv3 cost interface_cost
```

```
no ospfv3 cost
```

```
default ospfv3 cost
```

Parameters

interface_cost Value ranges from 1 to 65535; default is 10.

Guideline

Arista devices also support the legacy `ipv6 ospf cost` command in certain software releases of the EOS.

Example

This command configures a cost of 50 for VLAN 200.

```
switch(config)#interface vlan 200
switch(config-if-Vl200)#ospfv3 cost 50
switch(config-if-Vl200)#show active
interface Vlan200
    ospfv3 cost 50
switch(config-if-Vl200)#
```

14.3.5.23 ospfv3 dead-interval

The `ospfv3 dead-interval` command sets the OSPFv3 dead interval.

The `no ospfv3 dead-interval` and `default ospfv3 dead-interval` commands restore the default dead interval of 40 seconds on the configuration mode interface by removing the corresponding `ospfv3 dead-interval` command from *running-config*.

Command Mode

Interface-Ethernet Configuration

Interface-Loopback Configuration

Interface-Port-Channel Configuration

Interface-VLAN Configuration

Command Syntax

```
ospfv3 dead-interval time
```

```
no ospfv3 dead-interval
```

```
default ospfv3 dead-interval
```

Parameters

- *time* Value ranges from 1 to 65535; default is 40.

Guideline

Arista devices also support the legacy `ipv6 ospf dead-interval` command in certain software releases of the EOS.

Example

This command configures a dead interval of 75 seconds for VLAN 200.

```
switch(config)#interface vlan 200
switch(config-if-Vl200)#ospfv3 dead-interval 75
switch(config-if-Vl200)#show active
interface Vlan200
    ospfv3 dead-interval 75
switch(config-if-Vl200)#
```

14.3.5.24 ospfv3 encryption ipsec spi

The `ospfv3 encryption ipsec spi` command configures OSPFv3 security on an interface.

The `default ospfv3 encryption` and `no ospfv3 encryption` commands delete the OSPFv3 security on an interface.

Command Mode

Interface-Ethernet Configuration

Command Syntax

```
ospfv3 encryption ipsec spi spi_value esp {3des-cbc | aes-128-cbc | aes-128-cbc | aes-192-cbc} { 0unencrypted_key | 7 encrypted_key } { md5 | sha1 } { 0unencrypted_key | 7 encrypted_key | KEY }
```

```
ospfv3 encryption ipsec spi spi_value esp {3des-cbc | aes-128-cbc | aes-128-cbc | aes-192-cbc} { 0unencrypted_key | 7 encrypted_key } { md5 | sha1 } passphrase { 0unencrypted_passphrase | 7 encrypted_passphrase | LINE }
```

```
ospfv3 encryption ipsec spi spi_value esp null {md5 | sha1} { 0unencrypted_key | 7 encrypted_key | KEY }
```

```
ospfv3 encryption ipsec spi spi_value esp {md5 | sha1} passphrase { 0unencrypted_passphrase | 7 encrypted_passphrase | LINE }
```

```
default ospfv3 encryption
```

```
no ospfv3 encryption
```

Parameters

- `spi spi_value` configures the value for IPsec Security Parameter Index. The value ranges from 0 to 4294967295.
- `3des-cbc` configures ESP with 3DES-CBC encryption.
- `aes-128-cbc` configures ESP with AES-128-CBC encryption.
- `aes-192-cbc` configures ESP with AES-192-CBC encryption.
- `aes-256-cbc` configures ESP with AES-256-CBC encryption.
- `null` configures ESP with null encryption.
- `0 unencrypted_key` configures either a 192 bit 3DES key or 128/192/256 bit AES key in an unencrypted format.
- `7 encrypted_key` configures either a 192 bit 3DES key or 128/192/256 bit AES key in an encrypted format.
- `md5` configures HMAC-MD5 hash algorithm.
- `sha1` configures HMAC-SHA1 algorithm.
- `KEY` configures either a 128 bit MD5 key or a 140 bit SHA1 key.
- `passphrase` configures passphrase for authentication and encryption. Options include:
 - `0 unencrypted_passphrase` configures an unencrypted passphrase.
 - `7 encrypted_passphrase` configures an encrypted passphrase.
 - `LINE` uses passphrase string to derive keys for authentication and encryption.

Related Commands

- [area encryption ipsec spi](#)
- [ospfv3 authentication ipsec spi](#)

Guidelines

Passphrase and key value are exclusive. MD5 and SHA1 keys are derived from the configured passphrase. Arista devices also support the legacy `ipv6 ospf encryption ipsec spi` command in certain software releases of the EOS.

Restrictions

On the same interface, EOS allows security configuration with either AH or ESP but not both. We can have one interface configured with AH and another with ESP.

Examples

- This command configures OSPFv3 security on an interface with 3DES-CBC encryption and SHA1 algorithm.

```
switch(config)#interface ethernet 9
switch(config-if-Et9)#ospfv3 encryption ipsec spi 345 esp 3des-cbc sha1
passphrase 0 2fd4e1c67a2d28fced849ee1bb76e7391b93eb12
switch(config-if-Et9)#show active
interface Ethernet9
  no switchport
  ospfv3 encryption ipsec spi 345 esp 3des-cbc sha1 passphrase 7
  $1$VmUkWk6IL2S343bR3BbH0RhgvxHhwBpfvB4VXKNOOQF7HJBp5VvXTfBaVYbgCkWU
switch(config-if-Et9)#
```

- This command configures OSPFv3 security on an interface with 3DES-CBC encryption and MD5 hash algorithm.

```
switch(config)#interface ethernet 9
switch(config-if-Et9)#ospfv3 encryption ipsec spi 345 esp 3des-cbc md5
passphrase 7 $1$VmUkWk6IL2S343bR3BbH0RhgvxHhwBpfvB4VXKNOOQF7HJBp5
VvXTfBaVYbgCkWU
switch(config-if-Et9)#show active
interface Ethernet9
  no switchport
  ospfv3 encryption ipsec spi 345 esp 3des-cbc md5 passphrase 7
  $1$VmUkWk6IL2S343bR3BbH0RhgvxHhwBpfvB4VXKNOOQF7HJBp5VvXTfBaVYbgCkWU
switch(config-if-Et9)#
```

- This command deletes the OSPFv3 security on an interface.

```
switch(config)#interface ethernet 9
switch(config-if-Et9)#show active
interface Ethernet9
  no switchport
  ospfv3 encryption ipsec spi 3456 md5 7 $1$xtmcMSPzEn+Njp8Lb4qryVV
  OjKcjsrYuv6dxl0+nSwKQdaiRt2RPTQ==
switch(config-if-Et9)#no ospfv3 encryption
switch(config-if-Et9)#show active
interface Ethernet9
  no switchport
switch(config-if-Et9)#
```

14.3.5.25 ospfv3 hello-interval

The **ospfv3 hello-interval** command sets the OSPFv3 hello interval. The hello interval is the period between the transmission of consecutive hello packets.

Each OSPFv3 neighbor should be the same hello interval and should not be longer than any neighbors dead interval.

The **no ospfv3 hello-interval** and **default ospfv3 hello-interval** commands restore the default hello interval of 10 seconds on the configuration mode interface by removing the **ospfv3 hello-interval** command from **running-config**.

Command Mode

Interface-Ethernet Configuration

Interface-Loopback Configuration

Interface-Port-Channel Configuration

Interface-VLAN Configuration

Command Syntax

```
ospfv3 hello-interval time
no ospfv3 hello-interval
default ospfv3 hello-interval
```

Parameter

time Values range from 1 to 65535; default is 10.

Guideline

Arista devices also support the legacy **ipv6 ospf hello-interval** command in certain software releases of the EOS.

Example

This command configures a hello interval of 45 seconds for VLAN 200.

```
switch(config)#interface vlan 200
switch(config-if-Vl200)#ospfv3 hello-interval 45
switch(config-if-Vl200)#show active
interface Vlan200
  ospfv3 hello-interval 45
switch(config-if-Vl200)#
```

14.3.5.26 ospfv3 ipv6 retransmit-interval

The `ospfv3 ipv6 retransmit-interval` command configures the link state advertisement retransmission interval.

The `no ospfv3 ipv6 retransmit-interval` and `default ospfv3 ipv6 retransmit-interval` commands restore the default retransmission interval of 5 seconds on the configuration mode interface by removing the corresponding `ospfv3 ipv6 retransmit-interval` command from *running-config*.

Command Mode

Interface-Ethernet Configuration

Interface-Loopback Configuration

Interface-Port-Channel Configuration

Interface-VLAN Configuration

Command Syntax

```
ospfv3 ipv6 retransmit-interval period
no ospfv3 ipv6 retransmit-interval
default ospfv3 ipv6 retransmit-interval
```

Parameter

period Value ranges from 1 to 65535; default is 5.

Example

This command configures a retransmission interval of 25 seconds for VLAN 200.

```
switch(config)#interface vlan 200
switch(config-if-Vl200)#ospfv3 ipv6 retransmit-interval 25
switch(config-if-Vl200)#show active
interface Vlan200
    ospfv3 ipv6 retransmit-interval 25
switch(config-if-Vl200)#
```

14.3.5.27 ospfv3 network

The **ospfv3 network** command sets the configuration mode interface as a point-to-point link. By default, interfaces are set as broadcast links.

The **no ospfv3 network** and **default ospfv3 network** commands set the configuration mode interface as a broadcast link by removing the corresponding **ospfv3 network** command from **running-config**.

Command Mode

Interface-Ethernet Configuration

Interface-Loopback Configuration

Interface-Port-Channel Configuration

Interface-VLAN Configuration

Command Syntax

```
ospfv3 network point-to-point
```

```
no ospfv3 network
```

```
default ospfv3 network
```

Guideline

Arista devices also support the legacy **ipv6 ospf network** command in certain software releases of the EOS.

Examples

- This command configures VLAN interface 200 as a point-to-point link.

```
switch(config)#interface vlan 200
switch(config-if-Vl200)#ospfv3 network point-to-point
switch(config-if-Vl200)#show active
interface Vlan200
    ospfv3 network point-to-point
switch(config-if-Vl200)#
```

- This command restores Ethernet interface 10 as a broadcast link.

```
switch(config)#interface vlan 200
switch(config-if-Vl200)#no ospfv3 network
switch(config-if-Vl200)#show active
interface Vlan200
switch(config-if-Vl200)#
```

14.3.5.28 ospfv3 priority

The `ospfv3 priority` command configures the OSPFv3 router priority.

The `no ospfv3 priority` and `default ospfv3 priority` commands restore the default priority (1) on the interface by removing the corresponding `ospfv3 priority` command from *running-config*.

Command Mode

Interface-Ethernet Configuration

Interface-Loopback Configuration

Interface-Port-Channel Configuration

Interface-VLAN Configuration

Command Syntax

```
ospfv3 priority priority_level
```

```
no ospfv3 priority
```

```
default ospfv3 priority
```

Parameter

priority_level Settings range from 0 to 255.

Guideline

Arista devices also support the legacy `ipv6 ospf priority` command in certain software releases of the EOS.

Example

This command configures a router priority of 128 for VLAN 200.

```
switch(config)#interface vlan 200
switch(config-if-Vl200)#ospfv3 priority 128
switch(config-if-Vl200)#show active
interface Vlan200
    ospfv3 priority 128
switch(config-if-Vl200)#
```

14.3.5.29 passive-interface (OSPFv3)

The **passive-interface** command disables OSPF on an interface range. All interfaces are active by default.

The **no passive-interface** and **default passive-interface** commands enable OSPFv3 on the specified interface range by removing the corresponding **passive-interface** statements from *running-config*.

Command Mode

Router-OSPFv3 Configuration

Command Syntax

```
passive-interface INTERFACE_NAME
no passive-interface INTERFACE_NAME
default passive-interface INTERFACE_NAME
```

Parameters

- INTERFACE_NAME Options include:
 - ethernet *e_range*
 - loopback *l_range*
 - management *m_range*
 - port-channel *p_range*
 - vlan *v_range*
 - vxlan *vx_range*
 - default

Valid *e_range*, *l_range*, *m_range*, *p_range*, *v_range*, and *vx_range* formats include number, range, or comma-delimited list of numbers and ranges.

Example

This command configures VLAN interfaces 101 through 103 as passive interfaces.

```
switch(config)#ipv6 router ospf 9
switch(config-router-ospf3)#passive-interface vlan 101-103
switch(config-router-ospf3)#show active
ipv6 router ospf 9
  passive-interface Vlan101
  passive-interface Vlan102
  passive-interface Vlan103
switch(config-router-ospf3)#
```

14.3.5.30 redistribute (OSPFv3)

The **redistribute** command enables the advertising of all specified routes into the OSPFv3 domain as external routes.

The **no redistribute** and **default redistribute** commands remove the corresponding **redistribute** command from *running-config*, disabling route redistribution for the specified route type.

Command Mode

Router-OSPFv3 Configuration

Command Syntax

```
[redistribute ROUTE_TYPE ROUTE_MAP]
```

```
no redistribute ROUTE_TYPE
```

```
default redistribute ROUTE_TYPE
```

Parameters

- ROUTE_TYPE Options include:
 - BGP
 - connected
 - static
- ROUTE_MAP Options include:
 - route-map *map_name*

Example

The **redistribute static** command starts the advertising of static routes as OSPFv3 external routes.

```
switch(config)#ipv6 router ospf 9
switch(config-router-ospf3)#redistribute static
switch(config-router-ospf3)#show active
ipv6 router ospf 9
    redistribute connected
    redistribute static
switch(config-router-ospf3)#
```

14.3.5.31 router-id (OSPFv3)

The **router-id** command assigns the router ID for an OSPFv3 instance. The switch sets the router ID to the first available alternative in the following list:

1. The **router-id** command
2. The loopback IP address
3. The highest IP address present on the device.



Note: When configuring VXLAN on an MLAG, always manually configure the OSPFv3 router ID to prevent the switch from using the common VTEP IP address as the router ID.

The **no router-id** and **default router-id** commands remove the router ID command from *running-config*.

Command Mode

Router-OSPFv3 Configuration

Command Syntax

```
router-id identifier
```

```
no router-id
```

```
default router-id
```

Parameters

identifier Value ranges from 0.0.0.0 to 255.255.255.255 (dotted decimal notation).

Example

This command assigns 10.10.1.4 as the router ID for the OSPFv3 instance.

```
switch(config)#ipv6 router ospf 9
switch(config-router-ospf3)#router-id 10.10.1.4
switch(config-router-ospf3)#show active
ipv6 router ospf 9
  router-id 15.10.1.4
switch(config-router-ospf3)#
```

14.3.5.32 show ipv6 ospf border-routers

The `show ipv6 ospf border-routers` command displays the OSPF routing table entries.

Command Mode

EXEC

Command Syntax

```
show ipv6 ospf border-routers [VRF_INSTANCE]
```

Parameters

- VRF_INSTANCE Values include:
 - `<no parameter>` Displays information for all VRFs.
 - `vrf vrf_name` Displays information for the specified VRF.

Example

This command displays the ABRs and ASBRs configured in the switch in all VRFs.

```
switch#show ipv6 ospf border-routers
Routing Process "ospf 9", VRF default
Router 10.37.0.32 area 0.0.0.0 ASBR
Router 10.37.0.18 area 0.0.0.0 ASBR
Router 10.37.0.22 area 0.0.0.0 ASBR ABR
Router 10.37.0.31 area 0.0.0.0 ASBR ABR
Router 10.37.0.58 area 0.0.0.0 ASBR
Router 10.37.0.37 area 0.0.0.0 ASBR
Router 10.37.0.22 area 0.0.0.2 ASBR ABR
Router 10.37.0.31 area 0.0.0.2 ASBR ABR
switch>
```

14.3.5.33 show ipv6 ospf database link if-name

The **show ipv6 ospf database link** command displays link state advertisement details. The switch can return link state data about a single area or for all areas on the switch.

Command Mode

EXEC

Command Syntax

```
show ipv6 ospf database link if-name[INTF_ID][LS_ID][ROUTER][ DATA_LEVEL]
```

Parameters

- INTF_ID Options include:
 - ethernet *e_range* Ethernet interface list.
 - loopback *l_range* Loopback interface list.
 - management *m_range* Management interface list.
 - port-channel *p_range* Channel group interface list.
 - vlan *v_range* VLAN interface list.
 - vxlan *vx_range* VXLAN interface list.

Valid *range* formats include number, range, or comma-delimited list of numbers and ranges.

- LS_ID Options include:
 - *<no parameter>*
 - *<A.B.C.D>*
- **ROUTER** Options include:
 - *<no parameter>*
 - adv-router [*a.b.c.d*]
 - self-originate
- DATA_LEVEL Options include:
 - *<no parameter>*
 - detail

Example

This command displays information for Ethernet 4/1 link state advertisements.

```
switch#show ipv6 ospf database link if-name ethernet 4/1
Codes: AEX - AS External, GRC - Grace,
       IAP - Inter Area Prefix, IAR - Inter Area Router,
       LNK - Link, NAP - Intra Area Prefix,
       NSA - Not So Stubby Area, NTW - Network,
       RTR - Router

Routing Process "ospf 1":

switch>
```

14.3.5.34 show ipv6 ospf database link if-type

The **show ipv6 ospf database link** command displays information of the link state advertisements. The switch can return link state data about a single area or for all areas on the switch.

Command Mode

EXEC

Command Syntax

```
show ipv6 ospf database link if-type [INTF_TYPE][LS_ID][ROUTER][DATA_LEVEL]
```

Parameters

- INTF_TYPE
 - broadcast
 - nbma
 - p2mp
 - p2p
- LS_ID Options include:
 - *<no parameter>*
 - *<A.B.C.D>*
- ROUTER Options include:
 - *<no parameter>*
 - *adv-router [a.b.c.d]*
 - *self-originate*
- DATA_LEVEL Options include:
 - *<no parameter>*
 - *detail*

Example

This command displays LSA information for the interfaces configured for broadcast transmissions.

```
switch#show ipv6 ospf database link if-type broadcast
Codes: AEX - AS External, GRC - Grace,
       IAP - Inter Area Prefix, IAR - Inter Area Router,
       LNK - Link, NAP - Intra Area Prefix,
       NSA - Not So Stubby Area, NTW - Network,
       RTR - Router

Routing Process "ospf 1":

  Interface et4 LSDB

Type          Link ID          ADV Router  Age          Seq#          Checksum
LNK           0.0.0.61         10.26.0.49  1378        0x80000027   0x00f8b0
LNK           0.0.0.20         10.26.0.23  1371        0x80000027   0x005423

  Interface et7 LSDB

Type          Link ID          ADV Router  Age          Seq#          Checksum
LNK           0.0.0.61         10.26.0.50  1298        0x80000028   0x005e0d
LNK           0.0.0.38         10.26.0.23  1291        0x80000028   0x00ce8d

  Interface vlan3901 LSDB

Type          Link ID          ADV Router  Age          Seq#          Checksum
LNK           0.0.0.36         10.26.0.22  216         0x800000b0   0x00c2b1
```



```
LNK      0.0.0.19      10.26.0.23231 0x8000000b0  0x00cfca  
switch>
```

14.3.5.35 show ipv6 ospf database <link state list>

The `show ipv6 ospf database <link state list>` command displays the OSPF link state advertisements that originate on a switch.

Command Mode

EXEC

Command Syntax

```
show ipv6 ospf database [FILTER][LINKSTATE_ID][ROUTER][DATA_LEVEL]
```

Parameters

- **FILTER** Filters the output of the command by specifying areas. Options include:
 - `<no parameter>`
 - `area <A.B.C.D>`
 - `area backbone`
 - `as`
 - `as external`
- **LINKSTATE_ID** Options include:
 - `<no parameter>`
 - `<A.B.C.D>`
- **ROUTER** Options include:
 - `<no parameter>`
 - `adv-router [a.b.c.d]`
 - `self-originate`
- **DATA_LEVEL** Options include:
 - `<no parameter>`
 - `detail`

Example

This command displays the OSPFv3 database of link state advertisements.

```
switch#show ipv6 ospf database 10.26.0.23
Codes: AEX - AS External, GRC - Grace,
       IAP - Inter Area Prefix, IAR - Inter Area Router,
       LNK - Link, NAP - Intra Area Prefix,
       NSA - Not So Stubby Area, NTW - Network,
       RTR - Router

Routing Process "ospf 9":

  AS Scope LSDB

Type          Link ID      ADV Router  Age      Seq#      Checksum
AEX           0.0.0.5      10.37.0.37  15       0x80000005 0x00be82
AEX           0.0.0.9      10.37.0.22  1747    0x8000002b 0x00df56
AEX           0.0.0.3      10.37.0.46  599     0x8000002d 0x00651d

Area 0.0.0.0 LSDB

Type          Link ID      ADV Router  Age      Seq#      Checksum
RTR           0.0.0.0      10.37.0.32  234     0x80000031 0x00585a
NTW           0.0.0.26     10.37.0.32  271     0x80000005 0x005609
NAP           0.0.0.26     10.37.0.32  274     0x80000005 0x00964c
```

```
Interface vlan3911 LSDB
```

Type	Link ID	ADV Router	Age	Seq#	Checksum
LNK	0.0.0.38	10.37.0.22	267	0x80000005	0x00a45a
LNK	0.0.0.23	10.37.0.23	270	0x8000002c	0x005b7e

```
Interface vlan3902 LSDB
```

Type	Link ID	ADV Router	Age	Seq#	Checksum
LNK	0.0.0.17	10.37.0.11	1535	0x8000002b	0x007120
LNK	0.0.0.37	10.37.0.22	7	0x8000002b	0x00ce23
LNK	0.0.0.22	10.37.0.23	250	0x8000002d	0x00c350

```
switch>
```

14.3.5.36 show ipv6 ospf database link

The **show ipv6 ospf database link** command displays details of the specified link state advertisements. The switch can return link state data about a single area or for all areas on the switch.

Command Mode

EXEC

Command Syntax

```
show ipv6 ospf database link [LINKSTATE_ID][ROUTER][DATA_LEVEL]
```

Parameters

- LINKSTATE_ID Options include:
 - *<no parameter>*
 - *<A.B.C.D>*
- ROUTER Options include:
 - *<no parameter>*
 - *adv-router [a.b.c.d]*
 - *self-originate*
- DATA_LEVEL Options include:
 - *<no parameter>*
 - *detail*

Example

This command displays information about the Open Shortest Path First (OSPF).

```
switch#show ipv6 ospf database link
Codes: AEX - AS External, GRC - Grace,
       IAP - Inter Area Prefix, IAR - Inter Area Router,
       LNK - Link, NAP - Intra Area Prefix,
       NSA - Not So Stubby Area, NTW - Network,
       RTR - Router

Routing Process "ospf 9":

switch>
```

14.3.5.37 show ipv6 ospf database

The **show ipv6 ospf database** command displays data from the OSPF database. The switch can return link state data for a single VRF or for all VRFs on the switch.

Command Mode

EXEC

Command Syntax

```
show ipv6 ospf database[ VRF_INSTANCE]
```

Parameters

- VRF_INSTANCE Values include:
 - *<no parameter>* Displays information for all VRFs.
 - *vrf vrf_name* Displays information for the specified VRF.

Example

This command displays OSPF database information for VRF blue.

```
switch#show ipv6 ospf database vrf blue
Codes: AEX - AS External, GRC - Grace,
       IAP - Inter Area Prefix, IAR - Inter Area Router,
       LNK - Link, NAP - Intra Area Prefix,
       NSA - Not So Stubby Area, NTW - Network,
       RTR - Router
Routing Process "ospf 9", VRF blue
AS Scope LSDB
switch>
```

14.3.5.38 show ipv6 ospf database<link-state details>

The `show ipv6 ospf database <link-state details>` command displays detailed information about the specified link state advertisements. The switch can return link state data about a single area or for all areas on the switch.

Command Mode

EXEC

Command Syntax

```
show ipv6 ospf database [FILTER][LINK_TYPE][LINKSTATE_ID][ROUTER][DATA_LEVEL]
```

Parameters

- FILTER Filters the output of the command by specifying areas. Options include:
 - area <A.B.C.D>
 - area backbone
- LINK_TYPE Parameter options include:
 - router
 - network
 - inter-area-prefix
 - inter-area-router
 - intra-area-prefix
 - nssa
- LINKSTATE_ID Options include:
 - <no parameter>
 - <A.B.C.D>
- ROUTER Options include:
 - <no parameter>
 - adv-router [a.b.c.d]
 - self-originate
- DATA_LEVEL Options include:
 - <no parameter>
 - detail

Example

This command displays the OSPF database summary.

```
switch#show ipv6 ospf database detail
Codes: AEX - AS External, GRC - Grace,
       IAP - Inter Area Prefix, IAR - Inter Area Router,
       LNK - Link, NAP - Intra Area Prefix,
       NSA - Not So Stubby Area, NTW - Network,
       RTR - Router

Routing Process "ospf 9":

  AS Scope LSDB

LSA Type: AEX
  Link State ID: 0.0.0.1
  Advertising Router: 10.21.4.9
  Age: 1123
  Sequence Number: 0x80000001
  Checksum: 0x009c89
```

```
Length: 40
Metric Type: 2
Metric: 1
External Route Tag: 0
Prefix
  Prefix: fd7a:629f:52a4:1::
  Length: 64
  Options: (null)
  Metric: 0

Area 0.0.1.44 LSDB

LSA Type: LNK
Link State ID: 0.0.0.14
Advertising Router: 10.26.0.11
Age: 1285
Sequence Number: 0x800000c1
Checksum: 0x00629b
Length: 56
Option Priority: 16777235
Link Local Addr: fe80::21c:73ff:fe0b:a80e
Number of Prefixes: 1

Prefix
  Prefix: fd7a:629f:52a4:fe08::
  Length: 64
  Options: (null)
  Metric: 0

LSA Type: LNK
Link State ID: 0.0.0.34
Advertising Router: 10.26.0.22
Age: 1042
Sequence Number: 0x800000c2
Checksum: 0x00bd9f
Length: 56
Option Priority: 16777235
Link Local Addr: fe80::21c:73ff:fe01:5fe1
Number of Prefixes: 1

Prefix
  Prefix: fd7a:629f:52a4:fe08::
  Length: 64
  Options: (null)
  Metric: 0

LSA Type: LNK
Link State ID: 0.0.0.15
Advertising Router: 10.26.0.23
Age: 1128
Sequence Number: 0x800000c7
Checksum: 0x00d4ab
Length: 56
Option Priority: 16777235
Link Local Addr: fe80::21c:73ff:fe00:1319
Number of Prefixes: 1

Prefix
  Prefix: fd7a:629f:52a4:fe08::
  Length: 64
  Options: (null)
  Metric: 0

Interface vlan3925 LSDB
```

```
LSA Type: LNK
Link State ID: 0.0.0.153
Advertising Router: 10.27.0.52
Age: 1186
Sequence Number: 0x800009b6
Checksum: 0x002f27
Length: 56
Option Priority: 16777235
Link Local Addr: fe80::21c:73ff:fe17:3906
Number of Prefixes: 1
```

```
Prefix
  Prefix: fd7a:629f:52a4:fe67::
  Length: 64
  Options: (null)
  Metric: 0
```

```
Interface lo0 LSDB
```

```
switch>
```

14.3.5.39 show ipv6 ospf interface

The **show ipv6 ospf interface** command displays OSPFv3 information on interfaces where OSPFv3 is enabled.

Command Mode

EXEC

Command Syntax

```
show ipv6 ospf interface [VRF_INSTANCE]
```

Parameters

- VRF_INSTANCE Values include:
 - *<no parameter>* Displays information for all VRFs.
 - *vrf vrf_name* Displays information for the specified VRF.

Example

This command displays OSPFv3 information for interfaces where OSPFv3 is enabled.

```
switch#show ipv6 ospf interface
Ethernet17 is up
  Interface Address fe80::48c:73ff:fe00:1319, VRF default, Area 0.0.0.0
  Network Type Broadcast, Cost 10
  Transmit Delay is 1 sec, State Backup DR, Priority 1
  Designated Router is 10.37.0.37
  Backup Designated Router is 10.37.0.23
  Timer intervals configured, Hello 10, Dead 40, Retransmit 5
  Neighbor Count is 1
  Options are R E V6
Vlan31 is up
  Interface Address fe80::48c:73ff:fe00:1319, VRF default, Area 0.0.0.0
  Network Type Broadcast, Cost 10
  Transmit Delay is 1 sec, State Backup DR, Priority 1
  Designated Router is 10.37.0.22
  Backup Designated Router is 10.37.0.23
  Timer intervals configured, Hello 10, Dead 40, Retransmit 5
  Neighbor Count is 1
  Options are R E V6
Vlan32 is up
  Interface Address fe80::48c:73ff:fe00:1319, VRF default, Area 0.0.0.0
  Network Type Broadcast, Cost 10
  Transmit Delay is 1 sec, State DR Other, Priority 1
  Designated Router is 10.37.0.11
  Backup Designated Router is 10.37.0.22
  Timer intervals configured, Hello 10, Dead 40, Retransmit 5
  Neighbor Count is 2
  Options are R E V6
switch>
```

14.3.5.40 show ipv6 ospf lsa-log

The `show ipv6 ospf lsa-log` command displays log entries when LSA update messages are sent or received for OSPFv3.

Command Mode

EXEC

Command Syntax

```
show ipv6 ospf [PROCESS_ID] lsa-log [VRF_INSTANCE]
```

Parameters

- PROCESS_ID OSPFv3 process ID. Values include:
 - `<no parameter>` Displays information for all process IDs.
 - `<1 to 65535>` Displays information for the specified process ID.
- VRF_INSTANCE Values include:
 - `<no parameter>` Displays information for all VRFs.
 - `vrf vrf_name` Displays information for the specified VRF.

Example

This command displays log entries when LSA update messages are sent or received for OSPFv3.

```
switch#show ipv6 ospf lsa-log
OSPF3 Process 3.3.3.3, VRF default, LSA Throttling Log:
[04:21:09] type 1: 3.3.3.3/32 [3.3.3.3], event 1, backed off, new hold
value 2000 msecs
[04:21:08] type 1: 3.3.3.3/32 [3.3.3.3], event 2, backoff restarted, new
hold value 900 msecs
[04:21:00] type 1: 3.3.3.3/32 [3.3.3.3], event 1, backed off, new hold
value 3000 msecs
[04:21:00] type 1: 3.3.3.3/32 [3.3.3.3], event 4, maxwait value changed,
new hold value 3000
msecs
/* Here the maxwait value was changed to 3000 from earlier 32000, this is
not part of the log */
[04:20:42] type 1: 3.3.3.3/32 [3.3.3.3], event 1, backed off, new hold
value 32000 msecs
[04:20:10] type 1: 3.3.3.3/32 [3.3.3.3], event 1, backed off, new hold
value 32000 msecs
[04:19:54] type 1: 3.3.3.3/32 [3.3.3.3], event 1, backed off, new hold
value 16000 msecs
[04:19:46] type 1: 3.3.3.3/32 [3.3.3.3], event 1, backed off, new hold
value 8000 msecs
[04:19:42] type 1: 3.3.3.3/32 [3.3.3.3], event 1, backed off, new hold
value 4000 msecs
[04:19:40] type 1: 3.3.3.3/32 [3.3.3.3], event 1, backed off, new hold
value 2000 msecs
[04:19:39] type 1: 3.3.3.3/32 [3.3.3.3], event 2, backoff restarted, new
hold value 900 msecs
[04:19:22] type 1: 4.4.4.4/32 [4.4.4.4], event 3, discarded, was early by
995 msecs
[04:19:22] type 1: 3.3.3.3/32 [3.3.3.3], event 0, backoff started, new
hold value 1000 msecs
switch>
```

14.3.5.41 show ipv6 ospf neighbor state

The `show ipv6 ospf neighbor state` command displays the state information on OSPF neighbors on a per-interface basis.

Command Mode

EXEC

Command Syntax

```
show ipv6 ospf neighbor state STATE_NAME [VRF_INSTANCE ]
```

Parameters

- STATE_NAME Values include:
 - 2-ways
 - attempt
 - down
 - exch-start
 - exchange
 - full
 - restart
 - init
 - loading
- VRF_INSTANCE Values include:
 - *<no parameter>* Displays information for all VRFs.
 - *vrf vrf_name* Displays information for the specified VRF.

Example

This command displays OSPF information for neighboring devices that are adjacent.

```
switch#show ipv6 ospf neighbor state full
Routing Process "ospf 3":
switch>
```

14.3.5.42 show ipv6 ospf neighbor summary

The `show ipv6 ospf neighbor summary` command displays a single line of state information for each OSPFv3 neighbor.

Command Mode

EXEC

Command Syntax

```
show ipv6 ospf neighbor summary [VRF_INSTANCE]
```

Parameters

- VRF_INSTANCE Values include:
 - <no parameter> Displays information for all VRFs.
 - vrf *vrf_name* Displays information for the specified VRF.

Example

This command shows the summary information for the OSPFv3 neighbors.

```
switch#show ipv6 ospf neighbor summary
Routing Process "ospf 1":
  3 neighbors are in state Down
  3 neighbors are in state Full
  5 neighbors are in state Init
  0 neighbors are in state Loading
  0 neighbors are in state Attempt
  3 neighbors are in state Restarting
  0 neighbors are in state Exchange
  3 neighbors are in state 2 Ways
  0 neighbors are in state Exch Start
switch>
```

14.3.5.43 show ipv6 ospf neighbor

The `show ipv6 ospf neighbor` command displays OSPFv3 neighbor information.

Command Mode

EXEC

Command Syntax

```
show ipv6 ospf neighbor [VRF_INSTANCE]
```

Parameters

- VRF_INSTANCE Values include:
 - `<no parameter>` Displays information for all VRFs.
 - `vrf vrf_name` Displays information for the specified VRF.

Example

This command displays the switch's neighbors.

```
switch#show ipv6 ospf neighbor
Routing Process "ospf 9":
Neighbor 10.37.0.37 VRF default priority is 1, state is Full
  In area 0.0.0.0 interface et12
  DR is 10.37.0.37 BDR is 10.37.0.23
  Options is 0
  Dead timer is due in 37 seconds
Neighbor 10.37.0.22 VRF default priority is 1, state is Full
  In area 0.0.0.0 interface vlan3911
  DR is 10.37.0.22 BDR is 10.37.0.23
  Options is 0
  Dead timer is due in 31 seconds
Neighbor 10.37.0.11 VRF default priority is 1, state is Full
  In area 0.0.0.0 interface vlan3902
  DR is 10.37.0.11 BDR is 10.37.0.22
  Options is 0
  Dead timer is due in 33 seconds
Neighbor 10.37.0.22 VRF default priority is 1, state is Full
  In area 0.0.0.0 interface vlan3902
  DR is 10.37.0.11 BDR is 10.37.0.22
  Options is 0
  Dead timer is due in 31 seconds
Neighbor 10.37.0.22 VRF default priority is 1, state is Full
  In area 0.0.0.0 interface vlan3923
  DR is 10.37.0.22 BDR is 10.37.0.46
  Options is 0
  Dead timer is due in 31 seconds
Neighbor 10.37.0.22 VRF default priority is 1, state is Full
  In area 0.0.0.0 interface vlan3908
  DR is 10.37.0.22 BDR is 10.37.0.21
  Options is 0
  Dead timer is due in 39 seconds
Neighbor 10.37.0.22 VRF default priority is 1, state is Full
  In area 0.0.0.2 interface vlan3992
  DR is 10.37.0.22 BDR is 10.37.0.23
  Options is 0
  Dead timer is due in 39 seconds
switch>
```

14.3.5.44 show ipv6 ospf spf-log

The `show ipv6 ospf spf-log` command displays when and how long the switch took to run a full SPF calculation for OSPFv3.

Command Mode

EXEC

Command Syntax

```
show ipv6 ospf [PROCESS_ID] spf-log [VRF_INSTANCE]
```

Parameters

- PROCESS_ID OSPFv3 process ID. Values include:
 - *<no parameter>* Displays information for all process IDs.
 - *<1 to 65535>* Displays information for the specified process ID.
- VRF_INSTANCE Values include:
 - *<no parameter>* Displays information for all VRFs.
 - *vrf vrf_name* Displays information for the specified VRF.

Example

This command displays the SPF information for OSPFv3 in all VRFs.

```
switch#show ipv6 ospf spf-log
OSPF3 Process 172.26.0.22, VRF default
TIME          EVENT                               REASON
04:54:52.070  SPF ran for 0.70 ms
04:54:52.070  Scheduled after 0 ms           Router LSA generation
04:54:39.151  SPF ran for 0.71 ms
04:54:39.151  Scheduled after 0 ms           Router LSA generation
04:54:12.071  SPF ran for 0.56 ms
04:54:12.070  Scheduled after 0 ms           Router LSA generation
04:54:04.153  SPF ran for 0.29 ms
04:53:59.153  Scheduled after 4999 ms        Router LSA generation
04:53:59.153  SPF ran for 0.25 ms
04:53:59.151  Scheduled after 0 ms           Router LSA generation
04:53:33.081  SPF ran for 0.3 ms
04:53:33.081  Scheduled after 0 ms           ECMP max nexthop cfg change
switch>
```

14.3.5.45 show ipv6 ospf

The `show ipv6 ospf` command displays information about OSPFv3 routing.

Command Mode

EXEC

Command Syntax

```
show ipv6 ospf [access-list | border-routers | database | interface | lsa-log | neighbor | request-list
| retransmission-list | spf-log | vrf ] Process ID
```

Parameters

- `<no parameters>` displays the complete configuration of OSPFv3 address family and routing process.
- `access-list` displays the information of configured OSPFv3 access-list. Options include:
 - `<no parameters>` displays the information of all configured OSPFv3 access lists.
 - `WORD` displays the information of the specified access list.
 - `summary` displays the summary of all configured access lists.
- `border-routers` displays the information of configured OSPFv3 border and boundary routers. Options include:
 - `<no parameters>` displays the information of all configured OSPFv3 borders and boundary routers.
 - `vrf` displays the OSPFv3 borders and boundary routers information of the specified Virtual Routing and Forwarding (VRF).
- `database` displays the summary of database. Options include:
 - `<no parameters>` displays the complete summary of database.
 - `ipv4` displays the database information of link state ID.
 - `adv-router` displays the database information of advertising router link states.
 - `area` displays the database information filtered by area scope LSAs.
 - `as` displays the database information filtered by AS scope LSAs.
 - `database-summary` displays the count of LSAs in OSPFv3 database.
 - `detail` displays the detailed information of LSA.
 - `link` displays the database information filtered by link scoped LSAs.
 - `self-originate` displays the database information of self-originated link states.
 - `vrf` displays the VRF information in OSPFv3 database.
- `interface` displays the information of OSPFv3 interfaces. Options include
 - `<no parameters>` displays the information of all OSPFv3 interfaces.
 - Ethernet `eth_num` displays the information of the specified Ethernet interface. The value ranges from 1 to 24.
 - Loopback `lb_num` displays the information of the specified loop back interface. The value ranges from 0 to 1000.
 - Port-Channel `pc_num` displays the interface or sub-interface information of the specified port channel. The interface and sub-interface values of port channel ranges from `<1-1000>` and `<1-2000>`.`<1-4094>` respectively.
 - Tunnel `t_num` displays the information of the specified tunnel. The value ranges from 0 to 255.
 - Vlan `vlan_num` displays the information of the specified VLAN interface. The value ranges from 1 to 4094.
 - vrf `vrf_name` displays the information of the specified VRF.
- `lsa-log` displays the log entries of OSPFv3 LSA updates.
- `neighbor` displays the list of OSPFv3 neighbors.
- `request-list` displays the list of all OSPFv3 LSAs requested by a router.

- retransmission-list displays the list of all OSPFv3 LSAs waiting to be re-sent.
- spf-log displays the start-time, duration of completion, and reason of delay to calculate the OSPFv3 Sender Policy Framework (SPF).
- vrf vrf_name displays the information of specified VRF.
- Process ID displays the OSPFv3 configuration of the specified process ID. The value ranges from 1 to 65535.

Examples

- This command displays OSPFv3 routing information for all VRFs.

```
switch#show ipv6 ospf
Routing Process "ospfv3 0" with ID 11.1.11.1 and Instance 0 VRF default
  FIPS mode disabled
  It is not an autonomous system boundary router and is not an area
  border router
  Minimum LSA arrival interval 1000 msec
  Initial LSA throttle delay 1000 msec
  Minimum hold time for LSA throttle 5000 msec
  Maximum wait time for LSA throttle 5000 msec
  It has 0 fully adjacent neighbors
  Number of areas in this router is 0. 0 normal, 0 stub, 0 nssa
  Number of LSAs 0
  Initial SPF schedule delay 0 msec
  Minimum hold time between two consecutive SPF's 5000 msec
  Current hold time between two consecutive SPF's 5000 msec
  Maximum wait time between two consecutive SPF's 5000 msec
  SPF algorithm last executed 00:07:13 ago
  No scheduled SPF
  Adjacency exchange-start threshold is 20
  Maximum number of next-hops supported in ECMP is 32
  Number of backbone neighbors is 0
  Graceful-restart is not configured
  Graceful-restart-helper mode is enabled
```

- This command displays the log entries of OSPFv3 LSA updates.

```
switch#show ipv6 ospf lsa-log
[22:11:02] type RTR: 0.0.0.0 [13.13.13.13], event 2, backoff restarted,
new hold value 1000 msec
[21:31:02] type RTR: 0.0.0.0 [13.13.13.13], event 2, backoff restarted,
new hold value 1000 msec
[20:56:22] type RTR: 0.0.0.0 [13.13.13.13], event 2, backoff restarted,
new hold value 1000 msec
[20:18:12] type RTR: 0.0.0.0 [13.13.13.13], event 2, backoff restarted,
new hold value 1000 msec
[19:47:22] type RTR: 0.0.0.0 [13.13.13.13], event 2, backoff restarted,
new hold value 1000 msec
[19:13:22] type RTR: 0.0.0.0 [13.13.13.13], event 2, backoff restarted,
new hold value 1000 msec
[18:39:32] type RTR: 0.0.0.0 [13.13.13.13], event 2, backoff restarted,
new hold value 1000 msec
[18:06:32] type RTR: 0.0.0.0 [13.13.13.13], event 2, backoff restarted,
new hold value 1000 msec
[17:26:42] type RTR: 0.0.0.0 [13.13.13.13], event 2, backoff restarted,
new hold value 1000 msec
[16:48:42] type RTR: 0.0.0.0 [13.13.13.13], event 2, backoff restarted,
new hold value 1000 msec
[16:13:12] type RTR: 0.0.0.0 [13.13.13.13], event 2, backoff restarted,
new hold value 1000 msec
[15:36:52] type RTR: 0.0.0.0 [13.13.13.13], event 2, backoff restarted,
new hold value 1000 msec
```



```
[15:03:32] type RTR: 0.0.0.0 [13.13.13.13], event 2, backoff restarted,  
new hold value 1000 msecs  
[14:27:52] type RTR: 0.0.0.0 [13.13.13.13], event 2, backoff restarted,  
new hold value 1000 msecs  
[13:52:02] type RTR: 0.0.0.0 [13.13.13.13], event 2, backoff restarted,  
new hold value 1000 msecs  
[13:15:02] type RTR: 0.0.0.0 [13.13.13.13], event 2, backoff restarted,  
new hold value 1000 msecs  
[12:39:42] type RTR: 0.0.0.0 [13.13.13.13], event 2, backoff restarted,  
new hold value 1000 msecs  
[12:00:02] type RTR: 0.0.0.0 [13.13.13.13], event 2, backoff restarted,  
new hold value 1000 msecs  
[11:27:22] type RTR: 0.0.0.0 [13.13.13.13], event 2, backoff restarted,  
new hold value 1000 msecs  
[10:53:22] type RTR: 0.0.0.0 [13.13.13.13], event 2, backoff restarted,  
new hold value 1000 msecs  
[10:17:12] type RTR: 0.0.0.0 [13.13.13.13], event 2, backoff restarted,  
new hold value 1000 msecs  
[09:42:42] type RTR: 0.0.0.0 [13.13.13.13], event 2, backoff restarted,  
new hold value 1000 msecs
```

14.3.5.46 show ospfv3

The **show ospfv3** command displays the OSPFv3 configuration of OSPFv3 address family and routing process.

Command Mode

EXEC

Command Syntax

```
| show ospfv3 [access-list | border-routers | database | interface | ipv4 | ipv6 | lsa-log | neighbor | request-list | retransmission-list | spf-log | vrf]
```

Parameters

- *<no parameters>* displays the complete configuration of OSPFv3 address family and routing process.
- access-list displays the information of configured OSPFv3 access-list. Options include:
 - *<no parameters>* displays the information of all configured OSPFv3 access lists.
 - WORD displays the information of the specified access list.
 - summary displays the summary of all configured access lists.
- border-routers displays the information of configured OSPFv3 border and boundary routers. Options include:
 - *<no parameters>* displays the information of all configured OSPFv3 borders and boundary routers.
 - vrf displays the OSPFv3 borders and boundary routers information of the specified Virtual Routing and Forwarding (VRF).
- database displays the summary of database. Options include:
 - *<no parameters>* displays the complete summary of database.
 - ipv4 displays the database information of link state ID.
 - adv-router displays the database information of advertising router link states.
 - area displays the database information filtered by area scope LSAs.
 - as displays the database information filtered by AS scope LSAs.
 - database-summary displays the count of LSAs in OSPFv3 database.
 - detail displays the detailed information of LSA.
 - link displays the database information filtered by link scoped LSAs.
 - self-originate displays the database information of self-originated link states.
 - vrf displays the VRF information in OSPFV3 database.
- interface displays the information of OSPFv3 interfaces. Options include:
 - *<no parameters>* displays the information of all OSPFv3 interfaces.
 - Ethernet *eth_num* displays the information of the specified Ethernet interface. The value ranges from 1 to 24.
 - Loopback *lb_num* displays the information of the specified loop back interface. The value ranges from 0 to 1000.
 - Port-Channel *pc_num* displays the interface or sub-interface information of the specified port channel. The interface and sub-interface values of port channel ranges from <1-1000> and <1-2000>.<1-4094> respectively.
 - Tunnel *t_num* displays the information of the specified tunnel. The value ranges from 0 to 255.
 - Vlan *vlan_num* displays the information of the specified VLAN interface. The value ranges from 1 to 4094.
 - vrf *vrf_name* displays the information of the specified VRF.
- ipv4 displays the IPv4 address family information.
- ipv6 displays the IPv6 address family information.

- `lsa-log` displays the log entries of OSPFv3 LSA updates.
- `neighbor` displays the list of OSPFv3 neighbors.
- `request-list` displays the list of all OSPFv3 LSAs requested by a router.
- `retransmission-list` displays the list of all OSPFv3 LSAs waiting to be re-sent.
- `spf-log` displays the start-time, duration of completion, and reason of delay to calculate the OSPFv3 Sender Policy Framework (SPF).
- `vrf vrf_name` displays the information of specified VRF.

Examples

- This command displays the complete configuration of OSPFv3 address family and routing process.

```
switch#show ospfv3
OSPFv3 address-family ipv6
Routing Process "ospfv3" with ID 13.13.13.13 and Instance 0 VRF default
  FIPS mode disabled
  It is not an autonomous system boundary router and is not an area
  border router
  Minimum LSA arrival interval 1000 msec
  Initial LSA throttle delay 1000 msec
  Minimum hold time for LSA throttle 5000 msec
  Maximum wait time for LSA throttle 5000 msec
  Interface flood pacing timer 50 msec
  It has 0 fully adjacent neighbors
  Number of areas in this router is 1. 1 normal, 0 stub, 0 nssa
  Number of LSAs 1
  Initial SPF schedule delay 0 msec
  Minimum hold time between two consecutive SPFs 5000 msec
  Current hold time between two consecutive SPFs 5000 msec
  Maximum wait time between two consecutive SPFs 5000 msec
  SPF algorithm last executed 3d23h ago
  No scheduled SPF
  Adjacency exchange-start threshold is 20
  Maximum number of next-hops supported in ECMP is 32
  Number of backbone neighbors is 0
  Graceful-restart is not configured
  Graceful-restart-helper mode is enabled
  Area 0.0.0.0
    Number of interface in this area is 0
    It is a normal area
    SPF algorithm executed 2 times
```

- This command displays the count of LSAs in OSPFv3 database.

```
switch#show ospfv3 database database-summary
OSPFv3 address-family ipv4
Routing Process "ospfv3" Instance 64 VRF default

LSA Type          Count
Router             1
Network            0
Inter Area Prefix  0
Inter Area Router  0
Summary Asex      0
Nssa               0
Link               0
Intra Area Prefix  0
Grace              0
Total              1

OSPFv3 address-family ipv6
Routing Process "ospfv3" Instance 0 VRF default
```

```

LSA Type          Count
Router            0
Network          0
Inter Area Prefix 0
Inter Area Router 0
Summary Asex     0
Nssa             0
Link             0
Intra Area Prefix 0
Grace            0
Total            0

```

```
ro301.02:05:02(config-router-ospfv3-af)#
```

- This command displays the start-time, duration of completion, and reason of delay to calculate the OSPFv3 SPF.

```

switch#show ospfv3 spf-log
OSPFv3 address-family ipv4
Routing Process "ospfv3" with ID 11.1.11.1 and Instance 64, VRF default
TIME          EVENT          REASON
02:00:13.495  SPF ran for 0.064 ms
02:00:13.335  Scheduled after 0.000 ms Router LSA generation
01:59:55.499  SPF ran for 0.061 ms
01:59:54.604  Scheduled after 0.000 ms ECMP max nexthop cfg change
OSPFv3 address-family ipv6
Routing Process "ospfv3" with ID 11.1.11.1 and Instance 0, VRF default
TIME          EVENT          REASON
02:00:13.495  SPF ran for 0.064 ms
02:00:13.335  Scheduled after 0.000 ms OSPF3 re-initialisation
01:59:55.499  SPF ran for 0.089 ms
01:59:54.603  Scheduled after 0.000 ms ECMP max nexthop cfg change
ro301.02:04:06(config-router-ospfv3-af)#

```

14.3.5.47 shutdown (OSPFv3)

The **shutdown** command disables OSPFv3 on the switch.

OSPFv3 is disabled by default on individual interfaces and enabled through **ipv6 ospf area** commands.

The **no shutdown** and **default shutdown** commands enable the OSPFv3 instance by removing the **shutdown** statement from the OSPFv3 block in running-config.

Command Mode

Router-OSPFv3 Configuration

Command Syntax

```
shutdown
```

```
no shutdown
```

```
default shutdown
```

Example

This command disables OSPFv3 activity on the switch.

```
switch(config)#ipv6 router ospf 9
switch(config-router-ospf3)#shutdown
switch(config-router-ospf3)#show active
ipv6 router ospf 9
  shutdown
switch(config-router-ospf3)#
```

14.3.5.48 timers lsa rx min interval (OSPFv3)

The `timers lsa rx min interval` command sets the minimum interval for accepting identical link-state advertisements (LSAs) from OSPFv3 neighbors.

The `no timers lsa rx min interval` and `default timers lsa rx min interval` commands restore the minimum interval to the default value of one second by removing the `timers lsa rx min interval` command from *running-config*.

Command Mode

Router-OSPFv3 Configuration

Router-OSPFv3 Address-Family

IPv4/IPv6 Configuration

Command Syntax

```
timers lsa rx min interval lsa_time
```

```
no timers lsa rx min interval
```

```
default timers lsa rx min interval
```

Parameter

lsa_time Minimum time (in milliseconds) after which the switch accepts an identical LSA from OSPFv3 neighbors. Value ranges from 0 to 600000 (ms). Default value is 1000 milliseconds (1 second).

Example

This command sets the minimum LSA arrival interval to ten milliseconds.

```
switch(config)#router ospfv3
switch(config-router-ospfv3)#timers lsa rx min interval 10
switch(config-router-ospfv3)#
```

14.3.5.49 timers lsa tx delay initial (OSPFv3)

The `timers lsa tx delay initial` command sets the rate-limiting values for OSPFv3 Link-State Advertisement (LSA) generation.

The `no timers lsa tx delay initial` and `default timers lsa tx delay initial` commands restore the default LSA rate-limiting values by removing the `timers lsa tx delay initial` command from *running-config*.

Command Mode

Router-OSPFv3 Configuration

Router-OSPFv3 Address-Family

IPv4/IPv6 Configuration

Command Syntax

```
timers lsa tx delay initial initial_delay min_hold max_wait
```

```
no timers lsa tx delay initial
```

```
default timers lsa tx delay initial
```

Parameters

- *initial_delay* Initial delay in milliseconds to generate the first instance of LSAs. Value ranges from 0 to 600000 (ms). The default value is 1000 ms.
- *min_hold* Minimum hold interval availed in milliseconds between the generation of same LSA. Value ranges from 1 to 600000 (ms). The default interval is 5000 ms.
- *max_wait* Maximum hold interval availed in milliseconds between the generation of same LSA. Value ranges from 1 to 600000 (ms). The default interval is 5000 ms.

Example

These commands set the LSA transmission timers on the switch.

```
switch(config) #router ospfv3
switch(config-router-ospfv3) #
switch(config-router-ospfv3) #timers lsa tx delay initial 5 100 20000
switch(config-router-ospfv3) #
```

14.3.5.50 timers spf delay initial (OSPFv3)

The purpose of SPF throttling is to delay Shortest Path First (SPF) calculations when network topology is changing rapidly. The `timers spf delay initial` command controls the intervals of SPF calculations in a switch. The command sets three values:

- **Initial delay:** Initial wait by a switch to calculate SPF after a topology change in a network that has been stable throughout the hold interval. Because a topology change often requires several link state updates to be sent, the initial delay is configured to allow the network to settle before the switch calculates SPF. If an additional topology change occurs during the initial interval, the SPF calculation still takes place after the initial delay period has expired and no other change is made to the throttle timers.
- **Hold interval:** This is an additional wait timer that reduces the frequency of SPF calculations during periods of network instability. If a network change occurs during the hold period, an SPF calculation is scheduled to occur when the hold interval expires. Subsequent hold intervals are doubled if further topology changes occur during a hold interval until either the hold interval reaches its configured maximum or no topology change occurs during the interval. If the next topology change occurs after the hold interval expires, the hold interval is reset to its configured value and the SPF calculation is scheduled to take place after the initial delay.
- **Maximum interval:** The maximum wait time of a switch after a topology change before performing an SPF calculation.

The `no timers spf delay initial` and `default timers spf delay initial` commands restore the default OSPFv3 SPF calculation intervals by removing the `timers spf delay initial` command from `running-config`.

Command Mode

Router-OSPFv3 Configuration

Router-OSPFv3 Address-Family

IPv4/IPv6 Configuration

Command Syntax

```
timers spf delay initial initial_delay hold_interval max_interval
```

```
no timers spf
```

```
default timers spf
```

Parameters

- *initial_delay* Initial delay between a topology change and SPF calculation. Value ranges from 0 to 65535000 (ms). The default value is 0 ms.
- *hold_interval* Additional wait time after SPF calculation to allow the network to settle. If a topology change occurs during the hold interval, another SPF calculation is scheduled to occur after the hold interval expires. The next hold interval is doubled if topology changes occur during the hold interval. If doubling exceeds the maximum value, the maximum value is used instead. Value ranges from 0 to 65535000 (ms). The default value is 5000 ms.
- *max_interval* The maximum hold interval before a switch calculates SPF. Value ranges from 0 to 65535000 (ms). The default value is 5000 ms.

Example

These commands set the SPF timers on the switch.

```
switch(config)#router ospfv3
switch(config-router-ospfv3)#
switch(config-router-ospfv3)#timers spf delay initial 5 100 20000
switch(config-router-ospfv3)#
```

14.3.5.51 timers

The **timers** command configures the minimum interval between the transmission of consecutive LS update packets in a network.

The **no timers** and **default timers** commands set the configured timer value to its default.

Command Mode

Router-OSPFv3 Configuration

Command Syntax

```
timers {lsa | out-delay| pacing | throttle}
no timers {lsa | out-delay| pacing | throttle}
deault timers {lsa | out-delay| pacing | throttle}
```

Parameters

- lsa configures threshold for the retransmission of LSA. Option includes:
 - arrival configures the OSPF LSA arrival timer.
- out-delay configures the delay to flood router LSA in milliseconds. Option includes:
 - *out-delay_time* minimum interval in milliseconds between accepting the same LSAs. The value ranges from 0 to 65000 milliseconds. The default value is zero.
- pacing configures the OSPF packet pacing. Option includes:
 - flood configures the OSPF flood pacing.
- throttle configures ospf throttle timers. Options include:
 - lsaconfigures threshold for the retransmission of LSA.
 - spfconfigures the time between SPF calculations.

Examples

- This command configures OSPFv3 flood pacing timer to 50 ms in the global OSPFv3 instance.

```
switch(config)#ipv6 router ospf 9
switch(config-router-ospf3)#timers pacing flood 50
switch(config-router-ospf3)#show ospfv3
Routing Process "ospfv3 9" with ID 13.13.13.13 and Instance 0 VRF
default
  FIPS mode disabled
  It is not an autonomous system boundary router and is not an area
  border router
  Minimum LSA arrival interval 1000 msec
  Initial LSA throttle delay 1000 msec
  Minimum hold time for LSA throttle 5000 msec
  Maximum wait time for LSA throttle 5000 msec
  Interface flood pacing timer 50 msec
  It has 0 fully adjacent neighbors
  Number of areas in this router is 1. 1 normal, 0 stub, 0 nssa
  Number of LSAs 1
  Initial SPF schedule delay 0 msec
  Minimum hold time between two consecutive SPFs 5000 msec
  Current hold time between two consecutive SPFs 5000 msec
  Maximum wait time between two consecutive SPFs 5000 msec
  SPF algorithm last executed 21d19h ago
  No scheduled SPF
  Adjacency exchange-start threshold is 20
  Maximum number of next-hops supported in ECMP is 32
  Number of backbone neighbors is 0
  Graceful-restart is not configured
```

```
Graceful-restart-helper mode is enabled
Area 0.0.0.0
  Number of interface in this area is 0
  It is a normal area
  SPF algorithm executed 2 times
```

- This command configures the OSPFv3 flood pacing timer to 50 ms in IPv4 address family.

```
switch(config)#router ospfv3
switch(config-router-ospfv3)#address-family ipv4
switch(config-router-ospfv3-af)#timers pacing flood 50
switch(config-router-ospfv3-af)#show ospfv3
OSPFv3 address-family ipv4
Routing Process "ospfv3" with ID 11.1.11.1 and Instance 64 VRF default
  FIPS mode disabled
  It is not an autonomous system boundary router and is not an area
  border router
  Minimum LSA arrival interval 1000 msec
  Initial LSA throttle delay 1000 msec
  Minimum hold time for LSA throttle 5000 msec
  Maximum wait time for LSA throttle 5000 msec
  Interface flood pacing timer 50 msec
  It has 0 fully adjacent neighbors
  Number of areas in this router is 1. 1 normal, 0 stub, 0 nssa
  Number of LSAs 1
  Initial SPF schedule delay 0 msec
  Minimum hold time between two consecutive SPF's 5000 msec
  Current hold time between two consecutive SPF's 5000 msec
  Maximum wait time between two consecutive SPF's 5000 msec
  SPF algorithm last executed 00:10:38 ago
  No scheduled SPF
  Adjacency exchange-start threshold is 20
  Maximum number of next-hops supported in ECMP is 32
  Number of backbone neighbors is 0
  Graceful-restart is not configured
  Graceful-restart-helper mode is enabled
  Area 0.0.0.0
    Number of interface in this area is 0
    It is a normal area
    SPF algorithm executed 2 times
```

14.4 IS-IS

Intermediate System-to-Intermediate System (IS-IS) intra-domain routing information exchange protocol is designed by the International Organization for Standardization to support connectionless networking. This protocol is a dynamic routing protocol.

This chapter contains the following sections.

- [IS-IS Introduction](#)
- [IS-IS Segment Routing](#)
- [IS-IS Graceful Restart](#)
- [TI-LFA FRR using IS-IS Segment-Routing](#)
- [IS-IS Dynamic Flooding](#)
- [IS-IS Configuration](#)
- [IS-IS Commands](#)

14.4.1 IS-IS Introduction

IS-IS is a link-state protocol, which uses the shortest path first (SPF) algorithm. IS-IS and the OSPF protocol are similar in many aspects. As an interior gateway protocol (IGP), IS-IS runs inside an autonomous system (AS).

To enable IS-IS, you must instantiate an IS-IS routing instance and assign it to an interface. Arista IS-IS support includes IS-IS segment routing and IS-IS graceful restart.

14.4.2 IS-IS Segment Routing

Segment Routing (SR) provides a mechanism to simplify the definition of end-to-end paths within IGP topologies by encoding paths as sequences of topological sub-paths, called segments. The IS-IS protocol advertises these segments in four different ways: node segments, prefix segments, proxy-node segments, and adjacency segments.

Node segments represent a node in an IGP topology. A proxy segment are generally associated with an IP(v6) address received from a router that does not support IS-IS SR. Prefix segments represent an ECMP-aware shortest path to a prefix (or a node), as per the state of the IGP topology. Adjacency segments represent a hop over a specific adjacency between two nodes in IGP.

14.4.2.1 TI-LFA FRR using IS-IS Segment-Routing

Topology Independent Fast Reroute, or TI-LFA, uses IS-IS SR to build loop-free alternate paths along the post-convergence path. These loop-free alternates provide fast convergence in the range of sub-50 ms.

This section describes TI-LFA FRR using IS-IS SR, including configuration instructions and command descriptions. Topics covered by this chapter include:

- [TI-LFA FRR using IS-IS Segment-Routing Platform Compatibility](#)
- [TI-LFA FRR using IS-IS Segment-Routing Configuration](#)
- [TI-LFA FRR using IS-IS SR Commands](#)
- [Troubleshooting](#)
- [Limitations](#)

The (Point of Local Repair - the router where TI-LFA is configured) PLR switches to these loop-free alternate backup paths in the event of a link down (link-protection) or BFD neighbor down (node-protection) event, protecting traffic destined to IS-IS SR node segments, adjacency segments, and anycast segments while the IGP converges and the post-convergence paths are computed. Anycast segment protection is restricted to those segments which are attached to prefixes with host mask (/32 for V4 address and /128 for v6 address).

 **Note:** Unlike node segments, anycast segments do not have the 'N' flag set described in section [2.1.1.2 of RFC8667](#).

The following enhancements are available by release:

- **EOS Release 4.22.1F** adds support for TI-LFA backup paths that protect IS-IS SR labeled traffic corresponding to a node segment or adjacency segment on a transit router.
- **EOS Release 4.23.1F** adds support for TI-LFA backup paths that protect IS-IS SR tunnels.
- **EOS Release 4.24.1** adds support for protecting IS-IS SR labeled traffic corresponding to anycast segments.
- **EOS Release 4.24.2F** adds support for calculating TI-LFA backup paths that exclude the SRLG configured on the failing link.

Backup paths are only installed for IS-IS SR labeled routes and tunnels corresponding to node segments, adjacency segments, and anycast segments. When requesting node-protection, and no node-protecting LFAs are available, a link-protecting LFA is computed instead. TI-LFA FRR using IS-IS Segment-Routing is available with the multi-agent routing protocol model and the ribd routing protocol model.

Other traffic that resolves over IS-IS SR tunnels, such as LDP pseudowires, BGP LU tunnels, BGP IP routes, L2 EVPN, MPLS L3 VPN, and so on, are also protected by the TI-LFA tunnel that protects the resolving IS-IS SR tunnel.

14.4.2.1.1 TI-LFA FRR using IS-IS Segment-Routing Platform Compatability

The following platforms support TI-LFA FRR using IS-IS Segment-Routing:

- 7500R
- 7500R2
- 7500R3
- 7280R
- 7280R2
- 7280R3
- 7800R3 family of switches (platforms supporting HFEC).

14.4.2.1.1.1 TI-LFA FRR using IS-IS SR Commands

TI-LFA FRR using IS-IS SR Show Commands

- `show ip route`
- `show isis interface`
- `show isis local-convergence-delay`
- `show isis segment-routing prefix-segments`
- `show isis segment-routing adjacency-segments`
- `show isis segment-routing tunnel`
- `show isis ti-lfa path`
- `show isis ti-lfa tunnel`
- `show mpls lfib route`
- `show tunnel fib`

14.4.2.1.1.2 Troubleshooting

When an IS-IS SR LFIB route or a tunnel corresponding to a node segment or an adjacency segment that is expected to have backup paths, does not show backup paths in `show mpls lfib route` or `show tunnel fib`, follow this sequence of steps to possibly find the reason why a backup path has not been computed.

- Check the output of `show isis segment-routing prefix-segment` or `show isis segment-routing adjacency-segments` and confirm that the node or adjacency segment is eligible for protection. If the `Protection` field for a node segment or adjacency segment is `Unprotected` but TI-LFA is configured on the interface on which the segment is learned, go to the last step.
- Check the output of `show isis ti-lfa path <destination>` where `destination` is the system ID or hostname of the originator of the node segment or global adjacency segment. If the adjacency segment being protected is a locally adjacency segment, `destination` is the system ID or hostname of the router on the other side of the link where the adjacency segment is configured. If it indicates, `Path not found` for a destination/constraint tuple in the output, that would indicate there was no post-convergence path available. If that is not true, go to the last step.

- Verify that a segment-routing label stack can be built for the explicit backup path listed for the system ID in the output of the command above. The output in the `show isis ti-lfa path` lists the explicit repair path from the P-node to the Q-node.
 - Ensure that the P-node has a node segment associated with it, if it is not the neighbor of the PLR.
 - Ensure that there are adjacency segments that can be used to build a label stack to go from the P-node to the Q-node.
 - If the destination node segment/adjacency segment does not belong to the Q-node, ensure that the Q-node has a label binding (See `show mpls segment-routing bindings`).
- At this point, you have eliminated any topology related issues that could have caused the non-computation of backup paths. For further debugging, collect
 - ```
/var/log/qt/Rib*.qt, /var/log/qt/Isis*.qt,
/var/log/qt/Mpls.qt, /var/log/qt/Cspf.qt
```
  - The output of `show tech-support extended cspf` command.
  - The outputs of the `show tech-support ribd` command in *ribd agent mode* or the `show tech-support extended isis` command in *multi agent mode*.

#### 14.4.2.1.1.3 Limitations

- Backup paths are not computed for prefix segments that do not have a host mask (/32 for v4 and /128 for v6).
- When TI-LFA is configured, the number of anycast segments generated by a node cannot exceed 10.
- Computing TI-LFA backup paths for proxy node segments is not supported.
- Backup paths are not computed for node segments corresponding to multi-homed prefixes. The multi-homing could be the result of them being anycast node segments, loopback interfaces on different routers advertising SIDs for the same prefix, node segments leaked between levels, and thus being seen as originated from multiple L1-L2 routers.
- Backup paths are only computed for segments that are non-ECMP.
- Only IS-IS interfaces that are using the point-to-point network type are eligible for protection.
- Link/node protection is only supported in the default VRF owing to the lack of non-default VRF support for IS-IS segment-routing.
- Backup paths are computed in the same IS-IS level topology as the primary path.
- Even with IS-IS GR configured, ASU2, SSO, agent restart are not hitless events for IS-IS SR LFIB routes or tunnels being protected by backup paths.

### 14.4.3 IS-IS Graceful Restart

IS-IS Graceful Restart (GR) is a mechanism to prevent routing protocol re-convergence during a processor switchover or device downtime. Normally, when a router restarts, all the neighboring routers associated with that router detect that the device has gone down and remove routes from that neighbor. When the router restarts, the session is re-established and data transfer continues. During the restart, the removal and re-insertion of routes will result in data loss. This can be prevented by configuring graceful restart on the device.

When IS-IS is used as the interior gateway protocol (IGP), the following EOS features require nonstop forwarding (NSF) and support for the graceful restart from IS-IS:

- Accelerated Software Upgrade phase 2 (ASU2)
- planned Stateful Switchover (SSO) initiated by an operator for maintenance, or unplanned SSO due to failures on the active supervisor
- RIB agent restart due to software failures

---

With IS-IS Graceful Restart (GR) configured, a redundancy switchover from active to standby supervisor, or ASU2, or restart of the IS-IS software (the RIB agent) should be a hitless event if the GR completes successfully. Neighboring routers will continue to forward traffic to the restarting router and traffic forwarding through the restarting router continues without loss. If GR is successful, the failure of a router should be completely transparent to network applications.

ISIS Graceful Restart (GR) is compatible with the following platforms:

- IS-IS GR with unplanned software restart is supported on all platforms.
- IS-IS GR with SSO is supported on modular dual-supervisor platforms.
- IS-IS GR with ASU2 is supported on platforms that support ASU2.

#### 14.4.4 IS-IS Dynamic Flooding

Dynamic Flooding allows IS-IS to scale to large, dense topologies such as Leaf-Spine topologies. In such topologies, legacy IS-IS can exhibit a congestive collapse due to the control plane load created by excessively redundant flooding.

The concept in Dynamic Flooding is to dynamically compute a restricted topology for flooding (the **flooding topology**). Since this can be much smaller than the full physical topology, this can reduce the redundancy seen by each node, thereby reducing the control plane load and avoiding a congestive collapse.

To do this, first select one node within the IS-IS area as the **area leader**. Leverage the Designated Intermediate System (DIS) election algorithm for this, except instead of applying it to the neighbors on an interface, compute it across all of the nodes within the area.

The area leader is responsible for computing the flooding topology. This is distributed to the other nodes in the area through the Area System IDs TLV and the Flooding Path TLV.

All nodes within the area then flood only on the flooding topology.

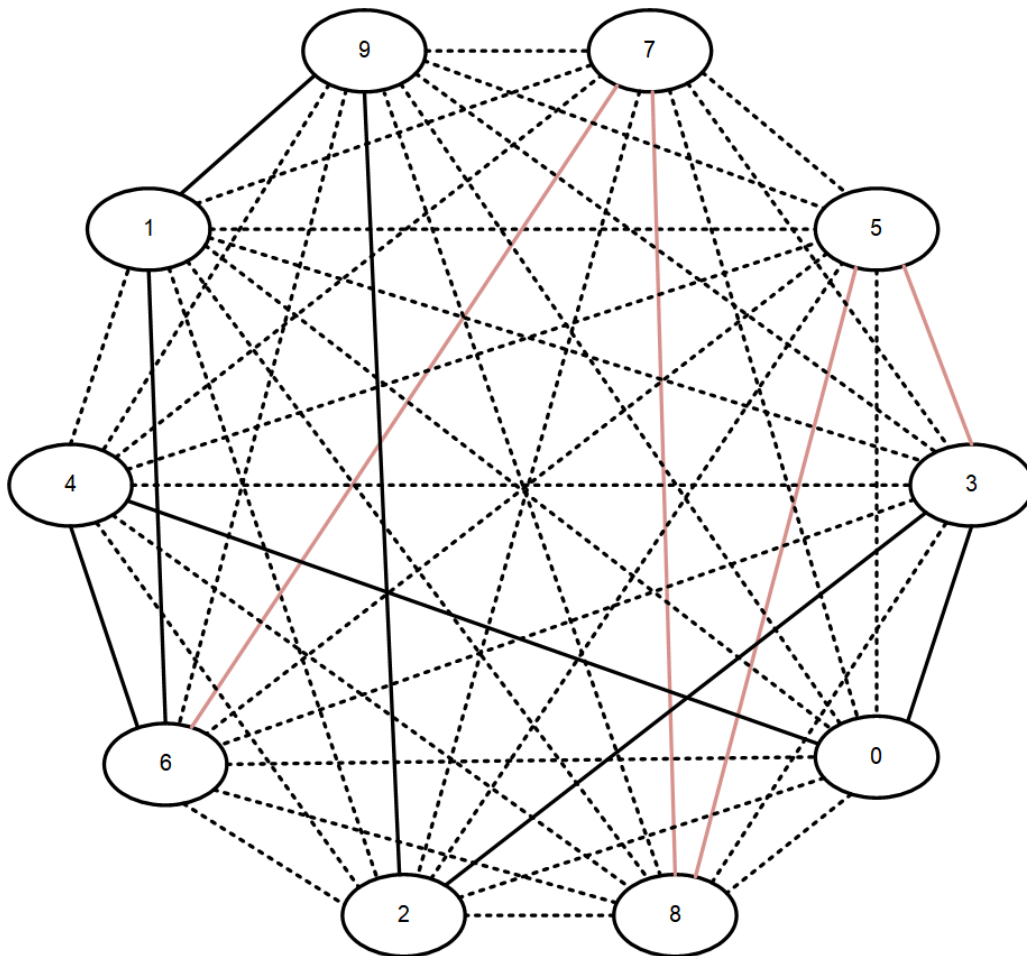

**Figure 53: Flooding Topology**

A flooding topology on a dense graph. The flooding topology is shown by the solid lines. Dotted lines indicate non-flooding links.

In a dense topology, this can reduce the amount of flooding by an order of magnitude or more, with a resulting increase in scalability.

#### 14.4.4.1 Platform Compatibility

IS-IS Dynamic Flooding is platform-independent.

#### 14.4.5 IS-IS Configuration

These sections describe IS-IS configuration tasks:

- [Enabling IS-IS](#)
- [Configuring IS-IS Optional Global Parameters](#)
- [Configuring Optional IS-IS Interface Parameters](#)
- [Configuring IS-IS Segment Routing](#)
- [Configuring Redistribution of DHCP for IS-IS Agent \(IPv6\)](#)
- [Disabling IS-IS](#)
- [Configuring IS-IS Graceful Restart \(GR\)](#)
- [TI-LFA FRR using IS-IS Segment-Routing Configuration](#)
- [IS-IS Dynamic Flooding Configuration](#)
- [Displaying IS-IS Information](#)

---

### 14.4.5.1 Enabling IS-IS

To enable IS-IS, each of the following tasks must be performed.

- [Enabling IS-IS Globally and Specifying an IS-IS Instance](#)
- [Configuring the Network Entity Title \(NET\)](#)
- [Setting the Address Family Configuration](#)
- [Enabling IS-IS on a Specified Interface](#)

#### 14.4.5.1.1 Enabling IS-IS Globally and Specifying an IS-IS Instance

The switch supports only one IS-IS routing instance per VRF. The routing instance uniquely identifies the switch to other devices. IS-IS configuration commands apply globally to the IS-IS instance.

The switch must be in router IS-IS configuration mode to run IS-IS configuration commands. The `router isis` command places the switch in router IS-IS configuration mode.

##### Example

- These commands create an IS-IS routing instance named Osiris in the default VRF and place the switch in IS-IS configuration mode for that instance.

```
switch(config)#router isis Osiris
switch(config-router-isis)#
```

#### 14.4.5.1.2 Configuring the Network Entity Title (NET)

After creating an IS-IS routing instance, configure the Network Entity Title (NET) with the `net` command. The NET defines the IS-IS area address and the system ID of the device.

##### Example

- These commands configure the NET by specifying the IS-IS area address and the system ID of the device.

```
switch(config)#router isis Osiris
switch(config-router-isis)#net 49.0001.1010.1040.1030.00
```

#### 14.4.5.1.3 Setting the Address Family Configuration

The `address-family` command enables the address families that IS-IS will route and places the switch in the configuration mode for that address family. The address families supported are IPv4 unicast and IPv6 unicast.

##### Example

- These commands enable and enter the address family mode for IPv4 unicast.

```
switch(config)#router isis Osiris
switch(config-router-isis)#address-family ipv4 unicast
switch(config-router-isis-af)#
```

#### 14.4.5.1.4 Enabling IS-IS on a Specified Interface

After enabling IS-IS globally, enable it on an interface with the `isis enable` command.

##### Example



- These commands enable IS-IS on Ethernet interface 4.

```
switch(config-router-isis)#interface ethernet 4
switch(config-if-Eth4)#isis enable Osiris
```

#### 14.4.5.2 Configuring IS-IS Optional Global Parameters

After globally enabling IS-IS, the following global parameters may be configured.

- [Setting the Router Type](#)
- [Configuring Redistribution of Connected or Static Non-ISIS Routes](#)
- [Configuring Redistribution of Connected or Static non-ISIS Routes into Level-1 or Level-2](#)
- [Configuring Redistribution of BGP Routes into ISIS](#)
- [Setting the Overload Bit](#)
- [Configuring IS-IS MD5 Authentication](#)
- [Setting the SPF Interval](#)
- [Configuring IS-IS Segment Routing Global Adjacency-SID](#)
- [Enabling Logging for Peer Changes](#)
- [Setting the IS-IS hostname](#)
- [Configuring IS-IS Multi-Topology](#)

##### 14.4.5.2.1 Setting the Router Type

The `is-type` command sets the routing level for an IS-IS instance.

###### Example

- These commands specify level-2 for the IS-IS instance.

```
switch(config)#router isis Osiris
switch(config-router-isis)#is-type level-2
switch(config-router-isis)#
```

##### 14.4.5.2.2 Configuring Redistribution of Connected or Static Non-ISIS Routes

The `redistribute (IS-IS)` command configures redistribution of connected or static non-ISIS routes.

###### Example

- These commands redistribute connected routes into the IS-IS domain.

```
switch(config)#router isis Osiris
switch(config-router-isis)#redistribute connected
switch(config-router-isis)#
```

##### 14.4.5.2.3 Configuring Redistribution of Connected or Static non-ISIS Routes into Level-1 or Level-2

Non-ISIS routes can be exported into level-1, level-2, or both using a route map. By default, the routes are exported only to level-2; to export to level-1 or to both levels, configure the route map using the `set isis level` command. The level-1 or level-2 routes can also be filtered using the route maps match statement. The route map is then used when redistributing routes in ISIS with the `redistribute (IS-IS)` command.

Use the `show isis database detail` command to make sure that the route shows up in the exported level.

###### Examples

- The following commands configure a route map called `rm` to set the IS-IS level to level-1, then use it to redistribute connected routes.

```
switch(config)#route-map rm
switch(config-route-map-rm)#set isis level level-1
switch(config-route-map-rm)#router isis osiris
switch(config-router-isis)#redistribute connected route-map rm
switch(config-router-isis)#
```

- The following command displays IS-IS database information and confirms that the level has been set to level-1.

```
switch#show isis database detail
ISIS Instance: inst1 VRF: default
ISIS Level 1 Link State Database
LSPID Seq Num Cksum Life IS Flags
1111.1111.1001.00-00 10 63306 751 L2 <>
NLPID: 0xCC(IPv4) 0x8E(IPv6)
Area address: 49.0001
<-----OUTPUT OMITTED FROM EXAMPLE----->
```

#### 14.4.5.2.4 Configuring Redistribution of BGP Routes into ISIS

The `redistribute bgp route-map` command redistributes the BGP routes from the specified route map into IS-IS. Only one route map can be specified; reissuing the command overrides any previous configuration.

The `no redistribute bgp` and `default redistribute bgp` commands disable BGP route redistribution from the specified domain by removing the `redistribute bgp` statement from *running-config*.

The command is available in both router IS-IS configuration mode and the address-family submode. The command is rejected if configured in both modes at the same time. Issuing the `no` or `default` command in router IS-IS configuration mode has no effect on redistribution configured in the address-family submode.

 **Note:** If the command is configured in an address-family submode, it only redistributes routes from that address family. If it is configured in router-ISIS mode, it applies to all enabled address families.

#### Examples

- These commands redistribute IPv4 BGP routes from the route map called `bgp-to-isis-v4` into the ISIS domain.

```
switch(config)#router isis 1
switch(config-router-isis)#address-family ipv4
switch(config-router-isis-af)#redistribute bgp route-map bgp-to-isis-v4
switch(config-router-isis-af)#
```

- These commands redistribute all BGP routes from the route map `bgp-to-isis` into ISIS.

```
switch(config)#router isis 1
switch(config-router-isis)#redistribute bgp route-map bgp-to-isis
```

#### 14.4.5.2.5 Setting the Overload Bit

The `set-overload-bit` command used without the `on-startup` option, informs other devices not to use the local router to forward transit traffic. When used with the `on-startup` option, the overload bit is set for the interval specified after startup.

In scenarios when Border Gateway Protocol (BGP) routes are resolved using an Interior Gateway Protocol (IGP), if the transit router reboots and becomes available again, the IGP will consider the transit router as an optimal path again. After rebooting, the transit router will blackhole traffic until the transit router learns the external destination reachability information via BGP.

### Examples

- These commands configure the switch and sets the overload bit to 120 seconds after startup.

```
switch(config)#router isis Osiris
switch(config-router-isis)#set-overload-bit on-startup 120
switch(config-router-isis)#
```

- These commands configure the overload bit until BGP converges. If BGP fails to converge within the set timeout default period, then the overload bit gets cleared.

```
switch(config)#router isis Osiris
switch(config-router-isis)#set-overload-bit on-startup wait-for-bgp
switch(config-router-isis)#set-overload-bit on-startup wait-for-bgp
timeout 750
switch(config-router-isis)#
```

#### 14.4.5.2.6 Configuring IS-IS MD5 Authentication

To configure authentication for the IS-IS instance causing LSPs, CSNPs and PSNPs to be authenticated, use the `authentication mode` and `authentication key` commands. To configure authentication on the interface, causing IS-IS Hellos to be authenticated, use the `isis authentication mode` and `isis authentication key` commands on the interface.

Two forms of authentication are supported by the IS-IS routing protocol: Clear-text authentication and MD5 authentication. The difference between the two forms of authentication is in the level of security provided. In the case of clear-text authentication, the password is specified as text in the authentication TLV, making it possible for an attacker to break authentication by sniffing and capturing IS-IS PDUs on the network. Arista recommends using the MD5 authentication.

HMAC MD5 authentication provides much stronger authentication by computing the message digest (on the IS-IS PDU contents) using the secret key to produce a hashed message authentication code (HMAC). Different modes of authentication can be specified on the interface, which authenticates IHH PDUs (IS-IS hello PDUs), and globally in the router IS-IS mode, in which the LSPs, CSNPs and PSNPs are authenticated. Area-wide and domain-wide authentication can be specified for L1 and L2 routers respectively.

### Example

- These commands configure authentication for the IS-IS instance causing LSPs, CSNPs and PSNPs to be authenticated.

```
switch(config)#router isis 1
switch(config-router-isis)#authentication mode md5
switch(config-router-isis)#authentication key secret
switch(config-router-isis)#
```

- These commands configure authentication on the interface causing IS-IS Hellos to be authenticated.

```
switch(config)#interface Ethernet 3/6
switch(config-if-Et3/6)#isis authentication mode text
switch(config-if-Et3/6)#isis authentication key 7 cAm28+9a/xPi0
4o7hjd8Jw==
switch(config-if-Et3/6)#
```

---

To maximize interoperability, Arista recommends using the same key in both interface mode and in router isis mode.

#### 14.4.5.2.7 Setting the SPF Interval

The SPF timer interval defines the maximum interval between two successive SPF calculations. IS-IS runs SPF calculations following a change in the network topology or the link-state database. The `spf-interval` command defines the following intervals:

- **Maximum wait interval:** The maximum time a switch will wait before running an SPF after a topology change.
- **Initial wait interval:** In a network that has been stable throughout the hold interval, this interval defines the initial wait time of a switch for performing an SPF calculation after a topology change. As several link-state updates must be sent after a topology change, the initial wait interval allows the network to settle before a switch computes an SPF. If the topology changes during an initial wait interval, an SPF is calculated after the initial wait interval expires and no further changes are made to throttle timers.
- **Hold time:** This interval delays SPF calculations during network instability. If the topology changes during a hold time, an SPF is computed when the hold time expires. Subsequent hold intervals are doubled up to the configured maximum wait interval for continuous topology changes. If the next topology change occurs after the hold interval expires, the hold interval is reset to its configured value and the SPF is computed after the initial wait interval.

 **Note:** EOS does not support configuring topology-specific SPF timers in multi-topology deployments and IS-IS level-specific SPF timers.

#### Example

This command configures maximum wait interval, initial wait interval, and hold time to 10 seconds, 2000 ms, and 1000 ms respectively.

```
switch(config)#router isis inst1
switch(config-router-isis)#spf-interval 10 2000 1000
```

#### 14.4.5.2.8 Configuring IS-IS Segment Routing Global Adjacency-SID

IS-IS Segment Routing (SR) supports global adjacency SIDs for point-to-point interfaces. The adjacency SID is configured as an index using the adjacency-segment command.

Global adjacency segments are represented using an index instead of actual MPLS labels. The index is an offset into the Segment Routing Global Block (SRGB) advertised by a router, resulting in an MPLS label. The default value of SRGB in EOS is Base: 900000 and Size: 65536.

The same index may be used to configure multiple interfaces so that MPLS forms an ECMP group, and the same index may be applied to IPv4 and IPv6 adjacencies.

#### Example

- In this example, the global adjacency is configured on a point-to-point interface Ethernet Et1, with an index value 10.

```
switch(config-if-Et1)#adjacency-segment ipv4 p2p index 10 global
```

#### Displaying Adjacency SID Information

The command `show isis segment-routing adjacency-segments` displays the global adjacency SID value and other related information.

#### Examples

- In this example an interface is configured as follows:

```
interface Ethernet1
 ip address 1.1.1.1/24
 ipv6 address 1000::1/64
 isis enable isis1
 isis network point-to-point
 adjacency-segment ipv4 p2p index 1 global
 adjacency-segment ipv6 p2p index 2 global
```

- The show output for the above interface configuration:

```
Switch#show isis segment-routing adjacency-segments

System ID: 1000.0000.0002 Instance: isis1
SR supported Data-plane: MPLS SR Router ID: 1.1.1.4
Adj-SID allocation mode: SR-adjacencies
Adj-SID allocation pool: Base: 100000 Size: 16384
Adjacency Segment Count: 2
Flag Descriptions: F: Ipv6 address family, B: Backup, V: Value
 L: Local, S: Set

Segment Status codes: L1 - Level-1 adjacency, L2 - Level-2 adjacency, P2P -
Point-to-Point adjacency, LAN - Broadcast adjacency

Locally Originated Adjacency Segments
Adj IP Address Local Intf SID SID Source Flags Type

1.1.1.2 Et1 1 Configured F:0 B:0 V:0 L:0 S:0 P2P L1
fe80::1:ff:fe65:0 Et1 2 Configured F:1 B:0 V:0 L:0 S:0 P2P L1

Received Global Adjacency Segments
SID Originator Neighbor Flags

0 rtrmpls1 1000.0000.0002 F:0 B:0 V:0 L:0 S:0
```

#### 14.4.5.2.9 Enabling Logging for Peer Changes

The `log-adjacency-changes (IS-IS)` command configures the switch to send syslog messages when it detects IS-IS neighbor adjacency state changes.

##### Example

- These commands configure the switch to send a syslog message when a neighbor goes up or down.

```
switch(config)#router isis Osiris
switch(config-router-isis)#log-adjacency-changes
switch(config-router-isis)#
```

#### 14.4.5.2.10 Setting the IS-IS hostname

The `is-hostname` command configures the use of a human-readable string to represent the symbolic name of an IS-IS router. It also changes the output of IS-IS show commands, to show the IS-IS hostname in place of system IDs if the corresponding IS-IS hostname is known. However, syslogs still use IS-IS system IDs and not the IS-IS hostname.

By default if there's a hostname configured on the switch, it is used as the IS-IS hostname. It is also possible to deconfigure an assigned hostname for IS-IS using the `no is-hostname` command. When the IS-IS hostname is removed, the switch goes back to using the switch's hostname as the IS-IS hostname.

##### Examples

- These commands configure the IS-IS hostname to the symbolic name ishost1 for the IS-IS router.

```
switch(config)#router isis inst1
switch(config-router-isis)#is-hostname ishost1
switch(config-router-isis)#
```

- These commands unconfigure the IS-IS hostname of the symbolic name ishost1 for the IS-IS router.

```
switch(config)#router isis inst1
switch(config-router-isis)#no is-hostname ishost1
switch(config-router-isis)#
```

#### 14.4.5.2.11 Configuring IS-IS Multi-Topology

The `multi-topology` command configures IS-IS Multi-Topology (MT) support (disabled by default), enabling an IS-IS router to compute a separate topology for IPv4 and IPv6 links in the network. With MT configured, not all the links in a network need to support both IPv4 and IPv6. Some can support IPv4 or IPv6 individually. The IPv4 SPF will install IPv4 routes using the IPv4 topology, and similarly, the IPv6 SPF will install IPv6 routes using the IPv6 topology. Without MT support, all links in an IS-IS network need to support the same set of address families.

When MT is enabled, and each link has a separate IPv4 metric and IPv6 metric.

The `isis ipv6 metric` command configures the IPv6 metric.

The `isis multi-topology` command configures the IPv4 or IPv6 address family individually on an interface with both IPv4 and IPv6 addresses.

The address families that are enabled on an interface are based on the global address families enabled in router IS-IS configuration mode, and the addresses configured on the interface. To enable a particular address family on an interface, it needs to have an address configured in that address family. In the case where both IPv4 and IPv6 address families are enabled in router IS-IS configuration mode, then if an interface has IPv4 and IPv6 addresses, both IPv4 and IPv6 address families are enabled on that interface. In the case of an interface with only an IPv4 address family, the IPv4 address family is enabled on that interface. Where an interface only has an IPv6 address family, the IPv6 address family is enabled on that interface. Finally, where only the IPv6 address family is enabled in router IS-IS config mode and MT is enabled, then the IPv6 address family is enabled on all interfaces which have an IPv6 address configured.

#### Examples

- These commands configure MT for the IS-IS router.

```
switch(config)#router isis 1
switch(config-router-isis)#address-family ipv6 unicast
switch(config-router-isis-af)#multi-topology
switch(config-router-isis-af)#
```

- These commands unconfigure MT for the IS-IS router.

```
switch(config)#router isis 1
switch(config-router-isis)#address-family ipv6 unicast
switch(config-router-isis-af)#no multi-topology
switch(config-router-isis-af)#
```

- These commands configure the IPv6 metric.

```
switch(config)#interface Ethernet 5/6
switch(config-if-Et5/6)#isis ipv6 metric 30
switch(config-if-Et5/6)#
```

- These commands configure the IPv4 address family on an interface with both IPv4 and IPv6 addresses.

```
switch(config)#interface Ethernet1
switch(config-if-Et1)#isis multi-topology address-family ipv4 unicast
switch(config-if-Et1)#
```

- These commands configure the IPv6 address family on an interface with both IPv4 and IPv6 addresses.

```
switch(config)#interface Ethernet1
switch(config-if-Et1)#isis multi-topology address-family ipv6 unicast
switch(config-if-Et1)#
```

- These commands configure both the IPv4 and IPv6 address families on an interface.

```
switch(config)#interface Ethernet1
switch(config-if-Et1)#no isis multi-topology address-family unicast
switch(config-if-Et1)#
```

### 14.4.5.3 Configuring Optional IS-IS Interface Parameters

After globally enabling IS-IS, the following parameters may be configured on individual interfaces.

- [Setting the Hello Packet Interval](#)
- [Configuring the Hello Multiplier for the Interface](#)
- [Configuring the IS-IS Metric](#)
- [Setting the LSP Transmission Interval](#)
- [Setting the IS-IS Priority](#)
- [Configuring an Interface as Passive](#)
- [Configuring BFD support for IS-IS for IPv4](#)

#### 14.4.5.3.1 Setting the Hello Packet Interval

The `isis hello-interval` command sets the time interval between the hello packets that maintain an IS-IS adjacency.

##### Example

- These commands configure a hello interval of 60 seconds for Ethernet 4.

```
switch(config)#interface ethernet 4
switch(config-if-Et4)#isis hello-interval 60
switch(config-if-Et4)#
```

#### 14.4.5.3.2 Configuring the Hello Multiplier for the Interface

The switch maintains the adjacency by sending/receiving hello packets. When receiving no hello packets from the peer within a time interval, the local switch considers the neighbors invalid.

The `isis hello-multiplier` command calculates the hold time announced in hello packets by multiplying this number with the configured `isis hello-interval`.

##### Example

- These commands configure a hello multiplier of 5 for Ethernet 4.

```
switch(config)#interface ethernet 4
switch(config-if-Et4)#isis hello-interval 60
```

```
switch(config-if-Et4)#isis hello-multiplier 5
switch(config-if-Et4)#
```

#### 14.4.5.3.3 Configuring the IS-IS Metric

The `isis metric` command sets the cost for sending information over a specific interface. At present only wide metrics are supported.

##### Example

These commands configure a metric cost of 30 for sending information over Ethernet 5.

```
switch(config)#interface ethernet 5
switch(config-if-Et5)#isis metric 30
switch(config-if-Et5)#
```

#### 14.4.5.3.4 Setting the LSP Transmission Interval

The `isis lsp tx interval` command configures the minimum interval between successive LSP transmissions on an interface.

##### Example

- This command sets the LSP transmission interval on interface Ethernet 5 to 50 milliseconds.

```
switch(config)#interface ethernet 5
switch(config-if-Et5)#isis lsp tx interval 50
switch(config-if-Et5)#
```

#### 14.4.5.3.5 Setting the IS-IS Priority

The `isis priority` command determines which device will be the Designated Intermediate System (DIS). The device with the highest priority on the LAN will become the DIS.

##### Example

- These commands configure a device priority of 60 on interface Ethernet 5.

```
switch(config)#interface ethernet 5
switch(config-if-Et5)#isis priority 60
switch(config-if-Et5)#
```

#### 14.4.5.3.6 Configuring an Interface as Passive

The `isis passive` and `passive (IS-IS)` commands configure IS-IS interfaces as passive to interfaces where adjacencies are wanted. The interface does not send or receive IS-IS packets when configured as passive.

##### Examples

- These commands configure Ethernet interface 10 as a passive interface.

```
switch(config)#interface ethernet 10
switch(config-if-Et10)#isis passive
switch(config-if-Et10)#
```

- These commands configure Ethernet interface 10 as a passive interface in the router IS-IS mode.

```
switch(config)#router isis Osiris
switch(config-router-isis)#passive interface ethernet 10
```



```
switch(config-router-isis)#
```

#### 14.4.5.3.7 Configuring BFD support for IS-IS for IPv4

The `isis bfd` and `bfd all-interfaces` commands configure Bidirectional Forwarding Detection (BFD). BFD is supported for both IS-IS IPv4 and IPv6 routes.

##### Examples

- These commands enable BFD (for the IPv4 address family) for all the interfaces on which IS-IS is enabled. By default, BFD is disabled on all interfaces.

```
switch(config)#router isis 1
switch(config-router-isis)#address-family ipv4
switch(config-router-af)#bfd all-interfaces
switch(config-router-af)#
```

- These commands enable BFD on an IS-IS interface.

```
switch(config)#interface Ethernet 5/6
switch(config-if-Et5/6)#isis bfd
switch(config-if-Et5/6)#
```

#### 14.4.5.4 Configuring IS-IS Segment Routing

Global IS-IS Segment Routing (IS-IS SR) commands are accessed in Segment-Routing MPLS mode, under the router IS-IS configuration mode. Interface-specific IS-IS SR commands are accessed in interface configuration mode.

##### 14.4.5.4.1 Starting the MPLS Agent

The routing information base (RIB) or IS-IS agent provides IS-IS segment routing, but the actual installation of LFIB entries pertaining to SR information provided by IS-IS is handled by the MPLS agent in EOS, which is disabled by default. To enable the MPLS agent, use the following commands.

 **Note:** IP(v6) routing must be enabled as a prerequisite.

##### Example

- The following commands enable IP routing and the MPLS agent on the switch.

```
switch(config)#ip routing
switch(config)#mpls ip
switch(config)#
```

##### 14.4.5.4.2 Enabling IS-IS SR

By default, IS-IS SR is disabled. You must enable it explicitly by issuing the `no shutdown (IS-IS SR)` command in Segment-Routing MPLS configuration mode.

##### Example

- The following commands enable IS-IS SR.

```
switch(config)#router isis instance1
switch(config-router-isis)#segment-routing mpls
switch(config-router-isis-sr-mpls)#no shutdown
switch(config-router-isis-sr-mpls)#
```

#### 14.4.5.4.3 Disabling IS-IS Segment Routing

To administratively disable IS-IS SR, issue the `shutdown (IS-IS SR)` command in Segment-Routing MPLS configuration mode. To disable IS-IS SR and delete all IS-IS SR configuration, issue the `no segment-routing mpls` command in router ISIS configuration mode.

##### Example

- The following commands administratively disable IS-IS SR.

```
switch(config)#router isis instance1
switch(config-router-isis)#segment-routing mpls
switch(config-router-isis-sr-mpls)#shutdown
switch(config-router-isis-sr-mpls)#
```

- The following commands disable IS-IS SR and delete all IS-IS SR configuration.

```
switch(config)#router isis instance1
switch(config-router-isis)#no segment-routing mpls
switch(config-router-isis)#
```

#### 14.4.5.4.4 SRGB (Segment Routing Global Range)

The global segments such as Prefix-SID, Node-SID, Proxy-node-SID are represented using indices of actual MPLS labels. These indices are offset on the SRGB advertised by a router to derive the respective MPLS label. The default value of SRGB in EOS is Base: 900000, Size: 65536. In other words, the labels that any global segment could represent is between 900000-965535. The MPLS label range is categorized and reserved into pools based on the applications using these labels. The default values of label ranges in these pools are:

- Dynamic Global Range--(100000) (262144)
- IS-IS SR Global Range -- (900000) (65536)
- Static Global Range -- (16) (99984)



**Note:** SRGB can be configured to fit in different MPLS ranges as long as it does not fall under an MPLS range already assigned for usage by other applications.

##### Example

```
switch(config)#mpls label range isis-sr 900000 65536
```

#### 14.4.5.4.5 Configuring Node-SID

Node segments are indices associated with routers within an IS-IS SR domain. This is done by associating node-segments with prefix mask length /32 (IPv4) or /128 (IPv6) addresses. Node segments are carried as sub-TLVs (type-length-value) in IP reachability TLVs for the prefixes with which these segments are associated. Node segments are configured on IS-IS enabled Loop-back interface(s) as shown in the example below.

##### Examples

- The following commands are used to associate a node-segment with an IPv4 address.

```
switch(config)#int loopback 1
switch(config-if-Lo1)#ip address 21.1.1.1/32
switch(config-if-Lo1)#node-segment ipv4 index 5
```

- The following commands are used to associate a node-segment with an IPv6 address.

```
switch(config)#int loopback 1
switch(config-if-Lo1)#ipv6 add 2000::24/128
```

```
switch(config-if-Lo1)#node-segment ipv6 index 5
```

- The following example shows a warning thrown at the CLI when a /32 or /128 address is not configured on the interface.

```
switch(config)#int loopback 1
switch(config-if-Lo1)#ip address 21.1.1.1/24
switch(config-if-Lo1)#node-segment ipv4 index 1
! /32 IPv4 address is not configured on the interface
```

- The following command removes the node-segment from IS-IS SR from an interface.

```
switch(config-if-Lo1)#no node-segment ipv4 index 1
```

#### 14.4.5.4.6 Configuring Prefix-SIDs

Prefix segments are associated with any IS-IS prefix a router is originating an IP Reachability TLV for. These segments are carried as sub-TLVs in IP Reachability TLVs of the prefixes with which these segments are associated. Prefix segments are configured under segment-routing MPLS configuration mode in IS-IS.

 **Note:** The configured prefix segment is effective, only if, the prefix for which a prefix-SID configured becomes a part of IS-IS by enabling IS-IS on interfaces, or by redistribution from other protocols etc.

#### Example

- The following commands are used to associate a prefix segment with an IPv4 address with index value of 50.

```
switch(config)#router isis instance1
switch(config-router-isis)#segment-routing mpls
switch(config-router-isis-sr-mpls)#prefix-segment 1.1.1.0/24 index 50
```

#### 14.4.5.4.7 Configuring Proxy-Node SIDs

Node segments represent a device (node) by attaching a segment (index) with a /32, /128 prefix which generally is configured on a loopback interface. There are routers which do not support segment routing, and there might be a situation where it is required to assign node identifiers on such routers. To overcome this shortfall, a router that supports IS-IS SR is made to proxy by configuring a proxy-node-SID for a IS-IS prefix originating from the router that does not support IS-IS SR.

#### Example

- A proxy-node SID associates a /32 or a /128 route with an SID as shown below.

```
switch(config)#router isis instance1
switch(config-router-isis)#segment-routing mpls
switch(config-router-isis-sr-mpls)#proxy-node-segment 1.1.1.0/32 index 50
```

Although the general use case is to configure a proxy node segment on a router that is not originating the prefix with which we want to associate the proxy-node SID, it is not prohibited to configure one for self-originated prefixes.

Configuring proxy-node-SIDs enables a router to send out a Binding-SID TLV with details pertaining to the prefix and SID.

 **Note:** A Binding-SID can carry a range of prefixes and an associated range of SIDs, but at present the EOS does not support to configure such ranges with one binding segment TLV in

---

IS-IS SR. However, we do process ranges of prefixes and SIDs if received from devices that support such configurations.

#### 14.4.5.4.8 Configuring Anycast-SID

An Anycast-SID is a prefix segment that identifies a set of routers and not a specific router. It enforces the ECMP-aware shortest-path forwarding towards the closest node of the anycast set.

An example of such an anycast group could be a set of routers A1, A2, A3, and A4 where at least one router of A1, A2, A3, and A4 advertises the prefix SID corresponding to the anycast address (which can be a prefix originating on all of A1, A2, A3 and A4 a loop-back address, maybe).

In general use case, all the routers of the anycast group would have the same prefix-SID configured for the anycast IP address present on them.

 **Note:** That for Anycast-SID to work as expected, the SRGB on the members of the anycast group should be same.

#### 14.4.5.4.9 Configuring router-ID

A router that support IS-IS SR need to advertise its SR data-plane capability and the range of MPLS label values it uses for segment routing, this is advertised by inserting SR-Capability sub-TLV in the Router Capabilities TLV.

A Router Capability TLV is now sent in IS-IS LSPs when Segment routing is enabled and it is necessary for a Router Capability TLV to carry a router-ID. This router-ID could be configured in EOS under the segment routing MPLS configuration mode. If no router-ID is configured, the router automatically picks up the highest IPv4 address configured on the router for an router-ID.

#### 14.4.5.4.10 Configuring IS-IS Static Adjacency SID

Adjacency segments for IS-IS adjacencies are statically configured on the switch, so that these values are preserved even when the switch restarts. Static adjacency segments are configured per address family on any interface (including Port-Channel, VLANs and SVIs). They are configured and advertised as labels.

These are the few points to be considered while configuring the static adjacency SIDs:

- The same label can be configured on multiple interfaces so that MPLS can form ECMP, the same value can be applied to IPv4 and IPv6 adjacency.
- Static adjacency SID is applied only to p2p interface, and has local scope. When interface type changes to LAN, then dynamic adjacency SID is assigned.
- When Static adjacency SIDs are configured, then simply replace dynamic adjacency SIDs which are advertised to other routers and installed in the local LFIB.
- Static adjacency SID is applied regardless of Adjacency Segment Allocation Mode.
- When Static adjacency SID is disabled, then normal rules for dynamic adjacency SID is applied (it automatically applies a value based on Adjacency Segment Allocation Mode as described in IS-IS Segment Routing TOI document).

#### Example

```
switch(config-if-Et1) #adjacency-segment ipv4 p2p index 50 global
```

They can be a label (local) or index (global) and we can assign multiple adjacency segments per link.

Where label-value must be within the SR Local Block (SRLB) that can be found in the output of show mpls label range command as shown.

```
Start End Size Usage

```

|         |         |        |                |
|---------|---------|--------|----------------|
| 0       | 15      | 16     | reserved       |
| 16      | 99999   | 99984  | static mpls    |
| 100000  | 362143  | 262144 | free (dynamic) |
| 362144  | 899999  | 537856 | unassigned     |
| 900000  | 965535  | 65536  | isis-sr        |
| 900000  | 965535  | 65536  | bgp-sr         |
| 965536  | 1031071 | 65536  | srlb           |
| 1031072 | 1036287 | 5216   | unassigned     |
| 1036288 | 1048575 | 12288  | l2evpn         |

#### 14.4.5.4.11 Configuring Adjacency Segment Label Range

Adjacency Segments are MPLS labels assigned to IS-IS adjacencies. These labels are shared with other routers in the domain by adding them in adjacency-SID sub-TLVs which are inserted in neighbor Reachability TLVs in IS-IS.

The MPLS labels (adjacency segments) are incrementally allocated to adjacencies, as the transition to Up state, from a adjacent set of MPLS labels pre-allocated by MPLS agent. This label range extends from 100000 to 116383 (base: 100000, size: 16384) by default. This could be changed by the following configuration:

##### Example

```
switch(config)#mpls label range dynamic 200000 131072
```

The dynamic label pool is shared between LDP and IS-IS SR Adjacency Segments.

#### 14.4.5.4.12 Configuring Adjacency Segment Allocation Mode

Adjacency Segments are allocated to all IS-IS adjacencies based on the IS-IS routers that have advertised IS-IS SR capability or to none of the adjacencies. The command adjacency-segment allocation is used to configure this under the segment-routing MPLS configuration mode.

The default behavior is to allocate adjacency segments to adjacencies of SR supporting devices.

##### Example

```
switch(config-router-isis-sr-mpls)#adjacency-segment allocation sr-peer
```

#### 14.4.5.4.13 Adjacency Segment Persistence across Link Flaps

Adjacency segments are allocated to IS-IS adjacencies based on configured adjacency segment allocation mode mentioned above.

If an adjacency that has been allocated label L goes down, L is reserved for this adjacency for a duration of 3600 seconds from the time of the adjacency down event. Only the adjacency that owned this label before going down could reclaim label L in this duration.

#### 14.4.5.4.14 Troubleshooting IS-IS Segment Routing

- The `show tech-support ribd` command has a section starting with the string SR Book Keeper which has extensive information on state of IS-IS SR on the router.
- In-case, if IS-IS SR is configured but SR related TLVs/sub, but, TLVs are not being sent in IS-IS LSPs.
  - Ensure that MPLS has been enabled (MPLD IP) enabled.
  - Check if segment routing is administratively shut down.
  - A segment might have been configured for a prefix not yet being advertised in IS-IS.

- In case, if Adjacency Segments are not being advertised.
  - Check if the adjacency segment mode is correctly set.
  - Adjacency Mode is set to all SR supported interfaces (default setting) and the peer does not support SR.
- Generally, it is good to not have same prefix with different indices or same index with different prefixes. There are CLI prohibitions that ensure that a router is not sending out conflicting sets of prefixes and associated SIDs. As there is possibility of receiving conflicting prefix-segments from other devices, there are ways to resolve the following three types of conflicts: prefix+SID conflict, SID conflict and prefix conflict.
  - Prefix+SID Conflict: When there are two prefix segments which have both the prefix and SID have same values, the one from the higher system ID is chosen for LFIB processing.
  - Prefix Conflict: If the two prefix segments which have same Prefix are from two different system than the one from higher system ID is chosen. If they are originated from same system ID than we choose the prefix segment of smaller SID.
  - SID Conflict: If the two prefix segments which have same SID are from two different system than the one from higher system ID is chosen. If they are originated from same system than the one which is of smaller prefix length is chosen. If prefix length is also same than the one with smaller address is chosen.

For a given prefix, if both a proxy-node segment and prefix-SID are received, the prefix-SID advertised is preferred while the proxy-node segment is ignored.

The `show tech-support ribd` displays detail information about IS-IS SRs internal state, and more information on conflicts and chosen active segments could be found under the SR Book Keeper section of `show tech-support ribd` command as shown.

```
Received Prefix Segments:

```

| Prefix      | Value | Index/Label | Type   | SystemID       | spfgen |
|-------------|-------|-------------|--------|----------------|--------|
| *1.0.3.0/24 | 3     | Index       | Prefix | 1111.1111.1002 | 0      |
| *1.0.5.1/32 | 0     | Index       | Node   | 1111.1111.1002 | 0      |
| *1.0.6.1/32 | 2     | Index       | Node   | 1111.1111.1003 | 39     |
| *1.0.7.1/32 | 14    | Index       | Node   | 1111.1111.1001 | 39     |
| #1.0.7.1/32 |       |             |        |                |        |

10 Index Proxy 1111.1111.1003 39

#### 14.4.5.5 Configuring Redistribution of DHCP for IS-IS Agent (IPv6)

The `redistribute dhcp` command redistributes DHCPv6 routes in IS-IS when using multi-agent routing protocol mode.

The `redistribute dhcp` command enables DHCP route redistribution in IS-IS when using the multi-agent routing protocol mode.

- These commands redistribute IPv6 DHCP routes into the ISIS domain.

```
switch(config)#router isis 1
switch(config-router-isis)#address-family ipv6
switch(config-router-isis-af)#redistribute dhcp
switch(config-router-isis-af)#
```

- The following command shows the DHCPv6 routes distributed into IS-IS.

```
switch(config)#show isis database detail
IS-IS Instance: inst1 VRF: default
IS-IS Level 1 Link State Database
```

```

LSPID Seq Num Cksum Life IS Flags
1111.1111.1001.00-00 10 19778 1101 L1 <>
...
 Reachability (MT-IPv6): 3ffe:701:ffff:101::10/128 Metric: 0 Type:
1 Up
...

```

#### 14.4.5.6 Disabling IS-IS

An IS-IS instance can be shut down globally or can be disabled on individual interfaces.

The `shutdown (IS-IS)` command shuts down an IS-IS instance globally.

##### Example

- These commands disable IS-IS globally without modifying the IS-IS configuration.

```

switch(config)#router isis Osiris
switch(config-router-isis)#shutdown
switch(config-router-isis)#

```

The `no isis enable` command disables IS-IS on an interface.

##### Example

- These commands disable IS-IS on interface Ethernet 4.

```

switch(config-router-isis)#interface ethernet 4
switch(config-if-Eth4)#no isis enable

```

#### 14.4.5.7 Configuring IS-IS Graceful Restart (GR)

By default, IS-IS graceful restart is disabled. Use the graceful-restart command to configure graceful restart on an IS-IS router. By default IS-IS graceful-restart-helper functionality is enabled, and to disable it use no graceful-restart-helper command.

##### Examples

- In this example IS-IS graceful restart is configured with t2 wait time of 30 seconds for level-1 routes.

```

switch(config)#router isis 1
switch(config-router-isis)#graceful-restart t2 level-1 30

```

t2 is the maximum wait time for the LSP database to synchronize (SPF computation is not done while t2 is running). t2 can be configured for either level-1 or level-2 through the CLI. The default value is 30 seconds, and the allowed configuration range is 5 to 300 seconds.

- In this example an ISIS graceful restart is configured with restart-hold-time of 50 seconds.

```

switch(config)#router isis 1
switch(config-router-isis)#graceful-restart restart-hold-time 50

```

In case of a planned restart, the hold time advertised by the IS-IS router prior to restart should be greater than the time for which the router is expected to be offline. Otherwise, neighboring routers will bring down the adjacency before the restarting router has a chance to send a restart request in its hello packet, which may result in traffic loss.

In case of ASU2, the IS-IS router instance will advertise a hello hold time of <restart-hold-time> on those interfaces for which the configured hold time is less than restart-hold-time. This is done just before the router restarts.



**Note:** Once the router has restarted, the routers advertised hello hold time will depend on the hello-interval and hello-multiplier configuration on each interface as before. By default, the restart-hold-time is disabled.

For Graceful Restart to be successful, the hold time advertised by the router should be greater than the time it takes for Graceful Restart to complete. If the restarting router is DIS, hold time advertised is 1/3rd of the configured value (default is 9s). We recommend increasing the hold time for the DIS to a higher value before a planned restart; otherwise, it may result in traffic loss.

## 14.4.5.8 TI-LFA FRR using IS-IS Segment-Routing Configuration

### 14.4.5.8.1 Configuring Link or Node Protection on a Specific Interface

To enable link or node protection for node segments and Adjacency segments learned on a specific IS-IS interface, use the following command in the interface configuration mode.

```
switch(config-if-Et1)#[no|default] isis fast-reroute ti-lfa mode
{link-protection|node-protection|disabled} [level-1|level-2]
```

The interface TI-LFA configuration inherits the address-family sub-mode configuration by default.

On an L1-L2 router, the **[level-1|level2]** optional keyword in both the router IS-IS address-family sub-mode and interface configuration mode CLIs is used to restrict protection to node segments and Adjacency segments learned through either level-1 or level-2 topologies only.

### 14.4.5.8.2 Configuring Link or Node Protection on a Specific Interface

To enable link or node protection for node segments and Adjacency segments learned on a specific IS-IS interface, use the following command in the interface configuration mode.

```
switch(config-if-Et1)#[no|default] isis fast-reroute ti-lfa mode
{link-protection|node-protection|disabled} [level-1|level-2]
```

The interface TI-LFA configuration inherits the address-family sub-mode configuration by default.

On an L1-L2 router, the **[level-1|level2]** optional keyword in both the router IS-IS address-family sub-mode and interface configuration mode CLIs is used to restrict protection to node segments and Adjacency segments learned through either level-1 or level-2 topologies only.

### 14.4.5.8.3 Configuring a Local LFIB Convergence Delay for Protected Node or Adjacency Segments

The point of local repair (PLR) switches to the TI-LFA backup path on link failure or BFD neighbor failure but switches back to the post-convergence path once the PLR computes SPF and updates its LFIB. This sequence of events can lead to micro-loops in the topology if the PLR converges faster than other routers along the post-convergence path. So a configuration option is provided to apply a delay, after which the LFIB route being protected by the TI-LFA loop-free repair path will be replaced by the post-convergence LFIB route.

To configure a convergence delay only to LFIB routes that are being protected, the following command is used either in the router IS-IS mode or the router IS-IS address-family sub-mode. A default of 10 seconds is used when using the command without an explicitly specified delay.



```
switch (config-router-isis-af)#timers local-convergence-delay [delay_in_seconds]
protected-prefixes
```

#### 14.4.5.8.4 Making Locally-originated Adjacency Segments Backup Eligible

The PLR computes backup paths for an adjacency segment only if the Adjacency SID sub-TLV has the B-flag (backup flag) set.

To set the B-flag in originated Adjacency SID sub-TLVs corresponding to adjacency segments dynamically allocated on the router, the following command is used in the segment-routing MPLS sub-mode in the router IS-IS mode.

```
switch(config-router-isis-sr-mpls)#adjacency-segment allocation [all-interfaces |
sr-peers]
```

To set the B-flag in originated Adjacency SID sub-TLVs corresponding to adjacency segments statically configured on the router, the following command is used in the interface configuration mode.

```
switch(config-if-Et1)#adjacency-segment [ipv4 | ipv6] p2p [multiple][label label |
index index] backup-eligible
```

**backup-eligible** is the newly introduced optional keyword in both the CLIs mentioned above that controls the setting of the B-flag in the Adjacency SID sub-TLV.

#### 14.4.5.8.5 Enabling SRLG Protection

To enable SRLG protection on all interfaces, use the **fast-reroute ti-lfa srlg** command. This command is used in addition to configuring link-protection or node-protection. If SRLG protection is enabled, the backup paths are computed after excluding all the links that share the same SRLG with the active link that is being used by all prefix segments and adjacency segments.

```
switch(config-router-isis-af)#fast-reroute ti-lfa srlg [strict]
```

If the optional argument **strict** is configured, the backup path is only programmed if a backup path that excludes all the SRLGs configured on the primary interface. If the keyword is not provided and an SRLG excluding path is not available, TI-LFA programs the backup path that excluded the maximum number of SRLGs possible.

To selectively disable SRLG protection on an interface, use the **isis [ipv4|ipv6] fast-reroute ti-lfa srlg disabled** command. This is useful if SRLG protection is enabled globally for all interfaces but needs to be selectively disabled for a specific interface.

```
switch(config-intf-et1)#isis [ipv4 | ipv6] fast-reroute ti-lfa srlg disabled
```

#### Sample Configuration

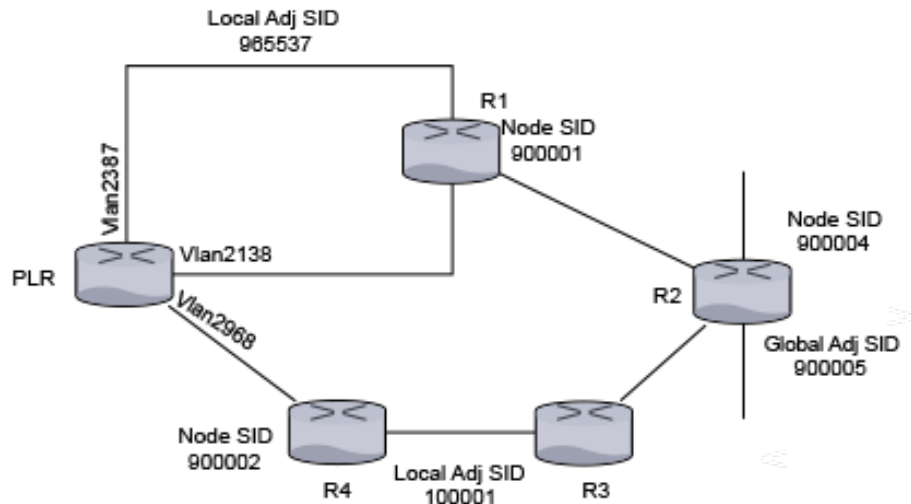

The above topology will be used to demonstrate the configuration and show command output.

**Figure 54: Sample Configuration**

The above topology is used to demonstrate the configuration and show command output. You will see the backup paths that the PLR computes to protect the node segments of R1 and R2, the global adjacency segment on R2, and the local adjacency segment on the **Vlan2387** on the PLR.

Here is a snippet of the configuration on the PLR.

```
switch(config)#interface vlan 2138
switch(config-if-Vl2138)#ip address 10.1.1.1/24
switch(config-if-Vl2138)#isis enable inst1
switch(config-if-Vl2138)#isis metric 11
switch(config-if-Vl2138)#isis network point-to-point

switch(config)#interface vlan2387
switch(config-if-Vl2138)#ip address 10.1.2.1/24
switch(config-if-Vl2138)#isis enable inst1
switch(config-if-Vl2138)#isis network point-to-point
switch(config-if-Vl2138)#adjacency-segment ipv4 p2p label 965537
backup-eligible

switch(config)#interface vlan2968
switch(config-if-Vl2968)#ip address 10.1.3.1/24
switch(config-if-Vl2968)#isis enable inst1
switch(config-if-Vl2968)#isis network point-to-point
switch(config-if-Vl2968)#isis fast-reroute ti-lfa mode disabled

...

switch(config)#router isis inst1
switch(config-isis)#net 49.0001.1111.1111.1001.00
switch(config-isis)#router-id ipv4 252.252.1.252
switch(config-isis)#is-type level-2
switch(config-isis)#timers local-convergence-delay 5000
protected-prefixes
!
switch(config-isis)#address-family ipv4 unicast
switch(config-isis-af)#fast-reroute ti-lfa mode node-protection
!
```

```

switch(config-isis)#segment-routing mpls
switch(config-isis-sr-mpls)#no shutdown
switch(config-isis-sr-mpls)#adjacency-segment allocation sr-peers
 backup-eligible
!
end

```

The protection of anycast segments does not need any new configuration. The above configuration enables protection of anycast segments.

To demonstrate the protection of anycast segments consider the following topology.

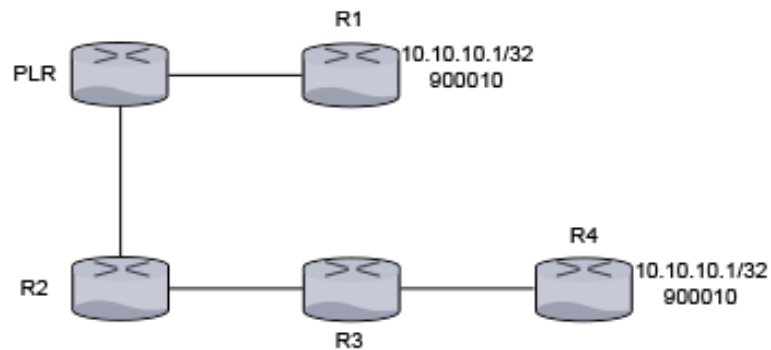

R1 and R4 are originators of the host prefix **10.10.10.1/32** and advertise prefix segment **900010**. Note that this should be configured as a prefix segment and not a node segment.

**Figure 55: Topology Number 2**

R1 and R4 are originators of the host prefix **10.10.10.1/32** and advertise prefix segment **900010**. This must be configured as a prefix segment and not a node segment.

R1 and R4's configuration should look similar to the following:

```

switch(config)#router isis inst1
switch(config-router-isis)#interface Loopback0
switch(config-if-Lo0)#ip address 10.10.10.1/32
switch(config-if-Lo0)#isis enable inst1

!
...
switch(config)#router isis inst1
switch(config-router-isis)#segment-routing mpls
switch(config-router-isis-sr-mpls)#prefix-segment 10.10.10.1/32
 index 10
!

```

The prefix in the prefix-segment command must belong to an interface enabled with IS-IS or must be an active route in the RIB of another protocol redistributed into IS-IS.

When the link or node protection is configured on the PLR, then the primary path to the segment 900010 is PLR - R1 and the backup path is PLR - R2 - R3 - R4. In other words, the destination in the backup path is the segment originated by R4 as the segment originated by R1 and is not reachable when link PLR-R1 or the node R1 goes down.

### 14.4.5.9 IS-IS Dynamic Flooding Configuration

Configure Dynamic flooding using the `lsp flooding dynamic` command under the *router config* mode. For example:

```
switch(config)#router isis Amun
switch(config-router-isis)#net 49.0000.0000.3333.00
switch(config-router-isis)#is-hostname ip3
switch(config-router-isis)#lsp flooding dynamic
```

Dynamic flooding should be enabled on all routers in the area. To enable Dynamic Flooding on all routers, use the following command:

```
[no|default]lsp flooding dynamic[level-1|level-2]
```

If necessary, the area leader election process can be tuned or disabled with the commands:

```
[no|default]area leader[level-1|level-2]priority <0-255> area
leader[level-1|level-2]disabled
```

#### 14.4.5.9.1 Limitations

On a sparse topology, Dynamic Flooding is not effective and only adds overhead. Leaf-spine and Clos networks are appropriate dense topologies.

### 14.4.5.10 Displaying IS-IS Information

The following sections describe display and verification of IS-IS settings and of peer and connection configuration:

- [Displaying the Link State Database](#)
- [Displaying the Interface Information for the IS-IS Instance](#)
- [Displaying IS-IS Neighbor Information](#)
- [Displaying IS-IS Instance Information](#)
- [Displaying IS-IS Segment Routing Information](#)
- [Verifying IS-IS Graceful Restart \(GR\) Information](#)

#### 14.4.5.10.1 Displaying the Link State Database

To display the link state database of IS-IS, use the `show isis database` command.

##### Example

- This command displays the IS-IS link state database.

```
switch#show isis database
ISIS Instance: Osiris
 ISIS Level 2 Link State Database
 LSPID Seq Num Cksum Life IS Flags
 1212.1212.1212.00-00 4 714 1064 L2 <>
 1212.1212.1212.0a-00 1 57417 1064 L2 <>
 2222.2222.2222.00-00 6 15323 1116 L2 <>
 2727.2727.2727.00-00 10 15596 1050 L2 <>
 3030.3030.3030.00-00 12 62023 1104 L2 <>
 3030.3030.3030.c7-00 4 53510 1104 L2 <>
switch>
```

#### 14.4.5.10.2 Displaying the Interface Information for the IS-IS Instance

To display interface information related to the IS-IS instance, use the `show isis interface` command.

##### Example

- This command displays IS-IS interface information.

```
switch#show isis interface

ISIS Instance: Osiris
Interface Vlan20:
 Index: 59 SNPA: 0:1c:73:c:5:7f
 MTU: 1497 Type: broadcast
 Level 2:
 Metric: 10, Number of adjacencies: 2
 LAN-ID: 1212.1212.1212, Priority: 64
 DIS: 1212.1212.1212, DIS Priority: 64
Interface Ethernet30:
 Index: 36 SNPA: 0:1c:73:c:5:7f
 MTU: 1497 Type: broadcast
 Level 2:
 Metric: 10, Number of adjacencies: 1
 LAN-ID: 3030.3030.3030, Priority: 64
 DIS: 3030.3030.3030, DIS Priority: 64
switch>
```

#### 14.4.5.10.3 Displaying IS-IS Neighbor Information

To display general information for IS-IS neighbors that the device sees, use `show isis neighbors`.

##### Example

- This command displays information for IS-IS neighbors that the device sees.

```
switch#show isis neighbor
Inst Id System Id Type Interface SNPA State Hold
time
10 2222.2222.2222 L2 Vlan20 2:1:0:c:0:0 UP 30
10 1212.1212.1212 L2 Vlan20 2:1:0:d:0:0 UP 9
10 3030.3030.3030 L2 Ethernet30 2:1:0:b:0:0 UP 9
switch>
```

#### 14.4.5.10.4 Displaying IS-IS Instance Information

To display the system ID, Type, Interface, IP address, State and Hold information for IS-IS instances, use the `show isis summary` command. The command is also used to verify the configured maximum wait interval, initial wait interval, and hold time of SPF timers in IS-IS instances. This command also displays values of the current SPF interval, last level-1 SPF run, and last level-2 SPF run.

##### Example

- This command displays general information about IS-IS instances.

```
switch#show isis summary
ISIS Instance: Osiris
System ID: 1010.1040.1030, administratively enabled, attached
Internal Preference: Level 1: 115, Level 2: 115
External Preference: Level 1: 115, Level 2: 115
IS-Type: Level 2, Number active interfaces: 1
```

```

Routes IPv4 only
Last Level 2 SPF run 2:32 minutes ago
Area Addresses:
 10.0001
 level 2: number dis interfaces: 1, LSDB size: 1
switch>

```

- This command displays the SPF interval information about IS-IS instances.

```

switch(config-router-isis-af)#show isis summary

IS-IS Instance: 1 VRF: default
System ID: 0000.0000.0001, administratively enabled
Multi Topology disabled, not attached
IPv4 Preference: Level 1: 115, Level 2: 115
IPv6 Preference: Level 1: 115, Level 2: 115
IS-Type: Level 1 and 2, Number active interfaces: 0
Routes both IPv4 and IPv6

 Max wait(s) Initial wait(ms) Hold
interval(ms)
LSP Generation Interval: 5 50 50
SPF Interval: 2 1000 1000
Current SPF hold interval(ms): Level 1: 1000, Level 2: 1000
Last Level 1 SPF run 1 seconds ago
Last Level 2 SPF run 1 seconds ago
Authentication mode: Level 1: None, Level 2: None
Graceful Restart: Disabled, Graceful Restart Helper: Enabled
Area Addresses:
 49.0001
 level 1: number dis interfaces: 0, LSDB size: 1
 level 2: number dis interfaces: 0, LSDB size: 1

```

#### 14.4.5.10.5 Displaying IS-IS Segment Routing Information

IS-IS Segment Routing information is displayed using the following commands:

- `show isis database detail`
- `show isis segment-routing`
- `show isis segment-routing global-blocks`
- `show isis segment-routing prefix-segments`
- `show isis segment-routing prefix-segments self-originated`
- `show isis segment-routing adjacency-segments`
- `show mpls label ranges`
- `show mpls segment-routing bindings`
- `show mpls lfib route`
- `show mpls lfib route <label value>`

##### show isis database detail

The `show isis database detail` command provides a view of LSPDB of different devices in the IS-IS domain. The output displays the TLVs and sub-TLVs that are being self-originated or the ones that have been received from other routers.

##### Example

```

switch#show isis database detail
ISIS Instance: inst1 VRF: default
ISIS Level 2 Link State Database
LSPID Seq Num Cksum Life IS Flags
1111.1111.1001.00-00 10 63306 751 L2 <>

```

```

NLPID: 0xCC(IPv4) 0x8E(IPv6)
Area address: 49.0001
Interface address: 1.0.7.1
Interface address: 1.0.0.1
Interface address: 2000:0:0:47::1
Interface address: 2000:0:0:40::1
IS Neighbor : lf319.53 Metric: 10
 LAN-Adj-sid: 100000 flags: [L V] weight: 0 system ID: 1111.1111.100
2
IS Neighbor (MT-IPv6): lf319.53 Metric: 10
 LAN-Adj-sid: 100001 flags: [L V F] weight: 0 system ID:
1111.1111.1002
Reachability : 1.0.11.0/24 Metric: 1 Type: 1 Up
 SR Prefix-SID: 10 Flags: [R] Algorithm: 0
Reachability : 1.0.3.0/24 Metric: 1 Type: 1 Up
Reachability : 1.0.7.1/32 Metric: 10 Type: 1 Up
 SR Prefix-SID: 2 Flags: [N] Algorithm: 0
Reachability : 1.0.0.0/24 Metric: 10 Type: 1 Up
Reachability (MT-IPv6): 2000:0:0:4b::/64 Metric: 1 Type: 1 Up
 SR Prefix-SID: 11 Flags: [R] Algorithm: 0
Reachability (MT-IPv6): 2000:0:0:43::/64 Metric: 1 Type: 1 Up
Reachability (MT-IPv6): 2000:0:0:47::1/128 Metric: 10 Type: 1 Up
 SR Prefix-SID: 3 Flags: [N] Algorithm: 0
Reachability (MT-IPv6): 2000:0:0:40::/64 Metric: 10 Type: 1 Up
Router Capabilities: 252.252.1.252 Flags: []
 SR Capability: Flags: [I V]
 SRGB Base: 900000 Range: 65536
Segment Binding: Flags: [F] Weight: 0 Range: 1 Pfx 2000:0:0:4f::1/128
 SR Prefix-SID: 19 Flags: [] Algorithm: 0
Segment Binding: Flags: [] Weight: 0 Range: 1 Pfx 1.0.15.1/32
 SR Prefix-SID: 18 Flags: [] Algorithm: 0

```

### show isis segment-routing

The **show isis segment-routing** command displays the summary information on IS-IS SR status.

### Example

```

switch(config)#show isis segment-routing
System ID: 1111.1111.1002 Instance: inst1
SR supported Data-plane: MPLS SR Router ID: 252.252.2.252
SR Global Block(SRGB): Base: 900000 Size: 65536
Adj-SID allocation mode: SR-adjacencies
Adj-SID allocation pool: Base: 100000 Size: 16384
All Prefix Segments have : P:0 E:0 V:0 L:0
All Adjacency Segments have : F:0 B:0 V:1 L:1 S:0
ISIS Reachability Algorithm : SPF (0)
Number of ISIS segment routing capable peers: 3
Self-Originated Segment Statistics:
Node-Segments : 2
Prefix-Segments : 2
Proxy-Node-Segments : 0
Adjacency Segments :

```

### About the Output

The first line of the output shows the IS-IS system ID of this device and the name of the instance with which IS-IS is configured.

The supported data plane is shown against the SR supported Data-plane field whereas the Router ID being advertised in the Router Capability is mentioned in the SR Router ID Field.

The SRGB in use and the MPLS label pool being used for adjacency segment allocation are mentioned in this output. The current adjacency allocation mode which refers to whether we are allocating adjacency segments to all IS-IS adjacencies or only those adjacencies which support SR or None of the adjacencies is shown in the Adj-SID allocation mode field.

Flag contents of All Prefix Segments originated on this router, Flag contents of All Adjacency Segments originated on this router and supported IS-IS Reachability Algorithm have been provided through this command output and they carry the meaning as per the IS-IS SR IETF draft.

This show command provides a statistics related to IS-IS SR in terms of various counters ranging from number of IS-IS SR enabled peers, number of Node-SIDs, prefix-SIDs, proxy-node-segments and adjacency segments being originated on this router in IS-IS.

The **show isis segment-routing** command also provides information if segment routing has been administratively disabled as shown.

```
switch(config-router-isis-sr-mpls)#show isis segment-routing
! IS-IS (Instance: inst1) Segment Routing has been administratively
shutdown
```

### show isis segment-routing global-blocks

The **show isis segment-routing global-blocks** command lists the SRGBs in use by all SR supporting devices in IS-IS domain including the SRGB in use by IS-IS SR on this device.

#### Example

```
switch#show isis segment-routing global-blocks
System ID: 1111.1111.1002 Instance: inst1
SR supported Data-plane: MPLS SR Router ID: 252.252.2.252
SR Global Block(SRGB): Base: 900000 Size: 65536
Number of ISIS segment routing capable peers: 3
SystemId Base Size

1111.1111.1002 900000 65536
1111.1111.1001 900000 65536
```

### show isis segment-routing prefix-segments

The **show isis segment-routing prefix-segments** command provides the details of all prefix segments being originated as well the segments received from IS-IS SR speakers in the domain.

#### Example

```
switch#show isis segment-routing prefix-segments
System ID: 1111.1111.1002 Instance: inst1
SR supported Data-plane: MPLS SR Router ID: 252.252.2.252
Node: 2 Proxy-Node: 2 Prefix: 2 Total Segments: 6
Flag Descriptions: R: Re-advertised, N: Node Segment, P: no-PHP
E: Explicit-NULL, V: Value, L: Local
Segment status codes: * - Self originated Prefix, L1 - level 1, L2 - level 2
Prefix SID Type Flags SystemID Type

1.0.7.1/32 2 Node R:0 N:1 P:0 E:0 V:0 L:0 1111.1111.1001 L1
* 1.0.8.1/32 4 Node R:0 N:1 P:0 E:0 V:0 L:0 1111.1111.1002 L2
1.0.11.0/24 10 Prefix R:1 N:0 P:0 E:0 V:0 L:0 1111.1111.1001 L2
* 1.0.12.0/24 12 Prefix R:1 N:0 P:0 E:0 V:0 L:0 1111.1111.1002 L2
1.0.15.1/32 18 Proxy-Node R:0 N:0 P:0 E:0 V:0 L:0 1111.1111.1001 L2
1.0.16.1/32 20 Proxy-Node R:0 N:0 P:0 E:0 V:0 L:0 1111.1111.1003 L2
```

#### About the Output

After the usual output header that represents the system ID, instance name, etc and parameters of a router, there is a line depicting prefix segment counters. Each field in this line relates to the number of



segments that are present in this routers IS-IS instance. For example, the above example shows that this device has 2 Node Segments (Self originated as well as the ones received from other IS-IS SR devices).

The main section of this show commands output is the section that lists all the prefix segments and related information like prefix, SID, type of segment (Prefix, Node, Proxy-Node), the flag values being carried in the sub-TLVs of these prefix segments and the system ID of the originating router. The Type field will be useful on a IS type level-1-2 router. It shows whether the installed prefix segment is from a level-1 prefix or a level-2 prefix.

### show isis segment-routing prefix-segments self-originated

The **show isis segment-routing prefix-segments self-originated** command output is identical to show isis segment-routing prefix-segments except, the fact that the former lists only self-originated prefix segments.

### show isis segment-routing adjacency-segments

The **show isis segment-routing adjacency-segments** displays list of all the adjacency segments that are being originated by IS-IS SR on a router.

#### Example

```
switch#show isis segment-routing adjacency-segments
System ID: 1111.1111.1002 Instance: inst1
SR supported Data-plane: MPLS SR Router ID: 252.252.2.252
Adj-SID allocation mode: SR-adjacencies
Adj-SID allocation pool: Base: 100000 Size: 16384
Adjacency Segment Count: 4
Adj IP-address Local Intf Label SID Source Flags Type

1.0.0.1 Vlan2472 100000 Dynamic F:0 B:0 V:1 L:1 S:0 LAN L2
1.0.1.2 Vlan2579 100001 Dynamic F:0 B:0 V:1 L:1 S:0 P2P L2
fe80::1:ff:fe01:0 Vlan2472 100002 Dynamic F:0 B:0 V:1 L:1 S:0 LAN L2
fe80::1:ff:fe02:0 Vlan2579 100003 Dynamic F:0 B:0 V:1 L:1 S:0 P2P L2
```

#### About the Output

It consists allocation mode, MPLS label pool from which labels would be allocated to adjacencies, total count of adjacency segments allocated so far and the default flag values carried in all adj-SID sub-TLVs originating from this device.

The main section of the output lists all the adjacency segments allocated so far in six columns each pertaining to Adjacency IP address, local interface name, MPLS label value, SID source, flags in the sub-TLV and the type of adj-SID respectively. The type of the adjacency segments depends on the IS-IS type of adjacency and the IS level.

### show mpls label ranges

The **show mpls label ranges** command displays the MPLS label range available on a router is categorized into different pools which cater to different applications running on the router.

The isis-sr refers to the SRGB use-case in IS-IS, and isis (dynamic) refers to the label pool that is used for dynamic allocation of adjacency segments in IS-IS.

#### Example

```
switch#show mpls label ranges
Start End Size Usage

0 15 16 reserved
16 99999 99984 static mpls
100000 116383 16384 isis (dynamic)
116384 362143 245760 free (dynamic)
```

|        |        |        |            |
|--------|--------|--------|------------|
| 362144 | 899999 | 537856 | unassigned |
| 900000 | 965535 | 65536  | isis-sr    |

### show mpls segment-routing bindings

The **show mpls segment-routing bindings** command displays the local label bindings and label bindings on the peer routers for each prefix that has a segment advertised. Peer ID here represents the IS-IS system ID of the peer.

#### Example

```
switch#show mpls segment-routing bindings
1.0.7.1/32
 Local binding: Label: 900002
 Remote binding: Peer ID: 1111.1111.1001, Label: imp-null
 Remote binding: Peer ID: 1111.1111.1003, Label: 900002
1.0.8.1/32
 Local binding: Label: imp-null
 Remote binding: Peer ID: 1111.1111.1001, Label: 900004
 Remote binding: Peer ID: 1111.1111.1003, Label: 900004
1.0.9.1/32
 Local binding: Label: 900006
 Remote binding: Peer ID: 1111.1111.1001, Label: 900006
 Remote binding: Peer ID: 1111.1111.1003, Label: imp-null
```

### show mpls lfib route

The **show mpls lfib route** command displays the LFIB. Each LFIB entry has In-Label, Out-Label, metric, payload type, nexthop information, etc. fields. The source column depicts the MPLS control plane protocol that is responsible for the label binding that resulted in this LFIB route.

#### Example

```
switch#show mpls lfib route
MPLS forwarding table (Label [metric] Vias) - 7 routes
MPLS next-hop resolution allow default route: False
Via Type Codes:
 M - Mpls Via, P - Pseudowire Via,
 I - IP Lookup Via, V - Vlan Via,
 VA - EVPN Vlan Aware Via, ES - EVPN Ethernet Segment Via,
 VF - EVPN Vlan Flood Via, AF - EVPN Vlan Aware Flood Via,
 NG - Nexthop Group Via
Source Codes:
 S - Static MPLS Route, B2 - BGP L2 EVPN,
 B3 - BGP L3 VPN, R - RSVP,
 P - Pseudowire, L - LDP,
 IP - IS-IS SR Prefix Segment, IA - IS-IS SR Adjacency Segment,
 IL - IS-IS SR Segment to LDP, LI - LDP to IS-IS SR Segment,
 BL - BGP LU, ST - SR TE Policy,
 DE - Debug LFIB

IA 100000 [1]
 via M, 1.0.1.2, pop
 payload autoDecide, ttlMode uniform, apply egress-acl
 interface Vlan2930
IA 100001 [1]
 via M, fe80::200:eff:fe02:0, pop
 payload autoDecide, ttlMode uniform, apply egress-acl
 interface Vlan2930
IP 900008 [1]
 via M, 1.0.1.2, swap 900008
 payload autoDecide, ttlMode uniform, apply egress-acl
```

```

interface Vlan2930
IP 900009 [1]
 via M, fe80::200:eff:fe02:0, swap 900009
 payload autoDecide, ttlMode uniform, apply egress-acl
interface Vlan2930

```

### show mpls lfib route <label value>

The **show mpls lfib route <label value>** command provides information relevant to just the label value passed as an extension to the show command.

### Example

```

switch#show mpls lfib route 900008
MPLS forwarding table (Label [metric] Vias) - 7 routes
MPLS next-hop resolution allow default route: False
Via Type Codes:
 M - Mpls Via, P - Pseudowire Via,
 I - IP Lookup Via, V - Vlan Via,
 VA - EVPN Vlan Aware Via, ES - EVPN Ethernet Segment Via,
 VF - EVPN Vlan Flood Via, AF - EVPN Vlan Aware Flood Via,
 NG - Nexthop Group Via
Source Codes:
 S - Static MPLS Route, B2 - BGP L2 EVPN,
 B3 - BGP L3 VPN, R - RSVP,
 P - Pseudowire, L - LDP,
 IP - IS-IS SR Prefix Segment, IA - IS-IS SR Adjacency Segment,
 IL - IS-IS SR Segment to LDP, LI - LDP to IS-IS SR Segment,
 BL - BGP LU, ST - SR TE Policy,
 DE - Debug LFIB
IP 900008 [1]
 via M, 1.0.1.2, swap 900008
 payload autoDecide, ttlMode uniform, apply egress-acl
interface Vlan2930

```

#### 14.4.5.10.6 Verifying IS-IS Graceful Restart (GR) Information

GR State can be one of the following:

- Last Start/Restart was completed successfully.
- Last Start/Restart exited after t2 (level-1/level-2) expiry.
- Last Restart exited after t3 expiry.
- Start/Restart in progress.
- Graceful Restart was disabled during startup.

The following show commands are used to display the IS-IS graceful restart information.

- The **show isis graceful-restart vrf [vrf-name]** command displays the GR configuration and graceful-restart related state of the IS-IS instance as well as its neighbors.

### Example

```

switch#show isis graceful-restart vrf default
IS-IS Instance: 1 VRF: default
System ID: 0000.0000.0001
Graceful Restart: Enabled, Graceful Restart Helper: Enabled
State: Last Start exited after T2 (level-1) expiry
T1 : 3s
T2 (level-1) : 30s/20s remaining
T2 (level-2) : 30s/not running
T3 : not running

```

| System ID     | Type | Interface | Restart Capable | Status     |
|---------------|------|-----------|-----------------|------------|
| is-hostname-1 | L1L2 | Ethernet1 | Yes             | Running    |
| is-hostname-2 | L1   | Ethernet2 | Yes             | Restarting |

- The **show isis summary vrf [vrf-name]** command displays the graceful restart state and helper configuration.

#### Example

```
switch#show isis summary vrf default
IS-IS Instance: 1 VRF: default
System ID: 0000.0000.0001, administratively enabled
....
Graceful Restart: Enabled, Graceful Restart Helper: Enabled
```

- The **show isis neighbors detail vrf [vrf-name]** command displays the helpers view of a restarting router.

#### Example

```
switch#show isis neighbors detail vrf default
Instance VRF System Id Type Interface SNPA State Hold time Circuit Id
1 default OT1 L1 Ethernet1 2:1:0:b 4:0:0 UP 29839 OT3.05
Area Address(es): 49.0001
SNPA: 2:1:0:b4:0:0
....
Graceful Restart: Supported, Status: Restarting (RR rcvd, RA sent, CSNP sent)
```

- The **show isis interface detail vrf [vrf-name]** command displays the graceful restart related stats for that interface.

#### Example

```
switch#show isis interface detail vrf default
ISIS Instance: ISISQ VRF: default
Interface Ethernet1:
 Index: 2 SNPA: P2P
 ...
Level 1:
 Graceful Restart Status: RR sent, SA sent, RA rcvd, CSNP rcvd
```

### 14.4.5.10.7 IS-IS Dynamic Flooding Show Commands

Several show commands are available to monitor Dynamic Flooding. To see the flooding topology, use the **show isis dynamic flooding topology** command:

```
switch#show isis dynamic flooding topology

IS-IS Instance: Amun VRF: default
Level 1:
 Path: ip6.00 ip4.00 ip2.00 ip1.00 ip3.00 ip5.00 ip6.00
```

This command displays a list of paths that describe the flooding topology. Each path is a list of nodes in the network.

To see which interfaces dynamic flooding will use, use the **show isis dynamic flooding interfaces** command:

```
switch#show isis dynamic flooding interfaces

IS-IS Instance: Amun VRF: default
```

```
Level 1:
 Ethernet5
 Ethernet4
```

This shows that the system is currently flooding only on **Ethernet 4** and **Ethernet 5**. Normally at least two interfaces are selected.

---

## 14.4.6 IS-IS Commands

### Global Configuration Commands

- `clear isis neighbor`
- `router isis`

### Interface Configuration Commands

- `area leader`
- `adjacency-segment`
- `adjacency-segment (allocation)`
- `authentication key`
- `authentication mode`
- `bfd all-interfaces`
- `isis [ipv4|ipv6] fast-reroute ti-lfa srlg`
- `isis fast-reroute ti-lfa mode`
- `isis authentication key`
- `isis authentication mode`
- `isis bfd`
- `isis enable`
- `isis hello-interval`
- `isis hello-multiplier`
- `isis ipv6 metric`
- `isis lsp tx interval`
- `isis metric`
- `isis multi-topology`
- `isis network`
- `isis passive`
- `isis priority`

### Router IS-IS Configuration Mode (Includes Address-Family Mode)

- `address-family`
- `fast-reroute ti-lfa mode`
- `fast-reroute ti-lfa srlg`
- `graceful-restart (IS-IS)`
- `is-hostname`
- `is-type`
- `log-adjacency-changes (IS-IS)`
- `lsp dynamic flooding`
- `match isis level`
- `multi-topology`
- `net`
- `passive (IS-IS)`
- `redistribute (IS-IS)`
- `set isis level`
- `set-overload-bit`
- `shutdown (IS-IS)`
- `spf-interval`

**IS-IS Segment Routing Commands**

- `segment-routing mpls`
- `mpls label range`
- `node-segment`
- `prefix-segment`
- `proxy-node-segment`
- `adjacency-segment (static)`

**Display Commands EXEC Mode**

- `show ip route`
- `show isis database`
- `show isis database detail`
- `show isis graceful-restart vrf`
- `show isis hostname show isis dynamic flooding`
- `show isis interface`
- `show isis local-convergence-delay`
- `show isis neighbors`
- `show isis network topology`
- `show isis segment-routing`
- `show isis segment-routing prefix-segments`
- `show isis segment-routing adjacency-segments`
- `show isis segment-routing global-blocks`
- `show isis segment-routing tunnel`
- `show isis ti-lfa path`
- `show isis ti-lfa tunnel`
- `show mpls label ranges`
- `show mpls lfib route`
- `show mpls segment-routing bindings`
- `show tunnel fib`
- `show mpls lfib route`
- `show mpls lfib route <label value>`
- `show isis summary`

---

### 14.4.6.1 address-family

The **address-family** command places the switch in address-family configuration mode.

Address-family configuration mode is not a group change mode; **running-config** is changed immediately after commands are executed. The **exit** command does not affect the configuration.

The switch supports these address families:

- ipv4-unicast
- ipv6-unicast

The **no address-family** and **default address-family** commands delete the specified address-family from **running-config** by removing all commands previously configured in the corresponding address-family mode.

The **exit** command returns the switch to IS-IS configuration mode.

#### Command Mode

Router-IS-IS Configuration

#### Command Syntax

```
address-family [ipv4 | ipv6] [MODE]
```

```
no address-family [ipv4 | ipv6] [MODE]
```

```
default address-family [ipv4 | ipv6] [MODE]
```

#### Parameters

- address\_family Options include:
  - ipv4 IPv4 unicast
  - ipv6 IPv6 unicast
- MODE Options include:
  - <no parameter> Defaults to unicast.
  - **unicast** All IPv4 or IPv6 addresses are active.

#### Example

- These commands enter the address family mode for IPv4 unicast.

```
switch(config)#router isis Osiris
switch(config-router-isis)#address-family ipv4 unicast
switch(config-router-isis-af)#
```

- To exit from the IPv4 IS-IS unicast address family configuration mode, enter the following command.

```
switch(config)#router isis Osiris
switch(config-router-isis)#address-family ipv4 unicast
switch(config-router-isis-af)#exit
switch(config-router-isis)#
```



### 14.4.6.2 adjacency-segment

Use the **adjacency-segment** command in the interface configuration mode to have the PLR compute backup paths for an adjacency segment only if the Adjacency SID sub-TLV has the B-flag (backup flag) set.

#### Command Mode

Interface configuration mode

#### Command Syntax

```
adjacency-segment [ipv4|ipv6]p2p[multiple] [labellabel|indexindex] backup-eligible
```

```
no adjacency-segment [ipv4|ipv6]p2p[multiple] [labellabel|indexindex] backup-eligible
```

```
default adjacency-segment [ipv4|ipv6]p2p multiple [labellabel|indexindex] backup-eligible
```

#### Parameters

- **ipv4** IPv4 related.
- **ipv6** IPv6 related.
- **p2p** P2P interface type.
- **multiple** Configure multiple Adj-SIDs.
- **label *label*** Label value to be assigned as Adj-SID for adjacency on this interface. ***label*** range **16 -1048575**.
- **index *index*** Prefix segment identifier. ***index*** range **0 -65535**.
- **backup-eligible** Eligible for protection.

---

### 14.4.6.3 adjacency-segment (static)

The **adjacency-segment** command configures IS-IS adjacencies statically on the switch, so that these values are preserved even when the switch restarts. The **no** and the default form of the command places the switch back to the global configuration mode.

#### Command Mode

Interface Ethernet Configuration

#### Command Syntax

```
adjacency-segment <ipv4 | ipv6> p2p [[label <label-value>] | [index <index-value> global]]
```

#### Parameters

- *ipv4* IS-IS SR adjacency segment IPv4 interface configuration.
- *ipv6* IS-IS SR adjacency segment IPv6 interface configuration.
- *label* Label value to be assigned as Adj-SID for adjacency on this interface. Value ranges from 16 to 1048575.
- *index* Index to be assigned as Adj-SID for adjacency on this interface. Value ranges from 0 to 65535.
- *global* global adjacency SID.

#### Example

- This command allocates the adjacency segment to an IPv4 p2p interface with a index value 50.

```
switch(config-if-Et1)#adjacency-segment ipv4 p2p index 50 global
```

#### 14.4.6.4 adjacency-segment (allocation)

The **adjacency-segment** command allocates adjacency segments to all IS-IS adjacencies, or only those adjacencies which are to IS-IS routers that have advertised IS-IS SR capability, or to none of the adjacencies.

##### Command Mode

Segment-Routing MPLS Configuration

##### Command Syntax

```
adjacency-segment allocation [all-interface | none | sr-peers]
```

##### Parameters

- *allocation* Allocation of Adjacency Segments.
- *all-interfaces* Allocates adjacency segments to all IS-IS adjacencies.
- *none* Disable automatic adjacency segment allocation.
- *sr-peers* Allocate adjacency segments to IS-IS adjacencies with SR peers.

##### Example

- This command allocates the adjacency segment to an sr-peer.

```
switch(config-router-isis-sr-mpls)#adjacency-segment allocation sr-peer
```

#### 14.4.6.5 area leader

Use the **area leader** command to tune or disable the area leader election process.

##### Command Mode

Router configuration mode

##### Command Syntax

```
area leader [disabled | level-1 [disabled] | level-2 [disabled] | priority [num [level-1 | level-2]]]
```

```
no area leader
```

```
default area leader
```

##### Parameters

- **disabled** Disables becoming the are leader.
- **level-1** Configure at level 1.
  - **disabled** Disables becoming the are leader.
- **level-2** Configure at level 2.
  - **disabled** Disables becoming the are leader.
- **priority** Sets the area leader priority.
  - **level-1** Configure at level 1.
  - **level-2** Configure at level 2.

---

#### 14.4.6.6 authentication key

The **authentication key** command configures the authentication key for the IS-IS instance causing LSPs, CSNPs and PSNPs to be authenticated.

The **no authentication key** and **default authentication key** commands disables the authentication key for the IS-IS instance.

##### Command Mode

ISIS-Router Configuration

##### Command Syntax

```
authentication key [0 / 7][LAYER_VALUE]
```

```
no authentication key [0 / 7][LAYER_VALUE]
```

```
default authentication key [0 / 7][LAYER_VALUE]
```

##### Parameters

- LAYER\_VALUE layer value. Options include:
  - level-1
  - level-2

##### Example

- These commands configure authentication for the IS-IS instance causing LSPs, CSNPs and PSNPs to be authenticated.

```
switch(config)#router isis 1
switch(config-router-isis)#authentication key secret
switch(config-router-isis)#
```

### 14.4.6.7 authentication mode

The `authentication mode` command configures authentication for the IS-IS instance causing LSPs, CSNPs and PSNPs to be authenticated.

The `no authentication mode` and `default authentication mode` commands disables authentication for the IS-IS instance.

#### Command Mode

ISIS-Router Configuration

#### Command Syntax

```
authentication mode <md5 / text> [LAYER_VALUE]
```

```
no authentication mode <md5 / text> [LAYER_VALUE]
```

```
default authentication mode <md5 / text> [LAYER_VALUE]
```

#### Parameters

- LAYER\_VALUE Layer value. Options include:
  - level-1
  - level-2

#### Example

- These commands configure authentication for the IS-IS instance causing LSPs, CSNPs and PSNPs to be authenticated.

```
switch(config)#router isis 1
switch(config-router-isis)#authentication mode md5
switch(config-router-isis)#
```

---

#### 14.4.6.8 bfd all-interfaces

The **bfd all-interfaces** command enables Bidirectional Forwarding Detection (BFD) for all IS-IS-enabled interfaces in the IPv4 or IPv6 address family.

Use the **isis bfd** command to configure BFD on a specific interface.

##### Command Mode

Router-IS-IS Address-Family Configuration

##### Command Syntax

**bfd all-interfaces**

##### Example

- These commands enable BFD for all the interfaces on which IS-IS is enabled. By default, BFD is disabled on all the interfaces.

```
switch(config)#router isis 1
switch(config-router-isis)#address-family ipv4
switch(config-router-af)#bfd all-interfaces
switch(config-router-af)#
```

### 14.4.6.9 clear isis neighbor

The **clear isis neighbor** command clears IS-IS adjacencies that exist on an interface, or at a specific level, or the adjacencies formed with a given neighbor (either with a system ID or a hostname).

#### Command Mode

Privileged EXEC

#### Command Syntax

```
clear isis neighbor {Neighbor-ID | all | interface} [level-1 | level-2 | level-1-2]
```

#### Parameters

- *Neighbor-ID* Clears adjacencies based on the system ID or the hostname of a neighbor.
- *all* Clears all adjacencies.
- *interface* Clears adjacencies for a specific interface.
- *level-1* level 1 only.
- *level-1-2* level 1-2 point-to-point only.
- *level-2* level 2 only.

#### Examples

- This command clears IS-IS adjacencies with a neighbor af86.3032.1a0f.

```
switch#clear isis neighbor af86.3032.1a0f
2 neighbors cleared on instance 1
switch#
```

- This command clears all IS-IS adjacencies on an interface et1.

```
switch#clear isis neighbor interface et1
4 neighbors cleared on instance 1
switch#
```

- This command clears IS-IS adjacencies with a neighbor af86.3032.1a0f and on interface et1.

```
switch#clear isis neighbor af86.3032.1a0f interface et1
2 neighbors cleared on instance 1
switch#
```

- This command clears all IS-IS adjacencies at Level 1 and on interface et1.

```
switch#clear isis neighbor interface et1 level-1
2 neighbors cleared on instance 1
switch#
```

- This command clears Level 1-2 point-to-point adjacencies only.

```
switch#clear isis neighbor all level-1-2
0 neighbors cleared on instance 1
switch#
```

---

#### 14.4.6.10 fast-reroute ti-lfa mode

Use the **fast-reroute ti-lfa mode** to enable link or node protection for node segments and adjacency segments of a specific address-family learned on all IS-IS interfaces.

##### Command Mode

address-family sub-mode of the router isis mode (config-router-isis-af)

##### Command Syntax

```
fast-reroute ti-lfa mode [[[link-protection | node-protection][level-1 | level-2]] | disabled]
```

##### Parameters

- **link-protection** Protects against the failure of the link.
- **node-protection** Protects against the failure of the neighbor mode.
- **level-1** Protects prefixes only in level-1.
- **level-2** Protects prefixes on in level-2. Disables the fast-reroute TI-LFA mode.

##### Guidelines

FRR using TI-LFA is disabled globally by default in the router IS-IS address-family sub-modes.

The interface TI-LFA configuration inherits the address-family sub-mode configuration by default.



#### 14.4.6.11 fast-reroute ti-lfa srlg

Use the **fast reroute ti-lfa srlg** command to enable SRLG protection on all interfaces. This command is used in addition to configuring link-protection or node-protection. When SRLG protection is enabled, the backup paths are computed after excluding all the links that share the same SRLG with the active link that is being used by all prefix segments and adjacency segments.

##### **Command Mode**

```
config-router-isis-af
```

##### **Command Syntax**

```
fast-reroute ti-lfa srlg [strict]
```

##### **Parameters**

**strict** The backup path is only programmed if a backup path that excludes all the SRLGs configured on the primary interface.

---

#### 14.4.6.12 graceful-restart (IS-IS)

The **graceful-restart** command configures IS-IS graceful-restart. The command provides options to configure the *t2* time or the *restart-hold-time*.

*t2* is the maximum wait time for the LSP database to synchronize (SPF computation is not done while *t2* is running). *t2* can be configured for either level-1 or level-2 routes.

*restart-hold-time* is the hold time advertised by the router to its neighbors before undergoing ASU2 fast reboot.

The **no graceful-restart** and **default graceful-restart** commands disables the IS-IS graceful-restart configuration from **running-config**.

##### Command Mode

Router-IS-IS Configuration

##### Command Syntax

```
graceful-restart <t2 | restart-hold-time> <value>
```

```
no graceful-restart <t2 | restart-hold-time> <value>
```

```
default graceful-restart <t2 | restart-hold-time> <value>
```

##### Parameters

- *value* The time in seconds. Value ranges from 5 to 300 seconds.
- *restart-hold-time* Sets the hold time when restarting.
- *t2* Sets the LSP database sync wait time.

##### Examples

- In this example an ISIS graceful restart is configured with *t2* wait time of 30 seconds for level-1 routes.

```
switch(config)#router isis 1
switch(config-router-isis)#graceful-restart t2 level-1 30
```

- In this example an ISIS graceful restart is configured with *restart-hold-time* of 50 seconds.

```
switch(config)#router isis 1
switch(config-router-isis)#graceful-restart restart-hold-time 50
```

### 14.4.6.13 is-hostname

The **is-hostname** command configures the use of a human-readable string to represent the symbolic name of an IS-IS router. It also changes the output of IS-IS show commands, to show the IS-IS hostname in place of system IDs if the corresponding IS-IS hostname is known. However, syslogs still use IS-IS system IDs and not the IS-IS hostname.

By default, if a hostname is configured on the switch, it is used as the IS-IS hostname. It is also possible to unconfigure an assigned hostname for IS-IS using the **no is-hostname** command. When the IS-IS hostname is removed, the switch goes back to using the switch's hostname as the IS-IS hostname.

#### Command Mode

Router-IS-IS Configuration

#### Command Syntax

```
is-hostname <string>
```

```
no is-hostname
```

#### Examples

- These commands configure the IS-IS hostname to the symbolic name `ishost1` for the IS-IS router.

```
switch(config)#router isis inst1
switch(config-router-isis)#is-hostname ishost1
switch(config-router-isis)#
```

- These commands unconfigure the IS-IS hostname of the symbolic name `ishost1` for the IS-IS router.

```
switch(config)#router isis inst1
switch(config-router-isis)#no is-hostname ishost1
switch(config-router-isis)#
```

---

#### 14.4.6.14 isis authentication key

The `isis authentication key` command configures the authentication key on the interface causing IS-IS Hellos to be authenticated.

The `no isis authentication mode` and `default isis authentication mode` commands disables the authentication key for the IS-IS instance.

##### Command Mode

Interface-Ethernet Configuration

##### Command Syntax

```
isis authentication key [0 | 7] [LAYER_VALUE]
```

```
no isis authentication key [0 | 7] [LAYER_VALUE]
```

```
default isis authentication key [0 | 7] [LAYER_VALUE]
```

##### Parameters

- LAYER\_VALUE Layer value. Options include:
  - level-1
  - level-2

##### Example

- These commands configure authentication on the interface causing IS-IS Hellos to be authenticated.

```
switch(config)#interface Ethernet 3/6
switch(config-if-Et3/6)#isis authentication mode text
switch(config-if-Et3/6)#isis authentication key 7 cAm28+9a/xPi0
4o7hjd8Jw==
switch(config-if-Et3/6)#
```

### 14.4.6.15 isis authentication mode

The **isis authentication mode** command configures authentication on the interface causing IS-IS Hellos to be authenticated.

The **no isis authentication mode** and **default isis authentication mode** commands disables authentication for the IS-IS instance.

#### Command Mode

Interface-Ethernet Configuration

#### Command Syntax

```
isis authentication mode <md5 | text> [LAYER_VALUE]
```

```
no isis authentication mode <md5 | text> [LAYER_VALUE]
```

```
default isis authentication mode <md5 | text> [LAYER_VALUE]
```

#### Parameters

- LAYER\_VALUE Layer value. Options include:
  - level-1
  - level-2

#### Example

- These commands configure authentication on the interface causing IS-IS Hellos to be authenticated.

```
switch(config)#interface Ethernet 3/6
switch(config-if-Et3/6)#isis authentication mode text
switch(config-if-Et3/6)#isis authentication key 7 cAm28+9a/xPi0
4o7hjd8Jw==
switch(config-if-Et3/6)#
```

---

#### 14.4.6.16 isis bfd

The `isis bfd` command activates the corresponding IS-IS routing instance on the configuration mode interface. By default, the IS-IS routing instance is not enabled on an interface.

The `no isis enable` and `default isis enable` commands disable IS-IS on the configuration mode interface by removing the corresponding `isis enable` command from *running-config*.

##### Command Mode

Interface-Ethernet Configuration

##### Command Syntax

```
isis bfd
```

```
no isis bfd
```

```
default isis bfd
```

##### Example

- These commands enable BFD on IS-IS interfaces.

```
switch(config)#interface Ethernet 5/6
switch(config-if-Et5/6)#isis bfd
switch(config-if-Et5/6)#
```

### 14.4.6.17 isis enable

The **isis enable** command activates the corresponding IS-IS routing instance on the configuration mode interface. By default, the IS-IS routing instance is not enabled on an interface.

The **no isis enable** and **default isis enable** commands disable IS-IS on the configuration mode interface by removing the corresponding **isis enable** command from *running-config*.

#### Command Mode

Interface-Ethernet Configuration

Interface-Loopback Configuration

Interface-Port-channel Configuration

Interface-VLAN Configuration

#### Command Syntax

```
isis enable instance_id
```

```
no isis enable
```

```
default isis enable
```

#### Parameters

- ***instance\_id*** IS-IS instance name.

#### Examples

- These commands enable the IS-IS protocol on the interface Ethernet 4.

```
switch(config)#router isis Osiris
switch(config-router-isis)#net 49.0001.1010.1040.1030.00
switch(config-router-isis)#interface ethernet 4
switch(config-if-Eth4)#isis enable Osiris
```

- These commands disable the IS-IS protocol on the interface Ethernet 4.

```
switch(config)#interface ethernet 4
switch(config-if-Eth4)#no isis enable
```

---

#### 14.4.6.18 isis fast-reroute ti-lfa mode

Use the `isis fast-reroute ti-lfa mode` command to enable link or node protection for node segments and adjacency segments learned on a specific IS-IS interface. By default, the interface TI-LFA configuration inherits the address-family sub-mode configuration.

The `no isis fast-reroute ti-lfa mode` and `default isis fast-reroute ti-lfa mode` commands disable link or node protection for node segments and adjacency segments learned on a specific IS-IS interface.

##### Command Mode

Interface configuration mode.

##### Command Syntax

```
isis fast-reroute ti-lfa mode [link-protection | node-protection | disabled][level-1 | level-2]
```

```
no isis fast-reroute ti-lfa mode [link-protection | node-protection | disabled][level-1 | level-2]
```

```
default isis fast-reroute ti-lfa mode [link-protection | node-protection | disabled][level-1 | level-2]
```

##### Parameters

- **link-protection** Configures link-protection.
- **node-protection** Configures node-protection.
- **disabled** Disables protection over the link.
- **level-1** Optional keyword in both the router IS-IS address-family sub-mode and interface configuration mode CLIs is used to restrict protection to node segments and adjacency segments learned through either level-1 topologies only.
- **level-2** Optional keyword in both the router IS-IS address-family sub-mode and interface configuration mode CLIs is used to restrict protection to node segments and adjacency segments learned through level-2 topologies only.



### 14.4.6.19 isis hello-interval

The **isis hello-interval** command sends Hello packets from applicable interfaces to maintain the adjacency through the transmitting and receiving of Hello packets. The Hello packet interval can be modified.

The **no isis hello-interval** and **default isis hello-interval** commands restore the default hello interval of 10 seconds on the configuration mode interface by removing the **isis hello-interval** command from *running-config*.

#### Command Mode

Interface-Ethernet Configuration

Interface-Loopback Configuration

Interface-Port-channel Configuration

Interface-VLAN Configuration

#### Command Syntax

```
isis hello-interval time
```

```
no isis hello-interval
```

```
default isis hello-interval
```

#### Parameters

- *time* Values range from 1 to 300; default is 10.

#### Examples

- These commands configure a hello interval of 45 seconds for VLAN 200.

```
switch(config)#interface vlan 200
switch(config-if-Vl200)#isis hello-interval 45
switch(config-if-Vl200)#
```

- These commands remove the configured hello interval of 45 seconds from VLAN 200.

```
switch(config)#interface vlan 200
switch(config-if-Vl200)#no isis hello-interval
switch(config-if-Vl200)#
```

- These commands configure a hello interval of 60 seconds for Ethernet 5.

```
switch(config)#interface ethernet 5
switch(config-if-Et5)#isis hello-interval 60
switch(config-if-Et5)#
```

- These commands remove the configured hello interval of 60 seconds from Ethernet 5.

```
switch(config)#interface ethernet 5
switch(config-if-Et5)#no isis hello-interval
switch(config-if-Et5)#
```

---

#### 14.4.6.20 isis hello-multiplier

The **isis hello-multiplier** command specifies the number of IS-IS hello packets missed by a neighbor before the adjacency is considered down.

The **no isis hello-multiplier** and **default isis hello-multiplier** commands restore the default hello interval of 3 on the configuration mode interface by removing the **isis hello-multiplier** command from *running-config*.

##### Command Mode

Interface-Ethernet Configuration

Interface-Loopback Configuration

Interface-Port-channel Configuration

Interface-VLAN Configuration

##### Command Syntax

```
isis hello-multiplier factor
```

```
no isis hello-multiplier
```

```
default isis hello-multiplier
```

##### Parameters

- *factor* Values range from 3 to 100; default is 3

##### Examples

- These commands configure a hello multiplier of 4 for VLAN 200.

```
switch(config)#interface vlan 200
switch(config-if-Vl200)#isis hello-multiplier 4
switch(config-if-Vl200)#
```

- These commands remove the configured hello multiplier of 4 from VLAN 200.

```
switch(config)#interface vlan 200
switch(config-if-Vl200)#no isis hello-multiplier
switch(config-if-Vl200)#
```

- These commands configure a hello multiplier of 45 for Ethernet 5.

```
switch(config)#interface ethernet 5
switch(config-if-Et5)#isis hello-multiplier 45
switch(config-if-Et5)#
```

- These commands remove the configured hello multiplier of 45 from Ethernet 5.

```
switch(config)#interface ethernet 5
switch(config-if-Et5)#no isis hello-multiplier
switch(config-if-Et5)#
```

#### 14.4.6.21 isis [ipv4|ipv6] fast-reroute ti-lfa srlg

Use the `isis [ipv4|ipv6] fast-reroute ti-lfa srlg` command to enable protection selectively on a specific interface. This command only enables SRLG protection for prefix segments and adjacency segments enabled on the interface.

##### Command Mode

```
config-intf-et1
```

##### Command Syntax

```
isis [ipv4 | ipv6] [fast-reroute ti-lfa srlg] [strict | disabled]
no isis [ipv4 | ipv6] [fast-reroute ti-lfa srlg] [strict | disabled]
default isis [ipv4 | ipv6] [fast-reroute ti-lfa srlg] [strict | disabled]
```

##### Parameters

- **ipv4** IS-IS IPv4 interface configuration.
- **ipv6** IS-IS IPv6 interface configuration.
- **fast-reroute** Configures fast reroute.
- **ti-lfa** Configures TI-LFA FRR.
- **srlg** Excludes same SRLG links from backup path.
- **strict** The backup path is only programmed only if a backup path that excludes all the SRLGs configured on the primary interface. If **strict** is not provided and an SRLG excluding path is not available, TI-LFA programs the backup path that excluded the maximum number of SRLGs possible.
- **disabled** Use to selectively disable SRLG protection on an interface. This is useful when SRLG protection is enabled globally for all interfaces but needs to be selectively disabled for a specific interface.

#### 14.4.6.22 isis ipv6 metric

The `isis ipv6 metric` command configures the IPv6 metric.

The `no isis ipv6 metric` and `default isis ipv6 metric` commands restore the default metric of 10 on the configuration mode interface.

##### Command Mode

Interface-Ethernet Configuration

##### Command Syntax

```
isis ipv6 metric metric_value
no isis ipv6 metric
default isis ipv6 metric
```

##### Parameters

- **metric\_value** Values range from 1 to 16777214; default is 10.

##### Example

- These commands configure the IPv6 metric.

```
switch(config)#interface Ethernet 5/6
switch(config-if-Et5/6)#isis ipv6 metric 30
switch(config-if-Et5/6)#
```

---

### 14.4.6.23 isis lsp tx interval

The `isis lsp tx interval` command sets the interval at which IS-IS sends link-state information on the interface.

The `no isis lsp tx interval` and `default isis lsp tx interval` commands restores the default setting of 33 ms. by removing the `isis lsp tx interval` command from *running-config*.

#### Command Mode

Interface-Ethernet Configuration

Interface-Loopback Configuration

Interface-Port-channel Configuration

Interface-VLAN Configuration

#### Command Syntax

```
isis lsp tx interval period
```

```
no isis lsp tx interval
```

```
default isis lsp tx interval
```

#### Parameters

- *period* Value ranges from 1 through 3000. Default interval is 33 ms.

#### Examples

- This command sets the LSP interval on interface Ethernet 5 to 600 milliseconds.

```
switch(config)#interface ethernet 5
switch(config-if-Et5)#isis lsp tx interval 600
switch(config-if-Et5)#
```

- This command removes the LSP interval on interface Ethernet 5.

```
switch(config)#interface ethernet 5
switch(config-if-Et5)#no isis lsp tx interval
switch(config-if-Et5)#
```

#### 14.4.6.24 isis metric

The **isis metric** command sets cost for sending information over an interface.

The **no isis metric** and **default isis metric** commands restore the metric to its default value of 10 by removing the **isis metric** command from *running-config*.

##### Command Mode

Interface-Ethernet Configuration

Interface-Loopback Configuration

Interface-Port-channel Configuration

Interface-VLAN Configuration

##### Command Syntax

```
isis metric metric_cost
```

```
no isis metric
```

```
default isis metric
```

##### Parameters

- *metric\_cost* Values range from 1 to 1677214. Default value is 10.

##### Examples

- These commands configure a metric cost of 30 for sending information over Ethernet 5.

```
switch(config)#router isis Osiris
switch(config-router-isis)#interface ethernet 5
switch(config-if-Et5)#isis metric 30
switch(config-if-Et5)#
```

- These commands remove the configured metric cost of 30 from Ethernet 5.

```
switch(config)#router isis Osiris
switch(config-router-isis)#interface ethernet 5
switch(config-if-Et5)#no isis metric
switch(config-if-Et5)#
```

---

### 14.4.6.25 isis multi-topology

The **isis multi-topology** command configures the IPv4 or IPv6 address family individually on an interface with both IPv4 and IPv6 addresses.

The **no isis multi-topology** and **default isis multi-topology** commands restores the default interface to both IPv4 and IPv6 address families.

#### Command Mode

Interface-Ethernet Configuration

#### Command Syntax

```
isis multi-topology address-family ipv4 unicast
no isis multi-topology address-family ipv4 unicast
default isis multi-topology address-family ipv4 unicast
```

#### Examples

- These commands configure the IPv4 address family on an interface with both IPv4 and IPv6 addresses.

```
switch(config)#interface Ethernet 5/6
switch(config-if-Et5/6)#isis multi-topology address-family ipv4 unicast
switch(config-if-Et5/6)#
```

- These commands configure the IPv6 address family on an interface with both IPv4 and IPv6 addresses.

```
switch(config)#interface Ethernet 5/6
switch(config-if-Et5/6)#isis multi-topology address-family ipv6 unicast
switch(config-if-Et5/6)#
```

- These commands configure both the IPv4 and IPv6 address families on an interface.

```
switch(config)#interface Ethernet 5/6
switch(config-if-Et5/6)#no isis multi-topology address-family unicast
switch(config-if-Et5/6)#
```

### 14.4.6.26 isis network

The **isis network** command sets the configuration mode interface as a point-to-point link. By default, interfaces are configured as broadcast links.

The **no isis network** and **default isis network** commands set the configuration mode interface as a broadcast link by removing the corresponding **isis network** command from *running-config*.

#### Command Mode

Interface-Ethernet Configuration

Interface-Loopback Configuration

Interface-Port-Channel Configuration

Interface-VLAN Configuration

#### Command Syntax

```
isis network point-to-point
```

```
no isis network
```

```
default isis network
```

#### Examples

- These commands configure Ethernet interface 10 as a point-to-point link.

```
switch(config)#interface ethernet 10
switch(config-if-Et10)#isis network point-to-point
switch(config-if-Et10)#
```

- This command restores Ethernet interface 10 as a broadcast link.

```
switch(config-if-Et10)#no isis network
switch(config-if-Et10)#
```

---

#### 14.4.6.27 isis passive

The **isis passive** command disables IS-IS on an interface configured as passive. The switch won't send or process IS-IS packets received on passive interfaces. The switch will continue to advertise the IP address in the LSP.

The **no isis passive** command enables IS-IS on the interface. The **default isis passive** command sets the interface to the default interface activity setting by removing the corresponding **isis passive** or **no isis passive** statement from *running-config*.

##### Command Mode

Interface-Ethernet Configuration

Interface-Loopback Configuration

Interface-Port-Channel Configuration

Interface-VLAN Configuration

##### Command Syntax

```
isis passive
```

```
no isis passive
```

```
default isis passive
```

##### Examples

- These commands configure Ethernet interface 10 as a passive interface.

```
switch(config)#router isis Osiris
switch(config-router-isis)#interface ethernet 10
switch(config-if-Et10)#isis passive
switch(config-if-Et10)#
```

- This command enables IS-IS on Ethernet interface 10.

```
switch(config-if-Et10)#no isis passive
switch(config-if-Et10)#
```



### 14.4.6.28 isis priority

The **isis priority** command sets the IS-IS priority for the interface.

The default priority is 64. The network device with the highest priority will be elected as the designated intermediate router to send link-state advertisements for that network.

The **no isis priority** and **default isis priority** commands restore the default priority (64) on the configuration mode interface.

#### Command Mode

Interface-Ethernet Configuration

Interface-Loopback Configuration

Interface-Port-channel Configuration

Interface-VLAN Configuration

#### Command Syntax

```
isis priority priority_level
```

```
no isis priority
```

```
default isis priority
```

#### Parameters

- *priority\_level* Value ranges from 0 to 127. Default value is 64.

#### Examples

- These commands configure a IS-IS priority of 60 on interface Ethernet 5.

```
switch(config)#router isis Osiris
switch(config-router-isis)#interface ethernet 5
switch(config-if-Et5)#isis priority 60
switch(config-if-Et5)#
```

- These commands restores the default IS-IS priority of 64 from interface Ethernet 5.

```
switch(config)#router isis Osiris
switch(config-router-isis)#interface ethernet 5
switch(config-if-Et5)#no isis priority
switch(config-if-Et5)#
```

- These commands configure the switch with a priority of 64 for VLAN 7.

```
switch(config)#interface vlan 7
switch(config-if-Vl7)#isis priority 64
switch(config-if-Vl7)#
```

- These command restores the default IS-IS priority of 64 for VLAN 7.

```
switch(config)#interface vlan 7
switch(config-if-Vl7)#no isis priority
switch(config-if-Vl7)#
```

---

### 14.4.6.29 is-type

The **is-type** command configures the routing level for an IS-IS instance.

An IS-IS router can be configured as Level-1-2 which can form adjacencies and exchange routing information with both Level-1 and Level-2 routers. A Level-1-2 router can be configured to transfer routing information from Level-1 to Level-2 areas and vice versa (via route leaking). By default, all routes from Level-1 area are always leaked into Level-2 network.

#### Command Mode

Router-IS-IS Configuration

#### Command Syntax

**is-type** LAYER\_VALUE

#### Parameters

- LAYER\_VALUE Layer value options include:
  - **level-1**
  - **level-1-2**
  - **level-2**

#### Example

- These commands configure Level 1-2 routing.

```
switch(config)#router isis Osiris
switch(config-router-isis)#is-type level-1-2
switch(config-router-isis)#
```

- These commands configure Level 2 routing.

```
switch(config)#router isis Osiris
switch(config-router-isis)#is-type level-2
switch(config-router-isis)#
```

### 14.4.6.30 log-adjacency-changes (IS-IS)

The **log-adjacency-changes** command sets the switch to send syslog messages when it detects link state changes or when it detects that a neighbor state has changed.

The default option is active when **running-config** does not contain any form of the command. Entering the command in any form replaces the previous command state in **running-config**.

#### Command Mode

Router-IS-IS Configuration

#### Command Syntax

```
log-adjacency-changes
no log-adjacency-changes
default log-adjacency-changes
```

#### Examples

- These commands configure the switch to send a syslog message when a neighbor state changes.

```
switch(config)#router isis Osiris
switch(config-router-isis)#log-adjacency-changes
switch(config-router-isis)#
```

- These commands configure not to log the peer changes.

```
switch(config)#router isis Osiris
switch(config-router-isis)#no log-adjacency-changes
switch(config-router-isis)#
```

---

### 14.4.6.31 Lsp dynamic flooding

Use the `lsp flooding dynamic` command to configure dynamic flooding. Dynamic flooding must be enabled on all routers in the area. The `no` form of the command removes LSP dynamic flooding. LSP flooding dynamic is disabled by default.

#### Command Mode

Router configuration mode

#### Command Syntax

```
lsp flood dynamic [level-1 | level-2]
```

```
no lsp flood dynamic [level-1 | level-2]
```

```
default lsp flood dynamic [level-1 | level-2]
```

#### Parameters

- **level-1** Level 1 adjecencies.
- **level-2** Level 2 adjencencies.

#### Example

```
switch(config)#router isis Amun
switch(config-router-isis)#net 49.0000.0000.3333.00
switch(config-router-isis)#is-hostname ip3
switch(config-router-isis)#lsp flooding dynamic
```

### 14.4.6.32 match isis level

The **match isis level** command configures a route map to match on ISIS level. It filters the Level-1 or Level-2 routes by using route maps match statement.

The **no match isis level** and **default match isis level** commands disables the match ISIS level configuration from **running-config**.

#### Command Mode

Route-map Configuration

#### Command Syntax

```
match isis level [level-1|level-2]
no match isis level [level-1|level-2]
default match isis level [level-1|level-2]
```

#### Parameters

- level-1 IS-IS level 1.
- level-2 IS-IS level 2.

#### Example

- These commands place the switch in route-map mode, and configures a route map to match isis level to level-1.

```
switch(config)#route-map Test
switch(config-route-map-test)#match isis level level-1
```

---

### 14.4.6.33 mpls label range

The `mpls label range` command derives the indices of the actual MPLS label on the SRGB advertised by the router. The default value of SRGB in EOS is Base: 900000, Size: 65536. In other words, the labels that any global segment could represent is between 900000-965535.

#### Command Mode

Global Configuration

#### Command Syntax

```
mpls label range <value>
```

#### Parameters

- *value* Specifies the Segment Routing global range.
  - `dynamic` Specifies labels reserved for dynamic assignment. Default value is (100000) (262144).
    - `IS-IS-sr` Specifies labels reserved for IS-IS SR global segment identifiers (SIDs). Default value is (900000) (65536).
    - `static` Specifies labels reserved for static MPLS routes. Default value is (16) (99984).

#### Example

- The following command configures an IS-IS SR global range with a value of (900000)-- starting label range, (65536)--Numbers of labels to reserve.

```
switch(config)#mpls label range isis-sr 900000 65536
```

### 14.4.6.34 multi-topology

The **multi-topology** command configures IS-IS Multi-Topology (MT) support (disabled by default), enabling an IS-IS router to compute a separate topology for IPv4 and IPv6 links in the network. With MT configured, not all the links in a network need to support both IPv4 and IPv6. Some can support IPv4 or IPv6 individually. The IPv4 SPF will install IPv4 routes using the IPv4 topology, and similarly the IPv6 SPF will install IPv6 routes using the IPv6 topology. Without MT support, all links in an IS-IS network need to support the same set of address families. When MT is enabled, and each link has a separate IPv4 metric and IPv6 metric.

The **no multi-topology** and **default multi-topology** commands restores the default interface to both IPv4 and IPv6 address families.

#### Command Mode

Router IS-IS Address-Family Configuration

#### Command Syntax

```
multi-topology
```

```
no multi-topology
```

```
default multi-topology
```

#### Examples

- These commands configure MT for the IS-IS router.

```
switch(config)#router isis 1
switch(config-router-isis)#address-family ipv6 unicast
switch(config-router-isis-af)#multi-topology
switch(config-router-isis-af)#
```

- These commands unconfigure MT for the IS-IS router.

```
switch(config)#router isis 1
switch(config-router-isis)#address-family ipv6 unicast
switch(config-router-isis-af)#no multi-topology
switch(config-router-isis-af)#
```

---

### 14.4.6.35 net

The **net** command configures the Network Entity Title of the IS-IS instance. By default, no NET is defined.

The **no net** and **default net** commands removes the NET from *running-config*.

#### Command Mode

Router-IS-IS Configuration

#### Command Syntax

```
net mask_hex
```

```
no net
```

```
default net
```

#### Parameters

- *mask\_hex* Mask value. Format is hh.hhhh.hhhh.hhhh.hhhh.hhhh.hhhh.hhhh.hhhh.00.

#### Examples

- These commands specify the NET as 49.0001.1010.1040.1030.00, in which the system ID is 1010.1040.1030, area ID is 49.0001.

```
switch(config)#router isis Osiris
switch(config-router-isis)#net 49.0001.1010.1040.1030.00
switch(config-router-isis)#
```

- These commands remove NET 49.0001.1010.1040.1030.00 from *running-config*.

```
switch(config)#router isis Osiris
switch(config-router-isis)#no net 49.0001.1010.1040.1030.00
switch(config-router-isis)#
```



### 14.4.6.36 node-segment

The **node-segment** command associates the node segments with prefix mask length /32 (IPv4) or /128 (IPv6) addresses. The **node-segment** command must be issued on an IS-IS-enabled loop back interface.

#### Command Mode

Loop-back Interface Configuration

#### Command Syntax

```
node-segment [ipv4 | ipv6] index <value>
```

#### Parameters

- *ipv4* Specifies the IPv4 node configuration.
- *ipv6* Specifies the IPv6 node configuration.
- *index* Node segment identifier.
- *value* Index to be mapped with IP prefix. Value ranges from 0-65535.

#### Examples

- The following commands are used to associate a node-segment with an IPv4 address.

```
switch(config)#int loopback 1
switch(config-if-Lo1)#ip address 21.1.1.1/32
switch(config-if-Lo1)#node-segment ipv4 index 5
```

- The following commands are used to associate a node-segment with an IPv6 address.

```
switch(config)#int loopback 1
switch(config-if-Lo1)#ipv6 add 2000::24/128
switch(config-if-Lo1)#node-segment ipv6 index 5
```

- The following example shows a warning thrown at the CLI when a /32 or /128 address is not configured on the interface.

```
switch(config)#int loopback 1
switch(config-if-Lo1)#ip address 21.1.1.1/24
switch(config-if-Lo1)#node-segment ipv4 index 1
! /32 IPv4 address is not configured on the interface
```

- The following command removes the node-segment from IS-IS SR from an interface.

```
switch(config-if-Lo1)#no node-segment ipv4 index 1
```

---

### 14.4.6.37 passive (IS-IS)

The **passive** command disables IS-IS on a passive interface. The switch will continue to advertise the IP address in the LSP.

The **no passive** command enables IS-IS on the interface. The **default passive** command sets the interface to the default interface activity setting by removing the corresponding **passive** or **no passive** statement from *running-config*.

#### Command Mode

Router-IS-IS Configuration

#### Command Syntax

```
passive INTERFACE_NAME
no passive INTERFACE_NAME
default passive INTERFACE_NAME
```

#### Parameters

- INTERFACE\_NAME Options include:
  - **ethernet** *e\_range* Ethernet interface list.
  - **loopback** *l\_range* Loopback interface list.
  - **port-channel** *p\_range* Channel group interface list.
  - **vlan** *v\_range* VLAN interface list.

Valid *e\_range*, *l\_range*, *p\_range*, and *v\_range* formats include number, range, or comma-delimited list of numbers and ranges.

#### Examples

- These commands configure Ethernet interface 10 as a passive interface.

```
switch(config)#router isis Osiris
switch(config-router-isis)#passive interface ethernet 10
```

- This command restores Ethernet interface 10 as an active interface.

```
switch(config-if-Et10)#no passive
switch(config-if-Et10)#
```

### 14.4.6.38 prefix-segment

The **prefix-segment** command associates prefix segments with any IS-IS prefix a router is originating an IP Reachability TLV for.

#### Command Mode

Segment-Routing MPLS Configuration

#### Command Syntax

```
prefix-segment ip-address index <value>
```

#### Parameters

- *ip-address* It can be IP address, or IP address with prefix, or an IPv6 address prefix.
- *index* Node segment identifier.
- *value* Index to be mapped with IP prefix. Value ranges from 0-65535.

#### Example

- The following commands are used to associate a prefix segment with an IPv4 address with index value of 50.

```
switch(config)#router isis instancel
switch(config-router-isis)#segment-routing mpls
switch(config-router-isis-sr-mpls)#prefix-segment 1.1.1.0/24 index 50
```

---

### 14.4.6.39 proxy-node-segment

The **proxy-node-segment** command configures a proxy-node-SID for a IS-IS prefix originating from the router that does not support IS-IS SR.

#### Command Mode

Segment-Routing MPLS Configuration

#### Command Syntax

```
proxy-node-segment ip-address index <value>
```

#### Parameters

- *ip-address* It can be IP address, or IP address with prefix, or an IPv6 address prefix.
- *index* Node segment identifier.
- *value* Index to be mapped with IP prefix. Value ranges from 0-65535.

#### Example

- A proxy-node-segment associates a /32 or a /128 route with an SID as shown below.

```
switch(config)#router isis instancel
switch(config-router-isis)#segment-routing mpls
switch(config-router-isis-sr-mpls)#proxy-node-segment 1.1.1.0/32 index
50
```

#### 14.4.6.40 redistribute (IS-IS)

The **redistribute** command redistributes the specified types of routes into IS-IS.

The **no redistribute** and **default redistribute** commands disable route redistribution from the specified domain by removing the corresponding **redistribute** statement from *running-config*.

##### Command Mode

Router-IS-IS Configuration

##### Command Syntax

```
redistribute ROUTE_TYPE
no redistribute ROUTE_TYPE
default redistribute ROUTE_TYPE
```

##### Parameters

- ROUTE\_TYPE The route type for which routes are redistributed. These are the option to include.
  - bgpredistribute BGP routes
  - connectedredistribute connected routes
  - ospfredistribute OSPF routes
  - ospfv3redistribute OSPFv3 routes
  - staticredistribute static routes

##### Examples

- These commands redistribute connected routes into the IS-IS domain.

```
switch(config)#router isis Test
switch(config-router-isis)#redistribute connected
```

- These commands redistribute static routes into the IS-IS domain.

```
switch(config)#router isis Test
switch(config-router-isis)#redistribute static
```

- These commands redistribute the BGP routes into ISIS domain in address-family mode.

```
Switch(config)#router isis 1
Switch(config-router-isis)#address-family ipv4
Switch(config-router-isis-af)#redistribute bgp route-map bgp-to-isis-v4
```

- These commands redistribute the BGP routes into ISIS domain in router-isis mode.

```
Switch(config)#router isis 1
Switch(config-router-isis)#redistribute bgp route-map bgp-to-isis
```

---

#### 14.4.6.41 redistribute bgp route-map

The **redistribute bgp route-map** command redistributes the BGP routes from the specified route map into IS-IS. Only one route map can be specified; reissuing the command overrides any previous configuration.

The **no redistribute bgp** and **default redistribute bgp** commands disable BGP route redistribution from the specified domain by removing the **redistribute bgp** statement from **running-config**.

The command is available in both router IS-IS configuration mode and the address-family submode. The command is rejected if configured in both modes at the same time. Issuing the **no** or **default** command in router IS-IS configuration mode has no effect on redistribution configured in the address-family submode.

 **Note:** If the command is configured in an address-family submode, it only redistributes routes from that address family. If it is configured in router-ISIS mode, it applies to all enabled address families.

##### Command Mode

Router-IS-IS Configuration

Router-IS-IS Address-Family Configuration

##### Command Syntax

```
redistribute bgp route-map map_name
```

```
no redistribute bgp
```

```
default redistribute ROUTE_TYPE
```

##### Parameters

*map\_name* Route map to be used for redistribution of BGP routes.

##### Examples

- These commands redistribute IPv4 BGP routes from the route map called bgp-to-isis-v4 into the ISIS domain.

```
switch(config)#router isis 1
switch(config-router-isis)#address-family ipv4
switch(config-router-isis-af)#redistribute bgp route-map bgp-to-isis-v4
switch(config-router-isis-af)#
```

- These commands redistribute all BGP routes from the route map bgp-to-isis into ISIS.

```
switch(config)#router isis 1
switch(config-router-isis)#redistribute bgp route-map bgp-to-isis
```

#### 14.4.6.42 router isis

The **router isis** command places the switch in router ISIS configuration mode.

Router ISIS configuration mode is not a group change mode; **running-config** is changed immediately after commands are executed. The **exit** command does not affect the configuration.

The **no router isis** command deletes the IS-IS instance.

The **exit** command returns the switch to global configuration mode.

##### Command Mode

Global Configuration

##### Command Syntax

```
router isis instance_name [VRF_INSTANCE]
```

```
no router isis instance_name
```

```
default router isis instance_name
```

##### Parameters

- *instance\_name* routing instance.
- VRF\_INSTANCE
  - <no parameter>
  - **vrf** *vrf\_name*

##### Examples

- These commands places the switch in router IS-IS mode and creates an IS-IS routing instance named Osiris.

```
switch(config)#router isis Osiris
switch(config-router-isis)#
```

- This command attempts to open an instance with a different routing instance name from that of the existing instance. The switch displays an error and stays in global configuration mode.

```
switch(config)#router isis Osiris
% More than 1 ISIS instance is not supported
switch(config)#
```

- This command deletes the IS-IS instance.

```
switch(config)#no router isis Osiris
switch(config)#
```

---

#### 14.4.6.43 segment-routing mpls

The **segment-routing mpls** command places the switch in the Segment-Routing MPLS configuration mode.

The **no segment-routing mpls** and **default segment-routing mpls** commands disable IS-IS SR and delete all IS-IS SR configuration.

##### Command Mode

Router IS-IS Configuration

##### Command Syntax

```
segment-routing mpls
```

```
no segment-routing mpls
```

```
default segment-routing mpls
```

##### Example

- The following commands place the switch in Segment-Routing MPLS configuration mode.

```
switch(config)#router isis instancel
switch(config-router-isis)#segment-routing mpls
switch(config-router-isis-sr-mpls)#
```



#### 14.4.6.44 set isis level

The `set isis level` command configures a route map to set ISIS level.

The `no set isis level` and `default set isis level` commands disables the set ISIS level configuration from *running-config*.

##### Command Mode

Route-map Configuration

##### Command Syntax

```
set isis level [level-1 | level-2 | level-1-2]
```

```
no set isis level [level-1 | level-2 | level-1-2]
```

```
default set isis level [level-1 | level-2 | level-1-2]
```

##### Parameters

- level-1 IS-IS level 1.
- level-2 IS-IS level 2.
- level-1-2 IS-IS level 1 and level 2.

##### Example

- These commands place the switch in route-map mode, and configures a route map to set isis level to level-1.

```
switch(config)#route-map Test
switch(config-route-map-test)#set isis level level-1
```

#### 14.4.6.45 set-overload-bit

The **set-overload-bit** command used without the on-startup option will inform other devices not to use this switch in SPF computation. When used with the on-startup parameter, the overload bit is set for the interval after startup.

The **no set-overload-bit** and **default set-overload-bit** commands removes the corresponding **set-overload-bit** command from *running-config*.

##### Command Mode

Router-IS-IS Configuration

##### Command Syntax

```
set-overload-bit TIMING
```

```
no set-overload-bit
```

```
default set-overload-bit
```

##### Parameters

- TIMING Options include:
  - <no parameter>
  - **on-startup** <1 to 3600>

##### Examples

- These commands configure the switch to sets the overload bit to 120 seconds after startup.

```
switch(config)#router isis Osiris
switch(config-router-isis)#set-overload-bit on-startup 120
switch(config-router-isis)#
```

- These commands remove the configured overload bit of 120 seconds from the *running-config*.

```
switch(config)#router isis Osiris
switch(config-router-isis)#no set-overload-bit on-startup
switch(config-router-isis)#
```

#### 14.4.6.46 show ip route

When services like LDP pseudowires, BGP LU, L2 EVPN, or L3 MPLS VPN use IS-IS SR tunnels as an underlay, these services are automatically protected by TI-LFA tunnels that protect the IS-IS SR tunnels. The **show ip route** command displays the hierarchy of the overlay-underlay-TI-LFA tunnels.

```
B 2001:db8:3::/48 [200/0]
 via 2002::b00:301/128, IS-IS SR tunnel index 3, label
122697 via TI-LFA tunnel index 5, label imp-null(3)
 via fe80::200:76ff:fe03:0, Ethernet26/1, label
imp-null(3) backup via fe80::200:76ff:fe01:0, Ethernet30/1,
label 900002 900003
```

#### 14.4.6.47 show isis database detail

The **show isis database detail** command displays a view of LSPDB of different devices in the IS-IS domain.

##### Command Mode

EXEC

##### Command Syntax

```
show isis database detail
```

##### Example

- The command output displays the TLVs and sub-TLVs that are being self-originated or the ones that have been received from other routers.

```
switch#show isis database detail

ISIS Instance: inst1 VRF: default
ISIS Level 2 Link State Database
LSPID Seq Num Cksum Life IS Flags
1111.1111.1001.00-00 10 63306 751 L2 <>
NLPID: 0xCC(IPv4) 0x8E(IPv6)
Area address: 49.0001
Interface address: 1.0.7.1
Interface address: 1.0.0.1
Interface address: 2000:0:0:47::1
Interface address: 2000:0:0:40::1
IS Neighbor : 1f319.53 Metric: 10
 LAN-Adj-sid: 100000 flags: [L V] weight: 0 system ID:
 1111.1111.1002
IS Neighbor (MT-IPv6): 1f319.53 Metric: 10
 LAN-Adj-sid: 100001 flags: [L V F] weight: 0 system ID:
 1111.1111.1002
Reachability : 1.0.11.0/24 Metric: 1 Type: 1 Up
 SR Prefix-SID: 10 Flags: [R] Algorithm: 0
Reachability : 1.0.3.0/24 Metric: 1 Type: 1 Up
Reachability : 1.0.7.1/32 Metric: 10 Type: 1 Up
 SR Prefix-SID: 2 Flags: [N] Algorithm: 0
Reachability : 1.0.0.0/24 Metric: 10 Type: 1 Up
Reachability (MT-IPv6): 2000:0:0:4b::/64 Metric: 1 Type: 1 Up
 SR Prefix-SID: 11 Flags: [R] Algorithm: 0
Reachability (MT-IPv6): 2000:0:0:43::/64 Metric: 1 Type: 1 Up
Reachability (MT-IPv6): 2000:0:0:47::1/128 Metric: 10 Type: 1 Up
 SR Prefix-SID: 3 Flags: [N] Algorithm: 0
Reachability (MT-IPv6): 2000:0:0:40::/64 Metric: 10 Type: 1 Up
Router Capabilities: 252.252.1.252 Flags: []
 SR Capability: Flags: [I V]
 SRGB Base: 900000 Range: 65536
Segment Binding: Flags: [F] Weight: 0 Range: 1 Pfx 2000:0:0:4f::
1/128
 SR Prefix-SID: 19 Flags: [] Algorithm: 0
Segment Binding: Flags: [] Weight: 0 Range: 1 Pfx 1.0.15.1/32
 SR Prefix-SID: 18 Flags: [] Algorithm: 0
```

#### 14.4.6.48 show isis database

The **show isis database** command displays the link state database of IS-IS. The default command displays active routes and learned routes.

##### Command Mode

EXEC

##### Command Syntax

```
show isis database [INSTANCES][INFO_LEVEL]
```

```
show isis database [INFO_LEVEL] [VRF_INSTANCE]
```

##### Parameters

- INSTANCES Options include:
  - <no parameter>
  - *instance\_name*
- INFO\_LEVEL Options include:
  - <no parameter>
  - **detail**
- VRF\_INSTANCE Specifies the VRF instance.
  - <no parameter>
  - **vrf** *vrf\_name*

##### Display Values

- ISIS Instance
- LSPID
- Seq Num
- Cksum
- Life
- IS

##### Examples

- This command displays general information about the link state database of IS-IS.

```
switch#show isis database

ISIS Instance: Osiris
 ISIS Level 2 Link State Database
 LSPID Seq Num Cksum Life IS Flags
 1212.1212.1212.00-00 4 714 1064 L2 <>
 1212.1212.1212.0a-00 1 57417 1064 L2 <>
 2222.2222.2222.00-00 6 15323 1116 L2 <>
 2727.2727.2727.00-00 10 15596 1050 L2 <>
 3030.3030.3030.00-00 12 62023 1104 L2 <>
 3030.3030.3030.c7-00 4 53510 1104 L2 <>
switch>
```

- This command displays detailed information about the link state database of IS-IS.

```
switch#show isis database detail

ISIS Instance: Osiris
 ISIS Level 2 Link State Database
 LSPID Seq Num Cksum Life IS Flags
 1212.1212.1212.00-00 4 714 1060 L2 <>
 Area address: 49.0001
```

```
Interface address: 10.1.1.2
Interface address: 2002::2
IS Neighbor: 1212.1212.1212.0a Metric: 10
Reachability: 10.1.1.0/24 Metric: 10 Type: 1
Reachability: 2002::/64 Metric: 10 Type: 1
1212.1212.1212.0a-00 1 57417 1060 L2 <>
IS Neighbor: 2727.2727.2727.00 Metric: 0
IS Neighbor: 2222.2222.2222.00 Metric: 0
IS Neighbor: 1212.1212.1212.00 Metric: 0
2222.2222.2222.00-00 6 15323 1112 L2 <>
Area address: 49.0001
Interface address: 10.1.1.1
Interface address: 10.1.1.3
Interface address: 2002::3
IS Neighbor: 1212.1212.1212.0a Metric: 10
Reachability: 10.1.1.0/24 Metric: 10 Type: 1
Reachability: 10.1.1.0/24 Metric: 10 Type: 1
Reachability: 2002::/64 Metric: 10 Type: 1
2727.2727.2727.00-00 10 15596 1046 L2 <>
Area address: 49.0001
Interface address: 10.1.1.1
Interface address: 30.1.1.1
Interface address: 2002::1
Interface address: 2001::1
IS Neighbor: 1212.1212.1212.0a Metric: 10
IS Neighbor: 3030.3030.3030.c7 Metric: 10
Reachability: 10.1.1.0/24 Metric: 10 Type: 1
Reachability: 30.1.1.0/24 Metric: 10 Type: 1
Reachability: 2002::/64 Metric: 10 Type: 1
Reachability: 2001::/64 Metric: 10 Type: 1
3030.3030.3030.00-00 12 62023 1100 L2 <>
Area address: 49.0001
Interface address: 30.1.1.2
Interface address: 2001::2
IS Neighbor: 3030.3030.3030.c7 Metric: 10
Reachability: 12.1.1.0/24 Metric: 1 Type: 1
Reachability: 110.1.1.0/24 Metric: 0 Type: 1
Reachability: 30.1.1.0/24 Metric: 10 Type: 1
Reachability: 2001::/64 Metric: 10 Type: 1
3030.3030.3030.c7-00 4 53510 1100 L2 <>
IS Neighbor: 2727.2727.2727.00 Metric: 0
IS Neighbor: 3030.3030.3030.00 Metric: 0
switch>
```

#### 14.4.6.49 show isis dynamic flooding

Use the **show isis dynamic flooding** command to monitor Dynamic Flooding.

##### Command Mode

EXEC

##### Command Syntax

```
show isis dynamic flooding [interfaces | level-1 | level-2 | nodes | paths | topology | interface]
```

##### Parameters

- **interfaces** Flooding interfaces
- **level-1** Level 1 adjencencies only.
- **level-2** Level 2 adjencencies only.
- **nodes** Nodes in the flooding topology.
- **paths** Paths in the flooding topology.
- **topology** Flooding topology.

##### Examples

- The command **show isis dynamic flooding nodes** shows the list of nodes in the area and the indices for the nodes.

```
switch#show isis dynamic flooding nodes
IS-IS Instance: Amun VRF: default
 Level 1 Nodes:
 Index Node ID
 0 ip6.00
 1 ip4.00
 2 ip2.00
 3 ip1.00
 4 ip3.00
 5 ip5.00
```

- The command **show isis dynamic flooding paths** shows the list of paths in the flooding topology using node indices.

```
switch#show isis dynamic flooding paths
IS-IS Instance: Amun VRF: default
 Level 1:
 Path: 0 1 2 3 4 5 0
```

- To view the flooding topology, use the **show isis dynamic flooding topology** command:

```
switch#show isis dynamic flooding topology
IS-IS Instance: Amun VRF: default
 Level 1:
 Path: ip6.00 ip4.00 ip2.00 ip1.00 ip3.00 ip5.00 ip6.00
```

- To view which interfaces dynamic flooding will use, use the **show isis dynamic flooding interfaces** command:

```
switch#show isis dynamic flooding interfaces
IS-IS Instance: Amun VRF: default
 Level 1:
 Ethernet5
 Ethernet4
```

#### 14.4.6.50 show isis graceful-restart vrf

The **show isis graceful-restart vrf** command displays the GR configuration and graceful-restart related state of the IS-IS instance as well as its neighbors.

##### Command Mode

EXEC

##### Command Syntax

```
show isis graceful-restart vrf <vrf-name>
```

##### Example

- In this example the show isis graceful-restart command displays the output for the default vrf instance.

```
switch#show isis graceful-restart vrf default
IS-IS Instance: 1 VRF: default
System ID: 0000.0000.0001
Graceful Restart: Enabled, Graceful Restart Helper: Enabled
State: Last Start exited after T2 (level-1) expiry
T1 : 3s
T2 (level-1) : 30s/20s remaining
T2 (level-2) : 30s/not running
T3 : not running

System ID Type Interface Restart Capable Status
is-hostname-1 L1L2 Ethernet1 Yes Running
is-hostname-2 L1 Ethernet2 Yes Restarting
```

---

#### 14.4.6.51 show isis hostname

The `show isis hostname` command displays mapping between the System ID and IS-IS hostname.

##### Command Mode

EXEC

##### Command Syntax

```
show isis hostname
```

##### Example

- This command mapping between the System ID and IS-IS hostnames host1 and host2.

```
switch#show isis hostname
ISIS Instance: 1 VRF: default
Level System ID Hostname
L1 1111.1111.1001 host1
L1 1111.1111.1002 host2
```



### 14.4.6.52 show isis interface

The `show isis interface` command displays interface information for the IS-IS instance.

#### Command Mode

EXEC

#### Command Syntax

```
show isis interface [INSTANCES][INTERFACE_NAME] [INFO_LEVEL]
```

```
show isis interface [INTERFACE_NAME] [INFO_LEVEL] [VRF_INSTANCE]
```

#### Parameters

- INSTANCES Options include:
  - <no parameter>
  - **instance\_name**
- INTERFACE\_NAME Values include
  - <no parameter> all interfaces.
  - **ethernet** *e\_num* Ethernet interface specified by *e\_num*.
  - **loopback** *l\_num* Loopback interface specified by *l\_num*.
  - **management** *m\_num* Management interface specified by *m\_num*.
  - **port-channel** *p\_num* Port channel interface specified by *p\_num*.
  - **vlan** *v\_num* VLAN interface specified by *v\_num*.
  - **vxlan** *vx\_num* VXLAN interface specified by *vx\_num*.
- INFO\_LEVEL Options include:
  - <no parameter>
  - **detail**
- VRF\_INSTANCE specifies the VRF instance.
  - <no parameter>
  - **vrf** *vrf\_name*

#### Display Values

- ISIS Instance
- System ID
- Index
- MTU
- Metric
- LAN-ID
- DIS
- Type
- Interface
- SNPA
- State
- Hold time

#### Examples

- This command displays general IS-IS information for instance Osiris.

```
switch#show isis interface

ISIS Instance: Osiris
Interface Vlan20:
 Index: 59 SNPA: 0:1c:73:c:5:7f
```

```

MTU: 1497 Type: broadcast
Level 2:
 Metric: 10, Number of adjacencies: 2
 LAN-ID: 1212.1212.1212, Priority: 64
 DIS: 1212.1212.1212, DIS Priority: 64
Interface Ethernet30:
 Index: 36 SNPA: 0:1c:73:c:5:7f
 MTU: 1497 Type: broadcast
 Level 2:
 Metric: 10, Number of adjacencies: 1
 LAN-ID: 3030.3030.3030, Priority: 64
 DIS: 3030.3030.3030, DIS Priority: 64

```

- This command displays detailed IS-IS information for instance Osiris.

```

switch#show isis interface detail

ISIS Instance: Osiris
Interface Vlan20:
 Index: 59 SNPA: 0:1c:73:c:5:7f
 MTU: 1497 Type: broadcast
 Level 2:
 Metric: 10, Number of adjacencies: 2
 LAN-ID: 1212.1212.1212, Priority: 64
 DIS: 1212.1212.1212, DIS Priority: 64
 Adjacency 2222.2222.2222:
 State: UP, Level: 2 Type: Level 2 IS
 Hold Time: 30, Supported Protocols: ipv4, ipv6
 SNPA: 2:1:0:c:0:0, Priority: 64
 IPv4 Interface Address: 10.1.1.3
 IPv6 Interface Address: fe80::1:ff:fe0c:0
 Areas:
 49.0001
 Adjacency 1212.1212.1212:
 State: UP, Level: 2 Type: Level 2 IS
 Hold Time: 9, Supported Protocols: ipv4, ipv6
 SNPA: 2:1:0:d:0:0, Priority: 64
 IPv4 Interface Address: 10.1.1.2
 IPv6 Interface Address: fe80::1:ff:fe0d:0
 Areas:
 49.0001
Interface Ethernet30:
 Index: 36 SNPA: 0:1c:73:c:5:7f
 MTU: 1497 Type: broadcast
 Level 2:
 Metric: 10, Number of adjacencies: 1
 LAN-ID: 3030.3030.3030, Priority: 64
 DIS: 3030.3030.3030, DIS Priority: 64
 Adjacency 3030.3030.3030:
 State: UP, Level: 2 Type: Level 2 IS
 Hold Time: 9, Supported Protocols: ipv4, ipv6
 SNPA: 2:1:0:b:0:0, Priority: 64
 IPv4 Interface Address: 30.1.1.2
 IPv6 Interface Address: fe80::1:ff:fe0b:0
 Areas:
 49.0001

```

- This example displays the state of TI-LFA protection for IPv4/IPV6 prefixes learned on that IS-IS interface.

```

switch#show isis interface Vlan2387

IS-IS Instance: inst1 VRF: default

```

```

Interface Vlan2387:
 Index: 36 SNPA: P2P
 MTU: 1497 Type: point-to-point
 BFD IPv4 is Disabled
 BFD IPv6 is Disabled
 Hello Padding is Enabled
 Level 2:
 Metric: 10, Number of adjacencies: 1
 Link-ID: 24
 Authentication mode: None
 TI-LFA node protection with SRLG loose protection is enabled for
the following IPv4 segments: node segments, adjacency segments
 TI-LFA protection is disabled for IPv6

```

#### 14.4.6.53 show isis local-convergence-delay

The **show isis local-convergence-delay** command shows the current or last attempt at delaying the convergence of protected routes on a link down/BFD neighbor down event. If the timer aborts for some reason (such as a topology change causing a new SPF), the attempt fails.

```

switch#show isis local-convergence-delay

IS-IS Instance: inst1 VRF: default
System ID: 1111.1111.1001
IPv4 local convergence delay configured, 5000 msec
IPv6 local convergence delay configured, 5000 msec
Level 1 attempts 0, failures 0
Level 2 attempts 3, failures 1

Level 2 in progress due to LINK DOWN on Vlan2138
TI-LFA node protection is enabled for IPv4
IPv4 Routes delayed: 0
 Delay timer started at: 2019-07-25 23:16:33
 Delay timer expires in 2 secs
TI-LFA protection is disabled for IPv6

Level 2 last attempt due to LINK DOWN on Vlan2138, Succeeded
TI-LFA node protection is enabled for IPv4
IPv4 Routes delayed: 3
 Delay timer started at: 2019-07-25 23:14:51
 Delay timer stopped at: 2019-07-25 23:14:56
TI-LFA protection is disabled for IPv6

```

The **detail** keyword also lists all the routes that have been delayed.

```

switch#show isis local-convergence-delay detail
...
Level 2 last attempt due to LINK DOWN on Vlan2138, Succeeded
TI-LFA node protection is enabled for IPv4
IPv4 Routes delayed: 3
 Delay timer started at: 2019-07-25 23:14:51
 Delay timer stopped at: 2019-07-25 23:14:56
 Delayed routes:
 10.0.7.1/32
 10.0.9.1/32

```

---

```
10.0.10.1/32
TI-LFA protection is disabled for IPv6
```

### 14.4.6.54 show isis neighbors

The `show isis neighbors` command displays IS-IS neighbor information.

#### Command Mode

EXEC

#### Command Syntax

```
show isis neighbors [INSTANCES] [INFO_LEVEL]
```

```
show isis neighbor [INFO_LEVEL] [VRF_INSTANCE]
```

#### Parameters

- INSTANCES Options include:
  - <no parameter>
  - *instance\_name*
- INFO\_LEVEL Options include:
  - <no parameter>
  - **detail**
- VRF\_INSTANCE Specifies the VRF instance.
  - <no parameter>
  - **vrf** *vrf\_name*

#### Display Values

- Inst. ID
- System ID
- Type
- Interface
- SNPA
- State
- Hold time
- Area Address

#### Example

- This command displays general information about the IS-IS neighbors.

```
switch(config)#show isis neighbors

Inst Id System Id Type Interface SNPA State Hold time

10 2222.2222.2222 L2 Vlan20 2:1:0:c:0:0 UP 30
10 1212.1212.1212 L2 Vlan20 2:1:0:d:0:0 UP 9
10 3030.3030.3030 L2 Ethernet30 2:1:0:b:0:0 UP 9

switch(config)#
```

#### 14.4.6.55 show isis network topology

The **show isis network topology** command displays a list of all connected devices in all areas.

##### Command Mode

EXEC

##### Command Syntax

```
show isis network topology
show isis INSTANCES topology
show isis network topology VRF_INSTANCE
```

##### Parameter

- INSTANCES Options include:
  - <no parameter>
  - *instance\_name*
- VRF\_INSTANCE Specifies the VRF instance.
  - <no parameter>
  - *vrf vrf\_name*

##### Display Values

- System Id
- Metric
- Next-Hop
- Interface
- SNPA

##### Examples

- This command displays forwarding state for ports mapped to all VLANs.

```
switch#show isis network topology

ISIS Instance: Osiris VRF: default
 ISIS IP paths to level-2 routers
 System Id Metric Next-Hop Interface SNPA
 00e0.52b5.78002010.110.2.1 1/700e0.22b5.5843
switch>
```

- This command displays detailed information about the IS-IS neighbors.

```
switch(config)#show isis neighbors detail

Inst Id System Id Type Interface SNPA State Hold time
 10 2222.2222.2222 L2 Vlan20 2:1:0:c:0:0 UP 26
Area Address(es): 49.0001
SNPA: 2:1:0:c:0:0
Advertised Hold Time: 30
State Changed: -
LAN Priority: 64
IPv4 Interface Address: 10.1.1.3
IPv6 Interface Address: fe80::1:ff:fe0c:0
Interface name: Vlan20
 10 1212.1212.1212 L2 Vlan20 2:1:0:d:0:0 UP 7
Area Address(es): 49.0001
SNPA: 2:1:0:d:0:0
Advertised Hold Time: 9
State Changed: -
LAN Priority: 64
IPv4 Interface Address: 10.1.1.2
IPv6 Interface Address: fe80::1:ff:fe0d:0
Interface name: Vlan20
switch(config)#
```

### 14.4.6.56 show isis segment-routing adjacency-segments

The **show isis segment-routing adjacency-segments** command displays the global adjacency SID value and other related information.

#### Command Mode

EXEC

#### Command Syntax

```
show isis segment-routing adjacency-segments
```

#### Examples

- In this example the **show isis segment-routing adjacency-segments** command displays the output for the interface configured like this:

```
interface Ethernet1
 ip address 1.1.1.1/24
 ipv6 address 1000::1/64
 isis enable isis1
 isis network point-to-point
 adjacency-segment ipv4 p2p index 1 global
 adjacency-segment ipv6 p2p index 2 global
```

- The show output for the above interface configuration:

```
switch#show isis segment-routing adjacency-segments

System ID: 1000.0000.0002 Instance: isis1
SR supported Data-plane: MPLS SR Router ID: 1.1.1.4
Adj-SID allocation mode: SR-adjacencies
Adj-SID allocation pool: Base: 100000 Size: 16384
Adjacency Segment Count: 2
Flag Descriptions: F: Ipv6 address family, B: Backup, V: Value
 L: Local, S: Set

Segment Status codes: L1 - Level-1 adjacency, L2 - Level-2 adjacency, P2P -
Point-to-Point adjacency, LAN - Broadcast adjacency

Locally Originated Adjacency Segments
Adj IP Address Local Intf SID SID Source Flags Type

1.1.1.2 Et1 1 Configured F:0 B:0 V:0 L:0 S:0 P2P L1
fe80::1:ff:fe65:0 Et1 2 Configured F:1 B:0 V:0 L:0 S:0 P2P L1

Received Global Adjacency Segments
SID Originator Neighbor Flags

0 rtrmpls1 1000.0000.0002 F:0 B:0 V:0 L:0 S:0
```

- The following is the C-API output for the show isis segment-routing adjacency-segments command.

```
switch#show isis segment-routing adjacency-segments | json
{
 "vrfs": {
 "default": {
 "isisInstances": {
 "isis1": {
 "routerId": "1.1.1.4",
 "adjSidPoolSize": 16384,
 "receivedGlobalAdjacencySegments": [
 {
 "systemId": "1000.0000.0001",
 "hostname": "rtrmpls1",
 "sid": 0,
 "flags": {
```

```

 "s": false,
 "b": false,
 "v": false,
 "f": false,
 "l": false
 },
 "nbrSystemId": "1000.0000.0002"
 }
},
"systemId": "1000.0000.0002",
"adjSidAllocationMode": "SrOnly",
"dataPlane": "MPLS",
"adjacencySegments": [
 {
 "lan": false,
 "sidOrigin": "configured",
 "flags": {
 "s": false,
 "b": false,
 "v": true,
 "f": false,
 "l": false
 },
 "sid": 1,
 "localIntf": "Ethernet1",
 "ipAddress": "1.1.1.2",
 "level": 1
 },
 {
 "lan": false,
 "sidOrigin": "configured",
 "flags": {
 "s": false,
 "b": false,
 "v": false,
 "f": true,
 "l": false
 },
 "sid": 2,
 "localIntf": "Ethernet1",
 "ipAddress": "fe80::1:ff:fe65:0",
 "level": 1
 }
],
"adjSidPoolBase": 100000,
"misconfiguredAdjacencySegments": []
}
}
}
}

```

- switch#show isis segment-routing adjacency-segments

```

...
Locally Originated Adjacency Segments
Adj IP Address Local Intf SID Flags
Protection

10.1.0.1 V12138 100001 F:0 B:1 V:1 L:1 S:0
node
10.1.0.2 V12968 100002 F:0 B:1 V:1 L:1 S:0
node with SRLG loose

```



```

10.1.0.3 V12387 965537 F:0 B:1 V:1 L:1 S:0
node with SRLG strict

Received Global Adjacency Segments
SID Originator Neighbor Flags
 Protection

5 1111.1111.1005 1111.1111.1004 F:0 B:1 V:0 L:0
S:0 node

```

---

#### 14.4.6.57 show isis segment-routing global-blocks

The **show isis segment-routing global-blocks** command lists the SRGBs in use by all SR supporting devices in IS-IS domain including the SRGB in use by IS-IS SR on this device.

##### Command Mode

EXEC

##### Command Syntax

```
show isis segment-routing global-blocks
```

##### Example

```
switch#show isis segment-routing global-blocks
System ID: 1111.1111.1002 Instance: inst1
SR supported Data-plane: MPLS SR Router ID: 252.252.2.252
SR Global Block(SRGB): Base: 900000 Size: 65536
Number of ISIS segment routing capable peers: 3
SystemId Base Size

1111.1111.1002 900000 65536
1111.1111.1001 900000 65536
```

### 14.4.6.58 show isis segment-routing prefix-segments

The `show isis segment-routing prefix-segments` command provides the details of all prefix segments being originated as well the segments received from IS-IS SR speakers in the domain.

#### Command Mode

EXEC

#### Command Syntax

```
show isis segment-routing prefix-segments
```

#### Example

```
switch#show isis segment-routing prefix-segments
System ID: 1111.1111.1002 Instance: inst1
SR supported Data-plane: MPLS SR Router ID: 252.252.2.252
Node: 2 Proxy-Node: 2 Prefix: 2 Total Segments: 6
Flag Descriptions: R: Re-advertised, N: Node Segment, P: no-PHP
 E: Explicit-NULL, V: Value, L: Local
Segment status codes: * - Self originated Prefix, L1 - level 1, L2 - level 2
 Prefix SID Type Flags SystemID Type

 1.0.7.1/32 2 Node R:0 N:1 P:0 E:0 V:0 L:0 1111.1111.1001 L1
* 1.0.8.1/32 4 Node R:0 N:1 P:0 E:0 V:0 L:0 1111.1111.1002 L2
 1.0.11.0/24 10 Prefix R:1 N:0 P:0 E:0 V:0 L:0 1111.1111.1001 L2
* 1.0.12.0/24 12 Prefix R:1 N:0 P:0 E:0 V:0 L:0 1111.1111.1002 L2
 1.0.15.1/32 18 Proxy-Node R:0 N:0 P:0 E:0 V:0 L:0 1111.1111.1001 L2
 1.0.16.1/32 20 Proxy-Node R:0 N:0 P:0 E:0 V:0 L:0 1111.1111.1003 L2
```

```
switch#show isis segment-routing prefix-segments
...
 Prefix SID Type ... System ID Level Protection

* 10.1.1.1/32 0 Node ... 1111.1111.1001 L2
 unprotected
 10.1.1.2/32 1 Node ... 1111.1111.1002 L2 node with
SRLG loose
 10.1.1.3/32 4 Node ... 1111.1111.1005 L2 node with
SRLG strict
 10.1.1.4/32 10 Prefix ... 1111.1111.1004 L1 node
```

#### About the Output

After the usual output header that represents the system ID, instance name, etc and parameters of a router, there is a line depicting prefix segment counters. Each field in this line relates to the number of segments that are present in this routers IS-IS instance. For example, the above example shows that this device has 2 Node Segments (Self originated as well as the ones received from other IS-IS SR devices).

The main section of this show commands output is the section that lists all the prefix segments and related information like prefix, SID, type of segment (Prefix, Node, Proxy-Node), the flag values being carried in the sub-TLVs of these prefix segments and the system ID of the originating router. The Type field will be useful on a IS type level-1-2 router. It shows whether the installed prefix segment is from a level-1 prefix or a level-2 prefix.

#### 14.4.6.59 show isis segment-routing

The **show isis segment-routing** command displays the summary information on IS-IS SR status.

##### Command Mode

EXEC

##### Command Syntax

```
show isis segment-routing
```

##### Example

- The command output displays the summary information on IS-IS SR status.

```
switch(config)#show isis segment-routing
System ID: 1111.1111.1002 Instance: inst1
SR supported Data-plane: MPLS SR Router ID: 252.252.2.252
SR Global Block(SRGB): Base: 900000 Size: 65536
Adj-SID allocation mode: SR-adjacencies
Adj-SID allocation pool: Base: 100000 Size: 16384
All Prefix Segments have : P:0 E:0 V:0 L:0
All Adjacency Segments have : F:0 B:0 V:1 L:1 S:0
ISIS Reachability Algorithm : SPF (0)
Number of ISIS segment routing capable peers: 3
Self-Originated Segment Statistics:
Node-Segments : 2
Prefix-Segments : 2
Proxy-Node-Segments : 0
Adjacency Segments :
```

##### About the Output

The first line of the output shows the IS-IS system ID of this device and the name of the instance with which IS-IS is configured.

The supported data plane is shown against the SR supported Data-plane field, while the router ID being advertised in the Router Capability is mentioned in the SR Router ID field.

The SRGB in use and the MPLS label pool being used for adjacency segment allocation are mentioned in this output. The current adjacency allocation mode which refers to whether we are allocating adjacency segments to all IS-IS adjacencies or only those adjacencies which support SR or None of the adjacencies is shown in the Adj-SID allocation mode field.

Flag contents of All Prefix Segments originated on this router, Flag contents of All Adjacency Segments originated on this router and supported IS-IS Reachability Algorithm have been provided through this command output and they carry the meaning as per the IS-IS SR IETF draft.

This show command provides a statistics related to IS-IS SR in terms of various counters ranging from number of IS-IS SR enabled peers, number of Node-SIDs, prefix-SIDs, proxy-node-segments and adjacency segments being originated on this router in IS-IS.

The **show isis segment-routing** command also provides information if segment routing has been administratively disabled as shown.

```
switch(config-router-isis-sr-mpls)#sh isis segment-routing
```

! IS-IS (Instance: inst1) Segment Routing has been administratively shutdown

#### 14.4.6.60 show isis segment-routing tunnel

The **show isis segment-routing tunnel** command displays all the IS-IS SR tunnels. The field **TI-LFA tunnel index** displays the index of the TI-LFA tunnel protecting the SR tunnel. The same TI-LFA tunnel that protects the LFIB route also protects the corresponding IS-IS SR tunnel.

```
switch#show isis segment-routing tunnel 10.0.10.1/32
Index Endpoint Nexthop Interface Labels TI-LFA
index

4 10.0.10.1/32 10.0.0.2 Vlan2387 [900004] 0
```

---

#### 14.4.6.61 show isis summary

The **show isis summary** command displays information about the configured IS-IS instances.

##### Command Mode

EXEC

##### Command Syntax

```
show isis summary
```

```
show isis [INSTANCES] summary
```

```
show isis summary VRF_INSTANCE
```

##### Parameters

- INSTANCES Options include:
  - <no parameter>
  - *instance\_name*
- VRF\_INSTANCE Specifies the VRF instance.
  - <no parameter>
  - **vrf** *vrf\_name*

##### Display Values

- System ID
- IPv4 Preference
- IPv6 Preference
- IS-Types
- LSP Generation interval
- SPF Interval
- Current SPF Hold Interval
- IS-Types Run Time
- Area Addresses
- Designated Intermediate Systems (DIS) Interfaces
- Link State Database (LSDB) size

##### Display Status

- Multi Topology
- Authentication Mode
- Graceful Restart
- Graceful Restart Helper

##### Example

- This command displays general information about the configured IS-IS instances.

```
switch(config-router-isis-af)#show isis summary

IS-IS Instance: 1 VRF: default
System ID: 0000.0000.0001, administratively enabled
Multi Topology disabled, not attached
IPv4 Preference: Level 1: 115, Level 2: 115
IPv6 Preference: Level 1: 115, Level 2: 115
IS-Type: Level 1 and 2, Number active interfaces: 0
Routes both IPv4 and IPv6

 Max wait(s) Initial wait(ms) Hold
interval(ms)
LSP Generation Interval: 5 50 50
SPF Interval: 2 1000 1000
```

```

Current SPF hold interval(ms): Level 1: 1000, Level 2: 1000
Last Level 1 SPF run 1 seconds ago
Last Level 2 SPF run 1 seconds ago
Authentication mode: Level 1: None, Level 2: None
Graceful Restart: Disabled, Graceful Restart Helper: Enabled
Area Addresses:
 49.0001
level 1: number dis interfaces: 0, LSDB size: 1
level 2: number dis interfaces: 0, LSDB size: 1

```

#### 14.4.6.62 show isis ti-lfa path

The `show isis ti-lfa path` command displays the repair path with the list of all the system IDs from the P-node to the Q-node for every destination/constraint tuple. You will see that even though node protection is configured, a link protecting LFA is computed too. This is to fallback to link protecting LFAs if the node protecting LFA becomes unavailable.

```

switch#show isis ti-lfa path 1111.1111.1005
TI-LFA paths for IPv4 address family
Topo-id: Level-2
Destination Constraint Path
1111.1111.1005 exclude node 1111.1111.1002 1111.1111.1003
 1111.1111.1004
 exclude Vlan2387
 SRLG strict 1111.1111.1002

```

```

switch#show isis ti-lfa path 10.10.10.1/32
TI-LFA paths for IPv4 address family
Topo-id: Level-1
Destination Constraint Path

10.10.10.1/32 exclude Vlan2387 1111.1111.1002
 1111.1111.1003
 exclude node 1111.1111.1004 1111.1111.1002
SRLG strict 1111.1111.1003

```

#### 14.4.6.63 show isis ti-lfa tunnel

The TI-LFA repair tunnels are just internal constructs that are shared by multiple LFIB routes that compute similar repair paths. The `show isis ti-lfa tunnel` command displays TI-LFA repair tunnels with the primary and backup via information.

```

switch#show isis ti-lfa tunnel 1
Tunnel Index 1
 via 10.0.1.2, 'Vlan2968'
 label stack 3
 backup via 10.0.0.2, 'Vlan2387'
 label stack 900004 900002

```

#### 14.4.6.64 show mpls lfib route

The **show mpls lfib route** command displays the backup information along with the primary vias for all node or adjacency segments that have TI-LFA backup paths computed. The following is the **show mpls lfib route** command output for the sample topology depicted for the **show tunnel fib** command.

```
switch#show mpls lfib route 900005
...
IP 900004 [1], 10.0.10.1/32
 via TI-LFA tunnel index 0, swap 900004
 payload autoDecide, ttlMode uniform, apply
egress-acl
 via 10.0.0.2, Vlan2387, label imp-null(3)
 backup via 10.0.1.2, Vlan2968, label 100001
```

```
switch#show mpls lfib route 900005
...
IA 900005 [1]
 via TI-LFA tunnel index 0, swap 900005
 payload autoDecide, ttlMode uniform, apply
egress-acl
 via 10.0.0.2, Vlan2387, label imp-null(3)
 backup via 10.0.1.2, Vlan2968, label 100001
```

```
switch#show mpls lfib route 900002
...
IP 900002 [1], 10.0.8.1/32
 via TI-LFA tunnel index 1, pop
 payload autoDecide, ttlMode uniform, apply
egress-acl
 via 10.0.1.2, Vlan2968, label imp-null(3)
 backup via 10.0.0.2, Vlan2387, label 900004
900002
```

#### 14.4.6.65 show tunnel fib

The **show tunnel fib** command that displays tunnels programmed in the tunnel FIB also includes the TI-LFA tunnels along with protected IS-IS SR tunnels.

```
switch#show tunnel fib ti-lfa 1
Type 'TI-LFA', index 1, forwarding None
 via 10.0.1.2, 'Vlan2968'
 label stack 3
 backup via 10.0.0.2, 'Vlan2387'
```



```
label stack 900004 900002
```

```
switch#show tunnel fib isis segment-routing
```

```
Type 'IS-IS SR', index 1, endpoint 2002::b00:201/128, forwarding
Primary
 via TI-LFA tunnel index 3 label 3
 via fe80::200:76ff:fe01:0, 'Ethernet30/1' label 900002
 backup via fe80::200:76ff:fe03:0, 'Ethernet26/1' label
132769
```

```
Type 'IS-IS SR', index 2, endpoint 2002::b00:101/128, forwarding
Primary
 via TI-LFA tunnel index 4 label 3
 via fe80::200:76ff:fe01:0, 'Ethernet30/1' label 3
 backup via fe80::200:76ff:fe03:0, 'Ethernet26/1' label
132769 900001
```

---

#### 14.4.6.66 show mpls label ranges

The **show mpls label ranges** command displays the MPLS label range available on a router is categorized into different pools which cater to different applications running on the router.

##### Command Mode

EXEC

##### Command Syntax

```
show mpls label ranges
```

##### Example

```
switch#show mpls label ranges
Start End Size Usage

0 15 16 reserved
16 99999 99984 static mpls
100000 116383 16384 isis (dynamic)
116384 362143 245760 free (dynamic)
362144 899999 537856 unassigned
900000 965535 65536 isis-sr
```

**14.4.6.67 show mpls lfib route <label value>**

The **show mpls lfib route <label value>** command provides information relevant to just the label value passed as an extension to the show command.

**Command Mode**

EXEC

**Command Syntax**

```
show mpls lfib route <label value>
```

**Example**

```
switch#show mpls lfib route 900008
MPLS forwarding table (Label [metric] Vias) - 7 routes
MPLS next-hop resolution allow default route: False
Via Type Codes:
 M - Mpls Via, P - Pseudowire Via,
 I - IP Lookup Via, V - Vlan Via,
 VA - EVPN Vlan Aware Via, ES - EVPN Ethernet Segment Via,
 VF - EVPN Vlan Flood Via, AF - EVPN Vlan Aware Flood Via,
 NG - Nexthop Group Via
Source Codes:
 S - Static MPLS Route, B2 - BGP L2 EVPN,
 B3 - BGP L3 VPN, R - RSVP,
 P - Pseudowire, L - LDP,
 IP - IS-IS SR Prefix Segment, IA - IS-IS SR Adjacency Segment,
 IL - IS-IS SR Segment to LDP, LI - LDP to IS-IS SR Segment,
 BL - BGP LU, ST - SR TE Policy,
 DE - Debug LFIB
IP 900008 [1]
 via M, 1.0.1.2, swap 900008
 payload autoDecide, ttlMode uniform, apply egress-acl
 interface Vlan2930
```

#### 14.4.6.68 show mpls lfib route

The **show mpls lfib route** command displays the LFIB. Each LFIB entry has In-Label, Out-Label, metric, payload type, nexthop information, etc. fields. The source column depicts the MPLS control plane protocol that is responsible for the label binding that resulted in this LFIB route.

##### Command Mode

EXEC

##### Command Syntax

```
show mpls lfib route
```

##### Example

```
switch#show mpls lfib route
MPLS forwarding table (Label [metric] Vias) - 7 routes
MPLS next-hop resolution allow default route: False
Via Type Codes:
 M - Mpls Via, P - Pseudowire Via,
 I - IP Lookup Via, V - Vlan Via,
 VA - EVPN Vlan Aware Via, ES - EVPN Ethernet Segment Via,
 VF - EVPN Vlan Flood Via, AF - EVPN Vlan Aware Flood Via,
 NG - Nexthop Group Via
Source Codes:
 S - Static MPLS Route, B2 - BGP L2 EVPN,
 B3 - BGP L3 VPN, R - RSVP,
 P - Pseudowire, L - LDP,
 IP - IS-IS SR Prefix Segment, IA - IS-IS SR Adjacency Segment,
 IL - IS-IS SR Segment to LDP, LI - LDP to IS-IS SR Segment,
 BL - BGP LU, ST - SR TE Policy,
 DE - Debug LFIB
IA 100000 [1]
 via M, 1.0.1.2, pop
 payload autoDecide, ttlMode uniform, apply egress-acl
 interface Vlan2930
IA 100001 [1]
 via M, fe80::200:eff:fe02:0, pop
 payload autoDecide, ttlMode uniform, apply egress-acl
 interface Vlan2930
IP 900008 [1]
 via M, 1.0.1.2, swap 900008
 payload autoDecide, ttlMode uniform, apply egress-acl
 interface Vlan2930
IP 900009 [1]
 via M, fe80::200:eff:fe02:0, swap 900009
 payload autoDecide, ttlMode uniform, apply egress-acl
 interface Vlan2930
```

#### 14.4.6.69 show mpls segment-routing bindings

The **show mpls segment-routing bindings** command displays the local label bindings and label bindings on the peer routers for each prefix that has a segment advertised. Peer ID here represents the IS-IS system ID of the peer.

##### Command Mode

EXEC

##### Command Syntax

```
show mpls segment-routing bindings
```

##### Example

```
switch#show mpls segment-routing bindings
1.0.7.1/32
 Local binding: Label: 900002
 Remote binding: Peer ID: 1111.1111.1001, Label: imp-null
 Remote binding: Peer ID: 1111.1111.1003, Label: 900002
1.0.8.1/32
 Local binding: Label: imp-null
 Remote binding: Peer ID: 1111.1111.1001, Label: 900004
 Remote binding: Peer ID: 1111.1111.1003, Label: 900004
1.0.9.1/32
 Local binding: Label: 900006
 Remote binding: Peer ID: 1111.1111.1001, Label: 900006
 Remote binding: Peer ID: 1111.1111.1003, Label: imp-null
```

---

#### 14.4.6.70 shutdown (IS-IS SR)

The **shutdown** and **default shutdown** commands administratively disable IS-IS SR on the switch without modifying the IS-IS SR configuration.

The **no shutdown** command enables IS-IS SR.

##### Command Mode

Segment-Routing MPLS Configuration

##### Command Syntax

```
shutdown
```

```
no shutdown
```

```
default shutdown
```

##### Examples

- These commands administratively disable IS-IS SR on the switch but preserve the IS-IS SR configuration.

```
switch(config)#router isis Osiris
switch(config-router-isis)#segment-routing mpls
switch(config-router-isis-sr-mpls)#shutdown
switch(config-router-isis-sr-mpls)#
```

- This command enables IS-IS SR on the switch.

```
switch(config)#router isis Osiris
switch(config-router-isis)#segment-routing mpls
switch(config-router-isis-sr-mpls)#no shutdown
switch(config-router-isis-sr-mpls)#
```

### 14.4.6.71 shutdown (IS-IS)

The **shutdown** command disables IS-IS on the switch without modifying the IS-IS configuration.

The **no shutdown** and **default shutdown** commands enable the IS-IS instance by removing the **shutdown** command from *running-config*.

#### Command Mode

Router-IS-IS Configuration

#### Command Syntax

```
shutdown
```

```
no shutdown
```

```
default shutdown
```

#### Examples

- These commands disable IS-IS on the switch.

```
switch(config)#router isis Osiris
switch(config-router-isis)#shutdown
switch(config-router-isis)#
```

- This command enables IS-IS on the switch.

```
switch(config)#router isis Osiris
switch(config-router-isis)#no shutdown
switch(config-router-isis)#
```

---

### 14.4.6.72 spf-interval

The **spf-interval** command sets the Shortest Path First (SPF) timer that defines the interval between IS-IS path calculations. The default value is two seconds.

This command also configures the maximum wait interval between any two SPF runs, initial wait interval before executing the first SPF computation, and the hold time between the first and second SPF runs.

The **no spf-interval** and **default spf-interval** commands restore the default maximum IS-IS path calculation interval to two seconds by removing the **spf-interval** command from **running-config**.

For information about viewing SPF interval values, see [Displaying IS-IS Instance Information](#).

#### Command Mode

Router-IS-IS Configuration

#### Command Syntax

```
spf-interval max-wait [initial-wait | hold-time]
no spf-interval
default spf-interval
```

#### Parameters

- *max-wait* Value ranges from 1 through 300 seconds. Default maximum wait interval is two seconds.
- *initial-wait* Value ranges from 1 through 300000 ms. Default initial wait interval is 1000 ms.
- *hold-time* Value ranges from 1 through 300000 ms. Default hold interval is 1000 ms.

#### Guidelines

EOS does not support configuring topology-specific SPF timers in multi-topology deployments and IS-IS level-specific SPF timers.

#### Examples

- This command configures the SPF maximum wait interval to 50 seconds.

```
switch(config)#router isis Osiris
switch(config-router-isis)#spf-interval 50
```

- This command configures maximum wait interval, initial wait interval, and hold time to 20 seconds, 10000 ms, and 5000 ms respectively.

```
switch(config)#router isis inst1
switch(config-router-isis)#spf-interval 20 10000 5000
```

- This command reverts the SPF interval configuration to its default value.

```
switch(config)#router isis Osiris
switch(config-router-isis)#no spf-interval
```

## 14.5 Border Gateway Protocol (BGP)

Border Gateway Protocol (BGP) exchanges routing information among neighboring routers in different Autonomous Systems (AS). Arista switches use BGP version 4+, incorporating the multiprotocol extensions defined by RFC 4760 so that BGP can carry both IPv4 and IPv6 routes simultaneously over a single BGP peering.

This section contains the following topics:



- [BGP Conceptual Overview](#)
- [Configuring BGP](#)
- [BGP Examples](#)
- [BGP Commands](#)

Arista switches support these BGP functions:

- A single BGP instance.
- Simultaneous internal (iBGP) and external (eBGP) peering.
- Multiprotocol BGP.
- BGP Confederations.
- BGP Selective Route Download.
- BGP Route Reflection.

### 14.5.1 BGP Conceptual Overview

BGP is a protocol that exchanges routing information among neighboring routers in different autonomous systems through TCP sessions.

BGP neighbors (peers) communicate through a TCP session on port 179. They are established by manual configuration commands (static peers) or by creating a peer group listen range and accepting incoming peering requests in that range (dynamic peers). Internal BGP (iBGP) peers operate within a single autonomous system (AS). External BGP (eBGP) peers operate between autonomous systems. Border routers are on AS boundaries and exchange information with other autonomous systems; the primary function of border routers is distributing routes. Internal routers do not distribute route updates that they receive.

BGP defines a state machine for establishing connections. BGP routers maintain a state variable for each peer-to-peer session to track connection status. The state machine consists of these states:

- **Idle**: the router initializes BGP resources, refuses inbound BGP connection attempts, initiates a TCP connection to the peer, then transitions to the **Connect** state.
- **Connect**: the router waits for the TCP connection to complete, then sends an OPEN message to the peer and transitions to the **OpenSent** state if successful. If unsuccessful, it sets the **ConnectRetry** timer and transitions to the **Active** state upon expiry.
- **Active**: the router sets the **ConnectRetry** timer to zero and returns to the **Connect** state.
- **OpenSent**: the router waits for an OPEN message from the peer. After receiving a valid message, it transitions to the **OpenConfirm** state.
- **OpenConfirm**: the router waits for a keepalive message from its peer. If the message is received prior to a timeout expiry, the router transitions to the **Established** state. If the timeout expires or an error condition exists, the router transitions to the **Idle** state.
- **Established**: peers exchange UPDATE messages about routes they advertise. If an UPDATE message contains an error, the router sends a NOTIFICATION message and transitions to the **Idle** state.

During established BGP sessions, routers exchange UPDATE messages about the destinations to which they offer connectivity. The route description includes the destination prefix, prefix length, autonomous systems in the path, the next hop, and information that affects the acceptance policy of the receiving router. UPDATE messages also list destinations to which the router no longer offers connectivity.

BGP detects and eliminates routing loops while making routing policy decisions by using the network topology as defined by AS paths and path attributes.

---

### 14.5.1.1 Multiprotocol BGP

Multiprotocol BGP facilitates the advertisement of network routes and switch capabilities to neighbors from multiple address families over a single BGP peering. The switch supports IPv4 unicast and IPv6 unicast address families.

Neighbors negotiate to select an address family when establishing a connection. The peer session is based on this address family, which identifies the following:

- the set of network layer protocols to which the address carried in the Next Hop field must belong.
- the encoding format of the next-hop address.
- the semantics of Network Layer Reachability Information (NLRI).

### 14.5.1.2 BGP Confederations

BGP confederations divide an autonomous system (AS) into subsystems (sub-ASs), each identified by a unique sub-AS number, while still appearing externally as a single AS.

### 14.5.1.3 QoS Control of Neighbor Discovery and ARP Packets

To help prevent BGP sessions from being affected by dropped neighbor discovery and ARP packets, some Arista switches assign those packets to a higher priority output queue when they are being software forwarded. This helps minimize hardware drops from competition with data plane packets traffic congestion.

The switch platforms which use this feature are:

- DCS-7500E
- DCS-7250X
- DCS-7300X
- DCS-7010X
- DCS-7050X

### 14.5.1.4 Best-path Selection

Routing information received via the BGP protocol often contains more than one route to the same destination: the BGP best-path selection algorithm determines which of these routes will be installed in the routing table. Criteria are evaluated in order; at each step, if there is a tie for best path the next criterion is applied. If there is still a tie at the end of the process, BGP installs the route received from the peer with the lowest address. When equal cost multi path (ECMP) routing is enabled, multiple paths to a single destination may be installed in the IP routing table.

Route preferences can be shaped through configuration choices as described in [Configuring Best-path Selection](#). The steps in Arista's best-path selection process are described on the Arista website at <https://eos.arista.com/bgp-best-path/>.

### 14.5.1.5 BGP Convergence

BGP supports convergence where it waits for all peers to join and receive all the routes from other peers.

Before declaring convergence, BGP also waits for IGP protocols to converge so that all IBGP sessions are established, and routes that were learned over IBGP sessions, are resolved via the IGP routes. BGP declares convergence when it has received route updates from all its peers and EOR (End-Of-RIB) markers from all the expected peers and IGP protocols have converged. Using BGP convergence, you can avoid hardware updates or route advertisement churn during a switch reload or a BGP instance start.

### 14.5.1.6 BGP Communities

A BGP community is a group of subnet address prefixes that share a common identifying attribute. Communities simplify routing policies by consolidating IP network spaces into logical entities that BGP speakers can address to accept, prefer, and distribute routing information. BGP communities are defined by setting the community value within route maps. Community lists then reference one or more communities as follows:

- **Standard** community lists refer to communities by name or number.
- **Expanded** community lists reference communities using regular expressions.

### 14.5.1.7 BGP Graceful Shutdown Community

Autonomous System Boundary Routers (ASBRs) do not update all paths received from external BGP sessions and routers. They hide inefficient alternate paths and update only best paths in the routing table. BGP route policies are applied to all internal BGP sessions of ASBRs that support the graceful shutdown procedure.

As a part of maintenance mode, these route policies perform the following functionalities on routing advertisements:

- Match the graceful shutdown community with route map rules.
- Set the local preference attribute value of the paths that are tagged with the graceful shutdown community as zero.

Refer to [Maintenance Mode](#) for detailed information on maintenance mode.

### 14.5.1.8 BGP Labeled-Unicast (LU) path Nexthop resolution over Tunnel RIB Entries

BGP Labeled-Unicast protocol (BGP LU) path next-hop is enhanced to allow BGP in “ribd” mode to support resolution of BGP LU path next-hop over entries in the Tunnel RIB and fall-back to resolving over connected route when there is no entry in Tunnel RIB that provides a direct match for the BGP LU path next-hop. Previously, BGP in “ribd” mode allowed resolution of BGP Labeled-Unicast protocol (BGP LU) path next-hop over only connected routes, resolution of the next-hop over IGP or static routes was not allowed since the next-hop router may not be in the MPLS forwarding path in which case the traffic will get dropped by the next-hop router (per IGP).

The following two use cases explain how BGP LU path next-hop resolution over tunnels would help in achieving desired or efficient traffic forwarding.

- [Egress Peer Engineering \(EPE\)](#)
- [Inter-AS Option C](#)

#### Egress Peer Engineering (EPE)

Egress Peer Engineering is a source-routing paradigm that provides ability to select an egress node/interface through which traffic goes out of an Autonomous System (AS). As shown in Figure 1 below R1, R2, ASBR1 & ASBR2 are in AS 1 and E1, E2, E3 & E4 are in different Ases. R1, R2, ASBR1 & ASBR2 could be connected each other directly or reachable to each other over an IGP (OSPF/ISIS) or MPLS tunnel. Let’s assume reachability of loop-back addresses 1.1.1.1, 2.2.2.2, 3.3.3.3 & 4.4.4.4 through LDP or Segment Routing (SR). There exists an iBGP Full Mesh between R1, R2, ASBR1 & ASBR2. eBGP session is present between ASBR1 & E1, ASBR1 & E2, ASBR2 & E3 and ASBR2 & E4. Consider following BGP updates are received on ASBR1:

Prefix 50.0.0.0/8 next-hop 10.0.0.2 as-path 2 100 from E1

Prefix 50.0.0.0/8 next-hop 11.0.0.2 as-path 3 200 300 from E2

BGP path from E1 will be selected as best path due to shorter AS path length. ASBR1 advertises this prefix to both R1 & R2. Any traffic destined to prefix 50.0.0.0/8 from R1 will always be tunneled to ASBR1 and then it will always be sent on an interface connected to E1. Traditional Destination based

routing enforced by BGP policy and best path selection on the ASBRs may route traffic to a single AS as exit when a case can be made that for some prefixes an exit via some other AS may be preferable. BGP LU can be used here to perform traffic engineering or selecting Egress peer through which traffic should be forwarded.

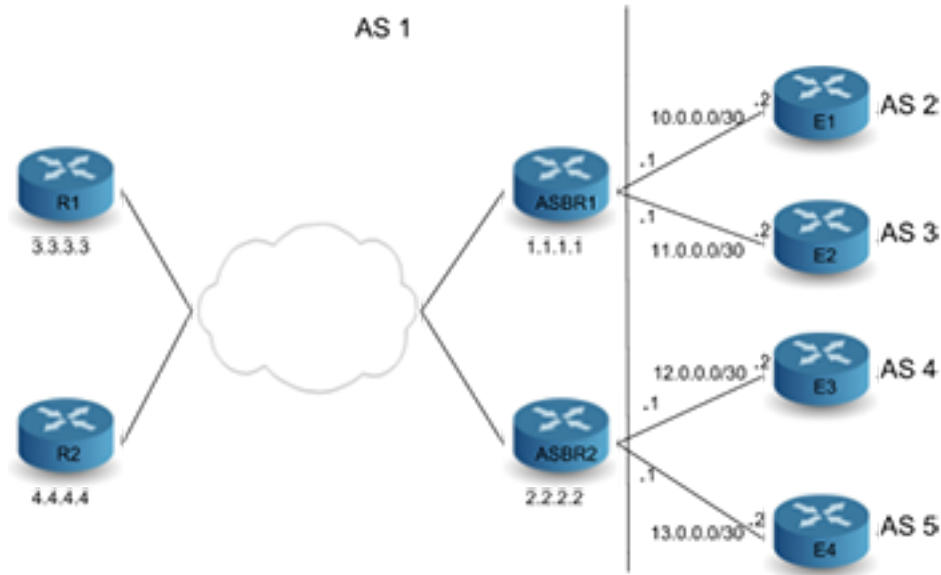

A Centralized EPE Controller can be used to establish iBGP session with R1 & R2. Let's assume Controller advertises BGP LU routes for E2, i.e., 11.0.0.2/32, with next-hop set to loop-back IP address of ASBR1, that is, 1.1.1.1 and a label 111 to R1 & R2.

```
switch#show ip bgp 11.0.0.2/32
BGP routing table information for VRF default
Router identifier 3.3.3.3, local AS number 1
BGP routing table entry for 11.0.0.2/32
Paths: 1 available
 Local
 1.1.1.1 labels [111] from 100.100.100.1 (100.100.100.1)
 Origin IGP, metric 0, localpref 100, IGP metric 40, weight 0,
 received
21:07:07 ago, valid, external, not installed
 Rx SAFI: Labels
 Tunnel RIB eligible
```

BGP LU path next-hop will get resolved over an ISIS SR tunnel present on R1 & R2 to reach 1.1.1.1, loop-back IP address of ASBR1.

```
switch#show tunnel rib brief
Endpoint Tunnel Type Index(es) Metric Metric2 Preference Preference2

1.1.1.1/32 IS-IS SR IPv4 5 40 0 115 0

switch#show bgp labeled-unicast tunnel
Index Endpoint Nexthop/Tunnel Index Interface Labels Contributing Metric

1 11.0.0.2/32 IS-IS SR IPv4 (5) - [111] Yes 0

Metric 2 Pref Pref 2

100 200 0

switch#show isis segment-routing tunnel
Index Endpoint Nexthop Interface Labels

5 1.1.1.1/32 6.6.6.6 Ethernet 5 [900001]
```

Controller or CLI can be used to install a static label route on ASBR1 such that ingress label 111 have a forwarding action of “POP and forward” to next-hop (11.0.0.2) in MPLS forwarding table.

```
switch#show mpls lfib route
MPLS forwarding table (Label [metric] Vias) - 20 routes
MPLS next-hop resolution allow default route: False
Via Type Codes:
 M - Mpls Via, P - Pseudowire Via,
 I - IP Lookup Via, V - Vlan Via,
 VA - EVPN Vlan Aware Via, ES - EVPN Ethernet Segment Via,
 VF - EVPN Vlan Flood Via, AF - EVPN Vlan Aware Flood Via,
 NG - Nexthop Group Via
Source Codes:
 S - Static MPLS Route, B2 - BGP L2 EVPN,
 B3 - BGP L3 VPN, R - RSVP,
 P - Pseudowire, L - LDP,
 IP - IS-IS SR Prefix Segment, IA - IS-IS SR Adjacency Segment,
 IL - IS-IS SR Segment to LDP, LI - LDP to IS-IS SR Segment,
 BL - BGP LU, ST - SR TE Policy,
 DE - Debug LFIB

S 111 [100]
 via M, 11.0.0.2, pop
 payload ipv4, apply egress-acl
 interface Ethernet 4
```

For prefixes to which traffic should be sent over interface connected E2 controller will advertise a BGP route with next-hop being BGP LU prefix and higher local-preference compared to paths advertised by ASBR1 & ASBR2, so that path received from controller will be preferred over paths coming from ASBR1 & ASBR2.

```
switch#show ip bgp 50.0.0.0/8
BGP routing table information for VRF default
Router identifier 3.3.3.3, local AS number 1
BGP routing table entry for 50.0.0.0/8
Paths: 3 available
 Local
 11.0.0.2 from 100.100.100.1 (100.100.100.1)
 Origin IGP, metric 0, localpref 200, IGP metric 0, weight 0,
 received 00:00:15
 ago, valid, internal, best
 Rx SAFI: Unicast
 2 100
 1.1.1.1 from 1.1.1.1 (1.1.1.1)
 Origin IGP, metric 0, localpref 100, IGP metric 0, weight 0,
 received 00:04:49
 ago, valid, internal
 Rx SAFI: Unicast
 2 200 300
 2.2.2.2 from 2.2.2.2 (2.2.2.2)
 Origin IGP, metric 0, localpref 100, IGP metric 0, weight 0,
 received 00:30:38
 ago, valid, internal
 Rx SAFI: Unicast
```

This results in pushing 2 labels on R1, top label is the label corresponding to ISIS SR tunnel to reach ASBR1 and bottom label is the label that corresponds to egress interface. Similarly LU route for 12.0.0.2 or 13.0.0.2 can be advertised from controller to select egress peer between E3 & E4. This approach provides Egress peer selection on an ingress router R1/R2.

```
switch#show ip route 50.0.0.0/8
```

```

VRF: default
Codes: C - connected, S - static, K - kernel,
 O - OSPF, IA - OSPF inter area, E1 - OSPF external type 1,
 E2 - OSPF external type 2, N1 - OSPF NSSA external type 1,
 N2 - OSPF NSSA external type2, B I - iBGP, B E - eBGP,
 R - RIP, I L1 - IS-IS level 1, I L2 - IS-IS level 2,
 O3 - OSPFv3, A B - BGP Aggregate, A O - OSPF Summary,
 NG - Nexthop Group Static Route, V - VXLAN Control Service,
 DH - DHCP client installed default route, M - Martian,
 DP - Dynamic Policy Route

B I 50.0.0.0/8 [200/0] via 11.0.0.2/32, BGP LU tunnel index 1
 via 6.6.6.6, Ethernet 5, label 900001 111

```

### Inter-AS Option C

Inter-AS Option C is an efficient and scalable MPLS IP VPN solution to provide connectivity between two sites of a customer connected to Provider Edge (PE) routers in different ASes. Following diagram shows a typical topology.

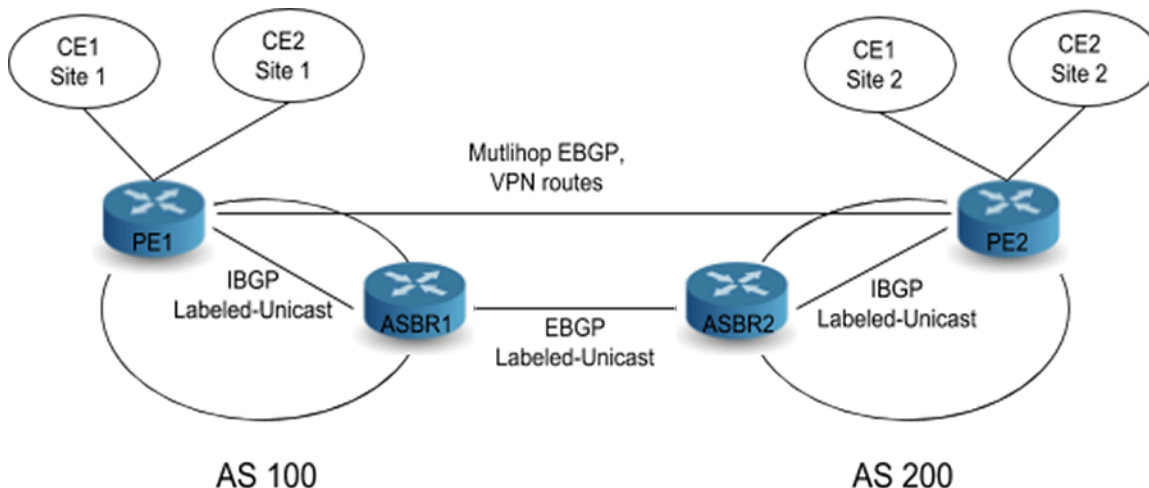

PE1 & ASBR1 and PE2 & ASBR2 distribute loop-back addresses using an IBGP Labeled Unicast (LU) session. ASBR2 advertises system addresses in AS200 to ASBR1 with next-hop as itself over EBGP LU session between them and installing Label swap entry of label sent to ASBR1 (L2) to label received from PE2 (L1) in MPLS forwarding table. ASBR1 further propagates system addresses in AS200 learned from ASBR2 into AS100 or to PE1 using IBGP LU session with next-hop as itself and installing Label swap entry with label advertised to PE1 (L3) to Label received from ASBR2 (L2) in MPLS forwarding table. Similarly ASBR1 sends system addresses in AS100 to ASBR2 over EBGP LU session, ASBR2 forwards them into AS200 or to PE2 using IBGP LU session with itself as next-hop and this would trigger installing appropriate label swap actions into MPLS forwarding table. These advertisements results in the creation of a label switched path from PE1 to PE2.

PE1 & PE2 exchange VPN routes between each other using a Multi hop EBGP session with next-hop being their own loop-back/system addresses. This method eliminates the requirement of storing or sending/receiving VPN routes at ASBR routers. When PE & ASBR routers are non-adjacent, but in the same AS, then LDP or ISIS-SR can be used as a transport label signaling protocol and this would need resolving BGP LU path next-hop over LDP or ISIS-SR tunnel. An IP packet destined to an address in CE1 site 2 is received on PE1 from CE1 site 1 PE1 would need to push 3 labels onto it. Bottom label corresponds to packet destination address in a particular VRF of CE1 site 2 advertised by PE2 to PE1 over Multi hop EBGP session, Middle label belongs to PE2 system address sent by ASBR1 and top label corresponding to ASBR1 system address assigned by transport label signaling protocol.

### 14.5.1.9 BGP Selective Route Download

BGP Selective Route Download allows the learning and advertising of BGP routes without installing them in hardware. The BGP routes are filtered before installation in hardware through the route map definition and routes that are filtered out are flagged as inactive in the RIB (Routing Information Base).

The route map used for filtering is applied only to BGP learned paths and not on locally originated routes, for example, BGP aggregate or redistributed routes. Also, because the BGP routes filtered by Selective Route Download are not active in the RIB, they are not used for recursive resolution, they are not redistributed into other protocols, and they do not contribute to BGP aggregates.

When BGP Selective Route Download is configured, the best path for peer advertisement is chosen based on the following aspects. If received BGP paths exist, then the best of them is advertised to BGP peers, else, the aggregate is preferred if configured and active. If neither BGP paths nor a BGP aggregate is available, then the RIB winner is advertised.



**Note:** The number of routes is limited based on the compute and memory resources available at runtime.

### 14.5.1.10 BGP Route Reflector

A BGP route reflector is a switch within an autonomous system that forwards route information learned from iBGP peers to other iBGP peers as an alternative to a full-mesh topology. When the switch is configured as a route reflector it can also be configured to preserve the BGP attributes of the reflected routes (next-hop, local preference, and metric) in its route advertisements regardless of outbound BGP policies.

### 14.5.1.11 BGP Nexthop Resolution RIBs: EVPN and IPV4/6 Labeled-Unicast Support

Adds the BGP Nexthop Resolution RIBs feature for EVPN and labeled-unicast address families.

BGP Nexthop Resolution RIBs: EVPN and IPV4/6 Labeled-Unicast Support adds support for user-configured BGP Nexthop Resolution RIB profiles for various BGP-based services such as IP unicast, L3 VPN, EVPN, etcetra. This feature allows an administrator to customize the next hop resolution semantics of BGP routes with an ordered list, or profile, of resolution RIB domains (for example, either tunnel or IP domain). This allows EOS to direct specific services over the specified RIB domains, overriding the default behavior. Further, this feature, through the use of user-defined tunnel RIBs, empowers an administrator to further select a subset of tunneling protocols for specific services.



**Note:** This feature is only available when running the multi-agent routing protocol model.

#### 14.5.1.11.1 Platform Compatibility

All platforms support this feature.

#### 14.5.1.11.2 Limitations

##### Resolution of NLRI from (directly connected) eBGP Speakers

For IPv4 or IPv6 unicast NLRI received from eBGP, directly connected BGP sessions are resolved by only using connected routes, or **system-connected**, in the parlance of this feature. This feature does not change this behavior, nor will configuration of a non-default resolution profile affect this behavior.

##### Address Family Profile Restrictions

Certain BGP address families only support a subset of possible next-hop resolution profiles. This section documents such limitations.

| Address family | Restriction |
|----------------|-------------|
|----------------|-------------|

|                                             |                                                     |
|---------------------------------------------|-----------------------------------------------------|
| IPv4/IPv6 unicast (non 6PE)                 | None.                                               |
| IPv6 unicast 6PE                            | Only supports tunnel domains*.                      |
| IPv4/IPv6 unicast (eBGP directly connected) | Only supports system-connected; Not configurable.   |
| IPv4/IPv6 VPN                               | Only supports tunnel domains* and system-connected. |
| IPv4/IPv6 LU                                | Only supports tunnel domains* and system-connected. |
| EVPN (MPLS)                                 | Only supports tunnel domains* and system-connected. |
| EVPN (VXLAN)                                | Only supports IP domains+.                          |

\* Tunnel domains refer to tunnel RIBs, e.g. system-colored-tunnel-rib, system-tunnel-rib, or user-defined tunnel RIBs.

+ IP domains are either of system-unicast-rib or system-connected.

#### 14.5.1.12 BGP Logical OR of Multiple Community Lists in the Same Match Command

In the multi-agent routing protocol model, the BGP agent now supports matching community lists with a logical OR via the route map `match community or-results` command (same applies for extended and large communities with `match extcommunity` and `match large-community`).

Without the `or-results` portion of the command, the default is to compute the logical AND of all provided community lists. Before, one would need to merge existing community lists into one to do a logical OR:

Issue:

```
ip community-list COMMLIST1 permit 1:1
ip community-list COMMLIST2 permit 2:2

! No way to match "COMMLIST1" or "COMMLIST2" in a single
! route-map sequence
match community COMMLIST1 COMMLIST2
```

Workaround:

```
ip community-list standard mergedCommunityList permit 1:1
ip community-list standard mergedCommunityList permit 2:2

match community mergedCommunityList
```

##### 14.5.1.12.1 Platform Compatibility

This feature is platform-independent.

##### 14.5.1.12.2 Limitations

This feature is available only when configuring BGP in the multi-agent routing protocol model.

##### 14.5.1.13 BGP Flowspec

The **EOS Release 4.21.3F** introduces support for BGP Flowspec, as defined in **RFC5575** and **RFC7674**. The typical use case is to filter or redirect DDoS traffic on edge routers.



BGP Flowspec rules are disseminated using a new BGP address family. The rules include both matching criteria used to match traffic, and actions to perform on the matching traffic. The rules are programmed into TCAM resources and applied on the ingress ports for which flowspec is enabled.

#### 14.5.1.13.1 Release Updates

##### **EOS Release 4.x (olso-rel) enhancements:**

- Added support for BGP Flowspec applied to SVI.
- BGP Flowspec releases TCAM banks as they are no longer needed to store matches. Previously, once TCAM banks allocated to BGP Flowspec, they never released.

##### **EOS Release 4.22.0 Enhancements:**

- Added support for redirect over MPLS or GRE Tunnels.
- Added support for traffic-rate action.

##### **EOS Release 4.22.1 Enhancements:**

Added support for hitless rule updates. This enhancement ensures that persistent filtering rules are always active while other filtering rules are updated (example: rules are published or withdrawn by a BGP peer).

##### **EOS Release 4.23.1 Enhancements:**

- Added support for best-effort rule programming. When a switch receives more filtering rules from its BGP neighbors than can fit within TCAM hardware, it programs the highest priority Flowspec rules up to the maximum TCAM available on a per-ASIC basis. The maximum TCAM available could either be the per-ASIC maximum free TCAM banks or the limit set by **feature flow-spec bank maximum tcam** in the hardware sub-configuration. (**LIMITATION** - the best-effort rule programming does not apply when Flowspec rules, after expansion into HW TCAM entries, occupy more than 24k 160b IPv4 or 320b IPv6 HW TCAM entries. In this case, programming fails, and no flowspec rules are programmed in hardware. This limitation is resolved in **EOS Release 4.24.2**).
- Added support for traffic-marking action. To enable traffic-marking action, the **feature flow-spec port (ipv4|ipv6)** command of the active TCAM profile must include action set-dscp.
- Added support for packet length (Type 10) component match on IPv4 packets. To enable matching on IPv4 packet length, the **feature flow-spec port ipv4** command of the active TCAM profile must include keyword **field ip-length**.

##### **EOS Release 4.23.2 Enhancements:**

- Added support for configuring BGP Flowspec in a non-default VRF. Only a single VRF is supported.
- Added support for packet length (Type 10) component match on IPv6 packets. To enable matching on IPv6 packet length, the **feature flow-spec port ipv6** command of the active TCAM profile must include the keyword **field ipv6-length**.

##### **EOS Release 4.24.0 Enhancements:**

Added support for configuring BGP Flowspec on subinterfaces. To enable subinterface support, the TCAM profile of the flow-spec feature must include **port qualifier size 3 bits** (see Flowspec TCAM Profile and Flowspec Policer TCAM Profile below).

##### **EOS Release 4.24.1 Enhancements:**

- Added support for BGP Flowspec in the DCS-7500R3 and DCS-7280R3 series.
- Added support for configuring BGP Flowspec in multiple VRFs.

---

### **EOS Release 4.24.2 Enhancements:**

Removed **EOS Release 4.23.1** limitation to best effort programming.

### **EOS Release 4.25.2 Enhancements:**

- Added support for BGP Flowspec applied to SVI.
- BGP Flowspec will release TCAM banks they are no longer needed to store matches. Previously, once TCAM banks were allocated to BGP Flowspec, they would never be released.

#### **14.5.1.13.2 Platform Compatibility**

The following platforms support BGP Flowspec:

- DCS-7500R
- DCS-7500R2
- DCS-7500R3
- DCS-7280R
- DCS-7280R2
- DCS-7280R3

 **Note:** This feature is only available when running the multi-agent routing protocol model.

#### **14.5.1.13.3 Limitations**

Flowspec functionality:

- The following actions are supported:
  - Drop
  - Redirect to a VRF
  - Redirect to a nexthop (both <https://tools.ietf.org/html/draft-simpson-idr-flowspec-redirect-02> and <https://tools.ietf.org/html/draft-ietf-idr-flowspec-redirect-ip-02> are supported).
  - Redirect to an IPv6 nexthop (<https://tools.ietf.org/html/draft-ietf-idr-flowspec-redirect-ip-02>) is supported only in EOS-4.22.0 or later.
  - Policer (**EOS Release 4.22.0** or later)
  - Traffic-marking (**EOS Release 4.23.1** or later)

To redirect to a nexthop, IP RIB must have a route to resolve the specified nexthop. When redirecting to a VRF, a default route for the VRF must be configured and traffic is sent to the nexthop for the default route in this VRF.

- Prior to version **EOS Release 4.22.0**, to redirect to a nexthop or VRF, the resolving route cannot be via MPLS VPN or GRE tunnel, so the resolving route must have regular IP nexthop(s) for the redirect action. This limitation was removed in **EOS Release 4.22.0**, except for the IPv6 GRE tunnels support for redirect action.
- All matching components described in **RFC 5575** are supported, except for the following known caveats:
  - For TCP flags, the ECE, CWR, and NS flags are not supported.
  - For fragment flags, only the **Is a fragment (IsF)** bit is supported only for IPv4 packets. Combining source and destination ports and the Fragment flags in the same rule is not supported.
- When flowspec policer is supported, the flowspec counter feature is disabled due to a hardware limitation.
- Beginning with **EOS Release 4.23.2**, the flowspec address family can be configured in a non-default VRF. However, only a single VRF (default or non-default) may be used on **EOS Release 4.24.0** or earlier versions.

- The additional BGP NLRI type (AFI=1, SAFI=134) which can be used to propagate traffic filtering information in a BGP/MPLS VPN environment is not supported.
- The validation procedure described in **RFC 5575** is not supported. Any received flowspec rules are considered valid.

BGP limitations:

- ECMP of flowspec rules are not supported. If the same rule is received from two peers and ECMP is configured, only the actions received from the ECMP head are applied.
- BGP Graceful Restart is not supported.
- Policies applied on the flowspec NLRI are not supported. This means that prefix-list matching rules in a route-map will not match against flowspec rules.
- BGP Additional Paths Send functionality is not supported.

Platform limitations:

- Flowspec rules can only be applied to traffic received on **routed Ethernet and Port-Channel** interfaces in the initial release. L3 subinterfaces are supported starting from **EOS Release 4.24.0**. SVIs are supported starting from EOS-4.25.2. L2 interfaces are not supported.
- Counters can either be reported for Flowspec or ACLs, but not both.
- With **EOS Release 4.24.1** and earlier versions, if the number of flow-spec rules exceed the available hardware TCAM resources, all rules are removed and a message is logged.
- When reinstalling the entire set of Flowspec rules, all existing rules are removed from the hardware upon installation.

Scaling limits:

- Similar to other TCAM features, the number of rules (BGP NLRI) that are supported in flowspec depend on the match criteria of each rule. Assuming that Flowspec is the only TCAM feature enabled on the switch, it attempts to use all of the TCAM space available (24K entries per chip) in the forwarding chip. Simple flowspec IPv4 rules will map to one entry, allowing a max of 24K rules. Simple IPv6 rules each take two entries, resulting in a max of 12K rules.
- Some types of rules expand into multiple entries in the TCAM. Port ranges are a common example. Combining source and destination port ranges in a single rule multiplies the number of entries needed to cover all combinations, which can quickly consume all of the TCAM space.
- The Flowspec and Flowspec Policer TCAM profiles support configuring the feature on up to seven VRFs starting with **EOS Release 4.24.1**. This scale can be adjusted with the number of bits in the feature's port qualifier size at the expense of removing other TCAM key fields.
- Make-before-break policer allocation affects scaling limits.

#### 14.5.1.14 Ordered Next Hops in FEC

In symmetric network topology, for the same ECMP (Equal Cost Multi-Path) route programmed at different devices in a switch layer, the various devices can program ECMP next-hops in the FEC (Forwarding Equivalence Class) for that route in varying orders. This could result in inconsistent hashing of traffic for those destination routes at the same layer of switches in the network and could be undesired behavior for certain classes of applications. Ordered FEC is an approach to order the next hops in the FEC of a route based on a network-wide device identifier for each next-hop resulting in consistent ordering of next hops in the FEC for a route across all switches in a layer.

A BGP router-id can be used as a unique network-wide device identifier and BGP paths received from various peers for a BGP ECMP route can have their paths and subsequently, next-hops sorted based on the corresponding peer's router-id. Ordered Next Hops in the FEC feature would use the BGP router-id to achieve a consistent ordering of next hops in the FEC for a route. This feature is available with multi-agent routing protocol models.

#### Platform Compatibility

- DCS-7010, DCS-7150, DCS-7050, DCS-7060, DCS-7250, DCS-7260 series

- DCS-7300, DCS-7320, DCS-7368 series
- CCS-720 series
- DCS-7020, DCS-7280, DCS-7500, DCS-7800 series

#### 14.5.1.14.1 Configuring Ordered Next Hops in FEC

Use the following configuration commands to implement Ordered FEC solution for BGP routes.

- The BGP instance must be configured to order ECMP paths received for a BGP route deterministically using `bgp bestpath tie-break router-id` under **router bgp** configuration mode.

```
switch(config)#router bgp 100
switch(config-router-bgp)#address-family ipv4
switch(config-router-bgp)#bgp bestpath tie-break router-id
switch(config-router-bgp)#
```

 **Note:** Other tie-break options available under **router bgp** configuration mode is not supported for Ordered Next Hops in FEC solution.

- The device must be configured to enforce ordering of next hops as determined by the protocol agents in the FEC programmed for the route using the `rib fib fec ecmp ordered` command under 'router general' configuration mode.

```
switch(config)#router general
switch(config-router-general)#rib fib fec ecmp ordered
switch(config-router-general)#
```

#### 14.5.1.14.2 Ordered FEC Show Commands

The `show ip route <prefix> fec` command displays if the next-hops in the FEC of a route have been ordered. The output below indicate the show command output before enabling the Ordered FEC solution on the device, and after enabling it. The `show ip bgp <prefix>` command output is also included to correlate next hop with corresponding router-id of the peer that the path was received from.

##### Example

```
switch#show ip bgp 1.0.16.0
BGP routing table information for VRF default
Router identifier 0.0.0.1, local AS number 1
BGP routing table entry for 1.0.16.0/24
 Paths: 8 available
 30
 1.0.10.2 from 1.0.10.2 (10.0.1.1)
 Origin EGP, metric 0, localpref 100, IGP metric 1, weight 0,
 received 00:01:53 ago, valid, external, ECMP head, ECMP, best, ECMP
 contributor
 Rx SAFI: Unicast
 10
 1.0.8.2 from 1.0.8.2 (10.0.4.1)
 Origin EGP, metric 0, localpref 100, IGP metric 1, weight 0,
 received 00:01:55 ago, valid, external, ECMP, ECMP contributor
 Rx SAFI: Unicast
 20
 1.0.9.2 from 1.0.9.2 (10.0.3.1)
 Origin EGP, metric 0, localpref 100, IGP metric 1, weight 0,
 received 00:01:54 ago, valid, external, ECMP, ECMP contributor
 Rx SAFI: Unicast
 40
 1.0.11.2 from 1.0.11.2 (10.0.8.1)
```

```

 Origin EGP, metric 0, localpref 100, IGP metric 1, weight 0,
 received 00:01:52 ago, valid, external, ECMP, ECMP contributor
 Rx SAFI: Unicast
50
 1.0.12.2 from 1.0.12.2 (10.0.2.1)
 Origin EGP, metric 0, localpref 100, IGP metric 1, weight 0,
 received 00:01:52 ago, valid, external, ECMP, ECMP contributor
 Rx SAFI: Unicast
60
 1.0.13.2 from 1.0.13.2 (10.0.5.1)
 Origin EGP, metric 0, localpref 100, IGP metric 1, weight 0,
 received 00:01:51 ago, valid, external, ECMP, ECMP contributor
 Rx SAFI: Unicast
70
 1.0.14.2 from 1.0.14.2 (10.0.6.1)
 Origin EGP, metric 0, localpref 100, IGP metric 1, weight 0,
 received 00:01:50 ago, valid, external, ECMP, ECMP contributor
 Rx SAFI: Unicast
80
 1.0.15.2 from 1.0.15.2 (10.0.7.1)
 Origin EGP, metric 0, localpref 100, IGP metric 1, weight 0,
 received 00:01:49 ago, valid, external, ECMP, ECMP contributor
 Rx SAFI: Unicast
switch#
switch#show ip ro 1.0.16.0 fec
FEC ID 4294967334, used by 100 IPv4 prefixes and 0 IPv6 prefixes
Next hops:
 via 1.0.8.2, Ethernet8
 via 1.0.9.2, Ethernet9
 via 1.0.10.2, Vlan2317
 via 1.0.11.2, Vlan2836
 via 1.0.12.2, Vlan2043
 via 1.0.13.2, Ethernet4
 via 1.0.14.2, Vlan2000
 via 1.0.15.2, Vlan2191
switch#
switch(config)#router general
switch(config-router-general)#rib fib fec ecmp ordered
switch(config-router-general)#end
switch#show ip route 1.0.16.0 fec
FEC ID 4294967334, used by 100 IPv4 prefixes and 0 IPv6 prefixes
Next hops (ordered):
 via 1.0.10.2, Vlan2317
 via 1.0.12.2, Vlan2043
 via 1.0.9.2, Ethernet9
 via 1.0.8.2, Ethernet8
 via 1.0.13.2, Ethernet4
 via 1.0.14.2, Vlan2000
 via 1.0.15.2, Vlan2191
 via 1.0.11.2, Vlan2836

```

#### 14.5.1.14.3 Troubleshooting

All relevant .qt files should be captured along with the output of **show tech support** and **show tech ribd** and provided to TAC for analysis by engineering. The following qts are useful in debugging:

AleAdj\*.qt, AleL2Adj\*.qt, AleL2AdjFlatteningHelper.qt, IpRib.qt, Ira.qt Bgp\*.qt

For analysing on a per prefix basis, please capture the following outputs to correlate prefix FIB state with platform programming state.

Run the **show ip route <px> fec** command to fetch the state of the route's FEC in the platform agent where the ordering of the next hops. This command should show the route's FEC ID.

```
switch#show ip route 1.0.16.0 fec
FEC ID 4294967348, used by 100 IPv4 prefixes and 0 IPv6 prefixes
Next hops (ordered):
 via 1.0.13.2, Vlan2478
 via 1.0.11.2, Ethernet23/1
 via 1.0.12.2, Ethernet37/1
 via 1.0.14.2, Ethernet42/1
 via 1.0.15.2, Vlan2787
 via 1.0.10.2, Ethernet15/1
 via 1.0.8.2, Vlan2277
 via 1.0.9.2, Vlan2228
```

Run the **show ip hardware ale adj <FECID>** command using the FEC ID obtained in the previous command. This should show the ordering of the next hops for this FEC and the corresponding I2-adj ID.

```
switch#show ip hardware ale adj 4294967348
Code: * - transient adj, # - ordered next-hops, P - proxy adj

 FecId FecType L2Adj Weight
 Prefixes TotalRefs Next Hop L3Intf

4294967348 forwardRoute 61 100
 100 1.0.13.2 1
 Vlan2478
 1.0.11.2 1
 Ethernet23/1
 1.0.12.2 1
 Ethernet37/1
 1.0.14.2 1
 Ethernet42/1
 1.0.15.2 1
 Vlan2787
 1.0.10.2 1
 Ethernet15/1
 1.0.8.2 1
 Vlan2277
 1.0.9.2 1
 Vlan2228
```

Fetch the platform FEC ID from **show ip hardware ale l2-adj <l2adjid>** command with the I2-adj ID obtained in the previous command. This should show the platform FEC ID.

```
switch#show ip hardware ale l2-adj 61
L2Adj Id: 61, Adjs: 1, State: Installed, Plat. FEC: 1,
 Via nextHopArpResolved, Weight: 1,
 MAC Address: 4695.3cff.0874,
 L3Intf: Ethernet15/1,
 L2Intf: Ethernet15/1
```

```

Via nextHopArpResolved, Weight: 1,
 MAC Address: d247.1f88.855b,
 L3Intf: Vlan2478
Via nextHopArpResolved, Weight: 1,
 MAC Address: 86b7.a678.887f,
 L3Intf: Vlan2787
Via nextHopArpResolved, Weight: 1,
 MAC Address: 5e0a.2d76.ba07,
 L3Intf: Vlan2228
Via nextHopArpResolved, Weight: 1,
 MAC Address: 3e57.0458.b9da,
 L3Intf: Ethernet42/1,
 L2Intf: Ethernet42/1
Via nextHopArpResolved, Weight: 1,
 MAC Address: ce5b.b9dd.0206,
 L3Intf: Vlan2277
Via nextHopArpResolved, Weight: 1,
 MAC Address: 961a.e9c9.6430,
 L3Intf: Ethernet23/1,
 L2Intf: Ethernet23/1
Via nextHopArpResolved, Weight: 1,
 MAC Address: 56f1.5201.efd7,
 L3Intf: Ethernet37/1,
 L2Intf: Ethernet37/1

```

Use the platform FEC ID in a platform show command to get the ordered list of egress interfaces in the FEC for that route programmed in the hardware.

```

switch#show platform fap fec 1
Tunnel Type: Mpop(mpls pop), Mpush(mpls push), Mswap(mpls swap),
 MoG(mpls-over-gre), T(IPv4 tunnels GRE/VXLAN)
CW - Control word
FL - Flow label
D - ECMP is divergent across switching chips

| FEC Entry
ECMP
Tunnel
Index
T Value

1
1
1
1
1
1
1

```

```
| 1 | 32786 | ROUTE | L3FloodFap1.0 | 2228 | 9 | 5e:0a:2d:76:ba:07
| -
```

#### 14.5.1.14.4 Limitations

- Ordered FEC is supported only for IPv4 and IPv6 BGP ECMP routes received with directly connected next hops.

## 14.5.2 Configuring BGP

These sections describe basic BGP configuration steps:

- [Configuring BGP Instances](#)
- [Configuring BGP Neighbors](#)
- [Configuring GTSM for BGP](#)
- [Configuring Routes](#)
- [Configuring Address Families](#)
- [Configuring Best-path Selection](#)
- [Configuring BGP Convergence](#)
- [Configuring BGP Graceful Shutdown Community](#)
- [Configuring BGP Selective Route Download](#)
- [Configuring Nexthop Resolution](#)
- [Configuring BGP Confederations](#)
- [Configuring BGP Flowspec](#)
- [Configuring BGP Logical OR of Multiple Community Lists](#)
- [BGP Operational Commands](#)

### 14.5.2.1 Configuring BGP Instances

#### 14.5.2.1.1 Creating an Instance and Entering BGP Configuration Mode

The switch supports one BGP instance, which is associated with a specified autonomous system (AS). To other BGP peers, the AS number uniquely identifies the network to which the switch belongs. Arista switches support four-byte AS numbers as described in RFC 4893. Four-byte AS number capability is communicated to BGP peers in OPEN messages. When communicating with a BGP peer which does not support four-byte AS numbers, the switch will replace AS numbers greater than 65535 with the well-known two-byte AS number 23456 (also called AS\_TRANS), and encode the actual four-byte AS numbers using the AS4\_PATH attribute.

The switch must be in router-BGP configuration mode to run BGP configuration commands. The `router bgp` command places the switch in router-BGP configuration mode for creating a BGP instance if one was not previously created. BGP configuration commands apply globally to the BGP instance.

#### Example

- This command places the switch in router-BGP configuration mode. It also creates a BGP instance in AS 50 if an instance was not previously created.

```
switch(config)#router bgp 50
switch(config-router-bgp)#
```

When a BGP instance exists, the `router bgp` command must include its autonomous system. Any attempt to create a second instance results in an error message.



**Example**

- This command attempts to open a BGP instance with a different AS number from that of the existing instance. The switch displays an error and stays in global configuration mode.

```
switch(config)#router bgp 100
% BGP is already running with AS number 50
switch(config)#
```

**14.5.2.1.2 Configuring BGP in a VRF**

IPv6 VRF support in EOS allows application of a BGP configuration to a single VRF instance, overriding global commands. To apply VRF-specific BGP configuration, use the `vrf` command within router-BGP configuration mode to enter BGP VRF configuration mode. IPv6 BGP VRF configuration is performed in the VRF submode of the router-BGP configuration mode. This submode is also where a route distinguisher (RD) is configured for a VRF on switches running Ethernet VPN (EVPN): use the `rd` ([Router-BGP VRF and VNI Configuration Modes](#)) command to configure an RD for a VRF.

**Examples**

- These commands place the switch in BGP VRF configuration mode for VRF “purple.” Commands issued in this mode will override global BGP configuration for the specified VRF instance.

```
switch(config)#router bgp 1
switch(config-router-bgp)#vrf purple
switch(config-router-bgp)#
```

- These commands activate IPv6 address-family support for the IPv6 neighbor 2001:0DB8:8c01::1 in VRF “purple.”

```
switch(config-router-bgp-vrf-purple)#router-id 1.1.1.1
switch(config-router-bgp-vrf-purple)#neighbor 2001:0DB8:8c01::1 remote-
as 16
switch(config-router-bgp-vrf-purple)#address-family ipv6
switch(config-router-bgp-vrf-purple-af)#neighbor 2001:0DB8:8c01::1
activate
switch(config-router-bgp-vrf-purple-af)#
```

- This command configures a route distinguisher for VRF “purple.”

```
switch(config-router-bgp-vrf-purple)#rd 530:12
switch(config-router-bgp-vrf-purple)#
```

**14.5.2.2 Configuring BGP Neighbors****14.5.2.2.1 Establishing BGP Neighbors**

BGP neighbors, or peers, are established by configuration commands that initiate a TCP connection. BGP supports two types of neighbors:

- **Internal neighbors** are in the same autonomous system.
- **External neighbors** are in different autonomous systems.

BGP neighbors can be either static or dynamic:

- **Static neighbors** are established by manually configuring the connection.
- **Dynamic neighbors** are established by creating a listen range and accepting incoming connections from neighbors in that address range.

---

Static neighbors may belong to a static peer group, allowing them to be configured as a group. Configuration applied to an individual member of a static peer group overrides the group configuration for that peer. Dynamic neighbors must belong to a dynamic peer group, and can only be configured as a group.

### Static BGP Neighbors

The `neighbor remote-as` command connects the switch with a peer, establishing a static neighbor.

Once established, a static neighbor may be added to an existing peer group. Any configuration applied to the peer group then is inherited by the neighbor, unless a conflicting configuration has been entered for that peer. Settings applied to a member of the peer group override group settings.

 **Note:** To establish a BGP session, there must be an IPv4 router ID configured in the same VRF or at least one L3 interface with an IPv4 address in the same VRF. If the VRF contains no L3 interfaces with IPv4 addresses (for example, in an IPv6-only environment), configure an appropriate router ID using the `router-id (BGP)` command.

### Example

- These commands establish an internal BGP connection with the peer at 10.1.1.14.

```
switch(config)#router bgp 50
switch(config-router-bgp)#neighbor 10.1.1.14 remote-as 50
switch(config-router-bgp)#
```

- These commands establish an external BGP connection with the peer at 192.168.2.5.

```
switch(config)#router bgp 50
switch(config-router-bgp)#neighbor 192.168.2.5 remote-as 100
switch(config-router-bgp)#
```

### Dynamic BGP Neighbors

The `bgp listen range` command specifies a range of IPv4 addresses from which the switch will accept incoming dynamic BGP peering requests, and creates the named dynamic peer group to which those peers belong. Dynamic BGP neighbors are peers which have not been manually established, but are accepted into a dynamic peer group when the switch receives a peering request from them.

Dynamic peers cannot be configured individually, but inherit any configuration that is applied to the peer group to which they belong. Peering relationships with dynamic peers are terminated if the peer group is deleted.

### Example

- These commands create a peer group called “brazil” which accepts dynamic peering requests from the 192.168.2.0/24 subnet.

```
switch(config)#router bgp 50
switch(config-router-bgp)#bgp listen range 192.168.2.0/24 peer-group
brazil remote-as 50
switch(config-router-bgp)#
```

### Displaying Neighbor Connections

The `show ip bgp summary` and `show ip bgp neighbors` commands display neighbor connection status.

## Example

- This command indicates the connection state with the peer at 192.168.2.5 is **Estab** (established). The peer is an external neighbor because it is in AS 100 and the local server is in AS 50.e

```
switch#show ip bgp summary
BGP summary information for VRF default
BGP router identifier 192.168.104.2, local AS number 50
Neighbor Status Codes: m - Under maintenance
 Neighbor V AS MsgRcvd MsgSent InQ OutQ Up/Down State PfxRcd
 PfxAcc
 192.168.2.5 4 100 198 281 0 0 03:11:31 Estab 12
 12
switch#
```

## Static BGP Peer Groups

A static BGP peer group is a collection of BGP neighbors which can be configured as a group. Once a static peer group is created, the group name can be used as a parameter in neighbor configuration commands, and the configuration will be applied to all members of the group. Neighbors added to the group will inherit any settings already created for the group. Static peer group members may also be configured individually, and the settings of an individual neighbor in the peer group override group settings for that neighbor.

When the default form of a BGP configuration command is entered for a member of a static peer group, the peer inherits that configuration from the peer group.

A static peer group is created with the `neighbor peer group (create)` command, or by using the `bgp listen range` command to accept dynamic peering requests. Once a static peer group has been created, static neighbors can be manually added to the group by using the `neighbor peer group (neighbor assignment)` command. The `no neighbor peer group (neighbor assignment)` command removes a neighbor from a static peer group.

The `no neighbor peer group (create)` command will delete a static peer group. When a peer group is deleted, the members of that group revert to their individual configurations, or to the system default for any attributes that have not been specifically configured for that peer.

## Examples

- These commands create a peer group named “akron.”

```
switch(config)#router bgp 50
switch(config-router-bgp)#neighbor akron peer group
switch(config-router-bgp)#
```

- This command adds the neighbors at 1.1.1.1 and 2.2.2.2 to peer group “akron.”

```
switch(config-router-bgp)#neighbor 1.1.1.1 peer group akron
switch(config-router-bgp)#neighbor 2.2.2.2 peer group akron
switch(config-router-bgp)#
```

- These commands configure the members of peer group “akron,” but cause the neighbor at 1.1.1.1 to use the system default value for out-delay.

```
switch(config-router-bgp)#neighbor akron remote-as 109
switch(config-router-bgp)#neighbor akron out-delay 101
switch(config-router-bgp)#neighbor akron maximum-routes 12000
switch(config-router-bgp)#no neighbor 1.1.1.1 out-delay
switch(config-router-bgp)#
```

---

## Dynamic BGP Peer Groups

A dynamic BGP peer group is a collection of BGP neighbors in a specified address range which makes a peer request to the switch. Members of dynamic peer group are configured in groups and not as individuals. A dynamic peer group name is used as a parameter to apply the configuration across all the members in the group. Neighbors joining the group inherit any settings already created for the group.

The `bgp listen range` command is used to create a dynamic peer group. This command identifies the BGP peering request from a range of IP address, and names the dynamic peer group to which those peers belong to. The `bgp listen range` command can be configured to accept a peering request from a single AS number or to accept peer request from the range of AS numbers. To accept the request from the range of AS numbers use the peer filter option in the command as shown. If the peer filter referred by the `bgp listen range` command does not exist, or if the filter exists but has no match commands, it will accept any AS number.

 **Note:** When a listen range command is modified, any existing dynamic neighbor that is already established will get reset.

To delete a dynamic peer group, use the no or default form of the `bgp listen range` command. All peering relationships with group members are terminated when the dynamic peer group is deleted.

### Example

- These commands create a dynamic peer group called “brazil” in a single AS, which accepts peering requests from the 192.0.2.0/24 subnet the single AS is 5.

```
switch(config)#router bgp 1
switch(config-router-bgp)#bgp listen range 192.0.2.0/24 peer-group
brazil
remote-as 5
switch(config-router-bgp)#
```

- These commands create a dynamic peer group called “brazil” in a range of ASNs, which accepts peering requests from the 192.0.2.0/24 subnet. The range of AS numbers is defined by peer filter option.

```
switch(config)#router bgp 1
switch(config-router-bgp)#bgp listen range 192.0.2.0/24 peer-group
brazil peer-filter group-1
switch(config-router-bgp)#
```

The `show ip bgp peer group` command displays the source of a listen range’s remote AS number definition as shown.

```
switch(config-router-bgp)#show ip bgp peer-group
BGP peer-group is brazil
BGP version 4
Listen-range subnets:
VRF default:
192.0.2.0/24, remote AS 5
192.0.2.0/24, peer filter group1
switch(config-router-bgp)#
```

#### 14.5.2.2.2 Peer Filter

A peer filter defines a set of rules to decide whether to accept or reject the incoming peer request based on the peer’s attributes. The peer filter is defined using a sequence number and a match statement, and supports one new match statement for matching against a range of BGP AS numbers.

A peer filter is defined in peer filter configuration mode as shown. The peer filter command supports only matching AS ranges. Unlike route maps, peer filters do not support sets, continues or subroutines.

To delete a peer filter, use the `no peer filter` or `default peer filter` commands.

### Example

- These commands define a peer filter that accepts any AS number.

```
switch(config)#peer-filter group1
switch(config-peer-filter-group1)#10 match as-range 1-4294967295 result
accept
switch(config-peer-filter-group1)#
```

- These commands define a peer filter that accepts any AS number between 65000 and 65100 (inclusive) except 65008 and 65009.

```
switch(config)#peer-filter group2
switch(config-peer-filter-group2)#10 match as-range 65008-65009 result
reject
switch(config-peer-filter-group2)#20 match as-range 65000-651000 result
accept
switch(config-peer-filter-group2)#
```

- These commands define a peer filter that accepts 3 specific remote AS numbers.

```
switch(config)#peer-filter group3
switch(config-peer-filter-group3)#10 match as-range 65003 result accept
switch(config-peer-filter-group3)#20 match as-range 65007 result accept
switch(config-peer-filter-group3)#30 match as-range 65009 result accept
switch(config-peer-filter-group3)#
```

The `show peer-filter` command displays the peer filter definition.

```
switch(config)#show ip bgp peer-group3
peer-filter group3
 10 match as-range 65003 result accept
 20 match as-range 65007 result accept
 30 match as-range 65009 result accept
switch(config)#
```

#### 14.5.2.2.3 Special Considerations for IPv6

BGP predates the use of IPv6, and BGP configuration assumes IPv4 connections by default. The following additional steps are used to configure IPv6 BGP neighbors.

-  **Note:** To establish a BGP session, there must be an IPv4 router ID configured in the same VRF or at least one L3 interface with an IPv4 address in the same VRF. If the VRF contains no L3 interfaces with IPv4 addresses (e.g., in an IPv6-only environment), configure an appropriate router ID using the `router-id (BGP)` command.

#### Activating IPv6 Neighbors

By default, the switch does not negotiate or advertise IPv6 BGP routes. In order to establish a session with an IPv6 neighbor, it must be made active in the IPv6 address family. The `ipv6-unicast` option of the `bgp default` command causes the switch to send IPv6 capability messages and all network advertisements with IPv6 prefixes to all BGP neighbors. The `neighbor activate` command issued in IPv6 address family configuration mode does the same for a single BGP neighbor.

---

## Examples

- These commands make all BGP neighbors active in the IPv6 address family.

```
switch(config)#router bgp 11
switch(config)#address-family ipv6
switch(config-router-bgp-af)#bgp default ipv6-unicast
switch(config-router-bgp-af)#exit
switch(config-router-bgp)#
```

- These commands make the BGP neighbor at 2001:0DB8:8c01::1 active in the IPv6 address family.

```
switch(config)#router bgp 11
switch(config)#address-family ipv6
switch(config-router-bgp-af)#neighbor 2001:0DB8:8c01::1 activate
switch(config-router-bgp-af)#exit
switch(config-router-bgp)#
```

## Sending IPv4 NLRIs over IPv6 Connections

The switch supports the exchange of IPv4 NLRIs with IPv6 neighbors. To enable this feature for all IPv6 neighbors, use the `ipv4-unicast transport ipv6` option of the `bgp default` command in IPv4 address family configuration mode. To enable it for a single IPv6 neighbor, use the `neighbor activate` command for that neighbor in IPv4 address family configuration mode.

To send IPv4 NLRIs to IPv6 neighbors, the IPv4 next-hop address must also be communicated. To explicitly configure an IPv4 next hop to send to a specific IPv6 neighbor, use the `neighbor local-v4-addr` command. In some network configurations, the switch can also be configured to automatically determine the best IPv4 next-hop address for an individual IPv6 neighbor or for all neighbors in the VRF using the `neighbor auto-local-addr` command.

## Examples

- These commands permit IPv4 NLRI transport over all IPv6 connections by making the IPv4 address family active on IPv6 BGP neighbors, then configure the switch to automatically select a local IPv4 address to be sent in NLRIs to the IPv6 neighbors in a peer group called "indianapolis."

```
switch(config)#router bgp 11
switch(config-router-bgp)#address-family ipv4
switch(config-router-bgp-af)#bgp default ipv4-unicast transport ipv6
switch(config-router-bgp-af)#exit
switch(config-router-bgp)#neighbor indianapolis auto-local-addr
switch(config-router-bgp)#
```

- These commands permit IPv4 NLRI transport with the IPv6 neighbor at 2001:0DB8:8c01::1 using a local IPv4 address of 10.7.5.11.

```
switch(config)#router bgp 11
switch(config-router-bgp)#address-family ipv4
switch(config-router-bgp-af)#neighbor 2001:0DB8:8c01::1 activate
switch(config-router-bgp-af)#exit
switch(config-router-bgp)#neighbor 2001:0DB8:8c01::1 local-v4-addr
10.7.5.11
switch(config-router-bgp)#
```

### 14.5.2.2.4 Maintaining Neighbor Connections

BGP neighbors maintain connections by exchanging KEEPALIVE, UPDATE, and NOTIFICATION messages. Neighbors that do not receive a message from a peer within a specified period (**hold time**)

close the BGP session with that peer. Hold time is typically three times the period between scheduled KEEPALIVE messages. The default keepalive period is 60 seconds; default hold time is 180 seconds.

The `timers bgp` command configures the hold time and keepalive period. A peer retains its BGP connections indefinitely when its hold time is zero.

### Example

- This command sets the keepalive period to 15 seconds and the hold time to 45 seconds.

```
switch(config-router-bgp)#timers bgp 15 45
switch(config-router-bgp)#
```

The `show ip bgp neighbors` command displays the hold time.

### Example

- This command indicates the BGP hold time is 45 seconds.

```
switch#show ip bgp neighbors 10.100.100.2
BGP neighbor is 10.100.100.2, remote AS 100
BGP version 4, remote router ID 192.168.100.13, VRF default
 Negotiated BGP version 4
 Last read 00:00:05, last write 00:00:05
 Hold time is 45, keepalive interval is 15 seconds <= hold
 time
 Configured hold time is 45, keepalive interval is 15 seconds
 Connect timer is inactive
 Idle-restart timer is inactive
 BGP state is Established, up for 04:44:05
 Number of transitions to established: 11
 Last state was OpenConfirm
 Last event was RecvKeepAlive
 Last sent notification:Cease/administrative reset, Last time 04:44:09
 Last rcvd notification:Cease/peer de-configured, Last time 2d02h,
 First time 7d08h, Repeats 1
 Neighbor Capabilities:
 Multiprotocol IPv4 Unicast: advertised and received and negotiated
 Four Octet ASN: advertised and received
 <-----OUTPUT OMITTED FROM EXAMPLE----->
switch#
```

## 14.5.2.2.5 Neighbor Route Configuration

### Maximum Routes

The `neighbor maximum-routes` command determines the number of BGP routes the switch accepts from a specified neighbor. The switch disables peering with the neighbor when this number is exceeded.

### Example

- This command configures the switch to accept 15,000 routes from the peer at 192.168.18.24.

```
switch(config-router-bgp)#neighbor 192.168.18.24 maximum-routes 15000
switch(config-router-bgp)#
```

---

## Route Reflection

Participating BGP routers within an AS communicate eBGP-learned routes to all of their peers; they do not re-advertise iBGP-learned routes within the AS to prevent routing loops. Although a fully meshed network topology ensures that all AS members share routing information, this topology can result in high volumes of iBGP messages when scaled. Alternatively, one or more routers can be configured as route reflectors in larger networks.

A route reflector re-advertises routes learned through iBGP to a group of BGP neighbors within the AS, replacing the function of a fully meshed topology. The `neighbor route-reflector-client` command configures the switch to act as a route reflector and configures the specified neighbor as a client. The `bgp client-to-client reflection` command enables client-to-client reflection.

**Cluster IDs** When using route reflectors, an AS is divided into clusters. A cluster contains at least one route reflector and a group of clients to which they re-advertise route information. A cluster may contain multiple route reflectors to provide redundancy protection. Each reflector has a cluster ID. When the cluster has a single route reflector, the cluster ID is its router ID. When a cluster has multiple route reflectors, a 4-byte cluster ID is assigned to all route reflectors in the cluster, allowing them to recognize updates from other cluster reflectors. The `bgp cluster-id` command configures the cluster ID in a cluster with multiple route reflectors.

**Attribute Preservation** Outbound BGP policies can rewrite the BGP attributes (next-hop, local preference and metric) of routes advertised by a route reflector. To configure the route reflector to preserve these attributes regardless of policy (unless those policies are included in a route map), use the `bgp route-reflector preserve-attributes` command. To include route attributes at all times (even contrary to policies included in route maps), use the `always` option of the command.

**Client-to-client Reflection** Usually the clients of a route reflector are not interconnected, and any routes learned by a client are mirrored to other clients and re-advertised within the AS by the route reflector. If the clients of a route reflector are fully meshed, routes received from a client do not need to be mirrored to other clients. In this case, client-to-client reflection should be disabled using the `no bgp client-to-client reflection` command.

## Examples

- These commands configure the switch as a route reflector and the neighbor at 172.72.14.5 as one of its clients, set the cluster ID to 172.22.30.101, and configure the reflector to preserve all BGP attributes of re-advertised routes.

```
switch(config-router-bgp) #neighbor 172.72.14.5 route-reflector-client
switch(config-router-bgp) #bgp cluster-id 172.22.30.101
switch(config-router-bgp) #bgp route-reflector preserve-attributes
switch(config-router-bgp) #
```

- This command displays the global BGP status for the default VRF, including route reflector configuration.



**Note:** The value of the “Attributes of reflected routes” can be **preserved** (reflected routes maintain attributes unless they are removed by an outbound BGP policy map), **always preserved** (reflected routes maintain BGP attributes regardless of all policies), or **not preserved** (reflected routes do not maintain their BGP attributes).

```
switch#show bgp instance
BGP instance information for VRF default
BGP Local AS: 64512, Router ID: 1.1.4.1
Total peers: 14
 Configured peers: 14
 UnConfigured peers: 0
 Disabled peers: 4
 Established peers: 9
Graceful restart helper mode enabled
```



**Attributes of reflected routes are preserved**

```

End of rib timer timeout: 00:05:00
BGP Convergence timer is inactive
BGP Convergence information:
 BGP has converged: yes, Time taken to converge: 00:05:44
 Outstanding EORs: 0, Outstanding Keepalives: 0
Convergence timeout: 00:10:00
switch#

```

**Route Preference**

The primary function of external peers is to distribute routes they learn from their peers. Internal peers receive route updates without distributing them. External peers receive route updates, then distribute them to internal and external peers.

**Local preference** is a metric that iBGP sessions use to select an external route. Preferred routes have the highest local preference value. UPDATE packets include this metric in the LOCAL\_PREF field.

The `neighbor export-localpref` command specifies the LOCAL\_PREF that the switch sends to an internal peer. The command overrides previously assigned preferences and has no effect on external peers.

**Example**

- This command configures the switch to enter 200 in the LOCAL\_PREF field of UPDATE packets it sends to the peer at 10.1.1.45.

```

switch(config-router-bgp)#neighbor 10.1.1.45 export-localpref 200
switch(config-router-bgp)#

```

The `neighbor import-localpref` command assigns a local preference to routes received through UPDATE packets from an external peer. This command has no effect when the neighbor is an internal peer.

**Example**

- This command configures the switch to assign the local preference of 50 for routes advertised from the peer at 172.16.5.2.

```

switch(config-router-bgp)#neighbor 172.16.5.2 import-localpref 50
switch(config-router-bgp)#

```

The `show ip bgp` command displays the LOCAL\_PREF value for all listed routes.

**Example**

- This command indicates the route to network 10.10.20.0/24 has a local preference of 400.

```

switch#show ip bgp
BGP routing table information for VRF default
Router identifier 192.168.100.23, local AS number 64512
Route status codes: s - suppressed, * - valid, > - active, # - not
installed, E - ECMP head, e - ECMP S - Stale, c - Contributing to
ECMP, b - backup, L - labeled-unicast
Origin codes: i - IGP, e - EGP, ? - incomplete
AS Path Attributes: Or-ID - Originator ID, C-LST - Cluster List, LL
Nexthop - Link Local Nexthop

 Network Next Hop Metric LocPref Weight Path

```

```
* >Ec 10.10.20.0/24 192.168.31.3 0 400 0
64521 i
switch#
```

## Graceful Restart

Graceful BGP restart allows a BGP speaker with separate control plane and data plane processing to continue forwarding traffic during a BGP restart. Its neighbors (receiving speakers) may retain routing information from the restarting speaker while a BGP session with it is being re-established, reducing route flapping.

Arista switches can act as helpers (receiving speakers) for graceful BGP restart with neighbors that advertise graceful restart capability.

Graceful restart helper mode is enabled by default, but can be turned off globally with the `no graceful-restart-helper` command. Per-peer configuration takes precedence over the global configuration.

## Examples

- This command disables graceful restart helper mode for all BGP peers.

```
switch(config-router-bgp) #no graceful-restart-helper
switch(config-router-bgp) #
```

- This command disables graceful restart helper mode for the neighbor at 192.168.32.5 regardless of global configuration.

```
switch(config-router-bgp) #no neighbor 192.168.32.5 graceful-restart-helper
switch(config-router-bgp) #
```

Peers with graceful restart capability advertise a restart time value as an estimate of the time it will take them to restart a BGP session. When a BGP session with a restarting speaker goes down, the switch (receiving speaker) marks routes from that peer as stale and starts the restart timer. If the session with the peer is not re-established before the restart time runs out, the switch deletes the stale routes from that peer. If the session is re-established within that time, the stale path timer is started. If the stale paths are not updated by the restarting speaker before the stale path time runs out, they are deleted. The maximum time these stale paths will be retained after the BGP session is re-established is 300 seconds by default, but can be configured using the `graceful-restart stalepath-time` command.

## Example

- This command configures BGP to discard stale paths from a restarting peer 500 seconds after the BGP session with that peer is re-established.

```
switch(config-router-bgp) #graceful-restart stalepath-time 500
switch(config-router-bgp) #
```

### 14.5.2.2.6 Filtering Routes

#### Filtering with Route Maps

Route maps are used in BGP to directly filter IPv4 unicast routes. The `neighbor route-map (BGP)` command applies a route map to inbound or outbound BGP routes. To display the route maps associated with a specific BGP neighbor, use the `show ip bgp neighbors` command.

## Filtering with BGP Communities

Community values are assigned to a set of subnet prefixes through route map `set` commands. Route map `match` commands subsequently use community values to filter routes. The switch uses the following `ip community-list` commands to filter community routes into a BGP domain:

- `ip community-list` creates a community list by explicitly referencing one or more communities by name or number.
- `ip community-list regexp` creates a community list by referencing one or more communities by regular expression.
- `ip extcommunity-list` creates an extended community list to identify routes for VRFs or for link bandwidth (LBW) by explicitly referencing extended communities by prefix and number.
- `ip extcommunity-list regexp` creates an extended community list to identify routes for VRFs or for link bandwidth (LBW) by regular expression.

The BGP community attribute is a 32 bit value formatted as follows:

- an integer between 0 and 4294967040.
- AA:NN, where AA is 65535 and NN specifies the community number (0-65535) within the AS.

These four community attribute values, and the associated BGP speaker actions, are predefined:

- **no-export**: speaker does not advertise the routes beyond the BGP domain.
- **no-advertise**: speaker does not advertise the routes to any BGP peers.
- **local-as**: speaker does not advertise route to any external peers.
- **internet**: speaker advertises the route to the Internet community. By default, this includes all prefixes.

### Example

- These commands assign two network subnets to a prefix list, assign a community number to the prefix list members, then utilize that community in an `ip community-list` command to permit the routes into the BGP domain.

1. Compose the IP prefix list.

```
switch(config)#ip prefix-list PL_1 permit 10.1.2.5/24
switch(config)#ip prefix-list PL_1 permit 10.2.5.1/28
switch(config)#
```

2. Create a route map that matches the IP prefix list and sets the community value.

```
switch(config)#route-map MAP_1 permit
switch(config-route-map-MAP_1)#match ip address prefix-list PL_1
switch(config-route-map-MAP_1)#set community 500
switch(config-route-map-MAP_1)#exit
switch(config)#
```

3. Create a community list that references the community.

```
switch(config)#ip community-list CL_1 permit 500
switch(config)#
```

BGP extended communities identify routes for VRFs or for link bandwidth (LBW). Extended community clauses utilize route target (rt) and site of origin options (soo):

- **route targets** identify sites that may receive appropriately tagged routes.
- **site of origin** identifies the site where the router learned the route.

---

## Filtering with AS Path Access Lists

An AS path access list is a named list of permit and deny statements which use regular expressions to filter BGP routes based on their AS path attribute. AS path access lists are created using the `ip as-path access-list` command, and are applied using a route map match clause with the name of the access list as a parameter.

### Example

- These commands create an AS path access list identifying routes which pass through AS 3, create a route map which references the access list, assign the routes it filters to community 300, and apply the route map to the neighbor at 192.68.14.5 to assign a community value of 300 to inbound routes received from that neighbor.

1. Create the AS path access list.

```
switch(config)#ip as-path access-list as_list3 permit _3_
```

2. Create a route map that matches the AS path access list and sets the community value.

```
switch(config)#route-map MAP_3 permit
switch(config-route-map-MAP_3)#match as-path as_list3
switch(config-route-map-MAP_3)#set community 300
switch(config-route-map-MAP_3)#exit
```

3. Apply the route map to the neighbor.

```
switch(config)#router bgp 1
switch(config-router-bgp)#neighbor 192.68.14.5 route-map MAP_3 in
switch(config-router-bgp)#
```

### 14.5.2.3 Configuring GTSM for BGP

The Generalized TTL Security Mechanism (GTSM) uses a packet's Time to Live (TTL) (IPv4) or Hop Limit (IPv6) to protect BGP peering sessions from denial-of-service (DoS) attacks based on forged protocol packets.

An IP packet received from a BGP peer is discarded when its current TTL value is less than (255-n) where n is the configured maximum number of hops to the peer. Use the `neighbor ttl maximum-hops` command to configure the maximum hop count.



**Note:** IP packets to GTSM enabled BGP peers are sent with the configured TTL value of 255.

### 14.5.2.4 Configuring Routes

#### 14.5.2.4.1 Advertising Routes

A BGP neighbor advertises routes it can reach through UPDATE packets. The `network (BGP)` command specifies a prefix that the switch advertises as a route originating from its AS.

The configuration clears the host portion of addresses entered in `network` commands. For example, 192.0.2.4/24 is stored as 192.0.2.0/24.

### Example

- This command configures the switch to advertise the 10.5.8.0/24 network.

```
switch(config-router-bgp)#network 10.5.8.0/24
switch(config-router-bgp)#
```

By default, BGP will advertise only those routes that are active in the switch's RIB. This can contribute to dropped traffic. If a preferred route is available through another protocol (like OSPF), the BGP route will become inactive and not be advertised; if the preferred route is lost, there is no available route to the affected peers. Advertising inactive BGP routes minimizes traffic loss by providing alternative routes.

The `bgp advertise-inactive` command causes BGP to advertise inactive routes to BGP neighbors. Inactive route advertisement is configured globally, but the global setting can be overridden on a per-VRF basis.

### Examples

- This command configures the switch to advertise routes learned through BGP even if they are not active on the switch.

```
switch(config-router-bgp) #bgp advertise-inactive
switch(config-router-bgp) #
```

- This command overrides inactive route advertisement for VRF "purple."

```
switch(config-router-bgp) #vrf purple
switch(config-router-bgp-vrf-purple) #no bgp advertise-inactive
switch(config-router-bgp-vrf-purple) #
```

#### 14.5.2.4.2 Advertising ISIS Routes into BGP Network

The `redistribute isis route-map isis-to-bgp` command advertises the routes learned through IS-IS routes into the BGP network. It also allows the user to selectively advertise some routes and modify route attributes before advertising using route maps.

The command is available in both address-family mode and router BGP mode, but the command is rejected if configured in both address-family mode and router mode at the same time.

While redistributing IS-IS routes into BGP, the Level-1 or Level-2 keyword can be used to selectively redistribute Level-1 routes or Level-2 routes into BGP. The keyword is optional, and defaults to level-2 when not configured.

Use the `show ipv6 bgp detail` command to verify that routes are advertised with correct attributes.



**Note:** If the command is configured in router-af mode, it only redistributes routes with matching address family. If it is configured in router mode, it applies to all enabled address-families.

### Examples

- These commands redistribute IS-IS routes into BGP in address-family mode.

```
switch(config) #router bgp 1
switch(config-router-bgp) #address-family ipv4
switch(config-router-bgp-af) #redistribute isis level-1 route-map isis-
to-bgp-v4
switch(config-router-bgp-af) #
```

- These commands redistribute IS-IS routes into BGP in router BGP mode.

```
switch(config) #router bgp 1
switch(config-router-bgp) #redistribute isis level-1 route-map isis-to-
bgp
switch(config-router-bgp) #
```

---

### 14.5.2.4.3 BGP Route Aggregation

Aggregation combines the characteristics of multiple routes into a single route for advertisement by the BGP speaker. Aggregation can reduce the amount of information that a BGP speaker is required to store and transmit when advertising routes to other BGP speakers. Aggregation options affect the attributes associated with the aggregated route, the advertisement of the contributor routes that comprise the aggregate, and which contributor routes are included.

Aggregate routes are created with the `aggregate-address` command, which takes an IP subnet as an argument; any routes configured on the switch that lie within that subnet then become contributors to the aggregate. Note that on Arista switches the BGP aggregate route will become active if there are any available contributor routes on the switch, regardless of the originating protocol. This includes routes configured statically.

BGP speakers display aggregate routes that they create as null routes (with one exception: if all the contributors to the aggregate have the same BGP path attributes, then the BGP aggregate copies those attributes and is no longer a null route). Aggregate routes are advertised into the BGP autonomous system and redistributed automatically, and their redistribution cannot be disabled. BGP neighbors display inbound aggregate routes as normal BGP routes. Null routes are displayed with the `show ip route` command; normal BGP routes (and null aggregate routes) are displayed with the `show ip bgp` and `show ip route` commands.

#### Aggregation Options

The `aggregate-address` command provides the following aggregate route options:

- **AS\_PATH attribute inclusion:** the `as-set` option controls the aggregate route's `AS_PATH` and `ATOMIC_AGGREGATE` attribute contents. `AS_PATH` identifies the autonomous systems through which UPDATE message routing information passes. `ATOMIC_AGGREGATE` indicates that the route is an aggregate or summary of more specific routes.

When the command includes `as-set`, the aggregate route's `AS_SET` attribute contains the AS numbers of contributor routes. This can help BGP neighbors to prevent loops by rejecting aggregate routes that include their AS number in the `AS_SET`.

When the command does not include `as-set`, the aggregate route's `ATOMIC_AGGREGATE` attribute is set and the `AS_PATH` attribute does not include AS numbers of contributing routes.

- **Attribute assignment:** the `attribute-map` option assigns attributes contained in `set` commands in a specified route map's lowest sequence with any `set` command to the aggregated route, overriding the automatic determination of the aggregate route's attributes by the switch.
- **Route suppression:** the `summary-only` option suppresses the advertisement of the contributor routes that comprise the aggregate.
- **Contributor filtering:** the `match-map` option uses a route map to filter out contributor routes that would otherwise be included in the aggregate.

#### Example

- These commands create an aggregate route (10.16.48.0/20) from four contributor routes (10.16.48.0/23, 10.16.50.0/23, 10.16.52.0/23, and 10.16.54.0/23). The aggregate route includes the `AS_PATH` information from the contributor routes.

```
switch(config)#router bgp 1
switch(config-router-bgp)#aggregate-address 10.16.48.0/20 as-set
switch(config-router-bgp)#exit
switch(config)#
```

- These commands create an aggregate route and use a route map to add a local-preference attribute to the route.

```
switch(config)#route-map map1 permit 10
```

```
switch(config-route-map-map1)#set local-preference 40
switch(config-route-map-map1)#exit
switch(config)#router bgp 1
switch(config-router-bgp)#aggregate-address 10.16.48.0/20 attribute-map
map1
switch(config-router-bgp)#exit
switch(config)#
```

- These commands create an aggregate route and use a route map to allow only those contributors which match a specified prefix list to be included in the aggregate route.

```
switch(config)#route-map matchmap permit 10
switch(config-route-map-matchmap)#match ip address prefix-list agglist
switch(config-route-map-matchmap)#exit
switch(config)#router bgp 1
switch(config-router-bgp)#aggregate-address 1.1.0.0/16 match-map
matchmap
switch(config-router-bgp)#
```

### Identifying BGP Aggregate Contributors Match in Outbound Policy

When configured, this feature introduces the ability to match on:

1. Any BGP aggregate contributor, in the outbound route maps.
2. A specific BGP aggregate's contributor, in the outbound route maps.

The attributes that are currently supported for matching on BGP aggregate contributors are community, local-preference, prefix, next-hop, route-type.

### Match Contributors to Any Aggregate

To match contributors to any BGP aggregate and set attributes (say communities) on said contributor, add an outbound policy with the clause:

```
switch(config-route-map-test)#match aggregate-role contributor
```

The **match aggregate-role contributor** clause only works with outbound policies.

#### Example:

- In this example, all the BGP contributor routes (to all aggregates) is assigned to the community 65536:100 as they are advertised to the neighbor 192.0.2.1

```
ip community-list BLUE permit 65536:100
!
route-map OUTBOUND_POLICY permit 10
 match aggregate-role contributor
 set community community-list BLUE
!
route-map OUTBOUND_POLICY permit 20
 description "Permit the routes rejected by seq10"
!
router bgp 65536
 aggregate-address 203.0.113.0/24
 neighbor 192.0.2.1 route-map OUTBOUND_POLICY out
!
```

---

## Match Contributors to Specific Aggregates

To match contributors which contribute only to a BGP aggregate with specific attributes (say communities) and set attributes (say communities again) on said contributor, add an outbound policy with the clause:

```
switch(config-route-map-test)#match aggregate-role contributor aggregate-attributes MATCH_AGG_COLOR
```

Define the MATCH\_AGG\_COLOR as below:

```
route-map MATCH_AGG_COLOR
 match community RED
```

Add an aggregate definition to explicitly set the desired attributes on the aggregate of interest:

```
route-map AGG_SET_COLOR
 set community community-list RED
!
router bgp 65536
 aggregate-address 203.0.113.0/24 attribute-map AGG_SET_COLOR
```

The route map referenced by the match **aggregate-role contributor aggregate-attributes** clause discards all set operations.

### Example:

- In this example the BGP contributor routes to the aggregate 203.0.113.0/24 (that has community 65536:200), to be assigned the community 65536:100 when they are advertised outbound to the neighbor 192.0.2.1

```
ip community-list BLUE permit 65536:100
ip community-list RED permit 65536:200
!
route-map AGG_SET_COLOR
 set community community-list RED
!
route-map MATCH_AGG_COLOR
 match community RED
!
route-map OUTBOUND_POLICY permit 10
 match aggregate-role contributor aggregate-attributes MATCH_AGG_COLOR
 set community community-list BLUE
!
route-map OUTBOUND_POLICY permit 20
 description "Permit the routes rejected by seq10"
!
router bgp 65536
 aggregate-address 203.0.113.0/24 attribute-map AGG_SET_COLOR
 neighbor 192.0.2.1 route-map OUTBOUND_POLICY out
!
```

### Invert-result Support

This match clause supports the invert-result modifier. When applied, invert-result will invert the result of the match clause to which it is applied.

The results for the following command would be:

```
switch(config-route-map-test)#match invert-result aggregate-role contributor aggregate-attributes MATCH_AGG_COLOR
```



1. match all routes that are not contributors to any aggregate
2. match all routes that are contributors to aggregates where the aggregate doesn't match MATCH\_AGG\_COLOR (provided MATCH\_AGG\_COLOR is configured)
3. not match all routes that are contributors to aggregates where the aggregate matches MATCH\_AGG\_COLOR (provided MATCH\_AGG\_COLOR is configured)
4. not match all routes that are contributors to aggregates if MATCH\_AGG\_COLOR is not configured

#### Related Command

[match \(route-map\)](#)

#### 14.5.2.4.4 Customizing the BGP AS-Path Attribute

The BGP Replace AS-Path feature allows the user to customize the AS\_PATH attribute for prefixes that are either received from a BGP neighbor or advertised to a BGP neighbor. To configure the BGP Replace AS-Path feature, use the `set as-path match` and `set as-path prepend` commands.

To replace the AS\_PATH attribute of routes received from a BGP neighbor, configure a route map and attach the policy to the corresponding BGP neighbor statement in the inbound direction.

To replace the AS\_PATH attribute of routes that are advertised to a neighbor, configure a route map and attach the policy to the corresponding BGP neighbor statement in the outbound direction.

The Replace AS-Path feature works in conjunction with the AS-Path Prepend feature which is also used to modify the AS\_PATH attribute. However, if both features are configured within the same route map, then the replace AS-Path feature takes precedence over the AS-Path Prepend.



**Note:** The BGP Replace AS-Path feature supports both eBGP and iBGP neighbors. The locally configured AS number is always prefixed to the AS-Path of routes advertised to the eBGP neighbors. This RFC behavior is retained in Arista's implementation of the Replace AS-Path feature as well.

BGP Replace AS-Path has the following limitations:

- Replacing the AS-Path should be used cautiously since it may impact BGP loop prevention.
- A few duplicated routes may be advertised and installed on a router after the original AS-Path of those routes are replaced. To fix this issue, it is always suggested to filter out such routes by prefix with BGP Community.

#### Example

- This command replaces the AS-Path with the none option.

```
switch#show ip bgp neighbors 80.80.1.2 advertised-routes
BGP routing table information for VRF default
Router identifier 202.202.1.1, local AS number 200
Route status codes: s - suppressed, * - valid, > - active, # - not installed, E
- ECMP head, e - ECMP
 S - Stale, c - Contributing to ECMP, b - backup, L - labeled-unicast,
q - Queued
for advertisement
Origin codes: i - IGP, e - EGP, ? - incomplete
AS Path Attributes: Or-ID - Originator ID, C-LST - Cluster List, LL Nexthop -
Link Local Nexthop

 Network Next Hop Metric LocPref Weight Path
* > 101.101.1.0/24 80.80.1.1 - - - 200 i
* > 102.102.1.0/24 80.80.1.1 - - - 200 i
* > 103.103.1.0/24 80.80.1.1 - - - 200 302 i
* > 202.202.1.0/24 80.80.1.1 - - - s200 i

switch#configuration terminal
switch(config)#route-map foo permit 10
switch(config-route-map-foo)#set as-path match all replacement none
switch(config-route-map-foo)#exit
switch(config)#router bgp 200
switch(config-router-bgp)#neighbor 80.80.1.2 route-map foo out
switch(config-router-bgp)#end
```

```

switch#show ip bgp neighbors 80.80.1.2 advertised-routes
BGP routing table information for VRF default
Router identifier 202.202.1.1, local AS number 200
Route status codes: s - suppressed, * - valid, > - active, # - not installed, E
- ECMP head, e - ECMP
 S - Stale, c - Contributing to ECMP, b - backup, L - labeled-unicast,
q - Queued
for advertisement
Origin codes: i - IGP, e - EGP, ? - incomplete
AS Path Attributes: Or-ID - Originator ID, C-LST - Cluster List, LL Nexthop -
Link Local Nexthop

 Network Next Hop Metric LocPref Weight Path
* > 101.101.1.0/24 80.80.1.1 - - - 200 i
* > 102.102.1.0/24 80.80.1.1 - - - 200 i
* > 103.103.1.0/24 80.80.1.1 - - - 200 i
* > 202.202.1.0/24 80.80.1.1 - - - 200 i
switch#

```

The AS-Path of matching prefixes are replaced with an empty or a null AS-Path. AS 302 is removed from prefix 103.103.1.0/24 as shown in the above output.

- This command replaces the AS-Path with the auto option.

```

switch(config)#route-map foo permit 10
switch(config-route-map-foo)#set as-path match all replacement auto
switch(config-route-map-foo)#end
switch#show ip bgp neighbors 80.80.1.2 advertised-routes
BGP routing table information for VRF default
Router identifier 202.202.1.1, local AS number 200
Route status codes: s - suppressed, * - valid, > - active, # - not installed, E
- ECMP head, e - ECMP
 S - Stale, c - Contributing to ECMP, b - backup, L - labeled-unicast,
q - Queued
for advertisement
Origin codes: i - IGP, e - EGP, ? - incomplete
AS Path Attributes: Or-ID - Originator ID, C-LST - Cluster List, LL Nexthop -
Link Local Nexthop

 Network Next Hop Metric LocPref Weight Path
* > 101.101.1.0/24 80.80.1.1 - - - 200 200 i
* > 102.102.1.0/24 80.80.1.1 - - - 200 200 i
* > 103.103.1.0/24 80.80.1.1 - - - 200 200 i
* > 202.202.1.0/24 80.80.1.1 - - - 200 200 i
switch#

```

The AS-path of matching prefixes are replaced with the locally configured AS 200.

#### 14.5.2.4.5 AS-path Modifications for Split ASes

By default, BGP rejects routes that contain the local autonomous system number (ASN). Sometimes a single autonomous system is divided geographically or otherwise with one or more provider ASes in between. In these cases, a valid route can sometimes be dropped by a customer edge router because the local ASN appears in the AS-path of route advertisements that have traveled through one or more provider networks. To ensure that these routes are not dropped, the provider edge router can be configured to replace the customer AS with its own, or the customer edge router can be configured to ignore its local AS number in received routes.

#### Replacing Remote ASN in Outbound Route Announcements

To replace a remote ASN with the local ASN in BGP route announcements sent to a specified router, use the `neighbor as-path remote-as replace out` command.

#### Example

- These commands configure the switch to substitute its local ASN for the ASN of the BGP neighbor at 192.168.2.15 in BGP routes advertised to that neighbor.

```

switch(config)#router bgp 1

```

```
switch(config-router-bgp) #neighbor 192.168.2.15 as-path remote-as
replace out
switch(config-router-bgp) #
```

### Ignoring Local ASN in Incoming Route Announcements

To accept BGP routes that include the local ASN in their AS-path attribute, use the `neighbor allowas-in` command.

#### Example

- These commands configure the switch to accept routes from the BGP neighbor at 192.168.1.30 which contain the switch's ASN in their AS paths as many as 3 times.

```
switch(config) #router bgp 1
switch(config-router-bgp) #neighbor 192.168.1.30 allowas-in
switch(config-router-bgp) #
```

### 14.5.2.5 Configuring Address Families

The switch determines the network prefixes that peering sessions advertise and the BGP neighbor addresses that receive advertisements through address family activity configuration.

An address family is a data structure that defines route advertising status to BGP neighbor addresses. Each BGP neighbor address is assigned an activity level for each address family on the switch. The switch sends capability and network prefix advertisements to neighbor addresses that are active within specified address families:

- IPv4 address family: switch advertises IPv4 capability and network commands with IPv4 prefixes to neighbor addresses configured as **IPv4 address family active**.
- IPv6 address family: switch advertises IPv6 capability and network commands with IPv6 prefixes to neighbor addresses configured as **IPv6 address family active**.

#### 14.5.2.5.1 Neighbor Address Family Configuration

Address family activity levels for neighbor addresses are configured through `bgp default` and `neighbor activate` commands.

- The `bgp default` command specifies the default activity level of BGP neighbor addresses for a specified address family.
- The `neighbor activate` command specifies deviations from default address family activity level for a specified BGP neighbor address.

#### Default Neighbor Activation

The `bgp default` command configures the default address family activity level of all configured BGP neighbor addresses. The switch advertises the following to **address family active** addresses:

- IPv4 address family active: IPv4 capability and all network advertisements with IPv4 prefixes.
- IPv6 address family active: IPv6 capability and all network advertisements with IPv6 prefixes.

These commands configure default address family activity levels for configured BGP neighbor addresses:

- **bgp default ipv4-unicast**: all BGP neighbor addresses are IPv4 address family active (this is the switch default).
- **no bgp default ipv4-unicast**: no BGP neighbor addresses are IPv4 address family active.
- **bgp default ipv6-unicast**: all BGP neighbor addresses are IPv6 address family active.

- **no bgp default ipv6-unicast:** no BGP neighbor addresses are IPv6 address family active (this is the switch default).
- **bgp default ipv4-unicast transport ipv6:** all BGP neighbor addresses are IPv4 address family active and IPv6 neighbors can receive IPv4 NLRIs.



**Note:** If it is necessary to exchange IPv4 NLRIs over an IPv6 connection, the IPv4 address family must be activated on the IPv6 neighbor. To do this for all IPv6 neighbors, use the command `bgp default ipv4-unicast transport ipv6`. For an individual neighbor, use the `neighbor activate` command for the IPv6 neighbor in the IPv4 address-family configuration mode as described below.

### Activating Individual Neighbor Addresses

The `address-family` command places the switch in address family mode to configure the address family activity level of individual BGP neighbor addresses. The switch supports these address families:

- `ipv4-unicast`
- `ipv6-unicast`

**Running-config** displays `address family` commands in sub-blocks of the BGP configuration. The `neighbor activate` command is available in each address family configuration mode and defines the configuration mode address family activity level of a specified configured BGP neighbor address. Addresses are assigned one of the following states by the activate command:

- **neighbor activate** configures the address as active in the configuration mode address family.
- **no neighbor activate** configures the address as not active in the configuration mode address family.

The switch sends the following announcements to addresses that are active in an address family:

- **IPv4 address family:** IPv4 capability and all network routes with IPv4 prefixes.
- **IPv6 address family:** IPv6 capability and all network routes with IPv6 prefixes.

The `neighbor route-map (BGP)` command applies a route map to inbound or outbound BGP routes. In address-family mode, the route map is applied to routes corresponding to the configuration-mode address family. When a route map is applied to outbound routes, the switch advertises only routes matching at least one section of the route map. One outbound and one inbound route map can be applied to a neighbor for each address family. Applying a route map to a route replaces the previous corresponding route map assignment.

### Network Route Advertising in Address Families

The `network (BGP)` command specifies a network for advertisement through UPDATE packets to BGP peers. The command is available in Router-BGP and Router-BGP-Address-Family configuration modes; the mode in which the command is issued does not affect the command's execution.

- Commands with an IPv4 address are advertised to peers that are IPv4 address family-active.
- Commands with an IPv6 address are advertised to peers that are IPv6 address family-active.

### Examples

- These commands instantiate BGP, configure three neighbors, and configure two network routes.

The default activity level for IPv4 and IPv6 address families is set to the default; all neighbor addresses are IPv4 address family active and IPv6 address family not active. IPv4 capability and network routes with IPv4 prefixes are advertised to all neighbor IPv4 addresses.

```
switch(config)#router bgp 9
switch(config-router-bgp)#neighbor 172.21.14.8 remote-as 15
switch(config-router-bgp)#neighbor 172.23.18.6 remote-as 16
switch(config-router-bgp)#neighbor 2001:0DB8:8c01::1 remote-as 16
```

```
switch(config-router-bgp) #network 172.18.23.9/24
switch(config-router-bgp) #network 2001:0DB8:de29::/64
switch(config-router-bgp) #
```

- These commands instantiate BGP on the switch, set IPv4 default activity level (**not active**), set IPv6 default activity level (**active**), and configure three neighbor addresses and two network route prefixes.

IPv6 capability and network routes with IPv6 prefixes are advertised to all neighbor addresses.

```
switch(config) #router bgp 10
switch(config-router-bgp) #bgp default ipv6-unicast
switch(config-router-bgp) #no bgp default ipv4-unicast
switch(config-router-bgp) #neighbor 172.21.14.8 remote-as 15
switch(config-router-bgp) #neighbor 172.23.18.6 remote-as 16
switch(config-router-bgp) #neighbor 2001:0DB8:8c01::1 remote-as 16
switch(config-router-bgp) #network 172.18.23.9/24
switch(config-router-bgp) #network 2001:0DB8:de29::/64
switch(config-router-bgp) #
```

- These commands configure three neighbors, two network routes, and the default activity level for each address family (**not active**), and specify neighbor addresses for each address family that is active.

```
switch(config) #router bgp 11
switch(config-router-bgp) #neighbor 172.21.14.8 remote-as 15
switch(config-router-bgp) #neighbor 172.23.18.6 remote-as 16
switch(config-router-bgp) #neighbor 2001:0DB8:8c01::1 remote-as 16
switch(config-router-bgp) #network 172.18.23.9/24
switch(config-router-bgp) #network 2001:0DB8:de29::/64
switch(config-router-bgp) #no bgp default ipv4-unicast
switch(config-router-bgp) #no bgp default ipv6-unicast
switch(config-router-bgp) #address-family ipv4
switch(config-router-bgp-af) #neighbor 172.21.14.8 activate
switch(config-router-bgp-af) #neighbor 172.23.18.6 activate
switch(config-router-bgp-af) #exit
switch(config-router-bgp) #address-family ipv6
switch(config-router-bgp-af) #neighbor 2001:0DB8:8c01::1 activate
switch(config-router-bgp-af) #exit
switch(config-router-bgp) #
```

- These commands permit IPv4 NLRI transport over all IPv6 connections by making the IPv4 address family active on IPv6 BGP neighbors.

```
switch(config) #router bgp 11
switch(config) #address-family ipv4
switch(config-router-bgp-af) #bgp default ipv4-unicast transport ipv6
switch(config-router-bgp-af) #exit
switch(config-router-bgp) #
```

#### 14.5.2.6 Configuring Best-path Selection

The best-path selection algorithm (described under [Best-Path Selection](#)) determines which of multiple paths to the same destination received by BGP will be added to the IP routing table. To shape route preferences and influence best-path selection, use the following commands in router-BGP configuration mode.

- `bgp always-compare-med` configures the switch to always consider the multi-exit discriminator (MED) value when comparing paths (disabled by default).

- `bgp bestpath as-path ignore` configures the switch to ignore the length of the autonomous system (AS) path when comparing routes (disabled by default).
- `bgp bestpath as-path multipath-relax` used in equal-cost multi path (ECMP configuration) and enabled by default; the `no` form of the command configures the switch to consider paths unequal if their AS paths have different contents.
- `bgp bestpath ecmp-fast` the `no` form of this command causes the switch to ignore order of arrival in evaluating paths within an ECMP group.
- `bgp bestpath med confed` causes comparison of multi-exit discriminator (MED) values in routes originating within the same confederation as the switch and received from confederation peers (disabled by default).
- `bgp bestpath med missing-as-worst` configures the switch to treat a missing MED as having the highest (least preferred) value (disabled by default). This command overrides the `missing-as-worst` setting of the `bgp bestpath med confed` command.
- `bgp bestpath tie-break cluster-list-length` configures the switch to prefer the multipath route with the shortest CLUSTER\_LIST length in case of a tie in step 10 of the selection process (disabled by default).
- `bgp bestpath tie-break router-id` configures the switch to prefer the multipath route with the lowest ROUTER\_ID in case of a tie in step 10 (disabled by default).

#### 14.5.2.6.1 Displaying Reasons for Best-path Selection

To see the reasons why certain routes were excluded by the best-path selection process, use the `detail` option of the `show ip bgp` command. Enter the prefix to which BGP has selected a best path, and the output will display all learned paths. Paths which were not selected as best will display the reason they were not selected after the label **not best**.

The reason will be listed as one of the following:

- path weight
- local preference
- AS path length
- origin
- path MED
- eBGP path preferred
- IGP cost
- AS path details
- ECMP-Fast configured
- router ID
- originator ID
- router ID tie-break configured
- cluster list length
- cluster list length tie-break configured
- peer IP address
- path ID
- redistributed route exists
- unknown
- another route from the same AS is a better BGP route
- peer not ready
- unusable

**Example**

- This command displays the reasons why three routes to 172.16.0.0/24 were rejected by the best-path algorithm. The reason for rejection is preceded by the label **Not best**:

```
switch#show ip bgp 172.16.0.0/24 detail
BGP routing table information for VRF default
Router identifier 192.168.100.18, local AS number 64524
Route status: [a.b.c.d] - Route is queued for advertisement to peer.
BGP routing table entry for 204.1.47.220/30
 Paths: 4 available
 64512 64550 65100
 192.168.14.2 from 192.168.14.2 (192.168.100.21)
 Origin IGP, metric 0, localpref 100, weight 0, received 19:15:29
 ago, valid,
 external, ECMP head, ECMP, best, ECMP contributor
 Rx SAFI: Unicast
 64512 64550 65100
 192.168.24.2 from 192.168.24.2 (192.168.100.22)
 Origin IGP, metric 0, localpref 100, weight 0, received 19:15:29
 ago, valid,
 external, ECMP, ECMP contributor
 Rx SAFI: Unicast
 Not best: ECMP-Fast configured
 64512 64550 65100
 192.168.34.2 from 192.168.34.2 (192.168.100.23)
 Origin IGP, metric 0, localpref 100, weight 0, received 19:15:29
 ago, valid,
 external, ECMP, ECMP contributor
 Rx SAFI: Unicast
 Not best: Redistributed route exists
 64512 64550 65100
 192.168.44.2 from 192.168.44.2 (192.168.100.24)
 Origin IGP, metric 0, localpref 100, weight 0, received 19:15:29
 ago, valid,
 external, ECMP, ECMP contributor
 Rx SAFI: Unicast
 Not best: eBGP path preferred
 Not advertised to any peer
switch#
```

**14.5.2.7 Configuring BGP Convergence**

To avoid hardware updates and route advertisement churn during switch reload or BGP instance start, BGP enters into the convergence state where it waits for all peers to join and receive all routes from all the peers.

**BGP Convergence** is bound by an upper value of convergence time (default value is 5 minutes) and BGP declares convergence on expiry of convergence timer. At the end of convergence, BGP updates the routes in FIB and advertises to all the peers.

To configure BGP convergence and the different timeout features, use the following commands in router-BGP configuration mode.

- `update wait-for-convergence` enables the BGP convergence feature.
- `bgp convergence slow-peer time` configures the BGP convergence idle peer timeout value. The default timeout value is 90 seconds.
- `bgp convergence time` configures the BGP convergence timeout value. The default timeout value is 300 seconds.



---

## Different Cases for Convergence with Default Timeout Configuration

- **Convergence Time < 90 seconds after the first peer has joined:** this is the best case when all the configured peers have joined and EORs have been received from all peers in less than 90 seconds after the first peer has joined.
- **Convergence Time = 90 seconds after the first peer has joined:** this is the case when one or more BGP peers have joined within 90 seconds and EORs have been received from all peers within 90 seconds, but there are still some configured peers which have not joined yet. In this case, the convergence is declared after slow-peer timeout is reached.
- **Convergence Time > 90 seconds after the first peer has joined:** this is the case when one or more BGP peers have joined after 90 seconds, but EORs have not been received from all peers. As soon as EORs are received from all peers which have joined during the first 90 seconds, the convergence is declared.
- **Convergence Time = 300 seconds after the first peer has joined:** this is the case when EOR is not received till 300 seconds from some of the peers that have joined during 90 seconds after the first peer has joined.

### 14.5.2.7.1 Displaying BGP Convergence Status

Use the `show bgp convergence` command to view information about the BGP convergence status, and to know if the convergence timer has started or not. The examples below show the command output at different points in the convergence process.

#### No Peers Have Joined

- This is the output when no peers have joined before convergence.

```
switch(config-router-bgp)#show bgp convergence
BGP Convergence information for VRF: default
Configured convergence timeout: 00:02:30
Configured convergence slow peer timeout: 00:00:55
Convergence based update synchronization is enabled
Last Bgp convergence event : None
Bgp convergence state : Not Initiated (Waiting for the first peer to
join)
Convergence timer is not running
Convergence timeout in use: 00:02:30
Convergence slow peer timeout in use: 00:00:55
First peer is not up yet
All the expected peers are up: no
All IGP protocols have converged: yes
Outstanding EORs: 0, Outstanding Keepalives: 0
Pending Peers: 2
Total Peers: 2
Established Peers: 0
Disabled Peers: 0
Peers that have not converged yet:
IPv4 peers:
201.1.1.1 (Session : Connect)
202.1.1.1 (Session : Connect)
IPv6 peers:
None
switch(config-router-bgp)#
```

#### First Peer Has Joined

- This is the output when the first peer has joined before convergence.

```
switch#show bgp convergence
```



```

BGP Convergence information for VRF: default
Configured convergence timeout: 00:02:30
Configured convergence slow peer timeout: 00:00:55
Convergence based update synchronization is enabled
Last Bgp convergence event 00:00:40 ago
Bgp convergence state : Pending (Waiting for EORs/Keepalives from
peer(s) and IGP
convergence)
Convergence timer running, will expire in 00:01:50
Convergence timeout in use: 00:02:30
Convergence slow peer timeout in use: 00:00:55
First peer came up 00:00:13 ago
All the expected peers are up: no
All IGP protocols have converged: yes
Outstanding EORs: 0, Outstanding Keepalives: 0
Pending Peers: 1
Total Peers: 2
Established Peers: 1
Disabled Peers: 0
Peers that have not converged yet:
IPv4 peers:
201.1.1.1 (Session : Active)
IPv6 peers:
None
switch#

```

### Convergence Timeout Reached

- This is the output when the convergence timeout value is reached.

```

switch(config-router-bgp)#show bgp convergence
BGP Convergence information for VRF: default
Configured convergence timeout: 00:02:30
Configured convergence slow peer timeout: 00:00:55
Convergence based update synchronization is enabled
Last Bgp convergence event 00:02:44 ago
Bgp convergence state : Timeout reached
Time taken to converge 00:02:30
Pending Peers: 1
Total Peers: 2
Established Peers: 1
Disabled Peers: 0
Peers that did not converge before local bgp convergence:
IPv4 peers:
201.1.1.1 (Session : Active)
202.1.1.1 (Session : Established)
IPv6 peers:
None
switch(config-router-bgp)#

```

### Converged State

- This is the output during the converged state.

```

switch(config-router-bgp)#show bgp convergence
BGP Convergence information for VRF: default
Configured convergence timeout: 00:05:00
Configured convergence slow peer timeout: 00:01:30
Convergence based update synchronization is enabled
Last Bgp convergence event 00:00:05 ago
Bgp convergence state : Converged
Time taken to converge 00:00:02

```

```
First peer came up 00:00:05 ago
Pending Peers: 0
Total Peers: 3
Established Peers: 3
Disabled Peers: 0
Peers that did not converge before local bgp convergence:
IPv4 peers:
None
IPv6 peers:
None
switch(config-router-bgp)#
```

## 14.5.2.8 Configuring BGP Graceful Shutdown Community

### 14.5.2.8.1 Creating a Route-Map Entry That Sets the Community for Graceful Shutdown

The `set community (route-map)` command specifies community attribute modifications to BGP routes.

#### Example

```
switch(config)#route-map map1
switch(config-route-map-map1)#set community GSHUT
switch(config)#exit
switch(config)#
```

### 14.5.2.8.2 Creating a Route-Map Entry with Matching Preferences on Graceful Shutdown Community

The `ip community-list` command creates and configures a BGP access list that is based on BGP communities.

The `match (route-map)` command creates a route map clause entry that specifies one route filtering condition.

#### Example

```
switch(config)#ip community-list gshut_list permit GSHUT
switch(config)#route-map map1
switch(config-route-map-map1)#match community gshut_list
switch(config-route-map-map1)#exit
switch(config)#
```

### 14.5.2.8.3 Validating the Route-Map

The `show route-map` command displays the contents of the specified route maps.

#### Example

```
switch#show route-map map1
route-map map1 permit 10
Description:
Match clauses:
Set clauses:
set community GSHUT
switch#
```

### 14.5.2.9 Configuring BGP Selective Route Download

The `bgp route install-map` command is used in the BGP configuration mode to enable BGP Selective Route Download. BGP Selective Route Download can also be configured in an address family or VRF instance as shown in the following examples.

The following examples show how to configure a prefix list and route map, then apply BGP Selective Route Download to the map.

#### Examples

- These commands install BGP routes in the 10.0.0.0/24 and 20.0.0.0/24 ranges in the RIB (and thus in the hardware), but no other BGP routes.

```
switch(config)#ip prefix-list PFXL_ALLOW
switch(config-ip-pfx)#seq 1 permit 10.0.0.0/24 ge 24 le 32
switch(config-ip-pfx)#seq 2 permit 20.0.0.0/24 ge 24 le 32
switch(config-ip-pfx)#exit
switch(config-ip-pfx)#
```

- These commands configure the permit and deny rules for BGP routes.

```
switch(config)#route-map BGP_INSTALL_MAP permit 10
switch(config-route-map-BGP_INSTALL_MAP)#match ip address prefix-list
PFXL_ALLOW
switch(config-route-map-BGP_INSTALL_MAP)#exit
switch(config)#route-map BGP_INSTALL_MAP deny 20
switch(config)#
```

- These commands configure Selective Route Download for the map BGP\_INSTALL\_MAP.

```
switch(config)#router bgp 100
switch(config-router-bgp)#bgp route install-map BGP_INSTALL_MAP
switch(config-router-bgp)#
```

The following examples show how to configure prefix lists individually for the IPv4 and IPv6 address families, then apply BGP Selective Route Download for these address families.

#### Examples

- These commands configure the IPv4 address family prefix list.

```
switch(config)#ip prefix-list V4_ALLOW
switch(config-ip-pfx)#route-map BGP_V4_MAP permit 10
switch(config-route-map-BGP_V4_MAP)#match ip address prefix-list
V4_ALLOW
switch(config-route-map-BGP_V4_MAP)#route-map BGP_V4_MAP deny 20
switch(config-route-map-BGP_V4_MAP)#exit
switch(config-route-map-BGP_V4_MAP)#
```

- These commands configure the IPv6 address family prefix list.

```
switch(config)#ipv6 prefix-list V6_ALLOW
switch(config-ipv6-pfx)#route-map BGP_V6_MAP permit 10
switch(config-route-map-BGP_V6_MAP)#match ipv6 address prefix-list
V6_ALLOW
switch(config-route-map-BGP_V6_MAP)#route-map BGP_V6_MAP deny 20
switch(config-route-map-BGP_V6_MAP)#exit
switch(config-route-map-BGP_V6_MAP)#
```

- These commands configure Selective Route Download individually for the two address families.

```
switch(config)#router bgp 200
switch(config-router-bgp)#address-family ipv4
switch(config-router-bgp-af)#bgp route install-map BGP_V4_MAP
switch(config-router-bgp-af)#exit
switch(config-router-bgp)#address-family ipv6
switch(config-router-bgp-af)#bgp route install-map BGP_V6_MAP
switch(config-router-bgp-af)#
```

#### 14.5.2.9.1 Displaying BGP Selective Route Download Information

The `show ip bgp` command displays BGP RIB winning paths that are not installed in the RIB.

##### Example

- The following command displays BGP routing table information for VRF default, showing winning paths that are not installed in the RIB.

```
switch#show ip bgp
BGP routing table information for VRF default
Router identifier 1.0.0.2, local AS number 100
Route status codes: s - suppressed, * - valid, > - active, # - not
installed, E
- ECMP head, e - ECMP
 S - Stale, c - Contributing to ECMP, b - backup
Origin codes: i - IGP, e - EGP, ? - incomplete
AS Path Attributes: Or-ID - Originator ID, C-LST - Cluster List, LL
Nexthop -
Link Local Nexthop

 Network Next Hop Metric LocPref Weight Path
* > 6.0.0.0/24 1.0.0.1 0 100 0 ?
* # 7.0.0.0/24 1.0.0.1 0 100 0 ?

switch#
```

The `show ip bgp` command with a specified prefix displays detailed information and the reason for the BGP RIB winning paths to that prefix not being installed in the RIB.

##### Example

- The following command displays detailed information for the BGP routing table for VRF default.

```
switch#show ip bgp 7.0.0.0/24
BGP routing table information for VRF default
Router identifier 1.0.0.2, local AS number 100
BGP routing table entry for 7.0.0.0/24
Paths: 1 available
Local
 1.0.0.1 from 1.0.0.1 (1.0.0.1)
 Origin INCOMPLETE, metric 0, localpref 100, weight 0, valid,
 internal, not
installed (denied by install-map)
switch#
```

The `show ip bgp installed` command displays the list of installed routes in the BGP RIB.

**Example**

- The following command displays the list of installed routes in BGP routing table for VRF defaults.

```
switch#show ip bgp installed
BGP routing table information for VRF default
Router identifier 1.0.0.2, local AS number 100
Route status codes: s - suppressed, * - valid, > - active, # - not
installed, E
- ECMP head, e - ECMP
 S - Stale, c - Contributing to ECMP, b - backup
Origin codes: i - IGP, e - EGP, ? - incomplete
AS Path Attributes: Or-ID - Originator ID, C-LST - Cluster List, LL
Nexthop -
Link Local Nexthop

 Network Next Hop Metric LocPref Weight
Path
* > 6.0.0.0/24 1.0.0.1 0 100 0 ?

switch#
```

The `show ip bgp not-installed` displays the list of non-installed routes in the RIB.

**Example**

- The following command displays the list of non-installed routes in the BGP routing table for VRF default.

```
switch#show ip bgp not-installed
BGP routing table information for VRF default
Router identifier 1.0.0.2, local AS number 100
Route status codes: s - suppressed, * - valid, > - active, # - not
installed, E
- ECMP head, e - ECMP
 S - Stale, c - Contributing to ECMP, b - backup
Origin codes: i - IGP, e - EGP, ? - incomplete
AS Path Attributes: Or-ID - Originator ID, C-LST - Cluster List, LL
Nexthop -
Link Local Nexthop

 Network Next Hop Metric LocPref Weight
Path
* # 7.0.0.0/24 1.0.0.1 0 100 0 ?

switch#
```

**14.5.2.10 Configuring Nexthop Resolution**

The configuration model for this feature involves configuring and applying **Nexthop Resolution RIB Profiles** on a per-address family basis. There are two ways a profile can be applied: (1) across an entire address-family, or (2) a granular, route-map based mechanism for specific routes within an address family. The per-address-family configuration is the simplest. It enables specification of a unique profile for all the routes in a given address family, such as IPV4 unicast, or EVPN. In contrast, the route-map approach leverages the matching criteria of route-map statements to apply profiles to individual routes within an address family.



**Note:** Note the support for each configuration and submode were released in a phased manner.

The general configuration model for the CLI is a new command under the BGP address-family submode:

```
switch(config-router-bgp-af) #next-hop resolution ribs (PROFILE | [route-map NAME])
```

The PROFILE option is a list of up to three (3) resolution domains. The NAME option is the name of a route-map. Notice the PROFILE and route-map NAME options are mutually exclusive. That is, a resolution profile can be specified either explicitly at the address family level, or on a per-route basis via a route-map.

To enable setting a profile using a route-map, this feature adds support for a new set statement in the route-map submode:

```
switch(config-route-map-NAME) #set next-hop resolution ribs PROFILE
```

You can combine this statement with existing match statements to select profiles based on the BGP path attributes of a route, or other properties.

As mentioned, the profile itself is a list of resolution domains:

```
PROFILE := DOMAIN [DOMAIN [DOMAIN]]
```

Example configuration for EVPN MPLS, EVPN VXLAN and BGP Labeled-unicast:

```
switch(config) #router bgp id
switch(config-router-bgp) #address-family evpn
switch(config-router-bgp-af) #next-hop mpls resolution ribs PRIMARY-RIB
[FALLBACK-RIB]
switch(config-router-bgp-af) #next-hop vxlan resolution ribs IP-RIB
...
address-family ipv4 labeled-unicast
next-hop mpls resolution ribs PRIMARY-RIB [FALLBACK-RIB]
address-family ipv6 labeled-unicast
next-hop mpls resolution ribs PRIMARY-RIB [FALLBACK-RIB]
```

The **PRIMARY-RIB** and **FALLBACK-RIB** refers to either tunnel domain or IP RIB domain. EVPN VXLAN only supports IP-RIB domain.

Configure the tunnel domain as:

- **tunnel-rib <tunnel-rib-name>** where the **<tunnel-rib-name>** refers to either the system-tunnel-rib or the user defined tunnel rib.

The IP domain can be either:

- **system-unicast-rib**
- **system-connected**

The **system-unicast-rib** refers to complete IP RIB and the **system-connected** refers to just the connected routes.

Primary and secondary RIBs cannot come from the same domain (for example, both cannot be from the tunnel domain and both cannot be from the IP RIB domain). The **FALLBACK-RIB** is optional.

Next-hops will first attempt to resolve, using the primary rib. If the resolution fails, it attempts to resolve using the fallback rib (if that exists).

### Example

```
router bgp <id>
address-family ipv4 labeled-unicast
```

**next-hop resolution ribs tunnel-rib USER\_TR system-unicast-rib**

All the nexthops of the IPV4 labeled-unicast routes will first attempt to resolve, using the **tunnel rib USER\_TR**. If the resolution fails, the nexthops attempt to resolve using the **complete unicast IP RIB**.

Each DOMAIN can be either a system or user-defined tunnel RIB or a unicast RIB. The available resolution domains, and their corresponding tokens, are tabulated below:

**Table 70: Domains**

| Domain                    | Token                                        | Description                                                                                                                                                                   |
|---------------------------|----------------------------------------------|-------------------------------------------------------------------------------------------------------------------------------------------------------------------------------|
| IP RIB                    | system-unicast-rib                           | The complete IP unicast RIB is available for next-hop resolution.                                                                                                             |
| Connected routes (IP)     | system-connected                             | Only connected routes are available for next-hop resolution.                                                                                                                  |
| System tunnel RIB         | tunnel-rib system-tunnel-rib                 | All winning tunnels from all protocols are available for next-hop resolution.                                                                                                 |
| System colored tunnel RIB | tunnel-rib colored system-colored-tunnel-rib | All winning, colored tunnels from all protocols are available for next-hop resolution. Only routes with an associated color can be resolved by the system colored tunnel RIB. |
| User-defined tunnel RIB   | tunnel-rib NAME                              | All contributing tunnels to the tunnel RIB called NAME are available for next-hop resolution.                                                                                 |
| IP RIB of VPN Import VRF  | vrf-unicast-rib                              | This token is limited to BGP L3VPNs.                                                                                                                                          |

Now the profile configuration is available under select BGP address family submodes. For example:

```
switch(config)#router bgp num
switch(config-router-bgp)#address-family evpn
switch(config-router-bgp-af)#next-hop mpls resolution ribs PROFILE
 next-hop vxlan resolution ribs PROFILE
address-family ipv4
 next-hop resolution ribs (PROFILE | route-map NAME)
address-family ipv4 labeled-unicast
 next-hop resolution ribs PROFILE
address-family ipv6
 next-hop resolution ribs (PROFILE | route-map NAME)
 next-hop 6pe resolution ribs PROFILE
address-family ipv6 labeled-unicast
 next-hop resolution ribs PROFILE
address-family vpn-ipv4
 next-hop resolution ribs PROFILE
address-family vpn-ipv6
 next-hop resolution ribs PROFILE
```

Note that a given address-family may restrict the possible profiles which can be configured, and may not support specifying a route-map. For example, the resolution profile for 6PE routes, configured via *next-hop 6pe resolution ribs PROFILE*, is constrained to only the tunnel domain. That is, the profile cannot specify either *system-unicast-rib* or *system-connected*. This is, of course, because it is meaningless to resolve a 6PE next-hop using either of those resolution domains.

### 14.5.2.10.1 Release Matrices

The following tables detail the release in which the possible configurations for this feature are available.

**Table 71:**

| Configuration                   | Release                                                |         |         |         |         |                              |
|---------------------------------|--------------------------------------------------------|---------|---------|---------|---------|------------------------------|
|                                 | next-hop resolution ribs PROFILE command               |         |         |         |         |                              |
|                                 | 4.22.0F                                                | 4.22.1F | 4.23.1F | 4.24.1F | 4.25.1F | Unsupported / Not Applicable |
| IPv4/IPv6 unicast (non 6PE)     | X                                                      |         |         |         |         |                              |
| IPv6 unicast 6PE                | X                                                      |         |         |         |         |                              |
| IPv4/IPv6 VPN (vrf-unicast-rib) | X                                                      |         |         |         |         |                              |
| IPv4/IPv6 VPN (full profile)    |                                                        | X       |         |         |         |                              |
| EVPN (MPLS)                     |                                                        |         | X       |         |         |                              |
| EVPN (VXLAN)                    |                                                        |         | X       |         |         |                              |
| IPv4/IPv6 LU                    |                                                        |         | X       |         |         |                              |
| IPv4/IPv6 Multicast             |                                                        |         |         |         |         | X                            |
| IPv4/IPv6 SR TE                 |                                                        |         |         |         |         | X                            |
| Flowspec                        |                                                        |         |         |         |         | X                            |
| Path Selection                  |                                                        |         |         |         |         | X                            |
| Link State                      |                                                        |         |         |         |         | X                            |
| RT Membership                   |                                                        |         |         |         |         | X                            |
|                                 | <b>PROFILE configuration</b>                           |         |         |         |         |                              |
| Up to 2 resolution domains      | X                                                      |         |         |         |         |                              |
| Up to 3 resolution domains      |                                                        |         |         | X       |         |                              |
| system-colored-tunnel-rib       |                                                        |         |         | X       |         |                              |
|                                 | <b>next-hop resolution ribs route-map NAME command</b> |         |         |         |         |                              |
| IPv4/IPv6 unicast (non 6PE)     |                                                        |         |         |         | X       |                              |
| IPv6 unicast 6PE                |                                                        |         |         |         |         | X                            |
| IPv4/IPv6 VPN                   |                                                        |         |         |         |         | X                            |
| EVPN (MPLS)                     |                                                        |         |         |         |         | X                            |
| EVPN (VXLAN)                    |                                                        |         |         |         |         | X                            |
| IPv4/IPv6 LU                    |                                                        |         |         |         |         | X                            |
| IPv4/IPv6 Multicast             |                                                        |         |         |         |         | X                            |
| IPv4/IPv6 SR TE                 |                                                        |         |         |         |         | X                            |
| Flowspec                        |                                                        |         |         |         |         | X                            |
| Path Selection                  |                                                        |         |         |         |         | X                            |



|                                  |                          |  |  |  |   |   |
|----------------------------------|--------------------------|--|--|--|---|---|
| Link State                       |                          |  |  |  |   | X |
| RT Membership                    |                          |  |  |  |   | X |
|                                  | <b>Route-map submode</b> |  |  |  |   |   |
| match ip[v6] next-hop            |                          |  |  |  | X |   |
| match ip[v6] address prefix-list |                          |  |  |  |   | X |
| match community                  |                          |  |  |  |   | X |
| match extcommunity               |                          |  |  |  |   | X |
| match large-community            |                          |  |  |  |   | X |
| All other match statements       |                          |  |  |  |   | X |
| All other set statements         |                          |  |  |  |   | X |
| sub-route-map                    |                          |  |  |  |   | X |

#### 14.5.2.10.2 Default Resolution Profiles

Given the aforementioned configuration model, the default resolution profiles in EOS for each address-family can be expressed by the following:

| Address-family                              | Default profile                                                                                                                                          |
|---------------------------------------------|----------------------------------------------------------------------------------------------------------------------------------------------------------|
| IPv4/IPv6 unicast (non 6PE)                 | tunnel-rib colored system-colored-tunnel-rib tunnel-rib system-tunnel-rib system-unicast-rib                                                             |
| IPv6 unicast 6PE                            | tunnel-rib colored system-colored-tunnel-rib tunnel-rib system-tunnel-rib                                                                                |
| IPv4/IPv6 unicast (eBGP directly connected) | system-connected                                                                                                                                         |
| IPv4/IPv6 VPN                               | tunnel-rib colored system-colored-tunnel-rib tunnel-rib system-tunnel-rib system-connected                                                               |
| IPv4/IPv6 LU                                | tunnel-rib colored system-colored-tunnel-rib tunnel-rib system-tunnel-rib system-connected                                                               |
| EVPN (MPLS)                                 | tunnel-rib colored system-colored-tunnel-rib tunnel-rib system-tunnel-rib system-connected                                                               |
| EVPN (VXLAN)                                | system-unicast-rib                                                                                                                                       |
| IPv4/IPv6 Multicast                         | <i>This is not supported. Multicast next-hops are first resolved in the MRIB. Failure to resolve in the MRIB results in a lookup in the unicast RIB.</i> |
| Flowspec                                    | <i>These next hops are not resolved.</i>                                                                                                                 |



**Note:** Support for the *system-colored-tunnel-rib* was released in **EOS Release 4.24.1F**. For earlier releases, the defaults can be determined by omitting this resolution domain.

#### 14.5.2.10.3 Semantics

When processing the next-hop of a route, the next-hop resolver attempts resolution by using the first domain in the route's resolution profile. If the resolution domain successfully resolves the next-hop, the resolver stops. If resolution fails, however, the resolver moves onto the next domain, if it exists,

---

and tries again. This iterative process continues until the next-hop is either resolved, or the profile is exhausted. In the latter case, the next-hop is left unresolved.

To illustrate this, consider the following example. This resolution profile constrains the resolution of a BGP route to only the IP unicast RIB:

```
switch(config-router-bgp-af) #next-hop resolution ribs system-unicast-rib
```

When a next-hop is unresolvable in the IP unicast RIB, and there are no further resolution domains to try, then the next-hop is ultimately unresolved. In contrast, the following profile first attempts resolution in the system colored tunnel RIB, then the system tunnel RIB, and finally attempts resolution using connected routes:

```
switch(config-router-bgp-af) #next-hop resolution ribs tunnel-rib colored
system-colored-tunnel-rib tunnel-rib system-tunnel-rib system-connected
```

Therefore, only when a next-hop cannot be resolved by any of those domains will it be ultimately unresolved.

### 14.5.2.10.3.Route Map Semantics

This section describes semantics and limitations specific to the `next-hop resolution ribs route-map NAME` command.

The use of a route-map to select a custom resolution profile allows for per-route granularity rather than an entire BGP address-family. The next-hop resolution semantics of a next-hop whose profile is set using a route-map are the same as the per-address family configuration. However, unlike in the per-address family configuration model, a route-map makes it possible to leave the resolution profile for a next-hop unspecified. **A next-hop for which the resolution profile is unspecified is left unresolved.** The following example illustrates this as well as the recommended configuration.

The profile below constrains the resolution of a subset of IPV4 unicast routes to only the system tunnel RIB:

```
ip prefix-list SUBSET 192.0.2.1/32 192.0.2.2/32 192.0.2.3/32
route-map TUNNEL_ONLY permit 10
 match ip next-hop prefix-list SUBSET
 set next-hop resolution ribs tunnel-rib system-tunnel-rib

router bgp 64512
 address-family ipv4
 next-hop resolution ribs route-map TUNNEL_ONLY
```

Note, however, that the **TUNNEL\_ONLY** route-map applies to *all IPV4 unicast routes*. Further, note that only routes whose next-hop value matches SUBSET will have a resolution profile set. **All other IPV4 unicast routes will have no resolution profile.** Any route without a resolution profile is left **unresolved**. This is often not intentional.

A more common use case is to allow the route's which do not match a given sequence to fallback to the system default resolution behavior. This can be achieved by adding a second sequence to the route-map with no match statements (matches all routes), and a single set statement which sets the default profile (see the [Default Resolution Profiles](#) section) for the given address family.

#### Example

```
ip prefix-list SUBSET 192.0.2.1/32 192.0.2.2/32 192.0.2.3/32
route-map TUNNEL_ONLY permit 10
 match ip next-hop prefix-list SUBSET
 set next-hop resolution ribs tunnel-rib system-tunnel-rib
route-map TUNNEL_ONLY permit 20
```

```

set next-hop resolution ribs tunnel-rib colored system-colored-tunnel-
rib tunnel-rib system-tunnel-rib system-unicast-rib

router bgp 64512
 address-family ipv4
 next-hop resolution ribs route-map TUNNEL_ONLY

```

This feature provides an explicit token to automatically fallback to the default resolution profile of whichever address family the route-map is applied:

```

ip prefix-list SUBSET 192.0.2.1/32 192.0.2.2/32 192.0.2.3/32
route-map TUNNEL_ONLY permit 10
 match ip next-hop prefix-list SUBSET
 set next-hop resolution ribs tunnel-rib system-tunnel-rib
route-map TUNNEL_ONLY permit 20
 set next-hop resolution ribs system-default

router bgp 64512
 address-family ipv4
 next-hop resolution ribs route-map TUNNEL_ONLY

```

#### 14.5.2.10.4 BGP L3VPNs: Next-hop Resolution ribs vrf-unicast-rib

This subfeature affects both the profile used to resolve BGP VPN routes as well as the VRF in which the route resolution takes place. With this feature disabled, or prior to ***EOS Release 4.22.0F***, imported VPN routes and is subject to the following restriction:

For each VPN route received from a neighbor, the route is imported (based on route-targets) and installed into the target VRF (import-vrf), **only if the nexthop of the route is resolvable via an MPLS tunnel in the default VRF.**

With this feature enabled, the above restriction is lifted, enabling a VPN route to be imported into the target VRF unconditionally. The plain IP unicast route is subsequently resolved using the unicast RIB of the target VRF.

 **Note:** With this feature enabled, no attempt is made to resolve the VPN route over an MPLS tunnel (even if one exists) in the default VRF. Therefore, the VPN routes received from a neighbor remains inactive in the default VRF.

To enable this feature, use the domain token **vrf-unicast-rib** under the IPV4 / IPV6 address family submodes:

```

switch(config-router-bgp-af) #next-hop resolution ribs vrf-unicast-rib

```

#### 14.5.2.10.4.Examples

To enable the vrf-unicast-rib feature:

```

router bgp 64512
 address-family vpn-ipv4
 next-hop resolution ribs vrf-unicast-rib

```

The following IPV4 VPN route has been received from a neighbor:

```

switch(config)#show bgp vpn-ipv4
BGP routing table information for VRF default
Router identifier 0.0.0.1, local AS number 300
Route status codes: s - suppressed, * - valid, > - active, # - not installed, E - ECMP head,
e - ECMP
 S - Stale, c - Contributing to ECMP, b - backup
 % - Pending BGP convergence
Origin codes: i - IGP, e - EGP, ? - incomplete

```

```
AS Path Attributes: Or-ID - Originator ID, C-LST - Cluster List, LL Nexthop - Link Local Nexthop
```

| Network             | Next Hop           | Metric | LocPref | Weight | Path      |
|---------------------|--------------------|--------|---------|--------|-----------|
| RD: 11.0.1.1:0 IPv4 | prefix 50.1.1.0/24 |        |         |        |           |
|                     | 42.42.42.42        | -      | 1       | 0      | 100 200 i |

The route is **inactive** in the default VRF.

Also, there is a VRF, **CUST-1**, where the VPN route (based on the route-targets) is imported. In the **CUST-1** VRF, the nexthop of the route is resolved via a static route to **42.42.42.42**. With this feature enabled, the VPN route is imported and installed in the VRF **CUST-1**:

```
switch(config)#show ip bgp vrf CUST-1
BGP routing table information for VRF CUST-1
Router identifier 11.0.0.1, local AS number 300
Route status codes: s - suppressed, * - valid, > - active, # - not installed, E - ECMP head,
e - ECMP
 S - Stale, c - Contributing to ECMP, b - backup, L - labeled-unicast
 % - Pending BGP convergence
Origin codes: i - IGP, e - EGP, ? - incomplete
AS Path Attributes: Or-ID - Originator ID, C-LST - Cluster List, LL Nexthop - Link Local
Nexthop
 Network Next Hop Metric LocPref Weight Path
* > 50.1.1.0/24 42.42.42.42 - 1 0 100 200 i
```

To confirm the route is installed in the VRF CUST-1, use the **show ip route** command:

```
switch(config)#show ip route vrf CUST-1
VRF: CUST-1
Codes: C - connected, S - static, K - kernel,
 O - OSPF, IA - OSPF inter area, E1 - OSPF external type 1,
 E2 - OSPF external type 2, N1 - OSPF NSSA external type 1,
 N2 - OSPF NSSA external type2, B I - iBGP, B E - eBGP,
 R - RIP, I L1 - IS-IS level 1, I L2 - IS-IS level 2,
 O3 - OSPFv3, A B - BGP Aggregate, A O - OSPF Summary,
 NG - Nexthop Group Static Route, V - VXLAN Control Service,
 DH - DHCP client installed default route, M - Martian,
 DP - Dynamic Policy Route
S 42.42.42.42/32 is directly connected, Null0
B I 50.1.1.0/24 is directly connected, Null0
```

The resolution profile used to resolve the next-hop can be seen using the **show rib next-hop** command. Note how the profile includes (only) the system-unicast-rib for **CUST-1**.

```
switch(config)#show rib next-hop ip vrf CUST-1 bgp detail
VRF: CUST-1, Protocol: bgp
Codes: * - Unresolved Next hop
 L - Part of a recursive route resolution loop
 A - Next hop not resolved in ARP/ND
11.0.1.1 [1 pref/0 metric] [ID: 18] type ipv4
Resolution RIBs: system-unicast-rib
via Null0, directly connected [ID 3]
```

#### 14.5.2.10.5 Viewing the BGP Nexthop Resolution Status

The following existing show commands which have been enhanced for this feature:

- **show route-msp NAME**
- **show bgp instance [vrf NAME]**
- **show rib next-hop {ip,ipv6}[PROTOCOL] detail**

**show route-map NAME**

Use the **show route-map NAME** command to display the new set statement:

```
switch(config)#show route-map
route-map foo permit 10
 Description:
 Match clauses:
 SubRouteMap:
 Set clauses:
 set next-hop resolution ribs tunnel-rib system-tunnel-rib
route-map foo permit 20
 Description:
 Match clauses:
 SubRouteMap:
 Set clauses:
 set next-hop resolution ribs tunnel-rib colored system-colored-
tunnel-rib tunnel-rib system-tunnel-rib system-unicast-rib

switch(config)#show route-map | json
{
 "routeMaps": {
 "foo": {
 "entries": {
 "20": {
 "setRules": {
 "resolutionRibProfileConfig": {
 "resolutionMethods": [
 {
 "ribType": "tunnel",
 "colored": true,
 "name": "system-colored-tunnel-rib"
 },
 {
 "ribType": "tunnel",
 "name": "system-tunnel-rib"
 },
 {
 "ribType": "ip",
 "name": "system-unicast-rib"
 }
]
 }
 }
 },
 "subRouteMap": {
 "name": "",
 "invert": false
 },
 "filterType": "permit",
 "matchRules": {},
 "description": []
 },
 "10": {
 "setRules": {
 "resolutionRibProfileConfig": {
 "resolutionMethods": [
 {
 "ribType": "tunnel",
 "name": "system-tunnel-rib"
 }
]
 }
 }
 }
 }
 }
}
```

```

 "subRouteMap": {
 "name": "",
 "invert": false
 },
 "filterType": "permit",
 "matchRules": {
 },
 "description": []
 }
}
}
},

```

### show bgp instance [vrf NAME]

Use the **show bgp instance** command to inspect the configured profiles and route-maps for each address family. The display output has been extended to show the resolution ribs as seen below, done so in order to display the resolution ribs used for EVPN and BGP Labeled-unicast address families. The output displays the resolution rib profile configuration for the respective address families.

#### Example

```

switch(config-router-bgp)#show bgp instance
BGP instance information for VRF default
...
Address family IPv4 MplsLabel:
 Additional-paths installation is disabled
 Convergence based update synchronization is disabled
 Target RIBs: Tunnel RIB
 Resolution RIBs: tunnel-rib system-tunnel-rib, system-connected
...
Address family IPv6 MplsLabel:
 Additional-paths installation is disabled
 Convergence based update synchronization is disabled
 Target RIBs: Tunnel RIB
 Resolution RIBs: tunnel-rib system-tunnel-rib, system-connected
...
Address family L2VPN EVPN:
 Additional-paths installation is disabled
 Convergence based update synchronization is disabled
 Vxlan Resolution RIBs: system-unicast-rib
 Mpls Resolution RIBs: tunnel-rib system-tunnel-rib, system-connected

```

Use the **show rib next-hop ip bgp** command to display the per-via resolution profile.

### show rib-next-hop {ip,ipv6} [proto] detail

Use the **show rib next-hop{ip,ipv6} [proto]detail** command to display which resolution profile is used to resolve each next-hop.

#### Example

```

switch#(config-router-bgp)#show rib next-hop ip bgp detail
VRF: default, Protocol: bgp
Codes: * - Unresolved Next hop
 L - Part of a recursive route resolution loop
 A - Next hop not resolved in ARP/ND
192.0.2.1 [110 pref/20 metric] [ID: 1] type ipv4
 Resolution RIBs: tunnel-rib colored system-colored-tunnel-rib, tunnel-
 rib system-tunnel-rib, system-unicast-rib
 via 198.51.100.1, Ethernet3 [ID: 10]

```

```

192.0.2.2 * [ID: 86]
 Resolution RIBs: No profile set for this next-hop
192.0.2.3 * [ID: 78]
 Resolution RIBs: tunnel-rib colored system-colored-tunnel-rib, tunnel-
rib system-tunnel-rib, system-connected

```

Note how **192.0.2.2** has no profile set, and is therefore unresolved. This show command illustrates this clearly with the **No profile set for this next-hop** message.

#### 14.5.2.10.6 User-defined Tunnel RIBs for NextHop Resolution

Currently, EOS generates a single system-defined tunnel RIB for the next-hop resolution. When tunnels to the same destination address are learned from multiple protocols, a fixed preference that is associated with each protocol is used to determine the winning tunnel.

However, with the User-defined tunnel RIBs feature the user is allowed to create user-defined tunnel RIBs with:

- Control over which protocols may contribute to the tunnel RIB.
- The ability to override the preference for all tunnels from a protocol to achieve non-default ordering of tunnels.
- The option to use it in a context where the system-defined tunnel RIB does not suffice.

#### Platform Compatibility

Resolution of LDP pseudowires over user-defined tunnel RIBs is available on all platforms supporting LDP pseudowires. The following platforms support LDP pseudowires:

- DCS-7500R
- DCS-7280R
- DCS-7500R2
- DCS-7280R2
- DCS-7020R
- DCS-7800R3
- DCS-7500R3
- DCS-7280R3

#### 14.5.2.10.6. Configuring User-defined Tunnel RIBs

A new **tunnel-ribs** configuration mode allows the creation of user-defined tunnel RIBs. For example, the following configuration creates a tunnel RIB with tunnels learned from IS-IS SR and LDP only, with IS-IS SR tunnels being preferred over LDP:

```

switch(config)#tunnel-ribs
switch(config-tunnel-ribs)#tunnel-rib SR_OVER_LDP
switch(config-tunnel-rib-SR_OVER_LDP)#source-protocol isis segment-routing
preference 10
switch(config-tunnel-rib-SR_OVER_LDP)#source-protocol ldp preference 20

```

When adding a source protocol in a user-defined tunnel RIB, the preference is optional. A lower preference value indicates a more preferred protocol. If the preference is not specified, the following system-defined preference values are used:

| Source protocol      | System-defined preference |
|----------------------|---------------------------|
| Static               | 15                        |
| Nexthop group tunnel | 25                        |
| RSVP LER             | 45                        |

| Source protocol | System-defined preference |
|-----------------|---------------------------|
| LDP             | 55                        |
| IS-IS SR        | 65                        |
| BGP-LU          | 85                        |

### Modifying the system-tunnel-rib

The user can explicitly modify the default preferences for the system-tunnel-rib as well as user-defined RIBs:

```

switch#(config)#tunnel-ribs
switch#(config-tunnel-ribs)#tunnel-rib system-tunnel-rib
switch#(config-tunnel-rib-system-tunnel-rib)#?
 source-protocol Configure the tunnel source

 comment Up to 240 characters, comment for this mode
 default Set a command to its defaults
 exit Leave Configure mode
 no Disable the command that follows
 show Display details of switch operation
 !! Append to comment

switch#(config-tunnel-rib-system-tunnel-rib)#source-protocol ?
 bgp BGP tunnel
 isis IS-IS tunnel
 ldp LDP tunnel
 nexthop-group Nexthop group tunnel
 rsvp-ler RSVP LER tunnel
 static Static tunnel

switch#(config-tunnel-rib-system-tunnel-rib)#source-protocol rsvp-ler
 preference 2
switch#(config-tunnel-rib-system-tunnel-rib)#exit
switch#(config-tunnel-ribs)#sh active all
tunnel-ribs
 tunnel-rib system-tunnel-rib
 source-protocol static
 source-protocol isis segment-routing
 source-protocol bgp labeled-unicast
 source-protocol nexthop-group
 source-protocol rsvp-ler preference 2
 source-protocol ldp

```

#### 14.5.2.10.6. Displaying Tunnel RIB Information

- Use the `show tunnel rib <name>` to display the user defined RIB information:

```

switch#show tunnel rib SR_OVER_LDP brief
Tunnel RIB: SR_OVER_LDP
Endpoint Tunnel Type Index(es) Tunnel Preference IGP
Preference IGP Metric

1.1.1.1/32 IS-IS SR IPv4 2 10 115
 20

```



- Use the `show tunnel rib brief` command to display the system-defined tunnel RIB information.

```
switch#show tunnel rib brief
Tunnel RIB: system-tunnel-rib
Endpoint Tunnel Type Index(es) Tunnel Preference IGP
Preference IGP Metric

1.1.1.1/32 LDP 1 55 1
0
```

- Use the `show active all` command to display the information about which source protocols contribute to the system-defined tunnel RIB.

```
switch(config)#tunnel-ribs
switch(config-tunnel-ribs)#tunnel-rib system-tunnel-rib
switch#(config-tunnel-ribs)#sh active all
tunnel-ribs
 tunnel-rib system-tunnel-rib
 source-protocol static
 source-protocol isis segment-routing
 source-protocol bgp labeled-unicast
 source-protocol nexthop-group
 source-protocol rsvp-ler
 source-protocol ldp
```

#### 14.5.2.11 Configuring BGP Confederations

BGP confederations allow you to break an autonomous system (AS) into multiple sub-ASs, and then to group the sub-ASs as a confederation. The sub-ASs exchange iBGP routing information (next-hop, local-preference and MED), but communicate via eBGP.

To configure a BGP confederation, complete the following tasks on each BGP device in the confederation.

- **Configure the local AS number:** the local AS number is the membership number in a sub-AS. BGP devices with the same local AS number are identified as members of the same sub-AS. BGP devices always use the local AS number when communicating with other BGP4 devices in the confederation.
- **Configure the confederation ID:** the confederation ID is the AS number for those BGP devices that are outside of the confederation. A BGP device outside the confederation is not aware that BGP devices are in multiple sub-ASs. The confederation ID must differ from the sub-AS numbers.
- **Configure the list of sub-AS numbers that are confederation members:** devices in a sub-AS exchange information via iBGP, while devices in different sub-ASs use eBGP.

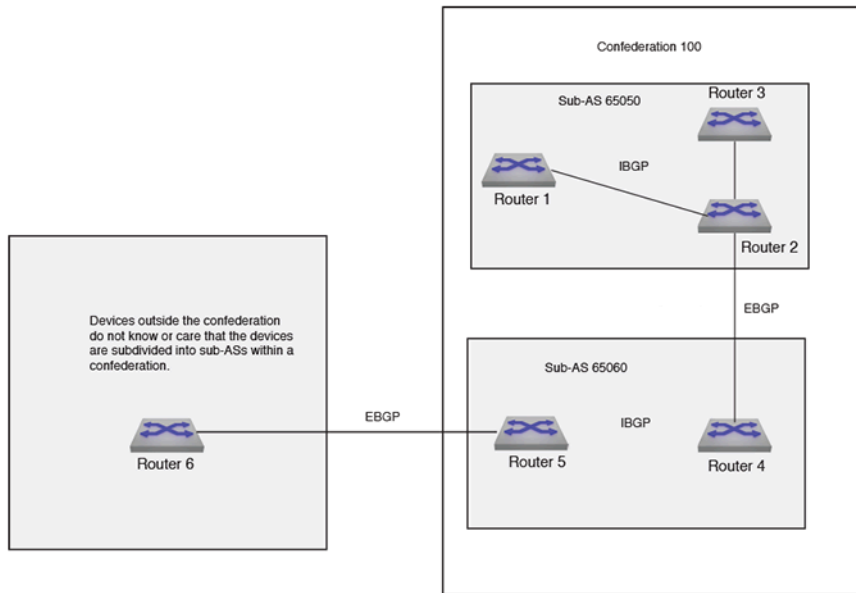

**Figure 56: BGP Confederation Example**

### Example

- The `router bgp` command enables BGP and configures the router in sub-autonomous system 65050. The `bgp confederation identifier` command specifies that confederation 65050 belongs to autonomous system 100.

The neighbors from other autonomous systems within the confederation are treated as special eBGP peers when using the `bgp confederation peers` command.

```
switch(config)#router bgp 65050
switch(config-router-bgp)#bgp confederation identifier 100
switch(config-router-bgp)#bgp confederation peers 65060
switch(config-router-bgp)#
```

- The Arista EOS will group the maximum ranges together. In this example, peers 65032 and 65036 are not included in BGP confederation 100.

```
switch(config)#router bgp 65050
switch(config-router-bgp)#bgp confederation identifier 100
switch(config-router-bgp)#bgp confederation peers 65060
switch(config-router-bgp)#no bgp confederation peers 65032, 65036
switch(config-router-bgp)#
```

### 14.5.2.12 Configuring BGP Flowspec

The BGP Flowspec address family is enabled on a per-peer basis with:

#### Example

```
switch(config)#router bgp id
switch(config-router-bgp)#address-family flow-spec [ipv4 | ipv6]
switch(config-router-bgp-af)#neighbor address activate
```

Flowspec has to be explicitly enabled on an interface, with:

**Example**

```
switch(config)#interface Ethernet1
switch(config-if-Et1)#flow-spec ipv4 ipv6
```

Currently, both IPv4 and IPv6 must be enabled together on the interface. A user defined TCAM profile, a feature introduced in ***EOS Release 4.20.5F***, must be configured for TCAM support for flowspec.

**Warning:** Creating user-defined TCAM profile on the Arista switch could cause serious issues that impact traffic. You should test flowspec policer with the profile given in this document. If you need to add new features in the profile, work with Arista's TAC team to define and test the new profile before deploying it on your production switches.

The ACL counters and Flowspec counters cannot be enabled simultaneously. To enable reporting of counters for flow-spec rules, use the following configuration:

**Example**

```
switch(config)#no hardware counter feature acl in
switch(config)#hardware counter feature flow-spec in
```

**14.5.2.12.1 Displaying Flowspec Information**

The BGP show commands have been enhanced to display the **flow-spec** content for both IPv4 and IPv6 address families:

**Example**

The **show bgp flow-spec ipv4 summary** command displays the count of flowspec rules received from each peer:

```
switch(config)#show bgp flow-spec ipv4 summary
BGP summary information for VRF default
Router identifier 0.0.0.1, local AS number 10
Neighbor Status Codes: m - Under maintenance
Neighbor V AS MsgRcvd MsgSent InQ OutQ Up/Down State RulesRcd
RulesAcc
10.0.0.2 4 10 12 4 0 0 00:02:18 Estab 2 2
10.0.1.2 4 10 6 4 0 0 00:02:18 Estab 0 0
```

The **show bgp flow-spec ipv4** displays a brief description of each flowspec rule, including the matching rule and actions. The matching rule uses a format:

**dest prefix; src prefix; [component:condition] +**

The component is abbreviated, for example, DP for destination port and IP for IP Protocol as shown in the following example. The detail of the show command will display the full component name.

The condition is expressed with logical operators. In the following example, **IP:=6|=17** matches any packets whose IP Protocol is 6 (TCP) or 17 (UDP). **DP:>1010&<1024** matches any packets whose destination port is greater than 1010 and less than 1024.

**Example**

```
switch(config)#show bgp flow-spec ipv4
```

```

BGP Flow Specification rules for VRF default
Router identifier 0.0.0.1, local AS number 10
Rule status codes: # - not installed, M - received from multiple
peers

 Matching Rule
Actions
 10.2.3.0/24;*;
Drop
 10.2.4.0/24;10.2.0.0/16;IP:=6|=17;DP:>1010&<1024;
Drop

```

The **show bgp flow-spec detail** displays the full details of each flowspec rule including the peer(s) it was received from, BGP properties, and an expanded description of the matching rule:

### Example

```

switch(config)#show bgp flow-spec ipv4 detail
BGP Flow Specification rules for VRF default
Router identifier 0.0.0.1, local AS number 10
BGP Flow Specification Matching Rule for 10.2.3.0/24;*;
Rule identifier: 3882065752
Matching Rule:
 Destination Prefix: 10.2.3.0/24
 Source Prefix: *
Paths: 1 available
Local
 from 10.0.0.2 (10.1.1.2)
 Origin IGP, metric -, localpref 100, weight 0, valid,
 internal, best
 Actions: Drop
BGP Flow Specification Matching Rule for 10.2.4.0/24;1
0.2.0.0/16;IP:=6|=17;DP:>1010&<1024;
Rule identifier: 3882090640
Matching Rule:
 Destination Prefix: 10.2.4.0/24
 Source Prefix: 10.2.0.0/16
 IP Protocol: =6 | =17
 Destination Port: >1010 & <1024
Paths: 1 available
Local
 from 10.0.0.2 (10.1.1.2)
 Origin IGP, metric -, localpref 100, weight 0, valid,
 internal, best
 Actions: Drop

```

The **show flow-spec ipv4 summary** command displays an overall status of how many flowspec rules were received and how many were installed:

### Example

```

switch(config)#show flow-spec ipv4 summary
Flow specification rules summary for VRF default
Total number of rules: 2

```

```
Number of installed rules: 2
```

The **show flow-spec ipv4** displays the installation status of the rule, and a counter of how many hits it has accumulated. This command also compiles the received flowspec rules into rules that can be programmed into the TCAM. For example, logical expressions on values such as the destination port are converted to ranges, as shown below:

### Example

```
switch(config)#show flow-spec ipv4
Flow specification rules for VRF default
Applied on: Ethernet47/1
 Flow-spec rule: 10.2.3.0/24;*;
 Rule identifier: 3882065752
 Matches:
 Destination prefix: 10.2.3.0/24
 Actions:
 Police: 80 Mbps (10 MBps)
 Redirect: VRF customer1
 Route via LDP tunnel index 4, MPLS label 100123
 Route via LDP tunnel index 1, MPLS label 116507
 Status:
 Installed: yes
 Counter: 312 packets
 Flow-spec rule: 10.2.4.0/24;10.2.0.0/16;IP:=6|=17;DP:>1
 010&<1024;
 Rule identifier: 3882090640
 Matches:
 Destination prefix: 10.2.4.0/24
 Source prefix: 10.2.0.0/16
 Next protocol: 17
 6
 Destination port: 1011-1023
 Actions:
 Police: 80 Mbps (10 MBps)
 Redirect: VRF customer1
 Route via LDP tunnel index 4, MPLS label 100123
 Route via LDP tunnel index 1, MPLS label 116507
 Status:
 Installed: yes
 Counter: 0 packets
```

Infeasible rules are detected and not programmed, and this status is reported using the **show flow-spec ipv4** command. Examples of the infeasible rules are:

- The **lt/gt/eq** operator is missing in the numerical opVal component.
- Co-existence of TCP flag component with ICMP type or code component in the same rule.
- Co-existence of port based component with ICMP type or code component in the same rule. For example, the default route in the specified VRF can be resolved over a GRE or MPLS tunnel. The following **show** command output verifies the resolution over the tunnel:

For redirect actions, additional information is displayed to show how it was resolved.

### Example

```
Actions:
 Redirect: VRF customer1
```

```
Route via LDP tunnel index 4, MPLS label 100123
Route via LDP tunnel index 1, MPLS label 116507
```

The specified **nexthop** in the flow-spec **redirect** action can be resolved by the respective VRFs IP RIB over MPLS or GRE tunnel, as shown in the following example:

#### Example

```
Actions:
 Redirect: VRF default, fc00:91:91:91::91
 Route via Static Interface tunnel index 1
```

### 14.5.2.13 Configuring BGP Logical OR of Multiple Community Lists

Adding the **or-results** token to the **match community** command allows you to do a logical OR between all provided community lists:

```
match community or-results COMMLIST1 COMMLIST2
match extcommunity or-results EXTCOMMLIST1 EXTCOMMLIST2
match large-community or-results LARGECOMMLIST1 LARGECOMMLIST2
```

Full configuration example:

- Enable the Multi-agent mode.

```
switch(config)#service routing protocols model multi-agent
```

- Create community lists (extended and large communities are also compatible with **or-results**).

```
switch(config)#ip community-list COMMLIST1 permit 1:1
switch(config)#ip community-list COMMLIST2 permit 2:2
```

- Configure Route-map with **or-results**.

```
switch(config)#route-map IN-POLICY
switch(config-route-map-IN-POLICY)#match community or-results
COMMLIST1 COMMLIST2
```

#### 14.5.2.13.1 Displaying BGP Logical OR Information

The **or-results** match clauses can be seen with the standard **show route-map <route-map name>** command, as shown in the following command display outputs.

```
switch#show route-map IN-POLICY
route-map IN-POLICY permit 10
 Description:
 Match clauses:
 match community or-results COMMLIST1 COMMLIST2
 SubRouteMap:
 Set clauses:
 set local-preference 500
route-map IN-POLICY permit 20
 Description:
 Match clauses:
 SubRouteMap:
```

Set clauses:

```
switch#show run | in 200.200.200.57
 neighbor 200.200.200.57 remote-as 300
 neighbor 200.200.200.57 update-source Loopback200
 neighbor 200.200.200.57 ebgp-multihop
 neighbor 200.200.200.57 route-map IN-POLICY in
 neighbor 200.200.200.57 maximum-routes 0
```

```
switch#show ip bgp community 1:1
BGP routing table information for VRF default
Router identifier 220.220.220.51, local AS number 200
Route status codes: s - suppressed, * - valid, > - active, # - not installed, E - ECMP head,
e - ECMP
 S - Stale, c - Contributing to ECMP, b - backup, L - labeled-unicast
 % - Pending BGP convergence
Origin codes: i - IGP, e - EGP, ? - incomplete
AS Path Attributes: Or-ID - Originator ID, C-LST - Cluster List, LL Nexthop - Link Local
Nexthop

Network Next Hop Metric LocPref Weight Path
* > 66.170.224.0/20 200.200.200.57 0 500 0 300 ?
* > 66.170.232.0/21 200.200.200.57 0 500 0 300 ?
* > 128.29.0.0/16 200.200.200.57 0 500 0 300 ?
```

```
switch#show ip bgp community 2:2
BGP routing table information for VRF default
Router identifier 220.220.220.51, local AS number 200
Route status codes: s - suppressed, * - valid, > - active, # - not installed, E - ECMP head,
e - ECMP
 S - Stale, c - Contributing to ECMP, b - backup, L - labeled-unicast
 % - Pending BGP convergence
Origin codes: i - IGP, e - EGP, ? - incomplete
AS Path Attributes: Or-ID - Originator ID, C-LST - Cluster List, LL Nexthop - Link Local
Nexthop

Network Next Hop Metric LocPref Weight Path
* > 192.12.24.0/24 200.200.200.57 0 500 0 300 ?
* > 192.47.242.0/24 200.200.200.57 0 500 0 300 ?
```

## 14.5.2.14 BGP Operational Commands

### 14.5.2.14.1 Shutdown

The `shutdown (BGP)` command disables BGP operations without disrupting the BGP configuration. The `no router bgp` command disables BGP and removes the BGP configuration.

The `no shutdown (BGP)` command resumes BGP activity.

#### Examples

- This command disables BGP activity on the switch.

```
switch(config-router-bgp)#shutdown
switch(config-router-bgp)#
```

- This command resumes BGP activity on the switch.

```
switch(config-router-bgp)#no shutdown
switch(config-router-bgp)#
```

## 14.5.2.14.2 Clearing the Routing Table and Resetting BGP Sessions

When entered without parameters, the `clear ip bgp` command clears all BGP learned routes from the routing table, reads routes from designated peers, and sends routes required by those peers. Routes that are read or sent are processed through any modified route map or AS-path access list.

Followed by an asterisk (\*), it clears the BGP sessions with all BGP peers. To reset the session with a specific peer, enter the peer's IP address at the end of the command.

### Example

- This command removes all BGP learned routes from the routing table.

```
switch#clear ip bgp
switch#
```

## 14.5.3 BGP Examples

This section shows example configurations and topologies for iBGP (Example 1) and eBGP (s).

### 14.5.3.1 BGP Example 1

Example 1 features an internal BGP (iBGP) link that connects peers in AS 100.

#### 14.5.3.1.1 BGP Example 1 Diagram

Figure 57: BGP Example 1 displays an iBGP connection, linking neighbors within AS 100. Each switch advertises two subnets. In UPDATE packets sent by Switch A, the LOCAL\_PREF field is 150. In UPDATE packets sent by Switch B, the LOCAL\_PREF field is 75.

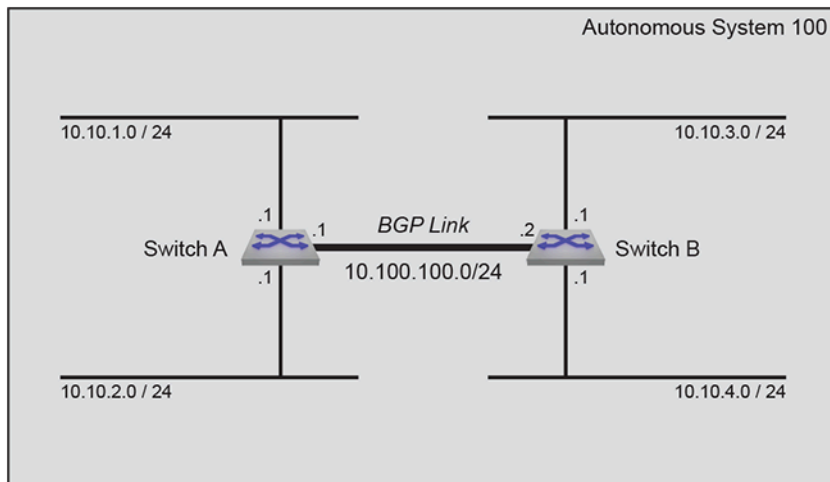

Figure 57: BGP Example 1

#### 14.5.3.1.2 BGP Example 1 Code

This code configures the Example 1 BGP instance on both switches.

1. Configure the neighbor addresses.
  - a. Specify the neighbor to Switch A.

```
switchA(config)#router bgp 100
```



```
switchA(config-router-bgp)#neighbor 10.100.100.2 remote-as 100
```

- b. Specify the neighbor to Switch B.

```
switchB(config)#router bgp 100
switchB(config-router-bgp)#neighbor 10.100.100.1 remote-as 100
```

2. Configure the routes to be advertised.

- a. Advertise Switch A's routes.

```
switchA(config-router-bgp)#network 10.10.1.0/24
switchA(config-router-bgp)#network 10.10.2.0/24
```

- b. Advertise Switch B's routes.

```
switchB(config-router-bgp)#network 10.10.3.0/24
switchB(config-router-bgp)#network 10.10.4.0/24
```

3. Configure the LOCAL\_PREF.

- a. Configure LOCAL\_PREF on Switch A.

```
switchA(config-router-bgp)#neighbor 10.100.100.2 export-localpref 150
```

- b. Configure LOCAL\_PREF on Switch B.

```
switchB(config-router-bgp)#neighbor 10.100.100.2 export-localpref 75
```

4. Modify the hold time and keepalive interval.

- a. Configure timers on Switch A.

```
switchA(config-router-bgp)#timer bgp 30 90
```

- b. Configure timers on Switch B.

```
switchB(config-router-bgp)#timer bgp 30 90
```

### 14.5.3.2 BGP Example 2

Example 2 creates an external BGP (eBGP) link that connects routers in AS 100 and AS 200.

#### 14.5.3.2.1 BGP Example 2 Diagram

[Figure 58: BGP Example 2](#) displays an eBGP connection, linking Switch A in AS 100 to Switch B in AS 200. Each switch advertises two subnets.

Switch A assigns a local preference of 150 to networks advertised by Switch B. Switch B assigns a local preference of 75 to networks advertised by Switch A.

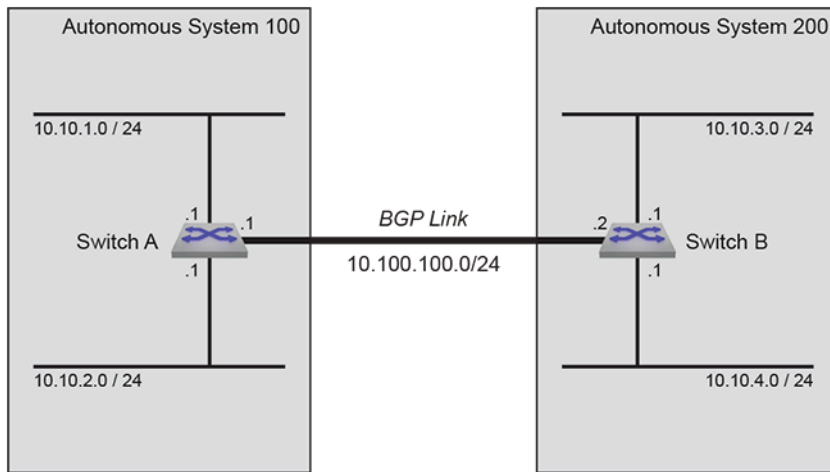

Figure 58: BGP Example 2

### 14.5.3.2.2 BGP Example 2 Code

This code configures the Example 2 BGP instance on both switches.

1. Configure the neighbor addresses.

a. Specify the neighbor to Switch A.

```
switchA(config)#router bgp 100
switchA(config-router-bgp)#neighbor 10.100.100.2 remote-as 200
```

b. Specify the neighbor to Switch B.

```
switchB(config)#router bgp 200
switchB(config-router-bgp)#neighbor 10.100.100.1 remote-as 100
```

2. Configure the routes to be advertised.

a. Advertise Switch A's routes.

```
switchA(config-router-bgp)#network 10.10.1.0/24
switchA(config-router-bgp)#network 10.10.2.0/24
```

b. Advertise Switch B's routes.

```
switchB(config-router-bgp)#network 10.10.3.0/24
switchB(config-router-bgp)#network 10.10.4.0/24
```

3. Configure the LOCAL\_PREF.

a. Configure LOCAL\_PREF on Switch A.

```
switchA(config-router-bgp)#neighbor 10.100.100.2 import-localpref 150
```

b. Configure LOCAL\_PREF on Switch B.

```
switchB(config-router-bgp)#neighbor 10.100.100.2 import-localpref 75
```

**4. Modify the hold time and keepalive interval.****a. Configure timers on Switch A.**

```
switchA(config-router-bgp)#timer bgp 30 90
```

**b. Configure timers on Switch B.**

```
switchB(config-router-bgp)#timer bgp 30 90
```

---

## 14.5.4 BGP Commands

### Global Configuration Commands

- ip as-path access-list
- ip as-path regex-mode
- ip community-list
- ip community-list regexp
- ip extcommunity-list
- ip extcommunity-list regexp
- ip large-community-list regexp
- router bgp

### Router General Command

- rib fib fec ecmp ordered

### Router-BGP Configuration Mode (Includes Address-Family Mode)

- address-family
- address-family flow-spec
- aggregate-address
- bgp advertise-inactive
- bgp always-compare-med
- bgp bestpath as-path ignore
- bgp bestpath as-path multipath-relax
- bgp bestpath ecmp-fast
- bgp bestpath med confed
- bgp bestpath med missing-as-worst
- bgp bestpath tie-break cluster-list-length
- bgp bestpath tie-break router-id
- bgp client-to-client reflection
- bgp cluster-id
- bgp confederation identifier
- bgp confederation peers
- bgp convergence slow-peer time
- bgp convergence time
- bgp default
- bgp enforce-first-as
- bgp listen range
- bgp log-neighbor-changes
- bgp redistribute-internal (BGP)
- bgp route install-map
- bgp route-reflector preserve-attributes
- distance bgp
- dynamic peer max
- graceful-restart stalepath-time
- graceful-restart-helper
- match as-range
- maximum paths (BGP)

- neighbor activate
- no neighbor
- neighbor allowas-in
- neighbor auto-local-addr
- neighbor default-originate
- neighbor description
- neighbor ebgp-multihop
- neighbor enforce-first-as
- neighbor export-localpref
- neighbor graceful-restart
- neighbor graceful-restart-helper
- neighbor import-localpref
- neighbor local-as
- neighbor local-v4-addr
- neighbor local-v6-addr
- neighbor maximum-routes
- neighbor next-hop-peer
- neighbor next-hop-self
- neighbor out-delay
- neighbor passive
- neighbor password
- neighbor peer group (create)
- neighbor peer group (neighbor assignment)
- neighbor remote-as
- neighbor remove-private-as
- neighbor rib-in pre-policy retain
- neighbor route-map (BGP)
- neighbor route-reflector-client
- neighbor route-to-peer
- neighbor send-community
- neighbor send-community add / remove
- neighbor send-community link-bandwidth
- neighbor shutdown
- neighbor timers
- neighbor ttl maximum-hops
- neighbor update-source
- neighbor weight
- network (BGP)
- peer-filter
- rd (Router-BGP VRF and VNI Configuration Modes)
- redistribute (BGP)
- router-id (BGP)
- shutdown (BGP)
- timers bgp
- update wait-for-convergence
- vrf

#### **Route Map Configuration Mode**

- set as-path match

---

### Clear Commands Privileged EXEC Mode

- clear bgp history
- clear ip bgp
- clear ip bgp neighbor \*
- clear ipv6 bgp
- clear ipv6 bgp neighbor \*

### Display Commands EXEC Mode

- show bgp convergence
- show bgp flow-spec
- show bgp instance
- show bgp labeled-unicast tunnel
- show bgp neighbors history
- show flow-spec
- show ip as-path access-list
- show ip bgp
- show ip bgp community
- show ip bgp installed
- show ip bgp neighbors
- show ip bgp neighbors (route type)
- show ip bgp neighbors (route-type) community
- show ip bgp neighbors regexp
- show ip bgp not-installed
- show ip bgp paths
- show ip bgp peer-group
- show ip bgp regexp
- show ip bgp summary
- show bgp neighbors history
- show ip community-list
- show ip extcommunity-list
- show ipv6 bgp
- show ipv6 bgp match community
- show ipv6 bgp peers
- show ipv6 bgp peers (route type)
- show ipv6 bgp peers (route type) community
- show ipv6 bgp peers regexp
- show ipv6 bgp regexp
- show ipv6 bgp summary
- show peer-filter
- show tunnel rib brief

### 14.5.4.1 address-family

The **address-family** command places the switch in address-family configuration mode to configure the address family setting of addresses configured as BGP neighbors. Address-family configuration mode is not a group change mode; **running-config** is changed immediately after commands are executed. The **exit** command does not affect the configuration.

The switch supports these address families:

- ipv4-unicast
- ipv6-unicast

**Running-config** displays **address-family** commands in sub-blocks of the BGP configuration. The following commands are available in address family configuration mode:

- **neighbor activate** configures the address as active in the configuration mode address family.
- **no neighbor activate** configures the address as not active in the configuration mode address family.
- **neighbor default-originate** advertises a default route to the specified BGP neighbor.
- **neighbor route-map (BGP)** applies a route map to the specified BGP route.
- **network (BGP)** specifies a network for advertisement through UPDATE packets to BGP peers.

The **no address-family** and **default address-family** commands delete the specified address family from **running-config** by removing all commands previously configured in the corresponding address-family mode.

The **exit** command returns the switch to router-BGP configuration mode.

#### Command Mode

Router-BGP Configuration

#### Command Syntax

```
bgp ipv4|ipv6
```

```
no bgp ipv4|ipv6
```

```
default bgp ipv4|ipv6
```

#### Parameters

- ipv4 subsequent commands are applied to the IPv4 unicast address family.
- ipv6 subsequent commands are applied to the IPv6 unicast address family.

#### Example

- These commands enter address family mode for IPv6-unicast, insert a command, then exit the mode:

```
switch(config)#router bgp 1
switch(config-router-bgp)#address-family ipv6
switch(config-router-bgp-af)#neighbor 172.10.1.1 activate
switch(config-router-bgp-af)#exit
switch(config-router-bgp)#
```

---

#### 14.5.4.2 address-family flow-spec

Use the **address-family flow-spec** command to filter or redirect DDoS traffic on edge routers. The **no** and **default** versions of the command removes the filter to redirect the DDoS traffic.

##### Command Mode

BGP router configuration mode (config-router-bgp)

##### Command Syntax

```
address-family flow-spec [ipv4 | ipv6]
```

```
no address-family flow-spec [ipv4 | ipv6]
```

```
default address-family flow-spec [ipv4 | ipv6]
```

##### Parameters

- **ipv4** IPv4 flow specifications.
- **ipv6** IPv6 flow specifications.

##### Example

- The BGP Flowspec address family is enabled on a per-peer basis with:

```
switch(config)#router bgp id
switch(config-router-bgp)#address-family flow-spec [ipv4|ipv6]
switch(config-router-bgp-af)#neighbor address activate
```



### 14.5.4.3 aggregate-address

The **aggregate-address** command creates an aggregate route in the Border Gateway Protocol (BGP) database. Aggregate routes combine the characteristics of multiple routes into a single route that the switch advertises. Aggregation can reduce the amount of information that a BGP speaker is required to store and transmit when advertising routes to other BGP speakers. Aggregate routes are advertised only after they are redistributed.

The advertised address of the aggregate is entered as an IP subnet; any routes configured on the switch that lie within that subnet then become contributors to the aggregate. Note that on Arista switches the BGP aggregate route will become active if there are any available contributor routes on the switch, regardless of the originating protocol. This includes routes configured statically.

 **Note:** Aggregate routes are redistributed automatically, and their redistribution cannot be disabled.

Command options affect the attributes associated with the aggregated route, the advertisement of the contributor routes that comprise the aggregate, and which contributor routes are included.

Command options affect the following aggregate routing attributes:

- **AS\_PATH attribute inclusion:** the `as-set` option controls the aggregate route's `AS_PATH` and `ATOMIC_AGGREGATE` attribute contents. `AS_PATH` identifies the autonomous systems through which UPDATE message routing information passes. `ATOMIC_AGGREGATE` indicates that the route is an aggregate or summary of more specific routes.

When the command includes `as-set`, the aggregate route's `AS_SET` attribute contains the AS numbers of contributor routes. This can help BGP neighbors to prevent loops by rejecting aggregate routes that include their AS number in the `AS_SET`.

When the command does not include `as-set`, the aggregate route's `ATOMIC_AGGREGATE` attribute is set and the aggregate route `AS_PATH` will include the longest leading `PATH_SEQ` of the `AS_PATH` which is common to all contributor routes. For example, for the aggregate `1.0.0.0/16` with two contributors present, the `AS_PATH` for the aggregate is "100 200" as shown.

#### Aggregate

```
1.0.0.0/16 as-path ??
```

#### Contributors

```
1.0.1.0/24 as-path "100 200 400 500"
```

```
1.0.2.0/24 as-path "100 200 300"
```

- **Attribute assignment:** the `attribute-map` option assigns attributes contained in set commands in a specified route map's lowest sequence with any set command to the aggregated route, overriding the automatic determination of the aggregate route's attributes by the switch.
- **Route suppression:** the `summary-only` option suppresses the advertisement of the contributor routes that comprise the aggregate.
- **Contributor filtering:** the `match-map` option uses a route map to filter out contributor routes that would otherwise be included in the aggregate.

The `no aggregate-address` and `default aggregate-address` commands remove the corresponding `aggregate-address` command from *running-config*.

#### Command Mode

Router-BGP Configuration

#### Command Syntax

```
aggregate-address AGGREGATE_NET [AS_SET][SUMMARY][ATTRIBUTE_MAP][MATCH_MAP]
```

```
no aggregate-address AGGREGATE_NET
```

---

```
default aggregate-address AGGREGATE_NET
```

### Parameters

- AGGREGATE\_NET aggregate route IP address. Options include:
  - *netv4\_addr* IPv4 subnet address (CIDR or address-mask notation).
  - *netv6\_addr* IPv6 subnet address (CIDR notation).
- AS\_SET controls AS\_PATH attribute values associated with aggregate route. Options include:
  - <no parameter> ATOMIC\_AGGREGATE attribute is set. Route contains no AS\_PATH data.
  - as-set route includes AS\_PATH information from contributor routes as AS\_SET attributes.
- SUMMARY controls advertisement of contributor routes. Options include:
  - <no parameter> contributor and aggregate routes are advertised.
  - summary-only contributor routes are not advertised.
- ATTRIBUTE\_MAP controls attribute assignments to the aggregate route. Options include:
  - <no parameter> attribute values are not assigned to route.
  - attribute-map *map\_name* assigns attribute values in set commands of the map's permit clauses. Deny clauses and match commands in permit clauses are ignored.
- MATCH\_MAP filters contributors to the aggregate route. Options include:
  - <no parameter> no contributors are filtered.
  - **match-map** *map\_name* filters contributor routes using the named match-map.

### Examples

- These commands create an aggregate route (10.16.48.0/20) from the contributor routes 10.16.48.0/23, 10.16.50.0/23, 10.16.52.0/23, and 10.16.54.0/23. The aggregate route includes the AS\_PATH information from the contributor routes.

```
switch(config)#router bgp 1
switch(config-router-bgp)#aggregate-address 10.16.48.0/20 as-set
switch(config-router-bgp)#exit
switch(config)#
```

- These commands create an aggregate route and use a route map to add a local-preference attribute to the route.

```
switch(config)#route-map map1 permit 10
switch(config-route-map-map1)#set community 45
switch(config-route-map-map1)#exit
switch(config)#router bgp 1
switch(config-router-bgp)#aggregate-address 10.16.48.0/20 attribute-map
map1
switch(config-router-bgp)#exit
switch(config)#
```

- These commands create an aggregate route and use a route map to allow only those contributors which match a specified prefix list to be included in the aggregate route.

```
switch(config)#route-map matchmap permit 10
switch(config-route-map-matchmap)#match ip address prefix-list agglist
switch(config-route-map-matchmap)#exit
switch(config)#router bgp 1
switch(config-router-bgp)#aggregate-address 1.1.0.0/16 match-map
matchmap
switch(config-router-bgp)#
```

#### 14.5.4.4 **bgp advertise-inactive**

By default, BGP will advertise only those routes that are active in the switch's RIB. This can contribute to dropped traffic. If a preferred route is available through another protocol (like OSPF), the BGP route will become inactive and not be advertised; if the preferred route is lost, there is no available route to the affected peers. Advertising inactive BGP routes minimizes traffic loss by providing alternative routes.

The **bgp advertise-inactive** command configures BGP to advertise inactive routes to BGP neighbors. Inactive route advertisement is configured globally, but the global setting can be overridden on a per-VRF basis.

The **no bgp advertise-inactive** and **default bgp advertise-inactive** commands restore the default BGP behavior (advertising only active routes) by removing the corresponding **bgp advertise-inactive** command from *running-config*.

##### **Command Mode**

Router-BGP Configuration

##### **Command Syntax**

```
bgp advertise-inactive
no bgp advertise-inactive
default bgp advertise-inactive
```

##### **Example**

- These commands configure BGP to advertise inactive routes.

```
switch(config)#router bgp 64500
switch(config-router-bgp)#bgp advertise-inactive
switch(config-router-bgp)#
```

---

### 14.5.4.5 `bgp always-compare-med`

The `bgp always-compare-med` command configures the switch to always consider multi-exit discriminator (MED) values (also known as “metric”) in best-path selection. By default, this function is disabled, and MED values are compared only if two paths have the same neighbor AS.

When there are two or more links between autonomous systems, MED values may be set by a router in the originating AS to give preferences to certain routes. In comparing MED values, the lower value is preferred.

The `no bgp always-compare-med` and `default bgp always-compare-med` commands restore the default behavior of comparing MED values only on paths with the same neighbor AS.

#### Command Mode

Router-BGP Configuration

#### Command Syntax

```
bgp always-compare-med
no bgp always-compare-med
default bgp always-compare-med
```

#### Related Commands

- `bgp bestpath as-path ignore`
- `bgp bestpath as-path multipath-relax`
- `bgp bestpath ecmp-fast`
- `bgp bestpath med confed`
- `bgp bestpath med missing-as-worst`
- `bgp bestpath tie-break cluster-list-length`
- `bgp bestpath tie-break router-id`

#### Example

- These commands configure BGP to always consider MED values in best-path comparisons.

```
switch(config)#router bgp 64500
switch(config-router-bgp)#bgp always-compare-med
switch(config-router-bgp)#
```

#### 14.5.4.6 `bgp bestpath as-path ignore`

The `bgp bestpath as-path ignore` command configures BGP to ignore the length of the autonomous system (AS) path when comparing routes. This behavior is disabled by default. Normally, the switch compares AS paths as the third step in the best-path selection process (see [Best-Path Selection](#)), preferring the route with the shorter AS path.

The `no bgp bestpath as-path ignore` and `default bgp bestpath as-path ignore` commands restore the default behavior of considering AS path length in route comparisons.

##### Command Mode

Router-BGP Configuration

##### Command Syntax

```
bgp bestpath as-path ignore
no bgp bestpath as-path ignore
default bgp bestpath as-path ignore
```

##### Related Commands

- `bgp always-compare-med`
- `bgp bestpath as-path multipath-relax`
- `bgp bestpath ecmp-fast`
- `bgp bestpath med confed`
- `bgp bestpath med missing-as-worst`
- `bgp bestpath tie-break cluster-list-length`
- `bgp bestpath tie-break router-id`

##### Example

- These commands configure BGP to ignore AS path lengths when comparing routes.

```
switch(config)#router bgp 64500
switch(config-router-bgp)#bgp bestpath as-path ignore
switch(config-router-bgp)#
```

---

#### 14.5.4.7 bgp bestpath as-path multipath-relax

The **bgp bestpath as-path multipath-relax** command allows multiple eBGP routes to a destination to be considered equal in ECMP if their AS paths are the same length despite having different autonomous systems in those paths. The **no bgp bestpath as-path multipath-relax** command configures best-path selection to consider two paths *unequal* if their AS path contents are different, and prefers the first path received.

Multipath-relax is enabled by default. The **bgp bestpath as-path multipath-relax** and **default bgp bestpath as-path multipath-relax** commands restore the default behavior by removing the corresponding **no bgp bestpath as-path multipath-relax** command from *running-config*.

For BGP to support equal cost multipath (ECMP) routing, the `maximum paths (BGP)` command must be issued in router-BGP configuration mode.

##### Command Mode

Router-BGP Configuration

##### Command Syntax

```
bgp bestpath as-path multipath-relax
no bgp bestpath as-path multipath-relax
default bgp bestpath as-path multipath-relax
```

##### Related Commands

- `bgp always-compare-med`
- `bgp bestpath as-path ignore`
- `bgp bestpath ecmp-fast`
- `bgp bestpath med confed`
- `bgp bestpath med missing-as-worst`
- `bgp bestpath tie-break cluster-list-length`
- `bgp bestpath tie-break router-id`

##### Example

- These commands configure BGP best-path selection to consider routes unequal if the contents of their AS paths differ.

```
switch(config)#router bgp 64500
switch(config-router-bgp)#no bgp bestpath as-path multipath-relax
switch(config-router-bgp)#
```

### 14.5.4.8 bgp bestpath ecmp-fast

By default, within an ECMP group the BGP best-path selection process prefers the active path (the first path received by the switch) unless a relevant tie-breaker is enabled. The **no bgp bestpath ecmp-fast** command causes the best-path selection process to ignore order of arrival and continue evaluating paths on other criteria.

The **bgp bestpath ecmp-fast** and **default bgp bestpath ecmp-fast** commands restore the default behavior by removing the corresponding **no bgp bestpath ecmp-fast** command from *running-config*.

#### Command Mode

Router-BGP Configuration

#### Command Syntax

```
bgp bestpath ecmp-fast
no bgp bestpath ecmp-fast
default bgp bestpath ecmp-fast
```

#### Related Commands

- [bgp always-compare-med](#)
- [bgp bestpath as-path ignore](#)
- [bgp bestpath as-path multipath-relax](#)
- [bgp bestpath med confed](#)
- [bgp bestpath med missing-as-worst](#)
- [bgp bestpath tie-break cluster-list-length](#)
- [bgp bestpath tie-break router-id](#)

#### Example

- These commands configure BGP to ignore order of arrival in best-path comparisons of paths within an ECMP group.

```
switch(config)#router bgp 64500
switch(config-router-bgp)#no bgp bestpath ecmp-fast
switch(config-router-bgp)#
```

### 14.5.4.9 bgp bestpath med confed

By default, paths originating within the same confederation as the switch and received from confederation peers do not have their multi-exit discriminator (MED) values compared as part of the best-path selection process. The `bgp bestpath med confed` command causes comparison of MED values in such routes. To ensure that MED values are considered in the best-path selection process for all routes received, use the `bgp always-compare-med` command.

The `no bgp bestpath med confed` and `default bgp bestpath med confed` commands restore the default behavior by removing the corresponding `bgp bestpath ecmp-fast` command from *running-config*.

#### Command Mode

Router-BGP Configuration

#### Command Syntax

```
bgp bestpath med confed [missing-as-worst]
no bgp bestpath med confed [missing-as-worst]
default bgp bestpath med confed [missing-as-worst]
```

#### Related Commands

- `bgp always-compare-med`
- `bgp bestpath as-path ignore`
- `bgp bestpath as-path multipath-relax`
- `bgp bestpath ecmp-fast`
- `bgp bestpath med missing-as-worst`
- `bgp bestpath tie-break cluster-list-length`
- `bgp bestpath tie-break router-id`

#### Parameters

- missing as worst By default, best-path selection considers a missing MED value to be 0, so paths with missing MED values will be preferred. This option reverses the behavior in comparisons of routes originating within the same confederation as the switch, treating a missing MED as having the highest (least preferred) value.



**Note:** The `bgp bestpath med missing-as-worst` command controls how best-path selection treats missing MED values for all routes received, and, if configured, overrides the `missing-as-worst` option of this command.

#### Example

- These commands configure the BGP best-path selection process to consider MED values in comparisons between routes originating within the same confederation as the switch.

```
switch(config)#router bgp 64500
switch(config-router-bgp)#bgp bestpath med confed
switch(config-router-bgp)#
```



### 14.5.4.10 bgp bestpath med missing-as-worst

By default, BGP best-path selection considers a missing MED value to be 0, so paths with missing MED values will be preferred. The `bgp bestpath med missing-as-worst` command reverses the behavior, treating a missing MED as having the highest (least preferred) value.

The `no bgp bestpath med missing-as-worst` and `default bgp bestpath med missing-as-worst` commands restore the default behavior (giving preference to missing MED values) by removing the corresponding `bgp bestpath med missing-as-worst` command from *running-config*.



**Note:** This command overrides the missing-as-worst setting of the `bgp bestpath med confed` command.

#### Command Mode

Router-BGP Configuration

#### Command Syntax

```
bgp bestpath med missing-as-worst
no bgp bestpath med missing-as-worst
default bgp bestpath med missing-as-worst
```

#### Related Commands

- `bgp always-compare-med`
- `bgp bestpath as-path ignore`
- `bgp bestpath as-path multipath-relax`
- `bgp bestpath ecmp-fast`
- `bgp bestpath med confed`
- `bgp bestpath tie-break cluster-list-length`
- `bgp bestpath tie-break router-id`

#### Example

- These commands configure the BGP best-path selection process to consider a missing MED value to be considered highest (least preferred) in MED comparisons for all routes received.

```
switch(config)#router bgp 64500
switch(config-router-bgp)#bgp bestpath med missing-as-worst
switch(config-router-bgp)#
```

---

#### 14.5.4.11 bgp bestpath tie-break cluster-list-length

The **bgp bestpath tie-break cluster-list-length** command causes the best-path selection process to prefer the multipath route with the shortest CLUSTER\_LIST length in case of a tie in step 10. The cluster list length is assumed to be 0 if the route doesn't carry a CLUSTER\_LIST attribute.

The **no bgp bestpath tie-break cluster-list-length** and **default bgp bestpath tie-break cluster-list-length** commands restore the default behavior by removing the associated **bgp bestpath tie-break cluster-list-length** command from *running-config*.

##### Command Mode

Router-BGP Configuration

##### Command Syntax

```
bgp bestpath tie-break cluster-list-length
```

```
no bgp bestpath tie-break cluster-list-length
```

```
default bgp bestpath tie-break cluster-list-length
```

##### Related Commands

- [bgp always-compare-med](#)
- [bgp bestpath as-path ignore](#)
- [bgp bestpath as-path multipath-relax](#)
- [bgp bestpath ecmp-fast](#)
- [bgp bestpath med confed](#)
- [bgp bestpath med missing-as-worst](#)
- [bgp bestpath tie-break router-id](#)

##### Example

- These commands configure the BGP selection process to prefer the multipath route with the shortest CLUSTER\_LIST length in case of a tie.e

```
switch(config)#router bgp 64500
switch(config-router-bgp)#bgp bestpath tie-break cluster-list-length
switch(config-router-bgp)#
```

#### 14.5.4.12 bgp bestpath tie-break router-id

The **bgp bestpath tie-break router-id** command causes the best-path selection process to prefer the multipath route with the lowest ROUTER\_ID in case of a tie in step 10. If the route is a reflected route (i.e., if it contains route reflector attributes), the process will use the ORIGINATOR\_ID as the ROUTER\_ID for comparison. This behavior is disabled by default.

The **no bgp bestpath tie-break router-id** and **default bgp bestpath tie-break router-id** commands restore the default behavior by removing the associated **bgp bestpath tie-break router-id** command from *running-config*.

##### Command Mode

Router-BGP Configuration

##### Command Syntax

```
bgp bestpath tie-break router-id
no bgp bestpath tie-break router-id
default bgp bestpath tie-break router-id
```

##### Related Commands

- [bgp always-compare-med](#)
- [bgp bestpath as-path ignore](#)
- [bgp bestpath as-path multipath-relax](#)
- [bgp bestpath ecmp-fast](#)
- [bgp bestpath med confed](#)
- [bgp bestpath med missing-as-worst](#)
- [bgp bestpath tie-break cluster-list-length](#)

##### Example

- These commands configure the best-path selection process to prefer the multipath route with the lowest ROUTER\_ID in case of a tie.

```
switch(config)#router bgp 64500
switch(config-router-bgp)#bgp bestpath tie-break router-id
switch(config-router-bgp)#
```

---

### 14.5.4.13 bgp client-to-client reflection

By default, routes received from a route reflector client and selected as best routes are propagated to all BGP peers, including other route reflector clients. If the clients are fully meshed, however, routes received from a client do not need to be mirrored to other clients. In this case, client-to-client reflection should be disabled.

The `no bgp client-to-client reflection` command disables client-to-client reflection.

The `bgp client-to-client reflection` and `default bgp client-to-client reflection` commands restore the default behavior by removing the `no bgp client-to-client reflection` command from *running-config*.

#### Command Mode

Router-BGP Configuration

#### Command Syntax

```
bgp client-to-client reflection
no bgp client-to-client reflection
default bgp client-to-client reflection
```

#### Example

- These commands disable client-to-client reflection on the switch.

```
switch(config)#router bgp 1
switch(config-router-bgp)#no bgp client-to-client reflection
switch(config-router-bgp)#
```

#### 14.5.4.14 bgp cluster-id

When using route reflectors, an AS is divided into clusters. A cluster consists of one or more route reflectors and a group of clients to which they re-advertise route information, and for redundancy a single cluster may contain multiple route reflectors. Each route reflector has a cluster ID. If the cluster has only one route reflector the cluster ID is its router ID, but if a cluster has multiple route reflectors a 4-byte cluster ID must be assigned to all route reflectors in the cluster. All must be configured with the same cluster ID to allow them to identify updates from the cluster's other route reflectors.

The **bgp cluster-id** command configures the cluster ID in a cluster with multiple route reflectors.

The **no bgp cluster-id** and **default bgp cluster-id** commands remove the cluster ID by removing the corresponding **bgp cluster-id** command from *running-config*. Do not remove the cluster ID if there are multiple route reflectors in the cluster.

##### Command Mode

Router-BGP Configuration

##### Command Syntax

```
bgp cluster-id ID_NUM
no bgp cluster-id
default bgp cluster-id
```

##### Parameters

- ID\_NUM cluster ID shared by all route reflectors in the cluster (32-bit dotted-decimal notation). Options include:
  - **0.0.0.1 to 255.255.255.255** valid cluster ID number.
  - **0.0.0.0** removes the cluster-ID from the switch. Equivalent to **no bgp cluster-id** command.

##### Example

- This command sets the cluster ID for the switch to 172.22.30.101.

```
switch(config)#router bgp 1
switch(config-router-bgp)#bgp cluster-id 172.22.30.101
switch(config-router-bgp)#
```

---

#### 14.5.4.15 bgp confederation identifier

The **bgp confederation identifier** command configures the confederation identifier. Confederation can reduce the number of iBGP connections in a large AS domain. The AS domain is divided into several smaller sub-ASs, and each sub-AS remains fully connected. Devices in a sub-AS exchange information via iBGP, while devices in different sub-ASs use eBGP

The **no bgp confederation identifier** and **default bgp confederation identifier** commands remove the **bgp confederation identifier** command from *running-config*.

##### Command Mode

Router-BGP Configuration

##### Command Syntax

```
bgp confederation identifier as_number
```

```
no bgp confederation identifier
```

```
default bgp confederation identifier
```

##### Parameters

- *as\_number* the ID of BGP AS confederation. Values range from 1 to 4294967295.

##### Example

- This command sets the BGP confederation identifier to 9.

```
switch(config)#router bgp 1
switch(config-router-bgp)#bgp confederation identifier 9
switch(config-router-bgp)#
```

#### 14.5.4.16 bgp confederation peers

The **bgp confederation peers** command configures a confederation consisting of sub-ASs.

Before this command is executed, the confederation ID should be configured using the **bgp confederation identifier** command. Otherwise this configuration is invalid. The configured ASs in this command are inside the confederation and each AS uses a fully meshed network. The confederation appears as a single AS to the devices outside it.

The **no bgp confederation peers** and **default bgp confederation peers** commands delete the specified sub-AS from the confederation by removing the corresponding **bgp confederation peers** command from *running-config*.

##### Command Mode

Router-BGP Configuration

##### Command Syntax

```
bgp confederation peers as_range
```

```
no bgp confederation peers as_range
```

```
default bgp confederation peers as_range
```

##### Parameters

- *as\_range* the sub-AS number. Formats include number (from 1 to 4294967295), number range, or comma-delimited list of numbers and ranges.

##### Example

- This command configures the confederation that contains AS 1000 and AS 1002.

```
switch(config)#router bgp 1
switch(config-router-bgp)#bgp confederation peers 1000 1002
switch(config-router-bgp)#
```

---

#### 14.5.4.17 bgp convergence slow-peer time

The **bgp convergence slow-peer time** command configures the idle peer time to wait for the slow peers to establish a session in a BGP convergence state.

The **no bgp convergence slow-peer time** command disables the inheritance of the configuration from the global BGP configuration mode. The **default bgp convergence slow-peer time** command sets the timeout value to the default value.

##### Command Mode

Router-BGP Configuration

##### Command Syntax

```
bgp convergence slow-peer time timeout
no bgp convergence slow-peer time
default bgp convergence slow-peer time
```

##### Parameters

- *timeout* the maximum time to wait for the slow peers to establish a session connection. Values range from 1 to 3600 seconds. The default value is 90 seconds.

##### Example

- This command configures an idle peer timeout of 40 seconds to wait before establishing a session.

```
switch(config)#router bgp 1
switch(config-router-bgp)#bgp convergence slow-peer time 40
switch(config-router-bgp)#
```



#### 14.5.4.18 bgp convergence time

The **bgp convergence time** command configures the time to wait before the BGP convergence starts in a session.

The **no bgp convergence time** command removes the configured convergence time to wait. The **default bgp convergence time** command sets the timeout value to the default value.

##### Command Mode

Router-BGP Configuration

##### Command Syntax

```
bgp convergence time timeout_range
```

```
no bgp convergence time
```

```
default bgp convergence time
```

##### Parameters

- *timeout\_range* the maximum time to wait for the BGP convergence. Values range from 1 to 3600 seconds. The default value is 300 seconds.

##### Example

- This command configures a convergence time of 200 seconds to wait before establishing a session.

```
switch(config)#router bgp 1
switch(config-router-bgp)#bgp convergence time 200
switch(config-router-bgp)#
```

### 14.5.4.19 bgp default

The `bgp default` command configures the default address family activation level of all addresses configured as BGP neighbors. The switch sends the following announcements to addresses active in an address family:

- **IPv4 address family:** IPv4 capability and all network advertisements with IPv4 prefixes.
- **IPv6 address family:** IPv6 capability and all network advertisements with IPv6 prefixes.

The following commands configure default address family activation levels for addresses configured as BGP neighbors:

- `bgp default ipv4-unicast`: all addresses are IPv4 address family active.
- `no bgp default ipv4-unicast`: all addresses are *not* IPv4 address family active.
- `bgp default ipv6-unicast`: all addresses are IPv6 address family active.
- `no bgp default ipv6-unicast`: all addresses are *not* IPv6 address family active.
- `bgp default ipv4-unicast transport ipv6`: all BGP neighbor addresses are IPv4 address family active and IPv6 neighbors can receive IPv4 NLRIs.



**Note:** If it is necessary to exchange IPv4 NLRIs over an IPv6 connection, the IPv4 address family must be activated on the IPv6 neighbor. To do this for all IPv6 neighbors, use the command `bgp default ipv4-unicast transport ipv6`. For an individual neighbor, use the `neighbor activate` command for the IPv6 neighbor in the IPv4 address-family configuration mode as described below.

The activation state of an individual BGP neighbor address is configured by the `neighbor activate` command. The `neighbor activate` command overrides the address's default activation state for the address family configuration mode in which the command is issued:

- `neighbor activate`: the specified address is active.
- `no neighbor activate`: the specified address is *not* active.

The **default-default address family activation state** defines the address family activation level of all addresses configured as BGP neighbors when *running-config* does not contain any `bgp default` commands. The default state of the BGP default activation level varies by address family.

- **IPv4 address family:** all BGP addresses are IPv4 address family active.
- **IPv6 address family:** all BGP addresses are *not* IPv6 address family active.

The default `bgp default` command restores the default-default activation setting for BGP neighbor addresses in the specified address family:

- `default bgp ipv4-unicast` is equivalent to `bgp ipv4-unicast`
- `default bgp ipv6-unicast` is equivalent to `no bgp ipv6-unicast`

#### Command Mode

Router-BGP Configuration

#### Command Syntax

```
bgp default ADDRESS_FAMILY
no bgp default ADDRESS_FAMILY
default bgp default ADDRESS_FAMILY
```

#### Parameters

- ADDRESS\_FAMILY BGP address family. Options include:
  - `ipv4-unicast` IPv4-unicast peering sessions.
  - `ipv6-unicast` IPv6-unicast peering sessions.

#### Example

- These commands configure the switch to configure all BGP neighbor addresses as IPv4 address-family active and IPv6 address-family active.

```
switch(config)#router bgp 1
switch(config-router-bgp)#bgp default ipv4-unicast
switch(config-router-bgp)#bgp default ipv6-unicast
switch(config-router-bgp)#show active
router bgp 65533
 bgp log-neighbor-changes
 distance bgp 20 200 200
 neighbor 172.23.254.2 remote-as 65533
 neighbor 172.41.254.78 remote-as 65534
 neighbor 2001:0DB8:52a4:fe01::2 remote-as 65533
 neighbor 2001:0DB8:52a4:fe4c::1 out-delay 10
switch(config-router-bgp)#
```

The **show active** command does not display the **bgp default ipv4-unicast** command because it is the default setting for IPv4 peering sessions.

---

#### 14.5.4.20 bgp enforce-first-as

The **bgp enforce-first-as** command causes a forced comparison of the first autonomous system (AS) in the AS path of eBGP routes received from BGP neighbors to the configured remote external peer autonomous system number (ASN). Updates from eBGP peers that do not include that ASN as the first item in the AS path (in the AS\_PATH attribute) are discarded.

This behavior is enabled by default upon BGP configuration, and disabled globally by the no form of this command. To configure first-AS enforcement for an individual neighbor or peer group, use the `neighbor enforce-first-as` command.

##### Command Mode

Router-BGP Configuration

##### Command Syntax

```
bgp enforce-first-as
default bgp enforce-first-as
no bgp enforce-first-as
```

##### Example

- This command configures BGP to enforce the first AS globally.

```
switch(config-router-bgp) #bgp enforce-first-as
switch(config-router-bgp) #
```

### 14.5.4.21 bgp listen range

The **bgp listen range** command identifies the BGP peering request from a range of IPv4 or IPv6 address, and names the dynamic peer group to which those peers belong to. To create a static peer group, use the **neighbor peer group (create)** command.

The request can be from a single AS number or from a range of AS numbers configured. To accept the peering request from single ASN use the **remote-as** option, and to accept request from multiple ASNs use the **peer-filter** option.

Members of a dynamic peer group are configured in groups and not as individuals. Once a new peer group is created with a group name, the group name is then used as an argument by the following **neighbor** commands:

- `neighbor ebgp-multihop`
- `neighbor import-localpref`
- `neighbor maximum-routes`
- `neighbor route-map (BGP)`
- `neighbor timers`
- `neighbor update-source.`

The **no bgp listen range** and **default bgp listen range** commands remove the dynamic peer group by deleting the corresponding command from **running-config**. To remove a static peer group, use the **no neighbor** command. All peering relationships with group members are terminated when the dynamic peer group is deleted.

#### Command Mode

Router-BGP Configuration

#### Command Syntax

```
bgp listen range NET_ADDRESS [PEER-ID include router-id] peer-group group_name
[remote-as as_number | peer-filter filter_name]
```

```
no bgp listen range NET_ADDRESS peer-group group_name
```

```
default bgp listen range NET_ADDRESS peer-group group_name
```

#### Parameters

- NET\_ADDRESS IP address range. Options include:
  - *IPv4\_subnet* IPv4 subnet (CIDR notation).
  - *IPv4\_address mask subnet* IPv4 subnet (dotted decimal notation).
  - *IPv6\_prefix* IPv6 subnet (dotted decimal notation).
- PEER-ID Additional specification for identifying a peer.
  - **include** Include following fields as part of peer identifier.
  - **router-id** Include router ID as part of peer identifier.
- *group\_name* name of the peer group.
- *as\_number* the autonomous system number, ranges from 1 to 4294967295.
- *filter\_name* name of the peer filter.

#### Examples

- These commands create a dynamic peer group called “brazil” in AS 5 which accepts peering requests from the 192.168.6.0/24 subnet.

```
switch(config)#router bgp 1
switch(config-router-bgp)#bgp listen range 192.168.6.0/24 peer-group
brazil remote-as 5
switch(config-router-bgp)#
```

- 
- These commands create a dynamic peer group called “brazil” in a range of AS numbers, which accepts peering requests from the 192.0.2.0/24 subnet. The range of AS numbers is defined by peer filter option.

```
switch(config)#router bgp 1
switch(config-router-bgp)#bgp listen range 192.0.2.0/24 peer-group
brazil peer-filter group-1
switch(config-router-bgp)#
```

- These commands enable the same address peering.

```
switch(config)#router bgp 1
switch(config-router-bgp)#bgp listen range 192.0.2.0/24 peer-id include
router-id peer-group brazil peer-filter group-1
```

#### 14.5.4.22 bgp log-neighbor-changes

The **bgp log-neighbor-changes** command configures the switch to generate a log message when a BGP peer enters or exits the **established** state. This is the default behavior.

The **no bgp log-neighbor-changes** command disables the generation of these log messages. The **default bgp log-neighbor-changes** command enables the generation of these log messages.

##### Command Mode

Router-BGP Configuration

##### Command Syntax

```
bgp log-neighbor-changes
no bgp log-neighbor-changes
default bgp log-neighbor-changes
```

##### Example

- These commands configure the switch to generate a message when a BGP peer enters or exits the **established** state.

```
switch(config)#router bgp 1
switch(config-router-bgp)#bgp log-neighbor-changes
switch(config-router-bgp)#
```

---

### 14.5.4.23 bgp redistribute-internal (BGP)

The **bgp redistribute-internal** command enables the redistribution of iBGP routes into an interior gateway protocol (IGP).

The **no bgp redistribute-internal** and **default bgp redistribute-internal** commands disable route redistribution from the specified domain by removing the corresponding **bgp redistribute-internal** command from *running-config*.

#### Command Mode

Router-BGP Configuration Router-BGP Address-Family Configuration

#### Command Syntax

```
bgp redistribute internal
no bgp redistribute internal
default bgp redistribute internal
```

#### Example

- This command redistributes internal BGP routes.

```
switch(config)#router bgp 9
switch(config-router-bgp)#bgp redistribute-internal
switch(config-router-bgp)#
```



#### 14.5.4.24 bgp route install-map

The **bgp route install-map** command enables BGP Selective Route Download on the switch and allows the learning and advertising of the BGP routes without installing them in hardware.

The **no bgp route install-map** and **default bgp route install-map** commands delete the BGP Selective Route Download instance.

The **exit** command returns the switch to global configuration mode.

##### Command Mode

BGP Configuration

##### Command Syntax

```
bgp route install-map map_name
```

##### Parameter

- *map\_name* The name of the route map configured.

##### Example

- These commands configure BGP Selective Route Download for test\_BGP map.

```
switch(config)#router bgp 100
switch(config-router-bgp)#bgp route install-map test_BGP
switch(config-router-bgp)#
```

---

#### 14.5.4.25 bgp route-reflector preserve-attributes

The **bgp route-reflector preserve-attributes** command configures the switch, when operating as a BGP route reflector, to preserve the BGP attributes of re-advertised routes. By default, BGP attribute preservation is disabled. When attribute preservation is enabled, the BGP attributes (next-hop, local preference, and metric) are preserved in the reflected routes regardless of outbound BGP policies, except when those policies are part of an outbound route map. To override outbound route maps, use the **always** keyword.

The **no bgp route-reflector preserve-attributes** and **default bgp route-reflector preserve-attributes** commands disable BGP attribute preservation.

##### Command Mode

Router-BGP Configuration

##### Command Syntax

```
bgp route-reflector preserve-attributes [always]
no bgp route-reflector preserve-attributes
default bgp route-reflector preserve-attributes
```

##### Parameter

- **always** Always preserves route attributes, overwriting route map changes.

##### Related Commands

- [neighbor route-reflector-client](#)

##### Example

- The following commands configure the switch as a route reflector and the neighbor at 10.5.2.1 as one of its clients, then configure the switch to preserve the BGP attributes of reflected routes unless overridden by an outbound route map policy.

```
switch(config)#router bgp 10
switch(config-router-bgp)#neighbor 10.5.2.11 route-reflector-client
switch(config-router-bgp)#bgp route-reflector preserve-attributes
switch(config-router-bgp)#
```

#### 14.5.4.26 clear bgp history

To clear all messages for a peer or group of peers, use the `clear bgp history` command .

##### Command Mode

Privileged EXEC

##### Command Syntax

```
clear bgp [PEER | PREFIX | peer-group PEER_GROUP] history [connect-failures] [vrf VRF]
```

##### Parameters

- **PEER** An IPv4 or IPv6 valid address.
- **PREFIX** An IPv4 or IPv6 valid prefix.
- **peer-group PEER\_GROUP** A peer group name.
- **connect-failures** Optional and will not affect the result.
- **vrf VRF** A VRF name. If it's not supplied, command will act upon VRF default.

If no peer, prefix, or peer-group is supplied, the `clear bgp history` command will clear the history for all peers in the specified VRF.

##### Related Command

[show bgp neighbors history](#)

##### Example

This example clears the BGP Peer group *Purple* history from *VRF\_1*.

```
switch#clear bgp Purple history vrf VRF_1
```

---

#### 14.5.4.27 clear ip bgp counters

The **clear ip bgp counters** command resets general statistics of peers. These statistics primarily consist of message-related counts.

##### Command Mode

Privileged EXEC

##### Command Syntax

```
clear ip bgp [PEERS] counters [VRF_INSTANCES]
```

##### Parameters

- PEERS specifies targeted BGP peers. Options include:
  - <no parameters> all IPv4 and IPv6 peers.
  - \* all IPv4 and IPv6 peers.
  - *ipv4\_addr* the IPv4 peer with the specified IPv4 address.
  - *ipv6\_addr* the IPv6 peer with the specified IPv6 address.
  - *inrf\_ipv6\_addr* the peer using the specified IPv6 link-local address.
  - *peer-group peer\_grp\_name* the peers using the specified BGP peer group.
- VRF\_INSTANCES specifies the VRF(s) examined for BGP peers. Options include:
  - <no parameters> resets matching peers in the context-active VRF.
  - *vrf\_name* resets matching peers in the specified VRF.
  - all resets matching peers in all VRFs.
  - default resets matching peers in the default VRF.

##### Related Commands

- [clear ip bgp](#)
- [clear ip bgp errors](#)
- [clear ip bgp neighbor \\*](#)

##### Example

- This command resets general statistics of all IPv4 and IPv6 peers in the context-active VRF.

```
switch#clear ip bgp counters
! Clearing all IPv4 and IPv6 peering sessions
switch#
```

### 14.5.4.28 clear ip bgp errors

The **clear ip bgp errors** command resets the error statistics and history of peers. Peer general statistics primarily consist of notification errors, socket errors, and update errors.

#### Command Mode

Privileged EXEC

#### Command Syntax

```
clear ip bgp [PEERS] errors [VRF_INSTANCES]
```

#### Parameters

- PEERS specifies targeted BGP peers. Options include:
  - <no parameters> all IPv4 and IPv6 peers.
  - \* all IPv4 and IPv6 peers.
  - *ipv4\_addr* the IPv4 peer with the specified IPv4 address.
  - *ipv6\_addr* the IPv6 peer with the specified IPv6 address.
  - *inrf\_ipv6\_addr* the peer using the specified IPv6 link-local address.
  - *peer-group peer\_grp\_name* the peers using the specified BGP peer group.
- VRF\_INSTANCES specifies the VRF(s) examined for BGP peers. Options include:
  - <no parameters> resets matching peers in the context-active VRF.
  - *vrf\_name* resets matching peers in the specified VRF.
  - all resets matching peers in all VRFs.
  - default resets matching peers in the default VRF.

#### Related Commands

- `clear ip bgp`
- `clear ip bgp counters`
- `clear ip bgp neighbor *`

#### Example

- This command resets the error statistics of all IPv4 and IPv6 peers in the context-active VRF.

```
switch#clear ip bgp errors
! Clearing all IPv4 and IPv6 peering sessions
switch#
```

---

#### 14.5.4.29 clear ip bgp neighbor \*

The `clear ip bgp neighbor *` command clears BGP neighbors belonging to the IPv4 transport address family. To clear BGP neighbors in the IPv6 transport address family, use the `clear ipv6 bgp neighbor *` command.

##### Command Mode

Privileged EXEC

##### Command Syntax

```
clear ip bgp neighbor * [VRF_INSTANCE] [ROUTER-ID]
```

##### Parameters

- VRF\_INSTANCE specifies VRF instance for which IPv4 transport address family BGP neighbors will be cleared. Options include:
  - <no parameter> clears IPv4 BGP neighbors in the context-active VRF.
  - vrf *vrf\_name* clears IPv4 BGP neighbors in the specified VRF.
  - vrf all clears IPv4 BGP neighbors in the all VRFs.
  - vrf default clears IPv4 BGP neighbors in the default VRF.
- ROUTER-ID Router ID as part of peer identifier.

##### Related Commands

- `clear ip bgp`
- `clear ip bgp counters`
- `clear ip bgp errors`

##### Examples

- This command clears all IPv4 BGP neighbors in the context-active VRF.

```
switch#clear ip bgp neighbor *
switch#
```

- This command clears all IPv4 BGP neighbors in VRF “purple.”

```
switch#clear ip bgp neighbor * vrf purple
switch#
```

- This command clears the peer IP address (Note, this command is effective only if you specify the router-ID).

```
switch#clear ip bgp neighbor 1.0.0.2 router-id 1.1.1.2 soft
```

### 14.5.4.30 clear ip bgp

The `clear ip bgp` command removes learned BGP routes from the routing table, reads all routes from designated peers, and sends routes to those peers as required. This command can also clear the switch's BGP sessions with its peers.

Routes that are read or sent are processed through modified route maps or AS-path access lists.

#### Command Mode

Privileged EXEC

#### Command Syntax

```
clear ip bgp [PEERS] [RESET_TYPE] [DATA_FLOW] [VRF_INSTANCE]
```

#### Parameters

- PEERS specifies targeted BGP peers. Options include:
  - <no parameters> all IPv4 and IPv6 peers.
  - \* all IPv4 and IPv6 peers.
  - *ipv4\_addr* the IPv4 peer with the specified IPv4 address.
  - *ipv6\_addr* the IPv6 peer with the specified IPv6 address.
  - *inrf\_ipv6\_addr* the peer using the specified IPv6 link-local address.
  - *peer-group peer\_grp\_name* the peers using the specified BGP peer group.
- RESET\_TYPE specifies the method used to reset routes. Options include:
  - <no parameters> performs a hard reset that terminates current BGP sessions and recreates the local routing information base.
  - *soft* performs a soft reset that maintains current BGP sessions and reconfigures the local routing information base using stored routes.
- DATA\_FLOW restricts soft reset to inbound or outbound routes. Hard reset is bidirectional. Options include:
  - <no parameters> resets inbound and outbound routes.
  - *in* resets inbound peer routes.
  - *out* resets outbound peer routes.
- VRF\_INSTANCES specifies the VRF(s) examined for BGP peers. Options include:
  - <no parameters> resets matching peers in the context-active VRF.
  - *vrf\_name* resets matching peers in the specified VRF.
  - *all* resets matching peers in all VRFs.
  - *default* resets matching peers in the default VRF.

#### Related Commands

- `clear ip bgp counters`
- `clear ip bgp errors`
- `clear ip bgp neighbor *`

#### Guidelines

Use the `clear ip bgp` command after changing any of the following BGP attributes:

- weights
- distribution lists
- timers
- administrative distance

#### Examples

- 
- This command performs a hard reset of all IPv4 and IPv6 peers in the context-active VRF.

```
switch#clear ip bgp
switch#
```

- This command has the same behavior as the above `clear ip bgp` command.

```
switch#clear ip bgp *
switch#
```



### 14.5.4.31 clear ipv6 bgp counters

The `clear ipv6 bgp counters` command resets general statistics of peers. These statistics primarily consist of message-related counts.

#### Command Mode

Privileged EXEC

#### Command Syntax

```
clear ipv6 bgp [PEERS] counters [VRF_INSTANCES]
```

#### Parameters

- PEERS specifies targeted BGP peers. Options include:
  - <no parameters> all IPv4 and IPv6 peers.
  - \* all IPv4 and IPv6 peers.
  - *ipv4\_addr* the IPv4 peer with the specified IPv4 address.
  - *ipv6\_addr* the IPv6 peer with the specified IPv6 address.
  - *intra\_ipv6\_addr* the peer using the specified IPv6 link-local address.
  - *peer-group peer\_grp\_name* the peers using the specified BGP peer group.
- VRF\_INSTANCES specifies the VRF(s) examined for BGP peers. Options include:
  - <no parameters> resets matching peers in the context-active VRF.
  - *vrf\_name* resets matching peers in the specified VRF.
  - all resets matching peers in all VRFs.
  - default resets matching peers in the default VRF.

#### Related Commands

- `clear ipv6 bgp`
- `clear ipv6 bgp errors`
- `clear ipv6 bgp neighbor *`

#### Example

- This command resets general statistics of all IPv4 and IPv6 peers in the context-active VRF.

```
switch#clear ipv6 bgp counters
! Clearing all IPv4 and IPv6 peering sessions
switch#
```

---

### 14.5.4.32 clear ipv6 bgp errors

The `clear ipv6 bgp errors` command resets the error statistics and history of peers. Peer general statistics primarily consist of notification errors, socket errors, and update errors.

#### Command Mode

Privileged EXEC

#### Command Syntax

```
clear ipv6s bgp [PEERS] errors [VRF_INSTANCES]
```

#### Parameters

- PEERS specifies targeted BGP peers. Options include:
  - <no parameters> all IPv4 and IPv6 peers.
  - \* all IPv4 and IPv6 peers.
  - *ipv4\_addr* the IPv4 peer with the specified IPv4 address.
  - *ipv6\_addr* the IPv6 peer with the specified IPv6 address.
  - *inrf\_ipv6\_addr* the peer using the specified IPv6 link-local address.
  - peer-group *peer\_grp\_name* the peers using the specified BGP peer group.
- VRF\_INSTANCES specifies the VRF(s) examined for BGP peers. Options include:
  - <no parameters> resets matching peers in the context-active VRF.
  - *vrf\_name* resets matching peers in the specified VRF.
  - all resets matching peers in all VRFs.
  - default resets matching peers in the default VRF.

#### Related Commands

- `clear ipv6 bgp`
- `clear ipv6 bgp counters`
- `clear ipv6 bgp neighbor *`

#### Example

- This command resets the error statistics of all IPv4 and IPv6 peers in the context-active VRF.

```
switch#clear ipv6 bgp errors
! Clearing all IPv4 and IPv6 peering sessions
switch#
```

### 14.5.4.33 clear ipv6 bgp neighbor \*

The `clear ipv6 bgp neighbor *` command clears BGP neighbors belonging to the IPv4 transport address family. To clear BGP neighbors in the IPv4 transport address family, use the `clear ip bgp neighbor *` command.

#### Command Mode

Privileged EXEC

#### Command Syntax

```
clear ipv6 bgp neighbor * [VRF_INSTANCE]
```

#### Parameters

- VRF\_INSTANCE specifies VRF instance for which IPv6 transport address family BGP neighbors will be cleared. Options include:
  - <no parameter> clears IPv6 BGP neighbors in the context-active VRF.
  - vrf *vrf\_name* clears IPv6 BGP neighbors in the specified VRF.
  - vrf all clears IPv6 BGP neighbors in the all VRFs.
  - vrf default clears IPv6 BGP neighbors in the default VRF.

#### Related Commands

- `clear ipv6 bgp`
- `clear ipv6 bgp counters`
- `clear ipv6 bgp errors`

#### Examples

- This command clears all IPv4 BGP neighbors in the context-active VRF.

```
switch#clear ip bgp neighbor *
switch#
```

- This command clears all IPv4 BGP neighbors in VRF "purple."

```
switch#clear ip bgp neighbor * vrf purple
switch#
```

---

#### 14.5.4.34 clear ipv6 bgp

The `clear ipv6 bgp` command removes learned BGP routes from the routing table, reads all routes from designated peers, and sends routes to those peers as required. This command can also clear the switch's BGP sessions with its peers.

Routes that are read or sent are processed through modified route maps or AS-path access lists.

##### Command Mode

Privileged EXEC

##### Command Syntax

```
clear ipv6 bgp [PEERS] [RESET_TYPE] [DATA_FLOW] [VRF_INSTANCE]
```

##### Parameters

- PEERS specifies targeted BGP peers. Options include:
  - <no parameters> all IPv4 and IPv6 peers.
  - \* all IPv4 and IPv6 peers.
  - *ipv4\_addr* the IPv4 peer with the specified IPv4 address.
  - *ipv6\_addr* the IPv6 peer with the specified IPv6 address.
  - *inrf\_ipv6\_addr* the peer using the specified IPv6 link-local address.
  - *peer-group peer\_grp\_name* the peers using the specified BGP peer group.
- RESET\_TYPE specifies the method used to reset routes. Options include:
  - <no parameters> performs a hard reset that terminates current BGP sessions and recreates the local routing information base.
  - *soft* performs a soft reset that maintains current BGP sessions and reconfigures the local routing information base using stored routes.
- DATA\_FLOW restricts soft reset to inbound or outbound routes. Hard reset is bidirectional. Options include:
  - <no parameters> resets inbound and outbound routes.
  - *in* resets inbound peer routes.
  - *out* resets outbound peer routes.
- VRF\_INSTANCES specifies the VRF(s) examined for BGP peers. Options include:
  - <no parameters> resets matching peers in the context-active VRF.
  - *vrf\_name* resets matching peers in the specified VRF.
  - *all* resets matching peers in all VRFs.
  - *default* resets matching peers in the default VRF.

##### Related Commands

- `clear ipv6 bgp counters`
- `clear ipv6 bgp errors`
- `clear ipv6 bgp neighbor *`

##### Guidelines

Use the `clear ipv6 bgp` command after changing any of the following BGP attributes:

- weights
- distribution lists
- timers
- administrative distance

##### Examples

- This command performs a hard reset of all IPv4 and IPv6 peers in the context-active VRF.

```
switch#clear ipv6 bgp
switch#
```

- This command has the same behavior as the above `clear ip bgp` command.

```
switch#clear ipv6 bgp *
switch#
```

---

### 14.5.4.35 distance bgp

The **distance bgp** command assigns an administrative distance to routes that the switch learns through BGP. Routers use administrative distances to select a route when two protocols provide routing information to the same destination. Distance values range from 1 to 255; lower distance values correspond to higher reliability. BGP routing tables do not include routes with a distance of 255.

The distance command assigns distance values to external, internal, and local BGP routes:

- **external:** Best-path routes learned from a neighbor external to the autonomous system. Default distance is 200.
- **internal:** Internal routes are routes learned from a BGP entity within the same autonomous system. Default distance is 200.
- **local:** Local routes are networks listed with a network router configuration command for that router or for networks that are redistributed from another process. Default distance is 200.

The **no distance bgp** and **default distance bgp** commands restore the default administrative distances by removing the **distance bgp** command from *running-config*.

#### Command Mode

Router-BGP Configuration

#### Command Syntax

```
distance bgp external_dist [INTERNAL_LOCAL]
```

```
no distance bgp
```

```
default distance bgp
```

#### Parameters

- *external\_dist* distance assigned to external routes. Values range from 1 to 255.
- INTERNAL\_LOCAL distance assigned to internal and local routes. Values for both routes range from 1 to 255. Options include:
  - <no parameter> the *external\_dist* value is also assigned to internal and local routes.
  - *internal\_dist local\_dist* values assigned to internal and local routes.

#### Example

- This command assigns an administrative distance of 150 to external routes, 200 to internal, and 150 to local routes.

```
switch(config)#router bgp 1
switch(config-router-bgp)#distance bgp 150 200 150
switch(config-router-bgp)#
```

### 14.5.4.36 dynamic peer max

The **dynamic peer max** command limits the number of dynamic BGP peers allowed on the switch.

The **no dynamic peer max** and **default dynamic peer max** commands restore the default limit of dynamic BGP peers by removing the **dynamic peer max** command from **running-config**.

#### Command Mode

Router-BGP Configuration

#### Command Syntax

```
dynamic peer max maximum
```

```
no dynamic peer max
```

```
default dynamic peer max
```

#### Parameters

- *maximum* the maximum number of dynamic BGP peers to be allowed on the switch. Values range from 1 to 1000; default value is 100.

#### Example

- This command sets the maximum number of dynamic BGP peers allowed on the switch to 200.

```
switch(config)#router bgp 1
switch(config-router-bgp)#dynamic peer max 200
switch(config-router-bgp)#
```

---

#### 14.5.4.37 graceful-restart stalepath-time

The **graceful-restart stalepath-time** command specifies the maximum time that stale routes from a restarting BGP neighbor will be retained after a BGP session is re-established with that peer.

The **no graceful-restart stalepath-time** and **default graceful-restart stalepath-time** commands restore the default value of 300 seconds by deleting the **graceful-restart stalepath-time** statement from *running-config*.

##### Command Mode

Router-BGP Configuration

##### Command Syntax

```
graceful-restart stalepath-time interval
no graceful-restart stalepath-time
default graceful-restart stalepath-time
```

##### Parameters

- *interval* Maximum period (in seconds) that stale routes from a restarting BGP neighbor will be retained after the BGP session is re-established. Values range from 1 to 3600 (60 minutes). Default is 300.

##### Example

- These commands configure the stale path retention interval to 15 minutes.

```
switch(config)#router bgp 1
switch(config-router-bgp)#graceful-restart stalepath-time 900
switch(config-router-bgp)#
```



### 14.5.4.38 graceful-restart-helper

The **graceful-restart helper** command enables BGP graceful restart helper mode on the switch for all BGP neighbors. When graceful restart helper mode is enabled, the switch will retain routes from neighbors which are capable of graceful restart while those neighbors are restarting BGP. Graceful restart is enabled by default. To configure graceful restart helper mode for a specific neighbor or peer group, use the `neighbor graceful-restart-helper` command. Individual neighbor configuration takes precedence over the global configuration.

The **no graceful-restart helper** command disables graceful restart helper mode on the switch. The **default graceful-restart helper** command enables graceful restart helper mode by removing the corresponding **no graceful-restart helper** command from *running-config*.

#### Command Mode

Router-BGP Configuration

#### Command Syntax

```
graceful-restart helper long-lived
no graceful-restart helper long-lived
default graceful-restart helper long-lived
```

#### Parameter

- long-lived Enables long lived graceful restart helper mode.

#### Example

- These commands disable graceful restart helper mode on the switch.

```
switch(config)#router bgp 1
switch(config-router-bgp)#no graceful-restart-helper
switch(config-router-bgp)#
```

---

### 14.5.4.39 ip as-path access-list

The `ip as-path access-list` command creates an access list to filter BGP route updates. If access list *list\_name* does not exist, this command creates it. If it already exists, this command appends statements to the list.

The `no ip as-path access-list` and `default ip as-path access-list` commands delete the named access list.

#### Command Mode

Global Configuration

#### Command Syntax

```
ip as-path access-list list_name FILTER_TYPE regex ORIGIN
```

```
no ip as-path access-list list_name
```

```
default ip as-path access-list list_name
```

#### Parameters

- *list\_name* the name of the AS path access list.
- FILTER\_TYPE access resolution of the specified AS path. Options include:
  - permit access is permitted.
  - deny access is denied.
- *regex* a regular expression describing the AS path being filtered. Regular expressions are pattern-matching strings that are composed of text characters and operators.
- ORIGIN the origin of the path information. Values include:
  - <no parameter> sets the origin to **any**.
  - any any BGP origin.
  - egp EGP origin.
  - igp IGP origin.
  - incomplete incomplete origin.

#### Example

- These commands create an AS path access list named "list1" which allows all BGP routes except those originating in AS 3.

```
switch(config)#ip as-path access-list list1 deny _3$
switch(config)#ip as-path access-list list1 permit .*
switch(config)#
```

#### 14.5.4.40 ip as-path regex-mode

The **ip as-path regex-mode** command specifies how the switch will evaluate regular expressions describing AS paths in ACLs. When the regex mode is set to **asn**, AS numbers in the ACL are interpreted as AS numbers; only complete AS number matches in the AS path return a match. When it is set to **string**, AS numbers in the ACL are interpreted as strings; both complete AS number matches and longer AS numbers that include the target string return a match. The default mode is **asn**.

For example, **asn** mode will return “false” and **string** mode will return “true” when searching for “10” in an AS path of “100 200.”

The **no ip as-path regex-mode** and **default ip as-path regex-mode** commands restore the regex mode to **asn** by removing the **ip as-path regex-mode** command from *running-config*.

##### Command Mode

Global Configuration

##### Command Syntax

```
ip as-path regex-mode MODE_SETTING
```

```
no ip as-path regex-mode
```

```
default ip as-path regex-mode
```

##### Parameters

- **MODE\_SETTING** Specifies how regular expressions describing AS paths in AS path ACLs will be evaluated. Options include:
  - **asn** AS numbers in the ACL are interpreted as AS numbers; only complete AS number matches in the AS path return a match.
  - **string** AS numbers in the ACL are interpreted as strings; both complete AS number matches and longer AS numbers that include the target string return a match.

##### Example

- This command sets the regex mode to **string**.

```
switch(config)#ip as-path regex-mode string
switch(config)#
```

---

#### 14.5.4.41 ip community-list regexp

The **ip community-list regexp** command creates and configures a BGP access list based on BGP communities. A BGP community access list filters prefixes based on their BGP communities. The command uses regular expressions to identify the communities specified by the list. To create a community list by explicitly specifying one or more communities, use the [ip community-list](#) command.

The **no ip community-list regexp** and **default ip community-list regexp** commands delete the specified community list. To delete a specific community-list entry, specify the entry in the **no ip community-list regexp** command.

##### Command Mode

Global Configuration

##### Command Syntax

```
ip community-list regexp list_name {deny | permit} reg_exp
no ip community-list regexp list_name {deny | permit} reg_exp
default ip community-list regexp list_name
```

##### Parameters

- *list\_name* name of the community list. Valid input is text.
- permit access is permitted for the specified community.
- deny access is denied for the specified community.
- *reg\_exp* list of communities, formatted as a regular expression. Regular expressions are pattern-matching strings that are composed of text characters and operators.



**Note:** When using the no form of the command, a regular expression can be used to specify a single entry to be removed from the list, leaving the rest of the list intact. If no entry is specified, the no form of the command removes the entire list.

##### Related Commands

- [route-map](#)
- [match \(route-map\)](#)
- [show ip community-list](#)
- [show ip extcommunity-list](#)

##### Guideline

The **ip community-list regexp** command with the permit internet option permits access to only those routes that carry the community value of 0.

##### Examples

- This command creates a BGP community list that permits routes from networks 20-24 and 30-34 in autonomous system 10.

```
switch(config)#ip community-list regexp list_2 permit 10:[2-3][0-4]_
switch(config)#
```

- This command removes the above statement from the community list named “list\_2,” leaving any other statements in the list intact.

```
switch(config)#no ip community-list regexp list_2 permit 10:[2-3][0-4]_
switch(config)#
```

- This command deletes the community list named “list\_2” entirely.

```
switch(config)#no ip community-list regexp list_2
```

```
switch(config)#
```

- This command permits access to all routes associated with the BGP community list (CLIST1) that carry the community value 0.

```
switch(config)#ip community-list regexp CLIST1 permit internet
switch(config)#
```

#### 14.5.4.42 ip community-list

The `ip community-list` command creates and configures a BGP access list based on BGP communities.

The `no ip community-list` and `default ip community-list` commands delete the specified community list by removing the corresponding `ip community-list` command from *running-config*.

##### Command Mode

Global Configuration

##### Command Syntax

```
ip community-list list_name [permit | deny] [GSHUT | aa:nn | internet | local-as | no-advertise | no-export | number]
```

```
no ip community-list list_name
```

```
default ip community-list list_name
```

##### Parameters

- *list\_name* name of the community list. Valid input is text.
- permit permits access to the specified community.
- deny denies access to the specified community.
- GSHUT well-known graceful shutdown community.
- *aa:nn* AA is 65535 and NN specifies the community number (0-65535) within the AS.
- internet advertises route to the Internet community.
- local-as advertises route only to local peers.
- no-advertise does not advertise route to any peer.
- no-export advertises route only within BGP AS boundary.
- number community number. Values ranges from 0 to 4294967040.

##### Related Commands

- `route-map`
- `match (route-map)`
- `show ip community-list`
- `show ip extcommunity-list`

##### Guideline

EOS does not support disabling the process of graceful shutdown community.

 **Note:** The `ip community-list` command with the permit internet option permits access to all routes associated with any community.

##### Examples

- This command creates a BGP community list (named "list\_9") that does not match members of route maps configured with AS-network number 100:250.

```
switch(config)#ip community-list list_9 deny 100:250
switch(config)#
```

- These commands create a BGP community list that permits the graceful shutdown community, then use that list in a route map to permit routes with that community.

```
switch(config)#ip community-list gshut_list permit GSHUT
switch(config)#route-map map1
switch(config-route-map-map1)#match community gshut_list
switch(config-route-map-map1)#exit
switch(config)#show route-map map1
```

```
route-map map1 permit 10
 Description:
 Match clauses:
 match community gshut_list
 SubRouteMap:
 Set clauses:
switch(config)#
```

- This command permits access to all routes associated with the BGP community list (CLIST1).

```
switch(config)#ip community-list CLIST1 permit internet
switch(config)#
```

---

#### 14.5.4.43 ip extcommunity-list regexp

The `ip extcommunity-list regexp` command creates an extended community list to filter VRF routes or for link bandwidth (LBW) advertisement. The command uses regular expressions to define the extended communities specified by the list. To specify particular values, use the `ip extcommunity-list` command.

The following extcommunity-list types are supported:

- **Route Target (rt)** identifies sites that may receive appropriately tagged routes.
- **Site of Origin (soo)** identifies sites where the switch learned the route.
- **Link Bandwidth (lbw)** advertises BGP link bandwidth.

The `no ip extcommunity-list regexp` and `default ip extcommunity-list regexp` commands delete the specified extended community list by removing the corresponding `ip extcommunity-list regexp` statement from *running-config*.

#### Command Mode

Global Configuration

#### Command Syntax

```
ip extcommunity-list regexp list_name {deny | permit} reg_exp
no ip extcommunity-list regexp list_name {deny | permit} reg_exp
default ip extcommunity-list regexp list_name
```

#### Parameters

- *list\_name* name of the extended community list. Valid input is text.
- permit access is permitted for the specified extended community list.
- deny access is denied for the specified extended community list.
- *reg\_exp* list of communities, formatted as a regular expression. Regular expressions are pattern-matching strings that are composed of text characters and operators.
  - Expressions beginning with **RT:** match the **route target** extended community attribute option.
  - Expressions beginning with **SoO:** match the **site of origin** extended community attribute option.

#### Related Commands

- `route-map`
- `match (route-map)`
- `show ip community-list`
- `show ip extcommunity-list`

#### Example

- This command creates a BGP extended community list that denies routes from route target networks 20-24 and 30-34 in autonomous system 10.

```
switch(config)#ip extcommunity-list regexp list_1 deny RT:10:[2-3][0-4]_
switch(config)#
```



#### 14.5.4.44 ip extcommunity-list

The `ip extcommunity-list` command creates an extended community list to filter VRF routes or for link bandwidth (LBW) advertisement.

The following extcommunity-list types are supported:

- **Route Target (rt)** identifies sites that may receive appropriately tagged routes.
- **Site of Origin (soo)** identifies sites where the switch learned the route.
- **Link Bandwidth (lbw)** advertises BGP link bandwidth.

The `no ip extcommunity-list` and `default ip extcommunity-list` commands delete the specified extended community list by removing the corresponding `ip extcommunity-list` statement from *running-config*.

#### Command Mode

Global Configuration

#### Command Syntax

```
ip extcommunity-list list_name {deny | permit} COMM_1 [COMM_2...COMM_n]
no ip extcommunity-list list_name
default ip extcommunity-list list_name
```

#### Parameters

- *list\_name* name of the extended community list.
- permit access is permitted for the specified community.
- deny access is denied for the specified community.
- COMM\_x extended community attribute. Options include:
  - rt *aa:nn* route target, as specified by autonomous system:network number.
  - rt *ip\_addr:nn* route target, as specified by ip address:network number.
  - soo *aa:nn* Site of Origin, as specified by autonomous system:network number.
  - soo *ip\_addr:nn* site of origin, as specified by ip address:network number.
  - lbw link bandwidth in bits per second.

#### Related Commands

- [route-map](#)
- [match \(route-map\)](#)
- [show ip community-list](#)
- [show ip extcommunity-list](#)

#### Example

- This command creates a BGP extended community list that denies routes from route target 100:250.

```
switch(config)#ip extcommunity-list list_9 deny rt 100:250
switch(config)#
```

#### 14.5.4.45 ip large-community-list regexp

The `ip large-community-list regexp` command creates and configures a BGP access list based on BGP large communities. A BGP large-community access list filters prefixes based on their BGP large community values. The command uses regular expressions to match large communities. Multiple large-community lists with the same name may be specified. To create a large-community list by explicitly specifying one or more communities, use the `ip large-community-list` command.

Large-communities are represented as follows: [ASN]:local-part1:local-part2.

The `no ip large-community-list regexp` and `default ip large-community-list regexp` commands delete the specified large community list. To delete a specific community-list entry, specify the entry in the `no ip large-community-list regexp` command.

##### Command Mode

Global Configuration

##### Command Syntax

```
ip large-community-list regexp list_name {deny | permit} reg_exp
```

```
no ip large-community-list regexp list_name {deny | permit} reg_exp
```

```
default ip large-community-list regexp list_name
```

##### Parameters

- *list\_name* name of the community list. Valid input is text.
- permit access is permitted for the specified community.
- deny access is denied for the specified community.
- *reg\_exp* list of communities, formatted as a regular expression. Regular expressions are pattern-matching strings that are composed of text characters and operators.



**Note:** When using the no form of the command, a regular expression can be used to specify a single entry to be removed from the list, leaving the rest of the list intact. If no entry is specified, the no form of the command removes the entire list.

##### Related Commands

- [route-map](#)
- [match \(route-map\)](#)
- [show ip community-list](#)
- [show ip extcommunity-list](#)

##### Examples

- This command creates a BGP large community list that permits routes from autonomous system 10 with local-part1 value of 20-24 or 30-34.

```
switch(config)#ip large-community-list regexp list_2 permit 10:[2-3]
[0-4]:_
switch(config)#
```

- This command removes the above statement from the large community list named "list\_2," leaving any other statements in the list intact.

```
switch(config)#no ip large-community-list regexp list_2 permit 10:
[2-3]:[0-4]_
switch(config)#
```

- This command deletes the large community list named "list\_2" entirely.

```
switch(config)#no ip large-community-list regexp list_2
```

```
switch(config)#
```

#### 14.5.4.46 match as-range

The **match as-range** command defines the match statement for the peer-filter, based on the match statement the peer-filter accept or reject the incoming peer request. The match statement includes a sequence number, AS number range and a match condition to accept or reject a peer by comparing its remote AS number to the specified range. A peer filter can consist of a single match statement or multiple match statements. The match statement for the peer filter is configured under peer-filter configuration mode.

The **no match as-range** or **default match as-range** command deletes the peer-filter condition for the group from *running-config*.

#### Command Mode

Peer-Filter Configuration

#### Command Syntax

```
[sequence_number] match as-range [as_number1] [- as_number2] result {accept | reject}
group_name
```

```
no [as_number1] [- as_number2] result {accept | reject} group_name
```

```
default [as_number1] [- as_number2] result {accept | reject} group_name
```

#### Parameters

- *sequence\_number* optional sequence number for the match statement; one is automatically created if not assigned. Values range from 0 to 65535.
- *group\_name* name of the peer filter group.
- *as\_number* the autonomous system number, values range from 1 to 4294967295.

#### Example

- These commands define a peer filter that accepts any AS number.

```
switch(config)#peer-filter group1
switch(config-peer-filter-group1)#10 match as-range 1-4294967295 result
accept
switch(config-peer-filter-group1)#
```

- These commands define a peer filter that accepts any AS number within 65000 and 65100 (inclusive) except 65008 and 65009.

```
switch(config)#peer-filter group2
switch(config-peer-filter-group2)#10 match as-range 65008-65009 result
reject
switch(config-peer-filter-group2)#20 match as-range 65000-651000 result
accept
switch(config-peer-filter-group2)#
```

- These commands define a peer filter that accepts 3 specific remote AS numbers.

```
switch(config)#peer-filter group3
eswitch(config-peer-filter-group3)#10 match as-range 65003 result
accept
switch(config-peer-filter-group3)#20 match as-range 65007 result accept
switch(config-peer-filter-group3)#30 match as-range 65009 result accept
switch(config-peer-filter-group3)#
```

### 14.5.4.47 maximum-paths (BGP)

The `maximum-paths` command controls the maximum number of parallel BGP routes that the switch supports. The default maximum is one route. The command provides an ECMP (equal cost multiple paths) parameter that controls the number of equal-cost paths that the switch stores in the routing table for each route.

For paths to be considered equal, they must have the same weight, local preference, AS-path length, and origin. To require that they also have the same multi-exit discriminator (MED) value, use the `bgp always-compare-med` command. To require that their AS paths have the same contents, use the `no bgp bestpath as-path multipath-relax` command.

The `no maximum-paths` and `default maximum-paths` commands restore the default values of the maximum number of parallel routes and the maximum number of ECMP paths by removing the corresponding `maximum paths` command from *running-config*.

#### Command Mode

Router-BGP Configuration

#### Command Syntax

```
maximum-paths paths [ecmp ecmp_paths]
```

```
no maximum-paths
```

```
default maximum-paths
```

#### Parameters

- *paths* maximum number of parallel routes. Default value is 1. Value must be less than or equal to the maximum number of ECMP paths.
- *ecmp\_paths* maximum number of ECMP paths for each route. Default is maximum value as defined belows.

Value for each parameter ranges from 1 to the number of interfaces available per ECMP group, which is platform dependent.

- **Arad:** Values range from 1 to 128. Default value is 128.
- **FM6000:** Values range from 1 to 32. Default value is 32.
- **PetraA:** Values range from 1 to 16. Default value is 16.
- **Trident:** Values range from 1 to 32. Default value is 32.
- **Trident II:** Values range from 1 to 128. Default value is 128.

#### Examples

- These commands configure the maximum number of BGP parallel paths to 12 without changing the default equal cost multipath (ECMP) value.

```
switch(config)#router bgp 1
switch(config-router-bgp)#maximum-paths 12
switch(config-router-bgp)#
```

- These commands configure the maximum number of BGP parallel routes to 2, with a maximum of 4 ECMP paths for each route.

```
switch(config)#router bgp 1
switch(config-router-bgp)#maximum-paths 2 ecmp 4
switch(config-router-bgp)#
```

---

#### 14.5.4.48 neighbor activate

The **neighbor activate** command defines the configuration mode address family activation state of a specified address that is configured as a BGP neighbor. The switch sends the following announcements to addresses active in an address family:

- **IPv4 address family:** IPv4 capability and all network advertisements with IPv4 prefixes.
- **IPv6 address family:** IPv6 capability and all network advertisements with IPv6 prefixes.

The **bgp default** command configures the default address family activation state of addresses configured as BGP neighbors. The **neighbor activate** and **no neighbor activate** commands override the neighbor's default activation state within the configuration mode address family.

- **neighbor activate:** the specified address is active in the address family.
- **no neighbor activate:** the specified address is not active in the address family.

The **default neighbor activate** command removes the corresponding **neighbor activate** or **no neighbor activate** command from **running-config**, restoring the default address family activation state for the specified neighbor address.

#### Command Mode

Router-BGP Address-Family Configuration

#### Command Syntax

```
neighbor neighbor_ID activate
no neighbor neighbor_ID activate
default neighbor neighbor_ID activate
```

#### Parameters

- *neighbor\_ID* neighbor's IPv4 or IPv6 address or peer group name.

#### Limitations

The switch supports the advertisement of networks with IPv6 prefixes to IPv4 transport neighbors. The switch does *not* support the advertisement of networks with IPv4 prefixes to IPv6 transport neighbors.

#### Example

- These commands activate the advertising of specified neighbors during IPv4 peering sessions, then display the result.

```
switch(config)#router bgp 1
switch(config-router-bgp)#no address-family ipv4
switch(config-router-bgp-af)#neighbor 172.41.18.15 activate
switch(config-router-bgp-af)#neighbor 172.49.22.6 activate
switch(config-router-bgp-af)#no neighbor 172.15.21.18 activate
switch(config-router-bgp-af)#show active
 address-family ipv4
 no neighbor 172.15.21.18 activate
 neighbor 172.49.22.6 activate
 neighbor 172.41.18.15 activate
switch(config-router-bgp-af)#exit
switch(config-router-bgp)#
```

#### 14.5.4.49 neighbor allows-in

By default, BGP drops received routes if their autonomous system (AS) paths contain the AS number (ASN) of the switch. The **neighbor allows-in** command configures the switch to accept routes from the specified BGP neighbor even if their AS paths contain the ASN of the switch itself. Optionally, the command can also configure the maximum number of times that the switch's ASN can appear in a route before it is dropped.

The **no neighbor allows-in** command configures the default behavior (dropping BGP routes that contain the ASN of the switch).

The default **neighbor allows-in** command applies the system default configuration for individual neighbors and applies the peer group's setting for neighbors that are members of a peer group.

The **no neighbor** command removes all configuration commands for the BGP neighbor at the specified address.

#### Command Mode

Router-BGP Configuration

#### Command Syntax

```
neighbor neighbor_ID allows-in [asn_quantity]
```

```
no neighbor neighbor_ID allows-in
```

```
default neighbor neighbor_ID allows-in
```

#### Parameters

- *neighbor\_ID* neighbor's IPv4 or IPv6 address or peer group name.
- *asn\_quantity* number of repetitions of the switch's ASN allowed in the AS path of routes received from the specified BGP neighbor. Values range from 1 to 10. Default is 3.

#### Related Commands

This command is used on a customer edge router that is part of a split AS; to address the problem at the provider end, use the **neighbor as-path remote-as replace out** command.

#### Example

- These commands configure the switch to accept routes from the BGP neighbor at 192.168.1.30 which contain the switch's ASN in their AS paths as many as 3 times.

```
switch(config)#router bgp 1
switch(config-router-bgp)#neighbor 192.168.1.30 allows-in
switch(config-router-bgp)#
```

---

#### 14.5.4.50 neighbor as-path remote-as replace out

By default, BGP drops received routes if their autonomous system (AS) paths contain the AS number (ASN) of the switch. In a split AS sharing route advertisements through a provider network, this can result in valid routes being dropped. The **neighbor as-path remote-as replace out** command configures a provider edge switch to replace the customer's AS with its own in route advertisements sent to neighbors in that AS.

The **no neighbor as-path remote-as replace out** command configures the default behavior (leaving the customer's AS in the AS path attribute of routes advertised to the specified neighbor).

The **default neighbor as-path remote-as replace out** command applies the system default configuration for individual neighbors and applies the peer group's setting for neighbors that are members of a peer group.

The **no neighbor** command removes all configuration commands for the BGP neighbor at the specified address.

#### Command Mode

Router-BGP Configuration

#### Command Syntax

```
neighbor neighbor_ID as-path remote-as replace out
no neighbor neighbor_ID as-path remote-as replace out
default neighbor neighbor_ID as-path remote-as replace out
```

#### Parameters

- *neighbor\_ID* neighbor's IPv4 or IPv6 address or peer group name.

#### Related Commands

This command is used on a provider edge router forwarding BGP routes to a customer in a split AS; to address the problem at the customer end, use the **neighbor allowas-in** command.

#### Example

- These commands configure the switch to substitute its local ASN for the ASN of the BGP neighbor at 192.168.2.15 in BGP routes advertised to that neighbor.

```
switch(config)#router bgp 1
switch(config-router-bgp)#neighbor 192.168.2.15 as-path remote-as
replace out
switch(config-router-bgp)#
```



### 14.5.4.51 neighbor auto-local-addr

The **neighbor auto-local-addr** command configures the switch to automatically determine the local address to be used for the non-transport address family in NLRIs sent to the specified neighbor or peer group. This allows IPv4 NLRIs to be carried over IPv6 transport, or IPv6 NLRIs to be carried over IPv4 transport.

The **no neighbor auto-local-addr** command applies the system default configuration.

The **default neighbor auto-local-addr** command applies the system default configuration for individual neighbors, and applies the peer group's setting for neighbors that are members of a peer group.

 **Note:** While this feature works well in eBGP deployments in which the pairing routers are directly connected and have matching IP address configurations, multi-hop eBGP or iBGP deployments may require manual local address configuration.

To explicitly configure a local address for the non-transport address family for a specific neighbor or peer group, use the **neighbor local-v4-addr** command for IPv6 neighbors, or the **neighbor local-v6-addr** for IPv4 neighbors.

#### Command Mode

Router-BGP Configuration

#### Command Syntax

```
neighbor neighbor_ID auto-local-addr
no neighbor neighbor_ID auto-local-addr
default neighbor neighbor_ID auto-local-addr
```

#### Parameters

- *neighbor\_ID* neighbor's IPv4 or IPv6 address or peer group name.

#### Example

- For the IPv6 neighbor at 2001:0DB8:c2a4:1761::2, these commands configure the switch to automatically determine the IPv4 NLRI value to be sent during peering sessions.

```
switch(config)#router bgp 1
switch(config-router-bgp)#neighbor 2001:0DB8:c2a4:1761::2 auto-local-addr
switch(config-router-bgp)#
```

---

#### 14.5.4.52 neighbor default-originate

The **neighbor default-originate** command advertises a default route to a BGP neighbor or peer group. This default route overrides the default route advertised by any other means to the specified neighbor or peer group. However, the update generated by **neighbor default-originate** is not processed by neighbor route map out policies.

If a route map is specified in this command, its set clauses are used to modify attributes of the exported default route, but its match clauses are not used to conditionally advertise the route. The default route is always advertised to the specified neighbor.

The **no neighbor default-originate** command applies the system default configuration.

The **default neighbor default-originate** command applies the system default configuration for individual neighbors and applies the peer group's setting for neighbors that are members of a peer group.

The **no neighbor** command removes all configuration commands for the neighbor at the specified address.

#### Command Mode

Router-BGP Configuration Router-BGP Address-Family Configuration

#### Command Syntax

```
neighbor neighbor_ID default-originate [MAP]
no neighbor neighbor_ID default-originate
default neighbor neighbor_ID default-originate
```

#### Parameters

- *neighbor\_ID* neighbor's IPv4 or IPv6 address or peer group name.
- MAP specifies route map that modifies attributes of the exported default route. Options include:
  - <no parameter> attributes are not modified by a route map.
  - route-map *map\_name* attributes set by specified route map are assigned to the exported default route.

#### Example

- These commands advertise a default route to the BGP neighbor at 192.168.14.5.

```
switch(config)#router bgp 9
switch(config-router-bgp)#neighbor 192.168.14.5 default-originate
switch(config-router-bgp)#
```

### 14.5.4.53 neighbor description

The **neighbor description** command associates descriptive text with the specified peer or peer group.

The **no neighbor description** command removes the text association from the specified peer or peer group.

The **default neighbor description** command removes the text association from the specified peer for individual neighbors, and applies the peer group's description to neighbors that are members of a peer group.

The **no neighbor** command removes all configuration commands for the neighbor at the specified address or for the specified peer group.

#### Command Mode

Router-BGP Configuration

#### Command Syntax

```
neighbor neighbor_ID description description_string
```

```
no neighbor neighbor_ID description
```

```
default neighbor neighbor_ID description
```

#### Parameters

- *neighbor\_ID* neighbor's IPv4 or IPv6 address or peer group name.
- *description\_string* text string to be associated with the neighbor or peer group.

#### Example

- These commands associate the string "PEER\_1" with the peer located at 192.168.1.30.

```
switch(config)#router bgp 1
switch(config-router-bgp)#neighbor 192.168.1.30 description PEER_1
switch(config-router-bgp)#
```

---

#### 14.5.4.54 neighbor ebgp-multihop

The **neighbor ebgp-multihop** command programs the switch to accept and attempt BGP connections to the external peers residing on networks not directly connected to the switch. The command does not establish the multihop if the only route to the peer is the default route (0.0.0.0).

The **no neighbor ebgp-multihop** command applies the system default configuration.

The **default neighbor ebgp-multihop** command applies the system default configuration for individual neighbors, and applies the peer group's setting for neighbors that are members of a peer group.

The **no neighbor** command removes all configuration commands for the neighbor at the specified address.

##### Command Mode

Router-BGP Configuration

##### Command Syntax

```
neighbor neighbor_ID ebgp-multihop [hop_number]
```

```
no neighbor neighbor_ID ebgp-multihop
```

```
default neighbor neighbor_ID ebgp-multihop
```

##### Parameters

- *neighbor\_ID* neighbor's IPv4 or IPv6 address or peer group name.
- *hop\_number* time-to-live (hops). Values range from 1 to 255. Default value is 255.

##### Example

- These commands configure the switch to accept and attempt BGP connections to the external peer located at 192.168.1.30, setting the hop limit to 32.

```
switch(config)#router bgp 1
switch(config-router-bgp)#neighbor 192.168.1.30 ebgp-multihop 32
switch(config-router-bgp)#
```

#### 14.5.4.55 neighbor enforce-first-as

The **neighbor enforce-first-as** command causes a forced comparison of the first autonomous system (AS) in the AS path of eBGP routes received from a specified BGP peer or peer group to the configured remote external peer autonomous system number (ASN). Updates from the specified eBGP peers that do not include an ASN as first AS path (in the AS\_PATH attribute) are discarded.

This behavior is enabled globally by default upon BGP configuration, and disabled for the specified neighbor or peer group by the no form of the command. To configure first AS enforcement globally, use the `bgp enforce-first-as` command.

##### Command Mode

Router-BGP Configuration

##### Command Syntax

```
neighbor neighbor_ID enforce-first-as
no neighbor neighbor_ID enforce-first-as
default neighbor neighbor_ID enforce-first-as
```

##### Parameters

- *neighbor\_ID* neighbor's IPv4 or IPv6 address or peer group name.

##### Example

- This command disables enforcement of the first BGP AS for the neighbors in peer group "region-3."

```
switch(config-router-bgp) #no neighbor region-3 enforce-first-as
switch(config-router-bgp) #
```

---

#### 14.5.4.56 neighbor export-localpref

The **neighbor export-localpref** command determines the LOCAL\_PREF value that is sent in BGP UPDATE packets to the specified peer or peer group. This command has no effect on external peers.

The **no neighbor export-localpref** command resets the LOCAL\_PREF value to the system default of 100 in packets sent to the specified peer or peer group.

The **default neighbor export-localpref** command resets the LOCAL\_PREF value to the system default of 100 for individual neighbors, and applies the peer groups's setting for neighbors that are members of a peer group.

The **no neighbor** command removes all configuration commands for the neighbor at the specified address or the specified peer group.

##### Command Mode

Router-BGP Configuration

##### Command Syntax

```
neighbor neighbor_ID export-localpref preference
```

```
no neighbor neighbor_ID export-localpref
```

```
default neighbor neighbor_ID export-localpref
```

##### Parameters

- *neighbor\_ID* neighbor's IPv4 or IPv6 address or peer group name.
- *preference* preference value. Values range from 0 to 4294967295.

##### Example

- This command configures the switch to fill the LOCAL\_PREF field with 200 in UPDATE packets that it sends to the peer located at 10.1.1.45.

```
switch(config)#router bgp 1
switch(config-router-bgp)#neighbor 10.1.1.45 export-localpref 200
switch(config-router-bgp)#
```

#### 14.5.4.57 neighbor graceful-restart

The **neighbor graceful-restart** command enables the BGP graceful restart mode for a specified BGP neighbor or peer group. When graceful restart mode is enabled, the switch retains routes from neighbors that are capable of graceful restart. By default, graceful restart is enabled for all BGP neighbors. Individual neighbor configuration takes precedence over the global configuration.

The **no neighbor graceful-restart** and **default neighbor graceful-restart** commands disable graceful restart mode for the specified BGP neighbor or peer group by removing the corresponding **no neighbor graceful-restart** command from **running-config**.

##### Command Mode

Router-BGP Configuration

##### Command Syntax

```
neighbor neighbor_ID graceful-restart
no neighbor neighbor_ID graceful-restart
default neighbor neighbor_ID graceful-restart
```

##### Parameters

- *neighbor\_ID* neighbors's IPv4 or IPv6 address or peer group name.

##### Example

- This command enables BGP graceful restart mode for the neighbor with the IP address 192.168.12.1.

```
switch(config)#router bgp 1
switch(config-router-bgp)#neighbor 192.168.12.1 graceful-restart
switch(config-router-bgp)#
```

---

#### 14.5.4.58 neighbor graceful-restart-helper

The **neighbor graceful-restart helper** command enables BGP graceful restart helper mode for the specified BGP neighbor or peer group. When graceful restart helper mode is enabled, the switch will retain routes from neighbors which are capable of graceful restart while those neighbors are restarting BGP. Graceful restart is enabled by default for all BGP neighbors. To configure graceful restart helper mode for all BGP neighbors, use the [graceful-restart-helper](#) command. Individual neighbor configuration takes precedence over the global configuration.

The **no neighbor graceful-restart helper** command disables graceful restart helper mode for the specified BGP neighbor or peer group. The **default neighbor graceful-restart helper** command enables graceful restart helper mode for the specified BGP neighbor or peer group by removing the corresponding **no neighbor graceful-restart helper** command from *running-config*.

##### Command Mode

Router-BGP Configuration

##### Command Syntax

```
neighbor neighbor_ID graceful-restart helper long-lived
no neighbor neighbor_ID graceful-restart helper long-lived
default neighbor neighbor_ID graceful-restart helper long-lived
```

##### Parameters

- *neighbor\_ID* neighbor's IPv4 or IPv6 address or peer group name.
- long-lived Enables long lived graceful restart helper mode.

##### Example

- These commands disable graceful restart helper mode for the neighbor at 192.168.12.1.

```
switch(config)#router bgp 1
switch(config-router-bgp)#no neighbor 192.168.12.1 graceful-restart-
helper
switch(config-router-bgp)#
```



#### 14.5.4.59 neighbor import-localpref

The **neighbor import-localpref** command determines the local preference assigned to routes received from the specified external peer or peer group. This command has no effect on routes received from internal peers. **no neighbor import-localpref**

The command resets the local preference to the default of 100 for routes received from the specified peer or peer group.

The **default neighbor import-localpref** command resets the local preference to the default of 100 for individual neighbors, and applies the peer group's setting for neighbors that are members of a peer group.

The **no neighbor** command removes all configuration commands for the neighbor at the specified address.

##### Command Mode

Router-BGP Configuration

##### Command Syntax

```
neighbor neighbor_ID import-localpref preference
```

```
no neighbor neighbor_ID import-localpref
```

```
default neighbor neighbor_ID import-localpref
```

##### Parameters

- *neighbor\_ID* neighbor's IPv4 or IPv6 address or peer group name.
- *preference* preference value. Values range from 0 to 4294967295.

##### Example

- These commands configure the switch to assign a local preference of 50 to routes received from the peer located at 192.168.1.30.

```
switch(config)#router bgp 1
switch(config-router-bgp)#neighbor 192.168.1.30 import-localpref 50
switch(config-router-bgp)#
```

---

#### 14.5.4.60 neighbor local-as

The **neighbor local-as** command enables AS\_PATH attribute modification for received eBGP routes, allowing the switch to appear as a member of a different AS to external peers. Arista switches do not prepend the local AS number to routes received from the eBGP neighbor; currently, we implement the command only as **neighbor local-as no-prepend replace-as**.

The **no neighbor local-as** command disables AS\_PATH modification for the specified peer or peer group. The **default neighbor local-as** command disables AS\_PATH modification for individual neighbors, and applies the peer groups setting for neighbors that are members of a peer group.

##### Command Mode

Router-BGP Configuration

##### Command Syntax

```
neighbor neighbor_ID local-as as_id no-prepend replace-as
no neighbor neighbor_ID local-as
default neighbor neighbor_ID local-as
```

##### Parameters

- *neighbor\_ID* neighbor's IPv4 or IPv6 address or peer group name.
- *as\_id* AS number that is sent in outbound routing updates in place of the actual AS of the switch. Values range from 1 to 4294967295.

This parameter cannot be set to the switch's AS number or to any AS number in the peer's network.

##### Example

- For the neighbor at 10.13.64.1, these commands remove AS 300 from outbound routing updates and replace it with AS 600.

```
switch(config)#router bgp 300
switch(config-router-bgp)#neighbor 10.13.64.1 local-as 600 no-prepend
replace-as
switch(config-router-bgp)#
```

#### 14.5.4.61 neighbor local-v4-addr

The **neighbor local-v4-addr** command specifies the next-hop value that the switch sends as the IPv4 NLRI value to neighbors with whom IPv6 transport peering is established.

The **no neighbor local-v4-addr** command applies the system default configuration.

The **default neighbor local-v4-addr** command applies the system default configuration for individual neighbors, and applies the peer group's setting for neighbors that are members of a peer group.

To configure the switch to automatically determine the IPv4 address to be sent as the next-hop in IPv4 NLRI to an IPv6 neighbor, use the **neighbor auto-local-addr** command.

#### Command Mode

Router-BGP Configuration

#### Command Syntax

```
neighbor neighbor_ID local-v4-addr ipv4_local
no neighbor neighbor_ID local-v4-addr
default neighbor neighbor_ID local-v4-addr
```

#### Parameters

- *neighbor\_ID* neighbor's IPv6 address or peer group name.
- *ipv4\_local* next hop address.

#### Example

- For the neighbor at 2001:0DB8:c2a4:1761::2, these commands specify an IPv4 NLRI value of 10.7.5.11 to be sent during IPv6 transport peering sessions.

```
switch(config)#router bgp 1
switch(config-router-bgp)#neighbor 2001:0DB8:c2a4:1761::2 local-v4-
addr
10.7.5.11
switch(config-router-bgp)#
```

---

#### 14.5.4.62 neighbor local-v6-addr

The **neighbor local-v6-addr** command specifies the next-hop value that the switch sends as the IPv6 NLRI value to neighbors with which IPv4 transport peering is established.

In IPv6 peering sessions, the switch sends the global IPv6 address of the interface that is used to transmit BGP updates.

The **no neighbor local-v6-addr** command applies the system default configuration.

The **default neighbor local-v6-addr** command applies the system default configuration for individual neighbors, and applies the peer group's setting for neighbors that are members of a peer group.

#### Command Mode

Router-BGP Configuration

#### Command Syntax

```
neighbor neighbor_ID local-v6-addr ipv6_local
```

```
no neighbor neighbor_ID local-v6-addr
```

```
default neighbor neighbor_ID local-v6-addr
```

#### Parameters

- *neighbor\_ID* neighbor's IPv4 address or peer group name.
- *ipv6\_local* next hop address (A:B:C:D:E:F:G:H).

#### Example

- For the neighbor at 10.7.5.11, these commands specify an IPv6 NLRI value that is sent during IPv4 transport peering sessions.

```
switch(config)#router bgp 1
switch(config-router-bgp)#neighbor 10.7.5.11 local-v6-addr
2001:0DB8:c2a4:1761::2
switch(config-router-bgp)#show active
router bgp 1
 bgp log-neighbor-changes
 bgp default ipv6-unicast
 neighbor 10.7.5.11 local-v6-addr 2001:0DB8:c2a4:1761::2
switch(config-router-bgp)#
```

### 14.5.4.63 neighbor maximum-routes

The **neighbor maximum-routes** command determines the number of BGP routes the switch accepts from a specified neighbor and defines an action when the limit is exceeded. The default value is 12,000. To remove the maximum routes limit, select a limit of zero.

When the number of routes received from a peer exceeds the limit, the switch generates an error message. This command can also configure the switch to disable peering with the neighbor. In this case, the neighbor state is reset only through a `clear ip bgp` command.

The **no neighbor maximum-routes** command applies the system default maximum-routes value of 12,000 for the specified peer.

The **default neighbor maximum-routes** command applies the system default value for individual neighbors, and applies the peer group's setting for neighbors that are members of a peer group.

The **no neighbor** command removes all configuration commands for the neighbor at the specified address.

#### Command Mode

Router-BGP Configuration

#### Command Syntax

```
neighbor neighbor_ID maximum-routes quantity [ACTION]
```

```
no neighbor neighbor_ID maximum-routes
```

```
default neighbor neighbor_ID maximum-routes
```

#### Parameters

- *neighbor\_ID* neighbor's IPv4 or IPv6 address or peer group name.
- *quantity* maximum number of routes. Values include:
  - **0** the switch does not define a route limit.
  - **1 to 4294967294** maximum number of routes.
- ACTION switch action when the route limit is exceeded. Values include:
  - <no parameter> peering is disabled and an error message is generated.
  - warning-only peering is not disabled, but an error message is generated.

#### Example

- This command configures the switch to accept 15000 routes for the neighbor at 10.3.16.210. If the neighbor exceeds 15000 routes, the switch disables peering with the neighbor.

```
switch(config)#router bgp 1
switch(config-router-bgp)#neighbor 110.3.16.210 maximum-routes 15000
switch(config-router-bgp)#
```

---

#### 14.5.4.64 neighbor next-hop-peer

The **neighbor next-hop-peer** command configures the switch to list the peer address as the next hop in routes that it receives from the specified peer BGP-speaking neighbor or members of the specified peer group. This command overrides the next hop for all routes received from this neighbor or peer group.

The **no neighbor next-hop-peer** command applies the system default (no next-hop override) for the specified peer.

The **default neighbor next-hop-peer** command applies the system default for individual neighbors and applies the peer group's setting for neighbors that are members of a peer group.

The **no neighbor** command removes all configuration commands for the neighbor at the specified address or the specified peer group.

##### Command Mode

Router-BGP Configuration

##### Command Syntax

```
neighbor neighbor_ID next-hop-peer
no neighbor neighbor_ID next-hop-peer
default neighbor neighbor_ID next-hop-peer
```

##### Parameters

- *neighbor\_ID* neighbor's IPv4 or IPv6 address or peer group name.

##### Example

- This command configures the peer address of 10.3.2.24 as the next hop for routes advertised to the switch from the peer BGP neighbor.

```
switch(config)#router bgp 9
switch(config-router-bgp)#neighbor 10.3.2.24 next-hop-peer
switch(config-router-bgp)#
```

#### 14.5.4.65 neighbor next-hop-self

The **neighbor next-hop-self** command configures the switch to list its address as the next hop in routes that it advertises to the specified BGP-speaking neighbor or neighbors in the specified peer group. This is used in networks where BGP neighbors do not directly access all other neighbors on the same subnet.

The **no neighbor next-hop-self** command applies the system default (no next-hop override) for the specified peer.

The **default neighbor next-hop-self** command applies the system default for individual neighbors and applies the peer group's setting for neighbors that are members of a peer group.

The **no neighbor** command removes all configuration commands for the neighbor at the specified address or for the specified peer group.

##### Command Mode

Router-BGP Configuration

##### Command Syntax

```
neighbor neighbor_ID next-hop-self
no neighbor neighbor_ID next-hop-self
default neighbor neighbor_ID next-hop-self
```

##### Parameters

- *neighbor\_ID* neighbor's IPv4 or IPv6 address or peer group name.

##### Example

- This command configures the switch as the next hop for the peer at 10.4.1.30.

```
switch(config)#router bgp 1
switch(config-router-bgp)#neighbor 10.4.1.30 next-hop-self
switch(config-router-bgp)#
```

---

#### 14.5.4.66 neighbor out-delay

The **neighbor out-delay** command sets the period of time that a route update for the specified neighbor must be in the routing table before the switch exports it to BGP. The out delay interval is used for bundling routing updates.

The **no neighbor out-delay** command applies the system default (out-delay value of zero) for the specified peer.

The **default neighbor out-delay** command applies the system default for individual neighbors and applies the peer group's setting for neighbors that are members of a peer group.

The **no neighbor** command removes all configuration commands for the specified neighbor.

##### Command Mode

Router-BGP Configuration

##### Command Syntax

```
neighbor neighbor_ID out-delay delay_time
```

```
no neighbor neighbor_ID out-delay delay_time
```

```
default neighbor neighbor_ID out-delay delay_time
```

##### Parameters

- *neighbor\_ID* neighbor's IPv4 or IPv6 address or peer group name.
- *delay\_time* the out delay period (seconds). Values range from 0 to 600. Default value is 0.

##### Example

- These commands set the out delay period to 5 seconds for the connection with the peer at 10.24.15.9.

```
switch(config)#router bgp 1
switch(config-router-bgp)#neighbor 10.24.15.9 out-delay 5
switch(config-router-bgp)#
```



### 14.5.4.67 neighbor passive

The **neighbor passive** command sets the TCP connection for the specified BGP neighbor or peer group to passive mode. When the peer's transport connection mode is set to passive, it accepts TCP connections for BGP but does not initiate them.

The **no neighbor passive** command sets the specified BGP neighbor or peer group to active connection mode. BGP peers in active mode can both accept and initiate TCP connections for BGP. This is the default behavior.

The **default neighbor passive** command restores the default connection mode. The default mode is **active** for individual BGP peers, or the mode inherited from the peer group for peer group members.

#### Command Mode

Router-BGP Configuration

#### Command Syntax

```
neighbor neighbor_ID passive
no neighbor neighbor_ID passive
default neighbor neighbor_ID passive
```

#### Parameters

- *neighbor\_ID* neighbor's IPv4 or IPv6 address or peer group name.

#### Example

- These commands configure the neighbor at IP address 10.2.2.14 to not initiate TCP connections for BGP peering.

```
switch(config)#router bgp 300
switch(config-router-bgp)#neighbor 10.2.2.14 passive
switch(config-router-bgp)#
```

---

#### 14.5.4.68 neighbor password

The **neighbor password** command enables authentication on a TCP connection with a BGP peer. The plain-text version of the password is a string, up to 8 bytes in length. Peers must use the same password to ensure proper communication.

**Running-config** displays the encrypted version of the password. The encryption scheme is not strong by cryptographic standards; encrypted passwords should be treated in the same manner as plain-text passwords.

The **no neighbor password** command applies the system default for the specified peer, removing the neighbor password from the configuration and disabling authentication with the specified peer.

The **default neighbor password** command applies the system default for individual neighbors and applies the peer group's setting for neighbors that are members of a peer group.

The **no neighbor password** and **default neighbor password** commands remove the neighbor password from the configuration, disabling authentication with the specified peer.

The **no neighbor** command removes all configuration commands for the neighbor at the specified address.

#### Command Mode

Router-BGP Configuration

#### Command Syntax

```
neighbor neighbor_ID password [ENCRYPT_LEVEL] key_text
```

```
no neighbor neighbor_ID password
```

```
default neighbor neighbor_ID password
```

#### Parameters

- *neighbor\_ID* neighbor's IPv4 or IPv6 address or peer group name.
- ENCRYPT\_LEVEL the encryption level of the *key\_text* parameter. Values include:
  - <no parameter> the *key\_text* is in clear text.
  - 0 the *key\_text* is in clear text. Equivalent to the <no parameter> case.
  - 7 the *key\_text* is MD5-encrypted.
- *key\_text* the password.

#### Example

- This command specifies a password in clear text.

```
switch(config)#router bgp 1
switch(config-router-bgp)#neighbor 10.25.25.13 password 0 code123
switch(config-router-bgp)#
```

**Running-config** stores the password as an encrypted string.

#### 14.5.4.69 neighbor peer group (create)

Peer groups allow the user to apply settings to a group of BGP neighbors simultaneously. Once a peer group is created, the group name can be used as a parameter in neighbor configuration commands, and the configuration will be applied to all members of the group. Settings applied to an individual neighbor in the peer group override group settings.

The **neighbor peer group (create)** command is used to create static BGP peer groups. Static peer groups are peer groups whose members are added manually. To assign BGP neighbors to a static peer group, use the **neighbor peer group (neighbor assignment)** command. To create a dynamic peer group, use the **bgp listen range** command.

The **no neighbor peer group (create)** and **default neighbor peer group (create)** commands remove the specified static peer group from *running-config*. When a static peer group is deleted, the neighbors that were members of that peer group lose any configuration that was inherited from the peer group. The no form of the **bgp listen range** command removes a dynamic peer group.

The **no neighbor** command removes all configuration commands for the specified neighbor.

#### Command Mode

Router-BGP Configuration

#### Command Syntax

```
neighbor group_name peer group
no neighbor group_name peer group
default neighbor group_name peer group
```

#### Parameters

- *group\_name* peer group name.

#### Examples

- These commands create a BGP peer group called “bgpgroup1,” assign several neighbors to the group, apply a route map, and adjust the configuration for one group member.

```
switch(config)#router bgp 9
switch(config-router-bgp)#neighbor bgpgroup1 peer group
switch(config-router-bgp)#neighbor 10.1.1.1 peer group bgpgroup1
switch(config-router-bgp)#neighbor 10.2.2.2 peer group bgpgroup1
switch(config-router-bgp)#neighbor 10.3.3.3 peer group bgpgroup1
switch(config-router-bgp)#neighbor bgpgroup1 route-map corporate in
switch(config-router-bgp)#neighbor 10.3.3.3 maximum-routes 5000
switch(config-router-bgp)#show active
router bgp 9
bgp log-neighbor-changes
 neighbor bgpgroup1 peer group
 neighbor bgpgroup1 route-map corporate in
 neighbor bgpgroup1 maximum-routes 12000
 neighbor 10.1.1.1 peer group bgpgroup1
 neighbor 10.2.2.2 peer group bgpgroup1
 neighbor 10.3.3.3 peer group bgpgroup1
 neighbor 10.3.3.3 maximum-routes 5000
switch(config-router-bgp)#
```

- This command removes peer group “bgpgroup1” from *running-config*. The group members remain, but all settings that group members inherited from the peer group are removed.

```
switch(config-router-bgp)#no neighbor bgpgroup1 peer group
switch(config-router-bgp)#show active
```

---

```
router bgp 9
 bgp log-neighbor-changes
 neighbor 10.1.1.1 maximum-routes 12000
 neighbor 10.2.2.2 maximum-routes 12000
 neighbor 10.3.3.3 maximum-routes 5000
switch(config-router-bgp)#
```

### 14.5.4.70 neighbor peer group (neighbor assignment)

Peer groups allow the user to apply settings to a group of BGP neighbors simultaneously. Once a peer group is created, the group name can be used as a parameter in neighbor configuration commands, and the configuration will be applied to all members of the group. Settings applied to an individual neighbor in the peer group override group settings.

The **neighbor peer group (neighbor assignment)** command is used to assign BGP neighbors to an existing static peer group. To create a static peer group, use the **neighbor peer group (create)** command. A neighbor can only belong to one peer group, so issuing this command for a neighbor that is already a member of another group will remove it from that group.

The **no neighbor peer group** and **default neighbor peer group** commands remove the specified neighbor from all peer groups. When a neighbor is removed from a peer group, the neighbor retains the configuration inherited from the peer group.

The **no neighbor** command removes all configuration commands for the specified neighbor.

#### Command Mode

Router-BGP Configuration

#### Command Syntax

```
neighbor NEIGHBOR_ADDR peer group group_name
no neighbor NEIGHBOR_ADDR peer group
default neighbor NEIGHBOR_ADDR peer group
```

#### Parameters

- **NEIGHBOR\_ADDR** address of a neighbor being added to peer group. Values include:
  - *ipv4\_addr* neighbor's IPv4 address.
  - *ipv6\_addr* neighbor's IPv6 address.
- *group\_name* peer group name.

#### Examples

- These commands create a BGP peer group called "bgpgroup1," assign several neighbors to the group, and apply a route map.

```
switch(config)#router bgp 9
switch(config-router-bgp)#neighbor bgpgroup1 peer group
switch(config-router-bgp)#neighbor 10.1.1.1 peer group bgpgroup1
switch(config-router-bgp)#neighbor 10.2.2.2 peer group bgpgroup1
switch(config-router-bgp)#neighbor 10.3.3.3 peer group bgpgroup1
switch(config-router-bgp)#neighbor bgpgroup1 route-map corporate in
switch(config-router-bgp)#
```

- This command removes the neighbor at 1.1.1.1 from the peer group. All settings that neighbor 10.1.1.1 inherited from the peer group are maintained.

```
switch(config-router-bgp)#no neighbor 10.1.1.1 peer group
switch(config-router-bgp)#
```

---

### 14.5.4.71 neighbor remote-as

The **neighbor remote-as** command configures the expected AS number for a neighbor (peer). This configuration is required to establish a neighbor connection. Internal neighbors have the same AS number; external neighbors have different AS numbers.

 **Note:** To establish a BGP session, there must be an IPv4 router ID configured in the same VRF or at least one L3 interface with an IPv4 address in the same VRF. If the VRF contains no L3 interfaces with IPv4 addresses (e.g., in an IPv6-only environment), configure an appropriate router ID using the [router-id \(BGP\)](#) command.

The **no neighbor remote-as** command applies the system default for the specified peer or peer group.

The **default neighbor remote-as** command applies the system default for individual neighbors and applies the peer group's setting for neighbors that are members of a peer group.

The **no neighbor** command removes all configuration commands for the neighbor at the specified address.

#### Command Mode

Router-BGP Configuration

#### Command Syntax

```
neighbor neighbor_ID remote-as as_id
no neighbor neighbor_ID remote-as
default neighbor neighbor_ID remote-as
```

#### Parameters

- *neighbor\_ID* neighbor's IPv4 or IPv6 address or peer group name.
- *as\_id* autonomous system (AS) of the peer. Values range from 1 to 4294967295.

#### Example

- These commands establish a BGP connection with the router at 10.4.3.10 in AS 300.

```
switch(config)#router bgp 9
switch(config-router-bgp)#neighbor 10.4.3.10 remote-as 300
switch(config-router-bgp)#
```

### 14.5.4.72 neighbor remove-private-as

The **neighbor remove-private-as** command removes private autonomous system numbers from outbound routing updates for external BGP (eBGP) neighbors. When the autonomous system path includes only private autonomous system numbers, the **REMOVAL** parameter specifies how the private autonomous system number is removed.

The **no neighbor remove-private-as** command applies the system default (preserves private AS numbers) for the specified peer.

The **default neighbor remove-private-as** command applies the system default for individual neighbors and applies the peer group's setting for neighbors that are members of a peer group.

The **no neighbor** command removes all configuration commands for the neighbor at the specified address.

#### Command Mode

Router-BGP Configuration

#### Command Syntax

```
neighbor neighbor_ID remove-private-as [REMOVAL]
```

```
no neighbor neighbor_ID remove-private-as
```

```
default neighbor neighbor_ID remove-private-as
```

#### Parameters

- *neighbor\_ID* neighbor's IPv4 or IPv6 address or peer group name.
- REMOVAL specifies removal of all private AS numbers when the AS path contains only private AS numbers. Values include:
  - all removes all private AS numbers from AS path in outbound updates.
  - all replace-as all private AS numbers in AS path are replaced with router's local AS number.

 **Note:** This command does not support a mix of public and private AS numbers.

#### Example

- These commands program the switch to remove all private AS numbers from outbound routing updates for the eBGP neighbor at 10.5.2.11 only if the AS path does not contain any public AS number.

```
switch(config)#router bgp 9
switch(config-router-bgp)#neighbor 10.5.2.11 remove-private-as
switch(config-router-bgp)#
```

- This command replaces all private AS numbers in the AS path with the switch's local AS number.

```
switch(config)#router bgp 9
switch(config-router-bgp)#neighbor 10.5.2.11 remove-private-as all
replace-as
switch(config-router-bgp)#
```

---

### 14.5.4.73 neighbor rib-in pre-policy retain

By default, inbound BGP routes that are filtered out by the import policy are still stored on the switch. Because all routes are retained, this allows policies to be changed without resetting BGP sessions. It also allows the switch to display all advertised routes when the **show ip bgp neighbor advertised-routes** command is issued.

The **no neighbor rib-in pre-policy retain** command configures the switch to discard information about routes received from the specified neighbor or group that fail the import policy.

The **neighbor rib-in pre-policy retain** command restores the system default behavior (retaining routes from the specified neighbor or group regardless of import policy).

The **default neighbor rib-in pre-policy retain** command applies the system default (retaining all routes) for individual neighbors and applies the peer group's setting for neighbors that are members of a peer group.

#### Command Mode

Router-BGP Configuration

#### Command Syntax

```
neighbor neighbor_ID rib-in pre-policy retain inbound [SCOPE]
no neighbor neighbor_ID rib-in pre-policy retain inbound
default neighbor neighbor_ID rib-in pre-policy retain inbound
```

#### Parameters

- *neighbor\_ID* neighbor's IPv4 or IPv6 address or peer group name.
- SCOPE determines how routes including the switch's AS number are handled. Values include:
  - <no parameter> routes including the switch's AS number are discarded.
  - all routes including the switch's AS number are retained.

#### Example

- These commands configure the switch to discard information about routes from the neighbor at 10.5.2.23 which are filtered out by the switch's import policies.

```
switch(config)#router bgp 9
switch(config-router-bgp)#no neighbor 10.5.2.23 rib-in pre-policy
retain inbound
switch(config-router-bgp)#
```



#### 14.5.4.74 neighbor route-map (BGP)

The **neighbor route-map** command applies a route map to inbound or outbound BGP routes. When a route map is applied to outbound routes, the switch will advertise only routes matching at least one section of the route map. Only one outbound route map and one inbound route map can be applied to a given neighbor. A new route map applied to a neighbor will replace the previous route map.

The command is available in Router-BGP and Router-BGP-Address-Family configuration modes. The mode in which the command is executed determines the scope of the command:

- In Router-BGP mode, the route map is applied to the specified neighbor in all peering sessions where it is advertised.
- In Router-BGP-Address-Family mode, the route map is applied to the neighbors only in peering sessions corresponding to the configuration-mode address family.

The **no neighbor route-map** command discontinues the application of the specified route map for the specified neighbor and direction. Removing a route map from one direction does not remove it from the other if it has been applied to both.

The **default neighbor route-map** command applies the system default (no route map) for individual neighbors, and applies the peer group's setting for neighbors that are members of a peer group.

##### Command Mode

Router-BGP Configuration

Router-BGP Address-Family Configuration

##### Command Syntax

```
neighbor neighbor_ID route-map map_name DIRECTION
```

##### Parameters

- *neighbor\_ID* neighbor's IPv4 or IPv6 address or peer group name.
- *map\_name* name of a route map.
- DIRECTION routes to which the route map is applied. Options include:
  - in route map is applied to inbound routes.
  - out route map is applied to outbound routes.

##### Example

- This command applies a route map named "inner-map" to a BGP inbound route from 10.5.2.11.

```
switch(config)#router bgp 9
switch(config-router-bgp)#neighbor 10.5.2.11 route-map inner-map in
switch(config-router-bgp)#
```

---

#### 14.5.4.75 neighbor route-reflector-client

Participating BGP routers within an AS communicate eBGP-learned routes to all of their peers, but to prevent routing loops they must not re-advertise iBGP-learned routes within the AS. To ensure that all members of the AS share the same routing information, a fully meshed network topology (in which each member router of the AS is connected to every other member) can be used, but this topology can result in high volumes of iBGP messages when it is scaled. Instead, in larger networks one or more routers can be configured as route reflectors.

A route reflector is configured to re-advertise routes learned through iBGP to a group of BGP neighbors within the AS (its clients), eliminating the need for a fully meshed topology.

The **neighbor route-reflector-client** command configures the switch to act as a route reflector and configures the specified neighbor as one of its clients. Additional clients are specified by re-issuing the command.

The **no neighbor route-reflector-client** and **default neighbor route-reflector-client** commands disable route reflection by deleting the **neighbor route-reflector-client** command from *running-config*.

##### Command Mode

Router-BGP Configuration

##### Command Syntax

```
neighbor neighbor_ID route-reflector-client
no neighbor neighbor_ID route-reflector-client
default neighbor neighbor_ID route-reflector-client
```

##### Parameters

- *neighbor\_ID* neighbor's IPv4 or IPv6 address or peer group name.

##### Related Commands

- [bgp client-to-client reflection](#)
- [bgp route-reflector preserve-attributes](#)

##### Example

- This command configures the switch as a route reflector and the neighbor at 10.5.2.1 as one of its clients.

```
switch(config)#router bgp 9
switch(config-router-bgp)#neighbor 10.5.2.11 route-reflector-client
switch(config-router-bgp)#
```

### 14.5.4.76 neighbor route-to-peer

The **neighbor route-to-peer** command allows BGP to establish a connection to reach the specified peer using kernel routing table information. By default, route-to-peer configuration is enabled for a peer or a peer group.

The **no neighbor route-to-peer** command prevents BGP from using kernel routing table information to establish a BGP connection to reach a peer and the **default neighbor route-to-peer** command enables route-to-peer configuration for a peer or a peer group by removing the corresponding **no neighbor route-to-peer** command from the **running-config**.

If the peer is directly connected, BGP instead uses ARP table or neighbor table information to establish a BGP connection to reach the peer.

#### Command Mode

Router-BGP Configuration

#### Command Syntax

```
neighbor neighbor_ID route-to-peer
no neighbor neighbor_ID route-to-peer
default neighbor neighbor_ID route-to-peer
```

#### Parameters

- *neighbor\_ID* neighbor's IPv4 or IPv6 address or the peer group name.

#### Example

- These commands establish a connection between the switch and the BGP peer located at IP address 172.16.1.1, and prevent BGP from using kernel routing table information to establish a route to that peer.

```
switch(config)#router bgp 64496
switch(config-router-bgp)#no neighbor 172.16.1.1 route-to-peer
switch(config-router-bgp)#neighbor 172.16.1.1 remote-as 100
switch(config-router-bgp)#
```

---

#### 14.5.4.77 neighbor send-community add / remove

The **neighbor send-community add / remove** command modifies the types of community path attributes included for routes in the UPDATE messages advertised to the specified BGP neighbor without having to issue the **no neighbor send-community** command.

##### Command Mode

Router-BGP Configuration

##### Command Syntax

```
neighbor neighbor_ID send-community {add | remove} {extended | large | standard}
```

##### Parameters

- *neighbor\_ID* neighbor's IPv4 or IPv6 address or peer group name.
- **add** appends the specified community path attribute type to the list of community path attribute types sent to the specified neighbor.
- **remove** removes the specified community path attribute type from the list of community path attribute types sent to the specified neighbor.
- **extended** enables (or disables) sending of the extended community path attribute to the specified neighbor.
- **large** enables (or disables) sending of the large community path attribute to the specified neighbor.
- **standard** enables (or disables) sending of the standard community path attribute to the specified neighbor.
- **link-bandwidth** see [neighbor send-community link-bandwidth](#) for a description of this parameter.

##### Guidelines

- If the **neighbor send-community** command has been issued for the neighbor without specifying any community types, that neighbor will receive all community attributes in the routes advertised to it. Using the **neighbor send-community add** command then to add an attribute will cause the switch to send *only* the specified community types in advertised routes. This will result in the other community path attributes no longer being advertised to that BGP peer.
- If all community types are removed using the **neighbor send-community remove** command, the switch will then send routes with all community types. (This behavior is maintained for backward compatibility.) To remove all community path attributes from routes sent to the specified neighbor, use the **no neighbor send-community** command.
- After using this command, issue the **show active** command in Router-BGP Configuration Mode to ensure that the intended attributes are being sent to the specified neighbor.

##### Examples

- These commands configure the switch to send large community attributes in the routes sent to the neighbor at address 10.5.2.24, then add extended community attributes as well.

```
switch(config)#router bgp 9
switch(config-router-bgp)#neighbor 10.5.2.24 send-community large
switch(config-router-bgp)#neighbor 10.5.2.24 send-community add
extended
switch(config-router-bgp)#show active
switch(config-router-bgp)#neighbor 10.5.2.24 send-community add
extended
switch(config-router-bgp)#show active
router bgp 9
 neighbor 10.5.2.24 send-community extended large
 neighbor 10.5.2.24 maximum-routes 12000
switch(config-router-bgp)#
```

- These commands configure the switch to include extended and large community attributes in the routes sent to the neighbor at address 10.5.2.27, then remove the large attribute from the list of community types to be included.

```
switch(config)#router bgp 9
switch(config-router-bgp)#neighbor 10.5.2.27 send-community extended
large
switch(config-router-bgp)#neighbor 10.5.2.27 send-community remove
large
switch(config-router-bgp)#show active
router bgp 600
 neighbor 10.5.2.27 send-community extended
 neighbor 10.5.2.27 maximum-routes 12000
switch(config-router-bgp)#
```

- These commands attempt to configure the switch to remove large community attributes from routes sent to the neighbor at address 10.5.2.28, but send all others. However, because the original command did not specify a list of attributes, the **remove** command has no effect, and all community path attributes are still included.

```
switch(config)#router bgp 9
switch(config-router-bgp)#neighbor 10.5.2.28 send-community
switch(config-router-bgp)#neighbor 10.5.2.28 send-community remove
large
switch(config-router-bgp)#show active
router bgp 600
 neighbor 10.5.2.28 send-community
 neighbor 10.5.2.28 maximum-routes 12000
switch(config-router-bgp)#
```

- These commands configure the switch to send only large community attributes in routes sent to the neighbor at address 10.5.2.29, then attempt to remove the large attribute from sent routes. However, because this removes the last specified attribute, *all* community path attributes (including large) will now be included.

```
switch(config)#router bgp 9
switch(config-router-bgp)#neighbor 10.5.2.29 send-community large
switch(config-router-bgp)#neighbor 10.5.2.28 send-community remove
large
switch(config-router-bgp)#show active
router bgp 600
 neighbor 10.5.2.29 send-community
 neighbor 10.5.2.29 maximum-routes 12000
switch(config-router-bgp)#
```

---

#### 14.5.4.78 neighbor send-community link-bandwidth

The **neighbor send-community link-bandwidth** command is used to locally regenerate the link-bandwidth value to be advertised to a specific BGP neighbor or peer group. When this command is configured the regenerated link-bandwidth value is included in the extended community path attribute in UPDATE messages.

This command is used specifically for local regeneration of the link-bandwidth value. To send an explicitly-configured link-bandwidth value, add an extended community to a route map instead. (see [set extcommunity \(route-map\)](#)) and include extended community attributes in UPDATE messages sent to that neighbor.

 **Note:** The **neighbor send-community** command will override this command and vice-versa.

The **no neighbor send-community** command applies the system default (not sending community attributes in BGP UPDATE messages) for the specified peer.

The **default neighbor send-community** command applies the system default for individual neighbors and applies the peer group's setting for neighbors that are members of a peer group.

#### Command Mode

Router-BGP Configuration

#### Command Syntax

```
neighbor neighbor_ID send-community link-bandwidth {aggregate [reference_speed] | divide {equal | ratio}}
```

```
no neighbor neighbor_ID send-community
```

```
default neighbor neighbor_ID send-community
```

#### Parameters

- *neighbor\_ID* neighbor's IPv4 or IPv6 address or peer group name.
- aggregate sends the sum of all link-bandwidth values for all paths toward a prefix to the specified neighbor or to each member of the specified peer group.
  - *reference\_speed* optional value to specify a reference link speed in bits/second. Values range from 0.0 to 4294967295.0; larger values can also be expressed using the multiplier K (\*10<sup>3</sup>), M (\*10<sup>6</sup>), or G (\*10<sup>9</sup>). The link speed of the connection to the peer is divided by this value, and the resulting ratio is used to scale down the link-bandwidth advertised to the peer. If the result is >1, the multiplier is ignored and the full aggregate value is advertised.
- divide divides the cumulative link-bandwidth value described above among the peers in an Adj-RIB-Out either equally or proportionally.
  - equal divides the cumulative total link-bandwidth value equally among all peers in the same Adj-RIB-Out.
  - ratio divides the cumulative total link-bandwidth value among peers proportionally according to the speed of the connection to each peer in the Adj-RIB-Out.

#### Examples

- These commands configure the switch to locally regenerate the link-bandwidth value, dividing the bandwidth proportionally and including it in UPDATE messages to all peers in the peer group "idaho."

```
switch(config)#router bgp 9
switch(config-router-bgp)#neighbor idaho send-community link-bandwidth
divide ratio
switch(config-router-bgp)#
```

- These commands configure the switch to locally regenerate the link-bandwidth value, scale it down with a reference link speed of 20 gigabits/second, and include it in UPDATE messages to the neighbor at address 10.5.2.24.

```
switch(config)#router bgp 9
switch(config-router-bgp)#neighbor 10.5.2.24 send-community link-
bandwidth aggregate 20G
switch(config-router-bgp)#
```

---

### 14.5.4.79 neighbor send-community

The **neighbor send-community** command configures the switch to include community path attributes for routes in the UPDATE messages advertised to the specified BGP neighbor. By default, the command enables the switch to send all community attributes: standard, extended, and large. To advertise *only a subset* of community attributes, use the keyword(s) for the community attribute(s) to be included. To add additional community attributes in a separate command, or to remove specific community attributes from advertised routes, use the **neighbor send-community add / remove** command.

 **Note:** The **neighbor send-community link-bandwidth** command will override this command and vice-versa.

The **no neighbor send-community** command applies the system default (not sending community attributes in BGP UPDATE messages) for the specified peer.

The **default neighbor send-community** command applies the system default for individual neighbors and applies the peer group's setting for neighbors that are members of a peer group.

#### Command Mode

Router-BGP Configuration

#### Command Syntax

```
neighbor neighbor_ID send-community [extended] [large] [standard]
```

#### Parameters

- *neighbor\_ID* neighbor's IPv4 or IPv6 address or peer group name.
- *extended* includes extended community attributes.
- *large* includes large community attributes.
- *standard* includes standard community attributes.

#### Examples

- These commands configure the switch to send all community attributes to the neighbor at address 10.5.2.23.

```
switch(config)#router bgp 9
switch(config-router-bgp)#neighbor 10.5.2.23 send-community
switch(config-router-bgp)#
```

- These commands configure the switch to include only large community attributes in the routes sent to the neighbor at address 10.5.2.24.

```
switch(config)#router bgp 9
switch(config-router-bgp)#neighbor 10.5.2.24 send-community large
switch(config-router-bgp)#
```

- These commands configure the switch to send only standard and large community attributes to the neighbor at address 10.5.2.25.

```
switch(config)#router bgp 9
switch(config-router-bgp)#neighbor 10.5.2.25 send-community standard
large
switch(config-router-bgp)#
```



#### 14.5.4.80 neighbor shutdown

The **neighbor shutdown** command disables the specified neighbor. Disabling a neighbor also terminates all of its active sessions and removes associated routing information.

The **no neighbor shutdown** command enables the specified peer.

The default neighbor shutdown command enables individual neighbors and applies the peer group's setting for neighbors that are members of a peer group.

##### Command Mode

Router-BGP Configuration

##### Command Syntax

```
neighbor neighbor_ID shutdown reason REASON
```

##### Parameters

- *neighbor\_ID* neighbor's IPv4 or IPv6 address or peer group name.

##### Example

- This command disables the neighbor at 10.5.2.23.

```
switch(config)#router bgp 9
switch(config-router-bgp)#neighbor 10.5.2.23 shutdown
switch(config-router-bgp)#
```

- This command disables the neighbor at 10.5.2.23 with a reason - planned upgrade. The reason parameter is optional.

```
switch(config)#router bgp 9
switch(config-router-bgp)#neighbor 10.5.2.23 shutdown reason Planned
upgrade
switch(config-router-bgp)#
```

---

#### 14.5.4.81 neighbor timers

The `neighbor timers` command configures the BGP keepalive and hold times for a specified peer connection. The `timers bgp` command configures the times on all peer connections for which an individual command is not specified.

- **Keepalive time** is the period between the transmission of consecutive keepalive messages.
- **Hold time** is the period the switch waits for a KEEPALIVE or UPDATE message before it disables peering.

The hold time must be at least 3 seconds and should be three times longer than the keepalive setting.

The `no neighbor timers` command applies the system default for the specified peer or group (the timers specified by the `timers bgp` command).

The `default neighbor timers` command applies the system default for individual neighbors and applies the peer group's setting for neighbors that are members of a peer group.

The `no neighbor` command removes all configuration commands for the neighbor at the specified address.

##### Command Mode

Router-BGP Configuration

##### Command Syntax

```
neighbor neighbor_ID timers keep_alive hold_time
```

```
no neighbor neighbor_ID timers
```

```
default neighbor neighbor_ID timers
```

##### Parameters

- *neighbor\_ID* neighbor's IPv4 or IPv6 address or peer group name.
- *keep\_alive* keepalive period, in seconds. Values include
  - **0** keepalive messages are not sent.
  - **1 to 3600** keepalive time (seconds).
- *hold\_time* hold time. Values include:
  - **0** peering is not disabled by timeout expiry; keepalive packets are not sent.
  - **3 to 7200** hold time (seconds).

##### Example

- This command sets the keepalive time to 30 seconds and the hold time to 90 seconds for the connection with the peer at 10.24.15.9.

```
switch(config)#router bgp 9
switch(config-router-bgp)#neighbor 10.24.15.9 timers 30 90
switch(config-router-bgp)#
```

#### 14.5.4.82 neighbor ttl maximum-hops

The `neighbor ttl maximum-hops` command configures the Generalized TTL Security Mechanism (GTSM) for the specified neighbor(s).

The `no neighbor ttl maximum-hops` command disables the GTSM configuration in the specified neighbor.

The `default neighbor ttl maximum-hops` command applies the system default configuration for individual neighbors; and applies the peer group's setting for neighbors that are members of a peer group.

**Command-Mode**

Router-BGP Configuration

**Command Syntax**`neighbor neighbor_ID ttl maximum-hops hop_number``no neighbor neighbor_ID ttl maximum-hops``default neighbor neighbor_ID ttl maximum-hops`**Parameters**

- *neighbor\_ID* neighbor's IPv4 or IPv6 address or peer group name.
- *hop\_number* maximum count of hops from a BGP peer. Values range from 0 to 254.

**Example**

- This command configures the TTL security for **10.20.20.30** with a maximum of four hops.

```
switch(config)#router bgp 9
switch(config-router-bgp)#neighbor 10.20.20.30 ttl maximum-hops 4
switch(config-router-bgp)#
```

---

### 14.5.4.83 neighbor update-source

The **neighbor update-source** command specifies the interface that BGP sessions use for TCP connections. By default, BGP sessions use the neighbor's closest interface (also known as the best local address).

The **no neighbor update-source** command applies the system default (using best local address for TCP connections) for the specified peer or group.

The default **neighbor update-source** command applies the system default for individual neighbors and applies the peer group's setting for neighbors that are members of a peer group.

The **no neighbor** command removes all configuration commands for the neighbor at the specified address.

#### Command Mode

Router-BGP Configuration

#### Command Syntax

```
neighbor neighbor_ID update-source INTERFACE
```

```
no neighbor neighbor_ID update-source
```

```
default neighbor neighbor_ID update-source
```

#### Parameters

- *neighbor\_ID* neighbor's IPv4 or IPv6 address or peer group name.
- **INTERFACE** interface type and number. Options include:
  - ethernet *e\_num* Ethernet interface specified by *e\_num*.
  - loopback *l\_num* loopback interface specified by *l\_num*.
  - management *m\_num* management interface specified by *m\_num*.
  - port-channel *p\_num* port-channel interface specified by *p\_num*.
  - vlan *v\_num* VLAN interface specified by *v\_num*.

#### Example

- This command configures the switch to use Ethernet interface 10 for TCP connections for the neighbor at 10.2.2.14.

```
switch(config)#router bgp 9
switch(config-router-bgp)#neighbor 10.2.2.14 update-source ethernet 10
switch(config-router-bgp)#
```

#### 14.5.4.84 neighbor weight

The **neighbor weight** command assigns a weight attribute value to paths from the specified neighbor. Weight is the first parameter that the BGP best-path selection algorithm considers. When multiple paths to a destination prefix exist, the best-path selection algorithm prefers the path with the highest weight. Other attributes are used only when all paths to the prefix have the same weight.

Weight values range from 0 to 65535 and are not propagated to other switches through route updates. The default weight for paths that the router originates is 32768; the default weight for routes received through BGP is 0.

A path's BGP weight is also configurable through route maps. Weight values set through route-map commands have precedence over neighbor weight command values.

The **no neighbor weight** command applies the system default (32768 for router-originated paths, 0 for routes received through BGP) for the specified peer or group.

The **default neighbor weight** command applies the system default for individual neighbors, and applies the peer group's setting for neighbors that are members of a peer group.

The **no neighbor** command removes all configuration commands for the neighbor at the specified address.

#### Command Mode

Router-BGP Configuration

#### Command Syntax

```
neighbor neighbor_ID weight weight_value
```

```
no neighbor neighbor_ID weight
```

```
default neighbor neighbor_ID weight
```

#### Parameters

- *neighbor\_ID* neighbor's IPv4 or IPv6 address or peer group name.
- *weight\_value* weight value. Values range from 1 to 65535.

#### Example

- This command specifies a weight of 4000 for all paths from the neighbor at 10.1.2.5.

```
switch(config)#router bgp 9
eswitch(config-router-bgp)#neighbor 10.1.2.5 weight 4000
switch(config-router-bgp)#
```

---

#### 14.5.4.85 network (BGP)

The **network** command specifies a network for advertisement through UPDATE packets to BGP peers. The configuration zeros the host portion of the specified network address; for example, 192.0.2.4/24 is stored as 192.0.2.0/24. A route map option is available for assigning attributes to the network.

The command is available in Router-BGP and Router-BGP-Address-Family configuration modes. The mode in which the command is issued does not affect the command. The scope of the command depends on the specified network address:

- commands with an IPv4 address are advertised to peers activated in the IPv4 address family.
- commands with an IPv6 address are advertised to peers activated in the IPv6 address family.

The **no network** and **default network** commands remove the network from the routing table, preventing its advertisement.

##### Command Mode

Router-BGP Configuration

Router-BGP Address-Family Configuration

##### Command Syntax

```
network NET_ADDRESS [ROUTE_MAP]
```

```
no network NET_ADDRESS
```

```
default network NET_ADDRESS
```

##### Parameters

- NET\_ADDRESS IP address range. Entry options include:
  - *ipv4\_subnet* IPv4 subnet (CIDR notation).
  - *ipv4\_addr mask subnet* IPv4 subnet (address-mask notation).
  - *ipv6\_prefix* neighbor's IPv6 prefix (CIDR notation).
- ROUTE\_MAP specifies route map that assigns attribute values to the network. Options include:
  - <no parameter> attributes are not assigned through a route map.
  - route-map *map\_name* attributes listed by specified route map are assigned to the network.

##### Example

- This command enables BGP advertising for the network located at 10.1.2.5. The configuration stores the network as 10.1.2.5.

```
switch(config)#router bgp 9
switch(config-router-bgp)#network 10.1.2.5/24
switch(config-router-bgp)#
```

### 14.5.4.86 no neighbor

The **no neighbor** command removes all neighbor configuration commands for the specified neighbor.

Neighbor settings can also be removed individually; refer to the command description page of the desired command for details. Neighbor settings for a peer group *must* be removed individually.

#### Command Mode

Router-BGP Configuration

#### Command Syntax

```
no neighbor neighbor_ID
```

```
default neighbor neighbor_ID
```

#### Parameters

- *neighbor\_ID* neighbor's IPv4 or IPv6 address. This command does not accept a peer group name as an argument; peer group settings must be removed individually.

#### Example

- This command removes all neighbor configuration commands for the neighbor at 10.1.1.1.

```
switch(config)#router bgp 9
switch(config-router-bgp)#no neighbor 10.1.1.1
switch(config-router-bgp)#
```

---

#### 14.5.4.87 peer-filter

The **peer-filter** command creates a peer filter group and places the switch in peer-filter configuration mode for that group. The peer-filter group parameters are defined using the [match as-range](#) command.

The **no peer-filter** and **default peer-filter** commands remove the peer-filter group from *running-config*.

##### Command Mode

Router-BGP Configuration

##### Command Syntax

```
peer-filter filter_name
```

```
no peer-filter filter_name
```

```
default peer-filter filter_name
```

##### Parameters

- *filter\_name* name of the peer filter.

##### Example

- This command creates a peer filter called “group1” and places the switch in peer-filter configuration mode for that filter.

```
switch(config-router-bgp) #peer-filter group1
switch(config-peer-filter-group1) #
```



#### 14.5.4.88 rd (Router-BGP VRF and VNI Configuration Modes)

The **rd** command adds a route distinguisher (RD) to VRF and VNI configuration modes. RDs internally identify routes belonging to a VRF or VNI to distinguish overlapping or duplicate IP address ranges. This allows the creation of distinct routes to the same IP address for different VPNs. The RD is a 64-bit number made up of an AS number or IPv4 address followed by a user-selected ID number.

If the switch is not running EVPN, an RD is not required for a VRF or VNI to function. Use **no** or **default** command forms to remove an RD from a VRF or VNI.

 **Note:** Legacy RDs that were assigned in VRF Configuration Mode appear in **show vrf** outputs if an RD has not been configured using this command, but they no longer have an effect on the system. RDs assigned in the VNI Configuration Mode are displayed in the output of **show bgp evpn** command.

#### Command Modes

Router-BGP VRF Configuration

Router-BGP VNI Configuration

#### Command Syntax

```
rd admin_ID:local_assignment
```

```
no rd
```

```
default rd
```

#### Parameters

- *admin\_ID* an AS number or globally assigned IPv4 address identifying the entity assigning the RD. This should be an IANA-assigned identifying number.
- *local\_assignment* a locally assigned number distinguishing the VRF. Values range from 0-65535 if the *admin\_ID* is an IPv4 address, or from 0-4,294,967,295 if the *admin\_ID* is an AS number. If the *admin\_ID* is an AS number, the *local\_assignment* can also be entered in the form of an IPv4 address.

#### Examples

- These commands identify the administrator of the VRF called “purple” as AS 530 and assign 12 as its local number.

```
switch(config)#router bgp 50
switch(config-router-bgp)#vrf purple
switch(config-router-bgp-vrf-purple)#rd 530:12
switch(config-router-bgp-vrf-purple)#
```

- These commands identify the administrator of the MAC-VRF called “bundle1” as AS 530 and assign 12 as its local number.

```
cvx(config)#router bgp 100
cvx(config-router-bgp)#vni-aware-bundle bundle1
cvx(config-macvrf-bundle1)#rd 530:12
cvx(config-macvrf-bundle1)#
```

### 14.5.4.89 redistribute (BGP)

The **redistribute** command enables the redistribution of specified routes to the BGP domain.

The **no redistribute** and **default redistribute** commands disable route redistribution from the specified domain by removing the corresponding **redistribute** command from *running-config*.

 **Note:** Aggregate routes are redistributed automatically, and their redistribution cannot be disabled.

#### Command Mode

Router-BGP Configuration

#### Command Syntax

```
redistribute ROUTE_TYPE [ROUTE_MAP]
```

```
no redistribute ROUTE_TYPE
```

```
default redistribute ROUTE_TYPE
```

#### Parameters

- ROUTE\_TYPE source from which routes are redistributed. Options include:
  - connected routes that are established when IP is enabled on an interface.
  - match nssa-external all OSPF NSSA external routes.
  - match nssa-external 1 type 1 OSPF NSSA external routes.
  - match nssa-external 2 type 2 OSPF NSSA external routes.
  - ospf routes from an OSPF domain.
  - ospf match external routes external to the AS, but imported from OSPF.
  - ospf match internal OSPF routes that are internal to the AS.
  - ospf match nssa-external all OSPF NSSA external routes.
  - ospf match nssa-external 1 type 1 OSPF NSSA external routes.
  - ospf match nssa-external 2 type 2 OSPF NSSA external routes.
  - ospf3 routes from an OSPFv3 domain.
  - ospf3 match external routes external to the AS, but imported from OSPFv3.
  - ospf3 match internal OSPFv3 routes that are internal to the AS.
  - rip routes from a RIP domain.
  - static IP static routes.
  - isis IS-IS routes. Sub-options include.
    - level-1 redistribute IS-IS level-1 routes.
    - level-1-2 redistribute IS-IS level-1 and level-2 routes.
    - level-2 redistribute IS-IS level-2 routes.
    - route-map route map reference.
- ROUTE\_MAP route map that determines the routes that are redistributed. Options include:
  - <no parameter> all routes are redistributed.
  - route-map *map\_name* only routes in the specified route map are redistributed.



**Note:** While redistributing IS-IS routes into BGP, the level-1 or level-2 keyword can be used to selectively redistribute level-1 routes or level-2 routes into BGP. The level-1 or level-2 keyword is optional, and the command defaults to level-2 when it is not configured.

#### Example

- These commands redistribute OSPF routes into the BGP domain.

```
switch(config)#router bgp 1
```

```
switch(config-router-bgp) #redistribute OSPF
switch(config-router-bgp) #
```

- These commands redistribute ISIS routes into the BGP domain in address-family mode.

```
Switch(config) #router bgp 1
switch(config-router-bgp) #address-family ipv4
switch(config-router-bgp-af) #redistribute isis level-1 route-map isis-
to-bgp-v4
switch(config-router-bgp-af) #
```

- These commands redistribute ISIS routes into the BGP domain in router-bgp mode.

```
switch(config) #router bgp 1
switch(config-router-bgp) #redistribute isis level-1 route-map isis-to-
bgp
switch(config) #
```

---

#### 14.5.4.90 rib fib fec ecmp ordered

The `rib fib fec ecmp ordered` command is configured to enforce ordering of next hops as determined by the protocol agents in the FEC programmed for the route.

The `no rib fib fec ecmp ordered` command removes the Ordered FEC configuration from the `running-config`.

##### Command Mode

Router General Configuration Mode

##### Command Syntax

```
rib fib fec ecmp ordered
```

```
no rib fib fec ecmp ordered
```

##### Example

- The `rib fib fec ecmp ordered` command configures the Ordered FEC feature on the switch.

```
switch(config)#router general
switch(config-router-general)#rib fib fec ecmp ordered
switch(config-router-general)#
```

### 14.5.4.91 router bgp

The **router bgp** command places the switch in router-BGP configuration mode. If BGP was not previously instantiated, this command creates a BGP instance with the specified AS number. Router-BGP configuration mode is not a group-change mode; **running-config** is changed immediately after commands are executed. The **exit** command does not affect the configuration.

When a BGP instance exists, the command must include the AS number of the existing BGP instance. Running this command with a different AS number generates an error message.

The **no router bgp** and **default router bgp** commands delete the BGP instance.

The **exit** command returns the switch to global configuration mode.

#### Command Mode

Global Configuration

#### Command Syntax

```
router bgp as_id
```

```
no router bgp
```

```
default router bgp
```

#### Parameters

- *as\_id* autonomous system (AS) number. Values range from 1 to 4294967295.

#### Examples

- This command creates a BGP instance with AS number 64500.

```
switch(config)#router bgp 64500
switch(config-router-bgp)#
```

- This command attempts to open a BGP instance with a different AS number from that of the existing instance. The switch displays an error and stays in global configuration mode.

```
switch(config)#router bgp 64501
% BGP is already running with AS number 64500
switch(config)#
```

- This command exits BGP configuration mode.

```
switch(config-router-bgp)#exit
switch(config)#
```

- This command deletes the BGP instance.

```
switch(config)#no router bgp
switch(config)#
```

---

### 14.5.4.92 router-id (BGP)

The **router-id** command sets the local router BGP router ID.

When no ID has been specified, the local router ID is set to the following:

- the loopback IP address when a single loopback interface is configured.
- the loopback with the highest IP address when multiple loopback interfaces are configured.
- the highest IP address on a physical interface when no loopback interfaces are configured.



**Note:** The router ID must be specified if the switch has no IPv4 addresses configured.

The **no router-id** and **default router-id** commands remove the **router-id** command from **running-config**.

#### Command Mode

Router-BGP Configuration

#### Command Syntax

```
router-id id_num
```

```
no router-id [id_num]
```

```
default router-id [id_num]
```

#### Parameters

- *id\_num* router ID number (32-bit dotted decimal notation).

#### Example

- This command configures the fixed router ID address of 10.10.4.11.

```
switch(config)#router bgp 9
switch(config-router-bgp)#router-id 10.10.4.11
switch(config-router-bgp)#
```

### 14.5.4.93 show bgp convergence

The **show bgp convergence** command displays information about the Border Gateway Protocol (BGP) convergence state and other statistics about the BGP instance in the specified VRF or in all VRFs.

#### Command Mode

EXEC

#### Command Syntax

```
show bgp convergence [VRF_INSTANCE]
```

#### Parameters

- VRF\_INSTANCE specifies VRF instances. Options include:
  - <no parameter> displays BGP information for the context-active VRF.
  - vrf *vrf\_name* displays BGP information for the specified VRF.
  - vrf all displays BGP information for all VRFs.
  - vrf default displays BGP information for the default VRF.

#### Examples

- This command displays the output when no peers have joined before convergence.

```
switch#show bgp convergence
BGP Convergence information for VRF: default
Configured convergence timeout: 00:02:30
Configured convergence slow peer timeout: 00:00:55
Convergence based update synchronization is enabled
Last Bgp convergence event : None
Bgp convergence state : Not Initiated (Waiting for the first peer to
join)
Convergence timer is not running
Convergence timeout in use: 00:02:30
Convergence slow peer timeout in use: 00:00:55
First peer is not up yet
All the expected peers are up: no
All IGP protocols have converged: yes
Outstanding EORs: 0, Outstanding Keepalives: 0
Pending Peers: 2
Total Peers: 2
Established Peers: 0
Disabled Peers: 0
Peers that have not converged yet:
IPv4 peers:
201.1.1.1 (Session : Connect)
202.1.1.1 (Session : Connect)
IPv6 peers:
None
switch#
```

- This command displays the output when the first peer has joined before convergence.

```
switch#show bgp convergence
BGP Convergence information for VRF: default
Configured convergence timeout: 00:02:30
Configured convergence slow peer timeout: 00:00:55
Convergence based update synchronization is enabled
Last Bgp convergence event 00:00:40 ago
Bgp convergence state : Pending (Waiting for EORs/Keepalives from
peer(s) and IGP
convergence)
```

```
Convergence timer running, will expire in 00:01:50
Convergence timeout in use: 00:02:30
Convergence slow peer timeout in use: 00:00:55
First peer came up 00:00:13 ago
All the expected peers are up: no
All IGP protocols have converged: yes
Outstanding EORs: 0, Outstanding Keepalives: 0
Pending Peers: 1
Total Peers: 2
Established Peers: 1
Disabled Peers: 0
Peers that have not converged yet:
IPv4 peers:
201.1.1.1 (Session : Active)
IPv6 peers:
None
switch#
```

- This command displays the output when the convergence timeout value is reached.

```
switch#show bgp convergence
BGP Convergence information for VRF: default
Configured convergence timeout: 00:02:30
Configured convergence slow peer timeout: 00:00:55
Convergence based update synchronization is enabled
Last Bgp convergence event 00:02:44 ago
Bgp convergence state : Timeout reached
Time taken to converge 00:02:30
Pending Peers: 1
Total Peers: 2
Established Peers: 1
Disabled Peers: 0
Peers that did not converge before local bgp convergence:
IPv4 peers:
201.1.1.1 (Session : Active)
202.1.1.1 (Session : Established)
IPv6 peers:
None
switch#
```

- This command displays the output during the converged state.

```
switch#show bgp convergence
BGP Convergence information for VRF: default
Configured convergence timeout: 00:05:00
Configured convergence slow peer timeout: 00:01:30
Convergence based update synchronization is enabled
Last Bgp convergence event 00:00:05 ago
Bgp convergence state : Converged
Time taken to converge 00:00:02
First peer came up 00:00:05 ago
Pending Peers: 0
Total Peers: 3
Established Peers: 3
Disabled Peers: 0
Peers that did not converge before local bgp convergence:
IPv4 peers:
None
IPv6 peers:
None
switch#
```



#### 14.5.4.94 show bgp flow-spec

The **show bgp flow-spec ipv4** displays a brief description of each flowspec rule, including the matching rule and actions.

##### Command Mode

EXEC

##### Command Syntax

```
show bgp flow-spec [ipv4 | ipv6] [summary | detail] [vrf VRFNAME]
```

##### Parameters

- **ipv4** Displays information related to IPv4.
- **ipv6** Displays information related to IPv6.
- **summary** Displays summarized BGP information.
- **detail** Displays detailed information.
- **vrf VRFNAME** Displays flow-spec information in the named VRF.

##### Related Command

[show flow-spec](#)

##### Example

The **show bgp flow-spec ipv4 summary** command displays the count of flowspec rules received from each peer:

```
switch(config)#show bgp flow-spec ipv4 summary
BGP summary information for VRF default
Router identifier 0.0.0.1, local AS number 10
Neighbor Status Codes: m - Under maintenance
Neighbor V AS MsgRcvd MsgSent InQ OutQ Up/Down State RulesRcd RulesAcc
10.0.0.2 4 10 12 4 0 0 00:02:18 Estab 2 2
10.0.1.2 4 10 6 4 0 0 00:02:18 Estab 0 0
```

The **show bgp flow-spec detail** displays the full details of each flowspec rule including the peer(s) it was received from, BGP properties, and an expanded description of the matching rule:

```
switch(config)#show bgp flow-spec ipv4 detail
BGP Flow Specification rules for VRF default
Router identifier 0.0.0.1, local AS number 10
BGP Flow Specification Matching Rule for 10.2.3.0/24;*;
Rule identifier: 3882065752
Matching Rule:
 Destination Prefix: 10.2.3.0/24
 Source Prefix: *
Paths: 1 available
Local
 from 10.0.0.2 (10.1.1.2)
 Origin IGP, metric -, localpref 100, weight 0, valid, internal,
best
 Actions: Drop
BGP Flow Specification Matching Rule for 10.2.4.0/24;10.2.0.0/16;IP:=6|
=17;DP:>1010&<1024;
Rule identifier: 3882090640
Matching Rule:
 Destination Prefix: 10.2.4.0/24
 Source Prefix: 10.2.0.0/16
 IP Protocol: =6 | =17
 Destination Port: >1010 & <1024
Paths: 1 available
Local
 from 10.0.0.2 (10.1.1.2)
```

---

```
Origin IGP, metric -, localpref 100, weight 0, valid, internal,
best
Actions: Drop
```

### 14.5.4.95 show bgp instance

The **show bgp instance** command displays summary Border Gateway Protocol (BGP) information about the BGP instance in the specified VRF or in all VRFs.

#### Command Mode

EXEC

#### Command Syntax

```
show bgp instance [VRF_INSTANCE]
```

#### Parameters

- VRF\_INSTANCE specifies VRF instances. Options include:
  - <no parameter> displays BGP information for the context-active VRF.
  - vrf *vrf\_name* displays BGP information for the specified VRF.
  - vrf all displays BGP information for all VRFs.
  - vrf default displays BGP information for the default VRF.

#### Examples

- This command displays information about the BGP instance in the context-active VRF.

```
switch#show bgp instance
BGP instance information for VRF purple
BGP Local AS: 64497, Router ID: 1.2.3.5
Total peers: 5
Configured peers: 3
 UnConfigured peers: 2
 Disabled peers: 0
 Established peers: 3
Graceful restart helper mode enabled
End of rib timer timeout: 00:05:00
BGP Convergence timer is inactive
BGP Convergence information:
 BGP has converged:no
 Outstanding EORs:0,Outstanding Keepalives: 0
 Convergence timeout: 00:10:00
switch#
```

- This command displays information about the BGP instance in the default VRF.

```
switch#show bgp instance vrf default
BGP instance information for VRF default
BGP Local AS: 64503, Router ID: 1.2.3.5
Total peers: 1
Configured peers: 1
 UnConfigured peers: 0
 Disabled peers: 0
 Established peers: 0
Graceful restart helper mode enabled
End of rib timer timeout: 00:05:00
BGP Convergence timer is inactive
BGP Convergence information:
 BGP has converged:no
 Outstanding EORs:0,Outstanding Keepalives: 0
 Convergence timeout: 00:10:00
switch#
```

#### 14.5.4.96 show bgp labeled-unicast tunnel

The `show bgp labeled-unicast tunnel` command displays the contents of the BGP labeled-unicast (LU) tunnel table. The user can optionally specify a tunnel index parameter to view the specific single tunnel information.

##### Command Mode

EXEC

##### Command Syntax

```
show bgp labeled-unicast tunnel tunnel_index
```

##### Parameters

- *tunnel\_index* index to view single tunnel information.

##### Example

- This command displays the BGP LU tunnel table.

```
switch#show bgp labeled-unicast tunnel
Index Endpoint Nexthop Interface Labels Contributing Metric Metric 2 Pref Pref 2

5 2.0.0.0/24 10.1.1.2 'Ethernet3' [123 899 900] Yes 0 100 200 0
6 2.0.1.0/24 10.1.1.2 'Ethernet3' [400 500 600] Yes 0 100 200 0
7 2.0.2.0/24 10.1.1.2 'Ethernet3' [400 500 600] Yes 0 100 200 0
switch#
```

- This command displays the BGP LU tunnel table for tunnel index 4.

```
switch#show bgp labeled-unicast tunnel 4
Index Endpoint Nexthop/Tunnel Index Interface Labels Contributing Metric Metric 2 Pref Pref 2

4 10.253.0.10/32 10.1.0.0 Port-Channel111 [3] Yes 0 0 200 0
switch#
```

### 14.5.4.97 show bgp neighbors history

The **show bgp neighbors history** command stores and displays a list of failed BGP connection attempts for each peer. This may be particularly useful while troubleshooting flappy connections. If dynamic peering is enabled, the failure history will be remembered even after the peers are no longer present.

#### Command Mode

EXEC

#### Command Syntax

```
show bgp neighbors [PEER | PREFIX | peer-group PEER_GROUP] history [connect-failures][vrf VRF]
```

#### Parameters

**PEER** An IPv4 or IPv6 valid address.

**PREFIX** An IPv4 or IPv6 valid prefix.

**peer-group** PEER\_GROUP A peer group name.

**connect-failures** Optional and will not affect the result.

**vrf** VRF A VRF name. If it is not supplied, the command will act upon the VRF default.

#### Guidelines

Relevant error messages are recorded by default, without any configuration. To clear all messages for a peer or group of peers, though, it is necessary to use the command **clear bgp history**. The syntax for this command is described as:

```
switch#clear bgp [PEER|PREFIX|peer-group PEER_GROUP] history [connect-failures][vrf VRF]
```

If no peer, prefix, or peer-group is supplied, this command will clear the history for all peers in the specified VRF.

- The number of recorded messages is limited to eight per peer.
- Only errors that occur prior to session establishment will be recorded.
- The **show bgp neighbors history** is available only with the multi-agent protocol model.

#### Related Command

[clear bgp history](#)

#### Example

For each peer, its address will be printed at the first line, along with the VRF it's part of. Then, a table will be printed with the following columns:

- **Type:** the peer connection type. May be Static or Dynamic.
- **AS:** the remote Autonomous System number.
- **Time:** the time of the failure, using the local timezone.
- **Event:** a description related to the cause of the failed BGP connection.

```
switch>show bgp neighbors history
1.1.1.2 VRF default
Type AS Time
Static 65538 Mon 2019-05-13 04:16:24 Connect (No route to host)
Static 65538 Mon 2019-05-13 04:16:31 Connect (No route to host)
Static 65538 Mon 2019-05-13 04:16:39 Connect (No route to host)
Static 65538 Mon 2019-05-13 04:16:47 Connect (No route to host)
Static 65538 Mon 2019-05-13 04:16:55 Connect (No route to host)
```

---

|        |       |                         |                            |
|--------|-------|-------------------------|----------------------------|
| Static | 65538 | Mon 2019-05-13 04:17:03 | Connect (No route to host) |
| Static | 65538 | Mon 2019-05-13 04:18:17 | bad AS number              |
| Static | 65538 | Mon 2019-05-13 04:19:40 | bad AS number              |

### 14.5.4.98 show flow-spec

The **show flow-spec** command displays an overall status of how many flowspec rules were received and how many were installed.

#### Command Mode

EXEC

#### Command Syntax

```
show flow-spec (ipv4 | ipv6) [summary] [vrf VRFNAME]
```

#### Parameters

- **ipv4** Displays information related to IPv4.
- **ipv6** Displays information related to IPv6.
- **summary** Displays summary of flow-spec rule.
- **vrf VRFNAME** Displays flow-spec information in the named VRF.

#### Related Command

[show bgp flow-spec](#)

#### Example

- The **show flow-spec ipv4 summary** command displays an overall status of how many flowspec rules were received and how many were installed:

```
switch(config)#show flow-spec ipv4 summary
Flow specification rules summary for VRF default
Total number of rules: 2
Number of installed rules: 2
```

- The **show flow-spec ipv4** displays the installation status of the rule, and a counter of how many hits it has accumulated. This command also compiles the received flowspec rules into rules that can be programmed into the TCAM. For example, logical expressions on values such as the destination port are converted to ranges, as shown below:

```
switch(config)#show flow-spec ipv4
Flow specification rules for VRF default
Applied on: Ethernet47/1
Flow-spec rule: 10.2.3.0/24;*;
Rule identifier: 3882065752
Matches:
 Destination prefix: 10.2.3.0/24
Actions:
 Police: 80 Mbps (10 MBps)
 Redirect: VRF customer1
 Route via LDP tunnel index 4, MPLS label 100123
 Route via LDP tunnel index 1, MPLS label 116507
Status:
 Installed: yes
 Counter: 312 packets
Flow-spec rule: 10.2.4.0/24;10.2.0.0/16;IP:=6|=17;DP:>1010&<1024;
Rule identifier: 3882090640
Matches:
 Destination prefix: 10.2.4.0/24
 Source prefix: 10.2.0.0/16
 Next protocol: 17
 6
 Destination port: 1011-1023
Actions:
 Police: 80 Mbps (10 MBps)
 Redirect: VRF customer1
```

---

```
Route via LDP tunnel index 4, MPLS label 100123
Route via LDP tunnel index 1, MPLS label 116507
```

```
Status:
```

```
Installed: yes
```

```
Counter: 0 packets
```



#### 14.5.4.99 show ip as-path access-list

The **show ip as-path access-list** command displays BGP filters on the switch. Specifying an access list displays the statements from that access list. Entering the command without parameters displays the statements from all access lists on the switch.

##### Command Mode

EXEC

##### Command Syntax

```
show ip as-path access-list [list_name]
```

##### Parameters

- *list\_name* the name of an AS path access list.

##### Example

- This command displays the contents of the AS path access list named "list1."

```
switch#show ip as-path access-list list1
ip as-path access-list list1 deny _3$
ip as-path access-list list1 permit .*
switch#
```

---

### 14.5.4.100 show ip bgp community

The **show ip bgp community** command displays Border Gateway Protocol (BGP) routing table entries, filtered by community.

#### Command Mode

EXEC

#### Command Syntax

```
show ip bgp community COMM_1 [COMM_2... COMM_n] [MATCH_TYPE] [DATA_OPTION]
[VRF_INSTANCE]
```

#### Parameters

- COMM\_x community number or name, as specified in the route map that sets the community list number.
  - GSHUT well-known graceful shutdown community.
  - aa:nn AS and network number, separated by colon. Each value ranges from 1 to 4294967295.
  - comm\_num community number. Values range from 1 to 4294967040.
  - internet advertises route to Internet community.
  - local-as advertises route only to local peers.
  - no-advertise does not advertise the route to any peer.
  - no-export advertises route only within BGP AS boundary.
- MATCH\_TYPE routes are filtered based on their communities. Options include:
  - <no parameter> routes must match at least one community in the list.
  - exact route must match all communities and include no other communities.
  - regex display routes matching the regular expression of communities.
- DATA\_OPTION type of information the command displays. Options include:
  - <no parameter> displays table of the routing entry line items.
  - detail displays data block for each routing table entry.
- VRF\_INSTANCE specifies VRF instances. Options include:
  - <no parameter> displays routing table for context-active VRF.
  - vrf vrf\_name displays routing table for the specified VRF.
  - vrf all displays routing table for all VRFs.
  - vrf default displays routing table for default VRF.

#### Guidelines

The interpretation of regular expressions is always based on string mode but not on the ACL configuration.

#### Example

- This command displays the BGP routing table entries with the community 64496:1000.

```
switch#show ip bgp community 64496:1000 detail
BGP routing table information for VRF default
Router identifier 10.0.0.102, local AS number 64500
BGP routing table entry for 10.100.1.0/24
Paths: 1 available
 64496 64497 65536
 10.1.0.100 from 10.1.0.100 (10.0.0.100)
 Origin IGP, metric 0, localpref 100, IGP metric 1, weight 0,
 received 00:03:16 ago, valid, external, best
 Community: 655:23590 64496:1000
 Rx SAFI: Unicast
```

```
switch#
```

---

### 14.5.4.101 show ip bgp installed

The `show ip bgp installed` command displays the list of installed routes in the RIB.

#### Command Mode

EXEC

#### Command Syntax

```
show ip bgp installed
```

#### Example

- This command displays the list of installed routes in the RIB.

```
switch#show ip bgp installed
BGP routing table information for VRF default
Router identifier 1.0.0.2, local AS number 100
Route status codes: s - suppressed, * - valid, > - active, # - not
installed, E
- ECMP head, e - ECMP
 S - Stale, c - Contributing to ECMP, b - backup
Origin codes: i - IGP, e - EGP, ? - incomplete
AS Path Attributes: Or-ID - Originator ID, C-LST - Cluster List, LL
Nexthop -
Link Local Nexthop

 Path Network Next Hop Metric LocPref Weight
 * > 6.0.0.0/24 1.0.0.1 0 100 0 ?

switch#
```

### 14.5.4.102 show ip bgp neighbors (route type)

The `show ip bgp neighbors (route type)` command displays information for next-hop routes to a specified IPv4 neighbor. The `show ip bgp neighbors (route-type) community` command displays the same information for routes filtered by communities.

The output format depends on the selected FILTER parameter:

- data-block format displays comprehensive information for each specified route.
- tabular format displays routing table entries in tabular format for the specified IP addresses.

Commands that do not include a route type revert to the `show ip bgp neighbors` command.

#### Command Mode

EXEC

#### Command Syntax

```
show ip bgp neighbors neighbor_addr HOPDIRECT [FILTER] [VRF_INSTANCE]
```

```
show ip bgp neighbors neighbor_addr [ROUTE_TYPE] HOPDIRECT [detail]
```

#### Related Commands

- `show ip bgp neighbors`
- `show ip bgp neighbors (route-type) community`

#### Parameters

- *neighbor\_addr* location of the neighbor.
- ROUTE\_TYPE filters route on route type. Options include:
  - ipv4 unicast displays IPv4 unicast routes.
  - ipv6 unicast displays IPv6 unicast routes.
- HOPDIRECT filters route on the basis of direction from neighbor. Options include:
  - advertised-routes displays routes advertised to the specified neighbor.
  - received-routes displays routes received from the specified neighbor (accepted and rejected).
  - routes displays routes received and accepted from specified neighbor.
- FILTER routing table entries that the command displays. Values include:
  - <no parameter> displays all routing table entries in tabular format.
  - detail displays all routing table entries in data-block format.
  - *ipv4\_addr* displays IPv4 host address in data-block format.
  - *ipv4\_prefix* displays the route information of specified IPv4 prefix in data-block format. Option includes:
    - longer-prefixes displays the route information of IPv4 prefix in data-block format.
- VRF\_INSTANCE specifies VRF instances. Options include:
  - <no parameter> displays routing table for context-active VRF.
  - *vrf vrf\_name* displays routing table for the specified VRF.
  - *vrf all* displays routing table for all VRFs.
  - *vrf default* displays routing table for default VRF.

#### Example

- This command displays information for routes advertised to the neighbor at 10.3.0.103.

```
switch#show ip bgp neighbors 10.3.0.103 advertised-routes
BGP routing table information for VRF default
Router identifier 10.0.0.102, local AS number 64500
Route status codes: s - suppressed, * - valid, > - active, # - not installed, E - ECMP
head, e - ECMP
S - Stale, c - Contributing to ECMP, b - backup, L - labeled-unicast
```

---

Origin codes: i - IGP, e - EGP, ? - incomplete  
AS Path Attributes: Or-ID - Originator ID, C-LST - Cluster List, LL Nexthop - Link Local  
Nexthop

|         | Network       | Next Hop   | Metric | LocPref | Weight | Path        |
|---------|---------------|------------|--------|---------|--------|-------------|
| * >     | 10.1.0.0/24   | 10.3.0.102 | -      | 100     | -      | i           |
| * >     | 10.2.0.0/24   | 10.3.0.102 | -      | 100     | -      | i           |
| * >     | 10.3.0.0/24   | 10.3.0.102 | -      | 100     | -      | i           |
| * >     | 10.100.0.0/24 | 10.1.0.100 | 200    | 100     | -      | 64496 i     |
| * >     | 10.100.1.0/24 | 10.1.0.100 | -      | 100     | -      | 64496 64497 |
| 65536 i |               |            |        |         |        |             |
| * >     | 10.100.2.0/24 | 10.1.0.100 | 42     | 100     | -      | 64496 ?     |
| * >     | 10.101.0.0/24 | 10.2.0.101 | -      | 100     | -      | 64510 i     |
| * >     | 10.101.1.0/24 | 10.2.0.101 | -      | 100     | -      | 64510 i     |
| * >     | 10.101.2.0/24 | 10.2.0.101 | -      | 100     | -      | 64510 i     |

switch#

### 14.5.4.103 show ip bgp neighbors (route-type) community

The `show ip bgp neighbors (route type) community` command displays information for next-hop routes to a specified neighbor. Routes are filtered by community.

The `show ip bgp neighbors (route type)` command displays the same information for routes filtered by IP addresses and subnets.

#### Command Mode

EXEC

#### Command Syntax

```
show ip bgp neighbors addr RTE community CM_1 [CM_2...CM_n] [MATCH] [INFO]
[VRF_INST]
```

#### Related Commands

- `show ip bgp neighbors`
- `show ip bgp neighbors (route type)`

#### Parameters

- *addr* location of the neighbor.
- RTE type of route that the command displays. Options include:
  - advertised-routes displays routes advertised to the specified neighbor.
  - received-routes displays routes received from the specified neighbor (accepted and rejected).
  - routes displays routes received and accepted from specified neighbor.
- CM\_x community number or name, as specified in the route map that sets the community list number. The command must list at least one of the following community identifiers:
  - GSHUT well-known graceful shutdown community.
  - *aa:nn* AS and network number, separated by colon. Each value ranges from 1 to 4294967295.
  - *comm\_num* community number. Values range from 1 to 4294967040.
  - internet advertises route to Internet community.
  - local-as advertises route only to local peers.
  - no-advertise does not advertise route to any peer.
  - no-export advertises route only within BGP AS boundary.
- MATCH routes are filtered based on their communities.
  - <no parameter> routes must match at least one community in the list.
  - exact route must match all communities and include no other communities.
- INFO type of information the command displays. Values include:
  - <no parameter> displays table of routing entry line items.
  - detail displays data block for each routing table entry.
- VRF\_INST specifies VRF instances. Options include:
  - <no parameter> displays routing table for context-active VRF.
  - *vrf vrf\_name* displays routing table for the specified VRF.
  - *vrf all* displays routing table for all VRFs.
  - *vrf default* displays routing table for default VRF.

#### Example

- This command lists the routes advertised to the neighbor at 10.3.0.103 with community 655:23590.

```
switch#show ip bgp neighbors 10.3.0.103 advertised-routes community 655:23590
BGP routing table information for VRF default
Router identifier 10.0.0.102, local AS number 64500
```

---

```
Route status codes: s - suppressed, * - valid, > - active, # - not installed, E - ECMP
head, e - ECMP
 S - Stale, c - Contributing to ECMP, b - backup, L - labeled-unicast
Origin codes: i - IGP, e - EGP, ? - incomplete
AS Path Attributes: Or-ID - Originator ID, C-LST - Cluster List, LL Nexthop - Link Local
Nexthop

* > Network Next Hop Metric LocPref Weight Path
65536 i 10.100.1.0/24 10.1.0.100 - 100 - 64496 64497
switch#
```



#### 14.5.4.104 show ip bgp neighbors regexp

The `show ip bgp neighbors regexp` command displays information for next-hop routes to a specified IPv4 neighbor that match the AS path attributes specified in the given regular expression.

##### Command Mode

EXEC

##### Command Syntax

```
show ip bgp neighbors addr RTE regexp as_paths [VRF_INST]
```

##### Related Commands

- `show ip bgp neighbors`
- `show ip bgp neighbors (route type)`

##### Parameters

- *addr* location of the neighbor.
- RTE type of route that the command displays. Options include:
  - `advertised-routes` displays routes advertised to the specified neighbor.
  - `received-routes` displays routes received from the specified neighbor (accepted and rejected).
  - `routes` displays routes received and accepted from specified neighbor.
- *as\_paths* list of AS paths, formatted as a regular expression. Regular expressions are pattern-matching strings that are composed of text characters and operators.
- VRF\_INST specifies VRF instances. Options include:
  - `<no parameter>` displays routing table for context-active VRF.
  - `vrf vrf_name` displays routing table for the specified VRF.
  - `vrf all` displays routing table for all VRFs.
  - `vrf default` displays routing table for default VRF.

##### Example

- This command lists the routes advertised to the neighbor at 10.3.0.103 where the AS path is 64496.

```
switch#show ip bgp neighbors 10.3.0.103 advertised-routes regex ^64496$
BGP routing table information for VRF default
Router identifier 10.0.0.102, local AS number 64500
Route status codes: s - suppressed, * - valid, > - active, # - not installed, E - ECMP
 head, e - ECMP
 S - Stale, c - Contributing to ECMP, b - backup, L = labeled-unicast
 % - Pending BGP convergence
Origin codes: i - IGP, e - EGP, ? - incomplete
AS Path Attributes: Or-ID - Originator ID, C-LST -Cluster List, LL Nexthop - Link Local
 Nexthop

Network Next Hop Metric LocPref Weight Path
* > 10.100.0.0/24 10.1.0.100 200 100 - 64496 i
* > 10.100.2.0/24 10.1.0.100 42 100 - 64496 ?
switch#
```

---

### 14.5.4.105 show ip bgp neighbors

The **show ip bgp neighbors** command displays Border Gateway Protocol (BGP) and TCP-session data for a specified IPv4 BGP neighbor, or for all IPv4 BGP neighbors if an address is not specified.

#### Command Mode

EXEC

#### Command Syntax

```
show ip bgp neighbors [NEIGHBOR_ADDR] [VRF_INSTANCE]
```

#### Parameters

- NEIGHBOR\_ADDR location of the neighbors. Options include:
  - <no parameter> command displays information for all IPv4 BGP neighbors.
  - *ipv4\_addr* command displays information for specified neighbor.
- VRF\_INSTANCE specifies VRF instances. Options include:
  - <no parameter> displays routing table for context-active VRF.
  - *vrf vrf\_name* displays routing table for the specified VRF.
  - *vrf all* displays routing table for all VRFs.
  - *vrf default* displays routing table for the default VRF.

#### Related Command

- [show ip bgp neighbors \(route type\)](#)
- [show ip bgp neighbors \(route-type\) community](#)

#### Example

- This command displays information of the neighbor at 10.1.0.100.

```
switch#show ip bgp neighbors 10.1.0.100
BGP neighbor is 10.1.0.100, remote AS 64496, external link
 BGP version 4, remote router ID 10.0.0.100, VRF default
 Inherits configuration from and member of peer-group EXTERNAL
 Negotiated BGP version 4
 Member of update group 3
 Last read 00:00:17, last write 00:00:18
 Hold time is 180, keepalive interval is 60 seconds
 Configured hold time is 180, keepalive interval is 60 seconds
 Connect timer is inactive
 Idle-restart timer is inactive
 BGP state is Established, up for 00:05:17
 Number of transitions to established: 1
 Last state was OpenConfirm
 Last event was RecvKeepAlive
 Neighbor Capabilities:
 Multiprotocol IPv4 Unicast: advertised and received and negotiated
 Four Octet ASN: advertised and received and negotiated
 Route Refresh: advertised and received and negotiated
 Send End-of-RIB messages: advertised and received and negotiated
 Additional-paths rcv capability:
 IPv4 Unicast: advertised
 Additional-paths send capability:
 IPv4 Unicast: received
 Restart timer is inactive
 End of rib timer is inactive
 Message Statistics:
 InQ depth is 0
 OutQ depth is 0
```

```

 Sent Rcvd
Opens: 1 1
Notifications: 0 0
Updates: 4 4
Keepalives: 7 7
Route-Refresh: 0 0
Total messages: 12 12
Prefix Statistics:
 Sent Rcvd
IPv4 Unicast: 9 4
IPv6 Unicast: 0 0
IPv4 SR-TE: 0 0
IPv6 SR-TE: 0 0
Inbound updates dropped by reason:
AS path loop detection: 0
Enforced First AS: 0
Originator ID matches local router ID: 0
Nexthop matches local IP address: 0
Unexpected IPv6 nexthop for IPv4 routes: 0
Nexthop invalid for single hop eBGP: 0
Inbound updates with attribute errors:
Resulting in removal of all paths in update (treat-as-withdraw): 0
Resulting in AFI/SAFI disable: 0
Resulting in attribute ignore: 0
Inbound paths dropped by reason:
IPv4 labeled-unicast NLRIs dropped due to excessive labels: 0
IPv6 labeled-unicast NLRIs dropped due to excessive labels: 0
Outbound paths dropped by reason:
IPv4 local address not available: 0
IPv6 local address not available: 0
Local AS is 64500, local router ID 10.0.0.102
TTL is 255, BGP neighbor may be upto 1 hops away
Local TCP address is 10.1.0.102, local port is 179
Remote TCP address is 10.1.0.100, remote port is 33171
Auto-Local-Addr is disabled
TCP Socket Information:
TCP state is ESTABLISHED
Recv-Q: 0/32768
Send-Q: 0/32768
Outgoing Maximum Segment Size (MSS): 1448
Total Number of TCP retransmissions: 0
Options:
Timestamps enabled: yes
Selective Acknowledgments enabled: yes
Window Scale enabled: yes
Explicit Congestion Notification (ECN) enabled: no
Socket Statistics:
Window Scale (wscale): 9,9
Retransmission Timeout (rto): 204.0ms
Round-trip Time (rtt/rtvar): 3.0ms/5.4ms
Delayed Ack Timeout (ato): 40.0ms
Congestion Window (cwnd): 10
TCP Throughput: 39.20 Mbps
Advertised Recv Window (rcv_space): 28960
switch#

```

- This command displays neighbor information for all neighbors.

```

switch#show ip bgp neighbors
BGP neighbor is 172.24.77.5, remote AS 100, external link
BGP version 4, remote router ID 172.24.77.5, VRF default
...
Neighbor Capabilities:
Multiprotocol IPv4 Unicast: advertised

```

---

```
 Multiprotocol IPv4 Labeled Unicast: advertised and received and
negotiated
 Four Octet ASN: advertised and received
 Route Refresh: advertised
 Send End-of-RIB messages: advertised
 Additional-paths Receive:
 IPv4 Unicast: advertised
 IPv4 Labeled Unicast: advertised
...
 Inbound updates dropped by reason:
 AS path loop detection: 0
 Enforced First AS: 0
 Malformed MPBGP routes: 0
 Originator ID matches local router ID: 0
 Nexthop matches local IP address: 0
 Unexpected IPv6 nexthop for IPv4 routes: 0
 Inbound paths dropped by reason:
 IPv4 labeled-unicast NLRIs dropped due to excessive labels: 0
switch#
```

### 14.5.4.106 show ip bgp not-installed

The `show ip bgp not-installed` command displays the list of non-installed routes in the RIB.

#### Command Mode

EXEC

#### Command Syntax

```
show ip bgp not-installed
```

#### Example

- This command displays the list of non-installed routes in the RIB.

```
switch#show ip bgp not-installed
BGP routing table information for VRF default
Router identifier 1.0.0.2, local AS number 100
Route status codes: s - suppressed, * - valid, > - active, # - not
installed, E
- ECMP head, e - ECMP
 S - Stale, c - Contributing to ECMP, b - backup
Origin codes: i - IGP, e - EGP, ? - incomplete
AS Path Attributes: Or-ID - Originator ID, C-LST - Cluster List, LL
Nexthop -
Link Local Nexthop

 Path Network Next Hop Metric LocPref Weight
 * # 7.0.0.0/24 1.0.0.1 0 100 0 ?

switch#
```

---

### 14.5.4.107 show ip bgp paths

The `show ip bgp paths` command displays all BGP AS paths in the database.

#### Command Mode

EXEC

#### Command Syntax

```
show ip bgp paths [VRF_INSTANCE]
```

#### Parameters

- VRF\_INSTANCE specifies VRF instances.
  - <no parameter> displays routing table for context-active VRF.
  - vrf *vrf\_name* displays routing table for the specified VRF.
  - vrf all displays routing table for all VRFs.
  - vrf default displays routing table for default VRF.

#### Display Values

- **Refcount:** number of routes using a listed path.
- **Metric:** the path's Multi Exit Discriminator (MED).
- **Path:** the route's AS path and its origin code.

The MED (the path's external metric) provides information to external neighbors about the preferred path into an AS that has multiple entry points. Lower MED values are preferred.

#### Example

- This command displays all BGP AS paths in the switch's database.

```
switch#show ip bgp paths
Refcount Metric Path
6 0 64510 64505 64506 64507 i (HashID 9)
6 0 64510 ? (HashID 8)
12 0 65530 65531 65532 e (HashID 5)
12 0 i (HashID 6)
6 0 64100 64200 i (HashID 4)
28 0 i (HashID 1)
7 0 ? (HashID 2)
40 0 64510 i (HashID 10)
19 0 64510 i (HashID 7)
2 0 i (HashID 3)
switch#
```

### 14.5.4.108 show ip bgp peer-group

The **show ip bgp peer-group** command displays the BGP version, address family, and group members for all BGP peer groups defined on the switch.

#### Command Mode

EXEC

#### Command Syntax

```
show ip bgp peer-group [GROUP] [VRF_INSTANCE]
```

#### Parameters

- GROUP peer group for which command displays information. Options include:
  - <no parameter> command displays information for all peer groups.
  - *group\_name* name of peer group for which command displays information.
- VRF\_INSTANCE specifies VRF instances.
  - <no parameter> displays routing table for context-active VRF.
  - *vrf vrf\_name* displays routing table for the specified VRF.
  - *vrf all* displays routing table for all VRFs.
  - *vrf default* displays routing table for default VRF.

#### Example

- This command displays BGP peer group information for all peer groups on the switch.

```
switch#show ip bgp peer-group
BGP peer-group is EXTERNAL
 BGP version 4
 Static peer-group members:
 VRF default:
 10.1.0.100, state: Connect
 Negotiated MP Capabilities:
 IPv4 Unicast: No
 IPv6 Unicast: No
 IPv4 SR-TE: No
 IPv6 SR-TE: No
 10.2.0.101, state: Connect
 Negotiated MP Capabilities:
 IPv4 Unicast: No
 IPv6 Unicast: No
 IPv4 SR-TE: No
 IPv6 SR-TE: No
 BGP peer-group is INTERNAL
 BGP version 4
 Listen-range subnets:
 VRF default:
 10.3.0.0/24, remote AS 64500
 Dynamic peer-group members:
 VRF default:
switch#
```

#### 14.5.4.109 show ip bgp regexp

The **show ip bgp regexp** command displays Border Gateway Protocol (BGP) IPv4 routing-table entries that match the AS path attributes specified in the given regular expression.

##### Command Mode

EXEC

##### Command Syntax

```
show ip bgp regexp as_paths [VRF_INSTANCE]
```

##### Parameters

- *as\_paths* list of AS paths, formatted as a regular expression. Regular expressions are pattern matching strings that are composed of text characters and operators.
- VRF\_INSTANCE specifies the VRF instance of the BGP routing table to be displayed. Options include:
  - <no parameter> displays routing table for context-active VRF.
  - *vrf vrf\_name* displays routing table for the specified VRF.
  - *vrf all* displays routing table for all VRFs.
  - *vrf default* displays routing table for default VRF.

##### Example

- This command displays information about the BGP IPv4 routes in the context-active VRF where the AS path is 64510.

```
switch#show ip bgp regexp ^64510$
BGP routing table information for VRF default
Router identifier 10.0.0.102, local AS number 64500
Route status codes: s - suppressed, * - valid, > - active, # - not installed, E - ECMP
 head, e - ECMP
 S - Stale, c - Contributing to ECMP, b - backup, L = labeled-unicast
 % - Pending BGP convergence
Origin codes: i - IGP, e - EGP, ? - incomplete
AS Path Attributes: Or-ID - Originator ID, C-LST -Cluster List, LL Nexthop - Link Local
 Nexthop

 Network Next Hop Metric LocPref Weight Path
* 10.2.0.0/24 10.2.0.101 0 100 0 64510 i
* > 10.101.0.0/24 10.2.0.101 0 100 0 64510 i
* > 10.101.1.0/24 10.2.0.101 0 100 0 64510 i
* > 10.101.2.0/24 10.2.0.101 0 100 0 64510 i
switch#
```



### 14.5.4.110 show ip bgp summary

The **show ip bgp summary** command displays the summary of all IPv4 and IPv6 BGP neighbors based on exchanged Address Family Identifiers (AFI) and Subsequent Address Family Identifiers (SAFI) negotiations where AFI is "IP" and SAFI is "unicast" information.

#### Command Mode

EXEC

#### Command Syntax

```
show ip bgp summary [VRF_INSTANCE]
```

#### Parameters

- VRF\_INSTANCE specifies VRF instances. Options include:
  - <no parameter> displays routing table for context-active VRF.
  - vrf *vrf\_name* displays routing table for the specified VRF.
  - vrf all displays routing table for all VRFs.
  - vrf default displays routing table for default VRF.

#### Display Values

##### Header Row

- **BGP router identifier**: the router identifier loopback address or highest IP address.
- **Local AS Number**: AS number assigned to the switch.

##### Neighbor Table Columns

- **(First) Neighbor**: neighbor's IP address.
- **(Second) V**: BGP version number.
- **(Third) AS**: neighbor's AS number.
- **(Fourth) MsgRcvd**: messages received from the neighbor.
- **(Fifth) MsgSent**: messages sent to neighbor.
- **(Sixth) InQ**: messages queued from neighbor.
- **(Seventh) OutQ**: messages queued to send neighbor.
- **(Eighth) Up/Down**: period the BGP session has been Established, or its current status.
- **(Ninth) State**: State of the BGP session and the number of routes received from a neighbor.

After the maximum number of routes are received, the ninth field displays **PfxRcd**, and the connection becomes Idle. Maximum number of routes is set using the [maximum paths \(BGP\)](#) command.

#### Related Command

- [show ipv6 bgp summary](#)

#### Example

- This command displays the status of the switch's BGP connections.

```
switch#show ip bgp summary
BGP summary information for VRF default
Router identifier 10.0.0.102, local AS number 64500
Neighbor Status Codes: m - Under maintenance
Neighbor V AS MsgRcvd MsgSent InQ OutQ Up/Down State PfxRcd
PfxAcc
 10.1.0.100 4 64496 1075 1083 0 0 00:04:04 Connect
 10.2.0.101 4 64510 1079 1088 0 0 00:04:14 Connect
switch#
```

#### 14.5.4.111 show ip bgp

The **show ip bgp** command displays Border Gateway Protocol (BGP) IPv4 routing table entries. The output format depends on the command parameters:

- **data-block format** displays comprehensive information for each specified BGP routing-table entry.
- **tabular format** displays routing-table entries for the specified IPv4 addresses.

#### Command Mode

EXEC

#### Command Syntax

```
show ip bgp [FILTER] [VRF_INSTANCE]
```

#### Parameters

- FILTER routing-table entries to display. Options include:
  - <no parameter> displays all routing-table entries in tabular format.
  - detail displays all routing-table entries in data-block format.
  - *ipv4\_addr* displays IPv4 host address in data-block format.
  - PREFIX displays the route information of the specified IPv4 prefix in data block format. Options include:
    - detail *ipv4\_prefix* displays the detailed route information of specified IPv4 prefix in data block format.
    - longer-prefixes *ipv4\_prefix* displays the route information of IPv4 prefix in tabular block format.
    - longer-prefixes detail *ipv4\_prefix* displays the detailed route information of specified IPv4 prefix in data block format.
  - community-list *cmnty\_list\_name* displays BGP routes filtered by the specified community list.
  - installed displays the information of installed BGP routes.
  - labeled-unicast displays the information of labeled-unicast BGP routes only.
  - not-installed displays the information of BGP routes that are not installed.
- VRF\_INSTANCE specifies VRF instances. Options include:
  - <no parameter> displays routing table for context-active VRF.
  - vrf *vrf\_name* displays routing table for the specified VRF.
  - vrf all displays routing table for all VRFs.
  - vrf default displays routing table for default VRF.

#### Guidelines

You must provide the IPv4 prefix in CIDR notation.

#### Examples

- This command displays the BGP routing table with prefix “L” flag for all BGP LU route entries.

```
switch#show ip bgp
BGP routing table information for VRF default
Router identifier 0.0.0.1, local AS number 100
Route status codes: s - suppressed, * - valid, > - active, # - not installed, E
- ECMP head, e - ECMP
S - Stale, c - Contributing to ECMP, b - backup, L - labeled-unicast
Origin codes: i - IGP, e - EGP, ? - incomplete
AS Path Attributes: Or-ID - Originator ID, C-LST - Cluster List, LL Nexthop -
Link Local Nexthop

 Network Next Hop Metric LocPref Weight Path
* > L 2.0.0.1/32 1.1.1.2 0 100 0 300 i
* # 2.0.0.1/32 1.0.0.2 0 100 0 200 ?
* > L 2.0.0.2/32 1.1.1.2 0 100 0 300 i
* # 2.0.0.2/32 1.0.0.2 0 100 0 200 ?
```

```
* > L 2.0.0.3/32 1.1.1.2 0 100 0 300 i
* # 2.0.0.3/32 1.0.0.2 0 100 0 200 ?
* > L 2.0.0.4/32 1.1.1.2 0 100 0 300 i
* # 2.0.0.4/32 1.0.0.2 0 100 0 200 ?
* > L 2.0.0.5/32 1.1.1.2 0 100 0 300 i
* # 2.0.0.5/32 1.0.0.2 0 100 0 200 ?
switch#
```

- This command displays the routing-table information of unicast routes for a default VRF.

```
switch#show ip bgp
BGP routing table information for VRF default
Router identifier 0.0.0.1, local AS number 100
BGP routing table entry for 2.0.0.1/32
 Paths: 2 available
 300
 1.1.1.2 labels [101 102 103 104] from 1.1.1.2 (1.1.1.2)
 Origin IGP, metric 0, localpref 100, weight 0, valid, external,
best
 Rx path id: 0x0
 200
 1.0.0.2 from 1.0.0.2 (0.0.1.1)
 Origin INCOMPLETE, metric 0, localpref 100, weight 0, valid,
external,
not installed (labeled-route present)
switch#
```

- This command displays the BGP routing-table entry for the 10.100.1.0/24 network.

```
switch#show ip bgp 10.100.1.0/24
BGP routing table information for VRF default
Router identifier 10.0.0.102, local AS number 64500
BGP routing table entry for 10.100.1.0/24
 Paths: 1 available
 64496 64497 65536
 10.1.0.100 from 10.1.0.100 (10.0.0.100)
 Origin IGP, metric 0, localpref 100, IGP metric 1, weight 0,
received
01:57:33 ago, valid, external, best
 Community: 655:23590 64496:1000
 Rx SAFI: Unicast
switch#
```

- This command displays the label stack associated with the route for a default VRF.

```
switch#show ip bgp detail
BGP routing table information for VRF default
Router identifier 0.0.0.1, local AS number 100
BGP routing table entry for 2.0.0.1/32
 Paths: 2 available
 200
 1.0.0.2 from 1.0.0.2 (0.0.1.1)
 Origin INCOMPLETE, metric 0, localpref 100, weight 0, valid,
external, best
 300
 1.1.1.2 labels [101 102 103 104] from 1.1.1.2 (1.1.1.2)
 Origin IGP, metric 0, localpref 100, weight 0, valid, external
 Rx path id: 0x0
 Rx SAFI: Labels
 Tunnel RIB eligible
switch#
```

- 
- This command displays the BGP routing-table entry for the 10.105.1.1/24 network, including the reason why the route was discarded by the best-path algorithm. The reason for discarding a route is preceded by the label “Not best:”.

```
switch#show ip bgp 10.105.1.1/24 detail
BGP routing table information for VRF default
Router identifier 10.0.0.102, local AS number 64500
Route status: [a.b.c.d] - Route is queued for advertisement to peer.
BGP routing table entry for 10.105.1.0/24
 Paths: 2 available
 64510
 10.2.0.101 from 10.2.0.101 (12.0.0.101)
 Origin IGP, metric 0, localpref 100, IGP metric 1, weight 0,
 received
 00:00:58 ago, valid, external, best
 Rx SAFI: Unicast
 64496
 10.1.0.100 from 10.1.0.100 (10.0.0.100)
 Origin INCOMPLETE, metric 42, localpref 100, IGP metric 1, weight
 0, received
 00:00:33 ago, valid, external
 Rx SAFI: Unicast
 Not best: Origin
 Advertised to 2 peers:
 peer-group EXTERNAL:
 10.1.0.100
 peer-group INTERNAL:
 10.3.0.103
switch#
```

#### 14.5.4.112 show ip community-list

The **show ip community-list** command displays the BGP community lists configured on the switch.

##### Command Mode

EXEC

##### Command Syntax

```
show ip community-list [COMMUNITY_LIST]
```

##### Parameters

- COMMUNITY\_LIST community list for which command displays information. Options include:
  - <no parameter> command displays information for all community lists.
  - *listname* name of the community list (text string).

##### Example

- This command displays the BGP paths in the switch's database.

```
switch#show ip community-list hs-comm-list
ip community-list hs-comm-list permit 0:10
switch#
```

---

### 14.5.4.113 show ip extcommunity-list

The **show ip extcommunity-list** command displays the BGP extended community lists configured on the switch.

#### Command Mode

EXEC

#### Command Syntax

```
show ip extcommunity-list [COMMUNITY_LIST]
```

#### Parameters

- **COMMUNITY\_LIST** extended community list for which command displays information. Options include:
  - `<no parameter>` command displays information for all extended community lists.
  - `listname` command displays information for the specified extended community list.

#### Example

- This command displays information for all extended extcommunity lists on the switch.

```
switch#show ip extcommunity-list
ip extcommunity-list hs-extcomm-list permit rt 3050:20
ip extcommunity-list hs-extcomm-list permit soo 172.17.52.2:30
ip extcommunity-list hs-extcomm-list permit rt 3050:70000
switch#
```

#### 14.5.4.114 show ipv6 bgp match community

The **show ipv6 bgp match community** command displays IPv6 Border Gateway Protocol (BGP) routing-table entries, filtered by community.

##### Command Mode

EXEC

##### Command Syntax

```
show ipv6 bgp match community [COMM_1 ... COMM_n] [MATCH_TYPE] [INFO]
[VRF_INSTANCE]
```

##### Parameters

- COMM\_x community number or name, as specified in the route map that sets the community-list number. Options include:
  - aa:nn AS and network number, separated by colon. Each value ranges from 1 to 4294967295.
  - comm\_num community number. Values range from 1 to 4294967040.
  - internet advertises route to Internet community.
  - local-as advertises route only to local peers.
  - no-advertise does not advertise route to any peer.
  - no-export advertises route only within BGP AS boundary.
- MATCH\_TYPE routes are filtered based on their communities. Options include:
  - <no parameter> routes must match at least one community in the list.
  - exact route must match all communities and include no other communities.
- INFO type of information the command displays. Options include:
  - <no parameter> displays table of the routing entry-line items.
  - detail displays data block for each routing-table entry.
- VRF\_INSTANCE specifies VRF instances. Options include:
  - <no parameter> displays routing-table for context-active VRF.
  - vrf vrf\_name displays routing table for the specified VRF.
  - vrf all displays routing table for all VRFs.
  - vrf default displays routing table for default VRF.

##### Example

- This command displays information in data-block format for each routing-table entry with community 655:23590.

```
switch(config)#show ipv6 bgp match community 655:23590 detail
BGP routing table information for VRF default
Router identifier 10.0.0.102, local AS number 64500
BGP routing table entry for 2001:10:100:1::/64
 Paths: 1 available
 64496 64497 65536
 2001:10:1::100 from 2001:10:1::100 (10.0.0.100)
 Origin IGP, metric 0, localpref 100, IGP metric 1, weight 0,
 received 01:09:29 ago, valid, external, best
 Community: 655:23590 64496:1000
 Rx SAFI: Unicast
switch(config)#
```

---

#### 14.5.4.115 show ipv6 bgp peers (route type) community

The `show ipv6 bgp peers (route type) community` command displays information about the routes either advertised to or received from a specified IPv6 BGP neighbor. The routes are filtered by community.

The `show ipv6 bgp peers (route type)` command displays the same information for routes filtered by IP addresses and prefixes.

##### Command Mode

EXEC

##### Command Syntax

```
show ipv6 bgp peers addr RTE community CM_1 [CM_2...CM_n] [MATCH] [INFO] [VRF_INST]
```

##### Parameters

- *addr* neighbor location (IPv6 address).
- RTE type of route that the command displays. Options include:
  - advertised-routes displays routes advertised to the specified neighbor.
  - received-routes displays routes received from the specified neighbor (accepted and rejected).
  - routes displays routes received and accepted from specified neighbor.
- CM\_x community number or name, as specified in the route map that sets the community list number. The command must list at least one of the following community identifiers:
  - *GSHUT* well-known graceful shutdown community.
  - *aa:nn* AS and network number, separated by colon. Each value ranges from 1 to 4294967295.
  - *comm\_num* community number. Values range from 1 to 4294967040.
  - internet advertises route to Internet community.
  - local-as advertises route only to local peers.
  - no-advertise does not advertise route to any peer.
  - no-export advertises route only within BGP AS boundary.
- MATCH routes are filtered based on their communities. Options include:
  - <no parameter> routes must match at least one community in the list
  - exact route must match all communities and include no other communities.
- INFO type of information the command displays. Values include:
  - <no parameter> displays table of the routing entry line items.
  - detail displays data block for each routing table entry.
- VRF\_INST specifies VRF instances. Options include:
  - <no parameter> displays routing table for context-active VRF.
  - vrf *vrf\_name* displays routing table for the specified VRF.
  - vrf all displays routing table for all VRFs.
  - vrf default displays routing table for default VRF.

##### Related Command

- `show ipv6 bgp peers`

##### Example

- This command lists the routes advertised to the neighbor at 2001:10:1:0::102 with the community 64496:1000.

```
switch#show ipv6 bgp peers 2001:10:1:0::102 advertised-routes community 64496:1000
BGP routing table information for VRF default
Router identifier 10.0.0.100, local AS number 64496
Route status codes: s - suppressed, * - valid, > - active, # - not installed, E - ECMP
head, e - ECMP
```



S - Stale, c - Contributing to ECMP, b - backup, L - labeled-unicast  
 Origin codes: i - IGP, e - EGP, ? - incomplete  
 AS Path Attributes: Or-ID - Originator ID, C-LST - Cluster List, LL Nexthop - Link Local Nexthop

|     | Network            | Next Hop       | Metric | LocPref | Weight | Path        |
|-----|--------------------|----------------|--------|---------|--------|-------------|
| * > | 2001:10:100:1::/64 | 2001:10:1::100 | -      | -       | -      | 64496 64497 |

65536 i  
 switch#

#### 14.5.4.116 show ipv6 bgp peers (route type)

The `show ipv6 bgp peers (route type)` command displays information about the routes either advertised to or received from a specified IPv6 BGP neighbor. The `show ipv6 bgp peers (route type) community` command displays the same information for routes filtered by communities. Commands that do not include a route type revert to the `show ipv6 bgp peers` command.

The output format depends on the selected FILTER parameter:

- data-block format displays comprehensive information for each specified route.
- tabular format displays routing table entries in tabular format for the specified IP addresses.

Output produced by the longer-prefixes option includes the specified route and all more specific routes.

#### Command Mode

EXEC

#### Command Syntax

```
show ipv6 bgp peers neighbor_addr HOPDIRECT [FILTER] [VRF_INSTANCE]
```

```
show ipv6 bgp peers neighbor_addr [ROUTE_TYPE] HOPDIRECT [detail]
```

#### Parameters

- *neighbor\_addr* location of the neighbor.
- ROUTE\_TYPE filters route on route type. Options include:
  - ipv4 unicast displays IPv4 unicast routes.
  - ipv6 unicast displays IPv6 unicast routes.
- HOPDIRECT filters route on the basis of direction from neighbor. Options include:
  - advertised-routes displays routes advertised to the specified neighbor.
  - received-routes displays routes received from the specified neighbor (accepted and rejected).
  - routes displays routes received and accepted from specified neighbor.
- FILTER routing table entries that the command displays. Options include:
  - <no parameter> displays all routing table entries in tabular format.
  - detail displays all routing table entries in data-block format.
  - *ipv6\_addr* displays the IPv6 host address in data-block format.
  - *ipv6\_prefix* displays the route information of specified IPv6 prefix in data-block format. Additional option:
    - longer-prefixes displays the route information of IPv4 prefix in data-block format.
- VRF\_INSTANCE specifies VRF instances. Options include:
  - <no parameter> displays routing table for context-active VRF.
  - *vrf vrf\_name* displays routing table for the specified VRF.
  - *vrf all* displays routing table for all VRFs.
  - *vrf default* displays routing table for default VRF.

#### Related Commands

- `show ipv6 bgp peers (route type) community`

#### Example

- This command displays information of all routes advertised to the neighbor at 2001:10:1:0::100.

```
switch#show ipv6 bgp peers 2001:10:1:0::100 advertised-routes
BGP routing table information for VRF default
Router identifier 10.0.0.102, local AS number 64500
Route status codes: s - suppressed, * - valid, > - active, # - not installed, E - ECMP
head, e - ECMP
S - Stale, c - Contributing to ECMP, b - backup, L - labeled-unicast
```

```

Origin codes: i - IGP, e - EGP, ? - incomplete
AS Path Attributes: Or-ID - Originator ID, C-LST - Cluster List, LL Nexthop - Link Local
Nexthop

```

|     | Network            | Next Hop       | Metric | LocPref | Weight | Path        |
|-----|--------------------|----------------|--------|---------|--------|-------------|
| * > | 2001:10:1::/64     | 2001:10:1::102 | -      | -       | -      | 64500 i     |
| * > | 2001:10:2::/64     | 2001:10:1::102 | -      | -       | -      | 64500 i     |
| * > | 2001:10:3::/64     | 2001:10:1::102 | -      | -       | -      | 64500 i     |
| * > | 2001:10:101::/64   | 2001:10:1::102 | -      | -       | -      | 64500 64510 |
| i   |                    |                |        |         |        |             |
| * > | 2001:10:101:1::/64 | 2001:10:1::102 | -      | -       | -      | 64500 64510 |
| i   |                    |                |        |         |        |             |
| * > | 2001:10:101:2::/64 | 2001:10:1::102 | -      | -       | -      | 64500 64510 |
| i   |                    |                |        |         |        |             |

```

switch#

```

#### 14.5.4.117 show ipv6 bgp peers regexp

The `show ipv6 bgp peers regexp` command displays information about routes (advertised or received) from a specified IPv6 neighbor that match the AS-path attributes specified in the given regular expression.

##### Command Mode

EXEC

##### Command Syntax

```
show ipv6 bgp peers addr ROUTE regexp as_paths [VRF_INST]
```

##### Parameters

- *addr* neighbor location (IPv6 address).
- ROUTE type of route that the command displays. Options include:
  - advertised-routes displays routes advertised to the specified neighbor.
  - received-routes displays routes received from the specified neighbor (accepted and rejected).
  - routes displays routes received and accepted from specified neighbor.
- *as\_paths* list of AS paths, formatted as a regular expression. Regular expressions are pattern-matching strings that are composed of text characters and operators.
- VRF\_INST specifies VRF instances. Options include:
  - <no parameter> displays routing table for context-active VRF.
  - vrf *vrf\_name* displays routing table for the specified VRF.
  - vrf all displays routing table for all VRFs.
  - vrf default displays routing table for default VRF.

##### Related Commands

- [show ip bgp regexp](#)
- [show ipv6 bgp peers](#)

##### Examples

- This command displays information for routes received from the neighbor at 2001:10:1:0::100 which include AS number 64496 in their AS paths.

```
switch#show ipv6 bgp peers 2001:10:1:0::100 received-routes regex 64496
BGP routing table information for VRF default
Router identifier 10.0.0.102, local AS number 64500
Route status codes: s - suppressed, * - valid, > - active, # - not installed, E - ECMP
head, e - ECMP
 S - Stale, c - Contributing to ECMP, b - backup, L - labeled-unicast
Origin codes: i - IGP, e - EGP, ? - incomplete
AS Path Attributes: Or-ID - Originator ID, C-LST - Cluster List, LL Nexthop - Link Local
Nexthop

 Network Next Hop Metric LocPref Weight Path
* 2001:10:1::/64 2001:10:1::100 42 - - 64496 ?
* > 2001:10:100::/64 2001:10:1::100 200 - - 64496 i
* > 2001:10:100:1::/64 2001:10:1::100 - - - 64496 64497
65536 i
* > 2001:10:100:2::/64 2001:10:1::100 42 - - 64496 ?
switch#
```

### 14.5.4.118 show ipv6 bgp peers

The **show ipv6 bgp peers** command displays IPv6 Border Gateway Protocol (BGP) and TCP session data for a specified neighbor. Command displays data for all neighbors if an address is not included.

#### Command Mode

EXEC

#### Command Syntax

```
show ipv6 bgp peers [NEIGHBOR_ADDR] [VRF_INSTANCE]
```

#### Parameters

- NEIGHBOR\_ADDR location of the neighbors. Options include:
  - <no parameter> command displays information for all neighbors.
  - *ipv6\_addr* command displays information for the specified neighbor.
- VRF\_INSTANCE specifies VRF instances. Options include:
  - <no parameter> displays routing table for the context-active VRF.
  - *vrf vrf\_name* displays routing table for the specified VRF.
  - *vrf all* displays routing table for all VRFs.
  - *vrf default* displays routing table for the default VRF.

#### Related Command

- [show ip bgp peer-group](#)

#### Example

- This command displays information for the neighbor at 2001:10:1:0::100.

```
switch#show ipv6 bgp peers 2001:10:1:0::100
BGP neighbor is 2001:10:1:0::100, remote AS 64496, external link
 BGP version 4, remote router ID 10.0.0.100, VRF default
 Inherits configuration from and member of peer-group EXTERNAL
 Negotiated BGP version 4
 Member of update group 3
 Last read 00:00:01, last write 00:00:01
 Hold time is 180, keepalive interval is 60 seconds
 Configured hold time is 180, keepalive interval is 60 seconds
 Connect timer is inactive
 Idle-restart timer is inactive
 BGP state is Established, up for 00:12:01
 Number of transitions to established: 1
 Last state was OpenConfirm
 Last event was RecvKeepAlive
 Neighbor Capabilities:
 Multiprotocol IPv6 Unicast: advertised and received and negotiated
 Four Octet ASN: advertised and received and negotiated
 Route Refresh: advertised and received and negotiated
 Send End-of-RIB messages: advertised and received and negotiated
 Additional-paths rcv capability:
 IPv6 Unicast: advertised
 Additional-paths send capability:
 IPv6 Unicast: received
 Restart timer is inactive
 End of rib timer is inactive
 Message Statistics:
 InQ depth is 0
 OutQ depth is 0
 Sent Rcvd
```

```

Opens: 1 1
Notifications: 0 0
Updates: 4 5
Keepalives: 14 14
Route-Refresh: 0 0
Total messages: 19 20
Prefix Statistics:
 Sent Rcvd
IPv4 Unicast: 0 0
IPv6 Unicast: 6 4
IPv4 SR-TE: 0 0
IPv6 SR-TE: 0 0
Inbound updates dropped by reason:
AS path loop detection: 0
Enforced First AS: 0
Originator ID matches local router ID: 0
Nextthop matches local IP address: 0
Unexpected IPv6 nextthop for IPv4 routes: 0
Nextthop invalid for single hop eBGP: 0
Inbound updates with attribute errors:
Resulting in removal of all paths in update (treat-as-withdraw): 0
Resulting in AFI/SAFI disable: 0
Resulting in attribute ignore: 0
Inbound paths dropped by reason:
IPv4 labeled-unicast NLRIs dropped due to excessive labels: 0
IPv6 labeled-unicast NLRIs dropped due to excessive labels: 0
Outbound paths dropped by reason:
IPv4 local address not available: 0
IPv6 local address not available: 0
Local AS is 64500, local router ID 10.0.0.102
TTL is 1
Local TCP address is 2001:10:1::102, local port is 45983
Remote TCP address is 2001:10:1::100, remote port is 179
Auto-Local-Addr is disabled
TCP Socket Information:
TCP state is ESTABLISHED
Recv-Q: 0/32768
Send-Q: 0/32768
Outgoing Maximum Segment Size (MSS): 1428
Total Number of TCP retransmissions: 0
Options:
Timestamps enabled: yes
Selective Acknowledgments enabled: yes
Window Scale enabled: yes
Explicit Congestion Notification (ECN) enabled: no
Socket Statistics:
Window Scale (wscale): 9,9
Retransmission Timeout (rto): 204.0ms
Round-trip Time (rtt/rtvar): 1.4ms/2.7ms
Delayed Ack Timeout (ato): 40.0ms
Congestion Window (cwnd): 10
TCP Throughput: 80.00 Mbps
Advertised Recv Window (rcv_space): 28800
switch#

```

### 14.5.4.119 show ipv6 bgp regexp

The `show ipv6 bgp regexp` command displays Border Gateway Protocol (BGP) IPv6 routing-table entries that match the AS-path attributes specified in the given regular expression.

#### Command Mode

EXEC

#### Command Syntax

```
show ipv6 bgp regexp as_paths [VRF_INSTANCE]
```

#### Parameters

- *as\_paths* list of AS paths, formatted as a regular expression. Regular expressions are pattern matching strings that are composed of text characters and operators.
- VRF\_INSTANCE specifies the VRF instance of the BGP routing table to be displayed. Options include:
  - <no parameter> displays routing table for context-active VRF.
  - *vrf vrf\_name* displays routing table for the specified VRF.
  - *vrf all* displays routing table for all VRFs.
  - *vrf default* displays routing table for default VRF.

#### Related Command

- [show ip bgp regexp](#)

#### Examples

- This command displays information about the BGP IPv6 routes in the context-active VRF that pass through AS 64496.

```
switch#show ipv6 bgp regex _64496_
BGP routing table information for VRF default
Router identifier 10.0.0.102, local AS number 64500
Route status codes: s - suppressed, * - valid, > - active, # - not installed, E - ECMP
 head, e - ECMP
 S - Stale, c - Contributing to ECMP, b - backup, L = labeled-unicast
 % - Pending BGP convergence
Origin codes: i - IGP, e - EGP, ? - incomplete
AS Path Attributes: Or-ID - Originator ID, C-LST -Cluster List, LL Nexthop - Link Local
 Nexthop

 Network Next Hop Metric LocPref Weight Path
* 2001:10:1::/64 2001:10:1::100 42 100 0 64496 ?
* > 2001:10:100::/64 2001:10:1::100 200 100 0 64496 i
* > 2001:10:100:1::/64 2001:10:1::100 0 100 0 64496 64497 65536 i
* > 2001:10:100:2::/64 2001:10:1::100 42 100 0 64496 ?
switch#
```

#### 14.5.4.120 show ipv6 bgp summary

The **show ipv6 bgp summary** command displays the summary of all IPv4 and IPv6 BGP neighbors based on Address Family Identifier (AFI) and Subsequent Address Family Identifier (SAFI) negotiations where AFI is "IPv6" and SAFI is "Unicast" information.

##### Command Mode

EXEC

##### Command Syntax

```
show ipv6 bgp summary [VRF_INSTANCE]
```

##### Parameters

- VRF\_INSTANCE specifies VRF instances. Options include:
  - <no parameter> displays routing table for context-active VRF.
  - vrf vrf\_name displays routing table for the specified VRF.
  - vrf all displays routing table for all VRFs.
  - vrf default displays routing table for default VRF.

##### Display Values

##### Header Row

- **BGP router identifier:** the router identifier; sloopback address or highest IP address.
- **Local AS number:** AS number assigned to switch.

##### Neighbor Table Columns

- **(First) Neighbor:** neighbor's IP address.
- **(Second) V:** BGP version number.
- **(Third) AS:** neighbor's AS number.
- **(Fourth) MsgRcvd:** messages received from the neighbor.
- **(Fifth) MsgSent:** messages sent to neighbor.
- **(Sixth) InQ:** messages queued from neighbor.
- **(Seventh) OutQ:** messages queued to send neighbor.
- **(Eighth) Up/Down:** period the BGP session has been Established, or its current status.
- **(Ninth) State:** state of the BGP session and the number of routes received from a neighbor.
- **(Tenth) PfxRcd:** the count of prefixes received by BGP per neighbor.
- **(Eleventh) PfxAcc:** the count of prefixes added to the BGP RIB among all received prefixes.

##### Related Command

- [show ip bgp summary](#)

##### Example

- This command displays the status of the switch's BGP connections.

```
switch#show ipv6 bgp summary
BGP summary information for VRF default
Router identifier 10.0.0.102, local AS number 64500
Neighbor Status Codes: m - Under maintenance
Neighbor V AS MsgRcvd MsgSent InQ OutQ Up/Down State PfxRcd
PfxAcc
 2001:10:1::100 4 64496 37 36 0 0 00:29:33 Estab 4 4
 2001:10:2::101 4 64510 35 38 0 0 00:29:37 Estab 4 4
switch#
```



### 14.5.4.121 show ipv6 bgp

The **show ipv6 bgp** command displays IPv6 Border Gateway Protocol (BGP) routing-table entries. The output format depends on the command parameters:

- data-block format displays comprehensive information for each specified BGP routing-table entry.
- tabular format displays routing-table entries for specified IPv6 addresses.

#### Command Mode

EXEC

#### Command Syntax

```
show ipv6 bgp [FILTER] [VRF_INSTANCE]
```

#### Parameters

- FILTER routing table entries that the command displays. Options include:
  - <no parameter> displays all routing-table entries in tabular format.
  - detail displays all routing-table entries in data-block format.
  - *ipv6\_addr* displays IPv6 host address in data-block format.
  - *ipv6\_prefix* displays the route information of specified IPv6 prefix address in data-block format. Options include:
    - detail displays the detailed route information of specified IPv6 prefix address in data-block format.
    - longer-prefixes displays the route information of IPv6 prefix in data-block format.
    - longer-prefixes detail displays detailed route information of specified IPv6 prefix in data-block format.
  - community-list *cmnty\_list\_name* displays BGP routes filtered by the specified community list.
  - installed displays the information of installed BGP routes.
  - labeled-unicast displays the information of labeled-unicast BGP routes only.
  - not-installed displays the information of BGP routes that are not installed.
- VRF\_INSTANCE specifies VRF instances. Options include:
  - <no parameter> displays routing table for context-active VRF.
  - *vrf vrf\_name* displays routing table for the specified VRF.
  - *vrf all* displays routing table for all VRFs.
  - *vrf default* displays routing table for default VRF.

#### Guidelines

You must provide the IPv6 prefix in CIDR notation.

#### Related Command

- [show ip bgp](#)

#### Examples

- This command displays the route information of 2001:10:1:0::102/64 in data-block format.

```
switch#show ipv6 bgp 2001:10:1:0::102/64
BGP routing table information for VRF default
Router identifier 10.0.0.102, local AS number 64500
BGP routing table entry for 2001:10:1::/64
 Paths: 2 available
 Local
 - from - (10.0.0.102)
 Origin IGP, metric 1, localpref 0, IGP metric -, weight -,
 received 00:16:27 ago, valid, local, best,
 redistributed (Connected)
```

---

```
 Rx SAFI: Unicast
64496
 2001:10:1::100 from 2001:10:1::100 (10.0.0.100)
 Origin INCOMPLETE, metric 42, localpref 100, IGP metric 1, weight
0, received 00:10:09 ago, valid,
external
 Rx SAFI: Unicast
switch#
```

### 14.5.4.122 show peer-filter

The **show peer-filter** command displays the definition of a peer filter.

#### Command Mode

EXEC

#### Command Syntax

```
show peer-filter filter_name
```

#### Parameters

- *filter\_name* name of the peer-filter group.

#### Example

- This command displays the peer-filter group information for “group3.”

```
switch#show peer-filter group3
peer-filter group3
 10 match as-range 65003 result accept
 20 match as-range 65007 result accept
 30 match as-range 65009 result accept
switch#
```

---

### 14.5.4.123 show tunnel rib brief

The **show tunnel rib brief** command displays the preferred tunnels for various IP endpoints, optionally filtered by endpoint. Each tunnel RIB entry in the output displays the type of the tunnel (such as BGP LU) and a numerical index uniquely identifying that tunnel within the type-specific tunnel table.

#### Command Mode

EXEC

#### Command Syntax

```
show bgp tunnel rib brief
```

#### Example

- This command displays the tunnel type and the index value.

```
switch#show tunnel rib brief
Endpoint Tunnel Type Indexes

10.1.1.0/32 BGP LU 2
11.1.1.0/32 BGP LU 1, 3
switch#
```

#### 14.5.4.124 shutdown (BGP)

The **shutdown** command disables BGP on the switch without modifying the BGP configuration.

The **no shutdown** and **default shutdown** commands enable the BGP instance by removing the **shutdown** command from *running-config*.

##### Command Mode

Router-BGP Configuration

##### Command Syntax

```
shutdown
```

```
no shutdown
```

```
default shutdown
```

##### Examples

- These commands disable BGP on the switch.

```
switch(config)#router bgp 9
switch(config-router-bgp)#shutdown
switch(config-router-bgp)#
```

- These commands enable BGP on the switch.

```
switch(config)#router bgp 9
switch(config-router-bgp)#no shutdown
switch(config-router-bgp)#
```

---

#### 14.5.4.125 timers bgp

The `timers bgp` command configures the BGP keepalive and hold times. Timer settings apply to each peer connection. The `neighbor timers` command configures the times on a specified peer connection.

- **Keepalive time:** period between the transmission of consecutive keepalive messages.
- **Hold time:** period the switch waits for a keepalive or UPDATE message before it disables peering.

The hold time must be at least 3 seconds and should be three times longer than the keepalive setting.

The `no timers bgp` and `default timers bgp` commands return the time settings to their default values by removing the `timers bgp` command from *running-config*. The default values are:

- **keepalive:** 60 seconds.
- **hold time:** 180 seconds.

##### Command Mode

Router-BGP Configuration

##### Command Syntax

##### Parameters

```
timers bgp keep_alive hold_time
```

```
no timers bgp
```

```
default timers bgp
```

- *keep\_alive* keepalive period, in seconds. Values include:
  - **0** keepalive messages are not sent.
  - **1 to 3600** keepalive time (seconds).
- *hold\_time* hold time. Values include:
  - **0** peering is not disabled by timeout expiry; keepalive packets are not sent.
  - **3 to 7200** hold time (seconds).

##### Example

- This command sets the keepalive time to 30 seconds and the hold time to 90 seconds.

```
switch(config)#router bgp 9
switch(config-router-bgp)#timers bgp 30 90
switch(config-router-bgp)#
```

### 14.5.4.126 update wait-for-convergence

The **update wait-for-convergence** command disables FIB updates and route advertisement when the BGP instance is initiated until the BGP convergence state is reached.

The **no update wait-for-convergence** command allows FIB updates and route advertisement irrespective of the BGP convergence state.

#### Command Mode

Router-BGP Configuration

#### Command Syntax

```
update wait-for-convergence
no update wait-for-convergence
default update wait-for-convergence
```

#### Related Commands

- `clear ip bgp` removes learned BGP routes from the routing table, reads all routes from designated peers, and sends routes to those peers as required.
- `bgp convergence slow-peer time` configures the BGP convergence idle peer timeout value.
- `bgp convergence time` configures the BGP convergence timeout value.
- `show bgp convergence` displays information about the BGP convergence state; and other statistics about the BGP instance in either the specified VRF or all VRFs.

#### Guidelines

The initiation of BGP instance includes the following scenarios:

- the BGP instance starts for the first time after a switch is reloaded.
- the BGP instance restarts.
- all sessions are cleared by using the `clear ip bgp *` command.

Configuration changes made by using this command are effective from the next initiation of a BGP instance.

#### Example

- This command disables FIB updates and route advertisement when the BGP instance is initiated until the BGP convergence state is reached.

```
switch(config)#router bgp 9
switch(config-router-bgp)#update wait-for-convergence
switch(config-router-bgp)#
```

---

#### 14.5.4.127 vrf

The **vrf** command places the switch in BGP VRF configuration mode for the specified VRF. Commands issued in this mode will override global BGP configuration for the specified VRF.

##### Command Mode

Router-BGP Configuration

##### Command Syntax

```
vrf vrf_instance
```

##### Parameters

- *vrf\_instance* VRF to be configured.

##### Example

- These commands place the switch in BGP VRF configuration mode for VRF “purple.”

```
switch(config)#router bgp 9
switch(config-router-bgp)#vrf purple
switch(config-router-bgp-vrf-purple)#
```

## 14.6 Maintenance Mode

This section describes configuration for performing maintenance of switch elements.

This section contains these topics:

- [Overview](#)
- [Maintenance Mode Elements](#)
- [Maintenance Mode Features](#)
- [Maintenance Mode Configuration](#)
- [Maintenance Mode Commands](#)

### 14.6.1 Overview

Using maintenance mode, you can perform several maintenance activities such as:

- EOS image upgrade
- Initial configuration or reconfiguration of a production system
- Replacement of hardware
- Changing linecards or transceiver modules
- Replace, reattach, and reroute cables

Maintenance mode uses BGP to divert traffic away from the switch on which the maintenance tasks need to be performed, minimizing traffic impact. You can set the traffic thresholds and time limits at which the switch, or parts of the switch, is considered to be available for maintenance tasks.

Maintenance mode can be activated on a switch at boot-up or during operation. The mode provides the following benefits:

- Rerouting of traffic when the mode is activated during operation and other routes are present
- Replacement of hardware in modular systems or systems with redundant hardware

The switch is placed into maintenance mode, serviced, and then returned to normal operation.



## 14.6.2 Maintenance Mode Elements

Maintenance mode elements include [Units](#), [Groups of Interfaces and BGP Peers](#), and [Profiles](#). Arista Network switches provide maintenance mode operations performed on a fundamental, configurable element, referred to as a Unit. Maintenance mode will quiesce a unit, which places the unit into maintenance mode by gracefully transitioning traffic away from it.

The most common maintenance mode operations such as removing from service an entire switch system or individual components of the switch, including a single linecard, interface, or BGP peer, can be achieved using minimal configuration.

### 14.6.2.1 Units

Units are configurable maintenance mode elements that comprise a collection of various groups. In addition, units contain policies which decide whether the member groups should be put into maintenance mode automatically upon boot. Built-in units are configured by default, such as the System unit representing the entire system. All maintenance mode operations are executed at the unit level.

An interface, interface range, and BGP peer (or peer-group) can be directly put under maintenance.

#### 14.6.2.1.1 Built-in Units

There are various built-in units such as **System** and **Linecard<n>**. Fixed systems contain only one built-in unit called **System**, which comprises the interface group containing all Ethernet interfaces and sub-interfaces; and BGP groups per VRF containing all the peers in the respective VRF.

Modular Systems have both **System** and **Linecard<n>** units. **Linecard<n>** units are present for each linecard which comprises the **Linecard<n>** groups containing all Ethernet interfaces and sub-interfaces of that linecard.

#### 14.6.2.1.2 User-configured Units

You can also configure customized units containing user-defined groups and policies as shown in the following example. A custom group called BG1 with a custom interface IG1 and a unit profile UP1 is created. The show command displays the details.

```
switch(config)#maintenance
switch(config-maintenance)#unit UNIT1
switch(config-unit-UNIT1)#group bgp BG1
switch(config-unit-UNIT1)#group interface IG1
switch(config-unit-UNIT1)#profile unit UP1
switch(config-unit-UNIT1)#exit
switch(config-maintenance)#show maintenance units
Unit Name: System
Origin: Built-in
Status: Not Under Maintenance
Unit Profile: Default
Time Since Last State Change: never
Bgp Groups:
AllBgpNeighborVrf-default
Interface Groups:
AllEthernetInterface
Unit Name: UNIT1
Origin: User Configured
Status: Under Maintenance
Unit Profile: UP1
Time Since Last State Change: 0:00:08 ago
Bgp Groups:
BG1
```

```
Interface Groups:
IG1
```

### 14.6.2.2 Groups of Interfaces and BGP Peers

Maintenance mode group types include the groups for interfaces and BGP peers. Groups are identified by a group name unique to a particular group type.

By default, several built-in groups are available on the device such as **linecard** groups containing physical interfaces.

#### 14.6.2.2.1 Built-in Groups

There are several built-in groups such as **AllEthernetInterface**, **Linecard1**, **Linecard2**, etc., **AllBgpNeighborVrf-<vrf\_name>**. **AllEthernetInterface** is the built-in interface group which contains all physical Ethernet interfaces and sub-interfaces on the switch, and is a part of **System** unit. Whereas on modulars **Linecard1**, **Linecard2**, etc., are the built-in groups which contain respective linecard interfaces and sub-interfaces; and are part of the **Linecard1** and **Linecard2** units respectively. **AllBgpNeighborVrf-<vrf\_name>** is the built-in BGP group which contains all the BGP peers in that particular VRF.

#### 14.6.2.2.2 User-defined Groups

The following set of commands sets up a custom group (IG1) of interfaces, which includes physical ports, port-channels and SVIs.

```
switch(config)#group interface IG1
switch(config-group-if-IG1)#interface Ethernet1
switch(config-group-if-IG1)#interface Port-Channel1,20
switch(config-group-if-IG1)#interface Vlan1-20
switch(config-group-if-IG1)#exit
switch(config)#
```



**Note:** User-defined interface groups do not contain sub-interfaces.

The following set of commands sets up a custom group (BG1) of BGP peers.

```
switch(config)#group bgp BG1
switch(config-group-bgp-BG1)#neighbor 10.0.0.1
switch(config-group-bgp-BG1)#neighbor BGP_PG1
switch(config-group-bgp-BG1)#vrf vrf1
switch(config-group-bgp-BG1)#exit
switch(config)#
```



**Note:** BGP groups are specific to VRF.

### 14.6.2.3 Profiles

Profiles are configurable maintenance mode elements that define policies for related software or hardware components to carry out maintenance mode operations.

#### 14.6.2.3.1 Default Profiles

Default profiles are the built-in policies which are applied to groups interface/BGP and unit.

The default profile is used in the absence of an explicit interface/BGP profile associated with the group, or explicit unit profile associated with the unit.

- **Interface Profile**

Default interface profile has rate-monitoring load-interval set to 60 seconds, threshold set to 100 kbps, and shutdown disabled as shown. The max-delay parameter is set to 300 seconds but is not enabled.

```
switch(config-maintenance)#show maintenance profile interface default
Interface Profile: Default
Rate Monitoring:
load-interval: 60 seconds
threshold (in/out): 100 kbps
shutdown:
enabled: no
max-delay: 300 seconds
```

- **BGP Profile**

Default BGP profile has route-map with set clauseset community GSHUT additive and set local-preference 0.

```
switch(config-maintenance)#show maintenance profile bgp default
Bgp Profile: Default
Initiator route-map: SystemGenerated
route-map SystemGenerated permit 10
Description:
description System generated initiator route-map
Match clauses:
SubRouteMap:
Set clauses:
set local-preference 0
set community GSHUT additive
```

- **Unit Profile**

Default unit profile has on-boot setting disabled.

```
switch(config-maintenance)#show maintenance profiles unit default
Unit Profile: Default
On-boot:
enabled: no
duration: 300 seconds
```

### 14.6.2.3.2 User-defined Profiles

You can define your own profiles which can be associated to groups or set as default profiles.

**Interface Profile:** The following set of commands sets up an Interface Profile(IP1) with load interval set to 10 seconds, rate-monitoring threshold set to 100kbps and the maximum delay for shutting down the interface set to 100 seconds. The interface will be shutdown with cause maint-down if traffic does not drain below the threshold even after the specified maximum delay period of 100 seconds.

```
switch(config)#maintenance
switch(config-maintenance)#profile interface IP1
switch(config-profile-intf-IP1)#rate-monitoring load-interval 10
switch(config-profile-intf-IP1)#rate-monitoring threshold 100
switch(config-profile-intf-IP1)#shutdown max-delay 100
switch(config-profile-intf-IP1)#exit
switch(config-maintenance)#
```

An interface profile can be associated to only interface groups using the following set of commands.

```
switch(config)#group interface IG1
```

```
switch(config-group-if-IG1) #maintenance profile interface IP1
switch(config-group-if-IG1) #exit
switch(config) #
```

You can set the interface profile as the default interface profile using the following set of commands.

```
switch(config) #maintenance
switch(config-maintenance) #profile interface IP1 default
switch(config-maintenance) #exit
switch(config) #
```

**Bgp Profile:** The following set of commands sets up a BGP profile(BP1) with initiator route-map called RM which will be applied for both inbound and outbound directions.

```
switch(config) #maintenance
switch(config-maintenance) #profile bgp BP1
switch(config-profile-bgp-BP1) #initiator route-map RM inout
switch(config-profile-bgp-BP1) #exit
switch(config-maintenance) #
```

A BGP profile can be associated to both interface and bgp groups using the following commands.

```
switch(config) #group interface IG1
switch(config-group-if-IG1) #maintenance profile bgp BP1
switch(config-group-if-IG1) #exit
switch(config) #group bgp BG1
switch(config-group-bgp-BG1) #maintenance profile bgp BP1
switch(config-group-bgp-BG1) #exit
switch(config) #
```

You can set the bgp profile as the default bgp profile using the following set of commands.

```
switch(config) #maintenance
switch(config-maintenance) #profile bgp BP1 default
switch(config-maintenance) #exit
switch(config) #
```

**Unit Profile:** The following set of commands sets up a Unit profile(UP1) with on-boot duration of 300 seconds. The unit will enter into maintenance mode at boot-up and exit maintenance mode at the end of 5 minutes (300sec) after boot-up.

```
switch(config-maintenance) #profile unit UP1
switch(config-profile-unit-UP1) #on-boot duration 300
switch(config-profile-unit-UP1) #exit
switch(config-maintenance) #
```

A Unit profile can be associated to a Unit using the following commands.

```
switch(config) #maintenance
switch(config-maintenance) #unit UNIT1
switch(config-unit-UNIT1) #profile unit UP1
switch(config-unit-UNIT1) #exit
switch(config-maintenance) #
```

You can set the Unit profile as the default Unit profile using the following set of commands.

```
switch(config) #maintenance
switch(config-maintenance) #profile unit UP1 default
switch(config-maintenance) #exit
```

```
switch(config)#
```

### 14.6.3 Maintenance Mode Features

Arista Network switches provide maintenance mode features including rate monitoring, BGP maintenance route map, on-boot maintenance, and EventMgr integration.

#### 14.6.3.1 Rate Monitoring

Rate monitoring provides a mechanism to monitor traffic on interfaces identified for maintenance. You can set the traffic threshold and a time limit for the interface to be shutdown for maintenance tasks.

A shutdown parameter can be configured in the interface profile that signals the interface to be shutdown after it has entered maintenance mode.

The max-delay parameter specifies the maximum number of seconds to allow for traffic to dissipate from the interface before the interface is shutdown. The default interface profile settings are shown in the output of the `show maintenance profile interface default` command.

 **Note:** The exclusive rate monitoring of sub-interfaces is not supported. Sub-interfaces inherit the interface profile from its parent interface. In case of multiple sub-interfaces configured for single parent interface, rate monitoring of parent interface include aggregate values of all respective sub-interfaces.

#### 14.6.3.2 BGP Maintenance Route Map

Route-maps are used within a BGP maintenance profile to tag the inbound and outbound routes in order to direct traffic away from the unit.

The default profile tags the inbound and outbound routes with the global shutdown community. Other methods can be configured under the route-map such as alternate communities, or by using AS\_PATH prepend operations.

#### 14.6.3.3 On-boot Maintenance

There are two ways of placing a unit in maintenance mode on switch boot-up:

- The unit is placed into maintenance mode prior to the switch reboot, and the running-config is saved prior to switch boot-up.
- The on-boot property in the unit maintenance profile specifies that the unit will be placed into maintenance mode as part of boot-up, and remains so for the specified duration.

 **Note:** The duration value in the on-boot unit maintenance profile starts as soon as the unit is put into maintenance mode on boot-up.

### 14.6.4 Maintenance Mode Configuration

You can configure maintenance mode for the entire device, specific linecards, or any other Unit. You can set up configuration for maintenance mode for the device at boot-up or while it is running.

 **Note:** Explicit maintenance of sub-interfaces is not supported. Sub-interfaces are put into maintenance implicitly in case of built-in unit maintenance and interface maintenance but not in case of user-configured units.

#### 14.6.4.1 Unit (System, Linecardn, etc.) Configuration

Arista Network switches provide the ability to place the switch in maintenance mode, and configuration options for groups, profiles, associating profiles with groups, units, and maintenance mode operations. **System** is a predefined (built-in) unit on all switches. Built-in groups include **AllEthernetInterface**,

**AllBgpNeighborVRF-`<vrf_name>`**, and **Linecardn**. **Linecardn** can also be a built-in unit and can be differentiated depending on the command being used as shown.

- `switch(config-maintenance) #unit Linecardn`
- `switch(config) #group interface Linecardn`

Built-in unit **System** comprises the following groups:

- **AllEthernetInterface** - a built-in interface group which contains all physical Ethernet interfaces on the switch on a fixed system
- **Linecardn** - a built-in interface group which contains all interfaces for the linecard numbered n for modular systems
- **AllBgpNeighborVRF-`<vrf_name>`** - a built-in BGP group which contains all the BGP peers in the named VRF.

For each Linecard n, there is a built-in unit which consists of all the **Linecardn** groups.

By default, the default interface and BGP profiles are applied to the built-in interface and BGP groups and the default built-in unit profile is applied to the built-in unit. You can also configure your own profiles and choose a default.

In the following example, traffic is flowing through multiple switches in the spine to and from one switch to another, when you elect to put one of the Units (entire switch or parts thereof) in the spine switch in maintenance mode. The traffic is then gracefully steered away from the Unit, provided other paths are available. Traffic will continue to flow through the Unit placed into maintenance mode, if no other path is available.

### Example

 **Note:** The illustration shows an entire switch as the Unit. You can replace switch with Linecardn or another relevant Unit as appropriate.

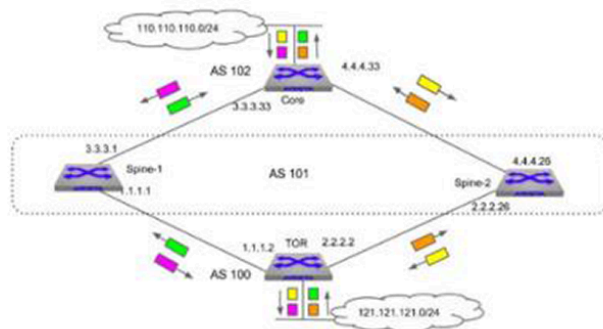

**Figure 59: Traffic flow pattern between TOR and Core Before Maintenance**

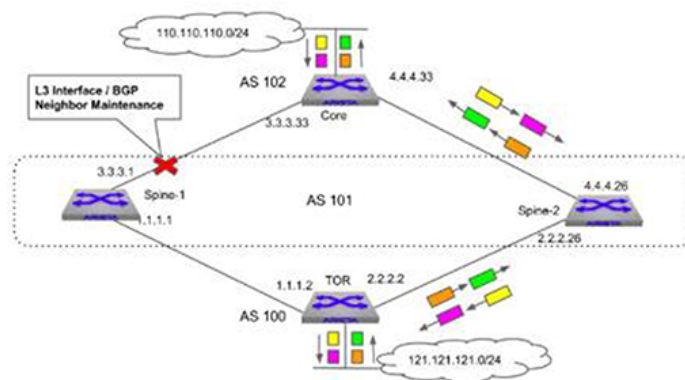

**Figure 60: Traffic flow pattern between TOR and Core After unit on Spine-1 is put into Maintenance**

You can see the status of the Unit (System) using the `show maintenance units System` command for the example above before the system is placed into maintenance mode. If the device being placed into maintenance mode is modular and the Unit is a linecard, replace the argument **System** with **Linecardn** to see the status of the Unit (Linecardn).

```
switch(config)#show maintenance units System
Unit Name: System
 Origin: Built-in
 Status: Not Under Maintenance
 Unit Profile: Default
 Time Since Last State Change: never
 Bgp Groups:
 AllBgpNeighborVrf-default
 Interface Groups:
 AllEthernetInterface
```

You can then place the Unit (System) into maintenance mode and recheck the status using the sequence of commands shown.

```
switch(config-maintenance)#unit System
switch(config-builtin-unit-System)#quiesce
switch(config-builtin-unit-System)#exit
switch(config-maintenance)#show maintenance
Flags:
o - On-boot maintenance
v - Violating traffic threshold
```

| Unit Name | Status            | Time since last change |
|-----------|-------------------|------------------------|
| System    | Under Maintenance | 0:02:03 ago            |

```
switch(config-maintenance)# show ip bgp summary
BGP summary information for VRF default
Router identifier 1.1.1.1, local AS number 101
Neighbor Status Codes: m - Under maintenance
Neighbor V AS MsgRcvd MsgSent InQ OutQ Up/Down
State
PfxRcd PfxAcc
m 1.1.1.2 4 100 24 17 0 0 00:00:40
 Estab 5 5
m 3.3.3.33 4 102 15 16 0 0 00:06:23
 Estab 1 1
```



**Note:** The 'o' flag is shown for on-boot maintenance in the **show maintenance** command and the 'm' neighbor status flag in the **show ip bgp summary** command indicates that the peer is in maintenance mode.

#### 14.6.4.2 On-boot Maintenance Mode Configuration

To configure on-boot maintenance, you can use one of two methods:

- Use **quiesce config** or
- Use on-boot profile

##### 14.6.4.2.1 Using quiesce config

You must perform the following tasks to place the Unit in maintenance mode on boot-up using the **quiesce** command.

1. Place the unit into maintenance mode prior to switch reboot using the following commands.

```
switch(config)#maintenance
switch(config-maintenance)#unit System
switch(config-unit-System)#quiesce
switch(config-unit-System)#exit
switch(config-maintenance)#show maintenance
```

Flags:

o - On-boot maintenance

v - Violating traffic threshold

Unit Name Status Time since last change Flags

-----

System Under Maintenance 00:01:10 ago

2. Save the running-config using the following command.

```
switch(config)#copy running-config startup-config
Copy completed successfully
switch(config)#
```

3. Reload the device.

```
switch(config)#reload
Proceed with reload? [Confirm] Yes
Connection to switch closed.
```

After the device comes up, you must execute the **no quiesce** command for the Unit to come out of maintenance mode. You can check the status of the device after it comes up using the **show maintenance** command.

```
switch#show maintenance
Flags:
o - On-boot maintenance
v - Violating traffic threshold
Unit Name Status Time since last change Flags

System Under Maintenance 00:03:10 ago
```



### 14.6.4.2.2 Using on-boot profile

The on-boot property in the Unit maintenance profile specifies that the Unit will be placed into maintenance mode as part of boot-up for the specified duration. You must perform the following tasks to use this method.

1. Check to see if the on-boot maintenance mode is enabled using the **show maintenance profiles unit default**.

```
switch#show maintenance profiles unit default
Unit Profile: Default
On-boot:
enabled: no
duration: 300 seconds
```

2. Configure an on-boot profile with on-boot enabled and a duration specified. Make this the default Unit profile. The following code example shows the creation of an on-boot duration of 300 seconds in the profile unit UP1

```
switch(config)#maintenance
switch(config-maintenance)#profile unit UP1
switch(config-profile-unit-UP1)#on-boot duration 300
switch(config-profile-unit-UP1)#exit
switch(config-maintenance)#profile unit UP1 default
switch(config-maintenance)#show maintenance profiles unit default
Unit Profile: UP1
On-boot:
enabled: yes
duration: 300 seconds
switch(config-maintenance)#
```

3. Save the running-config and reload the device.

```
switch(config)#copy running-config startup-config
Copy completed successfully
switch(config)# reload
Connection to switch closed.
```

4. After the device comes up, execute the **show maintenance** and **show maintenance units System** commands.

```
switch(config)#show maintenance
Flags:
o - On-boot maintenance
v - Violating traffic threshold
Unit Name Status Time since last change Flags

System Under Maintenance 00:00:08 ago o
switch(config)# show maintenance units System
Unit Name: System
Origin: Built-in
Status: Under Maintenance (on-boot)
Unit Profile: UP1
Time Since Last State Change: 0:00:16 ago
Will come out of on-boot Maintenance after 0:04:43
Interface Groups:
AllEthernetInterface
History:
2017-01-18 00:44:39 old state: 'maintenanceModeEnter' to new state:
'underMaintenance' 0:00:16 ago
2017-01-18 00:43:54 old state: 'active' to new state: 'maintenanceM
odeEnter'
```

0:01:01 ago

The `o` - flag shows that unit `System` is under maintenance due to on-boot profile. Also, `show maintenance units System` output shows the following - Will come out of on-boot Maintenance after 0:04:43, which is the time remaining of the specified duration of 5 minutes.

The Unit will come up in maintenance mode when the device boots up and will exit maintenance mode once the specified duration of 300 seconds in the default profile is completed. The BGP sessions will remain under maintenance for the duration and will resume after the specified duration is over.

#### 14.6.4.3 Interface-level Maintenance Mode Configuration

To configure the maintenance mode at interface-level, you must perform the following tasks:

1. Configure an interface-level profile (or use a pre-configured one). The following code example creates a user-defined interface profile `IP1` with a rate-monitoring load-interval of 100 seconds, a rate-monitoring threshold of 500 kbps and a maximum shutdown delay of 100 seconds.

```
switch(config)#maintenance
switch(config-maintenance)#profile interface IP1
switch(config-maint-if-Et5)#rate-monitoring load-interval 100
switch(config-maint-if-Et5)#rate-monitoring threshold 500
switch(config-maint-if-Et5)#shutdown max-delay 100
```

2. Make the user-defined interface profile `IP1` as the default interface profile.

```
switch(config-maintenance)#profile interface IP1 default
```

3. Place the interface into maintenance mode.

```
switch(config)#maintenance
switch(config-maintenance)#interface Ethernet 1
switch(config-maint-if-Et1)#quiesce
```

4. Remove the interface from maintenance mode once the service has been performed.

```
switch(config-maintenance)#interface Ethernet 1
switch(config-maint-if-Et1)#no quiesce
```



**Note:** If interface `Et1` has sub-interfaces (`Et1.1`, `Et1.2`,...) with BGP peers on these sub-interfaces, then these sub-interfaces are also placed into maintenance mode. The `show maintenance interface <sub-interface> detail` command displays the maintenance state of sub-interfaces.

#### 14.6.4.4 Entering Maintenance Mode

Enter configuration commands `unit` and `quiesce` using the `maintenance profile bgp` mode command to place the switch into maintenance mode. The following code sequence places unit `foo`, the interface `3/3`, and BGP `1.1.1.1` in maintenance mode.

##### Example

```
switch(config)#maintenance
switch(config-maintenance)#unit foo
switch(config-unit-foo)#quiesce
switch(config-unit-foo)#exit
switch(config-maintenance)#interface ethernet 3/3
switch(config-maint-if-Et3/3)#quiesce
switch(config-unit-if-Et3/3)#exit
```

```
switch(config-maintenance) #bgp 1.1.1.1
switch(config-maint-bgp-1.1.1.1) #quiesce
switch(config-maint-bgp-1.1.1.1) #exit
switch(config-maintenance) #
```

#### 14.6.4.5 Exiting Maintenance Mode

Enter configuration commands **unit** and **no quiesce** using the **maintenance profile bgp** mode command for the switch to exit maintenance mode. The following code sequence causes unit foo, the interface 3/3, and BGP 1.1.1.1 to exit maintenance mode.

##### Example

```
switch(config) #maintenance
switch(config-maintenance) #unit foo
switch(config-unit-foo) #no quiesce
switch(config-unit-foo) #exit
switch(config-maintenance) #interface ethernet 3/3
switch(config-maint-if-Et3/3) #quiesce
switch(config-unit-if-Et3/3) #exit
switch(config-maintenance) #bgp 1.1.1.1
switch(config-maint-bgp-1.1.1.1) #no quiesce
switch(config-maint-bgp-1.1.1.1) #exit
switch(config-maintenance) #
```

#### 14.6.4.6 Configuring Event Handlers

Enter configuration options for the **show maintenance** command to fire at different stages while entering or exiting maintenance mode.

##### Example for Maintenance Mode Event Handler for all Stages

```
switch(config) #event-handler foo
switch(config-handler-foo) #trigger on-maintenance enter unit unit-foo all
switch(config-handler-foo) #action bash /mnt/flash/mm-event-handler-script
switch(config-handler-foo) #timeout 20
switch(config-handler-foo) #exit
switch(config) #
```



**Note:** The user is expected to configure the timeout value. This is time within which the script should complete execution and exit. If the script has not exited by the end of this period, then the following will occur:

1. Send the SIGUSR1 signal to the script.
2. Wait for a GRACE-PERIOD of 10 seconds for the script to exit.
3. If the script does not exit even after that GRACE-PERIOD, then send a SIGKILL to the script.
4. The maintenance operation progresses to the next stage.

GRACE-PERIOD is not configurable.

```
switch(config) #event-handler bar
switch(config-handler-bar) #trigger on-maintenance exit unit unit-foo
before
stage ratemon
switch(config-handler-bar) #action bash /mnt/flash/mm-event-handler-script
switch(config-handler-bar) #exit
```

```
switch(config) #
```

#### 14.6.4.7 Configuring Groups

Enter the maintenance mode configuration options for groups with the `maintenance` and `group bgp` commands.

##### Example for group interface IG1

```
switch(config) #group interface IG1
switch(config-group-if-IG1) #interface Ethernet1
switch(config-group-if-IG1) #interface Port-Channel1,20
switch(config-group-if-IG1) #interface Vlan1-20
switch(config-group-if-IG1) #exit
switch(config) #
```

##### Example for group bgp BG1

```
switch(config) #group bgp BG1
switch(config-group-bgp-BG1) #neighbor 10.0.0.1
switch(config-group-bgp-BG1) #neighbor BGP_PG1
switch(config-group-bgp-BG1) #vrf vrf1
switch(config-group-bgp-BG1) #exit
switch(config) #
```



**Note:** BGP groups are specific to VRF.

#### 14.6.4.8 Configuring Profiles

Enter the maintenance mode configuration options for profiles with the `profile interface`, `rate-monitoring threshold`, `profile bgp`, and `profile unit <profile_name>` commands.

These command examples assign a user configured profile as the **default** profile.

##### Example for profile interface IP1

```
switch(config) #maintenance
switch(config-maintenance) #profile interface IP1
switch(config-profile-intf-IP1) #rate-monitoring load-interval 10
switch(config-profile-intf-IP1) #rate-monitoring threshold 100
switch(config-profile-intf-IP1) #shutdown max-delay 100
switch(config-profile-intf-IP1) #profile interface IP1 default
switch(config-profile-intf-IP1) #exit
switch(config-maintenance) #
```

##### Example for profile bgp BP1

```
switch(config-maintenance) #profile bgp BP1
switch(config-profile-bgp-BP1) #initiator route-map rmap inout
switch(config-profile-bgp-BP1) #profile bgp BP1 default
switch(config-profile-bgp-BP1) #exit
switch(config-maintenance) #
```

### Example for profile unit UP1

```
switch(config-maintenance) #profile unit UP1
switch(config-profile-unit-UP1) #on-boot duration 300
switch(config-profile-unit-UP1) #profile unit UP1 default
switch(config-profile-unit-UP1) #exit
switch(config-maintenance) #
```

#### 14.6.4.9 Associating Profiles with Groups

Enter the maintenance mode configuration options for associating profiles with groups using the `maintenance` and `group bgp` command.

#### Example

```
switch(config) #group interface IG1
switch(config-group-if-IG1) #maintenance profile bgp BP1
switch(config-group-if-IG1) #maintenance profile interface IP1
switch(config-group-if-IG1) #
```



**Note:** An interface/BGP profile can be associated with the interface group, and a BGP profile can be associated with the BGP group.

#### 14.6.4.10 Configuring Units

Enter the maintenance mode configuration options for units using the `unit`, `group bgp`, and `maintenance` commands.

#### Example

```
switch(config) #maintenance
switch(config-maintenance) #unit foo
switch(config-unit-foo) #group bgp BG1
switch(config-unit-foo) #group interface IG1
switch(config-unit-foo) #profile unit UP1
```

### 14.6.5 Show Commands

Maintenance mode show commands display general and detailed information associated with maintenance mode.

#### 14.6.5.1 show maintenance example

This example of the `show maintenance` command displays maintenance mode details.

#### Example

```
switch(config) #show maintenance
Flags:
o - On-boot maintenance
v - Violating traffic threshold
Unit Name Status Time since last change Flags

System Not Under Maintenance never
Foo Under Maintenance 0:00:14 ago ov
Interface Name Status Time since last change Flags
```

```

Ethernet4 Entering Maintenance 0:00:24 ago
Bgp Neighbor(vrf: defa Status Time since last change Flags

12.12.12.12 Under Maintenance 0:00:04 ago
Bgp Neighbor(vrf: red) Status Time since last change Flags

12.12.12.13 Under Maintenance 0:00:34 ago

switch(config)#

```

#### 14.6.5.2 show maintenance summary example

This example of the `show maintenance summary` command displays a summary of maintenance mode information.

##### Example

```

switch(config)#show maintenance summary
Number of Units configured: 3
Number of Units not under maintenance: 2
Number of Units entering maintenance: 1
Number of Units under maintenance: 0
Number of Units exiting maintenance: 0
Directly Put Under Maintenance:
 Number of interfaces entering maintenance: 0
 Number of interfaces under maintenance: 2
 Number of bgp peers entering maintenance: 0
 Number of bgp peers under maintenance: 3
Rate Monitoring:
 Number of interfaces entering maintenance: 0
 Number of interfaces under maintenance: 4
 Number of interfaces under maintenance with threshold violation:
0
 Number of interfaces shutdown for maintenance: 0

switch(config)#

```

#### 14.6.5.3 show maintenance units example

This example of the `show maintenance units` command displays maintenance mode units details.

##### Example

```

switch(config)#show maintenance units
Unit Name: Linecard3
Origin: User Configured
Status: Under Maintenance
Unit Profile: Default
Time Since Last State Change: 0:12:07 ago
Interface Groups:
IG1
Interface Traffic Threshold violations:
Current violations: 1
Etl
Total violations, during maintenance: 5
History:

```

```
2016-04-27 04:00:42 old state: 'maintenanceModeEnter' to new state:
'underMaintenance' 0:12:07 ago
2016-04-27 03:59:31 old state: 'active' to new state: 'maintenanceM
odeEnter'
0:13:18 ago
Unit Name: System
Origin: Built-in
Status: Not Under Maintenance
Unit Profile: Default
Time Since Last State Change: never
Interface Groups:
AllEthernetInterface

switch(config)#
```

#### 14.6.5.4 show maintenance bgp example

This example of the `show maintenance bgp` command displays maintenance mode BGP details for all IPs and VRFs.

##### Example

```
switch(config)#show maintenance bgp ip all vrf all
BGP peer maintenance information for VRF default
Router identifier 2.2.2.1, local AS number 1
Neighbor: 2.2.2.2
Maintenance State: Not Under Maintenance
BGP peer maintenance information for VRF red
Router identifier 6.6.6.1, local AS number 1
Neighbor: 1.1.1.2
Maintenance State: Not Under Maintenance
Router identifier 2.2.2.1, local AS number 1
Neighbor: 2.2.2.2
Maintenance State: Not Under Maintenance
Maintenance route-map: SystemGenerated
route-map SystemGenerated permit 10
Description:
Match clauses:
Set clauses:
set community GSHUT additive
set local-preference 0
Selected profile from BGP groups: Default

switch(config)#
```

#### 14.6.5.5 show maintenance interface example

This example of the `show maintenance interface status` command displays maintenance mode interface details.

##### Example

```
switch(config)#show maintenance interface
Flags:
v - Violating traffic threshold
s - Shutdown for maintenance
Rate (Mbps)
Interface Status In Out Flags

```

```
Ethernet1 Under Maintenance 0.4 0.0 v
Ethernet2 Under Maintenance 0.0 0.0
Ethernet3 Not Under Maintenance - -
Ethernet4 Under Maintenance 0.0 0.0
Ethernet5 Not Under Maintenance - -

switch(config)#
```

#### 14.6.5.6 show maintenance interface status quiesced

This example of the `show maintenance interface status quiesced` command displays maintenance mode interface status details for quiesced interfaces.

#### Example

```
switch(config)#show maintenance interface status quiesced
Flags:
v - Violating traffic threshold
s - Shutdown for maintenance
Rate (Mbps)
Interface Status In Out Flags

Ethernet1 Under Maintenance 0.3 0.0 v
Ethernet2 Under Maintenance 0.0 0.0
Ethernet4 Under Maintenance 0.0 0.0

switch(config)#
```

#### 14.6.5.7 show maintenance groups example

This example of the `show maintenance groups` command displays maintenance mode group details.

#### Example

```
switch(config)#show maintenance groups
Interface Group: IG1
Interfaces:
Et4-6
Profiles:
Interface Profile: IP1
Units: newEt
Bgp Group: BG
Neighbors:
IPv4 Peers: 4.4.4.2, 1.1.1.2, 3.3.3.2
IPv6 Peers: 3::3
Bgp Profile: prepend
Units: newBG

switch(config)#
```

#### 14.6.5.8 show maintenance profiles example

This example of the `show maintenance profiles` command displays maintenance mode profile details.



**Example**

```

switch(config)#show maintenance profiles
Interface Profile: INTFPROFILE
Rate Monitoring:
load-interval: 444 seconds
threshold (in/out): 4000 Kbps
shutdown:
enabled: yes
max-delay: 399 seconds
Bgp Profile: BGPPROFILE
Initiator route-map:
name: rm
Unit Profile: UNITPROFILE
On-boot:
enabled: yes
duration: 340 seconds

switch(config)#

```

**14.6.5.9 show interface status**

This example of the `show interface <intf_name> status` command displays maintenance mode information for interfaces.

**Example**

```

switch(config)#show interface status
Port Name Status Vlan Duplex Speed TypeFlags
Et1 connected 1 full 10G EbraTestPhyP mv
Et2 connected 1 full 10G EbraTestPhyP m
Et3 maint-down 1 full 10G EbraTestPhyP m
Et4 maint-down 1 full 10G EbraTestPhyP m
Et5 connected 1 full 10G EbraTestPhyP
Et6 connected 1 full 10G EbraTestPhyP
switch(config)#

```

**14.6.5.10 show interface ethernet**

This example of the `show interface ethernet` command displays maintenance mode information for an ethernet interface.

**Example**

```

switch(config)#show interface ethernet 4
Ethernet4 is down, line protocol is down (maint-down)
Hardware is Ethernet, address is 0000.0101.0004 (bia 0000.0101.0004)
Ethernet MTU 9214 bytes , BW 10000000 kbit
Full-duplex, 10Gb/s, auto negotiation: off, uni-link: unknown
Down 18 minutes, 39 seconds
Under maintenance for 18 minutes, 42 seconds
2 link status changes since last clear
Last clearing of "show interface" counters never
5 minutes input rate 0 bps (0.0% with framing overhead), 0 packets/sec
5 minutes output rate 0 bps (0.0% with framing overhead), 0 packets/sec
0 packets input, 0 bytes
Received 0 broadcasts, 0 multicast
0 runts, 0 giants
0 input errors, 0 CRC, 0 alignment, 0 symbol, 0 input discards

```

```
0 PAUSE input
94 packets output, 11562 bytes
Sent 0 broadcasts, 94 multicast
0 output errors, 0 collisions
0 late collision, 0 deferred, 0 output discards
0 PAUSE output

switch(config)#
```

#### 14.6.5.11 show ip bgp neighbors

This example of the **show ip bgp neighbors** command displays IP BGP neighbors maintenance mode details.

##### Example

```
switch(config)#show ip bgp neighbors 1.1.1.2
BGP neighbor is 1.1.1.2, remote AS 1, external link
...
Prefix statistics:
Sent Rcvd
IPv4 prefixes: 0 0
IPv6 prefixes: 0 0
Inbound route map is foo
Outbound route map is foo
Session is under maintenance
Maintenance-mode:
Inbound and Outbound policy
Route map is SystemGenerated

switch(config)#
```

#### 14.6.5.12 show ip bgp summary

This example of the **show ip bgp summary** command displays maintenance mode information for IP BGP.

##### Example

```
switch(config)#show ip bgp summary
BGP summary information for VRF default
Router identifier 192.168.201.13, local AS number 100
Neighbor Status Codes: m - Under maintenance
Neighbor V AS MsgRcvd MsgSent InQ OutQ Up/Down State PfxRcd
PfxAcc
m 1.0.0.1 4 300 983 988 0 0 16:16:03 Estab 1 1
1.0.1.1 4 300 983 983 0 0 16:15:58 Estab 1 1

switch(config)#
```

#### 14.6.5.13 show maintenance stages example

These examples of the **show maintenance stages** command display maintenance mode stages details.

##### Example

```
switch(config)#show maintenance stages
```

```

Maintenance Enter Stage Sequence
No. Stage Description

1 bgp BGP Maintenance processing
2 ratemon Interface Rate Monitoring

Maintenance Exit Stage Sequence
No. Stage Description

1 ratemon Interface Rate Monitoring
2 bgp BGP Maintenance processing

switch(config)#

```

### Example

```

switch(config)#show maintenance bgp receiver route-map
route-map SystemGenerated permit 10
 Description:
 description System generated receiver route-map
 Match clauses:
 match community GSHUT-LIST
 SubRouteMap:
 Set clauses:
route-map SystemGenerated permit 50
 Description:
 description System generated receiver route-map
 Match clauses:
 SubRouteMap:
 Set clauses:
tg232(s1)(config)#show maintenance profiles interface
tg232(s1)(config)#show maintenance profiles bgp
tg232(s1)(config)#show maintenance profiles unit
tg232(s1)(config)#show maintenance profiles unit default
Unit Profile: Default
 On-boot:
 enabled: no
 duration: 300 seconds
switch(config)#

```

### Example

```

switch(config)#show maintenance profiles interface default
Interface Profile: Default
 Rate Monitoring:
 load-interval: 60 seconds
 threshold (in/out): 100 Kbps
 shutdown:
 enabled: no
 max-delay: 300 seconds

switch(config)#

```

### Example

```

switch(config)#show maintenance profiles bgp default
Bgp Profile: Default
 Initiator route-map: SystemGenerated
 route-map SystemGenerated permit 10
 Description:

```

```
description System generated initiator route-map
Match clauses:
SubRouteMap:
Set clauses:
 set local-preference 0
 set community GSHUT additive

switch(config)#
```

### Example

```
switch(config)#show maintenance profiles unit default
Unit Profile: Default
 On-boot:
 enabled: no
 duration: 300 seconds

switch(config)#
```

## 14.6.6 Syslog Messages

Maintenance mode syslog messages are as follows:

- MaintenanceMode: %MMODE-4-MAINT\_OP\_WARNING: Unit config is deleted for unit foo. The unit is still undergoing maintenance operation.
- MaintenanceMode: %MMODE-5-MAINT\_UNIT\_STATE\_CHANGE: Maintenance unit state changed for unit <Dynamic Unit><SPINE-V6><vrf-default>. Old State maintenanceModeEnter, New State underMaintenance.
- MaintenanceMode: %ETH-6-MAINTENANCE\_DOWN: Interface Et1 has been shutdown for maintenance.
- MaintenanceMode: %MMODE-5-INTF\_PROFILE\_CHANGE: For interface Et1 interface profile changed to IP1.
- Rib: %BGP-6-MAINTENANCE-MODE: peer 1.1.1.1 is placed under maintenance.
- Rib: %BGP-6-MAINTENANCE-MODE: peer 1.1.1.1 is taken out of maintenance.

## 14.6.7 Maintenance Mode Commands

### Global Configuration Commands

- `group bgp`
- `group interface`
- `maintenance`

### Group Configuration Commands

- `interface`
- `maintenance profile bgp`
- `maintenance profile interface`
- `neighbor`
- `vrf`

### Maintenance Configuration Commands

- `bgp <peer> [vrf <vrf_name>]`
- `interface`
- `profile bgp`
- `profile unit <profile_name> default`
- `profile interface`
- `profile interface <profile_name> default`
- `profile unit`
- `profile unit <profile_name> default`
- `unit`

### Unit Configuration Commands

- `group bgp <group_name>`
- `group interface <group_name>`
- `profile unit`
- `quiesce`

### Interface Profile Configuration Commands

- `rate-monitoring load-interval`
- `rate-monitoring threshold`
- `shutdown max-delay`

### BGP Profile Configuration Commands

- `initiator route-map <route-map-name> inout`

### Unit Profile Configuration Commands

- `on-boot duration`

### EventMgr Configuration Commands

- `trigger on-maintenance`

---

## Display Commands

- `show maintenance`
- `show maintenance bgp`
- `show maintenance bgp receiver route-map`
- `show maintenance debug`
- `show maintenance groups`
- `show maintenance interface`
- `show maintenance interface status`
- `show maintenance profiles`
- `show maintenance stages`
- `show maintenance summary`
- `show maintenance units`

## Enhanced Commands to show Maintenance Status

- `show interface`
- `show interface <intf_name> status`
- `show ip | ipv6 bgp`
- `show ip | ipv6 bgp summary [ vrf <vrf_name>]`

### 14.6.7.1 `bgp <peer> [vrf <vrf_name>]`

The `bgp <peer> [vrf <vrf_name>]` command places the switch in maintenance dynamic BGP unit configuration mode. If no VRF is specified, the BGP peer is considered to be in the DEFAULT VRF, otherwise, in the specified VRF.

The command creates the dynamic BGP unit if the specified dynamic BGP unit does not exist prior to issuing the command.

The `no bgp <peer> [vrf <vrf_name>]` and `default bgp <peer> [vrf <vrf_name>]` removes the dynamic BGP unit from *running-config*.

#### Command Mode

Maintenance Configuration

#### Command Syntax

```
bgp ipv4_addr [vrf <vrf_name>]
```

```
bgp ipv6_addr [vrf <vrf_name>]
```

```
bgp peer_group_name [vrf <vrf_name>]
```

```
<no | default> bgp ipv4_addr|ipv6_addr|peer_group_name [vrf <vrf_name>]
```

#### Parameters

- `ipv4_addr` BGP neighbor IPv4 address
- `ipv6_addr` BGP neighbor IPv6 address
- `peer_group_name` BGP peer group name
- `vrf_name` name of the VRF to which the BGP peer belongs

#### Commands available in maintenance dynamic interface unit configuration mode:

- `quiesce`

#### Example

- This command creates dynamic BGP unit for IPv4 addr 1.0.1.1, IPv6 addr 1::1 with `quiesce` and `peer-group PG` in VRF VRF1 under maintenance configuration.

```
switch(config)#maintenance
switch(config-maintenance)#bgp 1.0.1.1
switch(config-maint-bgp-1.0.1.1)#exit
switch(config-maintenance)#bgp 1::1
switch(config-maint-bgp-1::1)#quiesce
switch(config-maint-bgp-1::1)#exit
switch(config-maintenance)#bgp PG vrf VRF1
switch(config-maint-bgp-PG)#exit
switch(config-maint-bgp-PG)#show active
maintenance
 bgp 1.0.1.1
 !
 bgp 1::1
 quiesce
 !
 bgp PG vrf VRF1
switch(config-maintenance)#
```

---

### 14.6.7.2 `group bgp <group_name>`

The `group bgp <group_name>` command adds a BGP group to a unit.

The `no group bgp <group_name>` and `default group bgp <group_name>` removes the BGP group from a unit.

#### Command Mode

Maintenance Unit Configuration

#### Command Syntax

```
group bgp group_name
```

```
no group bgp group_name
```

```
default group bgp group_name
```

#### Parameters

- `group_name` name of the BGP group

#### Example

- This command adds a BGP group BG1 to unit UNIT1.

```
switch(config)#maintenance
switch(config-maintenance)#unit UNIT1
switch(config-unit-UNIT1)#group bgp BG1
switch(config-unit-UNIT1)#show active
maintenance
 unit UNIT1
 group bgp BG1
switch(config-unit-UNIT1)
```



### 14.6.7.3 group bgp

The `group bgp <group_name>` command places the switch in group-BGP configuration mode for configuring the members of a BGP group in a particular VRF and associating a BGP maintenance profile for these members.

The command creates the group if the specified group does not exist prior to issuing the command.

The `no group bgp <group_name>` and `default group bgp <group_name>` removes the BGP group.

#### Command Mode

Global Configuration

#### Command Syntax

```
group bgp group_name
```

```
no group bgp group_name
```

```
default group bgp group_name
```

#### Parameters

- `group_name` name of the BGP group

#### Commands available in group-BGP configuration mode:

- `neighbor (ipv4 address | ipv6 address | peer-group)`
- `vrf (vrf-name)`
- `maintenance profile bgp`



**Note:** Built-in BGP groups like AllBgpNeighborVrf-default and AllBgpNeighborVrf-<vrf\_name> do not allow neighbor configuration. Only BGP maintenance profile can be associated to them.

#### Example

- This command creates a BGP group BG1 and enters into group BGP BG1 configuration mode.

```
switch(config)#group bgp BG1
switch(config-group-bgp-BG1)#show active
group bgp BG1
exit
switch(config-group-bgp-BG1)#
```

- This command enters into BGP built-in configuration mode for AllBgpNeighborVrf-default.

```
switch(config)#group bgp AllBgpNeighborVrf-default
switch(config-builtin-group-bgp-AllBgpNeighborVrf-default)#show active
group bgp AllBgpNeighborVrf-default
exit
switch(config-builtin-group-bgp-AllBgpNeighborVrf-default)#exit
switch(config)#show maintenance groups bgp AllBgpNeighborVrf-default
BGP Group: AllBgpNeighborVrf-default
Origin: Built-in
Neighbors:
Ipv4 Peers: 1.0.0.1, 1.0.1.2
Bgp Profile: Default
Vrf: default
Units: System
switch(config)#
```

---

#### 14.6.7.4 `group interface <group_name>`

The `group interface <group_name>` command adds an interface to a unit.

The `no group interface <group_name>` and `default group interface <group_name>` removes the interface group from a unit.

##### Command Mode

Maintenance Unit Configuration

##### Command Syntax

```
group interface group_name
```

```
no group interface group_name
```

```
default group interface group_name
```

##### Parameters

- `group_name` name of the interface group

##### Example

- This command adds an interface group IG1 to unit UNIT1.

```
switch(config)#maintenance
switch(config-maintenance)#unit UNIT1
switch(config-unit-UNIT1)#group interface IG1
switch(config-unit-UNIT1)# show active
maintenance
 unit UNIT1
 group interface IG1
switch(config-unit-UNIT1)
```

### 14.6.7.5 group interface

The **group interface** command places the switch in group-intf configuration mode for configuring the members of interface group and associating a BGP/interface maintenance profile for these members.

The command creates the group if the specified group does not exist prior to issuing the command.

The **no group interface <group\_name>** and **default group interface <group\_name>** removes the interface group.

#### Command Mode

Global Configuration

#### Command Syntax

```
group interface group_name
```

```
no group interface group_name
```

```
default group interface group_name
```

#### Parameters

- *group\_name* name of the interface group

#### Commands available in group-BGP configuration mode:

- **interface**
- **maintenance profile bgp**
- **maintenance profile interface**



**Note:** Built-in Interface groups like **AllEthernetInterface**, **Linecard3**, **Linecard4**, etc. do not allow interface configurations. Only BGP/interface maintenance profiles can be associated to them.

#### Example

- This command creates an interface group IG1 and enters into group interface IG1 configuration mode.

```
switch(config)#group interface IG1
switch(config-group-if-IG1)#show active
group interface IG1
exit
switch(config-group-if-IG1)#
```

- This command enters into built-in interface group AllEthernetInterface.

```
switch(config)#group interface AllEthernetIntetrface
switch(config-builtin-group-if-AllEthernetInterface)#show active
group interface AllEthernetInterface
exit
switch(config-builtin-group-if-AllEthernetInterface)#exit
switch(config)# show maintenance groups interface AllEthernetInterface
Interface Group: AllEthernetInterface
Origin: Built-in
Interfaces:
Et1, Et2, Et3, Et4, Et5/1, Et34, Et35, Et36
Profiles:
Interface Profile: Default
Bgp Profile: Default
Units: System#
```

---

### 14.6.7.6 initiator route-map <route-map-name> inout

The `initiator route-map <route-map-name> inout` command is a maintenance BGP profile configuration option for assigning the initiator route-map, which will be applied to inout (inbound and outbound).

The `no initiator route-map <route-map-name> inout` and `default initiator route-map <route-map-name> inout` removes this configuration from the BGP profile.

#### Command Mode

Maintenance-Profile-BGP Configuration

#### Command Syntax

```
initiator route-map route-map-name inout
```

```
no initiator route-map
```

```
default initiator route-map
```

#### Parameters

- *route-map-name* initiator route-map name

#### Example

- This command configures initiator route-map **RM1** within a BGP profile **BP1**.

```
switch(config)#maintenance
switch(config-maintenance)#profile bgp BP1
switch(config-profile-bgp-BP1)#initiator route-map RM1 inout
switch(config-profile-bgp-BP1)#show active
maintenance
 profile bgp BP1
 initiator route-map RM1 inout

switch(config-profile-bgp-BP1)#
```

### 14.6.7.7 interface intf-name

The **interface** <intf-name> command places the switch in maintenance dynamic interface unit configuration mode.

The command creates the dynamic interface unit if the specified dynamic interface unit does not exist prior to issuing the command.

The **no interface** <intf-name> and **default interface** <intf-name> removes the dynamic interface unit from *running-config*.

#### Command Mode

Maintenance Configuration

#### Command Syntax

**interface** *interface-name*

**no interface** *interface-name*

**default interface** *interface-name*

#### Parameters

- *interface-name* name of the interface
- ethernet *e\_range* Ethernet interfaces specified by *e\_range*
- port-channel *p\_range* port channel interfaces specified by *p\_range*
- vlan *v\_range* vlans specified by *v\_range*.

Valid *e\_range*, *p\_range* and *v\_range* formats include number, range, or comma-delimited list of numbers and ranges.

 **Note:** Different dynamic interface units are created for each interface in the range.

#### Commands available in maintenance dynamic interface unit configuration mode:

- quiesce

#### Example

- This command creates two dynamic interface units for interfaces Ethernet1-2 under maintenance configuration.

```
switch(config)#maintenance
switch(config-maintenance)#interface Ethernet1-2
switch(config-maint-if-Et1-2)#exit
switch(config-maintenance)#show active
maintenance
 interface Ethernet1
 !
 interface Ethernet2
switch(config-maintenance)#
```

---

### 14.6.7.8 interface

The **interface** command adds interfaces to interface group.

The **interface** <intf-name> and **default interface** <intf-name> removes the interface from the group.

#### Command Mode

Group-Interface Configuration

#### Command Syntax

**interface** *interface-name*

**no interface** *interface-name*

**default interface** *interface-name*

#### Parameters

- *interface-name* name of the interface
- ethernet *e\_range* Ethernet interfaces specified by *e\_range*
- port-channel *p\_range* port channel interfaces specified by *p\_range*
- vlan *v\_range* vlans specified by *v\_range*.

Valid *e\_range*, *p\_range* and *v\_range* formats include number, range, or comma-delimited list of numbers and ranges. Valid Ethernet numbers depend on the Ethernet interfaces available on the switch.

#### Example

- This command adds Ethernet8, Ethernet9, and port-channel10 to the interface group IG1.

```
switch(config)#group interface IG1
switch(config-group-if-IG1)#interface Ethernet8-9
switch(config-group-if-IG1)#interface port-channel10
switch(config-group-if-IG1)#show active
group interface IG1
interface Et8-9
interface Po10
switch(config-group-if-IG1)#exit
switch(config)#
```

### 14.6.7.9 maintenance profile bgp

The **maintenance profile bgp <profile-name>** command associates a BGP maintenance profile to an interface/BGP group. A BGP profile can be associated to both the interface and BGP group.

The **no maintenance profile bgp <profile-name>** and **default maintenance profile bgp <profile-name>** removes the profile from the interface/BGP group.

#### Command Mode

Group-Interface Configuration

Group-BGP Configuration

Built-in-Group-Interface Configuration

Built-in-Group-BGP Configuration

#### Command Syntax

```
maintenance profile bgp profile-name
```

```
no maintenance profile bgp profile-name
```

```
default maintenance profile bgp profile-name
```

#### Parameters

- *profile name* name of the BGP profile

#### Example

- This command adds BGP profile BP1 to a BGP group BG1.

```
switch(config)#group bgp BG1
switch(config-group-bgp-BG1)#neighbor 1.0.1.1
switch(config-group-bgp-BG1)#neighbor 1::1
switch(config-group-bgp-BG1)#neighbor PG
switch(config-group-bgp-BG1)#maintenance profile bgp BP1
switch(config-group-bgp-BG1)#show active
group bgp BG1
 neighbor 1.0.1.1
 neighbor 1::1
 neighbor PG
 maintenance profile bgp BP1
switch(config-group-bgp-BG1)#exit
switch(config)#
```

- This command adds BGP profile BP1 to interface group IG1.

```
switch(config)#group interface IG1
switch(config-group-if-IG1)#interface Ethernet8-9
switch(config-group-if-IG1)#maintenance profile bgp BP1
switch(config-group-if-IG1)#show active
group interface IG1
 interface Et8-9
 maintenance profile bgp BP1
switch(config-group-if-IG1)#exit
switch(config)#
```

- This command adds BGP profile BP1 to built-in interface group AllEthernetInterface.

```
switch(config)#group interface AllEthernetInterface
switch(config-builtin-group-if-AllEtherentInterface)#maintenance
profile bgp BP1
switch(config-builtin-group-if-AllEtherentInterface)#show active
```

---

```
group interface AllEthernetInterface
 maintenance profile bgp BP1

switch(config-builtin-group-if-AllEtherentInterface) #
```



### 14.6.7.10 maintenance profile interface

The **maintenance profile interface** <profile-name> command associates interface profile to interface group.

The **no maintenance profile interface** <profile-name> and **default maintenance profile interface** <profile-name> removes the interface profile from interface group.

#### Command Mode

Group-Interface Configuration

Built-in-Group-Interface Configuration

#### Command Syntax

```
maintenance profile interface profile-name
```

```
no maintenance profile interface profile-name
```

```
default maintenance profile interface profile-name
```

#### Parameters

- *profile-name* name of the interface profile

#### Example

- This command adds interface profile IP1 to interface group IG1.

```
switch(config)#group interface IG1
switch(config-group-if-IG1)#interface Ethernet8-9
switch(config-group-if-IG1)#maintenance profile interface IP1
switch(config-group-if-IG1)#show active
group interface IG1
 interface Et8-9
 maintenance profile interface IP1

switch(config-group-if-IG1)#
```

- This command adds interface profile IP1 to built-in interface group AllEthernetInterface.

```
switch(config)#group interface AllEthernetInterface
switch(config-builtin-group-if-AllEtherentInterface)#maintenance
profile
interface IP1
switch(config-builtin-group-if-AllEtherentInterface)#show active
group interface AllEthernetInterface
 maintenance profile interface IP1

switch(config-builtin-group-if-AllEtherentInterface)#
```

---

### 14.6.7.11 maintenance

The **maintenance** command allows you to enter maintenance configuration mode and specify maintenance configuration options.

The **no maintenance** and **default maintenance** command removes the maintenance configuration from the *running-config*.

#### Command Mode

Global Configuration

#### Command Syntax

**maintenance**

**no maintenance**

**default maintenance**

#### Commands available in maintenance configuration mode:

- **unit**
- **bgp**
- **interface**
- **profile bgp**
- **profile interface**
- **profile unit**
- **profile interface <profile-name> default**
- **profile bgp <profile-name> default**
- **profile unit <profile-name> default**

#### Examples

- This example shows the commands to enter maintenance configuration mode and configure maintenance related parameters.

```
switch(config)#maintenance
switch(config-maintenance)#profile unit foo
switch(config-profile-unit-foo)#on-boot duration 300
switch(config-profile-unit-foo)#exit
switch(config-maintenance)#unit U1
switch(config-unit-U1)#group interface IG1
switch(config-unit-U1)#group bgp BG1
switch(config-unit-U1)#profile unit foo
switch(config-unit-U1)#exit
switch(config-maintenance)#show active
maintenance
 profile unit foo
 on-boot duration 300
 unit U1
 group interface IG1
 group bgp BG1
 profile unit foo
switch(config-maintenance)#
```

### 14.6.7.12 neighbor

The **neighbor** command adds BGP peer(s) to a BGP group. The neighbors can be IPv4, IPv6 or a peer group. The **no neighbor <peer>** and **default neighbor <peer>** removes the BGP peer from the group.

#### Command Mode

Group-BGP Configuration

#### Command Syntax

**neighbor** *ipv4\_addr*

**no neighbor** *ipv4\_addr*

**default neighbor** *ipv4\_addr*

**neighbor** *ipv6\_addr*

**no neighbor** *ipv6\_addr*

**default neighbor** *ipv6\_addr*

**neighbor** *peer group name*

**no neighbor** *peer group name*

**default neighbor** *peer group name*

#### Parameters

- *ipv4\_addr* BGP neighbor ipv4 address
- *ipv6\_addr* BGP neighbor ipv6 address
- *peer group name* BGP peer group name

#### Example

- This command adds ipv4 peer 1.0.1.1, ipv6 peer 1::1 and peer group PG to the BGP group BG1.

```
switch(config)#group bgp BG1
switch(config-group-bgp-BG1)#neighbor 1.0.1.1
switch(config-group-bgp-BG1)#neighbor 1::1
switch(config-group-bgp-BG1)#neighbor PG
switch(config-group-bgp-BG1)#group bgp BG1
switch(config-group-bgp-BG1)#neighbor 1.0.1.1
switch(config-group-bgp-BG1)#neighbor 1::1
switch(config-group-bgp-BG1)#neighbor PG
switch(config-group-bgp-BG1)#exit
switch(config)#
```

---

### 14.6.7.13 on-boot duration

The **on-boot duration** command is a maintenance unit profile configuration option for specifying the duration after which the associated unit will be brought out of maintenance after reboot. The on-boot property in the maintenance unit profile specifies that the unit will be placed into maintenance mode as part of boot-up, and remain so for the specified duration.

The **no on-boot** and **default on-boot** removes this configuration from the unit profile.

#### Command Mode

Maintenance-Profile-Unit Configuration

#### Command Syntax

**on-boot duration** *duration*

**no on-boot**

**default on-boot**

#### Parameters

- *duration* number of seconds for which unit will remain under maintenance after reboot (from 300 to 3600 seconds)

#### Example

- This command configures on-boot duration of 1000 seconds in profile unit UP1.

```
switch(config)#maintenance
switch(config-maintenance)#profile unit UP1
switch(config-profile-unit-UP1)#on-boot duration 1000
switch(config-profile-unit-UP1)#show active
maintenance
 profile unit UP1
 on-boot duration 1000

switch(config-profile-unit-UP1)#
```

### 14.6.7.14 profile bgp <profile\_name> default

The `profile bgp <profile_name> default` command configures a user-configured BGP profile as default BGP profile.

The `no profile bgp <profile_name> default` and `default profile bgp <profile_name> default` removes the user-configured BGP profile as default BGP profile.

#### Command Mode

Maintenance Configuration

#### Command Syntax

```
profile bgp profile_name default
```

```
no profile bgp profile_name default
```

```
default profile bgp profile_name default
```

#### Parameters

- *profile\_name* name of the BGP profile

#### Example

- This command configures user configured BGP profile BP1 as default BGP profile.

```
switch(config)#maintenance
switch(config-maintenance)#profile bgp BP1
switch(config-profile-bgp-BP1)#initiator route-map RM1 inout
switch(config-profile-bgp-BP1)#exit
switch(config-maintenance)#
switch(config-maintenance)#show maintenance profile bgp default
Bgp Profile: Default
 Initiator route-map: SystemGenerated
 route-map SystemGenerated permit 10
 Description:
 description System generated initiator route-map
 Match clauses:
 Set clauses:
 set community GSHUT additive
 set local-preference 0

switch(config-maintenance)#
switch(config-maintenance)#profile bgp BP1 default
switch(config-maintenance)#show maintenance profile bgp default
Bgp Profile: BP1
 Initiator route-map: RM1
switch(config-maintenance)#
switch(config-maintenance)#show active
maintenance
 profile bgp BP1
 initiator route-map RM1 inout
 profile bgp BP1 default

switch(config-maintenance)#
```

---

### 14.6.7.15 profile bgp

The **profile bgp** command places the switch in maintenance profile BGP configuration mode for configuring initiator route-map.

The command creates the profile if the specified BGP profile does not exist prior to issuing the command.

The **no profile bgp <profile-name>** and **default profile bgp <profile-name>** removes the profile from *running-config*.

#### Command Mode

Maintenance Configuration

#### Command Syntax

```
profile bgp profile-name
```

```
no profile bgp profile-name
```

```
default profile bgp profile-name
```

#### Parameters

- *profile-name* name of the BGP profile

#### Commands available in maintenance profile BGP configuration mode:

- **initiator route-map (route-map name) inout**

#### Example

- This command creates BGP profile BP1.

```
switch(config)#maintenance
switch(config-maintenance)#profile bgp BP1
switch(config-profile-bgp-BP1)#show active
maintenance
 profile bgp BP1

switch(config-profile-bgp-BP1)#
```

### 14.6.7.16 profile interface <profile\_name> default

The **profile interface <profile\_name> default** command configures a user-configured interface profile as default interface profile.

The **no profile interface <profile\_name> default** and **default profile interface <profile\_name> default** removes the user-configured interface profile as default interface profile.

#### Command Mode

Maintenance Configuration

#### Command Syntax

```
profile interface profile_name default
no profile interface profile_name default
default profile interface profile_name default
```

#### Parameters

- *profile\_name* name of the interface profile

#### Example

- This command configures user configured interface profile IP1 as default interface profile.

```
switch(config)#maintenance
switch(config-maintenance)#profile interface IP1
switch(config-profile-intf-IP1)#rate-monitoring load-interval 100
switch(config-profile-intf-IP1)#rate-monitoring threshold 500
switch(config-profile-intf-IP1)#shutdown max-delay 100
switch(config-profile-intf-IP1)#exit
switch(config-maintenance)#
switch(config-maintenance)#show maintenance profile interface default
Interface Profile: Default
 Rate Monitoring:
 load-interval: 60 seconds
 threshold (in/out): 100 kbps
 shutdown:
 enabled: no
 max-delay: 300 seconds

switch(config-maintenance)#
switch(config-maintenance)#profile interface IP1 default
switch(config-maintenance)#show maintenance profile interface default
Interface Profile: IP1
 Rate Monitoring:
 load-interval: 100 seconds
 threshold (in/out): 500 kbps
 shutdown:
 enabled: yes
 max-delay: 100 seconds
switch(config-maintenance)#
switch(config-maintenance)#show active
maintenance
 profile interface IP1 default
 profile interface IP1
 rate-monitoring load-interval 100
 rate-monitoring threshold 500
 shutdown max-delay 100

switch(config-maintenance)#
```

---

### 14.6.7.17 profile interface

The **profile interface** command places the switch in maintenance profile interface configuration mode for configuring rate-monitoring threshold, load-interval, and shutdown max-delay.

The command creates the profile if the specified interface profile does not exist prior to issuing the command.

The **no profile interface <profile-name>** and **default profile interface <profile-name>** removes the profile from *running-config*.

#### Command Mode

Maintenance Configuration

#### Command Syntax

```
profile interface profile-name
```

```
no profile interface profile-name
```

```
default profile interface profile-name
```

#### Parameters

- *profile-name* name of the interface profile

#### Commands available in maintenance profile interface configuration mode:

- **rate-monitoring load-interval**
- **rate-monitoring threshold**
- **shutdown max-delay**

#### Example

- This command creates interface profile IP1.

```
switch(config)#maintenance
switch(config-maintenance)#profile interface IP1
switch(config-profile-intf-IP1)#show active
maintenance
 profile interface IP1

switch(config-profile-intf-IP1)#
```



### 14.6.7.18 profile unit <profile\_name> default

The **profile unit <profile\_name> default** command configures a user-configured unit profile as default unit profile.

The **no profile unit <profile\_name> default** and **default profile unit <profile\_name> default** removes the user-configured unit profile as default unit profile.

#### Command Mode

Maintenance Configuration

#### Command Syntax

```
profile unit profile_name default
```

```
no profile unit profile_name default
```

```
default profile unit profile_name default
```

#### Parameters

- *profile\_name* name of the interface profile

#### Example

- This command configures user-configured unit profile UP1 as the default unit profile.

```
switch(config)#maintenance
switch(config-maintenance)#profile unit UP1
switch(config-profile-unit-UP1)#on-boot duration 1000
switch(config-profile-unit-UP1)#exit
switch(config-maintenance)#
switch(config-maintenance)#show maintenance profiles unit default
Unit Profile: Default
 On-boot:
 enabled: no
 duration: 300 seconds

switch(config-maintenance)#profile unit UP1 default
switch(config-maintenance)#show maintenance profile unit default
Unit Profile: UP1
 On-boot:
 enabled: yes
 duration: 1000 seconds
switch(config-maintenance)#
switch(config-maintenance)#show active
maintenance
 profile unit UP1 default
 profile unit UP1
 on-boot duration 1000

switch(config-maintenance)#
```

### 14.6.7.19 profile unit <profile\_name>

The **profile unit <profile\_name>** command associates unit profile to a particular unit.

The **no profile unit <profile\_name>** and **default profile unit <profile\_name>** removes the unit profile from a unit.

#### Command Mode

Maintenance-Unit Configuration

Maintenance-Built-in-Unit Configuration

#### Command Syntax

```
profile unit profile-name
```

```
no profile unit profile-name
```

```
default profile unit profile-name
```

#### Parameters

- *profile-name* name of the unit profile

#### Examples

- This command adds unit profile UP1 to UNIT1.

```
switch(config)#maintenance
switch(config-maintenance)#unit UNIT1
switch(config-unit-UNIT1)#group interface IG1
switch(config-unit-UNIT1)#exit
switch(config-maintenance)#show maintenance units UNIT1
Unit Name: UNIT1
 Origin: User Configured
 Status: Not Under Maintenance
 Unit Profile: Default
 Time Since Last State Change: never
 Interface Groups:
 IG1

switch(config-maintenance)#unit UNIT1
switch(config-unit-UNIT1)#profile unit UP1
switch(config-unit-UNIT1)#show maintenance units UNIT1
Unit Name: UNIT1
 Origin: User Configured
 Status: Not Under Maintenance
 Unit Profile: UP1
 Time Since Last State Change: never
 Interface Groups:
 IG1
switch(config-unit-UNIT1)#show active
maintenance
 unit UNIT1
 group interface IG1
 profile unit UP1

switch(config-unit-UNIT1)#
```

- This command adds unit profile UP2 to built-in unit System.

```
switch(config)#maintenance
switch(config-maintenance)#profile unit UP2
switch(config-profile-unit-UP2)#on-boot duration 600
switch(config-profile-unit-UP2)#exit
switch(config-maintenance)#
switch(config-maintenance)#unit System
switch(config-builtin-unit-System)#show active
maintenance
 unit System
switch(config-builtin-unit-System)#exit
switch(config-maintenance)#show maintenance units System
Unit Name: System
 Origin: Built-in
 Status: Not Under Maintenance
```

```
Unit Profile: Default
Time Since Last State Change: never
Interface Groups:
 AllEthernetInterface

switch(config-maintenance)#
switch(config-maintenance)#unit System
switch(config-builtin-unit-System)#profile unit UP2
switch(config-builtin-unit-System)#show active
maintenance
 unit System
 profile unit UP2
switch(config-builtin-unit-System)#exit
switch(config-maintenance)#show maintenance units System
Unit Name: System
Origin: Built-in
Status: Not Under Maintenance
Unit Profile: UP2
Time Since Last State Change: never
Interface Groups:
 AllEthernetInterface

switch(config-maintenance)#
```

---

### 14.6.7.20 profile unit

The **profile unit** command places the switch in maintenance profile unit configuration mode for configuring on-boot duration.

The command creates the profile if the specified BGP profile does not exist prior to issuing the command.

The **no profile unit <profile-name>** and **default profile unit <profile-name>** removes the profile from *running-config*.

#### Command Mode

Maintenance Configuration

#### Command Syntax

```
profile unit profile-name
```

```
no profile unit profile-name
```

```
default profile unit profile-name
```

#### Parameters

- *profile-name* name of the unit profile

#### Commands available in maintenance profile unit configuration mode:

- **on-boot duration**

#### Example

- This command creates unit profile UP1.

```
switch(config)#maintenance
switch(config-maintenance)#profile unit UP1
switch(config-profile-unit-UP1)#show active
maintenance
 profile unit UP1

switch(config-profile-unit-UP1)#
```

### 14.6.7.21 quiesce

The **quiesce** command places a unit or dynamic interface/BGP unit into maintenance mode, gracefully transitioning traffic away from it.

The **no quiesce** and **default quiesce** exits the unit from maintenance.

#### Command Mode

Maintenance-Unit Configuration

Maintenance-Built-in-Unit Configuration

Maintenance Dynamic-Interface Unit Configuration

Maintenance Dynamic-Bgp Unit Configuration

#### Command Syntax

**quiesce**

**no quiesce**

**default quiesce**

#### Examples

- This command places unit UNIT1, interface Et1, BGP peer 1.0.1.1 in VRF default, BGP peer 1::1 in VRF VRF1 into maintenance.

```
switch(config)#group interface IG1
switch(config-group-if-IG1)#interface Ethernet3-6
switch(config-group-if-IG1)#maintenance profile interface IP1
switch(config-group-if-IG1)#exit
switch(config)#maintenance
switch(config-maintenance)#unit UNIT1
switch(config-unit-UNIT1)#group interface IG1
switch(config-unit-UNIT1)#quiesce
switch(config-unit-UNIT1)#exit
switch(config-maintenance)#interface Ethernet1
switch(config-maint-if-Et1)#quiesce
switch(config-maint-if-Et1)#exit
switch(config-maintenance)#bgp 1.0.1.1
switch(config-maint-bgp-1.0.1.1)#quiesce
switch(config-maint-bgp-1.0.1.1)#exit
switch(config-maintenance)#bgp 1::1 vrf VRF1
switch(config-maint-bgp-1::1)#quiesce
switch(config-maint-bgp-1::1)#exit
switch(config-maintenance)#show active
maintenance
 bgp 1.0.1.1
 quiesce
 !
 bgp 1::1 vrf VRF1
 quiesce
 interface Et1
 quiesce
 unit UNIT1
 quiesce

switch(config-maintenance)#show maintenance
Flags:
o - On-boot maintenance
v - Violating traffic threshold

Unit Name Status Time since last change Flags

System
UNIT1 Under Maintenance 0:00:06 ago
Interface Name Status Time since last change Flags

Ethernet1 Entering Maintenance 0:00:06 ago
Bgp Neighbor(vrf: defa Status Time since last change Flags

1.0.1.1 Under Maintenance 0:00:06 ago
Bgp Neighbor(vrf: VRF1 Status Time since last change Flags

1::1 Under Maintenance 0:00:06 ago
switch(config-maintenance)#
```

---

### 14.6.7.22 rate-monitoring load-interval

The **rate-monitoring load-interval** command is a maintenance interface profile configuration option for configuring the interfaces rate monitoring load interval with a load interval value between 5 and 600 seconds.

#### Command Mode

Maintenance-Profile-Interface Configuration

#### Command Syntax

```
rate-monitoring load-interval load_interval
```

```
no rate-monitoring load-interval load_interval
```

```
default rate-monitoring load-interval load_interval
```

#### Parameters

- *load\_interval* load interval value between 5 and 600 seconds

#### Example

- This command configures the rate monitoring load interval for the profile interface IP1 to a load interval of 10 seconds.

```
switch(config)#maintenance
switch(config-maintenance)#profile interface IP1
switch(config-profile-intf-IP1)#rate-monitoring load-interval 10
switch(config-profile-intf-IP1)#show active
maintenance
 profile interface IP1
 rate-monitoring load-interval 10

switch(config-profile-intf-IP1)#
```

### 14.6.7.23 rate-monitoring threshold

The **rate-monitoring threshold** command is a maintenance interface profile configuration option for configuring the interfaces rate monitoring threshold with a threshold value between 1 and 4294967295 kilobytes.

The **no rate-monitoring threshold** and **default rate-monitoring threshold** removes this configuration from the interface profile.

#### Command Mode

Maintenance-Profile-Interface Configuration

#### Command Syntax

```
rate-monitoring threshold threshold_in_kbps
```

```
no rate-monitoring threshold threshold_in_kbps
```

```
default rate-monitoring threshold threshold_in_kbps
```

#### Parameters

- *threshold\_in\_kbps* threshold in kilobytes per second (kbps) between 1 and 4294967295 kilobytes

#### Example

- This command configures the rate monitoring threshold for the profile interface IP1 to a threshold of 1000 kilobytes per second (kbps).

```
switch(config)#maintenance
switch(config-maintenance)#profile interface IP1
switch(config-profile-intf-IP1)#rate-monitoring threshold 1000
switch(config-profile-intf-IP1)# show active
maintenance
 profile interface IP1
 rate-monitoring threshold 1000

switch(config-profile-intf-IP1)#
```

---

#### 14.6.7.24 show interface <intf\_name> status

The **show interface <intf\_name> status** command displays an m flag if the interface is undergoing maintenance operation.

##### Command Mode

EXEC

##### Command Syntax

```
show interface [intf_name] status
```

##### Parameters

- *intf\_name* name of the interface
  - ethernet *e\_range* Ethernet interfaces specified by *e\_range*
  - port-channel *p\_range* port channel interfaces specified by *p\_range*
  - vlan *v\_range* vlans specified by *v\_range*



##### Note:

Valid *e\_range*, *p\_range* and *v\_range* formats include number, range, or comma-delimited list of numbers and ranges. Valid Ethernet numbers depend on the Ethernet interfaces available on the switch.

##### Example

- This command display tabular output and shows 'm' flag for Ethernet16/1 status.

```
switch#show interface Ethernet16/1 status
Port Name Status Vlan Duplex Speed Type Flags
Et1 disabled 1 auto auto 1000BASE-T
...
Et14/1 connected 2 full 40G 40GBASE-CR4
Et15/1 connected 2 full 40G 40GBASE-CR4
Et16/1 connected routed full 40G 40GBASE-CR4 m
Et17/1 notconnect 1 full 10G Not Present
...
switch#
```



### 14.6.7.25 show interface

The **show interface** command displays detailed information about the interface. It displays an extra line that reads: Under maintenance for time in hours and minutes.

#### Command Mode

EXEC

#### Command Syntax

```
show interface intf_name
```

#### Parameters

- *intf\_name* name of the interface
  - ethernet *e\_range* Ethernet interfaces specified by *e\_range*
  - port-channel *p\_range* port channel interfaces specified by *p\_range*
  - vlan *v\_range* vlans specified by *v\_range*



#### Note:

Valid *e\_range*, *p\_range* and *v\_range* formats include number, range, or comma-delimited list of numbers and ranges. Valid Ethernet numbers depend on the Ethernet interfaces available on the switch.

#### Example

- This command displays detailed information about Ethernet 16/1 interface.

```
switch#show interface ethernet 16/1
Ethernet16/1 is up, line protocol is up (connected)
 Hardware is Ethernet, address is 001c.7373.efc7
 Internet address is 1.0.1.1/24
 Broadcast address is 255.255.255.255
 Address determined by manual configuration
 IP MTU 1500 bytes, BW 40000000 kbit
 Full-duplex, 40Gb/s, auto negotiation: off, uni-link: n/a
 Up 4 hours, 44 minutes, 36 seconds
 Under maintenance for 4 hours, 22 minutes, 26 seconds
 Loopback Mode : None
 2 link status changes since last clear
 Last clearing of "show interface" counters 4:45:12 ago
 5 minutes input rate 20 bps (0.0% with framing overhead), 0 packets/sec
 5 minutes output rate 20 bps (0.0% with framing overhead), 0 packets/sec
 580 packets input, 46286 bytes
 Received 1 broadcasts, 0 multicast
 0 runts, 0 giants
 0 input errors, 0 CRC, 0 alignment, 0 symbol, 0 input discards
 0 PAUSE input
 601 packets output, 48954 bytes
 Sent 7 broadcasts, 15 multicast
 0 output errors, 0 collisions
 0 late collision, 0 deferred, 0 output discards
 0 PAUSE output
switch#
```

---

### 14.6.7.26 show ip | ipv6 bgp summary [ vrf <vrf\_name>]

The **show ip | ipv6 bgp summary [ vrf <vrf\_name>]** command displays the m flag if the BGP IPv4 or IPv6 peer is undergoing maintenance operation.

#### Command Mode

EXEC

#### Command Syntax

```
show ip bgp summary [vrf <vrf_name>]
```

```
show ipv6 bgp summary [vrf <vrf_name>]
```

#### Parameters

- *vrf\_name* name of the VRF

#### Example

- This command displays the 'm' flag in **show ip bgp summary** output for peer 1.0.1.2 which is in maintenance mode.

```
switch#show ip bgp summary
BGP summary information for VRF default
Router identifier 0.0.1.1, local AS number 200
Neighbor Status Codes: m - Under maintenance
Neighbor V AS MsgRcvd MsgSent InQ OutQ Up/Down State PfxRcd
PfxAcc
 1.0.0.1 4 100 292 296 0 0 04:47:44 Estab 1 1
m 1.0.1.2 4 300 292 296 0 0 04:47:44 Estab 1 1
switch#
```

### 14.6.7.27 show ip | ipv6 bgp

The `show ip | ipv6 bgp` command displays maintenance related information when relevant.

#### Command Mode

EXEC

#### Command Syntax

```
show ip bgp neighbors <peer_addr> [vrf <vrf_name>]
```

```
show ipv6 bgp peers <peer_addr> [vrf <vrf_name>]
```

#### Parameters

- *peer\_addr* name of the peer
  - *ipv4\_addr* BGP neighbor IPv4 address
  - *ipv6\_addr* BGP neighbor IPv6 address
  - *peer-group-name* BGP peer group name
- *vrf\_name* name of the VRF

#### Example

- This command displays the m flag in `show ip bgp summary` output for peer 1.0.1.2 which is in maintenance mode.

```
switch#show ip bgp neighbors 1.0.1.2
BGP neighbor is 1.0.1.2, remote AS 300, external link
 BGP version 4, remote router ID 0.0.2.1, VRF default
 Negotiated BGP version 4
 Last read 00:00:09, last write 00:00:11
 Hold time is 180, keepalive interval is 60 seconds
 Configured hold time is 180, keepalive interval is 60 seconds
 Connect timer is inactive
 Idle-restart timer is inactive
 Session is under maintenance
 BGP state is Established, up for 04:55:11
 Number of transitions to established: 1
 Last state was OpenConfirm
 Last event was RecvKeepAlive
 Neighbor Capabilities:
 Multiprotocol IPv4 Unicast: advertised and received and negotiated
 Four Octet ASN: advertised and received
 Route Refresh: advertised and received and negotiated
 Send End-of-RIB messages: advertised and received and negotiated
 Additional-paths Receive:
 IPv4 Unicast: advertised and received
 Restart timer is inactive
 End of rib timer is inactive
 Message statistics:
 InQ depth is 0
 OutQ depth is 0

 Sent Rcvd
 Opens: 1 1
 Notifications: 0 0
 Updates: 6 2
 Keepalives: 297 297
 Route-Refresh: 0 0
 Total messages: 304 300
 Prefix statistics:
 Sent Rcvd
 IPv4 Unicast: 2 1
 IPv6 Unicast: 0 0
 Inbound updates dropped by reason:
 AS path loop detection: 0
 Enforced First AS: 0
 Malformed MPBGP routes: 0
 Originator ID matches local router ID: 0
 Nexthop matches local IP address: 0
 Unexpected IPv6 nexthop for IPv4 routes: 0
 Nexthop invalid for single hop eBGP: 0
 Inbound paths dropped by reason:
 IPv4 labeled-unicast NLRI's dropped due to excessive labels: 0
 Outbound paths dropped by reason:
 IPv4 local address not available: 0
 IPv6 local address not available: 0
 Maintenance-mode:
 Inbound and Outbound policy
 Route map is SystemGenerated
 Local AS is 200, local router ID 0.0.1.1
```

---

```
TTL is 1
Local TCP address is 1.0.1.1, local port is 179
Remote TCP address is 1.0.1.2, remote port is 51936
Auto-Local-Addr is disabled
TCP Socket Information:
 TCP state is ESTABLISHED
 Recv-Q: 0/32768
 Send-Q: 0/32768
 Outgoing Maximum Segment Size (MSS): 1448
 Total Number of TCP retransmissions: 0
 Options:
 Timestamps enabled: yes
 Selective Acknowledgments enabled: yes
 Window Scale enabled: yes
 Explicit Congestion Notification (ECN) enabled: no
 Socket Statistics:
 Window Scale (wscale): 9,7
 Retransmission Timeout (rto): 204.0ms
 Round-trip Time (rtt/rtvar): 7.5ms/3.0ms
 Delayed Ack Timeout (ato): 40.0ms
 Congestion Window (cwnd): 10
 TCP Throughput: 15.45 Mbps
 Advertised Recv Window (rcv_space): 14480
switch#
```

### 14.6.7.28 show maintenance bgp receiver route-map

The **show maintenance bgp receiver route-map** command displays receiver route-map which is applied during maintenance operation.

#### Command Mode

EXEC

#### Command Syntax

```
show maintenance bgp receiver route-map
```

#### Example

- This command displays receiver route-map contents.

```
switch#show maintenance bgp receiver route-map
route-map SystemGenerated permit 10
 Description:
 description System generated receiver route-map
 Match clauses:
 match community GSHUT-LIST
 SubRouteMap:
 Set clauses:
route-map SystemGenerated permit 50
 Description:
 description System generated receiver route-map
 Match clauses:
 SubRouteMap:
 Set clauses:switch#
```

---

### 14.6.7.29 show maintenance bgp

The **show maintenance bgp** command displays detailed maintenance information about BGP peers.

#### Command Mode

EXEC

#### Command Syntax

```
show maintenance bgp <ipv4_addr> [vrf <vrf_name>] | <ipv6_addr> [vrf <vrf_name>] |
<peer_group> [vrf <vrf_name>] | ip all [vrf <vrf_name> | vrf all] | ipv6 all [vrf <vrf_name> |
vrf all]
```

#### Parameters

- *ipv4\_addr* BGP neighbor ipv4 address
- *ipv6\_addr* BGP neighbor ipv6 address
- *peer\_group* BGP peer group name
- *vrf\_name* name of the VRF to which peer belongs
- **ip all vrf vrf\_name** all ipv4 peers in specified VRF
- **ipv6 all vrf vrf\_name** all ipv6 peers in specified VRF
- **ip all vrf all** all ipv4 peers in all the VRFs
- **ipv6 all vrf all** all ipv6 peers in all the VRFs

#### Example

- This command displays maintenance information about BGP peers 1.0.0.1 and 1.0.1.1 and maintenance route-map applied.

```
switch#show maintenance bgp ip all vrf all
BGP peer maintenance information for VRF default
Router identifier 0.0.1.1, local AS number 200
Neighbor: 1.0.0.1
Maintenance state: Under Maintenance
Maintenance route-map: SystemGenerated
Neighbor: 1.0.1.2
Maintenance state: Under Maintenance
Maintenance route-map: SystemGenerated

switch#
```

### 14.6.7.30 show maintenance debug

The **show maintenance debug** command displays the history of various maintenance operations on a unit/interface/BGP peer.

#### Command Mode

EXEC

#### Command Syntax

```
show maintenance debug bgp [peer_name] | interface [intf_name] | units
[unit_name]
```

#### Parameters

- *bgp* display history of all dynamic BGP units which have undergone maintenance operation
  - *interface* display history of all dynamic interface units which have undergone maintenance operation
  - *units* display history of all units which have undergone maintenance operation
  - *peer\_name* name of the peer
    - *ipv4\_addr* BGP neighbor IPv4 address
    - *ipv6\_addr* BGP neighbor IPv6 address
    - *peer-group-name* BGP peer group name
  - *intf\_name* name of the interface
    - *ethernet e\_range* Ethernet interfaces specified by *e\_range*
    - *port-channel p\_range* port channel interfaces specified by *p\_range*
    - *vlan v\_range* vlans specified by *v\_range*
-  **Note:** Valid *e\_range*, *p\_range* and *v\_range* formats include number, range, or comma-delimited list of numbers and ranges. Valid Ethernet numbers depend on the Ethernet interfaces available on the switch.
- *unit\_name* name of the unit

#### Example

- This command displays history of maintenance operation on Ethernet 16/1.

```
switch#show maintenance debug interface Ethernet 16/1-4
Interface Ethernet16/1
History:
Maintenance Enter Stage Progression started 4:07:07 ago @ 2016-08-29 22:38:54
0.000000 maintEnter stages started
0.000091 stage begin started
0.000151 event begin:EventMgr started
0.004222 event begin:EventMgr completed
0.004256 stage begin is complete
0.004315 stage before_bgp started
0.004368 event before_bgp:EventMgr started
0.005820 event before_bgp:EventMgr completed
0.005843 stage before_bgp is complete
0.005904 stage bgp started
0.005947 event bgp:Rib started
0.013821 event bgp:Rib completed
0.013855 stage bgp is complete
0.013921 stage after_bgp started
0.013974 event after_bgp:EventMgr started
0.015848 event after_bgp:EventMgr completed
0.015878 stage after_bgp is complete
0.015935 stage before_ratemon started
0.015982 event before_ratemon:EventMgr started
0.017394 event before_ratemon:EventMgr completed
0.017423 stage before_ratemon is complete
0.017470 stage ratemon started
0.017506 event ratemon:MaintenanceMode started
5.021404 event ratemon:MaintenanceMode completed
5.021438 stage ratemon is complete
5.021500 stage after_ratemon started
5.021556 event after_ratemon:EventMgr started
5.023223 event after_ratemon:EventMgr completed
5.023247 stage after_ratemon is complete
5.023300 stage end started
5.023352 event end:EventMgr started
5.024683 event end:EventMgr completed
```

---

```
5.024705 stage end is complete
5.024762 maintEnter stages complete
```



### 14.6.7.31 show maintenance groups

The **show maintenance groups** command displays all the interface/BGP groups along with their members and associated profiles.

#### Command Mode

EXEC

#### Command Syntax

```
show maintenance groups interface | bgp <group_name>
```

#### Parameters

- *interface* display only interface groups
- *bgp* display only BGP groups
- *group\_name* name of the group

#### Example

- This command displays group details for built-in interface group **AllEthernetInterface** and built-in BGP group **AllBgpNeighborVrf-default** and user-configured interface group IG1.

```
switch#show maintenance groups
Interface Group: AllEthernetInterface
Origin: Built-in
Interfaces:
 Et1, Et2, Et3, Et4, Et5/1, Et5/2, Et5/3, Et5/4, Et6/1, Et6/2, Et6/3, Et6/4,
 Et7/1, Et7/2, Et7/3, Et7/4, Et8/1, Et8/2, Et8/3, Et8/4, Et9/1, Et9/2, Et9/3,
 Et9/4, Et10/1, Et10/2, Et10/3, Et10/4, Et11/1, Et11/2, Et11/3, Et11/4, Et12/1,
 Et12/2, Et12/3, Et12/4, Et13/1, Et13/2, Et13/3, Et13/4, Et14/1, Et14/2, Et14/3,
 Et14/4, Et15/1, Et15/2, Et15/3, Et15/4, Et16/1, Et16/2, Et16/3, Et16/4, Et17/1,
 Et17/2, Et17/3, Et17/4, Et18/1, Et18/2, Et18/3, Et18/4, Et19/1, Et19/2, Et19/3,
 Et19/4, Et20/1, Et20/2, Et20/3, Et20/4, Et21/1, Et21/2, Et21/3, Et21/4, Et22/1,
 Et22/2, Et22/3, Et22/4, Et23/1, Et23/2, Et23/3, Et23/4, Et24/1, Et24/2, Et24/3,
 Et24/4, Et25/1, Et25/2, Et25/3, Et25/4, Et26/1, Et26/2, Et26/3, Et26/4, Et27/1,
 Et27/2, Et27/3, Et27/4, Et28/1, Et28/2, Et28/3, Et28/4, Et29, Et30, Et31, Et32,
 Et33, Et34, Et35, Et36
Profiles:
 Interface Profile: low-load-interval-profile
 Bgp Profile: Default
Units: System
Interface Group: IG1
Origin: User Configured
Interfaces:
 Et1, Et2, Et3, Et4, Po10, Po11, Po12
Profiles:
 Interface Profile: IP1
 Bgp Profile: BP1
Units: UNIT1
Bgp Group: AllBgpNeighborVrf-default
Origin: Built-in
Neighbors:
 Ipv4 Peers: 1.0.0.1, 1.0.1.2
 Bgp Profile: Default
 Vrf: default
Units: System

switch#
```

---

### 14.6.7.32 show maintenance interface status

The **show maintenance interface status** command displays maintenance status and rates for interfaces.

#### Command Mode

EXEC

#### Command Syntax

```
show maintenance interface status active | entering | exiting | quiesced
```

#### Parameters

- *active* interfaces which are active
- *entering* interface which are entering maintenance
- *exiting* interface which are exiting maintenance
- *quiesced* interface which are under maintenance

#### Example

- This command displays interface status and traffic rates of interfaces which are quiesced.

```
switch#show maintenance interface status quiesced
Flags:
v - Violating traffic threshold
s - Shutdown for maintenance
Rate (Mbps)
Interface Status In Out Flags

Ethernet1 Not Under Maintenance - -
Ethernet2 Not Under Maintenance - -
Ethernet3 Not Under Maintenance - -
Ethernet4 Not Under Maintenance - -
Ethernet16/1 Under Maintenance 0.0 0.0
Port-Channel10 Under Maintenance 100.5 50.5v
Port-Channel11 Entering Maintenance 15.5 10.5
Port-Channel10 Under Maintenance - -

switch#
```

### 14.6.7.33 show maintenance interface

The **show maintenance interface** command displays detailed information about interfaces and their maintenance status with traffic rates.

#### Command Mode

EXEC

#### Command Syntax

```
show maintenance interface [intf_name [detail] | detail]
```

#### Parameters

- *intf\_name* name of the interface or sub-interface. Options include:
  - ethernet *e\_range* Ethernet interfaces specified by *e\_range*
  - port-channel *p\_range* port channel interfaces specified by *p\_range*
  - vlan *v\_range* vlans specified by *v\_range*
- **detail** provides the detailed rate-monitoring information

#### Guidelines

Valid *e\_range*, *p\_range* and *v\_range* formats include number, range, or comma-delimited list of numbers and ranges.

#### Example

- This command displays interface status and traffic rates.

```
switch#show maintenance interface
Flags:
v - Violating traffic threshold
s - Shutdown for maintenance
Rate (Mbps)
Interface Status In Out Flags

Ethernet1 Not Under Maintenance - -
Ethernet2 Not Under Maintenance - -
Ethernet3 Under Maintenance 0.0 0.0
Ethernet4 Not Under Maintenance - -
...
Ethernet35 Entering Maintenance 8.7 2.9
Ethernet36 Not Under Maintenance - -
switch#
```

- This command displays detailed information about the interface Ethernet16/1.

```
switch#show maintenance interface Ethernet16/1 detail
Ethernet16/1 is Under Maintenance
Groups: AllEthernetInterface
Selected profiles from Interface groups:
Interface Maintenance profile: low-load-interval-profile
Bgp Maintenance profile: Default
Bgp:
Maintenance State: Under Maintenance
Vrf: default
Neighbor: 1.0.1.2
Maintenance routemap: SystemGenerated
Rate Monitoring:
Passive monitoring since 0:42:25 ago
Total samples taken: 236
Before Maintenance:
Below threshold: 1
Above threshold: 0
After Maintenance:
Below threshold: 235
Above threshold: 0
Last sample information:
Sample taken 0:00:04 ago
In: 0.0 Mbps
Out: 0.0 Mbps
switch#
```

---

### 14.6.7.34 show maintenance profiles

The **show maintenance profiles** command displays all the interface/BGP/unit profiles configuration.

#### Command Mode

EXEC

#### Command Syntax

```
show maintenance profiles interface | bgp | unit <profile_name>
```

#### Parameters

- *interface* display only interface profiles
- *bgp* display only BGP profiles
- *unit* display only unit profiles
- *profile\_name* name of the profile

#### Example

- This command displays profile configuration details for interface profile IP1, unit profile UP1 and BGP profile BP1.

```
switch#show maintenance profiles
Interface Profile: IP1
 Rate Monitoring:
 load-interval: 444 seconds
 threshold (in/out): 4000 Kbps
 shutdown:
 enabled: yes
 max-delay: 399 seconds
Bgp Profile: BP1
 Initiator route-map:
 name: RM1
Unit Profile: UP1
 On-boot:
 enabled: yes
 duration: 340 seconds

switch #
```

### 14.6.7.35 show maintenance stages

The **show maintenance stages** command displays stages of maintenance operation while entering/exiting maintenance.

#### Command Mode

EXEC

#### Command Syntax

```
show maintenance stages [enter | exit]
```

#### Parameters

- *enter* display maintenance stages during maintenance enter operation
- *exit* display maintenance stages during maintenance exit operation

#### Example

- This command displays maintenance mode stages details.

```
switch #show maintenance stages
No. Stage Description

1 bgp BGP Maintenance processing
2 ratemon Interface Rate Monitoring
Maintenance Exit Stage Sequence
No. Stage Description

1 ratemon Interface Rate Monitoring
2 bgp BGP Maintenance processing
switch #
```

- This command displays maintenance mode stage details during entry.

```
switch #show maintenance stages enter
No. Stage Description

1 bgp BGP Maintenance processing
2 ratemon Interface Rate Monitoring
switch#
```

---

### 14.6.7.36 show maintenance summary

The **show maintenance summary** command displays summarized information about the maintenance mode operations such as number of units configured, number of units Entering/Exiting maintenance etc.

#### Command Mode

EXEC

#### Command Syntax

**show maintenance summary**

#### Example

- This command displays summary of maintenance mode operations.

```
switch#show maintenance summary
Number of Units Configured: 0
Number of Units Exiting Maintenance: 0
Number of Units Entering Maintenance: 0
Number of Units Not Under Maintenance: 1
Number of Units Under Maintenance: 0
Directly Put Under Maintenance:
 Number of interfaces Entering Maintenance: 0
 Number of interfaces Under Maintenance: 1
 Number of bgp peers Entering Maintenance: 0
 Number of bgp peers Under Maintenance: 1
Rate Monitoring:
 Number of interfaces Entering Maintenance: 0
 Number of interfaces Under Maintenance: 1
 Number of interfaces Under Maintenance with threshold violation: 0
 Number of interfaces shutdown for maintenance: 0

switch#
```

### 14.6.7.37 show maintenance units

The **show maintenance units** command displays detailed information about the particular unit.

#### Command Mode

EXEC

#### Command Syntax

```
show maintenance units [unit_name]
```

#### Parameters

- *unit\_name* name of unit

#### Example

- This command displays maintenance units details.

```
switch#show maintenance units
Unit Name: System
Origin: Built-in
Status: Not Under Maintenance
Unit Profile: Default
Time Since Last State Change: never
Bgp Groups:
AllBgpNeighborVrf-default
Interface Groups:
AllEthernetInterface

Unit Name: UNIT1
Origin: User Configured
Status: Under Maintenance
Unit Profile: UP1
Time Since Last State Change: 0:00:08 ago
Bgp Groups:
BG1
Interface Groups:
IG1
History:
2016-08-29 23:05:30 old state: 'maintenanceModeEnter' to new state:
'underMaintenance' 0:00:08 ago
2016-08-29 23:05:30 old state: 'active' to new state: 'maintenanceModeEnter'
0:00:08 ago

switch#
```

---

### 14.6.7.38 show maintenance

The **show maintenance** command provides brief information about all units/dynamic interface unit/dynamic bgp unit and status.

'o' - flag displays that unit is undergoing or has undergone a maintenance operation because of on-boot.

'v' - flag displays that one/some of the interfaces are violating traffic, i.e. traffic for those interfaces is above threshold.

#### Command Mode

EXEC

#### Command Syntax

**show maintenance**

#### Examples

- This command displays maintenance mode details.

```
switch#show maintenance
Flags:
o - On-boot maintenance
v - Violating traffic threshold
Unit Name Status Time since last change Flags

System Not Under Maintenance never
Foo Under Maintenance 0:00:40 ago o

Interface Name Status Time since last change Flags

Ethernet16/1 Entering Maintenance 0:00:02 ago v

Bgp Neighbor(vrf: defa Status Time since last change Flags

1.0.0.2 Not Under Maintenance never

Bgp Neighbor(vrf: red) Status Time since last change Flags

2.0.1.2 Under Maintenance 0:00:16 ago

switch#
```



### 14.6.7.39 shutdown max-delay

The **shutdown max-delay** command is a maintenance interface profile configuration option for configuring the maximum duration after which the interface is shutdown with a value between 1 and 4294967295 seconds.

The **no shutdown** and **default shutdown** removes this configuration from the interface profile.

#### Command Mode

Maintenance-Profile-Interface Configuration

#### Command Syntax

```
shutdown max-delay delay
```

```
no shutdown max-delay delay
```

```
default shutdown max-delay delay
```

#### Parameters

- *delay* maximum shutdown delay between 1 and 4294967295 seconds

#### Example

- This command configures the shutdown max-delay for the profile interface IP1 to 500 seconds or one hour.

```
switch(config)#maintenance
switch(config-maintenance)#profile interface IP1
switch(config-profile-intf-IP1)#shutdown max-delay 500
switch(config-profile-intf-IP1)#show active
maintenance
 profile interface IP1
 shutdown max-delay 500

switch(config-profile-intf-IP1)#
```

## 14.6.7.40 trigger on-maintenance

The **trigger on-maintenance** command is an event handler configuration for triggering actions during the maintenance operation of a unit, interface and BGP peer at specified stages.

The event-handler configuration takes effect only after exiting the event-handler configuration mode.

### Command Mode

Event-handler Configuration

### Command Syntax

```
trigger on-maintenance <enter | exit> <unit <unit_name> | bgp <ipv4_addr | ipv6_addr | peer_group> [vrf <vrf_name>] | interface <intf_name>> <begin | end | all | <before | after> stage <stage_name>>
```

### Parameters

- *enter* trigger on-maintenance event-handler on maintenance enter operation
- *exit* trigger on-maintenance event-handler on maintenance exit operation
- *bgp* trigger event-handler on dynamic BGP unit maintenance operation
  - *pv4\_addr* BGP neighbor ipv4 address
  - *pv6\_addr* BGP neighbor ipv6 address
  - *peer\_group* BGP peer group name
- *vrf vrf\_name* name of the VRF to which BGP peer belongs
- *interface* trigger event-handler on dynamic interface unit maintenance operation
  - *intf\_name* name of the interface
    - *ethernet* trigger event-handler on specified Ethernet interface
    - *port-channel* trigger event-handler on specified port channel interface
    - *vlan* trigger event-handler on specified vlan



**Note:** Comma-delimited list, ranges are not supported.

- *unit* trigger event-handler on maintenance operation of unit
- *begin* action is triggered in the beginning of maintenance operation
- *end* action is triggered at the end of maintenance operation
- *stage\_name* action is triggered at specified stage
  - *bgp* and *ratemon* are the two stages
- *all* action is triggered at all the stages
- *before* action is triggered before the specified stage
- *after* action is triggered after the specified stage

### Examples

- This command configures event-handler E1, which triggers on maintenance an enter operation of unit UNIT1 at all the stages.

```
switch(config)#event-handler E1
switch(config-handler-E1)#trigger on-maintenance enter unit UNIT1 all
switch(config-handler-E1)#action bash FastCli -c "show maintenance"
switch(config-handler-E1)# exit
switch(config)# show event-handler E1
Event-handler E1
Trigger: Asynchronous on-maintenance enter unit UNIT1 all delay 0
seconds
Threshold Time Window: 0 Seconds, Event Count: 1 times
Action: FastCli -c "show maintenance"
Action expected to finish in less than 10 seconds
Last Trigger Detection Time: Never
```

```
Total Trigger Detections: 0
Last Trigger Activation Time: Never
Total Trigger Activations: 0
Last Action Time: Never
Total Actions: 0

switch(config)#
```

- This command configures event-handler E2, which triggers on maintenance an exit operation of dynamic interface unit Ethernet1 before stage bgp.

```
switch(config)#event-handler E2
switch(config-handler-E2)#trigger on-maintenance exit interface
Ethernet1 before
stage bgp
switch(config-handler-E2)#action bash FastCli -c "show maintenance
summary"
switch(config-handler-E2)# exit
switch(config)# show event-handler E2
Event-handler E2
Trigger: Asynchronous on-maintenance exit interface Ethernet1 before
stage bgp
delay 0 seconds
Threshold Time Window: 0 Seconds, Event Count: 1 times
Action: FastCli -c "show maintenance summary"
Action expected to finish in less than 10 seconds
Last Trigger Detection Time: Never
Total Trigger Detections: 0
Last Trigger Activation Time: Never
Total Trigger Activations: 0
Last Action Time: Never
Total Actions: 0

switch(config)#
```

- This command configures event-handler E3, which triggers on maintenance an enter operation of dynamic BGP unit 1::1 in VRF VRF1 at the last stage end.

```
switch(config)#event-handler E3
switch(config-handler-E3)#trigger on-maintenance enter bgp 1::1 vrf
VRF1 end
switch(config-handler-E3)#action bash FastCli -c "show maintenance bgp
ip all vrf
all"
switch(config-handler-E3)# exit
switch(config)# show event-handler E3
Event-handler E3
Trigger: Asynchronous on-maintenance enter bgp 1::1 vrf VRF1 end delay
0 seconds
Threshold Time Window: 0 Seconds, Event Count: 1 times
Action: FastCli -c "show maintenance bgp ip all vrf all"
Action expected to finish in less than 10 seconds
Last Trigger Detection Time: Never
Total Trigger Detections: 0
Last Trigger Activation Time: Never
Total Trigger Activations: 0
Last Action Time: Never
Total Actions: 0

switch(config)#
```

---

### 14.6.7.41 unit

The `unit <unit_name>` command places the switch in maintenance unit configuration mode for configuring BGP/interface groups in the unit.

The command creates the unit if the specified unit profile does not exist prior to issuing the command.

The `no unit <unit-name>` and `default unit <unit-name>` removes the unit from *running-config*.

#### Command Mode

Maintenance Configuration

#### Command Syntax

```
unit linecard l_range | unit_name
no unit linecard l_range | unit_name
default unit linecard l_range | unit_name
```

#### Parameters

- *Linecard l\_range* name of the Linecard built-in unit
- *0 l\_range* linecards available on the switch
- *unit\_name* name of the user-configured unit

#### Commands available in maintenance unit configuration mode:

- `group interface`
- `group bgp`
- `profile unit`
- `quiesce`

 **Note:** Built-in units like System, Linecard3, Linecard4, etc. do not allow group configuration but unit profile can be associated to these units.

#### Examples

- This command creates maintenance unit UNIT1.

```
switch(config)#maintenance
switch(config-maintenance)#unit UNIT1
switch(config-unit-UNIT1)#show active
maintenance
unit UNIT1
switch(config-unit-UNIT1)#
```

- This command enters the built-in Linecard1 unit configuration mode.

```
switch(config)#maintenance
switch(config-maintenance)#unit Linecard1
switch(config-builtin-unit-Linecard1)#show active
maintenance
unit Linecard1
switch(config-builtin-unit-Linecard1)#
```

### 14.6.7.42 vrf

The **vrf** command specifies the VRF for BGP group. All the neighbors configured in the BGP group are considered to be members of the BGP group in the particular VRF context.

The **no vrf <vrf-name>** and **default vrf <vrf-name>** removes the VRF configuration from the BGP group and sets the VRF context to default.

#### Command Mode

Group-BGP Configuration

#### Command Syntax

**vrf** *vrf\_name*

**no vrf** *vrf\_name*

**default vrf** *vrf\_name*

#### Parameters

- *vrf\_name* name of the VRF in a group belonging to neighbors in that group

#### Example

- This command specifies VRF VRF1 for the neighbors in the BGP group BGP1.

```
switch(config)#group bgp BG1
switch(config-group-bgp-BG1)#neighbor 1.0.1.1
switch(config-group-bgp-BG1)#neighbor 1::1
switch(config-group-bgp-BG1)#neighbor PG
switch(config-group-bgp-BG1)#vrf VRF1
switch(config-group-bgp-BG1)#show active
group bgp BG1
 neighbor 1.0.1.1
 neighbor 1::1
 neighbor PG
 vrf VRF1
switch(config-group-bgp-BG1)#exit
switch(config)#
```

## 14.7 Bidirectional Forwarding Detection

This section describes Bidirectional Forwarding Detection (BFD) and how it is configured in relation to various protocols. Topics in this section include:

- [Introduction](#)
- [BFD Configuration](#)
- [Hardware Accelerated BFD Transmit](#)
- [BFD Commands](#)

### 14.7.1 Introduction

In networks without data link signaling, connection failures are usually detected by the hello mechanisms of routing protocols. Detection can take over a second, and reducing detection time by increasing the rate at which hello packets are exchanged can create an excessive burden on the participating CPUs.

BFD is a low-overhead, protocol-independent mechanism which adjacent systems can use instead for faster detection of faults in the path between them. BFD is strictly a failure-detection mechanism, and does not discover neighbors or reroute traffic.

---

BFD is a simple mechanism which detects the liveness of a connection between adjacent systems, allowing it to quickly detect failure of any element in the connection. It does not operate independently, but only as an adjunct to routing protocols. The routing protocols are responsible for neighbor detection, and create BFD sessions with neighbors by requesting failure monitoring from BFD.

Once a BFD session is established with a neighbor, BFD exchanges control packets to verify connectivity and informs the requesting protocol of failure if a specified number of successive packets are not received. The requesting protocol is then responsible for responding to the loss of connectivity.

Routing protocols using BFD for failure detection continue to operate normally when BFD is enabled, including the exchange of hello packets.

The basic behavior of BFD is defined in RFC 5880.

#### 14.7.1.1 BFD Modes

BFD functions in asynchronous or demand mode, and also offers an echo function. EOS supports asynchronous mode and the echo function.

- [Asynchronous Mode](#)
- [Demand Mode](#)

##### 14.7.1.1.1 Asynchronous Mode

In asynchronous mode, BFD control packets are exchanged by neighboring systems at regular intervals. If a specified number of sequential packets are not received, BFD declares the session to be down.

##### 14.7.1.1.2 Demand Mode

In demand mode, once the BFD session is established, the participating systems can request that BFD packets not be sent, then request an exchange of packets only when needed to verify connectivity. EOS does not support demand mode.

#### 14.7.1.2 Echo Function

When the echo function is in use, echo packets are looped back through the hardware forwarding path of the neighbor system without involving the CPU. Failure is detected by an interruption in the stream of echoed packets. The minimum reception rate for BFD control packets from the neighbor is also changed automatically when the echo function is operational, because liveness detection is supplied by the echo packets.

While BFD control messages are transmitted to port 3784, BFD echo messages use UDP port 3785 for both source and destination.

#### 14.7.1.3 BFD on Port Channels

On port channels, the BFD per-link feature can be used to add resiliency to the port channel's BFD sessions. When BFD per-link is enabled, BFD considers the port channel "up" as long as any link in the port channel is functioning properly.

BFD per-link can be configured in full compliance with RFC 7130, causing member ports to be removed from the port channel when their BFD micro sessions are down, or in legacy mode, which relies on the LAG itself to detect and remove unresponsive member ports. By default, BFD per-link operates in legacy mode, which allows the switch to inter-operate more effectively with older equipment, but which may drop traffic if downed links are not detected by other means. RFC7130 mode allows for faster detection and removal of downed links within the port channel and can be used in situations where LACP is not supported. For the BFD session to come up, both peers must be configured in the same way.

## 14.7.2 BFD Configuration

To use BFD as the failure detection mechanism for a routing protocol, it must be enabled for each participating protocol.

These sections describe BFD configuration tasks:

- [Configuring BFD on an Interface](#)
- [Configuring BFD on a Port Channel](#)
- [Configuring the Echo Function](#)
- [Configuring BFD for PIM](#)
- [Configuring BFD for BGP](#)
- [Configuring BFD for VRRP](#)
- [Configuring BFD for OSPF](#)
- [Configure BFD for IS-IS](#)
- [Configuring BFD Session Telemetry](#)
- [Displaying BFD Neighbor Information](#)

### 14.7.2.1 Configuring BFD on an Interface

The transmission rate for BFD control packets, the minimum rate at which control packets are expected from the peer, and the multiplier (the number of packets that must be missed in succession before BFD declares the session to be down) can all be configured per interface. The values configured apply to all BFD sessions that pass through the interface.

The default values for these parameters are:

- `transmission rate` 300 milliseconds
- `minimum receive rate` 300 milliseconds
- `multiplier` 3

To configure different values for these parameters on an interface, use the `bfd interval` command.

For BFD to function as a failure detection mechanism, it must be enabled for each participating protocol.

#### Example

- These commands set the transmit and receive intervals to 200 milliseconds and the multiplier to 2 for all BFD sessions passing through Ethernet interface 3/20.

```
switch(config)#interface ethernet 3/20
switch(config-if-Et3/20)#bfd interval 200 min_rx 200 multiplier 2
switch(config-if-Et3/20)#
```

### 14.7.2.2 Configuring BFD on a Port Channel

Basic BFD parameters are configured on a port channel as described in [Configuring BFD on an Interface](#) above.

Additionally, BFD can be configured in per-link mode on a port channel so that the port channel will be considered up as long as any link in the channel is up. BFD per-link can be configured in compliance with RFC 7130 (causing member ports to be removed from the port channel when their BFD micro session is down), or in legacy mode for interoperability with older equipment. For the BFD session to come up, both peers must be configured in the same way (either RFC-7130 or legacy mode).

- **Note:** In RFC 7130 mode, if multiple IP addresses are configured for a member of a port channel (e.g., one IPv4 address and one IPv6 address), the member will be removed from the port channel if the micro session associated with either IP address goes down.

### 14.7.2.2.1 Enabling BFD Per-link

To enable BFD per-link on a port channel, use the `bfd per-link` command.

#### Example

- These commands enabled BFD per-link on port channel 5.

```
switch(config)#interface port-channel 5
switch(config-if-Po5)#bfd per-link
switch(config-if-Po5)#
```

### 14.7.2.2.2 Configuring BFD Per-link in RFC 7130 Mode

By default, BFD per-link operates in legacy mode. To enable RFC 7130 mode (in which a member port is removed from the port channel when its BFD micro session is down), configure the switch as follows.

1. If you are configuring an L2 interface, specify a local L3 BFD address for the switch using the `bfd local-address` command. This is not necessary when configuring an L3 interface with an IP address configured on the port channel.
2. Enable BFD per-link on the port channel using the `bfd per-link` command.
3. Specify the L3 address of the port channel's BFD neighbor using the `bfd neighbor` command. For an L2 port channel, the address is the globally configured BFD local address on the peer switch. For an L3 port channel, the address is the IP address configured on the peer port channel.

#### Examples

- These commands configure BFD per-link in RFC 7130 mode over an L2 port channel.

Switch 1 configuration:

```
switch1(config)#bfd local-address 10.0.0.5
switch1(config)#interface port-channel 5
switch1(config-if-Po5)#bfd per-link rfc-7130
switch1(config-if-Po5)#bfd neighbor 10.0.0.4
switch1(config-if-Po5)#
```

Switch 2 configuration:

```
switch2(config)#bfd local-address 10.0.0.4
switch2(config)#interface port-channel 5
switch2(config-if-Po5)#bfd per-link rfc-7130
switch2(config-if-Po5)#bfd neighbor 10.0.0.5
switch2(config-if-Po5)#
```

- These commands configure BFD per-link in RFC 7130 mode over an L3 port channel.

Switch 1 configuration:

```
switch1(config)#interface port-channel 5
switch1(config-if-Po5)#no switchport
switch1(config-if-Po5)#bfd per-link rfc-7130
switch1(config-if-Po5)#ip address 10.0.0.5/24
switch1(config-if-Po5)#bfd neighbor 10.0.0.4
switch1(config-if-Po5)#
```

Switch 2 configuration:

```
switch2(config)#interface port-channel 5
```



```
switch2(config-if-Po5) #no switchport
switch2(config-if-Po5) #bfd per-link rfc-7130
switch2(config-if-Po5) #ip address 10.0.0.4/24
switch2(config-if-Po5) #bfd neighbor 10.0.0.5
```

### 14.7.2.3 Configuring the Echo Function

The echo function is disabled by default, and is enabled on an interface using the **bfd echo** command.

When the BFD echo function is enabled, a "slow-timer" value replaces the minimum receive interval value in BFD packets sent from the switch. The default value is 2000 milliseconds. To configure a different value for the slow-timer, use the **bfd slow-timer** command.

#### Examples

- These commands enable the BFD echo function on Ethernet interface 5. If a slow-timer value has been configured on the switch, the minimum receive rate expected from the BFD neighbor will be reset to that value; otherwise, the minimum receive rate will be set to 2000 milliseconds.

```
switch(config) #interface ethernet 5
switch(config-if-Et5) #bfd echo
switch(config-if-Et5) #
```

- This command configures BFD to expect control packets from the peer every 10000 milliseconds when the BFD echo function is enabled.

```
switch(config) #bfd slow-timer 10000
switch(config) #
```

### 14.7.2.4 Configuring BFD for PIM

The **bfd (Router-PIM Sparse-mode)** command enables or disables Bidirectional Forwarding Detection (BFD) globally for all protocol-independent multicast (PIM) neighbors.

To enable or disable PIM BFD on a specific interface, use the **pim ipv4 bfd** command. The interface-level configuration supersedes the global setting.

#### Example

- These commands enable PIM BFD globally on the switch in the default VRF, enabling it on all PIM-SM interfaces where it is not explicitly disabled.

```
switch(config) #router pim sparse-mode
switch(config-router-pim-sparse) #ipv4
switch(config-router-pim-sparse-ipv4) #bfd
switch(config-router-pim-sparse-ipv4) #
```

- These commands configure VLAN interface 200 to use BFD for PIM-SM connection failure detection regardless of the global PIM BFD configuration.

```
switch(config) #interface vlan 200
switch(config-if-VL200) #pim ipv4 bfd
switch(config-if-VL200) #
```

---

### 14.7.2.5 Configuring BFD for BGP

To enable or disable Bidirectional Forwarding Detection (BFD) for border gateway protocol (BGP) connections with a BGP neighbor or peer group, use the **neighbor bfd** command.

#### Example

- These commands enable BFD failure detection for BGP connections with the neighbor at 10.13.64.1.

```
switch(config)#router bgp 300
switch(config-router-bgp)#neighbor 10.13.64.1 bfd
switch(config-router-bgp)#
```

### 14.7.2.6 Configuring BFD for VRRP

To enable or disable Bidirectional Forwarding Detection (BFD) for virtual router redundancy protocol (VRRP), use the **vrrp bfd ip** command.

When enabled, BFD provides failure detection for a 2-router VRRP system. When the master is configured with the physical IP address of the backup router, and the backup is configured with the address of the master, a BFD session is established between them. If the BFD session goes down, the backup router immediately assumes the master role.

VRRP master advertisement packets are still sent even when the BFD session is established to accommodate VRRP systems involving more than two routers.

#### Example

- These commands enable BFD on Ethernet interface 3/20 for VRRP ID 15 with a connection to a router at IP address 192.168.2.1.

```
switch(config)#interface ethernet 3/20
switch(config-if-Et3/20)#vrrp 15 bfd ip 192.168.2.1
switch(config-if-Et3/20)#
```

### 14.7.2.7 Configuring BFD for OSPF

To enable or disable BFD globally for all OSPF neighbors, use the **bfd default (OSPF)** command in OSPF configuration mode.

To enable or disable BFD for OSPF on a specific interface, use the **ip ospf neighbor bfd** command. The interface-level configuration supersedes the global setting.

#### Example

- These commands enable BFD in OSPF instance 100 for all OSPF neighbors on BFD-enabled interfaces except those connected to interfaces on which OSPF BFD has been explicitly disabled.

```
switch(config)#router ospf 100
switch(config-router-ospf)#bfd default
switch(config-router-ospf)#
```

- This command enables OSPF BFD on Ethernet interface 3/21.

```
switch(config)#interface ethernet 3/21
switch(config-if-Et3/21)#ip ospf neighbor bfd
switch(config-if-Et3/21)#
```

### 14.7.2.8 Configure BFD for IS-IS

The `isis bfd` command configures Bidirectional Forwarding Detection (BFD), a low overhead protocol designed to provide rapid detection of failures at any protocol layer in the path between adjacent forwarding engines over any media. BFD is supported for IS-IS IPv4 routes.

#### Examples

- These commands enable BFD for all the interfaces on which IS-IS is enabled. By default BFD is disabled on all the interfaces.

```
switch(config)#router isis 1
switch(config-router-isis)#address-family ipv4
switch(config-router-af)#bfd default
switch(config-router-af)#
```

- These commands enable BFD on IS-IS interfaces.

```
switch(config)#interface Ethernet 5/6
switch(config-if-Et5/6)#isis bfd
switch(config-if-Et5/6)#
```

### 14.7.2.9 Configuring BFD Session Telemetry

The BFD session telemetry automatically collects the per-session statistics and the `rbfd` kernel module statistics at a set interval and stores them in a shared memory where Cloud Vision Portal (CVP) or other applications may collect this information. Also, several new statistics have been added which are updated within the `session-stats` interval and provides a finer snapshot view of the session health. The BFD session telemetry supports both hardware-accelerated and software (kernel module) accelerated BFD sessions.

Use the `session stats snapshot interval` command to enable the BFD session telemetry. This command is configured under the `router-bfd` configuration mode. By default, this command is disabled and the telemetry interval is set to zero seconds. A telemetry interval between 10 and 3600 seconds may be configured.

Use the `no` and `default` form of the command to disable the `session stats snapshot interval` command from the running configuration and sets the telemetry interval is set to zero.

#### Example

```
switch(config-router-bfd)#session stats snapshot interval 10
```

A telemetry interval may be configured to a value less than 10 seconds and as small as 1 second using an additional keyword **dangerous**, as follows:

```
switch(config-router-bfd)#session stats snapshot interval dangerous 1
```

However, note that, configurations including a telemetry interval of less than 10 seconds are not advised for systems with a large-scale BFD deployment as this may cause delays in the `rbfd` kernel module and result in BFD session instability.

### 14.7.2.10 Displaying BFD Neighbor Information

Use the `show bfd peers` command to display information about Bidirectional Forwarding Detection (BFD) neighbors.

## Example

- This command displays general information about BFD neighbors.

```
switch>show bfd peers
DstAddrMyDiscYoDiscIfLUpLDownLdiagState

10.168.1.561613et52_1(81)17151450 0NoDiagnosticUp
10.168.1.581714et52_2(65)17151883 0NoDiagnosticUp
10.168.1.241815et51_1(73)17152175 0NoDiagnosticUp
```

- This command displays detailed information about BFD neighbors.

```
switch>show bfd peers detail
Peer Addr 10.168.1.56, Intf Ethernet52/1, State Up
VRF default, LAddr 10.168.1.57, LD/RD 16/13
Last Up 17151450
Last Down 0
Last Diag: No Diagnostic
TxInt: 300, RxInt: 300, Multiplier: 3
Received RxInt: 300, Received Multiplier: 3
Rx Count: 433987, Tx Count: 433829
Detect Time: 900
Registered protocols: bgp

Peer Addr 10.168.1.58, Intf Ethernet52/2, State Up
VRF default, LAddr 10.168.1.59, LD/RD 17/14
Last Up 17151883
Last Down 0
Last Diag: No Diagnostic
TxInt: 300, RxInt: 300, Multiplier: 3
Received RxInt: 300, Received Multiplier: 3
Rx Count: 434235, Tx Count: 434050
Detect Time: 900
Registered protocols: bgp
```

### 14.7.3 Hardware Accelerated BFD Transmit

Hardware Accelerated BFD Transmit adds support for offloading BFD Transmit path to hardware (ASIC) for specific types of BFD sessions.

Hardware Accelerated BFD Transmit improves accuracy of transmit timer implementations for BFD (especially with fast timers like 50 ms) and relieves pressure on the main CPU in scenarios of scale. The RX packet processing for all BFD sessions is still handled by the BFD agent on the main CPU. The feature does not add any additional timer interval or multiplier configurations.

On supported platforms, hardware acceleration-capable BFD sessions is offloaded by default. Memory resources are required on ASIC to offload sessions (one unit per discriminator). Currently, the number of session discriminators that can be offloaded is restricted to 200 per ASIC.

Only single-hop BFD sessions on front panel ports are capable of being offloaded. In **EOS Release 4.23.0F**, the following sessions types **cannot** be offloaded:

- BFD sessions over Port-Channel Sub-Interfaces
- BFD sessions over L3 Sub-Interfaces
- BFD sessions over an entire Port-Channel (not per member BFD)
- BFD sessions over a Switched Virtual Interface
- BFD sessions over a Loopback interface
- BFD sessions over Tunnel interfaces
- Multi-hop BFD sessions
- BFD sessions with Authentication configured

From **EOS Release 4.23.1F** onwards, the following additional session types **can** be offloaded:

- BFD sessions over L3 Sub-Interfaces

From **EOS Release 4.24.0F** onwards, hardware acceleration is only supported on certain SSO redundancy protocol configured modular systems.

 **Note:** For the purposes of memory management in hardware, each discriminator occupies one unit of memory. When echo mode is enabled on a session, both asynchronous mode and the echo function have separate discriminators and each take up a unit each amongst the 200 available per ASIC.

### 14.7.3.1 Platform Compatibility

Starting with the **EOS Release 4.23.0F** onwards, the following platforms are supported:

**Table 72: EOS Release 4.23.0F Support**

|                 |                                                   |
|-----------------|---------------------------------------------------|
| DCS-7050QX-32   | DCS-7050TX-72                                     |
| DCS-7050QX-32S  | DCS-7050TX-72Q                                    |
| DCS-7050QX2-32S | DCS-7050TX-72Q                                    |
| DCS-7050SX-128  | DCS-7050TX2-128                                   |
| DCS-7050SX-64   | DCS-7060CX-32S                                    |
| DCS-7050SX-72   | DCS-7060CX2-32S                                   |
| DCS-7050SX-72Q  | DCS-7060SX2-48YC6                                 |
| DCS-7050SX-96   | DCS-7250QX-64                                     |
| DCS-7050SX2-128 | DCS-7260CX-64                                     |
| DCS-7050SX2-72Q | DCS-7260CX3-64                                    |
| DCS-7050TX-128  | DCS-7260CX3-64E                                   |
| DCS-7050TX-48   | DCS-7260QX-64                                     |
| DCS-7050TX-64   | DCS-7300 series on the following line cards only: |
|                 | • 7300X-32Q-LC                                    |
|                 | • 7300X-64S-LC                                    |
|                 | • 7300X-64T-LC                                    |
|                 | • 7320X-32C-LC                                    |

Starting with the **EOS Release 4.23.2F** onwards, support for the following platforms have been added:

**Table 73: EOS Release 4.23.2F Support**

|                    |                                              |
|--------------------|----------------------------------------------|
| DCS-7050SX3-48YC8  | DCS-7060DX4-32                               |
| DCS-7050SX3-48YC12 | DCS-7060PX4-32                               |
| DCS-7050CX3-32S    | DCS-7300 series on the following line cards: |
|                    | • 7300X3-32C-LC                              |
|                    | •                                            |
| DCS-7050CX3M-32S   | 7300X3-48YC4-LC                              |

Starting with the **EOS Release 4.24.1F** onwards, support for the following platforms have been added:

---

**Table 74: EOS Release 4.24.1F Support**

DCS-7368 series on the following line cards only: DCS-7280CR3-32D4

- 7368-4D
- 7368-4P
- 7368-16C

DCS-7280PR3-24

DCS-7280CR3K-32D4

DCS-7280PR3K-24

DCS-7280CR3MK-32D4

DCS-7280DR3-24

DCS-7280CR3-96

DCS-7280DR3K-24

DCS-7280CR3K-96

DCS-7280CR3-32P4

DCS-7500R series on the following line cards only:

- 7500R3-24P-LC
- 7500R3-24D-LC
- 7500R3-36CQ-LC
- 7500R3K-36CQ-LC

DCS-7280CR3K-32P4

DCS-7800 series on the following line cards only:

- 7800R3-48CQ-LC
- 7800R3K-48CQ-LC
- 7800R3-48CQM-LC
- 7800R3-36P-LC

DCS-7280CR3MK-32P4

**SSO Support**

Starting with the ***EOS Release 4.24.0F*** onwards, support for the following modular platforms has been added, when SSO redundancy protocol is configured:

**Table 75: EOS Release 4.24.0F SSO Support**

DCS-7500R series on the following line cards only:

- 7500R-8CFPX-LC
- 7500R-36Q-LC
- 7500R-36CQ-LC
- 7500R-48S2CQ-LC
- 7500R2AK-48YCQ-LC
- 7500R2-36CQ-LC
- 7500R2-18CQ-LC
- 7500R2A-36CQ-LC
- 7500R2AK-36CQ-LC
- 7500RM-36CQ-LC
- 7500R2M-36CQ-LC
- 7500R2AM-36CQ-LC

### 14.7.3.2 Configuration

The Hardware Accelerated BFD Transmit feature is enabled by default on supported platforms. No explicit configuration is required.

The feature may be disabled using the following command:

```
switch(config-router-bfd) #hardware acceleration disabled
```

### 14.7.3.3 Show Commands

#### Hardware Acceleration Information

To view whether hardware acceleration is running use the `show bfd hardware acceleration` command. In this example, hardware acceleration is running.

#### Example

```
switch(config) #show bfd hardware acceleration
Hardware acceleration is running
```

The following example displays when hardware acceleration is not enabled and the reasons why.

#### Example

```
switch#show bfd hardware acceleration
Hardware acceleration is not running: user disabled, no eligible
sessions, not supported with SSO
```

The reasons listed for when hardware acceleration could be a subset of the following:

- **User disabled:** The feature was explicitly disabled in the CLI configuration.
- **No eligible sessions:** There are no BFD sessions configured that could be hardware accelerated. For example, all current BFD sessions have authentication enabled.
- **Not supported with SSO:** On certain modular systems, the feature is not supported when the redundancy protocol is configured to SSO.

The following example output of the command is when the hardware acceleration feature is not supported on a product:

```
Hardware acceleration is not supported
```

#### Session Information

Use the `show bfd peers detail` command to display whether an individual session is hardware accelerated or not. An additional line has been added to the command to display hardware acceleration as shown in the following example.

```
switch#show bfd peers detail
VRF name: default

Peer Addr 10.0.0.2, Intf Ethernet3/1/1, Type normal, State Down
VRF default, LAddr 0.0.0.0, LD/RD 1157402594/0
Session state is Down and not using echo function
Hardware Acceleration: Async On, Echo On
...
```

**Async On** denotes the Asynchronous Transmit component of the session has been offloaded.

**Echo On** denotes the Echo Transmit function of the session has been offloaded.



**Note:** There is no guarantee that both the Asynchronous transmit component and the echo function will be offloaded together to the hardware.

### Hardware Acceleration Summary

Use the `show bfd hardware utilization` command to display a summary of the number of offloaded discriminators per ASIC.

#### Example

```
switch#show bfd hardware utilization
Chip Name Number Of Sessions Maximum Number Of Sessions

Jericho0 20 200
Jericho1 0 200
```

### Detailed Hardware Acceleration Information

Use the `show bfd hardware utilization detail` command to display a detailed list of the BFD discriminators whose transmit path is offloaded can be viewed per ASIC using:

#### Example

```
switch#show bfd hardware utilization detail
sh bfd hardware utilization detail
Chip: Jericho0
Dst Addr My Disc Interface VRF Type

1.1.6.2 3175653802 Ethernet1/1 default normal
1.1.3.2 1151992021 Ethernet2/1 default normal

Chip: Jericho1
Dst Addr My Disc Interface VRF Type

```

### 14.7.3.4 Tracing

By default, quick tracing is enabled for Bfd and SandBfd agents on supported platforms.

Beginning with **EOS Release 4.23.1F**, by default, quick tracing is enabled for the StrataBfd agent on supported platforms.

### 14.7.3.5 Limitations

The following limitations are associated with the Hardware Accelerated BFD Transmit feature.

- Hardware acceleration is not supported on certain modular systems configured with SSO redundancy protocol.
- Before **EOS Release 4.24.0F**, on 7500 series modular systems with both 7500E series and 7500R series line cards, hardware acceleration is not supported if the systems **Forwarding Mode** is **Arad**, as shown by `show platform sand compatibility` command display output. From the **EOS Release 4.24.0F** onwards, this does not apply because the 7500E series line cards are deprecated.
- Hardware acceleration is not supported on Port-Channel Sub-Interfaces.
- In the **EOS Release 4.23.0F**, hardware acceleration is not supported on L3 Sub-Interfaces.
- Hardware acceleration is not supported on Switched Virtual Interfaces.
- Hardware acceleration is not supported on Port-Channel interfaces (non-per-link BFD).
- Hardware acceleration is not supported on Loopback interfaces.
- Hardware acceleration is not supported on Tunnel interfaces.



- Hardware acceleration is not supported on front-panel or Port-Channel sub-interfaces.
- Hardware acceleration is not supported with Multi-hop BFD.
- Hardware acceleration is not supported when Authentication is enabled.
- Configuring authentication on an already offloaded session results in the session being migrated back to software. Similarly, deconfiguring authentication migrates the session to hardware if the session is hardware acceleration capable and if resources are available on the ASIC in question.
- Hardware acceleration limits the number of accelerated transmit discriminators to 200 per ASIC.
- Configuring more than 200 session discriminators on interfaces attached to an ASIC results in the additional session discriminators falling back to the default software transmit implementation, where the accuracy of transmit timers are dependent on the host CPU load.
- When enabling hardware acceleration with a high enough number of existing offload-capable software sessions, **a flap in some sessions may be observed once at the time of migration from software to hardware.**
- When disabling hardware acceleration with a high enough number of existing offloaded sessions, **a flap in some sessions may be observed once at the time of migration from hardware to software.**
- Sessions are offloaded to hardware in a first-come, first-served fashion. Currently, in an overflow scenario with more than 200 session discriminators per chip, there is no guarantee that shorter intervals are always offloaded.

---

## 14.7.4 BFD Commands

### BFD Configuration Command

- [bfd echo](#)
- [bfd interval](#)
- [bfd local-address](#)
- [bfd neighbor](#)
- [bfd per-link](#)
- [bfd slow-timer](#)
- [hardware acceleration disabled](#)
- [session stats snapshot interval \(BFD\)](#)

### BFD Display Commands

- [show bfd hardware acceleration](#)
- [show bfd hardware utilization](#)
- [show bfd peers](#)
- [show bfd peers detail](#)

### PIM-BFD Configuration Commands

- [bfd \(Router-PIM Sparse-mode\)](#)
- [pim ipv4 bfd](#)

### BGP-BFD Configuration Commands

- [neighbor bfd](#)

### VRRP-BFD Configuration Commands

- [vrrp bfd ip](#)

### OSPF-BFD Configuration Commands

- [bfd default \(OSPF\)](#)
- [ip ospf neighbor bfd](#)

### ISIS-BFD Configuration Commands

- [isis bfd](#)
- [bfd default \(ISIS\)](#)

### 14.7.4.1 bfd (Router-PIM Sparse-mode)

The **bfd (Router-PIM Sparse-mode)** command enables Bidirectional Forwarding Detection (BFD) globally for use as a failure-detection mechanism for Protocol-Independent Multicast Sparse-Mode (PIM-SM) on the switch. To override the global configuration for a specific interface, use the [pim ipv4 bfd](#) command. All PIM-SM interfaces will use the global setting if they are not individually configured.

When PIM BFD is enabled, a BFD session is created for each PIM-SM neighbor and used to detect a loss of connectivity with the neighbor. PIM hello packets are still exchanged with PIM-SM neighbors when BFD is enabled.

The **no bfd** and **default bfd** commands disable PIM BFD globally by deleting the **bfd** statement from **running-config**. When this is done, only interfaces with PIM BFD explicitly enabled will use PIM BFD.

#### Command Mode

Router-PIM Sparse-mode IPv4 Configuration

Router-PIM Sparse-mode VRF IPv4 Configuration

#### Command Syntax

```
bfd
```

```
no bfd
```

```
default bfd
```

#### Example

- These commands enable PIM BFD globally on the switch in the default VRF, enabling it on all PIM-SM interfaces where it is not explicitly disabled.

```
switch(config)#router pim sparse-mode
switch(config-router-pim-sparse)#ipv4
switch(config-router-pim-sparse-ipv4)#bfd
switch(config-router-pim-sparse-ipv4)#
```

---

### 14.7.4.2 bfd default (ISIS)

The **bfd default** command places the switch in address-family configuration mode.

The **bfd default** and **isis bfd** commands configure Bidirectional Forwarding Detection (BFD), a low overhead protocol designed to provide rapid detection of failures at any protocol layer in the path between adjacent forwarding engines over any media. BFD is supported for IS-IS IPv4 routes.

#### Command Mode

Router-Address-Family Configuration

#### Command Syntax

#### **bfd default** Example

- These commands enable BFD for all the interfaces on which IS-IS is enabled. By default BFD is disabled on all the interfaces.

```
switch(config)#router isis 1
switch(config-router-isis)#address-family ipv4
switch(config-router-af)#bfd default
switch(config-router-af)#
```

### 14.7.4.3 bfd default (OSPF)

The `bfd default` command globally configures OSPF to use Bidirectional Forwarding Detection (BFD). When this command is issued, BFD sessions will be established with all OSPF neighbors connected to BFD-enabled interfaces unless OSPF BFD has been disabled on a participating interface using the `ip ospf neighbor bfd` command. BFD is globally disabled in OSPF by default.

For OSPF BFD to function on an interface, BFD must also be enabled and configured on that interface using the `bfd interval` command.

The `no bfd default` and `default bfd default` commands disable OSPF BFD on all interfaces except those where it has been explicitly enabled using the `ip ospf neighbor bfd` command.

#### Command Mode

Router-OSPF Configuration

#### Command Syntax

`bfd default`

`no bfd default`

`default bfd default` **Examples**

These commands enable BFD for OSPF instance 100 on all interfaces except those on which OSPF BFD has been explicitly disabled.

```
switch(config)#router ospf 100
switch(config-router-ospf)#bfd default
switch(config-router-ospf)#
```

---

#### 14.7.4.4 bfd echo

The **bfd echo** command enables the BFD echo function on the configuration mode interface.

The **no bfd echo** and **default bfd echo** commands disable the BFD echo function by removing the corresponding **bfd echo** command from **running-config**.

##### Command Mode

Interface-Ethernet Configuration Interface-Loopback Configuration Interface-Management Configuration Interface-Port-channel Configuration Interface-VLAN Configuration

##### Command Syntax

**bfd echo**

**no bfd echo**

**default bfd echo**

##### Example

- These commands enable the BFD echo function on Ethernet interface 5. If a slow-timer value has been configured on the switch, the minimum receive rate expected from the BFD neighbor will be reset to that value; otherwise, the minimum receive rate will be set to 2000 milliseconds.

```
switch(config)#interface ethernet 5
switch(config-if-Et5)#bfd echo
switch(config-if-Et5)#
```

### 14.7.4.5 bfd interval

The **bfd interval** command configures the BFD control packet transmission rate, minimum control packet receive rate, and the number of missed packets that will signal that the session is down. These parameters can be configured globally for the switch or for the configuration mode interface. If a parameter is configured both globally and on the interface, the value configured on the interface takes precedence.



**Note:** For a BFD session to be established, BFD must be enabled for any routing protocol using BFD for failure detection.

The **no bfd interval** and **default bfd interval** commands return the BFD parameters on the configuration mode interface to default values by removing the corresponding **bfd interval** command from **running-config**.

#### Command Mode

Global Configuration Interface-Ethernet Configuration Interface-Loopback Configuration Interface-Management Configuration Interface-Port-channel Configuration Interface-VLAN Configuration

#### Command Syntax

```
bfd interval transmit_rate min_rx receive_minimum multiplier factor
```

```
no bfd interval
```

```
default bfd interval
```

#### Parameters

- *transmit\_rate* rate in milliseconds at which control packets will be sent. Values range from 50 to 60000; the default value is 300.
- *receive\_minimum* rate in milliseconds at which control packets will be expected. Values range from 50 to 60000.
- *factor* number of consecutive missed BFD control packets after which BFD will declare the session as down. Values range from 3 to 50.

#### Examples

- These commands configure BFD on Ethernet interface 5 to expect packets from the peer every 200 milliseconds and declare the session down after failing to receive 5 consecutive packets. This configuration overrides any values configured globally.

```
switch(config)#interface ethernet 5
switch(config-if-Et5)#bfd interval 200 min_rx 200 multiplier 5
switch(config-if-Et5)#
```

---

#### 14.7.4.6 bfd local-address

The **bfd local-address** command specifies the local L3 address for use in Bidirectional Forwarding Detection (BFD). When configuring an L2 interface, specification of a local L3 address is required in order to run BFD per-link in RFC 7130 mode. (This is not necessary when configuring an L3 interface with an IP address configured on the port channel.)

The **no bfd local-address** and **default bfd local-address** commands remove the local L3 address by removing the corresponding **bfd local-address** command from **running-config**.

##### Command Mode

Global Configuration

##### Command Syntax

```
bfd local-address address
```

```
no bfd local-address [address]
```

```
default bfd local-address [address]
```

##### Parameters

*address* local IPv4 or IPv6 address for BFD.

##### Example

- This command specifies the local L3 address for BFD.

```
switch(config)#bfd local-address 10.0.0.4
switch(config)#
```



#### 14.7.4.7 bfd neighbor

The **bfd neighbor** command specifies the L3 address of the BFD neighbor of the port channel being configured. This is required to run BFD per-link in RFC 7130 mode. For an L2 port channel, this address should be the BFD per-link "local address" globally configured on the peer switch. For an L3 port channel, this address should be the IP address configured on the peer port channel.

The **no bfd neighbor** and **default bfd neighbor** commands remove the BFD neighbor address by removing the corresponding **bfd neighbor** command from **running-config**.

##### Command Mode

Interface-Port-channel Configuration

##### Command Syntax

```
bfd neighbor address
```

```
no bfd neighbor [address
```

```
default bfd neighbor [address
```

##### Parameters

*address* IPv4 or IPv6 address of the port channel's BFD neighbor.

##### Example

- These commands specify the L3 address of the port channel's BFD neighbor.

```
switch(config)#interface port-channel 5
switch(config-if-Po5)#bfd neighbor 10.0.0.5
switch(config-if-Po5)#
```

---

### 14.7.4.8 bfd per-link

The **bfd per-link** command enables the BFD per-link function on the port channel being configured. When BFD per-link is enabled, BFD sub-sessions are run on each link of the port channel; BFD considers the port-channel to be up as long as any one of the links is live.

BFD per-link runs by default in legacy mode, which allows downed links to remain members of the port channel and relies on LACP or other means to prune the dead links. Legacy mode is provided for interoperability with older switches.

RFC 7130 mode runs BFD per-link in full compliance with RFC 7130, and automatically removes links in down state from the port-channel, then adds them back again when they come up. Use the **rfc-7130** keyword to enable per-link in RFC 7130 mode. You must also configure an L3 BFD neighbor address for each port-channel running RFC 7130 per-link using the **bfd neighbor** command. When configuring an L2 interface, you must also globally configure a local L3 BFD address on the switch using the **bfd local-address** command.

For the BFD session to come up, both peers must be configured in the same way (either RFC-7130 or legacy mode).

The **no bfd per-link** and **default bfd per-link** commands disable the BFD per-link function by removing the corresponding **bfd per-link** command from **running-config**.

#### Command Mode

Interface-Port-channel Configuration

#### Command Syntax

```
bfd per-link [rfc-7130]
no bfd per-link [rfc-7130]
default bfd per-link [rfc-7130]
```

#### Example

- These commands enable the BFD per-link function in legacy mode on port channel 5.

```
switch(config)#interface port-channel 5
switch(config-if-Po5)#bfd per-link
switch(config-if-Po5)#
```

- These commands globally specify a local L3 BFD address for the switch, enable the BFD per-link function in RFC 7130 mode on port channel 5, and specify the L3 address of the port channel's BFD neighbor.

```
switch(config)#bfd local-address 10.0.0.5
switch(config)#interface port-channel 5
switch(config-if-Po5)#bfd per-link rfc-7130
switch(config-if-Po5)#bfd neighbor 10.0.0.4
switch(config-if-Po5)#
```

### 14.7.4.9 bfd slow-timer

The **bfd slow-timer** command configures the minimum reception rate for BFD control packets which will be used if the BFD echo function is enabled. The default value is 2000 milliseconds.



**Note:** For a BFD session to be established, BFD must be enabled for any routing protocol using BFD for failure detection.

The **no bfd slow-timer** and **default bfd slow-timer** commands return the BFD slow-timer to the default value of 2000 milliseconds by removing the corresponding **bfd interval** command from **running-config**.

#### Command Mode

Global Configuration

#### Command Syntax

```
bfd slow-timer receive_minimum
```

```
no bfd slow-timer
```

```
default bfd slow-timer
```

#### Parameters

- *receive\_minimum* rate in milliseconds at which control packets will be expected when the BFD echo function is enabled. Values range from 2000 to 60000; default value is 2000.

#### Examples

- This command configures BFD to expect control packets from the peer every 10000 milliseconds when the BFD echo function is enabled.

```
switch(config)#bfd slow-timer 10000
switch(config)#
```

---

#### 14.7.4.10 hardware acceleration disabled

Hardware acceleration is enabled by default on supported platforms and no explicit configuration is needed. Use the **hardware acceleration disabled** command to disable hardware acceleration.

##### Command Mode

BFD configuration mode

##### Command Syntax

```
hardware acceleration disabled
```

##### Example

```
switch(config-router-bfd)#hardware acceleration disabled
```

#### 14.7.4.11 ip ospf neighbor bfd

The **ip ospf neighbor bfd** command enables Bidirectional Forwarding Detection (BFD) for the open shortest path first protocol (OSPF) on the configuration mode interface regardless of the global settings for the OSPF instance. All OSPF neighbors associated with the interface become BFD peers, and OSPF uses BFD for failure detection.

For OSPF BFD to function on an interface, BFD must also be enabled and configured on that interface using the **bfd interval** command.

The **no ip ospf neighbor bfd** command disables OSPF BFD on the interface and terminates all BFD sessions with the interface OSPF peers. The **default ip ospf neighbor bfd** command causes the interface to follow global OSPF BFD settings configured by the **bfd default (OSPF)** command.

##### Command Mode

Interface-Ethernet Configuration Interface-Port-Channel Configuration Interface-VLAN Configuration

##### Command Syntax

```
ip ospf neighbor bfd
```

```
no ip ospf neighbor bfd
```

```
default ip ospf neighbor bfd
```

##### Example

- These commands enable BFD on Ethernet interface 3/20.

```
switch(config)#interface ethernet 3/20
switch(config-if-Et3/20)#ip ospf neighbor bfd
switch(config-if-Et3/20)#
```

- These commands cause Ethernet interface 3/20 to follow the global OSPF BFD configuration.

```
switch(config)#interface ethernet 3/20
switch(config-if-Et3/20)#default ip ospf neighbor bfd
switch(config-if-Et3/20)#
```

---

#### 14.7.4.12 isis bfd

The **isis bfd** command activates the corresponding IS-IS routing instance on the configuration mode interface. By default, the IS-IS routing instance is not enabled on an interface.

The **no isis enable** and **default isis enable** commands disable IS-IS on the configuration mode interface by removing the corresponding **isis enable** command from **running-config**.

##### Command Mode

Interface-Ethernet Configuration

##### Command Syntax

```
isis bfd
```

```
no isis bfd
```

```
default isis bfd
```

##### Examples

- These commands enable BFD on IS-IS interfaces.

```
switch(config)#interface Ethernet 5/6
switch(config-if-Et5/6)#isis bfd
switch(config-if-Et5/6)#
```

### 14.7.4.13 neighbor bfd

The **neighbor bfd** command enables Bidirectional Forwarding Detection (BFD) for use as a failure detection mechanism for border gateway protocol (BGP) connections to the specified BGP neighbor or peer group.

Once a BFD session is established with a BGP neighbor, if the BFD session goes down the status of the BGP session is changed to down as well.

The **no neighbor bfd** and **default neighbor bfd** commands disable BFD for BGP connections to the specified neighbor or peer group by removing the corresponding **neighbor bfd** command from **running-config**.

#### Command Mode

Router-BGP Configuration

#### Command Syntax

```
neighbor NEIGHBOR_ID bfd
```

```
no neighbor NEIGHBOR_ID bfd
```

```
default neighbor NEIGHBOR_ID bfd
```

#### Parameters

- NEIGHBOR\_ID IP address or peer group name. Values include:
  - *ipv4\_addr* neighbor IPv4 address.
  - *ipv6\_addr* neighbor IPv6 address.
  - *group\_name* peer group name.

#### Example

- These commands enable BFD failure detection for BGP connections with the neighbor at 10.13.64.1.

```
switch(config)#router bgp 300
switch(config-router-bgp)#neighbor 10.13.64.1 bfd
switch(config-router-bgp)#
```

---

#### 14.7.4.14 pim ipv4 bfd

The `pim ipv4 bfd` command enables Bidirectional Forwarding Detection (BFD) on the configuration mode interface as a failure detection mechanism for Protocol-Independent Multicast Sparse-Mode (PIM-SM). To enable PIM BFD globally on the switch, use the [bfd \(Router-PIM Sparse-mode\)](#) command. Interface-level settings override the global setting.

When PIM BFD is enabled, a BFD session is created for each PIM-SM neighbor and used to detect a loss of connectivity with the neighbor. PIM-SM hello packets are still exchanged with PIM-SM neighbors when BFD is enabled.

The `no pim ipv4 bfd` disables PIM BFD on the configuration mode interface regardless of global settings. The `default pim ipv4 bfd` command causes the configuration mode interface to follow the global setting for PIM BFD by removing the corresponding `pim ipv4 bfd` statement from `running-config`.

##### Command Mode

Interface-Ethernet Configuration Interface-Port-Channel Configuration Interface-VLAN Configuration

##### Command Syntax

```
pim ipv4 bfd
```

```
no pim ipv4 bfd
```

```
default pim ipv4 bfd
```

##### Example

- These commands configure VLAN interface 200 to use BFD for PIM-SM connection failure detection regardless of the global PIM BFD configuration.

```
switch(config)#interface vlan 200
switch(config-if-VL200)#pim ipv4 bfd
switch(config-if-VL200)#
```



#### 14.7.4.15 show bfd hardware acceleration

The `show bfd hardware acceleration` command displays the status of hardware acceleration on the switch for Bidirectional Forwarding Detection (BFD) session. The `show bfd peers detail` command displays the status of hardware acceleration.

##### Command Mode

EXEC

##### Command Syntax

```
show bfd hardware acceleration
```

This command displays the status for hardware acceleration for BFD.

```
switch#show bfd hardware acceleration
Output when hardware acceleration is enabled(default) and running
Hardware acceleration is running
```

Output when hardware acceleration is disabled with explanation

```
Hardware acceleration is not running:
user disabled, no eligible sessions, not supported with SSO
```

Output when hardware acceleration is not supported by switch

```
Hardware acceleration is not supported
```

#### 14.7.4.16 show bfd hardware utilization

The `show bfd hardware utilization` command displays the status of hardware acceleration on the switch for Bidirectional Forwarding Detection (BFD) session.

##### Command Mode

EXEC

##### Command Syntax

```
show bfd hardware utilization [INFO_LEVEL]
```

##### Parameters

- `INFO_LEVEL` amount of information that is displayed. Options include:
  - **<no parameter>** command displays a summary of offloaded discriminators per ASIC.
  - **detail** command displays details of the BFD discriminators whose transmit path is offloaded per ASIC.

This command displays a summary of offloaded discriminators per ASIC for BFD.

```
switch#show bfd hardware utilization
Chip Name Number Of Sessions Maximum Number Of
Sessions

Jericho0 20
 200
Jericho1 0
 200
```

This command displays a details list of offloaded discriminators per ASIC for BFD.

```
switch#show bfd hardware utilization detail
sh bfd hardware utilization detail
Chip: Jericho0
Dst Addr My Disc Interface VRF
Type

1.1.6.2 3175653802 Ethernet1/1 default
normal
1.1.3.2 1151992021 Ethernet2/1 default
normal

Chip: Jericho1
Dst Addr My Disc Interface VRF Type

```

### 14.7.4.17 show bfd peers

The **show bfd peers** command displays information about the neighbors with which the switch currently has a Bidirectional Forwarding Detection (BFD) session.

#### Command Mode

EXEC

#### Command Syntax

```
show bfd peers [INFO_LEVEL]
```

#### Parameters

- **INFO\_LEVEL** amount of information that is displayed. Options include:
  - <no parameter> command displays data block for each specified interface.
  - detail command displays table that summarizes interface data.
  - summary displays the summary of the interface.
- **Display Values**
  - **DstAddr** IP address of the BFD neighbor.
  - **MyDisc** Local discriminator value of the BFD session.
  - **YoDisc** Neighbor's discriminator value for the BFD session.
  - **If** Interface to which the neighbor is connected.
  - **LUp** Last up.
  - **LDown** Last down.
  - **Ldiag** Diagnostic for the last change in session state.
  - **State** State of the BFD session.
  - **TxInt** Transmit interval of the local interface.
  - **RxInt** Minimum receive interval set on the local interface.
  - **Multiplier** Local multiplier (number of packets that must be missed to declare session down).
  - **Received RxInt** Minimum receive interval set on the neighbor interface.
  - **Received Multiplier** Neighbor's multiplier (number of packets that must be missed to declare session down).
  - **Rx Count** BFD control packets transmitted.
  - **Tx Count** BFD control packets received.
  - **Detect** Time Total time in milliseconds it takes for BFD to detect connection failure.
  - **Registered Protocols** Protocols using BFD with this neighbor.
- **Examples**
- This command displays general information about BFD neighbors.

```
switch>show bfd peers
DstAddr MyDisc YoDisc If LUp LDown Ldiag S
tate
10.168.1.56 16 13 et52_1(81) 17151450 0 No
Diagnostic Up
10.168.1.58 17 14 et52_2(65) 17151883 0 No
Diagnostic Up
10.168.1.24 18 15 et51_1(73) 17152175 0 No
Diagnostic Up
10.168.254.6 19 12 vlan4094(26) 17152336 0 No
Diagnostic Up
10.168.1.26 20 16 et51_2(57) 17152523 0 No
Diagnostic Up
10.168.1.40 21 12 et50_1(77) 17152966 0 No
Diagnostic Up
10.168.1.42 22 13 et50_2(61) 17153488 0 No
Diagnostic Up
```

```

10.168.1.8 27 55 et49_1(69) 26710447 0 No
Diagnostic Up
10.168.1.10 28 56 et49_2(53) 26710847 0 No
Diagnostic Up

```

- This command displays detailed information about BFD neighbors.

```

switch>show bfd peers detail
Peer Addr 10.168.1.56, Intf Ethernet52/1, State Up
VRF default, LAddr 10.168.1.57, LD/RD 16/13
Last Up 17151450
Last Down 0
Last Diag: No Diagnostic
TxInt: 300, RxInt: 300, Multiplier: 3
Received RxInt: 300, Received Multiplier: 3
Rx Count: 433987, Tx Count: 433829
Detect Time: 900
Registered protocols: bgp

Peer Addr 10.168.1.58, Intf Ethernet52/2, State Up
VRF default, LAddr 10.168.1.59, LD/RD 17/14
Last Up 17151883
Last Down 0
Last Diag: No Diagnostic
TxInt: 300, RxInt: 300, Multiplier: 3
Received RxInt: 300, Received Multiplier: 3
Rx Count: 434235, Tx Count: 434050
Detect Time: 900
Registered protocols: bgp
switch>

```

- This command displays the currently-configured BFD telemetry interval.

```

switch #show bfd peers summary
Global administrative shutdown: No
Configured session stats snapshot interval 10s
BFD:
Configured global single hop interval 300ms min_rx 300ms multiplier 3
Configured global multiple hop interval 300ms min_rx 300ms multiplier 3
Slow timer: 2000ms
SBFD:
IPv4 operational state: globally disabled (Local interface is not
 configured)
Configured global initiator tx interval 300ms multiplier 3
Configured reflector rx interval 300ms

```

Legend:

\*: pseudo LAG session (not counted in total sessions)

<N>[<M>]: Number of sessions [ Number of sessions with echo enabled ]

| Addressing     | Type          | Up    | Init  |
|----------------|---------------|-------|-------|
| Down AdminDown |               |       |       |
| All            | All           | 1 [0] | 0 [0] |
| [0] 0 [0]      |               |       | 0     |
| IPv4           | All           | 1 [0] | 0 [0] |
| [0] 0 [0]      |               |       | 0     |
| single hop     | All           | 1 [0] | 0 [0] |
| [0] 0 [0]      |               |       | 0     |
|                | normal        | 1 [0] | 0 [0] |
| [0] 0 [0]      |               |       | 0     |
|                | LAG RFC7130 * | 0 [0] | 0 [0] |
| [0] 0 [0]      |               |       | 0     |
|                | micro RFC7130 | 0 [0] | 0 [0] |
| [0] 0 [0]      |               |       | 0     |

|              |       |                |       |       |   |
|--------------|-------|----------------|-------|-------|---|
| [0]          | 0 [0] | LAG per-link * | 0 [0] | 0 [0] | 0 |
| [0]          | 0 [0] | micro per-link | 0 [0] | 0 [0] | 0 |
| [0]          | 0 [0] | multi-hop      | 0 [0] | 0 [0] | 0 |
| [0]          | 0 [0] | multi-hop      | 0 [0] | 0 [0] | 0 |
| IPv6         | 0 [0] | All            | 0 [0] | 0 [0] | 0 |
| [0]          | 0 [0] | single hop     | 0 [0] | 0 [0] | 0 |
| [0]          | 0 [0] | single hop     | 0 [0] | 0 [0] | 0 |
| [0]          | 0 [0] | normal         | 0 [0] | 0 [0] | 0 |
| [0]          | 0 [0] | LAG RFC7130 *  | 0 [0] | 0 [0] | 0 |
| [0]          | 0 [0] | LAG RFC7130 *  | 0 [0] | 0 [0] | 0 |
| [0]          | 0 [0] | micro RFC7130  | 0 [0] | 0 [0] | 0 |
| [0]          | 0 [0] | LAG per-link * | 0 [0] | 0 [0] | 0 |
| [0]          | 0 [0] | LAG per-link * | 0 [0] | 0 [0] | 0 |
| [0]          | 0 [0] | micro per-link | 0 [0] | 0 [0] | 0 |
| [0]          | 0 [0] | multi-hop      | 0 [0] | 0 [0] | 0 |
| [0]          | 0 [0] | multi-hop      | 0 [0] | 0 [0] | 0 |
| Tunnel       | 0 [0] | VXLAN          | 0 [0] | 0 [0] | 0 |
| [0]          | 0 [0] | VXLAN          | 0 [0] | 0 [0] | 0 |
| L2           | 0 [0] | LAG RFC7130 *  | 0 [0] | 0 [0] | 0 |
| [0]          | 0 [0] | LAG RFC7130 *  | 0 [0] | 0 [0] | 0 |
| [0]          | 0 [0] | micro RFC7130  | 0 [0] | 0 [0] | 0 |
| [0]          | 0 [0] | micro RFC7130  | 0 [0] | 0 [0] | 0 |
| SR-TE Tunnel | 0 [0] | All            | 0     | 0     | 0 |
| 0            | 0     | All            | 0     | 0     | 0 |
| IPv4         | 0     | Initiator      | 0     | 0     | 0 |
| 0            | 0     | Initiator      | 0     | 0     | 0 |
| 0            | 0     | Reflector      | 0     | 0     | 0 |
| 0            | 0     | Reflector      | 0     | 0     | 0 |
| IPv6         | 0     | Initiator      | 0     | 0     | 0 |
| 0            | 0     | Initiator      | 0     | 0     | 0 |
| 0            | 0     | Reflector      | 0     | 0     | 0 |
| 0            | 0     | Reflector      | 0     | 0     | 0 |

---

### 14.7.4.18 show bfd peers detail

Use the **show bfd peers detail** to display whether an individual session is hardware accelerated or not. An extra line has been added to to highlight hardware acceleration.

#### Command Mode

EXEC

#### Command Syntax

```
show bfd peers detail
```

#### Parameters

**detail** Displays a comprehensive view of the individual session.

#### Guidelines

- **Async On** Denotes the Asynchronous Transmit component of the session has been offloaded.
- **Echo On** Denotes the Echo Transmit function of the session has been offloaded.

 **Note:** There is no guarantee that both the Asynchronous transmit component and the echo function are offloaded to hardware together.

#### Example

```
switch#show bfd peers detail
VRF name: default

Peer Addr 10.0.0.2, Intf Ethernet3/1/1, Type normal, State Down
VRF default, LAddr 0.0.0.0, LD/RD 1157402594/0
Session state is Down and not using echo function
Hardware Acceleration: Async On, Echo On
...
```

### 14.7.4.19 session stats snapshot interval (BFD)

The **session stats snapshot interval** enables the BFD session telemetry on a switch. By default, this command is disabled and the telemetry interval is set to zero seconds. A telemetry interval between 10 and 3600 seconds may be configured. A telemetry interval may be configured to a value less than 10 seconds and as small as 1 second using an additional keyword **dangerous**.



**Note:** Configurations including a telemetry interval of less than 10 seconds are not advised for systems with a large-scale BFD deployment as this may cause delays in the rbfd kernel module and result in BFD session instability.

The **no session stats snapshot interval** and **default session stats snapshot interval** commands disables the BFD telemetry command from the **running-config** and sets the telemetry interval is set to zero..

#### Command Mode

Router BFD Configuration

#### Command Syntax

```
session stats snapshot interval timer_intervaldangerous
```

```
no session stats snapshot interval
```

```
default session stats snapshot interval
```

#### Parameters

- *timer\_interval* Session statistics timer interval in seconds between 10-3600.
- *dangerous* Set session statistics timer interval less than 10 seconds.

#### Examples

- The following commands places the switch in router BFD mode and enables the BFD session telemetry. In this example a BFD telemetry session with a time interval of 10 seconds is configured.

```
switch(config)#router bfd
switch(config-router-bfd)#session stats snapshot interval 10
```

- In this example a BFD telemetry session with a time interval of 1 seconds is configured using a keyword "dangerous".

```
switch(config-router-bfd)#session stats snapshot interval dangerous 1
```

#### 14.7.4.20 vrrp bfd ip

The **vrrp bfd ip** command enables and configures Bidirectional Forwarding Detection (BFD) for virtual router redundancy protocol (VRRP) on the configuration mode interface.

When enabled, BFD provides failure detection for a 2-router VRRP system. When the master is configured with the physical IP address of the backup router, and the backup is configured with the address of the master, a BFD session is established between them. If the BFD session goes down, the backup router immediately assumes the master role.

VRRP master advertisement packets are still sent even when the BFD session is established to accommodate VRRP systems involving more than two routers.

The **no vrrp bfd ip** and **default vrrp bfd ip** commands disable BFD for VRRP on the configuration mode interface by removing the corresponding **vrrp bfd ip** statement from **running-config**. The **no vrrp** command also removes the **vrrp bfd ip** command for the specified virtual router.

#### Command Mode

Interface-Ethernet Configuration

Interface-Port-Channel Configuration

Interface-VLAN Configuration

#### Command Syntax

```
vrrp group bfd ip ipv4_address
```

```
no vrrp group bfd ip
```

```
default vrrp group bfd ip
```

#### Parameters

- *group* virtual router identifier (VRID). Values range from 1 to 255.
- *ipv4\_address* IPv4 address of the other VRRP router. On the master router, enter the physical IP address of the backup; on the backup, enter the physical IP address of the master.

#### Example

- These commands enable BFD on Ethernet interface 3/20 for VRRP ID 15 with a connection to a router at IP address 192.168.2.1.

```
switch(config)#interface ethernet 3/20
switch(config-if-Et3/20)#vrrp 15 bfd ip 192.168.2.1
switch(config-if-Et3/20)#
```



## Multicast

---

IP multicast is the transmission of data packets to multiple hosts through a common IP address. Sections covered in this chapter include:

- [Multicast Architecture](#)
- [IGMP and IGMP Snooping](#)
- [Protocol Independent Multicast](#)
- [Multicast Source Discovery Protocol \(MSDP\)](#)
- [Audio Video Bridging \(AVB\)](#)

### 15.1 Multicast Architecture

IP multicast is the transmission of data packets to multiple hosts through a common IP address. Arista switches support multicast transmissions through IGMP, IGMP Snooping, and PIM-SM. These topics describe the Arista multicast architecture.

- [Overview](#)
- [Multicast Architecture Description](#)
- [Multicast Listener Discovery \(MLD\)](#)
- [MLDv2 Snooping](#)
- [Multicast Route Counters](#)
- [Multicast \(S,G\) Counters](#)
- [Static IP Mroute](#)
- [Static Multicast](#)
- [Configuring Multicast](#)
- [Multicast Commands](#)

#### 15.1.1 Overview

Arista switches provide layer 2 multicast filtering and layer 3 routing features for applications requiring IP multicast services. The switches support over a thousand separate routed multicast sessions at wire speed without compromising other layer 2/3 switching features. Arista switches support IGMP, IGMP snooping, PIM-SM, and MSDP to simplify and scale data center multicast deployments.

##### Supported Features

Feature support varies by platform; consult the release notes for multicast support information by platform.

Multicast and unicast use the same routing table. Unicast routes use TCAM resources, which may also impact the maximum number of multicast routes.

##### Features Not Supported

The multicast functions not supported by Arista switches include (\*,\*,G) forwarding or boundary routers, multicast MIBs, and router applications joining multicast groups.

## 15.1.2 Multicast Architecture Description

IP multicast is data transmission to a subset of all hosts through a single multicast group address. Multicast packets are delivered using best-effort reliability, similar to unicast packets. Senders use the multicast address as the destination address. Any host, regardless of group membership, can send to a group. However, only group members receive messages sent to a group address.

IP multicast addresses range from 224.0.0.0 to 239.255.255.255. Multicast routing protocol control traffic reserves the address range 224.0.0.0 to 224.0.0.255. The address 224.0.0.0 is never assigned to any group.

Multicast group membership is dynamic; a groups activity level and membership can vary over time. A host can also simultaneously belong to multiple multicast groups.

Multicast Architecture depicts the components that comprise the multicast architecture. The remainder of this section describes the multicast components depicted in the figure.

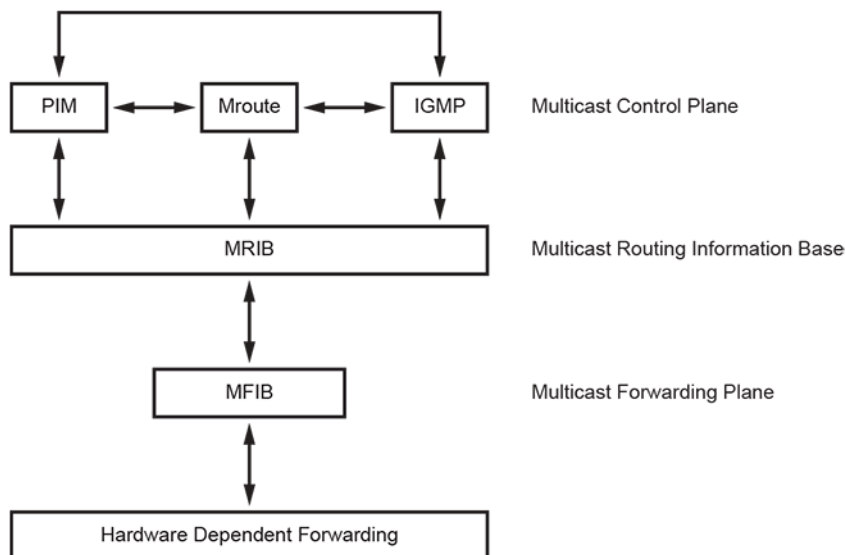

**Figure 61: Multicast Architecture**

### 15.1.2.1 Multicast Control Plane

The multicast control plane builds and maintains multicast distribution trees. It communicates changes in the multicast routing table to the MFIB for multicast forwarding.

- Protocol Independent Multicast (PIM) builds and maintains multicast routing trees using reverse path forwarding (RPF) on a unicast routing table.
- Internet Group Management Protocol (IGMP) identifies multicast group members on subnets directly connected to the switch. Hosts manage multicast group membership with IGMP messages.
- The switch maintains an mroute (multicast routing) table when running PIM to provide forwarding tables used to deliver multicast packets.

The mroute table stores the states of inbound and outbound interfaces for each source/group pair (S,G). The switch discards and forwards packets on the basis of this state information. Each table entry, referred to as an mroute, corresponds to a unique (S,G) and contains:

- the multicast group address
- the multicast source address (or \* for all sources)
- the inbound interface
- a list of outbound interfaces

### 15.1.2.2 Multicast Routing Information Base (MRIB)

The MRIB is the channel between multicast control plane clients and the multicast forwarding plane. The `show ip mroute` command displays MRIB entries as (\*, G), (S, G), and (\*, G/m) multicast entries.

MRIB entries are based on source, group, and group masks. The entries are associated with a list of interfaces whose forwarding state is described with flags. MRIB communication is based on the state change of entry and interface flags. Flags are significant to MRIB clients but are not interpreted by the MRIB.

### 15.1.2.3 Multicast Forwarding Plane

The multicast forwarding plane consists of the multicast forwarding information base (MFIB), a forwarding engine that is independent of multicast routing protocols.

MFIB formats PIM and IGMP multicast routes for protocol-independent hardware packet forwarding and adds them to the hardware multicast expansion table (MET) and the hardware FIB.

MFIB uses a core forwarding engine for interrupt-level (fast switching) and process-level (process switching) forwarding. MFIB fast-switches inbound multicast packets that match an MFIB forwarding entry and process-switches packets requiring a forwarding entry if a matching entry does not exist.

### 15.1.2.4 Hardware Dependent Forwarding and Fast Drop

In IP multicast protocols, each (S,G) and (\*,G) route corresponds to an inbound reverse path forwarding (RPF) interface. Packets arriving on non-RPF interfaces may require PIM processing, as performed by the CPU subsystem software.

By default, hardware sends all packets arriving on non-RPF interfaces to the CPU subsystem software. However, the CPU can be overwhelmed by non-RPF packets that do not require software processing. The CPU subsystem software prevents CPU overload by creating a fast-drop entry in hardware for inbound non-RPF packets not requiring PIM processing. Packets matching a fast-drop entry are bridged in the ingress VLAN but not sent to the software, avoiding CPU subsystem software overload. Fast-drop entry usage is critical in topologies with persistent RPF failures.

Protocol events, such as links going down or unicast routing table changes, can change the set of packets that can be fast dropped. Packets that were correctly fast dropped before a topology change may require forwarding to the CPU subsystem software after the change. The CPU subsystem software handles fast-drop entries that respond to protocol events so that PIM can process all necessary non-RPF packets.

## 15.1.3 Multicast Listener Discovery (MLD)

Networks use Multicast Listener Discovery (MLD) to control the flow of layer 3 IPv6 multicast traffic. Hosts request and maintain multicast group membership through MLD messages. Multicast routers use MLD to maintain a membership list of active multicast groups for each attached network.

With respect to each of its attached networks, a multicast router is either a querier or non-querier. Each physical network contains only one querier. A network with more than one multicast router designates the router with the lowest IP address as its querier.

In an MLD Report or Done message, the multicast address field holds a specific IPv6 multicast address to which the message sender is listening or is ceasing to listen, respectively.

### 15.1.3.1 Platform Compatibility

- 7280R
- 7500R

---

### 15.1.3.2 MLDv2 Snooping

MLDv2 Snooping optimizes the transmission of multicast packets in Layer 2 by using Layer 3 information contained in MLDv2 and PIM packets. MLDv2 is the protocol used to manage the membership of hosts in multicast groups for IPv6.

**RFC 3810** talks about MLDv2 functionality. MLDv2 is the IPv6 counterpart of IGMPv3. Beginning with **EOS Release 4.25.0F**, MLDv2 snooping is supported on MLAG deployments.

#### 15.1.3.2.1 Platform Compatibility

The following platforms support MLDv2 snooping:

- DCS-7020R
- DCS-7280R
- DCS-7280R2
- DCS-7500R
- DCS-7500R2

#### 15.1.3.2.2 Limitations

- Extraneous “Switch” interface should be ignored in **show mld snooping counters** and **show mld snooping counters errors** command outputs.
- MLDv2 Snooping with EVPN is not supported.

### 15.1.3.3 Configuring Multicast Listener Discovery

#### 15.1.3.3.1 Enabling MLD

Use **mld** command to enable MLD on an interface. When the switch fills the multicast routing table, it only adds interfaces when the interface receives join messages from downstream devices or when the interface is directly connected to a member of the MLD group. By default, MLD is disabled on an interface.

#### Examples

- This command enables MLD on the Ethernet interface 1.

```
switch(config)#interface Ethernet 1
switch(config-if-Et1)#mld
```

- This command disables MLD on the Ethernet interface 1.

```
switch(config)#interface Ethernet1
switch(config-if-Et1)#no mld
```

#### 15.1.3.3.2 Configuring MLD

An interface that runs MLD uses default protocol settings unless otherwise configured. The switch provides commands that alter startup query, last member query, and normal query settings.

#### MLD

The switch supports MLD versions 1 through 2. The **mld** command configures multicast routers on the configuration mode interface. Version 2 is the default MLD version.

## Example

- This command enables MLD on the Ethernet interface 1.

```
switch(config)#interface Ethernet 1
switch(config-if-Et1)#mld
```

## Startup Query

Membership queries are sent at an increased frequency immediately after an interface starts up to quickly establish the group state. Query count and query interval commands adjust the period between membership queries for a specified number of messages.

The `mld startup-query-interval` command specifies the interval between membership queries that an interface sends immediately after it starts up. The `mld startup-query-count` command specifies the number of queries that the switches sends from the interface at the startup interval rate.

## Examples

- This command configures the startup query count of 4 on an Ethernet interface 1.

```
switch(config)#interface Ethernet1
switch(config-if-Et1)#mld startup-query-count 4
```

- This command configures the startup query interval of 100 seconds on an Ethernet interface 1.

```
switch(config)#interface Ethernet1
switch(config-if-Et1)#mld startup-query-interval 100
```

## Membership Queries

The router with the lowest IP address on a subnet sends membership queries as the MLD querier. When a membership query is received from a source with a lower IP address, the router resets its query response timer. Upon timer expiry, the router begins sending membership queries. If the router subsequently receives a membership query originating from a lower IP address, it stops sending membership queries and resets the query response timer.

The `mld query-interval` command configures the frequency at which the active interface, as an MLD querier, sends membership query messages.

The `mld query-response-interval` command configures the time that a host has to respond to a membership query.

## Examples

- This command configures the query interval of 30 seconds on an Ethernet interface 1.

```
switch(config)#interface Ethernet1
switch(config-if-Et1)#mld query-interval 30
```

- This command configures the query response interval of 30 seconds on an Ethernet interface 1.

```
switch(config)#interface Ethernet1
switch(config-if-Et1)#mld query-response-interval 30
```

## Last Member Query

When the querier receives an MLD leave message, it verifies the group has no remaining hosts by sending a set of group-specific queries at a specified interval. If the querier does not receive a response to the queries, it removes the group state and discontinues multicast transmissions.

---

The `mld last-listener-query-count` command specifies the number of query messages the router sends in response to a group-specific or group-source-specific leave message.

The `mld last-listener-query-interval` command configures the transmission interval for sending group-specific or group-source-specific query messages to the active interface.

### Examples

- This command configures the last listener query count to 3 on an Ethernet interface 1.

```
switch(config)#interface Ethernet 1
switch(config-if-Et1)#mld last-listener-query-count 3
```

- This command configures the last listener query interval to 2 seconds on an Ethernet interface 1.

```
switch(config)#interface Ethernet1
switch(config-if-Et1)#mld last-listener-query-interval 2
```

### Static Groups

The `mld static-group` command configures the configuration mode interface as a static member of the multicast group at the specified address. The router forwards multicast group packets through the interface without otherwise appearing or acting as a group member. No interface is a static member of a multicast group by default.

### Example

- This command configures static groups on an interface Ethernet 1.

```
switch(config)#interface Ethernet1
switch(config-if-Et1)#mld static-group ff30::1 a::1
```

## 15.1.3.4 MLDv2 Snooping Configuration

### 15.1.3.4.1 Enabling or Disabling MLDv2 Snooping

You can configure MLDv2 snooping globally and per VLAN. A configuration mode is available for MLD related snooping commands in the *global configuration mode*.

#### Example

```
switch(config)#mld snooping
switch(config-mld-snooping)#disabled
switch(config-mld-snooping)#vlan 1-100
switch(config-mld-snooping)#vlan 101
switch(config-mld-snooping-vlan-101)#disabled
```

Items to consider:

- You must explicitly configure VLANs inside the mld-snooping configuration mode to enable snooping for those VLANs.
- Use the global **disabled** to disable the mld-snooping for all VLANs. **disabled** is *not* configured by default.
- Snooping can be explicitly **disabled** for a given VLAN. This is useful once there is configuration within the VLAN. **disabled** is not configured by default.

- Snooping cannot be explicitly enabled for a given VLAN if it is disabled globally.
- Beginning with the ***EOS Release 4.25.0F***, it allows the configuration of MLDvs snooping on PIM non DR (Designated Router) VLANs.

#### 15.1.3.4.2 Static Groups and Multicast Router

To configure static groups, refer to the following commands:

```
switch(config)#mld snooping
switch(config-mld-snooping)#vlan 100
switch(config-mld-snooping-vlan-100)#member ipv6-group-addr
interface intfs
```

To configure a static multicast router, refer to the following commands:

```
switch(config)#mld snooping
switch(config-mld-snooping)#vlan 100
switch(config-mld-snooping-vlan-100)#multicast-router
interface intfs
```

In the examples above, *intfs* can be a group of similar interfaces (for example, ***Ethernet1-5,8*** or ***port-channel 1-5,8***).

#### 15.1.3.5 Displaying MLDv2 Snooping Status

The following show commands display the MLD snooping status of the switch:

- ```
switch#show mld snooping
      Global MLD Snooping configuration:
      -----
      MLD snooping                : Enabled
      Robustness variable         : 2

      VLAN 1 :
      -----
      MLD snooping                : Disabled
      MLD max group limit         : No limit set
      Recent attempt to exceed limit : No
      MLD snooping pruning active  : False
      Flooding traffic to VLAN    : True
      VLAN 100 :
      -----
      MLD snooping                : Enabled
      MLD max group limit         : No limit set
      Recent attempt to exceed limit : No
      MLD snooping pruning active  : True
      Flooding traffic to VLAN    : False
```
- ```
switch#show mld snooping
 Global MLD Snooping configuration:

 MLD snooping : Enabled
 Robustness variable : 2
```

```

VLAN 1 :

MLD snooping : Disabled
MLD max group limit : No limit set
Recent attempt to exceed limit : No
MLD snooping pruning active : False
Flooding traffic to VLAN : True
VLAN 100 :

MLD snooping : Enabled
MLD max group limit : No limit set
Recent attempt to exceed limit : No
MLD snooping pruning active : True
Flooding traffic to VLAN : False

```

- Use the **show mld snooping groups** command to display MLDv2 snooping by group.

```

switch#show mld snooping groups
IGMP Snooping Group Membership
EX : Filter mode Exclude
IN : Filter mode Include
IR : Ingress Replication
VLAN Group Members
---- -
100 ff05::2 Cpu, Et4
100 ff08::11 Et1
100 ff08::21 Et2
100 ff08::31 Et3
100 * Et3, Et4

```

- Use the **show mld snooping groups detail** command to display detailed MLDv2 snooping information.

```

switch(config-mld-snooping-vlan-100)#show mld snooping groups detail
IGMP Snooping Group Membership
EX : Filter mode Exclude
IN : Filter mode Include
IR : Ingress Replication
VLAN Group Source Mode Uptime Members
---- -
100 ff05::2 * - 0d00h13m20 Cpu, Et4
100 ff08::11 * - 0d00h13m17 Et1
100 ff08::21 1::1 IN 0d00h13m20 Et2
100 ff08::31 2::1 EX 0d00h01m31 Et3
100 * * - - Et3, Et4

```

“show mld snooping groups” output can be further filtered to output just the

- **local** groups, that is groups learned locally using the **show mld snooping groups local** command.
- **user** groups, that is groups configured by user.
- **mLAG** groups, that is groups learned from the MLAG peer.

```

switch#show mld snooping mrouter
Vlan Interface-ports

100 Et3(dynamic), Et4(static)

```

- **show mld snooping mrouter detail**
- ```

Vlan  Intf      Address          FirstHeard      LastHeard      Expires
Type

```



```

-----
100    Et3      fe80::200:3ff:fe01:0 0d00h24m30 0d00h00m08 00h00m17
querier
100    Et4      fe80::200:3ff:fe03:0 0d00h24m10 0d00h00m08 00h01m37
pim
100    Et2      0.0.0.0             -           -           -
static

```

- switch##**show mld snooping mrouter vlan 100**

```

Vlan    Interface-ports
-----
100     Et2(static), Et3(dynamic), Et4(dynamic)

```

- switch#**show mld snooping querier**

```

Vlan  IP Address          Version  Port
-----
100   fe80::200:3ff:fe01:0  v2      Et3

```

- switch#**show mld snooping querier vlan 100**

```

IP Address      : fe80::200:3ff:fe01:0
MLD Version     : v2
Port            : Et3
Max response time : 10.0

```

- switch#**show mld snooping counters**

```

          Input          |          Output
Port  Queries Reports  Others  Errors|Queries Reports  Others
-----
Cpu           1    153      0       0   154     6    51
Et1           0    153      0       0   156     0    51
Et2           0    153      0       0   156   110    51
Et3          154     1       0       0     1   610    51
Et4           0    152     51       0   155   453     0
Switch        0     0       0       0     0     0     0

```

- switch#**show mld snooping counters errors**

```

          Packet          Packet  Bad IP  Unknown  Bad PIM  Bad
ICMP  Bad MLD  Bad MLD
Port  Checksum Too Short  Not IP  Checksum  IP Protocol  Checksum
Checksum Query    Report
-----
Cpu           0       0       0       0       0       0
0           0       0
Et1           0       0       0       0       0       0
0           0       0
Et2           0       0       0       0       0       0
0           0       0
Et3           0       0       0       0       0       0
0           0       0
Et4           0       0       0       0       0       0
0           0       0
Switch        0       0       0       0       0       0
0           0       0

```

15.1.4 Multicast Route Counters

Multicast Route Counters provides per multicast route ingress packet and byte counters for multicast routed packets.

15.1.4.1 Platform Compatibility

The following platforms support Multicast Route Counters:

- DCS-7020R
- DCS-7020TR
- DCS-7280TR
- DCS-7280R/R2/R3 (R3 beginning with **EOS Release 4.23.1F**)
- DCS-7500R/R2/R3 (R3 beginning with **EOS Release 4.23.1F**)

15.1.4.2 Configuration

To enable multicast route ingress packet and byte counters use the following command:

```
switch(config)#hardware counter feature multicast ipv4
```

To disable multicast route ingress packet and byte counters use the following command:

```
switch(config)#no hardware counter feature multicast ipv4
```

On DCS-7020R, DCS-7280R/R2 and 7500R/R2 platforms, create and apply user defined TCAM profile with multicast counter feature db enabled. This example reates a profile copying it from the default, then modifying the profile.

```
switch(config)#hardware tcam  
switch(config-hw-tcam)#profile <profileName> copy default  
switch(config-hw-tcam-profileName)#feature counter multicast ipv4  
switch(config-hw-tcam-profileName-feature-counter-multicast-ipv4)#exit  
switch(config-hw-tcam-profileName)#no feature mirror ip  
switch(config-hw-tcam-profileName)#exit  
switch(config-hw-tcam)#system profile <profileName>
```

15.1.4.3 Show Commands

Use the **show ip mfib counters** command to display per multicast route ingress packet and byte counters:

```
switch#show ip mfib 225.1.2.1 10.46.1.2 counters  
Activity poll time: 60 seconds  
 225.1.2.1 10.46.1.2  
   Byte: 1200200  
   Packet: 12002  
   Ethernet46 (iif)  
   Ethernet47  
   Activity 0:02:52 ago  
switch#
```

```
switch#show ip mfib counters  
Activity poll time: 60 seconds  
 225.1.1.1 0.0.0.0/0  
   Byte: 234100  
   Packet: 2341  
   1 (rpaIndex)  
   Ethernet21
```

```

Ethernet23
  Activity 1:00:52 ago
225.1.2.1 10.46.1.2
  Byte: 1200200
  Packet: 12002
Ethernet46 (iif)
Ethernet47
  Activity 0:02:52 ago
224.0.0.0/4 10.45.1.0/24
  Byte: N/A
  Packet: N/A
Ethernet45 (iif)
  Cpu
  Activity 0:02:04 ago
switch#

```

To clear all counters including per multicast route ingress counters, use the **clear counters** command.

```
switch#clear counters
```

To clear per multicast route ingress counters or clear counters for a particular multicast route, use the **clear ip multicast counters** command.

```
switch#clear ip multicast <vrf [vrf-name]> counters <group_addr>
<source_addr>
```

15.1.4.4 Syslog Messages

On platforms supporting the feature, 16 counter engines are available. Each engine can hold 4K counters on the DCS-7020R, and 16K on rest of the platforms. When the feature is configured and counter engines are not available, the output of the **show hardware counter feature** command does not have a **Multicast-IPv4 in** line. Instead, the following Syslog is observed:

```
%DATAPLANE-4-COUNTER_RESOURCE_FULL: Hardware resources are insufficient
to enable counters for feature Mcast
```

Once you free up counter resources by disabling features that are utilizing the counters banks, then this feature is automatically enabled and you no longer see the Syslog message.

```
%DATAPLANE-4-COUNTER_RESOURCE_CONFLICT: Counter resource conflict between
MplsLfib and Mcast
```

The feature is automatically active upon removing the conflicting counter feature.

15.1.4.5 Troubleshooting

Possible troubleshooting issues and remedies:

- Review the output of `show hardware counter feature` to see the status of the feature.

Example

```
switch#show hardware counter feature
Feature                Direction          Counter Resource (Engine)
-----
Multicast-IPv4        in                XXXXX: XXXXX
```

- Use the `no hardware counter feature <FEATURE>` CLI command to free resource(s) used by other counter feature(s).
- Review the output of `show hardware tcam profile` command to see the status of the user defined Tcam profile.

Example

```
switch#show hardware tcam profile
Configuration          Status
-----
XXXXXX                <profileName>    <profileName>
```

- On the DCS-7020R, DCS-7280R/R2 and 7500R/R2 platforms, in case counters are not incremented, run the `show hardware tcam profile <profileName> detail | grep multicast` command to ensure `counter multicast ipv4` exists in the output.

```
switch#show hardware tcam profile <profileName> detail | grep multicast
Feature                counter multicast ipv4
```

15.1.4.6 Limitations

This feature contains the following limitations:

- Counters are not supported on fastdrop multicast routes.
- For Pim sparse mode, counters are supported only on (*Source_addr, Group_addr*) multicast routes.
- Counting is supported for IPv4 multicast packets only.

15.1.5 Multicast (S,G) Counters

The Multicast Route Counters count the packets and bytes per group, source, and VRF. Every multicast route is counted when the Multicast (S,G) counters is enabled, and if there are sufficient hardware counter resources available. Since the number of hardware counter resources is limited, selected multicast routes can be **prioritized** to provide them the needed hardware counter resources over the **non-priority** multicast routes in case of resource contention.

Priority multicast routes can be configured if:

- Hardware counter resources are available:
 - The priority multicast routes do not affect the existing non-priority multicast route counters.
- In case there are insufficient hardware counter resources:
 - If there are non-priority multicast routes, one non-priority multicast route counter resource will be freed, which results in losing the counters for the non-priority multicast route, and the priority multicast route will be programmed, meanwhile the non-priority multicast route will be pending to be programmed until there are hardware counter resources available.
 - If there are only priority multicast groups, the newly configured priority multicast groups will wait till the resources are freed by existing priority groups

Platform Compatibility

- 7050X/X2/X3 series

- 7060X/X2/X3 series
- CCS-720XP series
- 7300X/7320X/7300X3 series
- DCS-7060DX4 series starts supporting IPv4.

15.1.5.1 Configuring Multicast (S,G) Counters

- The multicast (S, G) counters feature is configured using the following command in the configuration mode:

```
switch(config)#hardware counter feature multicast ipv[4|6]
```

The `hardware counter feature multicast ipv[4|6]` command enables counting for all groups as non-priority groups unless the groups that require priority treatment have been configured under router multicast as described in the next paragraph. Use the **no** form of the command to disable the multicast (S, G) counters on a switch.

- Certain multicast routes can be configured as priority multicast routes for counting purposes, and they will be counted with higher priority. In case of running out of hardware counter resources, this could result in deleting the existing multicast (S, G) counters. The following configuration shows how the ipv6 version is configured, it's similar to IPv4. Use the `no counters` command to disable the priority routes.

```
switch(config)#router multicast
switch(config-router-multicast)#ipv6
switch(config-router-multicast-ipv6)#counters
switch(config-router-multicast-ipv6)#counters ff08::e101:101
2002::a01:101
```

Of the above configuration steps, the following command is required before configuring the specific multicast routes:

```
switch(config-router-multicast-ipv6)#counters
```

Otherwise the system prompts the following error:

```
! 'counters' not configured, packet will not be counted
```

- Clear counters:

```
switch#clear ipv6 multicast <vrf [vrf-name]> counters <group> <source>
```

The above CLI command can either clear the counters for all multicast routes or the specific (vrf, group, source). The default VRF will be used if it's not specified. All the IPv6 counters are cleared if no group and source are specified. The IPv4 version of the command is:

```
switch#clear ip multicast <vrf [vrf-name]> counters <group> <source>
```

The below command clears the counters of all multicast routes along with all other counters.

```
switch#clear counters
```

15.1.5.2 Multicast (S,G) Counters Show Commands

- The hardware counter resources are allocated if the Multicast (S,G) Counters is configured. The configuration state is shown as the following: **Mcast** is listed in the **Feature ID** field and the

Counters column indicates the total number of hardware counter resources assigned to the Multicast (S,G) Counters:

```
switch#show platform trident flexcounters summary
Feature ID      Type      Request ID  Pool ID      Start Index
Counters
-----
Mcast          ingress   0           0            1
8191
```

- The current counter resource allocation for each multicast route is shown using the following CLI command. The **Pool ID** column indicates which pool is used, and the **Base Counter Index** indicates the entry index in that pool.

```
switch#show platform trident flexcounters multicast summary
Group          Source      VRF      VLAN      Counter Index
Pool ID      Offset Mode  Base Counter Index
-----
ff08::e101:101 2002::a01:105 0      2570      1
0              0              1
225.1.1.1      10.1.1.5    0      2571      2
0              0              2
```

- The raw counter value of the each multicast route is shown using the following command. The **cntTbl** reflects the hardware table, the counters are copied from **cntTbl** to **snapTbl** when the clear counter command is issued. The difference between “cntTbl” and “snapTbl” is the current counter.

```
switch#show platform trident flexcounters multicast values
Group          Source      VRF      VLAN      Counter Index Offset Bytes
(cntTbl)      Bytes (snapTbl) Pkts (cntTbl) Pkts (snapTbl)
-----
ff08::e101:101 2002::a01:105 0 2570      1
6600          0              100        0
225.1.1.1      10.1.1.5    0 2571      2
8800          0              100        0
```

- The multicast (S,G) counters is shown using the following CLI command. In the following example “Byte” and “Packet” are the counters:

```
switch#show multicast fib ipv6 <vrf [vrf-name]> <group> <source>
counters
Activity poll time: 60 seconds
ff08::e101:101 2002::a01:101
  Byte: 66
  Packet: 1
  Vlan2780 (iif)
  Ethernet6/4
  Vlan2899

switch#show multicast fib ipv4 <vrf [vrf-name]> <group> <source>
counters
Activity poll time: 60 seconds
255.1.1.1 10.1.1.5
  Byte: 66
  Packet: 1
  Vlan2781 (iif)
```

```
Ethernet8/4
Vlan2999
```

15.1.5.3 Limitations

- The number of counters for which the hardware counters can be enabled simultaneously will be limited by the availability of counter hardware resources in the system. When the configured hardware features exceed the available counter resources not all counters for all features will be available, the following CLI command shows the current allocation of the hardware resources:

```
switch#show platform trident flexcounters summary
Feature ID      Type      Request ID  Pool ID      Start Index
Counters
-----
Mcast          ingress   0           0            1
8191
```

15.1.6 Static IP Mroute

The Static IP Multicast route (or Static Mroute) interface overrides the interface that is ordinarily selected from the matching route in the unicast routing table, providing a means for breaking dependency on the unicast topology for the multicast topology. Let us assume that, PIM routers in a multicast network sends PIM joins towards a source to receive traffic from that source. The interface on which to send a PIM join is determined by looking up the unicast routing table for the source address. This interface is the upstream or RPF interface for that source. When traffic is received from that source, it is ensured it is received on the RPF interface for that source. This mechanism causes multicast traffic to take the same path through a network as unicast traffic would. In some cases, it is desirable to have the multicast traffic take a different path than the unicast traffic. For example, to avoid a slow firewall required for unicast traffic but not for multicast traffic or to receive multicast across a low latency, low bandwidth microwave link while unicast traverses a higher latency, higher bandwidth fiber path.

To overcome this situation, a static IP multicast route (or static mroute) command `ip mroute` command is introduced. The `ip mroute` command specifies a candidate for the RPF interface of any (S,G) multicast route where the source falls within the given source/mask. This interface potentially overrides the interface that would ordinarily have been selected from the matching route in the unicast routing table. This command, therefore, provides a means of breaking the dependence of the multicast topology on the unicast topology. The method of selecting the RPF interface for an (S,G) route is described next.

Example

- This command configures a Static IP mroute for a source 1.1.1.1/32 with an administrative distance 20 on a Ethernet interface 2/1.

```
switch(config)#ip mroute 1.1.1.1/32 ethernet 2/1 20
```

15.1.6.1 Selecting Static Mroute

The Static Mroute is selected based the following parameters:

- Longest Match
- Administrative Distance
- Interface Status

Longest Match

When a given source matches multiple static Mroutes in the MRIB, the longest match will be selected. The order in which the static Mroutes were configured will not be a factor.

Example

- If the following static mroutes were configured in order:

```
ip mroute 0.0.0.0/0 Ethernet1
ip mroute 192.168.0.0/16 Ethernet2
ip mroute 192.168.1.0/24 Ethernet3
```

For an (S,G) route where S = 192.168.1.1, the third static mroute listed above would be selected since it is the most specific route to the source. The RPF interface would therefore be Ethernet 3. The table below shows the selected RPF interface for 3 different sources based on the configuration above:

Source	RPF Interface
192.168.1.1	Ethernet 3
192.168.1.2	Ethernet 3
192.168.2.1	Ethernet 2
10.0.0.1	Ethernet 1

Administrative Distance

User is allowed to specify an administrative distance with each static Mroute. While selecting a Static Mroute for a source, if multiple Static Mroute exist in the MRIB with the same source/mask, then, the one with the lowest Admin distance is selected. The default administrative distance for a Static Mroute is 1.

Interface Status

For a Static Mroute to be considered for selection, the specified interface must be UP and PIM must be enabled on it.

15.1.6.2 Selecting RPF interface

Static Mroutes are BGP IP Multicast (SAFI 2) learned routes. These routes are stored in the multicast routing information base (MRIB), a separate routing table. The RPF interface is selected for a source as follows:

Initially, a source route is looked up in the MRIB. If the MRIB lookup yields a route, that route is used for selecting the RPF interface. Therefore, any configured Static Mroutes matching the source wins the selection process over a 'Connected' route to the source. For a static mroute to be considered for selection, the specified interface must be up and PIM must be enabled on it. By default, Static Mroute have an Admin distance of 1. If multiple Static Mroutes exist with equal longest prefix match, the mroute with the lowest Admin distance will win. Admin distance is not be used to compare selection between unicast RIB and MRIB routes. Successful Static Mroute looked up in the MRIB are always chosen over unicast RIB lookups.

If MRIB lookup does not yield a route, then the unicast RIB is looked up for a route to select the RPF interface. If the selected route has ECMP, one of the corresponding paths is selected as RPF neighbor.



Note: The path to choose RPF neighbor is selected based on the hashing scheme; and protocols specified for valid paths, multi-path configuration, directly connected sources, and assert winners.

Example

- Let us assume that the Static Mroute is configured, and for this example let us consider that the default Admin distance for connected routes is 0, 1 for static routes, and 110 for OSPF routes.

```
ip mroute 172.16.0.0/16 Ethernet1
ip mroute 192.168.0.0/16 Ethernet2
ip mroute 192.168.1.0/24 Ethernet3
ip mroute 192.168.1.0/24 Ethernet4 255
ip mroute 192.168.1.3/32 Ethernet5 255
ip mroute 200.10.0.0/16 Ethernet5
ip mroute 200.11.0.32/16 Ethernet5
```

- So the MRIB table contains the following:

Prefix	Interface	Admin Distance
172.16.0.0/16	Ethernet 1	1
192.168.0.0/16	Ethernet 2	1
192.168.1.0/24	Ethernet 3	1
192.168.1.0/24	Ethernet 4	255
192.168.1.3/32	Ethernet 5	255
200.10.0.0/16	Ethernet 5	1
200.11.0.1/32	Ethernet 5	1

- And let us assume the unicast RIB table contains the following:

Prefix	Interface	Protocol	Admin Distance
10.0.0.0/24	Ethernet 6	OSPF	110
172.16.1.0/24	Ethernet 7	OSPF	110
192.168.0.0/16	Ethernet 8	OSPF	110
192.168.1.0/24	Ethernet 9	Static	1
192.168.1.3/32	Ethernet 10	OSPF	110
200.10.0.0/16	Ethernet 11	Connected	0

- The table below shows the RPF interface selections for a set of sources along with which Static Mroute was chosen, which unicast RIB route was chosen, which was the eventual winner, and the reasoning behind the selection.

Source	Static Mroute	Unicast Route	Winner	RPF Interface	Reasoning
10.0.0.1	-	1	Unicast Route	Ethernet 6	<ul style="list-style-type: none"> Only the unicast Rib yields a route to the source so it wins
200.11.0.1	7	-	Static Mroute	Ethernet 5	<ul style="list-style-type: none"> Only the MRIB yields a route to the source so it wins
192.168.1.3	5	5	Unicast Route	Ethernet 10	<ul style="list-style-type: none"> In the MRIB (5) is the longest match While comparing the static mroute and the unicast route, the unicast route is the winner because it has a lower Admin distance
192.168.2.1	2	3	Static Mroute	Ethernet 2	<ul style="list-style-type: none"> In the MRIB (2) is the longest match While comparing the static mroute and the unicast route, the static Mroute is the winner because it has a lower Admin distance
192.168.1.1	3	4	Static Mroute	Ethernet 3	<ul style="list-style-type: none"> In the MRIB both (3) and (4) are the longest match but (3) has the lower Admin distance While comparing the static mroute and the unicast route, the static mroute is the winner even though both have the same distance

15.1.7 Static Multicast

Static Multicast enables to configure multicast routes statically on any Arista switches and even at per VRF granularity. However, static multicast routes do not, at this point, perform any VRF validation for the interfaces involved in the route, which can cause some possibility of route leakage. The Static Multicast co-exists with PIM-SM and PIM-BIDIR protocols which are dynamic variants of programming multicast routes. However, choose the appropriate route selection method before the static routes are programmed to obtain the best results.

Static multicast routes compete with the routes provided by PIM-SM and PIM-BIDIR mainly because this static variant, allows the operator to configure a PIM-SM-like or PIM-BIDIR-like route among other routes. The route chosen depends upon setting up the priority on the route.

At present, PIM-SM/PIM-BIDIR installs routes with a priority value of 0 (zero) while static route installs routes with a priority of 255, by default.

The priorities of PIM-SM and PIM-BIDIR are subject to future change. Higher priority wins in case of conflicts while programming the hardware. Conflicts here imply the same route present as static multicast route and in PIM-SM/PIM-BIDIR. It concludes that, by default, static multicast routes will always be the winner.

Platform Compatibility

The Static Multicast is supported across all the platforms.

15.1.8 Configuring Multicast

This section describes the following configuration tasks:

- [Enabling IPv4 Multicast Routing](#)
- [Enabling IPv6 Multicast Routing](#)
- [Multicast-Routing Configuration Example](#)
- [Multicast Boundary Configuration](#)
- [Multicast multipath router-ID \(IPv4\)](#)
- [Configuring MFIB](#)
- [Configuring Static Multicast](#)
- [Displaying and Clearing the Mroute Table](#)

15.1.8.1 Enabling IPv4 Multicast Routing

Enabling IPv4 multicast routing allows the switch to forward multicast packets. The `routing` command enables multicast routing. When multicast routing is enabled, *running-config* contains a `routing` statement.

Example

- These commands enable IPv4 multicast routing on the switch.

```
switch(config)#router multicast
switch(config-router-multicast)#ipv4
switch(config-router-multicast-ipv4)#routing
```

15.1.8.2 Enabling IPv6 Multicast Routing

Enabling IPv6 Multicast routing allows the switch to distribute IPv6 datagrams to one or more recipients. IPv6 PIM builds and maintains Multicast routing using reverse path forwarding (RPF) based on unicast routing table. IPv6 PIM is protocol-independent and can use routing tables consisting of OSPFv3, IPv6 BGP or static routes, for RPF lookup. MLD is used to discover Multicast hosts and maintain group membership on directly attached link. This feature is supported on 7280R and 7500R. Source-specific multicast (SSM) is currently supported on L3 routed port.

PIM Sparse Mode

In PIM-SM, each host (sender and/or receiver) is associated with a designated router (DR) which acts for all directly connected hosts in PIM-SM transactions. Upon receiving of MLD report from host or PIM join from downstream PIM neighbor, (S,G) route is created or programmed and router sends a PIM join to upstream PIM neighbor with shortest path to the source.

Configuring IPv6 Multicast Routing

The following steps are to configure IPv6 multicast routing on the switch.

1. Enabling IPv6 multicast-routing. By default, multicast-routing is disabled on switch. The following commands are used to enable IPv6 multicast-routing.

Example:

```
switch(config)#router multicast
switch(config-router-multicast)#ipv6
switch(config-router-multicast-ipv6)#routing
```

2. Enabling IPv6 PIM Sparse Mode

By default, IPv6 PIM is disabled on an interface. The `pim ipv6 sparse-mode` command enables an interface to participate in IPv6 multicast-routing domain.

Example:

```
switch(config)#interface ethernet 15/1
switch(config-if-Et15/1)#pim ipv6 sparse-mode
```

 **Note:** SVI is not supported.

3. Enabling MLD

By default, MLD is disabled on an interface. Enabling MLD is needed only on the interface that is connected to the MLD host which would like to receive IPv6 multicast traffic.

Example:

```
switch(config)#interface ethernet 15/1
switch(config-if-Et15/1)#mlld
```

15.1.8.3 Multicast-Routing Configuration Example

```
router multicast
  ipv6
    Routing
interface Ethernet15/1
  no switchport
  ipv6 enable
  ipv6 address 40:1::3/64
  mld
  pim ipv6 sparse-mode
```

Displaying IPv6 Multicast Routing Information

- The `show mld membership` command displays the MLD group membership table as shown.

```
switch#show mld membership
Interface          Group                Source
Filter Mode
-----
Ethernet2/1.1     ff33::1:0:0:1       101:1::2
include
Ethernet2/1.1     ff33::1:0:0:2       101:1::2
include
```

```

Ethernet2/1.1      ff33::1:0:0:3      101:1::2
include
Ethernet2/1.1      ff33::1:0:0:4      101:1::2
include
Ethernet2/1.1      ff33::1:0:0:5      101:1::2
include
Ethernet2/1.1      ff33::1:0:0:6      101:1::2
include
Ethernet2/1.1      ff33::1:0:0:7      101:1::2
include
Ethernet2/1.1      ff33::1:0:0:8      101:1::2
include
Ethernet2/1.1      ff33::1:0:0:9      101:1::2
include
Ethernet2/1.1      ff33::1:0:0:a      101:1::2
include
Ethernet2/1.1      ff33::1:0:0:b      101:1::2
include

```

- The `show pim ipv6 sparse-mode route` command displays the PIM Sparse Mode Multicast Routing table as shown.

```

switch#show pim ipv6 sparse-mode route
PIM Sparse Mode Multicast Routing Table
Flags: E - Entry forwarding on the RPT, J - Joining to the SPT
       R - RPT bit is set, S - SPT bit is set, L - Source is attached
       W - Wildcard entry, X - External component interest
       I - SG Include Join alert rcvd, P - (*,G) Programmed in hardware
       H - Joining SPT due to policy, D - Joining SPT due to protocol
       Z - Entry marked for deletion, C - Learned from a DR via a register
       A - Learned via Anycast RP Router, M - Learned via MSDP
       N - May notify MSDP, K - Keepalive timer not running
       T - Switching Incoming Interface, B - Learned via Border Router
RPF route: U - From unicast routing table
           M - From multicast routing table
ff33::1:0:0:1
 101:1::2, 2:03:00, flags: S
  Incoming interface: Ethernet11/1
  RPF route: [U] 101:1::/64 [110/1] via fe80::464c:a8ff:feb7:39e9
  Outgoing interface list:
    Ethernet6/1.1
    Ethernet4/1.1
    Ethernet7/1.1
    Ethernet9/1.1
    Ethernet8/1.1
    Ethernet2/1.1
    Ethernet5/1.1
    Ethernet3/1.1

```

- The `show multicast fib ipv6` command displays the Multicast Forwarding Information Base (MFIB) table.

```

switch#show mfib ipv6
Activity poll time: 60 seconds

```

```

ff33::1:0:0:1 101:1::2
Ethernet11/1 (iif)
Ethernet9/1.1
Ethernet2/1.1
Ethernet3/1.1
Ethernet6/1.1
Ethernet5/1.1
Ethernet8/1.1
Ethernet7/1.1
Ethernet4/1.1
Activity 0:00:35 ago

```

- The `show platform fap mroute ipv6` command displays the Platform Hardware Forwarding table.

```

switch#show platform fap mroute ipv6
Jericho0 Multicast Routes:
-----
Location      GroupId      Group                               Source
IIF           McId         OIF
FLP/TT        FLP/TT       TT                                   FLP
FLP           FLP          FLP
-----
-----
4096/2048    1/1          ff33::1:0:0:23/128                101:1::2/128
Vlan1357 21504      Vlan1044 (Et7/1) Vlan1123 (Et9/1)

Vlan1200 (Et8/1) Vlan1223 (Et2/1)

Vlan1226 (Et5/1) Vlan1232 (Et3/1)

Vlan1307 (Et6/1) Vlan1337 (Et4/1)

```

15.1.8.4 Multicast Boundary Configuration

The multicast boundary specifies subnets where source traffic entering an interface is filtered to prevent the creation of mroute states on the interface. The interface is not included in the outgoing interface list (OIL). Multicast PIM, IGMP and other multicast data cannot cross the boundary, facilitating the use of a multicast group address in multiple administrative domains.

The `ip multicast boundary` command configures the multicast boundary. The multicast boundary can be specified through multiple IPv4 subnets or one standard IPv4 ACL.

In an ACL method, the multicast subnets are allowed only from the permit entries of the ACL and rest is either denied or filtered. Whereas, in a non-ACL method the statements configure subnets that are only denied or filtered.

Examples

- These commands configure the multicast address of 229.43.23.0/24 as a multicast boundary where source traffic is restricted from VLAN interface 300.

```

switch(config)#interface vlan 300

```

```
switch(config-if-vl300)#ip multicast boundary 229.43.23.0/24
switch(config-if-vl300)#
```

- These commands create a standard ACL, then implement the ACL in an **ip multicast boundary** command to allow multicast for subnet (224.0.0.0/4) and create a multicast boundary for all remaining subnets by denying them.

```
switch(config)#ip access-list standard mbac1
switch(config-std-acl-mbac1)#10 deny 225.123.0.0/16
switch(config-std-acl-mbac1)#20 deny 239.120.10.0/24
switch(config-std-acl-mbac1)#30 permit 224.0.0.0/4
switch(config-std-acl-mbac1)#exit
switch(config)#interface vlan 200
switch(config-if-Vl200)#ip multicast boundary mbac1
switch(config-if-Vl200)#exit
switch(config)#
```

15.1.8.5 Multicast multipath router-ID (IPv4)

The `multipath deterministic` command with the `router-ID` allows downstream PIM neighbors to direct traffic for a group or source-group to be routed through only the specified upstream PIM neighbor for all downstream PIM neighbors with the same ECMP routes. Traffic is load balanced by group or source-group across upstream PIM neighbors as in the default multipath mode.

Multipath router-ID uses the Interface Identifier (from the Hello Option for PIM) to give PIM-enabled devices a globally unique router ID for each of their PIM neighbors.

The following configures the switch to use the `router_ID`.

```
switch(config)# router multicast
Switch(config-router-multicast)#ipv4
Switch(config-router-multicast-ipv4)#multipath deterministic router-id
```

The following displays the switch before the configuration.

```
Switch(config-router-multicast-ipv4)#show active all
router multicast
  ipv4
    counters bytes
    activity polling-interval 60
    no routing
    multipath deterministic
    max-fastdrops 1024
    unresolved cache-entries max 4000
    unresolved packet-buffers max 3
    software-forwarding kernel
```

The following displays the switch after the configuration.

```
Switch(config-router-multicast-ipv4)#show active all
router multicast
  ipv4
    counters bytes
    activity polling-interval 60
    no routing
    multipath deterministic router-id
    max-fastdrops 1024
    unresolved cache-entries max 4000
    unresolved packet-buffers max 3
    software-forwarding kernel
```

15.1.8.6 Configuring MFIB

MFIB formats PIM and IGMP multicast routes for protocol-independent hardware packet forwarding and adds them to the hardware multicast expansion table (MET) and the hardware FIB.

MFIB Polling Interval

The switch records activity levels for multicast routes in the MFIB after polling the corresponding hardware activity bits. The `activity polling-interval` command specifies the frequency at which the switch polls the hardware activity bits for the multicast routes.

Example

- These commands set the MFIB activity polling period to 15 seconds.

```
switch(config)#router multicast
switch(config-router-multicast)#ipv4
switch(config-router-multicast-ipv4)#activity polling-interval 15
switch(config-router-multicast-ipv4)#
```

MFIB Fast Drops

In IP multicast protocols, every (S,G) or (*,G) route is associated with an inbound RPF (reverse path forwarding) interface. Packets arriving on an interface not associated with the route may need CPU-dependent PIM processing, so packets received by non-RPF interfaces are sent to the CPU by default, causing heavy CPU processing loads.

Multicast routing protocols often do not require non-RPF packets; these packets do not require software processing. The CPU therefore updates the hardware MFIB with a fast-drop entry when it receives a non-RPF interface packet that PIM does not require. Additional packets that match the fast-drop entry are not sent to the system software.

Fast drop is enabled on all interfaces by default. The `no ip mfib fastdrop` command disables MFIB fast drop for the configuration mode interface.

Example

- This command disables MFIB fast drop for the VLAN interface 120.

```
switch(config)#interface vlan 120
switch(config-if-Vl120)#no ip mfib fastdrop
switch(config-if-Vl120)#
```

The `ip mfib max-fastdrops` command limits the number of fast-drop routes that the switch's MFIB table can contain. The default fast-drop route limit is 1024.

Example

- This command sets the maximum number of fast-drop routes to 2000.

```
switch(config)#ip mfib max-fastdrops 2000
switch(config)#
```

The `clear ip mfib fastdrop` command, in global configuration mode, removes all MFIB fast-drop entries on all interfaces.

Example

- This command removes all fast-drop entries from the MFIB table.

```
switch#clear ip mfib fastdrop
switch#
```

The `show multicast fib ipv4` command displays information about the routes and interfaces in the IPv4 MFIB.

- `show multicast fib ipv4` displays MFIB information for hardware-forwarded routes.
- `show multicast fib ipv4 software` displays MFIB information for software-forwarded routes.

Example

- This command displays MFIB information for hardware-forwarded routes.

```
switch#show multicast fib ipv4
Activity poll time: 60 seconds
239.255.255.250 172.17.26.25
  Vlan26 (iif)
  Vlan2028
  Cpu
    Activity 0:02:11 ago
239.255.255.250 172.17.26.156
  Vlan26 (iif)
  Vlan2028
  Cpu
    Activity 0:02:11 ago
239.255.255.250 172.17.26.178
  Vlan26 (iif)
  Vlan2028
  Cpu
    Activity 0:03:37 ago
switch#
```

MFIB Unresolved Cache-entries Max

The `unresolved cache-entries max` command configures the maximum number of unresolved (S,G) routes that the switch can cache packets. All packets belonging to (S,G) routes exceeding the limit are dropped. The default buffer size is 4000 routes. See `ip multicast boundary` to limit the number of cached packets per S,G.

Example

- This command sets the maximum MFIB unresolved cache-entry buffer size to 6000 routes in the default VRF.

```
switch(config)#router multicast
switch(config-router-multicast)#ipv4
switch(config-router-multicast-ipv4)#unresolved cache-entries max 6000
switch(config-router-multicast-ipv4)#
```

MFIB Unresolved Packet-buffers Max

The `ip multicast boundary` command specifies the number of packets per unresolved route that are queued while the route is being resolved by the switch. The limit for `ip multicast boundary` is for an individual route, packets that exceed this limit are dropped. By default, the switch processes

3 unresolved packets for an individual route. See `unresolved cache-entries max` to limit the number of unresolved routes that are cached.

Example

- This command configures the switch in the default VRF to cache up to thirty multicast packets from any route before that route is resolved.

```
switch(config)#router multicast
switch(config-router-multicast)#ipv4
switch(config-router-multicast-ipv4)#unresolved packet-buffers max 30
switch(config-router-multicast-ipv4)#
```

15.1.8.7 Configuring Static Multicast

Use the `route` command to configure the Static Multicast in the Router Multicast mode.

Example

```
switch(config)#router multicast
switch(config-router-multicast)#route
```

Configuring Static Multicast routes for a VRF

The Static Multicast route can be configured on a VRF in the Router Multicast VRF IPv4 Configuration mode. Note, static multicast commands belong in the router multicast mode. To maintain backward compatibility for default VRF, static multicast commands for default VRF can be entered without changing to router multicast mode.

Example

```
switch(config)#router multicast
switch(config-router-multicast)#route
```

Source address can be optionally entered. When no source address is entered, it is assumed to be 0.0.0.0

```
switch(config-router-multicast)#route 1.1.1.1 10.1.1.1
switch(config-router-multicast)#route 1.1.1.1 10.1.1.1 iif
```

Note, the IIF must belong to the same VRF for which the command is being executed for the configuration to take effect.

```
switch(config-router-multicast)#route 1.1.1.1 10.1.1.1 iif ethernet
switch(config-router-multicast)#route 1.1.1.1 10.1.1.1 iif ethernet 30
switch(config-router-multicast)#route 1.1.1.1 10.1.1.1 iif ethernet 30
oif
```

Multiple interfaces can be entered following the OIF. However, OIF is also optional. When there are no OIFs, then traffic for the S,G on the incoming interface is dropped.

```
switch(config-router-multicast)#route 1.1.1.1 10.1.1.1 iif ethernet 30
oif ethernet
switch(config-router-multicast)#route 1.1.1.1 10.1.1.1 iif ethernet 30
oif ethernet 30 ethernet 32
switch(config-router-multicast)#route 1.1.1.1 10.1.1.1 iif ethernet 30
oif ethernet 30 ethernet 32 cpu priority
```

The CPU option can be used to have CPU in the OIF set, it is optional. The **priority** is an optional and the value ranges from 1 to 255. By default, the value is 255.

```
switch(config-router-multicast)#route 1.1.1.1 10.1.1.1 iif ethernet 30
oif ethernet 30 ethernet 32 cpu priority 40
```

Displaying Static Multicast Information

Use the `show multicast fib ipv4` command verify the status of the Static Multicast configured interfaces.

```
switch#show multicast fib ipv4
Activity poll time: 60 seconds
225.1.1.1 10.1.1.1
  Ethernet1 (iif)
  Ethernet2
  Cpu
```

15.1.8.8 Displaying and Clearing the Mroute Table

The mroute table stores the states of inbound and outbound interfaces for each source/group pair (S,G). The switch discards and forwards packets on the basis of this state information. Each table entry, referred to as an mroute, corresponds to a unique (S,G) and contains:

- the multicast group address
- the multicast source address (or * for all sources)
- the inbound interface
- a list of outbound interfaces

Clearing mroute Entries

The `clear ip mroute` command removes route entries from the mroute table:

- `clear ip mroute *` all entries from the mroute table.
- `clear ip mroute gp_ipv4` all entries for the specified multicast group.
- `clear ip mroute gp_ipv4 src_ipv4` all entries for the specified source sending to a specified group.

Examples

- This command removes all route entries from the mroute table.

```
switch#clear ip mroute *
switch#
```

- This command removes entries for source 228.3.10.1 sending to multicast group 224.2.205.42.

```
switch#clear ip mroute 224.2.205.42 228.3.10.1
switch#
```

Displaying the mroute Table

The `show ip mroute count` command displays IP multicast routing table statistics.

Example

- This command displays IP multicast routing table statistics.

```
switch#show ip mroute count
IP Multicast Statistics
```

```
1 groups and 1 sources
Multicast routes: 1 (*,G), 1 (S,G)
Average of 1.00 sources per group
Maximum of 1 sources per group:
228.24.12.1
switch>
```

The **show ip mroute** command displays information from the IP multicast routing table.

- **show ip mroute** displays information for all routes in the table.
- **show ip mroute gp_addr** displays information for the specified multicast group.

Example

- This command displays the IP multicast routing table for the multicast group 225.1.1.1.

```
switch#show ip mroute 225.1.1.1
PIM Sparse Mode Multicast Routing Table
Flags: E - Entry forwarding on the RPT, J - Joining to the SPT
R - RPT bit is set, S - SPT bit is set
W - Wildcard entry, X - External component interest
I - SG Include Join alert rcvd, P - Ex-Prune alert rcvd
H - Joining SPT due to policy, D - Joining SPT due to protocol
Z - Entry marked for deletion
A - Learned via Anycast RP Router
225.1.1.1
172.28.1.100, 5d04h, flags: S
Incoming interface: Vlan281
Outgoing interface list:
Port-Channel999
switch>
```

15.1.9 Multicast Commands

Multicast Configuration Commands (Global)

- activity polling-interval
- hardware counter feature multicast ipv4
- ip mfib max-fastdrops
- ip mroute
- ip multicast boundary
- ip multicast static
- mld last-listener-query-count
- mld last-listener-query-interval
- mld query-interval
- mld query-response-interval
- mld robustness
- mld snooping
- mld startup-query-count
- mld startup-query-interval
- mld static-group
- mld
- multipath deterministic
- multipath none
- route
- router multicast
- routing
- rpf route
- unresolved cache-entries max

Multicast Configuration Commands (Interface)

- ip mfib fastdrop
- ip multicast boundary

Multicast Clear Commands

- clear ip mfib fastdrop
- clear ip multicast counters
- clear ip mroute

Multicast Display Commands

- show ip mroute
- show ip mfib counters
- show ip mroute count
- show ip multicast boundary
- show mld membership
- show mld querier
- show mld snooping
- show mld statistics
- show mld summary
- show multicast fib ipv4

-
- `show multicast fib ipv4 software`
 - `show multicast fib ipv6`
 - `show pim ipv6 sparse-mode route`
 - `show platform fap mroute ipv6`

15.1.9.1 activity polling-interval

The switch records activity levels for multicast routes in the mfib after polling the corresponding hardware activity bits. The **activity polling-interval** command specifies the frequency at which the switch polls the hardware activity bits for the multicast routes.

The **no activity polling-interval** and **default activity polling-interval** commands restore the default interval of 60 seconds by removing the **activity polling-interval** command from *running-config*.

Command Mode

Router Multicast IPv4 Configuration

Command Syntax

```
activity polling-interval period
```

```
no activity polling-interval
```

```
default activity polling-interval
```

Parameters

- *period* interval (seconds) between polls. Values range from 1 to 60. Default is 60.

Example

- These commands set the MFIB activity polling period to 15 seconds.

```
switch(config)#router multicast
switch(config-router-multicast)#ipv4
switch(config-router-multicast-ipv4)#activity polling-interval 15
switch(config-router-multicast-ipv4)#
```

15.1.9.2 clear ip mfib fastdrop

The `clear ip mfib fastdrop` command removes all fast-drop entries from the MFIB table.

Command Mode

Privileged EXEC

Command Syntax

```
clear ip mfib fastdrop
```

Example

- This command removes all fast-drop entries from the MFIB table.

```
switch#clear ip mfib fastdrop  
switch#
```

15.1.9.3 clear ip mroute

The **clear ip mroute** command removes route entries from the mroute table, as follows:

- **clear ip mroute *** removes all entries from the mroute table.
- **clear ip mroute *gp_ipv4*** removes all entries for the specified multicast group.
- **clear ip mroute *gp_ipv4src_ipv4*** removes all entries for the specified source sending to the specified group.

Command Mode

Privileged EXEC

Command Syntax

```
clear ip mroute ENTRY_LIST
```

Parameters

- ENTRY_LIST entries that the command removes from the mroute table. Options include:
 - * all route entries
 - *gp_ipv4* all entries for multicast group *gp_ipv4* (dotted decimal notation)
 - *gp_ipv4 src_ipv4* all entries for source (*src_ipv4*) sending to group (*gp_ipv4*)

Examples

- This command removes all route entries from the mroute table.

```
switch#clear ip mroute *  
switch#
```

- This command removes entries for the source 228.3.10.1 sending to multicast group 224.2.205.42.

```
switch#clear ip mroute 224.2.205.42 228.3.10.1  
switch#
```

15.1.9.4 clear ip multicast counters

To clear per multicast route ingress counters or clear counters for a particular multicast route, use the `clear ip multicast counters` command.

Command Mode

EXEC

Command Syntax

```
clear ip multicast [ vrf [ vrf-name ] ] counters group_addr source_addr
```

Parameters

- **vrf *vrf-name*** VRF name.
- **counters** Counter for bytes/packets.
- ***group_addr*** Group address.
- ***source_addr*** Source address.

15.1.9.5 hardware counter feature multicast ipv4

Use the **hardware counter feature multicast ipv4** command to enable per multicast router ingress packets and byte counters. The **no** and **default** forms of the command disables the feature. The feature is disabled by default.

Command Mode

Configuration mode

Command Syntax

```
hardware counter feature multicast ipv4
no hardware counter feature multicast ipv4
default hardware counter feature multicast ipv4
```

Example

On DCS-7020R, DCS-7280R/R2 and 7500R/R2 platforms, create and apply user defined TCAM profile with multicast counter feature db enabled. This example reates a profile copying it from the default, then modifying the profile.

```
switch(config)#hardware tcam
switch(config-hw-tcam)#profile <profileName> copy default
switch(config-hw-tcam-profileName)#feature counter multicast ipv4
switch(config-hw-tcam-profileName-feature-counter-multicast-ipv4)#exit
switch(config-hw-tcam-profileName)#no feature mirror ip
switch(config-hw-tcam-profileName)#exit
switch(config-hw-tcam)#system profile <profileName>
```

15.1.9.6 ip mfib fastdrop

In IP multicast protocols, every (S,G) or (*,G) route is associated with an inbound RPF (reverse path forwarding) interface. Packets arriving on an interface not associated with the route may need CPU-dependent PIM processing, so packets received by non-RPF interfaces are sent to the CPU by default, causing heavy CPU processing loads.

Multicast routing protocols often do not require non-RPF packets; these packets do not require software processing. The CPU therefore updates the hardware MFIB with a fast-drop entry when it receives a non-RPF interface packet that PIM does not require. Additional packets that match the fast-drop entry are not sent to the system software.

Fast drop is enabled on all interfaces by default. The `no ip mfib fastdrop` command disables MFIB fast drop for the configuration mode interface.

The `ip mfib fastdrop` and `default ip mfib fastdrop` commands enable MFIB fast drop for the configuration mode interface by removing the corresponding `no ip mfib fastdrop` command from *running-config*.

The `clear ip mfib fastdrop` command, in global configuration mode, removes all MFIB fast-drop entries on all interfaces.

Command Mode

Interface-Ethernet Configuration

Interface-Port-channel Configuration

Interface-VLAN Configuration

Command Syntax

```
ip mfib fastdrop
```

```
no ip mfib fastdrop
```

```
default ip mfib fastdrop
```

Examples

- This command disables MFIB fast drop for VLAN interface 120.

```
switch(config)#interface vlan 120
switch(config-if-Vl120)#no ip mfib fastdrop
switch(config-if-Vl120)#
```

15.1.9.7 ip mfib max-fastdrops

The `ip mfib max-fastdrops` command limits the number of fast-drop routes that the switch's MFIB table can contain.

The `no ip mfib max-fastdrops` and `default ip mfib max-fastdrops` commands restore the default fast-drop route limit of 1024 by removing the `ip mfib max-fastdrops` command from *running-config*.

Command Mode

Global Configuration

Command Syntax

```
ip mfib max-fastdrops quantity
```

```
no ip mfib max-fastdrops
```

```
default ip mfib max-fastdrops
```

Parameters

- *quantity* maximum number of fast-drop routes. Value ranges from 0 to 1000000 (one million). Default is 1024.

Example

- This command sets the maximum number of fast-drop routes to 2000.

```
switch(config)#ip mfib max-fastdrops 2000
switch(config)#
```

15.1.9.8 ip mroute

The `ip mroute` command configures the Static Mroute on the switch.

The `no ip mroute` and `default ip mroute` commands remove the specified static mroute from *running-config*.

Command Mode

Global Configuration

Command Syntax

```
ip mroute [<source-prefix>|<source-address> <mask>] [<rpf-interface>|<rpf-neighbor>] [admin distance]
```

Example

- This command configures a Static IP mroute for a source 1.1.1.1/32 with an administrative distance 20 on a Ethernet interface 2/1.

```
switch(config)#ip mroute 1.1.1.1/32 ethernet 2/1 20
```

15.1.9.9 ip multicast boundary

The **ip multicast boundary** command specifies subnets where source traffic entering the configuration mode interface is dropped, preventing the creation of mroute states on the interface. The interface is not included in the outgoing interface list (OIL). The multicast boundary can be specified through multiple IPv4 subnets or one standard IPv4 ACL.

In an ACL method, the multicast subnets are allowed only from the permit entries of the ACL and rest is either denied or filtered. Whereas, in a non-ACL method the statements configure subnets that are only denied or filtered.

Multicast PIM, IGMP and other multicast data cannot cross the boundary, facilitating the use of a multicast group address in multiple administrative domains.

The **no ip multicast boundary** and **default ip multicast boundary** commands delete the specified subnet restriction by removing the corresponding **ip multicast boundary** command from **running-config**. When these commands do not specify a subnet address, all **ip multicast boundary** statements for the configuration mode interface are removed.

Command Mode

Interface-Ethernet Configuration

Interface-Port-channel Configuration

Interface-VLAN Configuration

Command Syntax

```
ip multicast boundary SUBNET [TCAM]
```

```
no ip multicast boundary [SUBNET]
```

```
default ip multicast boundary [SUBNET]
```

Parameters

- SUBNET the subnet address configured as the multicast boundary. Options include:
 - *net_addr* multicast subnet address (CIDR or address mask).
 - *acl_name* standard access control list (ACL) that specifies the multicast group addresses.
- TCAM specifies address inclusion in the routing table. Options include:
 - <no parameter> boundaries ((S,G) entries) are added to routing table.
 - **out** boundaries are not added to routing table.

Guidelines

When **out** is selected, the first inbound data packet corresponding to the **SUBNET** may be sent to the CPU. In response, the packet is dropped and the boundary prefix is added to the hardware table. In this scenario, the mroute entry is added only when data traffic is received.

Restrictions

Only one command that specifies an ACL can be assigned to an interface. Commands that specify an ACL and a subnet cannot be simultaneously assigned to an interface.

Examples

- This command configures the multicast address of 229.43.23.0/24 as a multicast boundary where source traffic is restricted from VLAN interface 300.

```
switch(config)#interface vlan 300
switch(config-if-vl300)#ip multicast boundary 229.43.23.0/24
switch(config-if-vl300)#
```

-
- These commands create a standard ACL, then implement the ACL in an ip multicast boundary command to allow multicast for subnet (224.0.0.0/4) and create a multicast boundary for all remaining subnets by denying them.

```
switch(config)#ip access-list standard mbacl
switch(config-std-acl-mbacl)#10 deny 225.123.0.0/16
switch(config-std-acl-mbacl)#20 deny 239.120.10.0/24
switch(config-std-acl-mbacl)#30 permit 224.0.0.0/4
switch(config-std-acl-mbacl)#exit
switch(config)#interface vlan 200
switch(config-if-Vl200)#ip multicast boundary mbacl
switch(config-if-Vl200)#exit
switch(config)#
```

15.1.9.10 ip multicast static

The `ip multicast static` command enables static multicast routing on the switch.

The `exit` command returns the switch to global configuration mode.

Command Mode

Interface Ethernet Configuration

Command Syntax

```
ip multicast static
```

Example

- The following commands configure the static multicast routing on the switch.

```
switch(config)#interface ethernet 1/2
switch(config-if-Et1/2)#no switchport
switch(config-if-Et1/2)#ip address 1.1.1.1/24
switch(config-if-Et1/2)#ip multicast static
```

15.1.9.11 mld last-listener-query-count

The `mld last-listener-query-count` command specifies the number of query messages the switch sends in response to a group-specific or group-source-specific leave message.

After receiving a message from a host leaving a group, the switch sends query messages at intervals specified by `mld last-listener-query-interval`. If the switch does not receive a response to the queries after sending the number of messages specified by this parameter, it stops forwarding messages to the host.

The `no mld last-listener-query-count` and `default mld last-listener-query-count` commands reset the last-listener-query-count to the default value by removing the corresponding `mld last-listener-query-count` command from the *running-config*. Default value is 2.

Command Mode

Interface-Ethernet Configuration

Command Syntax

```
mld last-listener-query-count number
```

```
no mld last-listener-query-count
```

```
default mld last-listener-query-count
```

Parameters

- *number* the last listener query count. Values range from 0 to 100. Default value is 2.

Example

- This command configures the last listener query count to 3 on an Ethernet interface 1.

```
switch(config)#interface Ethernet 1  
switch(config-if-Et1)#mld last-listener-query-count 3
```

15.1.9.12 mld last-listener-query-interval

The **mld last-listener-query-interval** command configures the switch's transmission interval for sending group-specific or group-source-specific query messages from the configuration mode interface.

When a switch receives a message from a host that is leaving a group, it sends query messages at intervals set by this command. The **mld last-listener-query-count** specifies the number of messages that are sent before the switch stops forwarding packets to the host.

If the switch does not receive a response after this period, it stops forwarding traffic to the host on behalf of the group, source, or channel.

The **no mld last-listener-query-interval** and **default mld last-listener-query-interval** commands reset the last-listener-query-interval to the default value by removing the corresponding **mld last-listener-query-interval** command from the **running-config**. Default value is one second.

Command Mode

Interface-Ethernet Configuration

Command Syntax

```
mld last-listener-query-interval period  
no mld last-listener-query-interval  
default mld last-listener-query-interval
```

Parameters

- *period* the last listener query interval in seconds. Values range from 1 to 3175.

Example

- This command configures the last listener query interval to 2 seconds on an Ethernet interface 1.

```
switch(config)#interface Ethernet1  
switch(config-if-Et1)#mld last-listener-query-interval 2
```

15.1.9.13 mld query-interval

The **mld query-interval** command configures the frequency at which the configuration mode interface, as an MLD querier, sends host-query messages.

An MLD querier sends host-query messages to discover the multicast groups that have members on networks attached to the interface. The switch implements a default query interval of 125 seconds.

The **no mld query-interval** and **default mld query-interval** commands reset the query interval to the default value by removing the corresponding **mld query-interval** command from the *running-config*.

Command Mode

Interface-Ethernet Configuration

Command Syntax

```
mld query-interval period
```

```
no mld query-interval
```

```
default mld query-interval
```

Parameters

- *period* the interval between query messages in seconds. Values range from 1 to 3175.

Example

- This command configures the query interval of 30 seconds on an Ethernet interface 1.

```
switch(config)#interface Ethernet1  
switch(config-if-Et1)#mld query-interval 30
```

15.1.9.14 mld query-response-interval

The **mld query-response-interval** command configures the maximum response time that the recipient can wait before responding with a membership report on receipt of a general query.

The **no mld query-response-interval** and **default mld query-response-interval** commands reset the query interval to the default value by removing the corresponding **mld query-response-interval** command from the *running-config*.

Command Mode

Interface-Ethernet Configuration

Command Syntax

```
mld query-interval period
```

```
no mld query-interval
```

```
default mld query-interval
```

Parameters

- *period* the query response interval in seconds. Values range from 1 to 3175.

Example

- This command configures the query response interval of 30 seconds on an Ethernet interface 1.

```
switch(config) #interface Ethernet1  
switch(config-if-Et1) #mld query-response-interval 30
```

15.1.9.15 mld robustness

The `mld robustness` command configures the number of general queries to be sent before the router assumes there are no more listeners.

The `no mld robustness` and `default mld robustness` commands reset the robustness to the default value by removing the corresponding `mld robustness` command from the *running-config*.

Command Mode

Interface-Ethernet Configuration

Command Syntax

```
mld robustness robust_value
```

```
no mld robustness
```

```
default mld robustness
```

Parameters

- *robust_value* the robustness count. Values range from 1 to 100.

Example

- This command configures the robustness value to 2 on an Ethernet interface 1.

```
switch(config)#interface Ethernet1  
switch(config-if-Et1)#mld robustness 2
```

15.1.9.16 mld snooping

Multicast Listener Discovery (MLD) snooping constrains the flooding of IPv6 multicast traffic on VLANs and IGMP snooping for IPv4 environments. When MLD snooping is enabled on a VLAN, the device examines MLD messages between the hosts and multicast routers and learns which hosts are interested in receiving traffic for a multicast group. You can use the **mld snooping** command to configure MLDv2 snooping globally and per VLAN.

The **no** and the **default** forms of the command removes the mld snooping configuration.

Command Mode

Global configuration mode

Command Syntax

```
mld snooping
```

```
no mld snooping
```

```
default mld snooping
```

Example

The following example configures MLDv2 snooping globally and per VLAN.

```
switch(config)#mld snooping  
switch(config-mld-snooping)#disabled  
switch(config-mld-snooping)#vlan 1-100  
switch(config-mld-snooping)#vlan 101  
switch(config-mld-snooping-vlan-101)#disabled
```

15.1.9.17 mld startup-query-count

The `mld startup-query-count` command specifies the number of query messages that an interface sends during the startup query interval.

When an interface starts running MLD, it can establish the group state more quickly by sending query messages at a higher frequency. The `mld startup-query-interval` and `mld startup-query-count` commands define the startup period and the query message transmission frequency during that period.

The `no mld startup-query-count` and `default mld startup-query-count` commands restore the default startup-query-count value by removing the corresponding `mld startup-query-count` command from the *running-config*.

Command Mode

Interface-Ethernet Configuration

Command Syntax

```
mld startup-query-count number
```

```
no mld startup-query-count
```

```
default mld startup-query-count
```

Parameters

- *number* the startup query count. Values range from 1 to 100.

Example

- This command configures the startup query count of 4 on an Ethernet interface 1.

```
switch(config)#interface Ethernet1  
switch(config-if-Et1)#mld startup-query-count 4
```

15.1.9.18 mld startup-query-interval

The `mld startup-query-interval` command specifies the interval between the general queries sent by a querier on startup.

When an interface starts running MLD, it can establish the group state quicker by sending query messages at a higher frequency. The `mld startup-query-interval` and `mld startup-query-count` commands define the startup period and the query message transmission frequency during that period.

The `no mld startup-query-count` and `default mld startup-query-interval` commands restore the default startup-query-interval value by removing the corresponding `mld startup-query-interval` command from the *running-config*.

Command Mode

Interface-Ethernet Configuration

Command Syntax

```
mld startup-query-interval period
```

```
no mld startup-query-interval
```

```
default mld startup-query-interval
```

Parameters

- *period* the startup query interval in seconds. Values range from 1 to 3175.

Example

- This command configures the startup query interval of 100 seconds on an Ethernet interface 1.

```
switch(config) #interface Ethernet1  
switch(config-if-Et1) #mld startup-query-interval 100
```

15.1.9.19 mld static-group

The **mld static-group** command configures the configuration mode interface as a static member of a specified multicast group. This allows the router to forward multicast group packets through the interface without otherwise appearing or acting as a group member. By default, static group memberships are not configured on any interfaces.

If the command includes a source address, only multicast group messages received from the specified host address are fast-switched. Otherwise, all multicast traffic of the specified group is fast-switched.

The **no mld static-group** and **default mld static-group** commands remove the configuration mode interfaces group membership by removing the corresponding **mld startup-group** command from the *running-config*.

Command Mode

Interface-Ethernet Configuration

Command Syntax

```
mld static-group source_address [group_address | access-list acl_name]
no mld static-group source_address [group_address | access-list acl_name]
default mld static-group source_address [group_address | access-list
acl_name]
```

Parameters

- *source_address* IP address of the host that originates multicast data packets.
- *group_address* IPv6 address of a multicast group.
- *access-list* IPv6 access list to use as a static group list.
- *acl_name* specifies access-list name

Examples

- This command configures static groups on an interface Ethernet 1.

```
switch(config)#interface Ethernet1
switch(config-if-Et1)#mld static-group ff30::1 a::1
```

- This command configures multiple static groups using an access list on an interface Ethernet 1.

```
switch(config)#interface Ethernet1
switch(config-if-Et1)#mld static-group access-list testAccessList
```

15.1.9.20 mld

The **mld** command enables multicast listener discovery on an interface which controls the flow of layer 3 IPv6 multicast traffic. Hosts request and maintain multicast group membership through MLD messages. Multicast routers use MLD to maintain a membership list of active multicast groups for each attached network.

The **no mld** and **default mld** commands restore the default behavior by removing the corresponding **mld** command from the *running-config*.



Note: It is possible to change the values of the querier parameters used by MLD.

Command Mode

Interface-Ethernet Configuration

Command Syntax

```
mld [last-listener-query-count | last-listener-query-interval | query-interval | query-response-interval | robustness | startup-query-count | startup-query-interval | static-group]
```

```
no mld
```

```
default mld
```

Parameters

- **last-listener-query-count** the number of group-specific or group-source-specific queries to send before the router assumes there are no more listeners.
- **last-listener-query-interval** the interval between the last listener queries.
- **query-interval** the interval between the general queries regularly sent by a querier.
- **query-response-interval** the interval that the host has to respond to a general query.
- **robustness** the number of general queries to send before the router assumes there are no more listeners.
- **startup-query-count** the number of queries a router sends at startup.
- **startup-query-interval** the interval between the general queries sent by a querier at startup.
- **static-group** the number of static groups or sources of MLD messages.

Examples

- This command enables MLD on the Ethernet interface 1.

```
switch(config)#interface Ethernet1  
switch(config-if-Et1)#mld
```

15.1.9.21 multipath deterministic

By default, multicast traffic is load balanced by distributing packets over all ECMP links. The `no multipath deterministic` command routes multicast ECMP traffic to the neighbor with the highest IPv4 address.

The `multipath deterministic` and `default multipath deterministic` commands restore the default behavior of randomly distributing multicast traffic over all ECMP links.

Command Mode

Router Multicast IPv4 Configuration

Command Syntax

```
multipath deterministic
```

```
no multipath deterministic
```

```
default multipath deterministic
```

Related Commands

- `multipath none` performs the same function as `no multipath deterministic`

Example

- These commands configure the switch to route multicast traffic through the ECMP link to the neighbor with the highest IP address.

```
switch(config)#router multicast  
switch(config-router-multicast)#ipv4  
switch(config-router-multicast-ipv4)#no multipath deterministic  
switch(config-router-multicast-ipv4)#
```

- These commands configure the switch to load balance multicast traffic by distributing packets over all ECMP links.

```
switch(config)#router multicast  
switch(config-router-multicast)#ipv4  
switch(config-router-multicast-ipv4)#multipath deterministic  
switch(config-router-multicast-ipv4)#
```

- These commands configure the switch to load balance multicast traffic by enabling the behavior of RPF selection.

```
switch(config)#router multicast  
switch(config-router-multicast)#ipv4  
switch(config-router-multicast-ipv4)#multipath deterministic router-id  
switch(config-router-multicast-ipv4)#
```

15.1.9.22 multipath none

By default, multicast traffic is load balanced by distributing packets over all ECMP links. The `multipath none` command routes multicast ECMP traffic to the neighbor with the highest IPv4 address.

The `no multipath none` and `default multipath none` commands restore the default behavior of randomly distributing multicast traffic over all ECMP links by removing the `multipath none` command from *running-config*.

Command Mode

Global Configuration

Command Syntax

```
multipath none
```

```
no multipath none
```

```
default multipath none
```

Related Commands

- `multipath deterministic` performs the same function as `no multipath none`

Example

- These commands configure the switch to route multicast traffic through the ECMP link to the neighbor with the highest IP address.

```
switch(config)#router multicast
switch(config-router-multicast)#ipv4
switch(config-router-multicast-ipv4)#multipath none
switch(config-router-multicast-ipv4)#
```

- These commands configure the switch to load balance multicast traffic by distributing packets over all ECMP links.

```
switch(config)#router multicast
switch(config-router-multicast)#ipv4
switch(config-router-multicast-ipv4)#no multipath none
switch(config-router-multicast-ipv4)#
```

15.1.9.23 route

The **route** command configures a static multicast route for the specified source, destination group, and incoming interface on the router.

The **no route** and **default route** commands remove the specified static multicast route by removing the corresponding **route** command from *running-config*.

Command Mode

Router Multicast IPv4 Configuration

Router Multicast VRF IPv4 Configuration

Command Syntax

```
route group_address [source_address] iif interface [oif interface] [cpu] [iifFrr interface]
[priority priority_num]
```

```
no route group_address
```

```
default route group_address
```

Parameters

- *group_address* the multicast group address
- *source_address* the optional source address for the multicast route
- **iif interface** specifies an incoming interface for the static route
- **cpu** optionally mirrors multicast packets to the CPU
- **oif interface** specifies an optional outgoing interface to be included among those on which the multicast traffic is forwarded
- **iifFrr interface** specifies an optional interface for multicast-only fast reroute
- *interface* options include:
 - **Ethernet ethernet_port** Ethernet interface
 - **Null0** drops all traffic
 - **Port-Channel lag_no** port-channel interface or sub-interface; values range from 1-2000 or 1-2000.1-4094
 - **Register0** drops all incoming traffic
 - **Vlan vlan_no** VLAN interface
- **priority priority_num** specifies an optional priority for the multicast route. If the same route is present in several multicast routing tables, the priority number is used to select the best available route. Values range from 0 to 255; PIM routes by default have a priority of 0, while static multicast routes by default have a priority of 255.

Examples

- These commands create a static multicast route in the default VRF. The static route has a group address of 225.3.3.3 and source address of 1.1.1.1. It uses VLAN 100 as its incoming interface, VLANs 200 and 300 as its outgoing interfaces, and Ethernet interface 2 as its multicast-only fast reroute interface.

```
switch(config)#router multicast
switch(config-router-multicast)#ipv4
switch(config-router-multicast-ipv4)#route 225.3.3.3 1.1.1.1 iif
Vlan100 oif
Vlan200 Vlan300 iifFrr Ethernet2
switch(config-router-multicast-ipv4)#
```

15.1.9.24 router multicast

The `router multicast` command places the switch in router-multicast configuration mode to configure IPv4 and IPv6 router multicast traffic.

Command Mode

Global Configuration

Command Syntax

```
router multicast
```

Example

- The following command places the switch in router-multicast configuration mode.

```
switch(config)#router multicast  
switch(config-router-multicast)#ipv6  
switch(config-router-multicast-ipv6)#routing
```

15.1.9.25 routing

The **routing** command allows the switch to forward multicast packets. Multicast routing is disabled by default.

The **no routing** and **default routing** commands disable multicast routing by removing the **routing** command from *running-config*.

Command Mode

Router Multicast IPv4 Configuration

Router Multicast VRF IPv4 Configuration

Command Syntax

routing

no routing

default routing

Example

- These commands enable multicast routing on the switch.

```
switch(config)#router multicast
switch(config-router-multicast)#ipv4
switch(config-router-multicast-ipv4)#routing
switch(config-router-multicast-ipv4)#
```

15.1.9.26 rpf route

The **rpf route** command specifies a candidate for the multicast reverse path forwarding (RPF) interface of any (S,G) multicast route (mroute), where the source falls within the given network prefix. Static mroutes are stored in a separate routing table, the multicast routing information base (MRIB).

Command Mode

Router Multicast IPv4 Configuration

Router Multicast VRF IPv4 Configuration

Command Syntax

```
rpf route {<source_prefix>|<source_address> <mask>} {<rpf_interface>|<rpf_neighbor>}
[admin_distance]
```

```
no rpf route {<source_prefix>|<source_address> <mask>} {<rpf_interface>|<rpf_neighbor>}
```

```
default rpf route {<source_prefix>|<source_address> <mask>} {<rpf_interface>|<rpf_neighbor>}
```

Parameters

- source_prefix specifies the source prefix.
- source_address specifies the source address.
- mask specifies the address mask.
- rpf_interface specifies the multicast RPF interface.
- rpf_neighbor specifies the multicast RPF neighbor.
- admin_distance specifies the administrative distance (optional). Values range from 1 to 255.

Examples

- These commands select the longest match when a source matches multiple static mroutes in the MRIB.

```
switch(config)#router multicast
switch(config-router-multicast)#ipv4
switch(config-router-multicast-ipv4)#rpf route 10.0.0.0/16 Ethernet 4
switch(config-router-multicast-ipv4)#rpf route 11.10.1.0/24 Ethernet 5
switch(config-router-multicast-ipv4)#rpf route 11.10.1.2/32 Ethernet 6
switch(config-router-multicast-ipv4)##
```

- These commands include an administrative distance of 255 on Ethernet interface 5 with static mroute.

```
switch(config)#router multicast
switch(config-router-multicast)#ipv4
switch(config-router-multicast-ipv4)#rpf route 10.0.0.0/16 Ethernet 4
switch(config-router-multicast-ipv4)#rpf route 11.10.1.0/24 Ethernet 5
255
switch(config-router-multicast-ipv4)#rpf route 11.10.1.2/32 Ethernet 6
switch(config-router-multicast-ipv4)#
```

15.1.9.27 show ip mfib counters

Use the **show ip mfib counters** command to display per multicast route ingress packet and byte counters.

Command Mode

EXEC

Command Syntax

```
show ip mfib vrf [ vrf-name ] group_addr source_addr counters
```

Parameters

- **vrf** [*vrf-name*] VRF name.
- **group_addr** Group address.
- **source_addr** Source address.
- **counters** Counter for bytes/packets.

Example

```
switch#show ip mfib 225.1.2.1 10.46.1.2 counters
Activity poll time: 60 seconds
 225.1.2.1 10.46.1.2
   Byte: 1200200
   Packet: 12002
   Ethernet46 (iif)
   Ethernet47
   Activity 0:02:52 ago
switch#
```

15.1.9.28 show ip mroute count

The `show ip mroute count` command displays IP multicast routing table statistics.

The `show ip mroute` command displays information from the IP multicast routing table.

Command Mode

EXEC

Command Syntax

`show ip mroute count`

Example

- This command displays IP multicast routing table statistics.

```
switch#show ip mroute count
IP Multicast Statistics
1 groups and 1 sources
Multicast routes: 1 (*,G), 1 (S,G)
Average of 1.00 sources per group
Maximum of 1 sources per group:
228.24.12.1
switch#
```

15.1.9.29 show ip mroute

The `show ip mroute` command displays information from the IP multicast routing table.

- `show ip mroute` displays information for all routes in the table.
- `show ip mroute gp_addr` displays information for the specified multicast group.

Command Mode

EXEC

Command Syntax

`show ip mroute`

`show ip mroute gp_addr`

Parameters

- `gp_addr` group IP address (dotted decimal notation).

Example

- This command displays the IP multicast routing table entry for the multicast group 225.1.1.11

```
switch#show ip mroute 225.1.1.1
PIM Sparse Mode Multicast Routing Table
Flags: E - Entry forwarding on the RPT, J -Joining to the SPT
R - RPT bit is set, S - SPT bit is set
W - Wildcard entry, X - External component interest
I - SG Include Join alert rcvd, P - Ex-Prune alert rcvd
H - Joining SPT due to policy, D - Joining SPT due to protocol
Z - Entry marked for deletion
A - Learned via Anycast RP Router
225.1.1.1
172.28.1.100, 5d04h, flags: S
Incoming interface: Vlan281
Outgoing interface list:
Port-Channel999
switch#
```

15.1.9.30 show ip multicast boundary

The **show ip multicast boundary** command displays the summary of all IP multicast boundaries across all interfaces.

Command Mode

EXEC

Command Syntax

```
show ip multicast boundary [group_prefix | group_prefix/length [out] | interface
{ethernet e_num | loopback l_num | management m_num | port-channel p_num | vlan
v_num} | out]
```

Parameters

- <no parameters> displays the summary of all IP multicast boundaries across all interfaces
- *group_prefix* displays the list of IP multicast boundaries matching the specified group address with subnet mask.
- *group_prefix/length* displays the list of IP multicast boundaries matching the specified group address with CIDR notation. Option includes:
 - **out** displays the specified group addresss IP multicast boundaries whose control plane filtering is enabled
- **interface** displays IP multicast boundary of the specified interface. Options include:
 - **ethernet** *e_num* displays IP multicast boundaries of the specified Ethernet interface
 - **loopback** *l_num* displays IP multicast boundaries of the specified Loopback interface
 - **management** *m_num* displays IP multicast boundaries of the specified management interface
 - **port-channel** *p_num* displays IP multicast boundaries of the specified port channel interface
 - **vlan** *v_num* displays IP multicast boundaries of the specified VLAN interface
- **out** displays all IP multicast boundaries whose only control plane filtering is enabled

Examples

- This command displays the summary of all IP multicast boundaries across all interfaces.

```
switch(config-if-Et24)#show ip multicast boundary
Interface Denied Prefix Data Plane Filtered
Ethernet1 224.5.5.0/24 Yes
Ethernet1 224.6.6.0/24 Yes
Ethernet2 224.4.4.0/24 Yes
Ethernet3 224.5.5.0/24 No
```

- This command displays all IP multicast boundaries matching 224.5.5.0 255.255.255.255.

```
switch(config-if-Et24)#show ip multicast boundary 224.5.5.0
255.255.255.255
Interface Denied Prefix Data Plane Filtered
Ethernet1 224.5.5.0 255.255.255.255
Ethernet3 224.5.5.0 255.255.255.255 No
```

- This command displays all IP multicast boundaries matching 224.5.5.0/24.

```
switch(config-if-Et24)#show ip multicast boundary 224.5.5.0/24
Interface Denied Prefix Data Plane Filtered
Ethernet1 224.5.5.0/24
Ethernet3 224.5.5.0/24 No
```

- This command displays all IP multicast boundaries of the Ethernet1 interface.

```
switch(config-if-Et24)#show ip multicast boundary interface Ethernet1
```

```
Interface Denied Prefix Data Plane Filtered
Ethernet1 224.5.5.0/24
Ethernet1 224.6.6.0/24 No
```

- This command displays the list of IP multicast boundaries whose only control plane filtering is enabled.

```
switch(config-if-Et24)#show ip multicast boundary out
Interface Denied Prefix Data Plane Filtered
Ethernet1 224.5.5.0/24 No
Ethernet3 224.5.5.0/24 No
```

15.1.9.31 show mld membership

The **show mld membership** command displays MLD group and source membership information on a specific interface.

Command Mode

EXEC

Command Syntax

```
show mld membership [dynamic | group | interface | static]
```

Parameters

- *dynamic* displays MLD information for a dynamic group.
- *group* displays MLD information for a specified multicast group address.
- *interface* displays MLD information for the specified interface.
- *static* displays MLD information for statically configured group.

Example

- This command displays MLD group and source information on the Ethernet interface 3 and 6.

```
switch#show mld membership
Interface          Group          Source
  Filter Mode
-----
-----
Ethernet3          ff30::1       a::2
  include
Ethernet3          ff30::1       a::1
  include
Ethernet6          ff30::2       a::2
  include
```

15.1.9.32 show mld querier

The **show mld querier** command displays information about the MLD querier and querier parameters.

Command Mode

EXEC

Command Syntax

```
show mld querier [interface | parameters]
```

Parameters

- *interface* displays MLD querier information.
- *parameters* displays MLD querier parameters.

Example

- This command displays MLD querier on the Ethernet interface Et3 and Et6.

```
Switch#show mld querier
Interface Querier          General  Other
      Version
Querier
-----
Et3      fe80::1:ff:fe01:0      0:01:14  N/A
      2
Et6      fe80::1:ff:fe01:0      0:01:14  N/A
      2
```

- This command displays MLD querier parameters on the Ethernet interface Et3 and Et6.

```
Switch#show mld querier parameters
Interface Robustness Query  Query  Startup  Startup
Last      Last
Listener  Listener
Query     Query
Interval  Count
-----
Et3      2      125     10      31.25    2      1
      2
Et6      2      125     10      31.25    2      1
      2
```

15.1.9.33 show mld snooping

Use the **show mld snooping** command to display the snooping status of the switch.

Command Mode

EXEC

Command Syntax

```
show mld snooping [ counters [errors] | groups [ A:B:C:D:E:F:G:H | count | detail | local | mlag |
user | vlan ] | mrouter [ detail | vlan ] | querier [ vlan ] | vlan [ num ]]
```

Parameters

- **counters** MLD counter information.
 - **errors** Error counters.
- **groups** MLD group information.
 - **A:B:C:D:E:F:G:H** IPv6 address.
 - **count** Displays membership count.
 - **detail** Displays a comprehensive output.
 - **local** Displays groups learned locally via MLD.
 - **mlag** Displays groups learned via MLAG peer.
 - **user** Displays groups configured by the user.
 - **vlan** Specifies VLAN.
- **mrouter** MLD multicast router information.
 - **detail** Displays a comprehensive output.
 - **vlan** Specifies VLAN.
- **querier** MLD querier information.
 - **vlan** Specifies VLAN.
- **vlan** Specifies VLAN.
 - **num** <1-4094> Identifier for Virtual LAN.

Examples

- Use the **show mld snooping** command to display the MLD snooping status of the switch.

```
switch#show mld snooping
  Global MLD Snooping configuration:
-----
MLD snooping                : Enabled
Robustness variable         : 2

VLAN 1 :
-----
MLD snooping                : Disabled
MLD max group limit         : No limit set
Recent attempt to exceed limit : No
MLD snooping pruning active : False
Flooding traffic to VLAN    : True
VLAN 100 :
-----
MLD snooping                : Enabled
MLD max group limit         : No limit set
Recent attempt to exceed limit : No
MLD snooping pruning active : True
Flooding traffic to VLAN    : False
```

```

switch##show mld snooping vlan 100
  Global MLD Snooping configuration:
  -----
MLD snooping                : Enabled
Robustness variable         : 2

VLAN 100 :
-----
MLD snooping                : Enabled
MLD max group limit         : No limit set
Recent attempt to exceed limit : No
MLD snooping pruning active : True
Flooding traffic to VLAN    : False

```

- Use the **show mld snooping groups** command to display VLANs by group.

```

switch#show mld snooping groups
IGMP Snooping Group Membership
EX : Filter mode Exclude
IN : Filter mode Include
IR : Ingress Replication
VLAN  Group                Members
-----
100    ff05::2              Cpu, Et4
100    ff08::11            Et1
100    ff08::21            Et2
100    ff08::31            Et3
100    *                   Et3, Et4

```

- Use the **show mld snooping groups detail** command to display detailed VLANs information by group.

```

switch(config-mld-snooping-vlan-100)#show mld snooping groups detail
IGMP Snooping Group Membership
EX : Filter mode Exclude
IN : Filter mode Include
IR : Ingress Replication
VLAN  Group                Source      Mode  Uptime      Members
-----
100    ff05::2              *          -     0d00h13m20  Cpu, Et4
100    ff08::11            *          -     0d00h13m17  Et1
100    ff08::21            1::1      IN     0d00h13m20  Et2
100    ff08::31            2::1      EX     0d00h01m31  Et3
100    *                   *          -     -           Et3, Et4

```

- The **show mld snooping groups** command output can be further filtered to output just the:
 - **local** groups, That is groups learned locally using **show mld snooping groups local** command.
 - **user** groups, that is groups configured by user using the **show mld snooping groups user** command.
 - **mlag** groups, that is groups learned from the MLAG peer using the **show mld snooping groups mlag** command.
- Use the **show mld snooping mrouter** to display MLD multicat router information.

```

switch#show mld snooping mrouter
Vlan      Interface-ports
-----
100       Et3(dynamic), Et4(static)

switch#show mld snooping mrouter detail

```

```

Vlan  Intf      Address          FirstHeard      LastHeard      Expires
Type
-----
100    Et3         fe80::200:3ff:fe01:0 0d00h24m30    0d00h00m08    00h00m17
querier
100    Et4         fe80::200:3ff:fe03:0 0d00h24m10    0d00h00m08    00h01m37
pim
100    Et2         0.0.0.0          -              -              -
static

switch##show mld snooping mrouter vlan 100
Vlan  Interface-ports
-----
100    Et2(static), Et3(dynamic), Et4(dynamic)
switch#show mld snooping querier
Vlan  IP Address          Version  Port
-----
100    fe80::200:3ff:fe01:0  v2      Et3

```

- Use the **show mld snooping querier** command to display querier information. In the example, the querier information requested for display is for VLAN **100**.

```

switch#show mld snooping querier vlan 100
IP Address      : fe80::200:3ff:fe01:0
MLD Version     : v2
Port           : Et3
Max response time : 10.0

switch#show mld snooping counters
          Input          |          Output
Port  Queries Reports Others Errors|Queries Reports Others
-----
Cpu      1      153      0      0    154      6      51
Et1      0      153      0      0    156      0      51
Et2      0      153      0      0    156     110     51
Et3     154      1      0      0      1     610     51
Et4      0      152     51      0    155     453      0
Switch   0      0      0      0      0      0      0

switch#show mld snooping counters errors
          Packet          Packet  Bad IP   Unknown   Bad PIM   Bad ICMP   Bad MLD   Bad
MLD      Too Short   Not IP  Checksum IP Protocol Checksum Checksum Query
Port
Report
-----
Cpu      0      0      0      0      0      0      0      0
0
Et1      0      0      0      0      0      0      0      0
0
Et2      0      0      0      0      0      0      0      0
0
Et3      0      0      0      0      0      0      0      0
0
Et4      0      0      0      0      0      0      0      0
0
Switch   0      0      0      0      0      0      0      0
0

```

The **Switch** interface in the above output can be ignored.

15.1.9.34 show mld statistics

The **show mld statistics** command displays total statistics information of incoming and outgoing MLD messages on a specific interface.

Command Mode

EXEC

Command Syntax

show mld statistics *version value*

Parameters

- *version* specifies MLD version.
- *value* specifies the MLD version number. Accepted version values are 1 and 2.

Example

- This command displays total MLD statistics on the Ethernet interface Et3 and Et6.

```
switch#show mld statistics
                MLD Total (Version1 + Version2) Statistics
                Received
  Sent
Interface      Queries    Reports    Dones      Others     Errors
  Queries
-----
Et3             0           12         0           0           0
  12
Et6             0           11         0           0           0
  12
```

15.1.9.35 show mld summary

The `show mld summary` command displays MLD summary information.

Command Mode

EXEC

Command Syntax

```
show mld summary
```

Parameters

- *interface* displays MLD summary on a specified interface.

Example

- This command displays MLD summary on the Ethernet interface 3 and 6.

```
Arista#show mld summary
Interface          IPv6 link-local address      Group
Count      Querier State
-----
Ethernet3          fe80::1:ff:fe01:0            2
  querier
Ethernet6          fe80::1:ff:fe01:0            2
  querier

Number of MLD interfaces: 2
Number of total groups joined across all MLD interfaces: 4
```

15.1.9.36 show multicast fib ipv4 software

The **show multicast fib ipv4 software** command displays information about the interfaces and the software-forwarded routes included in the IPv4 multicast forwarding information base (MFIB). Use the **show multicast fib ipv4** command for hardware-forwarded routes.

Parameter options are available to filter output by group address or group and source address.

Command Mode

EXEC

Command Syntax

```
show multicast fib ipv4 software [INFO_LEVEL] [ROUTE]
```

Parameters

- INFO_LEVEL specifies the type of information displayed. Options include
 - <no parameter> displays packet reception counters.
 - **detail** displays packet reception counters and packet queued/dropped counters.
- ROUTE routes displayed, filtered by multicast group and source IP addresses:
 - <no parameter> shows information for all software-forwarded routes in the MFIB.
 - *group_addr* shows information only for the specified multicast group.
 - *group_addr source address* shows information only for the specified group and source.

Example

- This command displays MFIB information for all software-forwarded routes in the MFIB.

```
switch#show multicast fib ipv4 software
239.255.255.250 172.17.41.150
    Vlan3040 (iif)
    Packets Received: 18
    Bytes Received   : 9147
    RPF Failures     : 0
239.255.255.250 172.17.41.120
    Vlan3040 (iif)
    Packets Received: 6
    Bytes Received   : 966
    RPF Failures     : 0
switch#
```

- This command displays detailed MFIB information for all software-forwarded routes in the MFIB.

```
switch#show multicast fib ipv4 software detail
239.255.255.250 172.17.41.150
Vlan3040 (iif)
Packets Received: 18
Bytes Received: 9147
RPF Failures: 0
Packets Queued/Dropped : 0 / 0
239.255.255.250 172.17.41.120
Vlan3040 (iif)
Packets Received: 6
Bytes Received: 966
RPF Failures: 0
Packets Queued/Dropped : 0 / 0
switch#
```

15.1.9.37 show multicast fib ipv4

The **show multicast fib ipv4** command displays information about interfaces and the hardware-forwarded routes included in the IPv4 Multicast Forwarding Information Base (MFIB).

Command Mode

EXEC

Command Syntax

```
show multicast fib ipv4 [group_address [source_address] | bidirectional |
count | counter | df | rpa | software | sparse-mode | static | summary |
vrf]
```

Parameters

- <no parameters> displays information for all hardware-forwarded routes in the MFIB
- *group_address* displays the information of the specified multicast group address. Options include:
 - *source_address* displays the information of the specified multicast group and source addresses
 - **count** displays the multicast routes count of the specified group address
 - **counters** displays the multicast route traffic count of the specified group address
- **bidirectional** displays the information of bidirectional routes
- **count** displays the count of multicast routes
- **counter** displays the count of multicast route traffic in either bytes or packets
- **df** displays the bidirectional Protocol Independent Multicast (PIM) Designated Forwarder (DF) bitmap
- **rpa** displays the bidirectional PIM Rendezvous Point Address (RPA) index
- **software** displays the software multicast FIB
- **sparse-mode** displays the sparse-mode information
- **static** displays the static multicast information
- **summary** displays the multicast FIB summary
- **vrf** *vrf_name* displays information of the corresponding VRF

Guidelines

The counter is not available (N/A) if a multicast route does not have an associated counter. If the counter value for any source in a group address is N/A, then the sum of counters for the group address is N/A. However, the counter values for other sources are still displayed.

Examples

- This command displays the bidirectional PIM RPA index.

```
switch#show multicast fib ipv4 rpa
Prefix                               Rpa Index
225.0.0.0/8                           1
226.0.0.0/8                           1
```

- This command displays the static multicast route information.

```
switch#show multicast fib ipv4 static count
(S,G) routes: 34
(*,G) routes: 31
Fastdrop routes: 0
Prefix routes: 12
```

- This command displays the multicast routes count of the specified group and source addresses.

```
switch#show multicast fib ipv4 229.0.0.0 10.1.5.101 count
Activity poll time: 60 seconds
```

```
(S,G) routes: 1
Fastdrop routes: 0
```

- This command displays the multicast route traffic count of the specified group and source addresses.

```
switch#show multicast fib ipv4 229.0.0.0 10.1.5.101 counters
Activity poll time: 60 seconds
229.0.0.0 10.1.5.101
  Byte: 46128
  Packet: 93
  Port-Channel100 (iif)
    Activity 0:53:52 ago
```

- This command displays the multicast FIB summary.

```
switch#show multicast fib ipv4 summary
Number of multicast routes: 12
Number of fastdrop routes : 45
```

15.1.9.38 show multicast fib ipv6

The `show multicast fib ipv6` command displays the Multicast Forwarding Information Base (MFIB) table.

Command Mode

EXEC

Command Syntax

```
show multicast fib ipv6
```

Example

- The command output displays the Multicast Forwarding Information Base (MFIB) table as shown.

```
switch#show multicast fib ipv6
Activity poll time: 60 seconds
ff33::1:0:0:1 101:1::2
  Ethernet11/1 (iif)
  Ethernet9/1.1
  Ethernet2/1.1
  Ethernet3/1.1
  Ethernet6/1.1
  Ethernet5/1.1
  Ethernet8/1.1
  Ethernet7/1.1
  Ethernet4/1.1
Activity 0:00:35 ago
```

15.1.9.39 show pim ipv6 sparse-mode route

The `show pim ipv6 sparse-mode route` command displays the PIM Sparse Mode Multicast Routing table.

Command Mode

EXEC

Command Syntax

```
show pim ipv6 sparse-mode route
```

Example

- The command output displays the PIM Sparse Mode Multicast Routing table as shown.

```
switch#show pim ipv6 sparse-mode route
PIM Sparse Mode Multicast Routing Table
Flags: E - Entry forwarding on the RPT, J - Joining to the SPT
       R - RPT bit is set, S - SPT bit is set, L - Source is attached
       W - Wildcard entry, X - External component interest
       I - SG Include Join alert rcvd, P - (*,G) Programmed in hardware
       H - Joining SPT due to policy, D - Joining SPT due to protocol
       Z - Entry marked for deletion, C - Learned from a DR via a register
       A - Learned via Anycast RP Router, M - Learned via MSDP
       N - May notify MSDP, K - Keepalive timer not running
       T - Switching Incoming Interface, B - Learned via Border Router
RPF route: U - From unicast routing table
           M - From multicast routing table
ff33::1:0:0:1
 101:1::2, 2:03:00, flags: S
  Incoming interface: Ethernet11/1
  RPF route: [U] 101:1::/64 [110/1] via fe80::464c:a8ff:feb7:39e9
  Outgoing interface list:
    Ethernet6/1.1
    Ethernet4/1.1
    Ethernet7/1.1
    Ethernet9/1.1
    Ethernet8/1.1
    Ethernet2/1.1
    Ethernet5/1.1
    Ethernet3/1.1
```

15.1.9.40 show platform fap mroute ipv6

The `show platform fap mroute ipv6` command displays the Platform Hardware Forwarding table.

Command Mode

EXEC

Command Syntax

```
show platform fap mroute ipv6
```

Example

- The command output displays the Platform Hardware Forwarding table as shown

```
switch#show platform fap mroute ipv6
Jericho0 Multicast Routes:
-----
  Location      GroupId      Group
  Source
  IIF           McId         OIF
  FLP/TT       FLP/TT       TT
  FLP
  FLP           FLP          FLP
-----
  4096/2048     1/1         ff33::1:0:0:23/128
  101:1::2/128
  Vlan1357 21504      Vlan1044(Et7/1) Vlan1123(Et9/1)

  Vlan1200(Et8/1) Vlan1223(Et2/1)

  Vlan1226(Et5/1) Vlan1232(Et3/1)
```

15.1.9.41 unresolved cache-entries max

The **unresolved cache-entries max** command configures the maximum number of unresolved (S,G) routes that the switch can cache packets. The default buffer size is 4000 (S,G) routes.

The **no unresolved cache-entries max** and **default unresolved cache-entries max** commands restore the default unresolved cache-entries buffer size of 4000 (S,G) routes by removing the **unresolved cache-entries max** command from *running-config*. See [ip multicast boundary](#) to limit the number of cached packets per S,G.

Command Mode

Router Multicast IPv4 Configuration

Router Multicast VRF IPv4 Configuration

Command Syntax

```
unresolved cache-entries max quantity_entries
```

```
no unresolved cache-entries max
```

```
default unresolved cache-entries max
```

Parameters

- *quantity_entries* maximum buffer size (routes). Value ranges from 10 to 10000000. Default is 4000.

Example

- This command sets the maximum MFIB unresolved cache-entry buffer size to 6000 routes in the default VRF.

```
switch(config)#router multicast
switch(config-router-multicast)#ipv4
switch(config-router-multicast-ipv4)#unresolved cache-entries max 6000
switch(config-router-multicast-ipv4)#
```

15.1.9.42 unresolved packet-buffers max

The **unresolved packet-buffers max** command specifies the number of (S,G) multicast packets for an individual route that the switch can process before the (S,G) entry is entered into cache. Packets that are received in excess of this limit before the route is programmed into the cache are dropped. By default, the switch processes 3 unresolved packets for an individual route.

The **no unresolved packet-buffers max** and **default unresolved packet-buffers max** commands restore the number of unresolved packets that the switch processes to the default value of 3 packets by removing the **unresolved packet-buffers max** command from **running-config**. See [unresolved cache-entries max](#) to limit the number of unresolved routes that are cached.

Command Mode

Router Multicast IPv4 Configuration

Router Multicast VRF IPv4 Configuration

Command Syntax

```
unresolved packet-buffers max quantity_packets
```

```
no unresolved packet-buffers max
```

```
default unresolved packet-buffers max
```

Parameters

- *quantity_packets* packets per unresolved route that the switch processes. Values range from 3 to 10000000. Default is 3.

Example

- This command programs the switch in the default VRF to process thirty multicast packets from any route regardless of its entries presence in the multicast routing cache.

```
switch(config)#router multicast
switch(config-router-multicast)#ipv4
switch(config-router-multicast-ipv4)#unresolved packet-buffers max 30
switch(config-router-multicast-ipv4)#
```

15.2 IGMP and IGMP Snooping

- [IGMP Snooping](#)
- [IGMP Host Proxy Description](#)
- [Supported Features](#)
- [IGMP Protocols](#)
- [Configuring IGMP](#)
- [Configuring IGMP Snooping](#)
- [IGMP Host Proxy](#)
- [IGMP and IGMP Snooping Commands](#)

15.2.1 IGMP Snooping

IGMP snooping is a layer 2 switch process that extracts lists of hosts receiving multicast group traffic by monitoring IGMP network packets. The switch uses these lists to avoid flooding hosts with extraneous multicast traffic by sending group packets only to group members. Besides preventing local hosts from receiving traffic for groups they did not join, snooping prunes multicast traffic from links that do not contain IGMP clients.

When snooping is enabled, a switch examines IGMP packets sent between hosts connected to network switches and multicast routers (mrouter). When a switch finds an IGMP report from a multicast group recipient, it adds the recipient's port to the group multicast list. When the switch receives an IGMP leave, it removes the recipient's port from the list. Groups are removed upon the group timer expiry. When the switch finds an IGMP query packet or PIM hello packet from a multicast router, it adds the router's port to the port list for all multicast groups.

Snooping Querier

Snooping requires an IGMP querier in the network to create multicast group tables. An IGMP snooping querier performs the multicast router (mrouter) role when the network does not have a router. When the snooping querier is enabled on a VLAN, the switch periodically broadcasts IGMP queries and listens for IGMP Reports that indicate host group memberships.

Networks that contain multiple snooping queriers elect one as the querier, based on IP address. When IGMP snooping querier is enabled on a VLAN, the switch performs as a querier only when it is elected or it is the only snooping querier on the network.

L2 Report Flooding

L2 report flooding is an IGMP snooping feature that forwards membership report messages to specified ports. Relying on a single switch to maintain and send report messages can degrade performance. L2 report flooding addresses this by facilitating report message forwarding through any network port. This allows switches to bypass the querier when forwarding multicast traffic to its interested ports.

IGMP Snooping Proxy

IGMP snooping proxy is an enhancement over IGMP snooping. When snooping proxy is enabled, the switch starts sending proxy queries periodically to the downstream hosts and collects the IGMP reports and updates the local state. Later, when the switch receives an IGMP query from an upstream router, the switch immediately responds with a report based on its local state.

When IGMP snooping proxy is disabled, the IGMP queries in VLAN, and the reports from hosts are flooded. Enabling IGMP snooping proxy prevents a sudden burst in IGMP report traffic in response to every query. It also reduces the number of reports that the IGMP Querier needs to process in the VLAN. However, it introduces a latency in the propagation of the IGMP state through the VLAN.

15.2.2 IGMP Host Proxy Description

The figure displays a typical IGMP host-proxy implementation. The customer network connects to the sender network through the edge switch's Ethernet 1 interface, which is configured as an IGMP host proxy. PIM is enabled within the sender and customer networks but not on the connection between the networks.

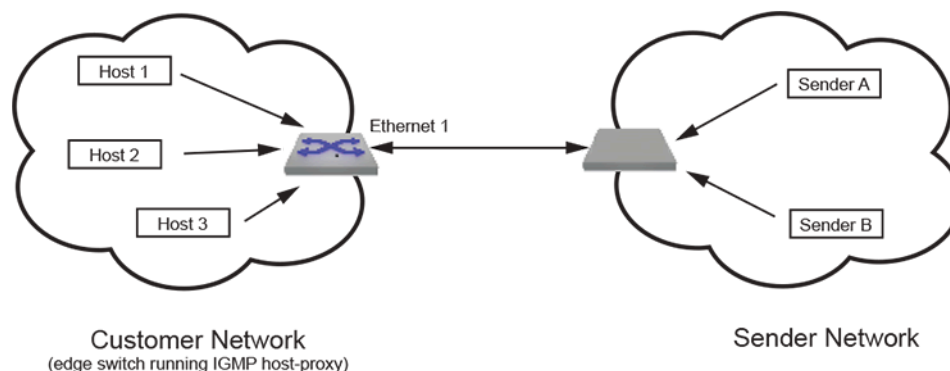

Figure 62: IP IGMP Host Proxy Implementation

The IGMP proxy agent sends unsolicited IGMP joins when a (S,G) or (*,G) entry arrives in the multicast routing table (mroute table). Subsequently, IGMP reports are sent when queries or group-specific queries arrive on the host proxy interface. When the customer network is void of active listeners, the connection eventually expires and the senders stop transmitting to the network.

IGMP host proxy requires the following:

- PIM multicast border router (MBR) must be enabled on the interface.
- IP IGMP and IP multicast must be enabled.
- The switch must be an RP or in each host's RP path.
- Fast-drop entries are required when there are no interested listeners for the group.

IGMP host proxy is configurable to filter for specific multicast groups and sources.

15.2.3 Supported Features

For a list of the IGMP features that each Arista switch platform supports, refer to the supported features table here: <https://www.arista.com/en/support/product-documentation/supported-features>.

15.2.4 IGMP Protocols

- [IGMP](#)
- [IGMP Snooping](#)

15.2.4.1 IGMP

Networks use Internet Group Management Protocol (IGMP) to control the flow of layer 3 multicast traffic. Hosts request and maintain multicast group membership through IGMP messages. Multicast routers use IGMP to maintain a membership list of active multicast groups for each attached network.

- IGMP version 1 is defined in RFC 1112. Hosts can join multicast groups without a method to leave a group. Routers use a timeout-based process to determine when hosts lose interest in a group.
- IGMP version 2 is defined in RFC 2236. Version 2 adds leave messages that hosts use to terminate group membership.
- IGMP version 3 is defined in RFC 4604. Version 3 allows hosts to specify IP addresses within a group from where they receive traffic. Traffic from all other group addresses is blocked from the host.

With respect to each of its attached networks, a multicast router is either a querier or non-querier. Each physical network contains only one querier. A network with more than one multicast router designates the router with the lowest IP address as its querier.

Queriers solicit group membership information by periodically sending General Query messages. Queriers also receive unsolicited messages from hosts joining or leaving a multicast group. When a querier receives a message from a host, it updates its membership list for the group referenced in the message and the network where the message originated.

Queriers forward multicasts from remote sources only to networks as specified by its membership list. If a querier does not receive a report from a network host for a specific group, it removes the corresponding entry from the table and discontinues forwarding multicasts for that group on the network. Queriers also send group-specific queries after receiving a leave request from a host to determine if the network still contains active multicast group members. If it does not receive a membership report during the period defined by the last member query response interval, the querier removes the group-network entry from the membership list.

When a host receives a General Query, it responds with Membership Report messages for each of its multicast groups within the interval specified by the Max Response Time field in the query. IGMP suppresses multiple messages from different hosts on a network for the same group. Hosts send unsolicited Membership reports to join a multicast group and send leave messages to exit a group.

15.2.5 Configuring IGMP

This section describes the following configuration tasks:

- [Enabling IGMP](#)
- [Configuring IGMP Settings](#)

15.2.5.1 Enabling IGMP

Enabling PIM also enables IGMP on that interface. When the switch fills the multicast routing table, it only adds interfaces when the interface receives join messages from downstream devices or when the interface is directly connected to a member of the IGMP group.

By default, PIM and IGMP are disabled on an interface. Use the [pim ipv4 sparse-mode](#) or [pim ipv4 bidirectional](#) command to enable PIM and IGMP on the configuration mode interface.

Example

- This command enables PIM and IGMP on VLAN interface 8.

```
switch(config)#interface vlan 8
switch(config-if-Vl8)#pim ipv4 sparse-mode
switch(config-if-Vl8)#
```

In the unlikely event that the IGMP agent needs to run on an interface without PIM being enabled, use the [ip igmp](#) command.

Example

- This command enables IGMP on VLAN interface 8 without enabling PIM.

```
switch(config)#interface vlan 8
switch(config-if-Vl8)#ip igmp
switch(config-if-Vl8)#
```

15.2.5.2 Configuring IGMP Settings

An interface that runs IGMP uses default protocol settings unless otherwise configured. The switch provides commands that alter startup query, last member query, and normal query settings.

IGMP Version

The switch supports IGMP versions 1 through 3. The [ip igmp version](#) command configures the IGMP version on the configuration mode interface. Version 3 is the default IGMP version.

Example

- This command configures IGMP version 3 on VLAN interface 4

```
switch(config)#interface vlan 4
switch(config-if-Vl4)#ip igmp version 3
switch(config-if-Vl4)#
```

Startup Query

Membership queries are sent at an increased frequency immediately after an interface starts up to quickly establish the group state. Query count and query interval commands adjust the period between membership queries for a specified number of messages.

The `ip igmp startup-query-interval` command specifies the interval between membership queries that an interface sends immediately after it starts up. The `ip igmp startup-query-count` command specifies the number of queries that the switches sends from the interface at the startup interval rate.

Example

- These commands define a startup interval of 15 seconds for the first 10 membership queries sent from VLAN interface 12.

```
switch(config)#interface vlan 12
switch(config-if-Vl12)#ip igmp startup-query-interval 150
switch(config-if-Vl12)#ip igmp startup-query-count 10
switch(config-if-Vl12)#
```

Membership Queries

The router with the lowest IP address on a subnet sends membership queries as the IGMP querier. When a membership query is received from a source with a lower IP address, the router resets its query response timer. Upon timer expiry, the router begins sending membership queries. If the router subsequently receives a membership query originating from a lower IP address, it stops sending membership queries and resets the query response timer.

The `ip igmp query-interval` command configures the frequency at which the active interface, as an IGMP querier, sends membership query messages.

The `igmp query-max-response-time` command configures the time that a host has to respond to a membership query.

Example

- These commands define a membership query interval of 75 seconds and a query response timer reset value of 45 seconds for queries sent from VLAN interface 15.

```
switch(config)#interface vlan 15
switch(config-if-Vl15)#ip igmp query-interval 75
switch(config-if-Vl15)#igmp query-max-response-time 450
switch(config-if-Vl15)#
```

Last Member Query

When the querier receives an IGMP leave message, it verifies the group has no remaining hosts by sending a set of group-specific queries at a specified interval. If the querier does not receive a response to the queries, it removes the group state and discontinues multicast transmissions.

The `ip igmp last-member-query-count` (LMQC) command specifies the number of query messages the router sends in response to a group-specific or group-source-specific leave message.

The `ip igmp last-member-query-interval` command configures the transmission interval for sending group-specific or group-source-specific query messages to the active interface.

Example

- These commands program the switch to send 3 query messages, one every 25 seconds, when VLAN interface 15 receives an IGMP leave message.

```
switch(config)#interface vlan 15
switch(config-if-Vl15)#ip igmp last-member-query-interval 250
switch(config-if-Vl15)#ip igmp last-member-query-count 3
switch(config-if-Vl15)#
```

Static Groups

The `ip igmp static-group` command configures the configuration mode interface as a static member of the multicast group at the specified address. The router forwards multicast group packets through the interface without otherwise appearing or acting as a group member. No interface is a static member of a multicast group by default.

 **Note:** To become a static member of a multicast group, the switch must be the PIM designated router (DR) for the network. If it is not, you can use the `pim ipv4 dr-priority` command to make it the DR by configuring its PIM DR value to be the highest on the network.

Example

- These commands configure VLAN interface 15 as the PIM designated router, then configure it as a static member of the multicast group at address 231.1.1.15 for multicast data packets that originate at 10.1.1.1.

```
switch(config)#interface vlan 15
switch(config-if-Vl15)#pim ipv4 dr-priority 5000
switch(config-if-Vl15)#ip igmp static-group 231.1.1.45 10.1.1.1
switch(config-if-Vl15)#
```

15.2.6 Configuring IGMP Snooping

This section describes the following configuration tasks:

- [Enabling Snooping](#)
- [Configuring Snooping Parameters](#)
- [Snooping Querier](#)
- [IGMP Snooping L2 Report Flooding](#)
- [IGMP Snooping Filters](#)
- [Configuring IGMP Snooping Proxy](#)

15.2.6.1 Enabling Snooping

The switch provides two control settings for snooping IGMP packets:

- Global settings control the availability of IGMP snooping on the switch. Snooping is globally enabled by default.
- Per-VLAN settings control IGMP on individual VLANs. If snooping is enabled on the VLAN, it follows the global snooping state.

The `ip igmp snooping` command controls the global snooping setting. The `ip igmp snooping vlan` command configures snooping on individual VLANs.

Examples

- This command globally enables snooping on the switch.

```
switch(config)#ip igmp snooping
switch(config)#
```

- This command disables snooping on VLANs 2 through 4.

```
switch(config)#no ip igmp snooping vlan 2-4
switch(config)#
```

15.2.6.2 Configuring Snooping Parameters

Specifying a Static Multicast Router Connection

The `ip igmp snooping vlan multicast-router` command statically configures a port that connects to a multicast router to join all multicast groups. The port to the router must be in the specified VLAN range.

Snooping may not always be able to locate the IGMP querier. This command is for IGMP queriers that are known to connect through the network to a port on the switch.

Example

- This command configures the static connection to a multicast router through Ethernet port 3.

```
switch(config)#ip igmp snooping vlan 2 mrouter interface ethernet 3
switch(config)#
```

Adding a Port to a Multicast Group

The `ip igmp snooping vlan member` command adds an a port to a multicast group. The IP address must be an unreserved IPv4 multicast address. The interface to the port must be in the specified VLAN range.

Example

- This command configures the static connection to a multicast group at 237.2.1.4 through Ethernet port 3.

```
switch(config)#ip igmp snooping vlan 7 static 237.2.1.4 interface
ethernet 3
switch(config)#
```

Robustness Variable

The robustness variable specifies the number of unacknowledged snooping queries that a switch sends before removing the recipient from the group list.

The `ip igmp snooping robustness-variable` command configures the robustness variable for all snooping packets sent from the switch. The default value is 2.

Example

- This command sets the robustness-variable value to 3.

```
switch(config)#ip igmp snooping robustness-variable 3
switch(config)#
```

Configuring Interface Startup Initial Query Times

The `ip igmp snooping interface-restart-query` command configures the interface startup initial query times in milliseconds. If nothing is configured, a default value of 2000 milliseconds is used. Issuing the command replaces any values already configured. Multiple values may be input in a single command; this makes the mechanism more resilient in the case of dropped packets.

Examples

- This command configures interfaces to send IGMP queries at 1000, 2000, and 4000 milliseconds (i.e., 1 second, 2 seconds, and 4 seconds) after an interface restart or spanning tree change.

```
switch(config)#ip igmp snooping interface-restart-query 1000 2000 4000
switch(config)#
```

Example

- This command configures interfaces to send a single IGMP query of 5000 milliseconds (5 seconds) after an interface restart or spanning tree change.

```
switch(config)#ip igmp snooping interface-restart-query 5000
switch(config)#
```

15.2.6.3 Snooping Querier

The IGMP snooping querier supports snooping by sending Layer 2 membership queries to hosts attached to the switch. Note that if IGMP snooping is enabled, QoS will not apply to IGMP packets.

15.2.6.3.1 Enabling the Snooping Querier

Enabling the snooping querier on an interface requires the explicit configuration of a global querier address or a local querier address for the interface. See [Configuring Snooping Querier Parameters](#).

The switch provides two control settings for controlling the snooping querier:

- The global setting controls the querier on VLANs for which there is no snooping querier command.
- VLAN querier settings take precedence over the global querier setting.

The [ip igmp snooping querier](#) command controls the global querier setting. When enabled globally, the querier is controlled on individual VLANs through the [ip igmp snooping vlan querier](#) command.

The [ip igmp snooping vlan querier](#) command controls the querier for the specified VLANs. VLANs follow the global querier setting unless overridden by one of these commands:

- [ip igmp snooping vlan querier](#) enables the querier on specified VLANs.
- [no ip igmp snooping vlan querier](#) disables the querier on specified VLANs.

Example

- These commands globally enables the snooping querier on the switch, explicitly disables snooping on VLANs 1-4, and explicitly enables snooping on VLANs 5-8.

```
switch(config)#ip igmp snooping querier
switch(config)#no ip igmp snooping vlan 1-4 querier
switch(config)#ip igmp snooping vlan 5-8 querier
switch(config)#
```

- This command removes the querier setting for VLANs 3-6:

```
switch(config)#default ip igmp snooping vlan 3-6 querier
switch(config)#
```

Globally Set the Snooping Querier Version

The [ip igmp snooping querier version](#) command configures the IGMP snooping querier version. Version 2 is the default IGMP snooping version.

Example

- This command globally configures IGMP snooping querier version 2.

```
switch(config)#ip igmp snooping querier version 2
switch(config)#
```

The `ip igmp snooping vlan querier version` command configures IGMP globally on the VLAN. Version 2 is the default IGMP snooping version.

Example

- This command configures IGMP snooping vlan querier version VLAN 5.

```
switch(config)#ip igmp snooping vlan 5 querier version 2
switch(config)#
```

15.2.6.3.2 Configuring Snooping Querier Parameters**Querier Address**

The switch provides two IP addresses for setting the querier source:

- The global address is used by VLANs for which there is no querier address command.
- VLAN querier address settings take precedence over the global querier address.

The snooping querier address specifies the source IP address for IGMP snooping query packets that the switch transmits. The source address is also used to elect a snooping querier when the subnet contains multiple snooping queriers.

The default global querier address is not defined. When the configuration includes a snooping querier, a querier address must be defined globally or for each interface that enables a querier.

The `ip igmp snooping querier address` command sets the global querier source IP address for the switch. VLANs use the global address unless overwritten with the `ip igmp snooping vlan querier address` command. The default global address is not defined.

The `ip igmp snooping vlan querier address` command sets the source IP address for query packets transmitted from the specified VLAN. This command overrides the `ip igmp snooping querier address` for the specified VLAN.

Examples

- This command sets the source IP address for query packets that the switch transmits to 10.1.1.41

```
switch(config)#ip igmp snooping querier address 10.1.1.41
switch(config)#
```

- This command sets the source IP address for query packets that VLAN 2 transmits to 10.14.1.1.

```
switch(config)#ip igmp snooping vlan 2 querier address 10.14.1.1
switch(config)#
```

Membership Query Interval

The query interval is the period (seconds), between IGMP Membership Query message transmissions. The interval ranges from 5 to 3600 seconds.

The `ip igmp snooping querier query-interval` command specifies the global query interval for packets the switch sends as a snooper querier. The default global setting is 125 seconds.

The `ip igmp snooping vlan querier query-interval` command specifies the query interval for packets sent from the snooping querier to the specified VLAN, overriding the global setting. VLANs that do not specify a query interval use the global setting.

Examples

- This command sets a query interval of 150 seconds for queries transmitted from VLANs for which a query interval is not configured.

```
switch(config)#ip igmp snooping querier query-interval 150
switch(config)#
```

- This command sets the query interval of 240 seconds for queries transmitted from VLAN 2.

```
switch(config)#ip igmp snooping vlan 2 querier query-interval 240
switch(config)#
```

Membership Query Response Interval

The Max Response Time field, in Membership Query messages, specifies the longest time a host can wait before responding with a Membership Report message. In all other messages, the sender sets the field to zero and the receiver ignores it. The switch provides two values for setting this field:

- The global value is used by VLANs for which there is no Max Response Time command.
- VLAN values take precedence over the global value for the specified VLAN.

The `ip igmp snooping querier max-response-time` command specifies the global Max Response Time value used in snooping query packets transmitted from the switch. Values range from 1 to 25 seconds with a default of 10 seconds. VLANs use the global setting unless overwritten with the `ip igmp snooping vlan querier max-response-time` command.

The `ip igmp snooping vlan querier max-response-time` command configures the Max Response Time field contents for packets transmitted from the specified VLAN, overriding the global setting.

Examples

- This command sets the maximum response time of 15 seconds for queries transmitted from VLANs for which a maximum response time is not configured.

```
switch(config)#ip igmp snooping querier max-response-time 15
switch(config)#
```

- This command sets a maximum response time of 5 seconds for queries that VLAN 2 transmits.

```
switch(config)#ip igmp snooping vlan 2 querier max-response-time 5
switch(config)#
```

Last Member Query

When the querier receives an IGMP leave message, it verifies the group has no remaining hosts by sending a set of group-specific queries at a specified interval. If the querier does not receive a response to the queries, it removes the group state and discontinues multicast transmissions.

The switch provides two values for setting this field:

- The global value is used by VLANs for which there is no last-member-query-interval defined.
- VLAN values take precedence over the global value for the specified VLAN.

The `ip igmp snooping querier last-member-query-interval` command specifies the global last-member-query-interval used in snooping query packets transmitted from the switch. This value is used for

VLANs that do not have a value specified. Values range from 1 to 25 seconds with a global default of one second.

The `ip igmp snooping vlan querier last-member-query-interval` command configures the last-member-query-interval field contents for packets transmitted from the specified VLAN, overriding the global setting.

Example

- This command sets the global snooping querier last-member-query-interval to five seconds and the VLAN 10 last-member-query-interval to 12 seconds.

```
switch(config)#ip igmp snooping querier last-member-query-interval 5
switch(config)#ip igmp snooping vlan 10 querier last-member-query-
interval 12
switch(config)#
```

Interface Restart Query Spoofing

When the port status (link status or spanning tree status) changes, an IGMP general query is spoofed based on the information of the last known IGMP querier. This facilitates faster network convergence time.

By default, interfaces wait 2000 milliseconds before sending the spoofed IGMP query. To configure the delay before the spoofed query is sent, use the `ip igmp snooping interface-restart-query` command. This setting is applied to all ports.

Example

- This command configures the switch to send general IGMP queries at 100 milliseconds, 200 milliseconds, and 300 milliseconds after interface restart or spanning tree status change.

```
switch(config)# ip igmp snooping interface-restart-query 100 200 300
```

15.2.6.4 IGMP Snooping L2 Report Flooding

L2 report flooding is an IGMP snooping feature that forwards membership report messages to specified ports. Report flooding is disabled by default and must be enabled globally before it can be enabled on individual interfaces.

The list of ports that can forward membership report messages must be explicitly configured. Commands are available to define lists of ports that are valid for all VLANs and port lists that are valid for specified VLAN ranges. Ports can forward membership reports only if they are configured to handle VLAN traffic, regardless of any report flooding configuration settings.

Enabling L2 Report Flooding

These commands enable L2 report flooding:

- `ip igmp snooping report-flooding` enables report flooding globally.
- `ip igmp snooping vlan report-flooding` enables report flooding on a specified VLAN range.

Example

- These commands enable L2 report flooding globally, and on VLANs 201-205.

```
switch(config)#ip igmp snooping report-flooding
switch(config)#ip igmp snooping vlan 201-205 report-flooding
```

```
switch(config)#
```

Configuring Forwarding Ports

These commands specify the ports that forward membership report messages:

- [ip igmp snooping report-flooding switch-port](#) configures ports globally.
- [ip igmp snooping vlan report-flooding switch-port](#) configures ports for a specified VLAN range.

Example

- These commands enable Ethernet ports 5-9 to forward reports on all VLANs and ports 12-15 on VLANs 201-205.

```
switch(config)#ip igmp snooping report-flooding switch-port ethernet
5-9
switch(config)#ip igmp snooping vlan 201-205 report-flooding switch-
port ethernet
12-15
switch(config)#
```

15.2.6.5 IGMP Snooping Filters

IGMP snooping filters assigns IGMP profiles only to Layer 2 interfaces, and for Layer 3 interfaces use multicast boundary filters to control the multicast groups that the interfaces can join. An IGMP profile specifies a filter type and a list of address ranges. The address ranges comprise the multicast groups covered by the profile. The filter type determines an interface's accessibility to the multicast groups:

- Permit filters define the multicast groups the interface can join.
- Deny filters define the multicast groups the interface cannot join.

Profiles are created in IGMP-profile configuration mode, then applied to an interface in interface configuration mode.

The [ip igmp profile](#) command places the switch in IGMP profile configuration mode. The [permit / deny](#) and [range](#) commands specify the profile's filter type and address range. A profile may contain multiple range statements to define a discontinuous address range.

Example

- These commands create an IGMP profile named list_1 by entering IGMP-profile configuration mode, configure the profile to permit multicast groups 231.22.24.0 through 231.22.24.127, and return the switch to global configuration mode.

```
switch(config)#ip igmp profile list_1
switch(config-igmp-profile-list_1)#permit
switch(config-igmp-profile-list_1)#range 231.22.24.0 231.22.24.127
switch(config-igmp-profile-list_1)#exit
switch(config)#
```

The [ip igmp snooping filter](#) command applies an IGMP profile to the configuration mode interface.

Example

- These commands apply the list_1 snooping profile to Ethernet interface 7.

```
switch(config)#interface ethernet 7
switch(config-if-Et7)#ip igmp snooping filter list_1
switch(config-if-Et7)#
```

15.2.6.5.1 Verifying IGMP Snooping

Show commands are available to display various configurations and IGMP snooping status. IGMP snooping that are viewable include:

- **show ip igmp snooping**
- **show ip igmp snooping counters**
- **show igmp snooping querier**
- **show igmp snooping querier counters**
- **show igmp snooping querier membership**

IGMP Snooping Status

The [show ip igmp snooping](#) command displays the switch's IGMP snooping configuration.

Example

- This command displays the switch's IGMP snooping configuration.

```
switch>show ip igmp snooping
  Global IGMP Snooping configuration:
-----
IGMP snooping                : Enabled
Robustness variable          : 2

Vlan 1 :
-----
IGMP snooping                : Enabled
Multicast router learning mode : pim-dvmrp

Vlan 20 :
-----
IGMP snooping                : Enabled
Multicast router learning mode : pim-dvmrp

Vlan 2028 :

switch>
```

IGMP Snooping Counters

The [show ip igmp snooping counters](#) command displays the number of IGMP messages sent and received through each switch port. The display table sorts the messages by type.

Example

- This command displays the number of messages received on each port.

```
switch>show ip igmp snooping counters
          Input
Port  Queries Reports  Leaves  Others  Errors | Queries Reports  Leaves
  Others
-----
Cpu      15249  106599      4 269502      0  30242  102812   972
 3625
Et1         0      0      0      0      0      0      0      0
 0
Et2         0      6      1     26      0   5415      0      0
 731
```

Et3	0	10905	222	1037	0	15246	0	0
1448								
Et4	0	44475	21	288	0	15247	0	0
2199								
Et5	0	355	0	39	0	15211	0	0
2446								
Et6	0	475	13	0	0	15247	0	0
2487								
Et7	0	0	0	151	0	15247	0	0
2336								
Et8	0	578	6	75	0	2859	0	0
931								
Et9	0	0	0	27	0	15247	0	0
2460								
Et10	0	12523	345	54	0	15247	0	0
2433								
Et11	0	0	0	0	0	0	0	0
0								
Et12	0	4509	41	22	0	15247	0	0
2465								
Et13	0	392	29	119	0	15247	0	0
2368								
Et14	0	88	3	6	0	15247	0	0
2481								
Et15	0	16779	556	72	0	15117	0	0
66								
Et16	0	2484	13	66	0	15247	0	0
2421								
Et17	0	0	0	0	0	0	0	0
0								
Et18	0	20	6	160	0	3688	0	0
803								
Et19	0	4110	17	0	0	15247	0	0
2487								
Et20	0	0	0	0	0	0	0	0
0								
Et21	0	0	0	0	0	0	0	0
0								
Et22	0	0	0	52	0	15247	0	0
2435								
Et23	0	5439	181	138	0	15247	0	0
2349								
Et24	0	2251	21	4	0	15247	0	0
2483								
Po1	45360	540670	8853	464900	0	15249	224751	618
2576								
Po2	0	101399	58	17	0	15120	0	0
1121								
Switch	0	0	0	0	0	0	0	0
0								

IGMP Snooping Querier

The `show igmp snooping querier` command displays snooping querier configuration and status information. Command provides options to only include specific VLANs.

Example

- This command displays the querier IP address, version, and port servicing each VLAN.

```
switch>show igmp snooping querier
Vlan IP Address      Version Port
```

```

-----
1      172.17.0.37      v2      Po1
20     172.17.20.1     v2      Po1
26     172.17.26.1     v2      Cpu
2028   172.17.255.29  v2      Po1
switch>

```

IGMP Snooping Querier Counters

The `show igmp snooping querier counters` command displays the counters from the querier, as learned through Internet Group Management Protocol (IGMP).

Example

- This command displays the counters from the querier.

```

switch>show igmp snooping querier counters
-----
Vlan: 1      IP Addr: 100.0.0.1      Op State: Querier      Version:  v3

v1 General Queries Sent      :0
v1 Queries Received          :0
v1 Reports Received          :0
v2 General Queries Sent      :1
v2 Queries Received          :0
v2 Reports Received          :25
v2 Leaves Received           :0
v3 General Queries Sent      :655
v3 GSQ Queries Sent          :0
v3 GSSQ Queries Sent         :8
v3 Queries Received          :654
v3 Reports Received          :2385
Error Packets                 :0
Other Packets                 :0
switch>

```

IGMP Snooping Querier Membership

The `show igmp snooping querier membership` command displays the membership from the querier, as learned through Internet Group Management Protocol (IGMP).

Example

- This command displays the membership from the querier fro VLAN 1.

```

switch>show igmp snooping querier membership
-----
-----
Vlan: 1      Elected: 100.0.0.1      QQI: 125  QRV: 2  QRI: 10  GMI:
260

Groups      Mode  Ver  Num of Sources
-----
-----
10.0.0.2    EX    v3   0 [ ]
10.0.0.3    IN    v3   2 [ 3.3.3.3, 3.3.3.4 ]
10.0.0.4    EX    v3   0 [ ]
10.0.0.13   EX    v3   0 [ ]
10.0.0.22   EX    v3   0 [ ]
10.0.0.1    IN    v3   3 [ 5.6.7.9, 5.6.7.8, ... ]

```

```
switch>
```

15.2.6.6 Configuring IGMP Snooping Proxy

Use the `ip igmp snooping proxy` command to enable IGMP snooping proxy globally. Enabling IGMP snooping proxy enables it for all VLANs where IGMP snooping is enabled. IGMP snooping proxy is globally disabled by default.

Use the `ip igmp snooping proxy` command to enable IGMP snooping proxy globally. Use the `no ip igmp snooping vlan proxy` command to disable IGMP snooping proxy on specified VLANs.

Examples

This command globally enables IGMP snooping proxy on the switch.

```
switch(config)#ip igmp snooping proxy
switch(config)#
```

This command disables IGMP snooping proxy on VLANs 2 through 4.

```
switch(config)#no ip igmp snooping proxy vlan 2-4 proxy
switch(config)#
```

15.2.6.6.1 Configuring Snooping Proxy Querier

To configure the IGMP snooping proxy querier use the existing `ip igmp snooping querier` commands. For more information on these commands, refer to [IGMP and IGMP Snooping Commands](#).

 **Note:** The proxy querier by default uses 0.0.0.0 IP address.

Example:

In this example, IGMP snooping proxy is enabled using the `ip igmp snooping proxy` command and the snooping proxy is set to reports for all the VLANs except VLANs 100 through 110 using the `ip igmp snooping vlan` command. The proxy querier operates in version 3 and sends queries at a 15-second interval and hosts can take up to 5 seconds to respond.

```
switch(config)#ip igmp snooping proxy
switch(config)#no ip igmp snooping vlan 100-110 proxy
switch(config)#ip igmp snooping querier query-interval 15
switch(config)#ip igmp snooping querier max-response-time 5
switch(config)#ip igmp snooping querier version 3
switch(config)#ip igmp snooping querier
switch(config)#
```

15.2.7 IGMP Host Proxy

Interfaces on the switch can be configured to serve as IGMP host proxies. An IGMP host proxy exchanges IGMP reports (joins/leaves) between networks whose connection does not support PIM along network boundaries.

- [IGMP Host Proxy Description](#)
- [IGMP Host Proxy Configuration](#)

15.2.7.1 IGMP Host Proxy Description

The figure displays a typical IGMP host-proxy implementation. The customer network connects to the sender network through the edge switch's Ethernet 1 interface, which is configured as an IGMP host proxy. PIM is enabled within the sender and customer networks but not on the connection between the networks.

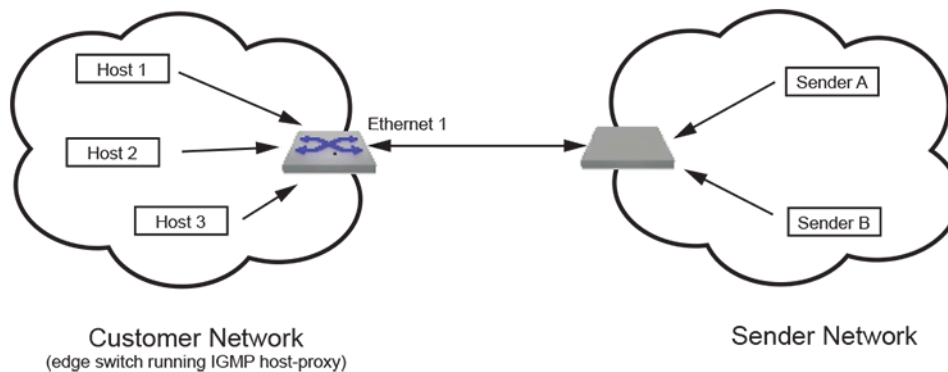

Figure 63: IP IGMP Host Proxy Implementation

The IGMP proxy agent sends unsolicited IGMP joins when a (S,G) or (*,G) entry arrives in the multicast routing table (mroute table). Subsequently, IGMP reports are sent when queries or group-specific queries arrive on the host proxy interface. When the customer network is void of active listeners, the connection eventually expires and the senders stop transmitting to the network.

IGMP host proxy requires the following:

- PIM multicast border router (MBR) must be enabled on the interface.
- IP IGMP and IP multicast must be enabled.
- The switch must be an RP or in each host's RP path.
- Fast-drop entries are required when there are no interested listeners for the group.

IGMP host proxy is configurable to filter for specific multicast groups and sources.

15.2.7.2 IGMP Host Proxy Configuration

Enabling IGMP Host Proxy

Enable PIM MBR on the interface using the `pim ipv4 border-router` command. The IGMP host proxy service is then configured on the interface using the `ip igmp host-proxy` command. When the host proxy is configured, it sends reports for (S,G) entries in the multicast routing (mroute) table if these are the only routes there; if there are any (*,G) entries, it sends reports only for these. To send reports for a specific group even when there is no (*, G) entry in the mroute table for that group, include the group address in the `ip igmp host-proxy` command. Multiple `ip igmp host-proxy` statements are required to specify multiple groups. The interval between IGMP reports is configured by `ip igmp host-proxy report-interval`.

Host Proxy IGMP Version and Source Filtering

IGMP host proxies can be configured with IGMP versions 1, 2, or 3, and use version 3 by default. When the host-proxy IGMP version is set to 3, the proxy can explicitly include or exclude source addresses. Otherwise, include/exclude configuration for source addresses is ignored. The IGMP version of unsolicited reports is specified with the `ip igmp host-proxy version` command. Reports that are triggered by IGMP queries, however, are sent in the same IGMP version as the received query. (An interface may also have a different IGMP version configured on it for other purposes using the `ip igmp version` command.)

Using ACLs

IGMP host proxy can also be enabled for the addresses defined by an ACL; if one or more groups are configured in addition to ACLs, the groups are processed first. Implicit deny in the ACL is ignored, but if the ACL includes an explicit deny rule, then the interface sends joins only to groups configured directly on the interface or included in a permit ACL. Deny rules take precedence over permit rules. If a group is configured with no filters and a host-proxy is configured with an ACL with rules having filters for the group, or configured with groups and source filters, then the filters are applied to the group.

Disabling Host Proxy or Removing an Individual Group or Source

The `no igmp host-proxy` command can be entered with group or source parameters to remove the specified group or source from the list. Entering the `no igmp host-proxy` command without specifying group or source disables the forwarding of all IGMP reports on the interface.

Examples

- These commands enable IGMP host proxy on Ethernet interface 17 for all multicast group addresses.

```
switch(config)#interface ethernet 17
switch(config-if-Et17)#pim ipv4 border-router
switch(config-if-Et17)#ip igmp host-proxy
switch(config-if-Et17)#
```

- These commands enable IGMP host proxy on Ethernet interface 18 for the multicast group at 231.10.10.1. The list of source addresses is not restricted.

```
switch(config)#interface ethernet 18
switch(config-if-Et18)#pim ipv4 border-router
switch(config-if-Et18)#ip igmp host-proxy 231.10.10.1
switch(config-if-Et18)#
```

- These commands enable IGMP host proxy on Ethernet interface 19 for the multicast group at 231.10.10.2. The list of source addresses only excludes 10.4.4.1 and 10.4.5.2.

```
switch(config)#interface ethernet 19
switch(config-if-Et19)#pim ipv4 border-router
switch(config-if-Et19)#ip igmp host-proxy 231.10.10.2 exclude 10.4.4.1
switch(config-if-Et19)#ip igmp host-proxy 231.10.10.2 exclude 10.4.5.2
switch(config-if-Et19)#
```

- These commands enable IGMP host proxy on Ethernet interface 16 for the multicast group at 231.10.10.3. The list of source address for this group only includes 10.5.5.1 and 10.5.5.2

```
switch(config)#interface ethernet 16
switch(config-if-Et16)#pim ipv4 border-router
switch(config-if-Et16)#ip igmp host-proxy 231.10.10.3 include 10.5.5.1
switch(config-if-Et16)#ip igmp host-proxy 231.10.10.3 include 10.5.5.2
switch(config-if-Et16)#
```

- These commands configure an IGMP host proxy interval of five seconds on port channel 100.

```
switch(config)#interface port-channel 100
switch(config-if-Po100)#ip igmp host-proxy report-interval 5
switch(config-if-Po100)#
```

- These commands enable IGMP host proxy on Ethernet interface 17 for the group address(es) specified in ACL "acl1."

```
switch(config)#interface ethernet 17
```

```
switch(config-if-Et17) #pim ipv4 border-router  
switch(config-if-Et17) #ip igmp host-proxy access-list acl1  
switch(config-if-Et17) #
```

15.2.8 IGMP and IGMP Snooping Commands

IGMP Configuration Commands (Interface Configuration Mode)

- `igmp query-max-response-time`
- `ip igmp last-member-query-count`
- `ip igmp last-member-query-interval`
- `ip igmp query-interval`
- `ip igmp router-alert`
- `ip igmp startup-query-count`
- `ip igmp startup-query-interval`
- `ip igmp static-group`
- `ip igmp static-group acl`
- `ip igmp static-group range`
- `ip igmp version`

IGMP Clear Commands

- `clear ip igmp group`
- `clear ip igmp statistics`

IGMP Display Commands

- `show ip igmp groups`
- `show ip igmp groups count`
- `show ip igmp interface`
- `show ip igmp static-groups`
- `show ip igmp static-groups acl`
- `show ip igmp static-groups group`
- `show ip igmp statistics`

IGMP Snooping Configuration Commands (Global Configuration Mode)

- `ip igmp`
- `ip igmp profile`
- `ip igmp snooping`
- `ip igmp snooping interface-restart-query`
- `ip igmp snooping proxy`
- `ip igmp snooping querier`
- `ip igmp snooping querier address`
- `ip igmp snooping querier last-member-query-count`
- `ip igmp snooping querier last-member-query-interval`
- `ip igmp snooping querier max-response-time`
- `ip igmp snooping querier query-interval`
- `ip igmp snooping querier startup-query-count`
- `ip igmp snooping querier startup-query-interval`
- `ip igmp snooping querier version`
- `ip igmp snooping report-flooding`
- `ip igmp snooping report-flooding switch-port`
- `ip igmp snooping restart query-interval`
- `ip igmp snooping robustness-variable`

- ip igmp snooping vlan
- ip igmp snooping vlan fast-leave
- ip igmp snooping vlan max-groups
- ip igmp snooping vlan member
- ip igmp snooping vlan multicast-router
- ip igmp snooping vlan proxy
- ip igmp snooping vlan querier
- ip igmp snooping vlan querier address
- ip igmp snooping vlan querier last-member-query-count
- ip igmp snooping vlan querier last-member-query-interval
- ip igmp snooping vlan querier max-response-time
- ip igmp snooping vlan querier query-interval
- ip igmp snooping vlan querier startup-query-count
- ip igmp snooping vlan querier startup-query-interval
- ip igmp snooping vlan querier version
- ip igmp snooping vlan report-flooding
- ip igmp snooping vlan report-flooding switch-port

IGMP Configuration Commands (Interface Configuration Mode)

- ip igmp snooping filter

IGMP Snooping Clear Commands

- clear ip igmp snooping counters

IGMP Snooping Display Commands

- show igmp snooping querier
- show igmp snooping querier counters
- show igmp snooping querier membership
- show ip igmp profile
- show ip igmp snooping
- show ip igmp snooping counters
- show ip igmp snooping counters ethdev-pams
- show ip igmp snooping groups
- show ip igmp snooping groups count
- show ip igmp snooping mrouter
- show ip igmp snooping report-flooding

IGMP Profile Configuration Mode Commands

- permit / deny
- range

IGMP Host Proxy Commands

- ip igmp host-proxy
- ip igmp host-proxy report-interval
- ip igmp host-proxy version
- show ip igmp host-proxy config-sanity
- show ip igmp host-proxy interface

15.2.8.1 clear ip igmp group

The `clear ip igmp group` command deletes IGMP cache entries as follows:

- `clear ip igmp group` all entries from the IGMP cache.
- `clear ip igmp group gp_addr` all entries for a specified multicast group.
- `clear ip igmp group interface int_id` all entries that include a specified interface.
- `clear ip igmp group gp_addr interface int_id` all entries for a specified interface in a specified group.

Command Mode

Privileged EXEC

Command Syntax

```
clear ip igmp group [ gp_addr ] [ interface INT_ID ]
```

Parameters

- *gp_addr* multicast group IP address (dotted decimal notation).
- INT_ID interface name. Options include:
 - **ethernet** *e_num* Ethernet interface specified by *e_num*.
 - **loopback** *l_num* Loopback interface specified by *l_num*.
 - **management** *m_num* Management interface specified by *m_num*.
 - **port-channel** *p_num* Port-channel interface specified by *p_num*.
 - **vlan** *v_num* VLAN interface specified by *v_num*.
 - **vxlan** *vx_num* VXLAN interface specified by *vx_num*.

Examples

- This command deletes all IGMP cache entries for the multicast group 231.23.23.14.

```
switch#clear ip igmp group 231.23.23.14  
switch#
```

- This command deletes IGMP cache entries for Ethernet interface 16 in multicast group 226.45.10.45.

```
switch#clear ip igmp group 226.45.10.45 interface ethernet 16  
switch#
```

15.2.8.2 clear ip igmp snooping counters

The **clear ip igmp snooping counters** command resets the snooping message counters for the specified interface. The snooping counters for all interfaces are reset if the command does not include an interface name.

The **show ip igmp snooping counters** command displays the counter contents. See the [show ip igmp snooping counters](#) command description for a list of available snooping counters.

Command Mode

Privileged EXEC

Command Syntax

```
clear ip igmp snooping counters [ INT_NAME ]
```

Parameters

- INT_NAME interface name. Formats include:
 - **ethernet** *e_num* Ethernet interface specified by *e_num*.
 - **port-channel** *p_num* Port-channel interface specified by *p_num*.
 - **switch** virtual interface to an L2 querier.

Example

- This command clears the snooping counters for messages received on Ethernet interface 15.

```
switch(config)#clear ip igmp snooping counters ethernet 15
switch(config)#
```

15.2.8.3 clear ip igmp statistics

The `clear ip igmp statistics` command resets IGMP transmission statistic counters for the specified interface.

Command Mode

Privileged EXEC

Command Syntax

```
clear ip igmp statistics [ INTF_ID ]
```

Parameters

- INTF_ID nterface name. Options include:
 - <no parameter> all interfaces.
 - **interface ethernet** *e_num* Ethernet interface specified by *e_num*.
 - **interface loopback** *l_num* Loopback interface specified by *l_num*.
 - **interface management** *m_num* Management interface specified by *m_num*.
 - **interface port-channel** *p_num* Port-channel interface specified by *p_num*.
 - **interface vlan** *v_num* VLAN interface specified by *v_num*.
 - **interface xlan** *vx_num* VXLAN interface specified by *vx_num*.

Examples

- This command resets IGMP transmission statistic counters on Ethernet 1 interface.

```
switch#clear ip igmp statistics interface ethernet 1  
switch#
```

15.2.8.4 igmp query-max-response-time

The **igmp query-max-response-time** command configures the query-max-response-time variable for the configuration mode interface. This variable is used to set the Max Response Time field in outbound Membership Query messages. Max Response Time specifies the maximum period a recipient can wait before responding with a Membership Report.

The router with the lowest IP address on a subnet sends membership queries as the IGMP querier. When a membership query is received from a source with a lower IP address, the router resets its query response timer. Upon timer expiry, the router begins sending membership queries. If the router subsequently receives a membership query originating from a lower IP address, it stops sending membership queries and resets the query response timer.

The **no igmp query-max-response-time** and **default igmp query-max-response-time** commands restore the default query-max-response-time of 10 seconds for the configuration mode interface by removing the corresponding **igmp query max-response-time** command from **running-config**.

Command Mode

Interface-Ethernet Configuration

Interface-Port-Channel Configuration

Interface-VLAN Configuration

Command Syntax

```
igmp query-max-response-time period
```

```
no igmp query-max-response-time
```

```
default igmp query-max-response-time
```

Parameters

- *period* maximum response time (deciseconds). Values range from 1 to 31744 (52 minutes, 54 seconds). Default is 100 (ten seconds).

Example

- This command configures the query-max-response-time of 18 seconds for VLAN interface 4.

```
switch(config)#interface vlan 4
switch(config-if-Vl4)# igmp query-max-response-time 180
switch(config-if-Vl4)#
```

15.2.8.5 ip igmp host-proxy report-interval

The `ip igmp host-proxy report-interval` command configures the period between unsolicited join reports that the switch sends as an IGMP host proxy from the configuration mode interface to a sender network after a (S,G) or (*,G) entry arrives in the multicast route (mroute) table. When the interface receives a query in response, this interval is set to the [ip igmp last-member-query-interval](#). This command also enables the host proxy on the configuration mode interface if it was not previously enabled.

The `no ip igmp host-proxy report-interval` and `default ip igmp host-proxy report-interval` commands reset the query interval to the default value of one second by removing the corresponding `ip igmp host-proxy report-interval` command from running-config. The `no ip igmp host-proxy` and `default ip igmp host-proxy` commands also remove the corresponding `report-interval` command.

Command Mode

Interface-Ethernet Configuration

Interface-Port-Channel Configuration

Interface-VLAN Configuration

Command Syntax

```
ip igmp host-proxy report-interval period
```

```
no ip igmp host-proxy report-interval
```

```
default ip igmp host-proxy report-interval
```

Parameters

- *period* transmission interval (seconds) between consecutive reports. Value range: 1 (one second) to 31744 (8 hours, 49 minutes, 4 seconds). Default is 1 (one second).

Example

- These commands configures a IGMP host proxy interval of five seconds on port channel 100.

```
switch(config)#interface port-channel 100
switch(config-if-Po100)#ip igmp host-proxy report-interval 5
switch(config-if-Po100)#
```

15.2.8.6 ip igmp host-proxy version

The **ip igmp host-proxy version** command configures the version number to be used in unsolicited reports when the interface is serving as an IGMP host proxy. To configure the IGMP version used by the interface for other purposes, use the [ip igmp version](#) command instead.

The **no ip igmp host-proxy version** and **default ip igmp host-proxy version** commands reset the version to the default value of 3.

Command Mode

Interface-Ethernet Configuration

Interface-Port-Channel Configuration

Interface-VLAN Configuration

Command Syntax

```
ip igmp host-proxy version version_number
```

```
no ip igmp host-proxy version
```

```
default ip igmp host-proxy version
```

Parameters

- *version_number* values range from 1 to 3. The default value is 3.

Example

- These commands configure the IGMP host proxy version on port channel interface 100 to 2.

```
switch(config)#interface port-channel 100
switch(config-if-Po100)#ip igmp host-proxy version 2
switch(config-if-Po100)#
```

15.2.8.7 ip igmp host-proxy

The `ip igmp host-proxy` command enables the IGMP host proxy service on the configuration mode interface. The IGMP host proxy performs IGMP joins and leaves between networks that are directly connected by an exchange that does not support PIM on the network boundary.

 **Note:** For an interface to serve as an IGMP host proxy, PIM MBR must also be enabled on that interface using the `pim ipv4 border-router` command.

The IGMP host proxy sends unsolicited IGMP join reports when an (S,G) or (*,G) entry arrives in the multicast routing (mroute) table. Reports are subsequently sent upon the arrival of queries on the interface. The interval between IGMP reports is configured through `ip igmp host-proxy report-interval`.

The `ip igmp host-proxy` command can also specify a group address; this ensures that reports are generated for the specified group even if there is no (*,G) entry in the mroute table for that group. Multiple `ip igmp host-proxy` statements are required to specify multiple groups.

When the host proxy IGMP version is set to 3 using the `ip igmp host-proxy version` command, the `ip igmp host-proxy` command can also include or exclude source addresses. These options are ignored when the interface runs host proxy IGMP version 1 or 2. Note that the IGMP version set using the `ip igmp version` command does not affect host proxy behavior.

An ACL can also be used in place of a group address by using the `access-list` option. If one or more groups are configured in addition to ACLs, the groups are processed first. Implicit deny in the ACL is ignored, but if the ACL includes an explicit deny rule, then the interface sends joins only to groups configured directly on the interface or included in a permit ACL. Deny rules take precedence over permit rules. If a group is configured with no filters and a host-proxy is configured with an ACL with rules having filters for the group, or configured with groups and source filters, then the filters are applied to the group.

The `no ip igmp host-proxy` and `default ip igmp host-proxy` commands remove the corresponding `ip igmp host-proxy` command from `running-config`. When these commands do not include a group address, all `ip igmp host-proxy` statements are deleted. When inclusion or exclusion parameters are not specified, all statements with the specified group address are deleted.

Command Mode

Interface-Ethernet Configuration

Interface-Port-Channel Configuration

Interface-VLAN Configuration

Command Syntax

```
ip igmp host-proxy [ GROUP_ADDRESS [SOURCE_ADDRESS ]] | [ access-list acl]
```

```
no ip igmp host-proxy [ GROUP_ADDRESS [ SOURCE_ADDRESS ]]
```

```
default ip igmp host-proxy [ GROUP_ADDRESS [SOURCE_ADDRESS]]
```

Parameters

- **GROUP_ADDRESS** IPv4 address of group address for which host proxy sends reports.
 - `<no parameter>` only groups for which there is a (*,G) entry in the mroute table.
 - `ipv4_address` IP address of multicast group (dotted decimal notation). This ensures that reports are generated for this group even if it does not have a (*,G) entry in the mroute table.
- **SOURCE_ADDRESS** IP address of a host that originates multicast data packets.
 - `<no parameter>` Proxy sends report for all received or configured groups regardless of source address.
 - `exclude ipv4_address` Proxy does not send reports for specified source address.
 - `include ipv4_address` Proxy always sends reports for specified source address.

Commands that list at least one parameter must specify a group address. Parameters may be listed in any order. When a command specifies include and exclude parameters, the exclude parameter is ignored.

- **access-list** *acl* specifies an access control list (ACL); a join is sent for all groups and/or sources obtained by processing the rules from all configured ACLs.
- **version** *version* specifies the IGMP version on IGMP host-proxy interface. The value ranges from 1 to 3. Default value is 3.

Guidelines

Multiple statements for a group address may be configured. The effect of entering a command depends on previously entered commands. The following describes command combination:

- **ip igmp host-proxy**: IGMP host proxy is enabled for all multicast groups and their source addresses. When enabled for all group addresses, the source address list cannot be restricted.
- **ip igmp host-proxy** *group_ipv4*: IGMP host proxy is enabled for a specified multicast group. The list of source addresses for this group is not restricted. Enabling host proxy for another group address requires another **ip igmp host-proxy** command.
- **ip igmp host-proxy** *group_ipv4* **exclude** *source_ipv4*: IGMP host proxy is enabled for the specified multicast group. Sources for this group include all addresses not in an exclude statement. Multiple source addresses for the group are excluded by multiple statements.
- **ip igmp host-proxy** *group_ipv4* **include** *source_ipv4*: IGMP host proxy is enabled for the specified group address for only the specified source address. Additional statements are required to include other source addresses for the group. The presence of one include parameter invalidates all exclude statements for the specified multicast group.
- **ip igmp host-proxy access-list** *acl*: IGMP host proxy is enabled for the addresses defined by the specified ACL. If one or more groups are configured in addition to ACLs, the groups are processed first. If the ACL has a “deny all” rule for a group, then this filter takes precedence over configurations with include /exclude keywords or permit/deny rules for that group. If a group is configured with no filters and a host-proxy is configured with an ACL with rules having filters for the group, or configured with groups and source filters, then the filters are applied to the group.

Example

- These commands enable IGMP host proxy on Ethernet interface 17 for all multicast group addresses.

```
switch(config)#interface ethernet 17
switch(config-if-Et17)#pim ipv4 border-router
switch(config-if-Et17)#ip igmp host-proxy
switch(config-if-Et17)#
```

- These commands enable IGMP host proxy on Ethernet interface 17 for the multicast group at 231.10.10.1. The list of source addresses is not restricted.

```
switch(config)#interface ethernet 17
switch(config-if-Et17)#pim ipv4 border-router
switch(config-if-Et17)#ip igmp host-proxy 231.10.10.1
switch(config-if-Et17)#
```

- These commands enable IGMP host proxy on Ethernet interface 17 for the multicast group at 231.10.10.2. The list of source addresses only excludes 10.4.4.1 and 10.4.5.2.

```
switch(config)#interface ethernet 17
switch(config-if-Et17)#pim ipv4 border-router
switch(config-if-Et17)#ip igmp host-proxy 231.10.10.2 exclude 10.4.4.1
switch(config-if-Et17)#ip igmp host-proxy 231.10.10.2 exclude 10.4.5.2
switch(config-if-Et17)#
```

-
- These commands enable IGMP host proxy on Ethernet interface 17 for the multicast group at 231.10.10.3. The list of source address for this group only includes 10.5.5.1 and 10.5.5.2

```
switch(config)#interface ethernet 17
switch(config-if-Et17)#pim ipv4 border-router
switch(config-if-Et17)#ip igmp host-proxy 231.10.10.3 include 10.5.5.1
switch(config-if-Et17)#ip igmp host-proxy 231.10.10.3 include 10.5.5.2
switch(config-if-Et17)#
```

- These commands enable IGMP host proxy on Ethernet interface 17 for the group address(es) specified in ACL "acl1"

```
switch(config)#interface ethernet 17
switch(config-if-Et17)#pim ipv4 border-router
switch(config-if-Et17)#ip igmp host-proxy access-list acl1
switch(config-if-Et17)#
```

15.2.8.8 ip igmp last-member-query-count

The `ip igmp last-member-query-count` command specifies the number of query messages the switch sends in response to a group-specific or group-source-specific leave message.

After receiving a message from a host leaving a group, the switch sends query messages at intervals specified by `ip igmp last-member-query-interval`. If the switch does not receive a response to the queries after sending the number of messages specified by this parameter, it stops forwarding messages to the host.

Setting the last member query count (LMQC) to 1 causes the loss of a single packet to stop traffic forwarding. While the switch can start forwarding traffic again after receiving a response to the next general query, the host may not receive that query for a period defined by `ip igmp query-interval`.

The `no ip igmp last-member-query-count` and `default ip igmp last-member-query-count` commands reset the LMQC to the default value by removing the corresponding `ip igmp last-member-query-count` command from *running-config*.

Command Mode

Interface-Ethernet Configuration

Interface-Port-Channel Configuration

Interface-VLAN Configuration

Command Syntax

```
ip igmp last-member-query-count number
```

```
no ip igmp last-member-query-count
```

```
default ip igmp last-member-query-count
```

Parameters

- *number* query message quantity. Values range from 0 to 3. Default is 2.

Example

- This command configures the last-member-query-count to 3 on VLAN interface 4.

```
switch(config)#interface vlan 4
switch(config-if-Vl4)#ip igmp last-member-query-count 3
switch(config-if-Vl4)#
```

15.2.8.9 ip igmp last-member-query-interval

The `ip igmp last-member-query-interval` command configures the switch's transmission interval for sending group-specific or group-source-specific query messages from the configuration mode interface.

When a switch receives a message from a host that is leaving a group it sends query messages at intervals set by this command. The `ip igmp startup-query-count` specifies the number of messages that are sent before the switch stops forwarding packets to the host.

If the switch does not receive a response after this period, it stops forwarding traffic to the host on behalf of the group, source, or channel.

The `no ip igmp last-member-query-interval` and `default ip igmp last-member-query-interval` commands reset the query interval to the default value of one second by removing the `ip igmp last-member-query-interval` command from *running-config*.

Command Mode

Interface-Ethernet Configuration

Interface-Port-Channel Configuration

Interface-VLAN Configuration

Command Syntax

```
ip igmp last-member-query-interval period
```

```
no ip igmp last-member-query-interval
```

```
default ip igmp last-member-query-interval
```

Parameters

- *period* transmission interval (deciseconds) between consecutive group-specific query messages.
Value range: 10 (one second) to 317440 (8 hours, 49 minutes, 4 seconds). Default is 10 (one second).

Example

- This command configures the last member query interval of 6 seconds for VLAN interface 4.

```
switch(config)#interface vlan 4
switch(config-if-Vl4)#ip igmp last-member-query-interval 60
switch(config-if-Vl4)#
```

15.2.8.10 ip igmp profile

The `ip igmp profile` command places the switch in IGMP-profile configuration mode to configure an IGMP profile. IGMP profiles control the multicast groups that an interface can join.

Profiles consist of the filter type and an address range:

- Filter types specify accessibility to the listed address range:
 - Permit filters define the multicast groups the interface can join.
 - Deny filters define the multicast groups the interface cannot join.

Profiles are deny filters by default.

- Address ranges specify a list of addresses and ranges:
 - In permit filters, permitted groups are specified by the address range.
 - In deny filters, all groups are permitted except those specified by the address range.

Implementing IGMP filtering affects IGMP report forwarding as follows:

- IGMPv2: Report is forwarded to mrouter for permitted groups and dropped for disallowed groups.
- IGMPv3: There may be multiple group records in a report.
 - No groups are allowed: The report is dropped.
 - All groups are allowed: The report is forwarded to mrouter ports as normal.
 - Some groups are allowed: A revised report is forwarded to mrouter ports.

The revised report includes records for the allowed group addresses with the same source MAC and IP addresses.

The `no ip igmp profile` and `default ip igmp profile` commands delete the specified IGMP profile from *running-config*.

IGMP-profile configuration mode is not a group change mode; running-config is changed immediately upon entering commands. Exiting IGMP-profile configuration mode does not affect the configuration. The `exit` command returns the switch to global configuration mode.

Command Mode

Global Configuration

Command Syntax

```
ip igmp profile profile_name
no ip igmp profile profile_name
default igmp profile profile_name
```

Parameters

- *profile_name* name of the IGMP profile.

Commands Available in igmp-profile Configuration Mode

- [permit / deny](#)
- [range](#)

Related Commands

- [ip igmp snooping filter](#) applies an IGMP snooping filter to a configuration mode interface.

Example

- These commands enter IGMP-profile configuration mode and configure the profile as a permit list.

```
switch(config)#ip igmp profile list_1
switch(config-igmp-profile-list_1)#permit
```

```
switch(config-igmp-profile-list_1)#
```

15.2.8.11 ip igmp query-interval

The **ip igmp query-interval** command configures the frequency at which the configuration mode interface, as an IGMP querier, sends host-query messages.

An IGMP querier sends host-query messages to discover the multicast groups that have members on networks attached to the interface. The switch implements a default query interval of 125 seconds.

The **no ip igmp query-interval** and **default ip igmp query-interval** commands reset the IGMP query interval to the default value of 125 seconds by removing the **ip igmp query-interval** command from *running-config*.

Command Mode

Interface-Ethernet Configuration

Interface-Port-Channel Configuration

Interface-VLAN Configuration

Command Syntax

```
ip igmp query-interval period
```

```
no ip igmp query-interval
```

```
default ip igmp query-interval
```

Parameters

- *period* interval (seconds) between IGMP query messages. Values range from 1 to 3175 (52 minutes, 55 seconds). Default is 125.

Example

- This command configures the query-interval of 2 minutes, 30 seconds for VLAN interface 4.

```
switch(config)#interface vlan 4
switch(config-if-Vl4)#ip igmp query-interval 150
switch(config-if-Vl4)#
```

15.2.8.12 ip igmp router-alert

The `ip igmp router-alert` command configures the switch disposition of inbound IGMP packets to the configuration mode interface based on the presence of the router-alert option in the IP header. By default, the port accepts all IGMP packets that arrive on the local subnet and rejects all other packets that arrive without the router-alert option.

The command provides three IGMP packet disposition options:

- **mandatory**: packets are accepted only when router-alert is present.
- **optional**: packets are accepted regardless of router-alert presence.
- **optional connected**: packets are accepted from the same subnet; other packets require router-alert.

The `no ip igmp router-alert` and `default ip igmp router-alert` commands reset the default setting of optional connected on the configuration mode interface by removing the corresponding `ip igmp router-alert` command from *running-config*.

Command Mode

Interface-Ethernet Configuration

Interface-Port-Channel Configuration

Interface-VLAN Configuration

Command Syntax

```
ip igmp router-alert DISPOSITION
```

```
no ip igmp router-alert
```

```
default ip igmp router-alert
```

Parameters

- DISPOSITION IGMP packet disposition method. Options include:
 - **mandatory** Rejects packets if router-alert is not present.
 - **optional** Accepts packets regardless of router-alert presence.
 - **optional connected** Accepts packets from same subnet. Other packets require router-alert.

Example

- This command configures the switch to accept IGMP packets on Ethernet interface 8 only if the IP header contains router alert.

```
switch(config)#interface ethernet 8
switch(config-if-Et8)#ip igmp router-alert mandatory
switch(config-if-Et8)#
```

15.2.8.13 ip igmp snooping filter

The **ip igmp snooping filter** command applies the specified IGMP snooping profile to the configuration mode interface. An IGMP snooping profile specifies the multicast groups that an interface may join. Profiles consist of the filter type and an address range:

- Filter type: Specifies accessibility to the listed address range:
 - Permit filters define the multicast groups the interface can join.
 - Deny filters define the multicast groups the interface cannot join.
- Address range: Specifies a list of addresses and ranges.
 - In permit filters, the permitted groups are specified by the address range.
 - In deny filters, all groups are permitted except those specified by the address range.

An interface without a snooping profile assignment may join any multicast group.

Snooping profiles are configured in IGMP-profile configuration mode ([ip igmp profile](#)).

The **no ip igmp snooping filter** and **default ip igmp snooping filter** commands restore the default setting of allowing an interface to join any multicast group by deleting the corresponding **ip igmp snooping filter** command from *running-config*.

Command Mode

Interface-Ethernet Configuration

Interface-Port-Channel Configuration

Command Syntax

```
ip igmp snooping filter profile_name
no ip igmp snooping filter [profile_name]
default ip igmp snooping filter [profile_name]
```

Parameters

- *profile_name* name of profile assigned to interface.

Example

- This command applies the list_1 snooping profile to Ethernet interface 7.

```
switch(config)#interface ethernet 7
switch(config-if-Et7)#ip igmp snooping filter list_1
switch(config-if-Et7)#
```

15.2.8.14 ip igmp snooping interface-restart-query

The **ip igmp snooping interface-restart-query** command configures the interface startup initial query time used for IGMP query spoofing. When an interface restarts or there is a change to the spanning tree, the interface will send general IGMP queries after this interval. The query is based on the information of the last known IGMP querier, and serves to facilitate faster network convergence times.

Multiple values can be configured with a single command; issuing the command again replaces any previously configured value(s).

The **no ip igmp snooping interface-restart-query** and **default ip igmp snooping interface-restart-query** commands restore the default setting of 2000 milliseconds by deleting the corresponding **ip igmp snooping interface-restart-query** command from **running-config**.

Command Mode

General Configuration

Command Syntax

```
ip igmp snooping interface-restart-query query_time
```

```
no ip igmp snooping interface-restart-query
```

```
default ip igmp snooping interface-restart-query
```

Parameters

- *query_time* interval (in milliseconds) after an interface restart or spanning tree change at which the interface will send general IGMP queries. Values range from 100 to 50000 milliseconds; default is 2000.

Example

- This command configures interfaces to send IGMP queries at 100, 200, and 300 milliseconds after an interface restart or spanning tree change.

```
switch(config)#ip igmp snooping interface-restart-query 100 200 300
switch(config)#
```

15.2.8.15 ip igmp snooping proxy

The **ip igmp snooping proxy** command enables snooping proxy globally. By default, IGMP snooping proxy is disabled globally.

When the snooping proxy is enabled globally, it enables IGMP snooping proxy on an individual VLANs and when the IGMP snooping proxy is globally disabled the snooping proxy is disabled on individual VLANs.

The **no ip igmp snooping proxy** and **default ip igmp snooping proxy** commands disable snooping proxy globally and on individual VLANs by removing the **ip igmp snooping proxy** command from *running-config*.

Command Mode

Global Configuration

Command Syntax

```
ip igmp snooping proxy
```

```
no ip igmp snooping proxy
```

```
default ip igmp snooping proxy
```

Examples

- This command globally enables snooping proxy on the switch.

```
switch(config)#ip igmp snooping proxy
switch(config)#
```

- This command explicitly disables IGMP snooping proxy on VLAN 20.

```
switch(config)#no ip igmp snooping vlan 20 proxy
switch(config)#
```

15.2.8.16 ip igmp snooping querier address

The **ip igmp snooping querier address** command sets the global querier source IP address, which specifies the source address for packets transmitted from VLANs for which a querier address ([ip igmp snooping vlan querier address](#)) is not configured. To use a snooping querier, an address must be explicitly configured globally or for the VLAN.

The switch does not define a default global querier address.

The **no ip igmp snooping querier address** and **default ip igmp snooping querier address** commands remove the global querier address command from *running-config*.

Command Mode

Global Configuration

Command Syntax

```
ip igmp snooping querier address ipv4_address
```

```
no ip igmp snooping querier address
```

```
default ip igmp snooping querier address
```

Parameters

- *ipv4_address* source IPv4 address.

Example

- This command sets the source IP address to 10.1.1.41 for query packets transmitted from the switch.

```
switch(config)#ip igmp snooping querier address 10.1.1.41
switch(config)#
```

15.2.8.17 ip igmp snooping querier last-member-query-count

The `ip igmp snooping querier last-member-query-count` command configures the global **IGMP snooping querier last member query count** (LMQC) value. LMQC specifies the number of query messages the switch sends in response to group-specific or group-source-specific leave messages it receives from a host; the transmission frequency is specified by **IGMP snooping querier last member query interval**. The switch stops forwarding messages to the host if it does not receive a response to these query messages.

Setting LMQC to 1 causes the loss of one packet to stop traffic forwarding. While the switch can start forwarding traffic again after receiving a response to the next general query, the host may not receive that query for a period defined by `ip igmp snooping querier query-interval`.

VLANs use the global value when they are not assigned a value (`ip igmp snooping vlan querier last-member-query-count`). VLAN commands take precedence over the global value. The default global value is specified by the robustness variable (`ip igmp snooping robustness-variable`).

The `no ip igmp snooping querier last-member-query-count` and `default igmp snooping querier last-member-query-count` commands reset the LMQC to the default value by removing the corresponding `ip igmp snooping querier last-member-query-count` command from *running-config*.

Command Mode

Global Configuration

Command Syntax

```
ip igmp snooping querier last-member-query-count number
```

```
no ip igmp snooping querier last-member-query-count
```

```
default ip igmp snooping querier last-member-query-count
```

Parameters

- *number* query message quantity. Value ranges from 1 to 3. Default is set by robustness-variable.

Example

- This command configures the global last-member-query-count to 3.

```
switch(config)#ip igmp snooping querier last-member-query-count 3
switch(config)#show igmp snooping querier status
  Global IGMP Querier status
-----
admin state                : Disabled
source IP address         : 0.0.0.0
query-interval (sec)      : 125.0
max-response-time (sec)   : 10.0
querier timeout (sec)     : 255.0
last-member-query-interval (sec) : 1.0
last-member-query-count   : 3
startup-query-interval (sec) : 31.25 (query-interval/4)
startup-query-count       : 2 (robustness)
Vlan Admin IP            Query Response Querier Operational Ver
  State                  Interval Time      Timeout State
-----
1   Disabled 0.0.0.0      125.0   10.0    255.0   Non-Querier v2
100 Disabled 0.0.0.0      125.0   10.0    255.0   Non-Querier v2
101 Disabled 0.0.0.0      125.0   10.0    255.0   Non-Querier v2
switch(config)#
```

15.2.8.18 ip igmp snooping querier last-member-query-interval

The `ip igmp snooping querier last-member-query-interval` command sets the global IGMP snooping last member query interval. The default interval is one second.

A multicast host sends an IGMP leave report when it leaves a group. To determine if the host was the last group member, the leave message recipient sends an IGMP query. The last-member-query-interval determines when the group record is deleted if no subsequent reports are received.

VLANs not assigned a **last member query interval** value ([ip igmp snooping vlan querier last-member-query-interval](#)) use the global value. VLAN commands take precedence over the global value.

The `no ip igmp snooping querier last-member-query-interval` and `default ip igmp snooping querier last-member-query-interval` commands reset the **last-member-query-interval** value the default interval of one second by removing the `ip igmp snooping querier last-member-query-interval` statement from *running-config*.

Command Mode

Global Configuration

Command Syntax

```
ip igmp snooping querier last-member-query-interval period
no ip igmp snooping querier last-member-query-interval
default ip igmp snooping querier last-member-query-interval
```

Parameters

- *period* last member query interval (seconds). Value ranges from 1 to 25. Default is one second.

Related Commands

- [ip igmp snooping vlan querier last-member-query-interval](#) assign a last member query interval value to the specified VLANs.

Example

- This command sets the IGMP snooping querier last-member-query-interval to five seconds.

```
switch(config)#ip igmp snooping querier last-member-query-interval 5
switch(config)#
```

15.2.8.19 ip igmp snooping querier max-response-time

The `ip igmp snooping querier max-response-time` command specifies the global max-response-time value. The switch uses max-response-time to set the Max Response Time field in outbound Membership Query messages. Max Response Time specifies the maximum period a recipient can wait before responding with a Membership Report.

VLANs not assigned a max-response-time value (`ip igmp snooping vlan querier max-response-time`) use the global value. VLAN commands take precedence over the global value.

Values range from 1 to 25 seconds. The default global value is 10 seconds.

The `no ip igmp snooping querier max-response-time` and `default ip igmp snooping querier max-response-time` commands restore the global max-response-time default value by removing the `ip igmp snooping querier max-response-time` statement from *running-config*.

Command Mode

Global Configuration

Command Syntax

```
ip igmp snooping querier max-response-time resp_sec
no ip igmp snooping querier max-response-time
default ip igmp snooping querier max-response-time
```

Parameters

- `resp_sec` max-response-time value (seconds). Values range from 1 to 25. Default (global) is 10.

Example

- This command sets the global max-response-time to 15 seconds.

```
switch(config)#ip igmp snooping querier max-response-time 15
switch(config)#
```

15.2.8.20 ip igmp snooping querier query-interval

The `ip igmp snooping querier query-interval` command sets the global query interval. This command also sets the query-interval of IGMP Snooping when using IGMP version 2. Values range from 5 to 3600 seconds. The default global value is 125 seconds. The query interval is the period between IGMP Membership Query messages sent from the querier. The global value specifies the query interval for VLANs with no query-interval command.

VLANs not assigned a query interval value (`ip igmp snooping vlan querier query-interval`) use the global value. VLAN commands take precedence over the global value.

The `no ip igmp snooping querier query-interval` and `default ip igmp snooping querier query-interval` commands reset the global query-interval value to 125 seconds by removing the `ip igmp snooping querier query-interval` statement from *running-config*.

Command Mode

Global Configuration

Command Syntax

```
ip igmp snooping querier query-interval query_sec
```

```
no ip igmp snooping querier query-interval
```

```
default ip igmp snooping querier query-interval
```

Parameters

- *query_sec* query interval (seconds). Values range from 5 to 3600. Default (global) is 125.

Example

- This command sets the global query interval to 150 seconds.

```
switch(config)#ip igmp snooping querier query-interval 150
switch(config)#
```

15.2.8.21 ip igmp snooping querier startup-query-count

The `ip igmp snooping querier startup-query-count` command configures the global **startup query count** value. The **startup query count** specifies the number of query messages that the querier sends on a VLAN during the **startup query interval** (`ip igmp snooping querier startup-query-interval`).

When snooping is enabled, the group state is more quickly established by sending query messages at a higher frequency. The `startup-query-interval` and `startup-query-count` parameters define the startup period by defining the number of queries to be sent and transmission frequency for these messages.

VLANs use the global **startup query count** value when they are not assigned a value (`ip igmp snooping vlan querier startup-query-count`). VLAN commands take precedence over the global value. The default global value is specified by the robustness variable (`ip igmp snooping robustness-variable`).

The `no ip igmp snooping querier startup-query-count` and `default ip igmp snooping querier startup-query-count` commands restore the default startup-query-count value by removing the corresponding `ip igmp snooping querier startup-query-count` command from *running-config*.

Command Mode

Global Configuration

Command Syntax

```
ip igmp snooping querier startup-query-count number
```

```
no ip igmp snooping querier startup-query-count
```

```
default ip igmp snooping querier startup-query-count
```

Parameters

- *number* global startup query count. Value ranges from 1 to 3.

Example

- These commands configure the global startup query count value of 2, then displays the status of the snooping querier.

```
switch(config)#ip igmp snooping querier startup-query-count 2
switch(config)#show igmp snooping querier status
  Global IGMP Querier status
-----
admin state                : Disabled
source IP address          : 0.0.0.0
query-interval (sec)       : 125.0
max-response-time (sec)    : 10.0
querier timeout (sec)      : 255.0
last-member-query-interval (sec) : 1.0
last-member-query-count    : 2 (robustness)
startup-query-interval (sec) : 31.25 (query-interval/4)
startup-query-count        : 2

Vlan Admin   IP           Query   Response  Querier  Operational  Ver
      State   Address         Interval Time     Timeout  State
-----
1     Disabled 0.0.0.0         125.0   10.0     255.0   Non-Querier v2
100   Disabled 0.0.0.0         125.0   10.0     255.0   Non-Querier v2
101   Disabled 0.0.0.0         125.0   10.0     255.0   Non-Querier v2
switch(config)#
```

15.2.8.22 ip igmp snooping querier startup-query-interval

The `ip igmp snooping querier startup-query-interval` command configures the global startup query interval value. The `startup query interval` specifies the period between query messages that the querier sends upon startup.

When snooping is enabled, the group state is more quickly established by sending query messages at a higher frequency. The `startup-query-interval` and `startup-query-count` parameters define the startup period by defining the number of queries to be sent and transmission frequency for these messages.

VLANs use the global `startup query interval` value when they are not assigned a value (`ip igmp snooping vlan querier startup-query-interval`). VLAN commands take precedence over the global value. The default global value equals the query interval divided by four. (`ip igmp snooping querier query-interval`).

The `no ip igmp snooping querier startup-query-interval` and `default ip igmp snooping querier startup-query-interval` commands restore the default method of specifying the startup query interval by removing the corresponding `ip igmp snooping querier startup-query-interval` command from *running-config*.

Command Mode

Global Configuration

Command Syntax

```
ip igmp snooping querier startup-query-interval period
```

```
no ip igmp snooping querier startup-query-count
```

```
default ip igmp snooping querier startup-query-count
```

Parameters

- *period* startup query interval (seconds). Value ranges from 1 to 3600 (1 hour).

Example

- This command configures the startup query count of one minute for VLAN interface 4.

```
switch(config)#ip igmp snooping querier startup-query-interval 40
switch(config)#show igmp snooping querier status
  Global IGMP Querier status
-----
admin state                : Enabled
source IP address          : 0.0.0.0
query-interval (sec)       : 125.0
max-response-time (sec)    : 10.0
querier timeout (sec)      : 255.0
last-member-query-interval (sec) : 1.0
last-member-query-count    : 2 (robustness)
startup-query-interval (sec) : 40.0
startup-query-count        : 2

Vlan Admin   IP           Query   Response Querier Operational Ver
   State     Address      Interval Time    Timeout State
-----
1    Enabled  0.0.0.0     125.0   10.0    255.0   Non-Querier v3
100  Enabled  0.0.0.0     125.0   10.0    255.0   Non-Querier v3
101  Enabled  0.0.0.0     125.0   10.0    255.0   Non-Querier v3
switch(config)#
```

15.2.8.23 ip igmp snooping querier version

The `ip igmp snooping querier version` command configures the Internet Group Management Protocol (IGMP) snooping querier version on the configuration mode interfaces. Version 3 is the default IGMP version.

IGMP is enabled by the `pim ipv4 sparse-mode` or `pim ipv4 bidirectional` command. The `ip igmp snooping querier version` command does not affect the IGMP enabled status.

The `no ip igmp snooping querier version` and `default ip igmp snooping querier version` commands restore the configuration mode to IGMP version 3 by removing the `ip igmp snooping querier version` statement from *running-config*.

Command Mode

Global Configuration

Command Syntax

```
ip igmp snooping querier version version_number
no ip igmp snooping querier startup-query-count
default ip igmp snooping querier startup-query-count
```

Parameters

- *version_number* IGMP version number. Value ranges from 1 to 3. Default value is 3.

Example

- This command configures IGMP snooping querier version 2.

```
switch(config)# ip igmp snooping querier version 2
switch(config)#
```

- This command restores the IGMP snooping querier to version 3.

```
switch(config)# no ip igmp snooping querier version
switch(config)#
```

15.2.8.24 ip igmp snooping querier

The **ip igmp snooping querier** command enables the snooping querier globally, which controls the querier for VLANs that are not configured with a snooping querier command. The **ip igmp snooping vlan querier** command controls the querier on individual VLANs.

The IGMP snooping querier supports snooping by sending layer 2 membership queries to hosts attached to the switch. The snooping querier is functional on VLANs where hosts receive IP multicast traffic without access to a network IP multicast router. A snooping querier avoids flooding multicast packets in the VLAN by querying for hosts and routers.

The IGMP snooping querier is functional on VLANs that meet these criteria:

- Snooping is enabled.
- The corresponding SVI (VLAN interface) is active.
- The VLAN querier IP address or the global querier IP address is configured.

The **no ip igmp snooping querier** and **default ip igmp snooping querier** commands disable the snooping querier globally by removing the **ip igmp snooping querier** statement from *running-config*. The snooping querier is globally disabled by default.

Command Mode

Global Configuration

Command Syntax

```
ip igmp snooping querier
```

```
no ip igmp snooping querier
```

```
default ip igmp snooping querier
```

Guidelines

- Enabling a querier after it was disabled is equivalent to establishing a new querier.
- Changing the querier IP address is equivalent to establishing a new querier.

Example

- This command globally enables the snooping querier on the switch.

```
switch(config)#ip igmp snooping querier
switch(config)#
```

15.2.8.25 ip igmp snooping report-flooding switch-port

The `ip igmp snooping report-flooding switch-port` command specifies Ethernet ports or port channels that can forward IGMP membership report messages for all VLANs where L2 report flooding is enabled. Ports that are connected to multicast routers or queriers continue to forward traffic as previously specified and are not affected by L2 report flooding commands.

L2 report flooding is an IGMP snooping feature that forwards membership report messages to specified ports. The `ip igmp snooping vlan report-flooding switch-port` command configures a list of forwarding ports for a specified VLAN range.

The `no ip igmp snooping report-flooding switch-port` and `default ip igmp snooping report-flooding switch-port` commands remove the specified ports from the global report flooding port list by deleting the corresponding `ip igmp snooping report-flooding switch-port` command from *running-config*.

Command Mode

Global Configuration

Command Syntax

```
ip igmp snooping report-flooding switch-port INTERFACE
no ip igmp snooping report-flooding switch-port INTERFACE
default ip igmp snooping report-flooding switch-port INTERFACE
```

Parameters

- INTERFACE Membership report message forwarding is enabled on these ports:
 - **ethernet** *e_range* *e_range* is the number, range, or list of ethernet ports
 - **port-channel** *p_range* where *p_range* is the number, range, or list of channel ports

Related Commands

- `ip igmp snooping report-flooding` globally enables L2 report flooding.
- `ip igmp snooping vlan report-flooding switch-port` specifies a port list for a VLAN range.

Example

- This command configures Ethernet ports 7-9 for report message forwarding for any VLAN where L2 report flooding is enabled.

```
switch(config)#ip igmp snooping report-flooding switch-port ethernet
7-9
switch(config)#
```

15.2.8.26 ip igmp snooping report-flooding

The `ip igmp snooping report-flooding` command globally enables L2 report flooding on the switch. When report flooding is globally enabled, the `ip igmp snooping vlan report-flooding` configures a VLAN range to forward membership report messages to specified ports. When report flooding is not globally enabled, L2 report flooding cannot be enabled on individual VLANs.

L2 report flooding is an IGMP snooping feature that forwards membership report messages to specified ports. Relying on a single switch to maintain and send report messages can result in performance issues. L2 report flooding addresses this by facilitating report message transmissions through any network port. This allows switches to bypass the querier when forwarding multicast traffic to its interested ports.

The `no ip igmp snooping report-flooding` and `default ip igmp snooping report-flooding` commands disable global L2 report flooding by removing `ip igmp report flooding` from *running-config*. L2 report flooding is disabled by default.

Command Mode

Global Configuration

Command Syntax

```
ip igmp snooping report-flooding
```

```
no ip igmp snooping report-flooding
```

```
default ip igmp snooping report-flooding
```

Related Commands

- [ip igmp snooping vlan report-flooding](#) enables L2 report flooding on a specified VLAN range.

Example

- This command globally enables the snooping L2 report-flooding.

```
switch(config)#ip igmp snooping report-flooding
switch(config)#
```

15.2.8.27 ip igmp snooping restart query-interval

The `ip igmp snooping restart query-interval` command sets the query interval for all VLANs during an IGMP snooping restart. By default, the query interval during an IGMP snooping restart is a VLAN configured query interval divided by five. This accelerates the transmission of robustness queries to establish the IGMP snooping state more quickly. However, some large scale configurations may not be able to process all of the queries at this query interval rate. The restart query interval, when configured, is valid for all VLANs.

The `no ip igmp snooping resrtart query-interval` and `default ip igmp snooping restart query-interval` commands removes the global restart query interval by deleting the `ip igmp snooping restart query-interval` statement from *running-config*.

Command Mode

Global Configuration

Command Syntax

```
ip igmp snooping restart query-interval query_sec
no ip igmp snooping restart query-interval
default ip igmp snooping restart query-interval
```

Parameters

- `query_sec` query interval (seconds). Values range from 2 to 400. Default (global) is 125.

Example

- This command sets the global query interval to 35 seconds.

```
switch(config)#ip igmp snooping restart query-interval 35
switch(config)#
```

15.2.8.28 ip igmp snooping robustness-variable

The **ip igmp snooping robustness-variable** command configures the robustness variable for snooping packets sent from any VLAN. Values range from 1 to 3 with a default of 2.

The robustness variable specifies the number of unacknowledged snooping queries that a switch sends before removing the recipient from the group list.

The **no ip igmp snooping robustness-variable** and **default ip igmp snooping robustness-variable** commands reset the robustness variable to 2 by removing the **ip igmp snooping robustness-variable** command from *running-config*.

Command Mode

Global Configuration

Command Syntax

```
ip igmp snooping robustness-variable robust_value
```

```
no ip igmp snooping robustness-variable
```

```
default ip igmp snooping robustness-variable
```

Parameters

- *robust_value* robustness variable. Values range from 1 to 3. Default is 2.

Example

- This command sets the robustness-variable value to 3.

```
switch(config)#ip igmp snooping robustness-variable 3
switch(config)#
```

15.2.8.29 ip igmp snooping vlan fast-leave

The **ip igmp snooping vlan fast-leave** command enables fast-leave processing on specified VLANs. When fast-leave processing is enabled, the removal of a VLAN interface's multicast group entry from the IGMP table is not preceded by an IGMP group-specific query to the interface. The switch removes an interface from the forwarding table when it detects an IGMP leave message on the interface. IGMP fast-leave processing is enabled on all VLANs by default.

The **no ip igmp snooping vlan fast-leave** command disables fast-leave processing on the specified VLANs. The **default ip igmp snooping vlan fast-leave** command restores fast-leave processing on the specified VLANs by removing the corresponding **no ip igmp snooping vlan fast-leave** statement from running-config.

Command Mode

Global Configuration

Command Syntax

```
ip igmp snooping vlan v_range fast-leave
```

```
no ip igmp snooping vlan v_range fast-leave
```

```
default ip igmp snooping vlan v_range fast-leave
```

Parameters

- *v_range* VLAN IDs. Formats include a number, number range, or comma-delimited list of numbers and ranges. Numbers range from 1 to 4094.

Example

- This command enables IGMP fast-leave processing on VLAN 10.

```
switch(config)#ip igmp snooping vlan 10 fast-leave
switch(config)#
```

15.2.8.30 ip igmp snooping vlan max-groups

The **ip igmp snooping vlan max-groups** command configures the quantity of multicast groups that the specified VLAN forwarding table can contain. After the limit is reached, attempts to join new groups are ignored. There is no default limit.

The **no ip igmp snooping vlan max-groups** and **default ip igmp snooping vlan max-groups** removes the maximum group limit by deleting the **ip igmp snooping vlan max-groups** statement from *running-config*.

Command Mode

Global Configuration

Command Syntax

```
ip igmp snooping vlan v_range max-groups quantity
```

```
no ip igmp snooping vlan v_range max-groups
```

```
default ip igmp snooping vlan v_range max-groups
```

Parameters

- *v_range* VLAN IDs. Formats include a number, number range, or comma-delimited list of numbers and ranges. Numbers range from 1 to 4094.
- *quantity* maximum number of groups that can access the VLAN. Value ranges from 0 to 65534.

Examples

- This command limits the number of multicast groups that hosts on VLAN 6 can simultaneously access to 25.

```
switch(config)#ip igmp snooping vlan 6 max-groups 25
switch(config)#
```

- This command allows each VLAN between 8 and 15 to receive multicast packets from 30 groups.

```
switch(config)#ip igmp snooping vlan 8-15 max-groups 30
switch(config)#
```

- This command removes the maximum group restriction from all VLAN interfaces between 1 and 50.

```
switch(config)#no ip igmp snooping vlan 1-50 max-groups
switch(config)#
```

15.2.8.31 ip igmp snooping vlan member

The **ip igmp snooping vlan member** command adds ports as static members to a multicast group. The ports must be in the specified VLAN range.

The **no ip igmp snooping vlan member** and **default ip igmp snooping vlan member** commands remove the specified ports from the multicast group by deleting the corresponding ip igmp snooping member statements from *running-config*.

Command Mode

Global Configuration

Command Syntax

```
ip igmp snooping vlan v_num member ipv4_addr interface STATIC_INT
```

```
no ip igmp snooping vlan v_num member ipv4_addr interface STATIC_INT
```

```
default ip igmp snooping vlan v_num member ipv4_addr interface STATIC_INT
```

Parameters

- *v_num* VLAN number. Value ranges from 1 to 4094.
- *ipv4_addr* multicast group IPv4 address.
- *STATIC_INT* interface the command configures as the static group member. Options include:
 - **ethernet** *e_range*, where *e_range* is the number, range, or list of Ethernet ports
 - **port-channel** *p_range*, where *p_range* is the number, range, or list of channel ports

Example

- This command configures the static connection to a multicast group at 237.2.1.4 through Ethernet port 3.

```
switch(config)#ip igmp snooping vlan 7 member 237.2.1.4 interface
ethernet 3
switch(config)#
```

15.2.8.32 ip igmp snooping vlan multicast-router

The `ip igmp snooping vlan multicast-router` command adds a multicast router as a static port to the specified VLANs. The router port must be in the specified VLAN range.

Snooping may not always be able to locate the IGMP querier. This command should specify IGMP queriers that are known to connect to the network through a port on the switch.

The `no ip igmp snooping vlan multicast-router` and `default ip igmp snooping vlan multicast-router` commands remove the specified static port configuration by deleting the corresponding `ip igmp snooping vlan multicast-router` command from *running-config*.

Command Mode

Global Configuration

Command Syntax

```
ip igmp snooping vlan v_range multicast-router interface STATIC_INT
no ip igmp snooping vlan v_range multicast-router interface STATIC_INT
default ip igmp snooping vlan v_range multicast-router interface STATIC_INT
```

Parameters

- *v_range* VLAN IDs. Formats include a number, number range, or comma-delimited list of numbers and ranges. Numbers range from 1 to 4094.
- STATIC_INT interface the command configures as a static port. Selection options include:
 - **ethernet** *e_range* where *e_range* is the number, range, or list of ethernet ports
 - **port-channel** *p_range* where *p_range* is the number, range, or list of channel ports

The STATIC_INT interface must route traffic through a VLAN specified within *v_range*.

Example

- This command configures the static connection to a multicast router through Ethernet port 3.

```
switch(config)#ip igmp snooping vlan 2 multicast-router interface
  ethernet 3
switch(config)#
```

15.2.8.33 ip igmp snooping vlan proxy

The **ip igmp snooping vlan proxy** command enables snooping proxy on individual VLAN, and to enable or disable IGMP snooping vlan proxy globally, use **ip igmp snooping proxy** command.



Note: The **ip igmp snooping proxy** command enables snooping proxy on all VLANs only where IGMP snooping is enabled.

The **no** and **default** form of **ip igmp snooping vlan proxy** command disables snooping proxy globally and on individual VLANs by removing the **ip igmp snooping vlan proxy** command from **running-config**.

Command Mode

Global Configuration

Command Syntax

```
ip igmp snooping vlan [ID | range] proxy
no ip igmp snooping vlan [ID | range] proxy
default ip igmp snooping vlan [ID | range] proxy
```

Parameters

- *range* specifies the range of VLAN IDs. Numbers range from 1 to 4094.
- *ID* specifies a individual VLAN ID. Numbers range from 1 to 4094.

Examples

- This command globally enables IGMP snooping proxy on the switch and on all VLANs where IGMP snooping is enabled.

```
switch(config)#ip igmp snooping proxy
switch(config)#
```

- This command enables IGMP snooping proxy on VLAN 20.

```
switch(config)#ip igmp snooping vlan 20 proxy
switch(config)#
```

- This command disables IGMP snooping proxy on VLAN 20.

```
switch(config)#no ip igmp snooping vlan 20 proxy
switch(config)#
```

15.2.8.34 ip igmp snooping vlan querier address

The **ip igmp snooping vlan querier address** command sets the source address for query packets sent from specified VLANs. VLANs not assigned an address use the global address ([ip igmp snooping querier address](#)). VLAN querier address commands take precedence over the global address.

To use a snooping querier, an address must be explicitly configured globally or for the querier VLAN.

The **no ip igmp vlan snooping querier address** and **default ip igmp snooping vlan querier address** commands reset the specified VLAN to use the global address by removing the corresponding **ip igmp snooping vlan querier address** command from *running-config*.

Command Mode

Global Configuration

Command Syntax

```
ip igmp snooping vlan v_range querier address ipv4_address
```

```
no ip igmp snooping vlan v_range querier address
```

```
default ip igmp snooping vlan v_range querier address
```

Parameters

- *v_range* VLAN IDs. Formats include a number, number range, or comma-delimited list of numbers and ranges. Numbers range from 1 to 4094.
- *ipv4_address* source IPv4 address.

Example

- This command sets the source IPv4 address of 10.14.1.1 for query packets transmitted from VLAN 2.

```
switch(config)#ip igmp snooping vlan 2 querier address 10.14.1.1  
switch(config)#
```

15.2.8.35 ip igmp snooping vlan querier last-member-query-count

The `ip igmp snooping vlan querier last-member-query-count` command specifies an **IGMP snooping querier last member query count** (LMQC) value for the specified VLANs. LMQC specifies the number of query messages the switch sends in response to group-specific or group-source-specific leave messages it receives from a host; the transmission frequency is specified by **IGMP snooping querier last member query interval**. The switch stops forwarding messages to the host if it does not receive a response to these query messages.

VLANs not assigned an LMQC value use the global value (`ip igmp snooping querier last-member-query-count`). VLAN commands take precedence over the global command.

Setting the last member query count (LMQC) to 1 causes the loss of a single packet to stop traffic forwarding. While the switch can start forwarding traffic again after receiving a response to the next general query, the host may not receive that query for a period defined by `ip igmp snooping querier query-interval I`.

The `no ip igmp snooping vlan querier last-member-query-count` and `default igmp snooping vlan querier last-member-query-count` commands reset the specified VLAN to use the global LMQC by removing the corresponding `ip igmp snooping vlan querier last-member-query-count` command from *running-config*.

Command Mode

Global Configuration

Command Syntax

```
ip igmp snooping vlan v_range querier last-member-query-count number
```

```
no ip igmp snooping vlan v_range querier address
```

```
default ip igmp snooping vlan v_range querier address
```

Parameters

- *v_range* VLAN IDs. Formats include a number, number range, or comma-delimited list of numbers and ranges. Numbers range from 1 to 4094.
- *number* query message quantity. Value ranges from 1 to 3.

Example

- This command configures the last-member-query-count to 1 on VLAN interface 3.

```
switch(config)#ip igmp snooping vlan 3 querier last-member-query-count
1
switch(config)#
```

15.2.8.36 ip igmp snooping vlan querier last-member-query-interval

The `ip igmp snooping vlan querier last-member-query-interval` command configures **last-member-query-interval** for packets sent from the specified VLANs. VLANs not assigned a value use the global setting (`ip igmp snooping querier last-member-query-interval`). VLAN commands take precedence over the global value. The global default is one second.

A multicast host sends an IGMP leave report when it leaves a group. To determine if the host was the last group member, the leave message recipient sends an IGMP query. The `last-member-query-interval` determines when the group record is deleted if no subsequent reports are received.

The `no ip igmp snooping vlan querier last-member-query-interval` and `default ip igmp snooping vlan querier last-member-query-interval` commands reset the specified VLAN to use the global **last-member-query-interval** by removing the corresponding `ip igmp snooping vlan querier last-member-query-interval` command from *running-config*.

Command Mode

Global Configuration

Command Syntax

```
ip igmp snooping vlan v_range querier last-member-query-interval period
```

```
no ip igmp snooping vlan v_range querier last-member-query-interval
```

```
default ip igmp snooping vlan v_range querier last-member-query-interval
```

Parameters

- *v_range* VLAN IDs. Formats include a number, number range, or comma-delimited list of numbers and ranges. Numbers range from 1 to 4094.
- *period* last member query interval (seconds). Value ranges from 1 to 25.

Example

- This command sets the `last-member-query-interval` for VLAN 10 to 12 seconds.

```
switch(config)#ip igmp snooping vlan 10 querier last-member-query-  
interval 12  
switch(config)#
```

15.2.8.37 ip igmp snooping vlan querier max-response-time

The `ip igmp snooping vlan querier max-response-time` command configures max-response-time for packets sent from the specified VLANs. VLANs not assigned a value use the global setting (`ip igmp snooping querier max-response-time`). VLAN commands take precedence over the global value. The global default is 10 seconds.

Switches use max-response-time to set the Max Response Time field in outbound Membership Query messages. Max Response Time specifies the maximum period a recipient can wait before responding with a Membership Report.

The `no ip igmp snooping vlan querier max-response-time` and `default ip igmp snooping vlan querier max-response-time` commands reset the specified VLAN to use the global max-response-time by removing the corresponding `ip igmp snooping vlan querier max-response-time` command from *running-config*.

Command Mode

Global Configuration

Command Syntax

```
ip igmp snooping vlan v_range querier max-response-time resp_sec  
no ip igmp snooping vlan v_range querier max-response-time  
default ip igmp snooping vlan v_range querier max-response-time
```

Parameters

- *v_range* VLAN ID. Formats include a number, number range, or comma-delimited list of numbers and ranges. Numbers range from 1 to 4094.
- *resp_sec* max-response-time value (seconds). Values range from 1 to 25.

Example

- This command sets the max-response-time for VLAN 2 to 5 seconds.

```
switch(config)#ip igmp snooping vlan 2 querier max-response-time 5  
switch(config)#
```

15.2.8.38 ip igmp snooping vlan querier query-interval

The `ip igmp snooping vlan querier query-interval` command sets the query interval for the specified VLAN. VLANs not assigned a value use the global value (`ip igmp snooping querier query-interval`). VLAN commands have precedence over the global value. The query interval is the period between IGMP Membership Query messages sent from the querier.

The `no ip igmp snooping vlan querier query-interval` and `default ip igmp snooping vlan querier query-interval` commands reset the specified VLAN to use the global value by removing the corresponding `ip igmp snooping vlan querier query-interval` command from *running-config*.

Command Mode

Global Configuration

Command Syntax

```
ip igmp snooping vlan v_range querier query-interval query_sec
```

```
no ip igmp snooping vlan v_range querier query-interval
```

```
default ip igmp snooping vlan v_range querier query-interval
```

Parameters

- *v_range* VLAN IDs. Formats include a number, number range, or comma-delimited list of numbers and ranges. Numbers range from 1 to 4094.
- *query_sec* query interval (seconds). Values range from 5 to 3600. Default (global) is 125.

Example

- This command sets the query interval for VLAN 10 to 240 seconds.

```
switch(config)#ip igmp snooping vlan 10 querier query-interval 240
switch(config)#
```

15.2.8.39 ip igmp snooping vlan querier startup-query-count

The `ip igmp snooping vlan querier startup-query-count` command specifies the startup query count value for the specified VLANs. The `startup query count` specifies the number of query messages that the querier sends on a VLAN during the `startup query interval` (`ip igmp snooping vlan querier startup-query-interval`).

When an interface starts running IGMP, it can establish the group state more quickly by sending query messages at a higher frequency. The `startup-query-interval` and `startup-query-count` parameters define the startup period and the query message transmission frequency during that period.

VLANs not assigned a `startup query count` value use the global value (`ip igmp snooping querier startup-query-count`). VLAN commands take precedence over the global command.

The `no ip igmp snooping vlan querier startup-query-count` and `default ip igmp snooping vlan querier startup-query-count` commands restore the default condition of using the global `startup query count` value by removing the corresponding `ip igmp snooping vlan querier startup-query-count` command from *running-config*.

Command Mode

Global Configuration

Command Syntax

```
ip igmp snooping vlan v_range querier startup-query-count number  
no ip igmp snooping vlan v_range querier startup-query-count  
default ip igmp snooping vlan v_range querier startup-query-count
```

Parameters

- *v_range* VLAN IDs. Formats include a number, number range, or comma-delimited list of numbers and ranges. Numbers range from 1 to 4094.
- *number* startup query count. Value ranges from 1 to 3.

Example

- This command configures the startup query count of 3 for VLAN 100.

```
switch(config)#ip igmp snooping vlan 100 querier startup-query-count 3  
switch(config)#
```

15.2.8.40 ip igmp snooping vlan querier startup-query-interval

The `ip igmp snooping vlan querier startup-query-interval` command specifies the **startup query interval** value for the specified VLANs. The **startup query interval** specifies the period between query messages that the querier sends upon startup.

When snooping is enabled, the group state is more quickly established by sending query messages at a higher frequency. The `startup-query-interval` and `startup-query-count` parameters define the startup period by defining the number of queries to be sent and transmission frequency for these messages.

VLANs not assigned a **startup query interval** value use the global value (`ip igmp snooping querier startup-query-count`). VLAN commands take precedence over the global command.

The `no ip igmp snooping vlan querier startup-query-interval` and `default ip igmp snooping vlan querier startup-query-interval` commands restore the default condition of using the global **startup query interval** value by removing the corresponding `ip igmp snooping vlan querier startup-query-interval` command from *running-config*.

Command Mode

Global Configuration

Command Syntax

```
ip igmp snooping vlan v_range querier startup-query-interval period  
no ip igmp snooping vlan v_range querier startup-query-interval  
default ip igmp snooping vlan v_range querier startup-query-interval
```

Parameters

- *v_range* VLAN IDs. Formats include a number, number range, or comma-delimited list of numbers and ranges. Numbers range from 1 to 4094.
- *period* startup query interval (seconds). Value ranges from 1 to 3600 (1 hour). Default is 31.

Example

- This command configures the startup query count of one minute for VLAN interface 100.

```
switch(config)#ip igmp snooping vlan 100 querier startup-query-interval  
60  
switch(config)#
```

15.2.8.41 ip igmp snooping vlan querier version

The `ip igmp snooping vlan querier version` command configures the Internet Group Management Protocol (IGMP) snooping querier function on the VLAN. Version 3 is the default IGMP snooping version.

IGMP is enabled by the `pim ipv4 sparse-mode` or `pim ipv4 bidirectional` command. The `ip igmp snooping vlan querier version` command does not affect the IGMP enabled status.

The `no ip igmp snooping vlan querier version` and `default ip igmp snooping vlan querier version` commands restore the configuration mode interface to IGMP snooping VLAN querier version 3 by removing the `ip igmp snooping vlan querier version` statement from *running-config*.

Command Mode

Global Configuration

Command Syntax

```
ip igmp snooping vlan v_range querier version version_number
```

```
no ip igmp snooping vlan v_range querier version
```

```
default ip igmp snooping vlan v_range querier version
```

Parameters

- *v_range* VLAN ID. Formats include a number, number range, or comma-delimited list of numbers and ranges. Numbers range from 1 to 4094.
- *version_number* IGMP version number. Value ranges from 1 to 3. Default value is 3.

Example

- The example sets the querier version to 2 on vlan 5.

```
switch(config)# ip igmp snooping vlan 5 querier version 2
switch(config)#
```

- This command restores IGMP snooping querier version 3 to VLAN 5.

```
switch(config)# no ip igmp snooping vlan 5 querier version
switch(config)#
```

15.2.8.42 ip igmp snooping vlan querier

The `ip igmp snooping vlan querier` command controls the querier for the specified VLANs. VLANs follow the global querier setting unless overridden by one of these commands:

- `ip igmp snooping vlan querier` enables the querier on specified VLANs.
- `no ip igmp snooping vlan querier` disables the querier on specified VLANs.

VLAN querier commands take precedence over the global querier setting. The `ip igmp snooping querier` controls the querier for VLANs with no snooping querier command.

The IGMP snooping querier supports snooping by sending layer 2 membership queries to hosts attached to the switch. The snooping querier is functional on VLANs where hosts receive IP multicast traffic without access to a network IP multicast router. A snooping querier avoids flooding multicast packets in the VLAN by querying for hosts and routers.

The IGMP snooping querier is functional on VLANs that meet these criteria:

- Snooping is enabled.
- The corresponding SVI (VLAN interface) is active.
- The VLAN querier IP address or the global querier IP address is configured.

The `default ip igmp snooping vlan querier` command restores the usage of the global setting for the specified VLAN by removing the corresponding `ip igmp snooping vlan querier` or `no ip igmp snooping vlan querier` command from *running-config*.

Command Mode

Global Configuration

Command Syntax

```
ip igmp snooping vlan v_range querier
no ip igmp snooping vlan v_range querier
default ip igmp snooping vlan v_range querier
```

Parameters

- *v_range* VLAN IDs. Formats include a number, a number range, or a comma-delimited list of numbers and ranges. Numbers range from 1 to 4094.

Examples

- These commands globally enable the snooping querier on the switch, explicitly disable snooping on VLANs 1-3, and explicitly enable snooping on VLANs 4-6.

```
switch(config)#ip igmp snooping querier
switch(config)#no ip igmp snooping vlan 1-3 querier
switch(config)#ip igmp snooping vlan 4-6 querier
```

After running these commands, the running-config file contains these lines, which indicate that the snooping querier is enabled on VLANs 4-6.

```
switch(config)#show running-config
<-----OUTPUT OMITTED FROM EXAMPLE----->
no ip igmp snooping vlan 1 querier
no ip igmp snooping vlan 2 querier
no ip igmp snooping vlan 3 querier
ip igmp snooping vlan 4 querier
ip igmp snooping vlan 5 querier
ip igmp snooping vlan 6 querier
ip igmp snooping querier
```

```
<-----OUTPUT OMITTED FROM EXAMPLE----->
```

- This command removes the querier setting for VLANs 2-5:

```
switch(config)#default ip igmp snooping vlan 2-5 querier
```

When executed after the previous commands, the snooping querier is disabled explicitly on VLANs 1-2, enabled implicitly on VLANs 3-6, and enabled explicitly on VLANs 7-8, as shown by **running-config**:

```
<-----OUTPUT OMITTED FROM EXAMPLE----->
no ip igmp snooping vlan 1 querier
ip igmp snooping vlan 6 querier
ip igmp snooping querier
<-----OUTPUT OMITTED FROM EXAMPLE----->
```

- This command sets the global snooping querier to disabled by removing the global querier setting from running-config:

```
switch(config)#no ip igmp snooping querier
switch(config)#
```

When executed after the previous commands, the snooping querier is disabled explicitly on VLANs 1-2, disabled implicitly on VLANs 3-6 and enabled explicitly on VLANs 7-8, as shown by running-config.

```
<-----OUTPUT OMITTED FROM EXAMPLE----->
no ip igmp snooping vlan 1 querier
ip igmp snooping vlan 6 querier
<-----OUTPUT OMITTED FROM EXAMPLE----->
```

15.2.8.43 ip igmp snooping vlan report-flooding switch-port

The `ip igmp snooping vlan report-flooding switch-port` command configures Ethernet ports or port channels to forward IGMP membership report messages for a specified VLAN range where L2 report flooding is enabled. Ports that are connected to multicast routers or queriers continue to forward traffic as previously specified and are not affected by L2 report flooding commands.

L2 report flooding is an IGMP snooping feature that forwards membership report messages to specified ports. The `ip igmp snooping report-flooding switch-port` command configures a list of forwarding ports for all VLANs where L2 report flooding is enabled.

The `no ip igmp snooping vlan report-flooding switch-port` and `default ip igmp snooping vlan report-flooding switch-port` commands remove the listed ports from the specified report flooding port list by deleting the corresponding `ip igmp snooping vlan report-flooding switch-port` statements from *running-config*.

Command Mode

Global Configuration

Command Syntax

```
ip igmp snooping vlan v_range report-flooding switch-port INTERFACE
no ip igmp snooping vlan v_range report-flooding switch-port INTERFACE
default ip igmp snooping vlan v_range report-flooding switch-port INTERFACE
```

Parameters

- `v_range` VLAN IDs. Formats include a number, number range, or comma-delimited list of numbers and ranges. Numbers range from 1 to 4094.
- `INTERFACE` Membership report message forwarding is enabled on these ports:
 - **ethernet** `e_range` where `e_range` is the number, range, or list of ethernet ports
 - **port-channel** `p_range` where `p_range` is the number, range, or list of channel ports

Related Commands

- `ip igmp snooping report-flooding` globally enables L2 report flooding.
- `ip igmp snooping vlan report-flooding switch-port` specifies a port list for a VLAN range.
- `ip igmp snooping report-flooding switch-port` specifies a port list for all VLANs.

Example

- These commands globally enable L2 report flooding, enable flooding on VLANs 201 through 205, and specify Ethernet ports 8-10 as the report flooding port list for VLANs 201-205.

```
switch(config)#ip igmp snooping report-flooding
switch(config)#ip igmp snooping vlan 201-205 report-flooding
switch(config)#ip igmp snooping vlan 201-205 report-flooding switch-
port ethernet
8-10
switch(config)#
```

15.2.8.44 ip igmp snooping vlan report-flooding

The `ip igmp snooping vlan report-flooding` command enables L2 report flooding on the specified VLANs if report flooding is globally enabled. When L2 report flooding is not globally enabled, this command has no effect. The `ip igmp snooping report-flooding` command globally enables L2 report flooding.

L2 report flooding is an IGMP snooping feature that forwards membership report messages to specified ports. Relying on a single switch to maintain and send report messages can degrade performance. L2 report flooding addresses this by facilitating report message forwarding through any network port. This allows switches to bypass the querier when forwarding multicast traffic to its interested ports.

Two commands specify the ports that forward reports:

- `ip igmp snooping vlan report-flooding switch-port` for a VLAN range.
- `ip igmp snooping report-flooding switch-port` for all VLANs where report flooding is enabled.

The `no ip igmp snooping vlan report-flooding` and `default ip igmp snooping vlan report-flooding` commands disable L2 report flooding for the specified VLAN by removing the corresponding `ip igmp snooping vlan report-flooding` statement from *running-config*.

Command Mode

Global Configuration

Command Syntax

```
ip igmp snooping vlan v_range report-flooding
no ip igmp snooping vlan v_range report-flooding
default ip igmp snooping vlan v_range report-flooding
```

Parameters

- `v_range` VLAN IDs Formats include a number, number range, or comma-delimited list of numbers and ranges. Numbers range from 1 to 4094.

Related Commands

- `ip igmp snooping report-flooding` globally enables L2 report flooding.

Example

- These commands enable L2 report flooding globally and on VLANs 201 through 205.

```
switch(config)#ip igmp snooping report-flooding
switch(config)#ip igmp snooping vlan 201-205 report-flooding
switch(config)#
```

15.2.8.45 ip igmp snooping vlan

The **ip igmp snooping vlan** command enables snooping on the specified VLANs if snooping is globally enabled. IGMP snooping is globally enabled by default. The **ip igmp snooping** command enables snooping globally.

Note that if IGMP snooping is enabled, QoS will not apply to IGMP packets.

The **no ip igmp snooping vlan** command disables snooping on the specified VLANs.

The **default ip igmp snooping vlan** command returns the snooping setting for the specified VLANs to enabled by removing the corresponding **ip igmp snooping vlan** command from **running-config**.

Command Mode

Global Configuration

Command Syntax

```
ip igmp snooping vlan v_range
```

```
no ip igmp snooping vlan v_range
```

```
default ip igmp snooping vlan v_range
```

Parameters

- *v_range* VLANs upon which snooping is enabled. Formats include a number, a number range, or a comma-delimited list of numbers and ranges. Numbers range from 1 to 4094.

Example

- This command disables snooping on VLANs 2 through 4.

```
switch(config)#no ip igmp snooping vlan 2-4  
switch(config)#
```

15.2.8.46 ip igmp snooping

The `ip igmp snooping` command enables snooping globally. By default, global snooping is enabled.

When global snooping is enabled, `ip igmp snooping vlan` enables or disables snooping on individual VLANs. When global snooping is disabled, snooping cannot be enabled on individual VLANs.

QoS cannot be used for IGMP packets when IGMP snooping is enabled.

The `no ip igmp snooping` command disables global snooping. The `default ip igmp snooping` command restores the global snooping default setting of enabled by removing the `ip igmp snooping` command from *running-config*.

Command Mode

Global Configuration

Command Syntax

```
ip igmp snooping
```

```
no ip igmp snooping
```

```
default ip igmp snooping
```

Example

- This command globally enables snooping on the switch.

```
switch(config)#ip igmp snooping
switch(config)#
```

15.2.8.47 ip igmp startup-query-count

The `ip igmp startup-query-count` command specifies the number of query messages that an interface sends during the startup interval defined by `ip igmp startup-query-interval`.

When an interface starts running IGMP, it can establish the group state more quickly by sending query messages at a higher frequency. The `startup-query-interval` and `startup-query-count` parameters define the startup period and the query message transmission frequency during that period.

The `no ip igmp startup-query-count` and `default ip igmp startup-query-count` commands restore the default `startup-query-count` value of 2 for the configuration mode interface by removing the corresponding `ip igmp startup-query-count` command from *running-config*.

Command Mode

Interface-Ethernet Configuration

Interface-Port-Channel Configuration

Interface-VLAN Configuration

Command Syntax

```
ip igmp startup-query-count number
```

```
no ip igmp startup-query-count
```

```
default ip igmp startup-query-count
```

Parameters

- *number* quantity of queries. Values range from 1 to 65535. Default is 2.

Example

- This command configures the startup query count of 10 for VLAN interface 4.

```
switch(config)#interface vlan 4
switch(config-if-Vl4)#ip igmp startup-query-count 10
switch(config-if-Vl4)#
```

15.2.8.48 ip igmp startup-query-interval

The **ip igmp startup-query-interval** command specifies the configuration mode interface IGMP startup period, during which query messages are sent at an accelerated rate.

When an interface starts running IGMP, it can establish the group state quicker by sending query messages at a higher frequency. The startup-query-interval and startup-query-count parameters define the startup period and the query message transmission frequency during that period.

The **no ip igmp startup-query-interval** and **default ip igmp startup-query-interval** commands restore the configuration mode interface default IGMP startup-query-interval of 31 seconds by removing the corresponding **ip igmp startup-query-interval** command from *running-config*.

Command Mode

Interface-Ethernet Configuration

Interface-Port-Channel Configuration

Interface-VLAN Configuration

Command Syntax

```
ip igmp startup-query-interval period
```

```
no ip igmp startup-query-interval
```

```
default ip igmp startup-query-interval
```

Parameters

- *period* startup query interval, in deciseconds. Value ranges from 10 (one second) to 317440 (8 hours, 49 minutes, 4 seconds). Default is 31 seconds.

Example

- This command configures the startup query count of one minute for VLAN interface 4.

```
switch(config)#interface vlan 4
switch(config-if-Vl4)#ip igmp startup-query-interval 600
switch(config-if-Vl4)#
```

15.2.8.49 ip igmp static-group acl

The `ip igmp static-group acl` command configures the configuration mode interface as a static member of the multicast groups specified by an IP access control list (ACL). This command is a variant of the `ip igmp static-group` command that uses ACL rules to specify a set of source-multicast group address pairs instead of specifying a single pair. Multiple static-group ACLs can be assigned to an interface. Static groups can be assigned manually and through ACLs simultaneously.

Access control lists that this command references must contain rules of the following format.

- `permit <protocol><source><destination>`, where
 - `<protocol>` has no effect on the static group.
 - `<source>` address of host originating multicast data packets. Must be a host address.
 - `<destination>` multicast group IP address or subnet. Must be a valid multicast address.

An ACL can contain multiple rules. An ACL can be applied to an interface only when all of its rules comply to the specified restrictions. The `show ip igmp static-groups acl` displays the source-multicast group pairs that the specified list configures and lists issues with illegal rules.

The `no ip igmp static-group acl` and `default ip igmp static-group acl` commands remove the specified static group ACL command from *running-config*.

Command Mode

Interface-Ethernet Configuration

Interface-Port-Channel Configuration

Interface-VLAN Configuration

Command Syntax

```
ip igmp static-group acl list_name
```

```
no ip igmp static-group acl
```

```
default ip igmp static-group acl
```

Parameters

- `list_name` ACL that specifies multicast group addresses for which interface fast-switches packets.

Example

- This command configures VLAN interface 4 as a static member of the multicast group specified by the ACL named LIST_1.

```
switch(config)#interface vlan 4
switch(config-if-Vl4)#ip igmp static-group acl LIST_1
switch(config-if-Vl4)#
```

15.2.8.50 ip igmp static-group range

The `ip igmp static-group range` command configures the configuration mode interface as a static member of multicast groups specified by an address range. This allows the router to forward multicast group packets through the interface without otherwise appearing or acting as a group member. By default, no static group memberships are configured on interfaces.

This command is a variant of the `ip igmp static-group` command that allows the assignment of a subnet range of source addresses or a subnet range of multicast groups. A single `ip igmp static-group range` command is the equivalent of multiple `ip igmp static-group` commands, each of which can only assign a single multigroup-source pair to an interface. Running-config converts the range command to the equivalent list of `ip igmp static-group` commands.

If the command includes a source address range, only multicast group messages received from the range are fast-switched. Otherwise, all multicast messages of the specified group are fast-switched.

The `no ip igmp static-group range` and `default ip igmp static-group range` commands remove the specified range of static group statements from *running-config*. The `no ip igmp static-group` and `default ip igmp static-group` commands can remove an individual static-group command that was initially added to *running-config* by an `ip igmp static-group range` command.

Command Mode

Interface-Ethernet Configuration

Interface-Port-Channel Configuration

Interface-VLAN Configuration

Command Syntax

```
ip igmp static-group range GROUP_ADDR[SOURCE_ADDR]
```

```
no ip igmp static-group range GROUP_ADDR[SOURCE_ADDR]
```

```
default ip igmp static-group range GROUP_ADDR[SOURCE_ADDR]
```

Parameters

- *GROUP_ADDR* address of multicast group for which the interface fast-switches packets.
 - *gp_ipv4_addr* multicast group IPv4 address.
 - *gp_ipv4_subnet* IPv4 subnet address of multicast groups (CIDR or address-mask).
- *SOURCE_ADDR* IP address of a host range that originates multicast data packets.
 - <no parameter> all multicast messages of the specified range are fast-switched.
 - **source** *sr_ipv4_address* source IPv4 address (dotted decimal notation).
 - **source** *sr_ipv4_subnet* IPv4 subnet address of source hosts (CIDR or address-mask).



Note: A command cannot specify a subnet address for both multicast group and source.

Examples

- This command configures VLAN interface 4 as a static member of the multicast group range 241.1.4.1/24 for data packets that originate at 10.1.1.1.

```
switch(config)#interface vlan 4
switch(config-if-Vl4)#ip igmp static-group range 239.1.4.1/24 source
10.1.1.1
switch(config-if-Vl4)#
```

-
- This command attempts to configure VLAN interface 4 as a static member of the multicast group range 241.1.4.1/24 for data packets that originate at the 10.1.1.1/29 subnet. Because the range and source cannot both be subnets, this command generates an error message.

```
switch(config-if-Vl4)#ip igmp static-group range 239.1.1.1/29 source
16.1.1.1/29
% Error: cannot specify source range with group range
switch(config-if-Vl4)#
```

15.2.8.51 ip igmp static-group

The `ip igmp static-group` command configures the configuration mode interface as a static member of a specified multicast group. This allows the router to forward multicast group packets through the interface without otherwise appearing or acting as a group member. By default, static group memberships are not configured on any interfaces.

If the command includes a source address, only multicast group messages received from the specified host address are fast-switched. Otherwise, all multicast messages of the specified group are fast-switched.

 **Note:** To become a static member of a multicast group, the switch must be the PIM designated router (DR) for the network. If it is not, you can use the `pim ipv4 dr-priority` command to make it the DR by configuring its PIM DR value to be the highest on the network.

The `no ip igmp static-group` and `default ip igmp static-group` commands remove the configuration mode interface group membership by removing the corresponding `ip igmp static-group` command from *running-config*.

Command Mode

Interface-Ethernet Configuration

Interface-Port-Channel Configuration

Interface-VLAN Configuration

Command Syntax

```
ip igmp static-group group_address [SOURCE_ADDRESS]
```

```
no ip igmp static-group group_address [SOURCE_ADDRESS]
```

```
default ip igmp static-group group_address [SOURCE_ADDRESS]
```

Parameters

- `group_address` IPv4 address of multicast group for which the interface fast-switches packets.
- `SOURCE_ADDRESS` IP address of host that originates multicast data packets.
 - `<no parameter>` all multicast messages of the specified group are fast-switched.
 - `ipv4_address` source IP address (dotted decimal notation).

Related Commands

- `ip igmp static-group acl` configures the configuration mode interface as a static member of the multicast groups specified by an IP access control list (ACL).
- `ip igmp static-group range` configures the configuration mode interface as a static member of multicast groups specified by an address range.

One `ip igmp static-group range` command is equivalent to multiple `ip igmp static-group` commands.

Example

- These commands configure VLAN interface 15 as the PIM designated router, then configure it as a static member of the multicast group at address 231.1.1.15 for multicast data packets that originate at 10.1.1.1.

```
switch(config)#interface vlan 15
switch(config-if-Vl15)#pim ipv4 dr-priority 5000
switch(config-if-Vl15)#ip igmp static-group 231.1.1.45 10.1.1.1
switch(config-if-Vl15)#
```

15.2.8.52 ip igmp version

The **ip igmp version** command configures the Internet Group Management Protocol (IGMP) version on the configuration mode interface. Version 3 is the default IGMP version.

IGMP is enabled by the [pim ipv4 sparse-mode](#) or [pim ipv4 bidirectional](#) command. The **ig igmp version** command does not affect the IGMP enabled status.

The **no ip igmp version** and **default ip igmp version** commands restore the configuration mode interface to IGMP version 3 by removing the **ip igmp version** statement from *running-config*.

Command Mode

Interface-Ethernet Configuration

Interface-Port-Channel Configuration

Interface-VLAN Configuration

Command Syntax

```
ip igmp version version_number
```

```
no ip igmp version
```

```
default ip igmp version
```

Parameters

- *version_number* IGMP version number. Value ranges from 1 to 3.

Example

- This command configures IGMP version 3 on VLAN interface 4.

```
switch(config)#interface vlan 4
switch(config-if-Vl4)#ip igmp version 3
switch(config-if-Vl4)#
```

15.2.8.53 ip igmp

The `ip igmp` command enables IGMP on a routed interface or on SVI (VLAN interface) without enabling PIM.

The `no ip igmp` command removes the corresponding `ip igmp` command from *running-config*.

Command Mode

Interface Configuration

Command Syntax

```
ip igmp
```

```
no ip igmp
```

Example

- This command enables IGMP on Ethernet interface 5/2.

```
switch(config)#interface ethernet 5/2
switch(config-if-Et5/2)#ip igmp
switch(config-if-Et5/2)#
```

15.2.8.54 permit / deny

The **permit** command configures the configuration mode IGMP profile as a permit list. Applying a permit list to an interface restricts that interface from joining any multicast group not included in the list.

IGMP profiles are deny lists by default. When applied to an interface, a deny list allows the interface to join any multicast group that is not included in the list.

The **deny** command restores the IGMP list to its default type by removing the corresponding **permit** statement from *running-config*.

The **range** command adds and removes address ranges from the configuration mode profile.

Command Mode

IGMP-profile Configuration

Command Syntax

permit

deny

Related Commands

- [ip igmp profile](#) places the switch in IGMP-profile configuration mode.

Example

- These commands enter IGMP profile configuration mode and configure the profile as a permit list.

```
switch(config)#ip igmp profile list_1
switch(config-igmp-profile-list_1)#permit
switch(config-igmp-profile-list_1)#
```

15.2.8.55 range

The **range** command specifies an address range for the configuration mode IGMP profile. A permit range specifies the groups that an interface is permitted to join. A deny range specifies the groups that an interface is not permitted to join. The **permit / deny** command specifies the range type.

A profile may contain multiple range statements to define a discontinuous address range.

The **no range** and **default range** commands remove the specified address range from a previous specified list.

Command Mode

IGMP-profile Configuration

Command Syntax

```
range init_address [UPPER_RANGE]
```

```
no range init_address [UPPER_RANGE]
```

```
default range init_address [UPPER_RANGE]
```

Parameters

- *init_address* IP address of lower boundary of the address range (dotted decimal notation).
- UPPER_RANGE sets the upper boundary of the address range. Options include
 - <no parameter> upper boundary is equal to lower boundary: range consists of one address.
 - *range_address* IP address of upper boundary.

All addresses must be multicast addresses (10.0.0.0 to 239.255.255.255).

Related Commands

- [ip igmp profile](#) places the switch in IGMP-profile configuration mode.

Example

- These commands enter IGMP profile configuration mode, configure the profile as a permit list, and define the permit address list of 232.1.1.0 to 232.1.1.255 and 233.1.1.10.

```
switch(config)#ip igmp profile list_1
switch(config-igmp-profile-list_1)#permit
switch(config-igmp-profile-list_1)#232.1.1.0 232.1.1.255
switch(config-igmp-profile-list_1)#233.1.1.10
switch(config-igmp-profile-list_1)#ip igmp profile
```

15.2.8.56 show igmp snooping querier counters

The **show igmp snooping querier counters** command displays the counters from the querier, as learned through Internet Group Management Protocol (IGMP).

Command Mode

EXEC

Command Syntax

```
show igmp snooping querier counters [ VLAN_ID]
```

Parameters

- VLAN_ID specifies VLANs for which command displays information. Options include:
 - <no parameter> displays information for all VLANs.
 - **vlan** *v_num* displays information for specified VLAN.

Example

- This command displays the counters from the querier.

```
switch>show igmp snooping querier counters
-----
Vlan: 1      IP Addr: 100.0.0.1      Op State: Querier      Version:  v3

v1 General Queries Sent      :0
v1 Queries Received          :0
v1 Reports Received          :0
v2 General Queries Sent      :1
v2 Queries Received          :0
v2 Reports Received          :25
v2 Leaves Received           :0
v3 General Queries Sent      :655
v3 GSQ Queries Sent          :0
v3 GSSQ Queries Sent         :8
v3 Queries Received          :654
v3 Reports Received          :2385
Error Packets                 :0
Other Packets                 :0
switch>
```

15.2.8.57 show igmp snooping querier membership

The **show igmp snooping querier membership** command displays the membership from the querier, as learned through Internet Group Management Protocol (IGMP).

Command Mode

EXEC

Command Syntax

```
show igmp snooping querier membership [ VLAN_ID [GROUP_LIST]]
```

Parameters

- VLAN_ID specifies VLANs for which command displays information. Options include:
 - <no parameter> displays information for all VLANs.
 - **vlan** *v_num* displays information for specified VLAN.
- GROUP_LIST list of groups for which the command displays information. Options include:
 - <no parameter> all multicast groups within specified VLAN.
 - **group** *ipv4_addr* single multicast group address (dotted decimal notation).

Example

- This command displays the membership from the querier fro VLAN 1.

```
switch>show igmp snooping querier membership
-----
Vlan: 1      Elected: 10.0.0.1      QQI: 125  QRV: 2  QRI: 10  GMI: 260
Groups      Mode  Ver  Num of Sources
-----
10.0.0.2    EX    v3   0 []
10.0.0.3    IN    v3   2 [ 3.3.3.3, 3.3.3.4 ]
10.0.0.4    EX    v3   0 []
10.0.0.13   EX    v3   0 []
10.0.0.22   EX    v3   0 []
10.0.0.1    IN    v3   3 [ 5.6.7.9, 5.6.7.8, ... ]
switch>
```

15.2.8.58 show igmp snooping querier

The **show igmp snooping querier** command displays snooping querier configuration and status information. Command provides options to only include specific VLANs.

Command Mode

EXEC

Command Syntax

```
show igmp snooping querier [STATUS] [VLAN_ID] [DATA]
```

Parameters

- STATUS specifies the type of information displayed. Options include:
 - <no parameter> querier IP address, port, and IGMP version.
 - **status** querier configuration parameters.
- VLAN_ID specifies VLANs for which command displays information. Options include:
 - <no parameter> all VLANs.
 - **vlan** *v_num* specified VLAN.
- DATA specifies the type of information displayed. Options include:
 - <no parameter> displays VLAN number and port-list for each group.
 - **detail** displays port-specific data for each group; includes transmission times and expiration.

Example

- This command displays the querier IP address, version, and port servicing each VLAN.

```
switch>show igmp snooping querier
Vlan  IP Address      Version  Port
-----
 1     172.17.0.37       v2       Po1
20     172.17.20.1       v2       Po1
26     172.17.26.1       v2       Cpu
2028   172.17.255.29    v2       Po1
switch>
```

- This command displays the querier configuration parameters for each VLAN.

```
switch>show igmp snooping querier status
Global IGMP Querier status
-----
admin state           : Enabled
source IP address     : 0.0.0.0
query-interval (sec)  : 125.0
max-response-time (sec) : 10.0
querier timeout (sec) : 130.0

Vlan Admin   IP           Query   Response Querier Operational
     State   Address      Interval Time    Timeout State
-----
 1   Enabled  0.0.0.0      125.0  10.0    130.0  Non-Querier
 4   Enabled  0.0.0.0      125.0  10.0    130.0  Non-Querier
20   Enabled  0.0.0.0      125.0  10.0    130.0  Non-Querier
22   Enabled  0.0.0.0      125.0  10.0    130.0  Non-Querier
28   Enabled  0.0.0.0      125.0  10.0    130.0  Non-Querier
```

15.2.8.59 show ip igmp groups count

The **show ip igmp groups count** command displays the number of multicast groups that are joined across the specified interfaces.

Command Mode

EXEC

Command Syntax

```
show ip igmp groups [GROUP_LIST] count
```

Parameters

- **INTERF** Specifies the interface for which the command displays information. Options include:
 - <no parameter> all IGMP interfaces.
 - **interface ethernet** *e_num* Ethernet interface.
 - **interface loopback** *l_num* Loopback interface.
 - **interface management** *m_num* Management interface.
 - **interface port-channel** *p_num* Port-Channel Interface.
 - **interface vlan** *v_num* VLAN interface.
 - **interface vxlan** *vx_num* VXLAN interface.

Example

- This command displays the number of multicast groups joined across all interfaces.

```
switch>show ip igmp groups count
Number of total groups joined across all IGMP interfaces: 5
switch>
```

- This command displays the number of multicast groups joined on Ethernet 3/4 interface.

```
switch>show ip igmp groups interface ethernet 3/4 count
Number of groups joined on Ethernet3/4: 2
switch>
```

15.2.8.60 show ip igmp groups

The **show ip igmp groups** command displays multicast groups that have receivers directly connected to the switch, as learned through Internet Group Management Protocol (IGMP).

- **show ip igmp groups** all multicast groups.
- **show ip igmp groups** *group_addr* listed multicast group.
- **show ip igmp groups interface** *int_name* all multicast groups on specified interfaces
- **show ip igmp groups** *group_addr* **interface** *int_name* listed multicast group on specified interface.

Command Mode

EXEC

Command Syntax

```
show ip igmp groups GROUP_LIST [DATA]
```

Parameters

- GROUP_LIST list of groups for which the command displays information. Options include:
 - <no parameter> all multicast groups.
 - *group_addr* single multicast group address (dotted decimal notation).
 - **interface ethernet** *e_num* all multicast groups on specified Ethernet interface.
 - **interface loopback** *l_num* all multicast groups on specified Loopback interface.
 - **interface management** *m_num* all multicast groups on specified Management interface.
 - **interface port-channel** *p_num* all multicast groups on specified Port-Channel Interface.
 - **interface vlan** *v_num* all multicast groups on specified VLAN interface.
 - **interface vxlan** *vx_num* all multicast groups on specified VXLAN interface.
- DATA specifies the type of information displayed. Options include:
 - <no parameter> provides uptime, expiration, and address of reporter.
 - **detail** also include group mode and group source list.

Example

- This command displays multicast groups with receivers directly connected to the switch.

```
switch>show ip igmp groups
NOTE: static-group information not shown below. Use the
      'show ip igmp static-groups' command.
IGMP Connected Group Membership
Group Address      Interface          Uptime    Expires    Last
Reporter
10.12.1.1          Vlan162           11d01h    00:02:57
172.17.2.110
10.12.1.2          Vlan162           11d01h    00:02:57
172.17.2.110
10.12.1.3          Vlan162           11d01h    00:02:57
172.17.2.110
10.12.1.4          Vlan162           11d01h    00:02:57
172.17.2.110
10.12.1.5          Vlan162           11d01h    00:02:57
172.17.2.110
switch>
```

15.2.8.61 show ip igmp host-proxy config-sanity

The **show ip igmp host-proxy config-sanity** command displays diagnostic information about an IGMP host proxy configuration.

Command Mode

EXEC

Command Syntax

```
show ip igmp host-proxy config-sanity
```

Example

- This command displays IGMP host proxy configuration diagnostic information.

```
switch>show ip igmp host-proxy config-sanity
Below are hints of potential IGMP Host-Proxy misconfigurations
IGMP host-proxy configured on interface Test3:
Access-lists having "deny ip any any" rule:
acl1
acl2
Groups with overlapping permit and deny configurations:
192.168.1.1/32
192.168.2.2/32
192.168.4.4/32
Groups with source filters configured with IGMP Host-Proxy set to
version 2 :
192.168.2.2/32
192.168.3.0/24
192.168.3.3/32
192.168.8.8/32
switch>
```

15.2.8.62 show ip igmp host-proxy interface

The **show ip igmp host-proxy interface** command displays per-interface IGMP host-proxy configuration information, including the IGMP groups joined on the interface. Command filters allow the list to display only data for a specified interface and to include packet counter statistics in the display.

Command Mode

EXEC

Command Syntax

```
show ip igmp host-proxy interface [interface] [detail]
```

Parameters

- *interface* optional parameter to limit the display to a single interface. Omitting the parameter displays host-proxy configuration information for all interfaces on which IGMP host-proxy is configured. Options include:
 - **ethernet** *e_num* Ethernet interface specified by *e_num*.
 - **port-channel** *p_num* port-channel Interface specified by *p_num*.
 - **vlan** *v_num* VLAN interface specified by *v_num*.
- detail use this optional keyword to include packet counter statistics in the display.

Examples

- This command displays host-proxy information for all switch interfaces on which IGMP host-proxy is configured.

```
switch>show ip igmp host-proxy interface
IGMP host-proxy configured on: Test2
IGMP host-proxy version: 3
Unsolicited-report interval: 1.0
Device name: Test2
Interface Group Address IncludeSrc ExcludeSrc
Test2 172.16.89.0
Test2 172.16.0.0 20.0.0.0
Test2 172.16.0.0 10.0.0.0
Test2 192.168.110.0 20.0.0.0
```

- This command displays host-proxy information for all switch interfaces on which IGMP host-proxy is configured, plus host-proxy statistics.

```
switch>show ip igmp host-proxy interface detail
IGMP host-proxy configured on: Test2
IGMP host-proxy version: 3
Unsolicited-report interval: 1.0
Device name: Test2
Interface Group Address IncludeSrc ExcludeSrc
Test2 172.16.89.0
Test2 172.16.0.0 20.0.0.0
Test2 172.16.0.0 10.0.0.0
Test2 192.168.110.0 20.0.0.0
IGMP host-proxy statistics:
IGMP v1 Queries received: 0
IGMP v2 General-Queries received: 0
IGMP v2 Group-Queries received: 0
IGMP v3 General-Queries received: 0
IGMP v3 Group-Queries received: 0
IGMP v3 Group-Source Queries received: 0
IGMP v1 Reports sent: 0
IGMP v2 Reports sent: 0
IGMP v3 Reports sent: 1
```

15.2.8.63 show ip igmp interface

The **show ip igmp interface** command displays multicast information about the specified interface.

Command Mode

EXEC

Command Syntax

```
show ip igmp interface [INT_NAME]
```

Parameters

- INT_NAME Interface type and number. Values include
 - **<no parameter>** Displays information for all interfaces.
 - **ethernet** *e_num* Ethernet interface specified by *e_num*.
 - **loopback** *l_num* Loopback interface specified by *l_num*.
 - **management** *m_num* Management interface specified by *m_num*.
 - **port-channel** *p_num* Port-Channel Interface specified by *p_num*.
 - **vlan** *v_num* VLAN interface specified by *v_num*.
 - **vxlan** *vx_num* VXLAN interface specified by *vx_num*.

Example

- This command displays multicast related information about VLAN 26.

```
switch>show ip igmp interface vlan 26
Vlan26 is up
Interface address: 172.17.26.1/23
IGMP on this interface: enabled
Multicast routing on this interface: enabled
Multicast TTL threshold: 1
Current IGMP router version: 2
IGMP query interval: 125 seconds
IGMP max query response time: 100 deciseconds
Last member query response interval: 10 deciseconds
Last member query response count: 2
IGMP querier: 172.17.26.1
Robustness: 2
Require router alert: enabled
Startup query interval: 312 deciseconds
Startup query count: 2
General query timer expiry: 00:00:22
Multicast groups joined:
    239.255.255.250
switch>
```

15.2.8.64 show ip igmp profile

The **show ip igmp profile** command displays the contents of the specified IGMP profile. IGMP snooping filters use an IGMP profile to control the multicast groups that an interface can join.

Command Mode

EXEC

Command Syntax

```
show ip igmp profile [PROFILES]
```

Parameters

- PROFILES IGMP profiles for which command displays contents. Options include:
 - <no parameter> displays all IGMP profiles.
 - *profile_name* displays specified profile.

Example

- This command displays the IGMP profiles configured on the switch.

```
switch>show ip igmp profile
IGMP Profile list_1
permit
range 229.1.24.0 229.1.25.255
IGMP Profile list_2
deny
range 234.1.1.0 234.1.255.255
switch>
```

15.2.8.65 show ip igmp snooping counters ethdev-pams

The **show ip igmp snooping counters** command displays the number of dropped IGMP packets messages sent and received through each switch port at the kernel level. The display table sorts the messages by type.

Command Mode

EXEC

Command Syntax

```
show ip igmp snooping counters ethdev-pams
```

Example

- This command displays the number of messages dropped at the kernel level.

```
switch>show ip igmp snooping counters ethdev-pams
  IntfName  rxErrors  txErrors  txDrops
    et9      1          0          0
    et18     1          0          0
    mlag9    1          0          0
    mlag8    1          0          0
    et17     1          0          0
    po1      1          0          0
    po2      1          0          0
    et15     1          0          0
    et6      1          0          0
    mlag10   1          0          0
    et16     1          0          0
    mlag7    1          0          0
    et11     1          0          0
    mlag5    1          0          0
    mlag4    1          0          0
    cpu      1          0          0
    et13     1          0          0
switch>
```

15.2.8.66 show ip igmp snooping counters

The **show ip igmp snooping counters** command displays the number of IGMP messages sent and received through each switch port. The display table sorts the messages by type.

Command Mode

EXEC

Command Syntax

```
show ip igmp snooping counters [ DATA_TYPE ][ DATA_LEVEL ]
```

Parameters

- **DATA_TYPE** Information displayed by the command. Options include:
 - <no parameter> displays transmission counters.
 - **errors** displays error counters.
- **DATA_LEVEL** specifies the type of information displayed. Options include:
 - <no parameter> number of packets on physical ports.
 - **detail** number of packets on physical ports.

Example

- This command displays the number of messages received on each port.

```
switch>show ip igmp snooping counters
```

Port	Input				Errors	Output			
	Queries	Reports	Leaves	Others		Queries	Reports	Leaves	Others
Cpu	15249	106599	4	269502	0	30242	102812	972	3625
Et1	0	0	0	0	0	0	0	0	0
Et2	0	6	1	26	0	5415	0	0	731
Et3	0	10905	222	1037	0	15246	0	0	1448
Et4	0	44475	21	288	0	15247	0	0	2199
Et5	0	355	0	39	0	15211	0	0	2446
Et6	0	475	13	0	0	15247	0	0	2487
Et7	0	0	0	151	0	15247	0	0	2336
Et8	0	578	6	75	0	2859	0	0	931
Et9	0	0	0	27	0	15247	0	0	2460
Et10	0	12523	345	54	0	15247	0	0	2433
Et11	0	0	0	0	0	0	0	0	0
Et12	0	4509	41	22	0	15247	0	0	2465
Et13	0	392	29	119	0	15247	0	0	2368
Et14	0	88	3	6	0	15247	0	0	2481
Et15	0	16779	556	72	0	15117	0	0	66
Et16	0	2484	13	66	0	15247	0	0	2421
Et17	0	0	0	0	0	0	0	0	0
Et18	0	20	6	160	0	3688	0	0	803
Et19	0	4110	17	0	0	15247	0	0	2487
Et20	0	0	0	0	0	0	0	0	0
Et21	0	0	0	0	0	0	0	0	0
Et22	0	0	0	52	0	15247	0	0	2435
Et23	0	5439	181	138	0	15247	0	0	2349
Et24	0	2251	21	4	0	15247	0	0	2483
Po1	45360	540670	8853	464900	0	15249	224751	618	2576
Po2	0	101399	58	17	0	15120	0	0	1121
Switch	0	0	0	0	0	0	0	0	0

15.2.8.67 show ip igmp snooping groups count

The `show ip igmp snooping groups count` command displays the number of multicast groups on the switch. Command provides options to only include specific VLANs and ports.

Command Mode

EXEC

Command Syntax

```
show ip igmp snooping groups [VLAN_ID][PORT_INT] count [DATA]
```

Parameters

- VLAN_ID specifies VLAN for which command displays information. Options include:
 - <no parameter> all VLANs.
 - **vlan** *v_num* specified VLAN.
- PORT_INT specifies physical ports for which command displays information. Options include:
 - <no parameter> all physical ports.
 - **interface ethernet** *e_range* specified Ethernet ports.
 - **interface port-channel** *p_range* specified port channels.

Valid *e_range* and *p_range* formats include number, number range, or comma-delimited list of numbers and ranges.

- DATA specifies the type of information displayed. Options include:
 - <no parameter> number of multicast group on specified VLAN and ports.
 - **detail** number of multicast group on specified VLAN and ports.

Example

- This command displays the number of multicast groups on the switch.

```
switch>show ip igmp snooping groups count
Total number of multicast groups: 2
switch>
```

15.2.8.68 show ip igmp snooping groups

The **show ip igmp snooping groups** command displays IGMP snooping statistics. Available information includes the physical ports that send and receive information, the time when multicast data was originally and most recently heard on the ports, and the version number of the IGMP messages. Command provides options that restrict the output to specific VLANs, ports, and groups.

Command Mode

EXEC

Command Syntax

```
show ip igmp snooping groups proxy [VLAN_ID][PORT_INT][GROUPS][DATA]
```

Parameters

- VLAN_ID specifies VLAN for which command displays information. Options include:
 - <no parameter> displays information for all VLANs.
 - **vlan** *v_num* displays information for VLAN *v_num* (1 to 4094).
- PORT_INT specifies physical ports for which command displays information. Options include:
 - <no parameter> displays information for all physical ports.
 - **interface ethernet** *e_range*, where *e_range* is the number, range, or list of Ethernet ports.
 - **interface port-channel** *p_range*, where *p_range* is the number, range, or list of channel ports.
- GROUPS specifies the multicast groups. Options include:
 - <no parameter> all multicast groups on all specified ports.
 - *mgroup_address* multicast group specified by IPv4 address (dotted decimal notation).
 - **dynamic** multicast groups learned through IGMP.
 - **user** multicast groups manually added.
- DATA specifies the type of information displayed. Options include:
 - <no parameter> VLAN number and port-list for each group.
 - **detail** port-specific information for each group, including transmission times and expiration.
- **proxy** displays IGMP snooping proxy information.

Examples

- This command displays the port lists for all multicast groups.

```
switch>show ip igmp snooping groups
Vlan  Group                Type      Version      Port-List
-----
-
1      239.255.255.250  -        -            Po1, Po2
26     239.255.255.250  -        -            Cpu, Et3, Et4,
      Et10, Et23,
                                         Et27
switch>
```

- This command displays detailed port information of all multicast groups.

```
switch>show ip igmp snooping groups detail
Vlan Group          IP          First      Last      Expire      Ver
  Filter Port
          Mode
-----
-
```

```

1 239.255.255.250 172.17.3.73 2536:15 0:47 3:33 v2 0
  Po2
1 239.255.255.250 172.17.0.37 31532:48 0:18 1:27 - -
  Po1
26 239.255.255.250 172.17.26.189 5:07 0:52 3:28 v2 0
  Et3
26 239.255.255.250 172.17.26.182 17:34 3:02 1:18 v2 0
  Et3
26 239.255.255.250 172.17.26.245 1046:47 0:57 3:23 v2 0
  Et4
26 239.255.255.250 172.17.26.184 27:41 0:53 3:27 v2 0
  Et10
26 239.255.255.250 172.17.26.161 9:16 0:56 3:24 v2 0
  Et23
26 239.255.255.250 172.17.26.62 90:24 0:50 3:30 v2 0
  Et27
26 239.255.255.250 172.17.26.1 31532:52 0:04 1:41 - -
  Cpu
switch>

```

- This command displays the port lists for all dynamic multicast groups.

```

switch>show ip igmp snooping groups dynamic
Vlan  Group                Type      Version      Port-List
-----
-
1     239.255.255.250 -        -           Po1, Po2
26    239.255.255.250 -        -           Cpu, Et3, Et4,
      Et10, Et23,
                                     Et27, Et34
switch>

```

- This command displays the detailed port information for all dynamic multicast groups.

```

switch>show ip igmp snooping groups dynamic detail
Vlan Group          IP           First      Last      Expire      Ver
  Filter Port
      Mode
-----
-
1     239.255.255.250 172.17.3.73 2539:16   1:37     2:43       v2  0
  Po2
1     239.255.255.250 172.17.0.37 31535:49  0:19     1:26       -   -
  Po1
26    239.255.255.250 172.17.26.189 8:08     3:53     0:27       v2  0
  Et3
26    239.255.255.250 172.17.26.182 20:35    1:49     2:31       v2  0
  Et3
26    239.255.255.250 172.17.26.245 1049:48  1:46     2:34       v2  0
  Et4
26    239.255.255.250 172.17.26.184 30:42    1:44     2:36       v2  0
  Et10
26    239.255.255.250 172.17.26.161 12:17    3:57     0:23       v2  0
  Et23
26    239.255.255.250 172.17.26.143 1:53     1:53     2:27       v2  0
  Et23
26    239.255.255.250 172.17.26.62 93:25    1:48     2:32       v2  0
  Et27
26    239.255.255.250 172.17.26.164 0:32     0:31     3:49       v2  0
  Et34

```

```

26 239.255.255.250 172.17.26.1 31535:53 0:05 1:40 - -
  Cpu
switch>

```

- This command displays the port lists for all static (user configured) multicast groups.

```

switch>show ip igmp snooping groups user
Vlan Group          Type      Version      Port-List
-----
-
1    239.255.255.250 -        -           Po1, Po2
26   239.255.255.250 -        -           Cpu, Et3, Et4,
      Et10, Et23,
                                      Et27, Et34
switch>

```

- This command displays detailed port information for all user configured (static) multicast groups.

```

switch>show ip igmp snooping groups user detail
Vlan Group          IP          First      Last      Expire     Ver
  Filter Port
      Mode
-----
-
1    239.255.255.250 172.17.3.73 2539:50   0:06     4:14      v2  0
      Po2
1    239.255.255.250 172.17.0.37 31536:23  0:23     1:22      -   -
      Po1
26   239.255.255.250 172.17.26.182 21:09    0:21     3:59      v2  0
      Et3
26   239.255.255.250 172.17.26.245 1050:22  0:17     4:03      v2  0
      Et4
26   239.255.255.250 172.17.26.184 31:16    0:17     4:03      v2  0
      Et10
26   239.255.255.250 172.17.26.161 12:51    0:17     4:03      v2  0
      Et23
26   239.255.255.250 172.17.26.143 2:27     2:27     1:53      v2  0
      Et23
26   239.255.255.250 172.17.26.62 93:59    0:22     3:58      v2  0
      Et27
26   239.255.255.250 172.17.26.164 1:06     0:21     3:59      v2  0
      Et34
26   239.255.255.250 172.17.26.1 31536:27  0:09     1:36     -   -
      Cpu
switch>

```

- This command displays detailed port information for multicast group 239.255.255.253 on VLAN 10.

```

switch>show ip igmp snooping groups vlan 10 239.255.255.253 detail
Vlan Group          IP          First      Last      Expire     Ver
  Filter Port
      Mode
-----
-
10   239.255.255.253 10.255.255.246 7177:16  0:08     2:07      v2  0
      Po7
10   239.255.255.253 10.255.255.247 7177:20  0:03     2:12      v2  0
      Po7

```

```

10 239.255.255.253 10.255.255.248 7177:16 0:06 2:09 v2 0
   Po7
10 239.255.255.253 10.255.255.254 7177:56 0:07 1:38 - -
   Cpu
switch>

```

- This command displays the groups that is present in IGMP report when a query is received on any of the ports listed under port-list.

```

switch>show ip igmp snooping groups proxy
Vlan      Group      Type      Port-List
-----
10        225.0.0.1   Proxy     Cpu, Et4, Et6
10        225.2.2.2   Proxy     Cpu, Et3, Et4
10        225.3.3.3   Proxy     Cpu, Et3, Et4, Et6

```

- This command displays all the information that is present in the IGMP report if a general IGMP query was received on Ethernet4.

```

switch>show ip igmp snooping groups proxy interface Ethernet4 detail
Vlan      Interface   Group      Source/Filter Mode
-----
10        Ethernet4   225.0.0.1   Include
          150.227.112.250
          190.171.60.6
10        Ethernet4   225.2.2.2   Exclude
10        Ethernet4   225.3.3.3   Exclude
          150.227.112.250

```

15.2.8.69 show ip igmp snooping mrouter

The **show ip igmp snooping mrouter** command displays the status of dynamic and static multicast router ports. Command provides options to include only specific VLANs.

Command Mode

EXEC

Command Syntax

```
show ip igmp snooping mrouter [VLAN_ID] [DATA]
```

Parameters

- VLAN_ID specifies VLAN for which command displays information. Options include:
 - <no parameter> all VLANs.
 - **vlan** *v_num* specified VLAN.
- DATA specifies the type of information displayed. Options include:
 - <no parameter> displays VLAN number and port-list for each group.
 - **detail** displays port-specific data for each group; includes transmission times and expiration.

Examples

- This command displays port information of each multicast router on all VLANs.

```
switch>show ip igmp snooping mrouter
Vlan      Interface-ports
-----
1         Po1 (dynamic)
20        Po1 (dynamic)
26        Cpu (dynamic)
2028      Cpu (dynamic), Po1 (dynamic)
switch>
```

- This command displays multicast router information for each port.

```
switch>show ip igmp snooping mrouter detail
Vlan  Intf      Address           FirstHeard  LastHeard  Expires
Type
-----
1     Po1       172.17.0.37      31549:12   0:12      1:33      pim
20    Po1       172.17.20.1     7066:51    0:19      1:26      pim
26    Cpu       172.17.26.1     31549:16   0:28      1:17      pim
2028  Po1       172.17.255.29   31549:10   0:18      1:27      pim
2028  Cpu       172.17.255.30   31549:14   0:28      1:17      pim
switch>
```

15.2.8.70 show ip igmp snooping report-flooding

The **show ip igmp snooping report-flooding** command displays IGMP snooping L2 report flooding configuration and status information. Command provides options to only include specific VLANs.

Command Mode

EXEC

Command Syntax

```
show ip igmp snooping report-flooding [VLAN_ID][DATA]
```

Parameters

- VLAN_ID specifies VLANs for which command displays information. Options include:
 - <no parameter> all VLANs.
 - **vlan** *v_num* specified VLAN.
- DATA specifies the type of information displayed. Options include:
 - <no parameter> displays VLAN number and port-list for each group.
 - **detail** displays port-specific data for each group; includes transmission times and expiration.

15.2.8.71 show ip igmp snooping

The `show ip igmp snooping` command displays the switch IGMP snooping configuration.

Command Mode

EXEC

Command Syntax

```
show ip igmp snooping [VLAN_ID]
```

Parameters

- VLAN_ID specifies VLANs for which command displays information. Options include:
 - <no parameter> displays information for all VLANs.
 - **vlan** *v_num* displays information for specified VLAN.

Example

- This command displays the switch IGMP snooping configuration.

```
switch>show ip igmp snooping
  Global IGMP Snooping configuration:
  -----
IGMP snooping                : Enabled
Robustness variable          : 2

Vlan 1 :
-----
IGMP snooping                : Enabled
Multicast router learning mode : pim-dvmrp

Vlan 20 :
-----
IGMP snooping                : Enabled
Multicast router learning mode : pim-dvmrp

Vlan 26 :
-----
IGMP snooping                : Enabled
Multicast router learning mode : pim-dvmrp

Vlan 2028 :
-----
IGMP snooping                : Enabled
Multicast router learning mode : pim-dvmrp
switch>
```

15.2.8.72 show ip igmp static-groups acl

The **show ip igmp static-groups acl** command displays information about the IGMP multicast static groups that are configured by the specified access control list (ACL). The command also displays problems with an ACL that prevent its assignment to an interface.

Command Mode

EXEC

Command Syntax

```
show ip igmp static-groups acl
```

Example

- The following **show ip igmp static-group acl** command example references these ACLs:

```
ip access-list 1
 10 permit igmp host 10.1.1.1 10.1.1.0/29
 20 permit igmp host 10.1.1.2 10.1.1.0/29
!
ip access-list 2
 10 permit igmp 10.1.1.0/29 host 10.1.1.1
!
ip access-list 3
 10 deny igmp host 10.1.1.1 255.1.1.0/29
!
ip access-list 4
 10 permit igmp host 10.1.1.1 10.1.1.0/29
 20 permit igmp 10.1.1.0/29 host 10.1.1.1
```

- This command displays static group configuration data about the various ACLs.

```
switch>show ip igmp static-group acl 1
acl 1
   ( 10.1.1.1, 10.1.1.0/29 )
   ( 10.1.1.2, 10.1.1.0/29 )
Interfaces using this ACL for static groups:
   Ethernet12
switch>show ip igmp static-group acl 2
acl 2
   Seq no 30: source address must be a single host or *, not a
   range
Interfaces using this ACL for static groups:
   Ethernet8
switch>show ip igmp static-group acl 3
acl 4
   Seq no 10: action must be 'permit'
Interfaces using this ACL for static groups:
   none
switch>show ip igmp static-group acl 4
acl 5
   ( 10.1.1.1, 10.1.1.0/29 )
   Seq no 20: source address must be a single host or *, not a
   range
Interfaces using this ACL for static groups:
   none
switch>
```

15.2.8.73 show ip igmp static-groups group

The `show ip igmp static-groups group` command displays information about all specified IGMP multicast static groups. IGMP multicast static groups are assigned with the [ip igmp static-group](#) command.

Command Mode

EXEC

Command Syntax

```
show ip igmp static-groups group [GROUP_LIST]
```

Parameters

- GROUP LIST Groups for which command displays information
 - <no parameter> all multicast groups.
 - *group_address* single multicast group address (dotted decimal notation).

Related Commands

- [show ip igmp static-groups](#)

15.2.8.74 show ip igmp static-groups

The **show ip igmp static-groups** command displays information about all configured IGMP multicast static groups. IGMP multicast static groups are assigned with the [ip igmp static-group](#) command.

Command Mode

EXEC

Command Syntax

```
show ip igmp static-groups [INFO_LEVEL] [interface INT_NAME]
```

Parameters

- INFO_LEVEL specifies the type of information displayed. Options include
 - <no parameter> VLAN number and port-list for each group.
 - **detail** port-specific information for each group, including transmission times and expiration.
- INT_NAME Interface type and number. Values include
 - <no parameter> static groups on all interfaces.
 - **ethernet** *e_num* Ethernet interface specified by *e_num*.
 - **loopback** *l_num* Loopback interface specified by *l_num*.
 - **management** *m_num* Management interface specified by *m_num*.
 - **port-channel** *p_num* Port-Channel Interface specified by *p_num*.
 - **vlan** *v_num* VLAN interface specified by *v_num*.
 - **vxlan** *vx_num* VXLAN interface specified by *vx_num*.

Related Commands

- [show ip igmp static-groups acl](#)
- [show ip igmp static-groups group](#)

Examples

- This command displays information about all multicast static groups.

```
switch>show ip igmp static-groups
Interface Vlan281:
    Manually configured groups:
Interface Port-Channel999:
    Manually configured groups:
switch>
```

- This command displays information about the multicast static groups on VLAN interface 21.

```
switch>show ip igmp static-groups interface vlan 21
Interface Vlan281:
    Manually configured groups:
switch>
```

15.2.8.75 show ip igmp statistics

The **show ip igmp statistics** command displays IGMP transmission statistics for the specified interface.

Command Mode

EXEC

Command Syntax

```
show ip igmp statistics [ INTERFACE_ID ]
```

Parameters

- INTERFACE_ID Specifies interface for which command returns data. Options include:
 - <no parameter> all interfaces.
 - **interface ethernet** *e_num* Ethernet interface specified by *e_num*.
 - **interface loopback** *l_num* Loopback interface specified by *l_num*.
 - **interface management** *m_num* Management interface specified by *m_num*.
 - **interface port-channel** *p_num* Port-Channel Interface specified by *p_num*.
 - **interface vlan** *v_num* VLAN interface specified by *v_num*.
 - **interface vxlan** *vx_num* VXLAN interface specified by *vx_num*.

Example

- This command displays IGMP transmission statistics for ethernet 1 interface.

```
switch>show ip igmp statistics interface ethernet 1
IGMP counters for Ethernet1:
  V1 queries sent: 0
  V2 queries sent: 0
  V3 queries sent: 3
  Total general queries sent: 3
  V3 group specific queries sent: 0
  V3 group-source specific queries sent: 0
  V1 queries received: 0
  V2 queries received: 0
  V3 queries received: 0
  V1 reports received: 0
  V2 reports received: 0
  V3 reports received: 14
  V2 leaves received: 0
  Error Packets received: 0
  Other Packets received: 0
switch>
```

15.3 Protocol Independent Multicast

Protocol Independent Multicast (PIM) distributes multicast data using routes gathered by other protocols. Arista switches support two types of PIM: PIM Sparse Mode (PIM-SM) and Bidirectional PIM (Bidir-PIM).

These sections describe the Arista PIM implementation:

- [Introduction](#)
- [Overview](#)
- [Configuring PIM](#)
- [Multicast Example](#)
- [PIM Commands](#)

15.3.1 Introduction

Protocol Independent Multicast (PIM) distributes multicast data using routes gathered by other protocols. PIM Sparse Mode (PIM-SM), defined in RFC 4601, is a multicast routing protocol intended for networks where multicast group recipients are sparsely distributed, including wide-area and inter-domain networks. Bidirectional PIM (Bidir-PIM), defined in RFC 5015, is a variant of PIM-SM designed for cases in which the receivers of multicast traffic are also sources and where scalability could affect optimization.

Arista switches support both PIM Sparse-Mode (PIM-SM) and Bidirectional PIM (Bidir-PIM).

15.3.2 Overview

PIM builds and maintains multicast routing trees using reverse path forwarding (RPF) on a unicast routing table. PIM is protocol-independent, and can use routing tables consisting of OSPF, BGP, RIP, and static routes. All sources send traffic to multicast groups through shared trees that have a common root node called the rendezvous point (RP).

PIM uses a multicast routing information base (MRIB) that is populated from the unicast table. The MRIB provides the next-hop router for each multicast destination subnet. This determines the next-hop neighbor for sending PIM join or prune messages.

15.3.2.1 PIM Sparse Mode

In PIM-SM, each host (sender or receiver) is associated with a designated router (DR) that acts for all directly connected hosts in PIM-SM transactions, and trees are unidirectional. Once sufficient traffic is flowing on a route it usually does not pass through the RP.

PIM-SM establishes multicast routes through three phases:

- Establishing the RP Tree
- Eliminating Encapsulation
- Establishing the Shortest Path Tree (SPT)

15.3.2.1.1 Establishing the RP Tree (Phase 1)

The RP tree is a distribution network that all sources share to deliver multicast data. The root of the RP tree is the Rendezvous Point.

The process starts when a receiver requests multicast data from a group (G). The receiver's DR sends a PIM (*,G) Join message toward the multicast group's RP. As the message travels towards the RP, it instantiates the multicast (*,G) state in each router on the path. Join messages converge on the RP to form the RP tree.

The DR resends Join messages periodically, while it has a receiver in the group, to prevent state timeout expiry in the routers along the path. When all receivers on a DR's subnet leave a group, the DR sends a (*,G) Prune message towards the RP to remove the state from the routers.

A multicast sender transmits multicast data to the RP through its DR. The DR encapsulates the multicast packets and sends them as unicast packets. The RP extracts the native multicast packet and sends it to the RP tree towards the group members.

15.3.2.1.2 Eliminating Multicast Encapsulation (Phase 2)

Data encapsulation, while initially required before the multicast path is established, is inefficient because it requires the transmission of data that is extraneous to multicast. Phase 2 establishes states in the routers that support the transmission of native multicast packets.

When the RP receives an encapsulated packet from source S on group G, it sends an (S,G) join message toward the source. As the message travels towards S, it instantiates the (S,G) state on each

router in the path which is used to forward packets from source S destined for group G. Data packets on the (S,G) path are also routed into the RP tree when they encounter an (*,G) router.

When the RP starts receiving native packets from the sources, it sends a Register-Stop message to the sources DR, halting packet encapsulation. At this time, traffic flows natively from the source along a source-specific tree to the RP, then along the shared RP tree to the receivers.

15.3.2.1.3 Establishing the Shortest Path Tree (Phase 3)

The third phase establishes the shortest path from the multicast source to all receivers.

When a multicast packet arrives at the receiver, its router (typically the DR) sends a Join message towards the source to instantiate the (S,G) state in all routers along its path. The message eventually reaches either the sources subnet or a router that already has an (S,G) state. This causes data to flow from the source to the receiver following the (S,G) path. At this time, the receiver is receiving data from the shortest path tree (SPT) and the RP tree (RPT).

The DR (or upstream router) eliminates the data transmission along the RPT by sending a prune message (S,G,rpt) towards the RP. The message instantiates the state on each router in the path, continuing until it reaches the RP or a router that needs traffic from the same source for other receivers.

15.3.2.2 Bidirectional PIM

Bidirectional PIM (Bidir-PIM) builds shared trees, rooted at the rendezvous point (RP), for each multicast group. Because the trees are based only on (*,G) routes, they can accommodate a much larger number of sources without overfilling the MFIB.

In Bidir-PIM, there is no multicast encapsulation or SPT establishment. All packets are natively forwarded toward the RP along shared, bidirectional trees. There are also no designated routers. Instead, a single designated forwarder (DF) is elected on each link to each RP, usually during the RP discovery process. The DF is the router with the shortest route to the RP based on the unicast routing table. It is responsible for forwarding upstream traffic toward the RP and forwarding downstream traffic toward the groups on its link. All routes pass through the RP, and multicast packets are sent from sources toward the RP and to receivers at each hop along the route.

Bidir-PIM elects DFs when a new RP is discovered, when the DF fails, or when there is a change that affects the topology of the link.

15.3.2.3 Rendezvous Points (RP)

In PIM-SM, an RP is a router that is configured as the root of multicast groups distribution tree. These distribution trees are not source-specific. The RP is the destination for both join messages from receivers and data from senders, allowing receivers discover sender identity and begin receiving group traffic. In PIM-SM, paths through RP routers are temporary; when traffic volume reaches a sufficient level, the receiver joins a source-specific tree and the path through the RP is dropped. In Bidir-PIM, all paths pass through the RP, and all packets destined for a given multicast group are forwarded to the RP for that group.

RP addresses in Bidir-PIM must be routable from all sources in the domain, but do not have to correspond to any specific physical interface. Multiple groups can use the same RP for distribution.

The switch supports two methods of mapping RPs to multicast groups:

- Static: RPs are statically configured through a CLI statement.
- Dynamic: RPs are dynamically selected by a bootstrap router from a set of candidate RPs.

While dynamic RP mappings have priority over static maps by default, a static RP can be configured to override dynamic mappings.

[Rendezvous Points \(RPs\)](#) describes the configuration of rendezvous points.

15.3.3 Configuring PIM

This section describes the following configuration tasks:

- [Enabling PIM IPv4 Sparse Mode](#)
- [Enabling PIM IPv6 Sparse Mode](#)
- [Enabling the S, G Expiry Timer Interval](#)
- [Enabling PIM Bidirectional](#)
- [Rendezvous Points \(RPs\)](#)
- [Hello Messages](#)
- [Hello Hold Time](#)
- [Designated Router Election](#)
- [Designated Forwarder Election](#)
- [Join-Prune Messages](#)
- [Legacy PIM Configuration in Global Configuration Mode](#)
- [Configuring PIM in a Non-default VRF](#)

15.3.3.1 Enabling PIM IPv4 Sparse Mode

By default, IPv4 PIM is disabled on an interface. The [pim ipv4 sparse-mode](#) command enables PIM IPv4 Sparse Mode (PIM-SM) on the configuration mode interface. Enabling PIM on an interface enables IGMP on the interface as well.

Example

This command enables IPv4 PIM-SM and IGMP on VLAN interface 8.

```
switch(config) #interface vlan 8
switch(config-if-Vl8) #pim ipv4 sparse-mode
switch(config-if-Vl8) #
```

15.3.3.2 Enabling PIM IPv6 Sparse Mode

By default, IPv6 PIM is disabled on an interface. The [pim ipv6 sparse-mode](#) command enables PIM IPv6 Sparse Mode (PIM-SM) on the configuration mode interface.

Example

This command enables IPv6 PIM-SM on Ethernet interface 15.

```
switch(config) #interface ethernet 15
switch(config-if-Et15) #pim ipv6 sparse-mode
switch(config-if-Et15) #
```

15.3.3.3 Enabling the S, G Expiry Timer Interval

The [sg-expiry-timer](#) command enables expiry timer interval for the PIM-SM multicast routes. By default, the [sg-expiry-timer](#) command applies to the default VRF when the command is issued in the Router-Multicast Configuration mode. During the time of interval, there is no multicast traffic activity on the route.

Example

This command configures 150 seconds as the (S,G) expiry timer interval in the default VRF.

```
switch(config)#router pim sparse-mode
switch(config-router-pim-sparse)#ipv4
switch(config-router-pim-sparse-ipv4)#sg-expiry-timer 150
switch(config-router-pim-sparse-ipv4)#
```

15.3.3.4 Enabling PIM Bidirectional

By default, PIM is disabled on an interface. The `pim ipv4 bidirectional` command enables Bidirectional PIM (Bidir-PIM) on the configuration mode interface. Enabling PIM on an interface also enables IGMP on that interface.

Example

These commands enable Bidir-PIM and IGMP on VLAN interface 9.

```
switch(config)#interface vlan 9
switch(config-if-Vl9)#pim ipv4 bidirectional
switch(config-if-Vl9)#
```

15.3.3.5 Rendezvous Points (RPs)

The switch supports dynamic RPs, static RPs, and anycast RPs.

Configuring Static RPs

The `rp address` command configures a static RP, providing an option to override dynamic RPs.

Examples

- This command creates a static RP at 10.17.255.83 in the default VRF that maps to all multicast groups (224/4) and overrides dynamic RPs.

```
switch(config)#router pim sparse-mode
switch(config-router-pim-sparse)#ipv4
switch(config-router-pim-sparse-ipv4)#rp address 10.17.255.83 override
switch(config-router-pim-sparse-ipv4)#
```

- This command creates a static RP at 10.21.18.23 in the default VRF that maps to the multicast groups at 238.1.12.0/24.

```
switch(config)#router pim sparse-mode
switch(config-router-pim-sparse)#ipv4
switch(config-router-pim-sparse-ipv4)#rp address 10.21.18.23
238.1.12.0/24
switch(config-router-pim-sparse-ipv4)#
```

Configuring Dynamic RPs

Dynamic RP selection is implemented through a bootstrap router (BSR), which is a PIM router within the PIM domain that selects RPs from a list of candidates. A subset of PIM routers within the domain are configured as candidate bootstrap routers (C-BSRs). Through the exchange of bootstrap messages (BSMs), the C-BSRs elect the BSR, which then uses BSMs to inform all domain routers of its status.

The BSR holdtime defines the timeout period that an elected BSR remains valid after the receipt of a BSM and is also used in dynamic RP configuration. Holdtime is designated by the BSR router and communicated to other routers through BSMs.

Another subset of domain PIM routers are configured as candidate RPs (C-RPs). The BSR creates a set of qualifying RPs from the list of C-RPs, then distributes the group-to RP mapping set to all domain routers through BSMs. Each PIM router, after receiving this set, uses a standard algorithm defined in RFC 6226 to select one RP per multicast group.

The `candidate` command configures the switch as a candidate BSR router (C-BSR). Command parameters specify the switchs BSR address, the interval between BSM transmissions, and the switchs BSR priority rating. Priority ratings range from 0 to 255 with a default of 64. Higher numbers denote higher priority during BSR elections.

Example

These commands configure the switch as a BSR candidate in the default VRF, using the IP address assigned to VLAN interface 24 as its BSR address. The BSM transmission interval is set to 30 seconds and the priority is set to 192.

```
switch(config)#router pim bsr
switch(config-router-pim-bsr)#ipv4
switch(config-router-pim-bsr-ipv4)#candidate vlan 24 priority 192
interval 30
switch(config-router-pim-bsr-ipv4)#
```

The `holdtime` command specifies the value the switch inserts in the *holdtime* field of bootstrap messages (BSMs) that it sends. This value becomes the holdtime for the PIM domain if the switch is elected as the BSR.

Example

These commands specify 75 seconds as the value that the switch inserts into BSM holdtime fields in the default VRF.

```
switch(config)#router pim bsr
switch(config-router-pim-bsr)#ipv4
switch(config-router-pim-bsr-ipv4)#holdtime 75
switch(config-router-pim-bsr-ipv4)#
```

The `rp candidate` command configures the switch as a candidate rendezvous point (C-RP). The BSR selects a multicast groups dynamic RP set from the list of C-RPs. Command parameters specify the switchs RP address, C-RP advertisement interval, and priority rating. The priority rating is used by the BSR when selecting RPs. The C-RP advertisement interval specifies the period between successive C-RP advertisement message transmissions to the BSR.

Running-config may contain multiple `rp candidate` statements to support multiple multicast groups:

- All commands must specify the same interface. Issuing a command with an interface that differs from existing commands removes all existing commands from **running-config**.
- **Running-config** stores the interval setting in a separate statement that applies to all `rp candidate` statements. Commands that specify an interval that differs from the previously configured value place the new value in **running-config**. This new value applies to all `rp candidate` statements.

Example

These commands configure a switch as a candidate RP for the multicast group 235.1.1.0/24, with a priority of 48 and a RP advertisement interval of 45 seconds, in the default VRF.

```
switch(config)#router pim sparse-mode
switch(config-router-pim-sparse)#ipv4
switch(config-router-pim-sparse-ipv4)#rp candidate vlan 24 235.1.1.0/24
priority 48 interval 45
switch(config-router-pim-sparse-ipv4)#
```

By default, the switch transmits bootstrap router messages (BSMs) over all PIM-enabled interfaces. The `pim bsr ipv4 border` command prevents the switch from transmitting BSMs over the configuration mode interface.

Example

This command prevents the switch from sending BSMs from VLAN interface 10.

```
switch(config)#interface vlan 10
switch(config-if-Vl10)#pim bsr ipv4 border
switch(config-if-Vl10)#
```

Anycast Rendezvous Points

A PIM anycast rendezvous point (anycast RP) defines a single RP address that exists on multiple devices. An anycast-RP set consists of the routers configured with the same anycast-RP address. An anycast RP provides redundancy protection and load balancing. The anycast-RP set supports all multicast groups.

The `anycast-rp` command configures the switch as a member of an anycast-RP set and establishes a communication link with another member of the set.

Example

These commands configure a switch (IP address 10.1.1.14) into an anycast-RP set with an RP address of 10.17.255.2 in the default VRF. The anycast-RP set contains three other routers, located at 10.1.2.14, 10.1.3.14, and 10.1.4.14. It sets the number of unacknowledged register messages it sends to each router at 15.

```
switch(config)#router pim sparse-mode
switch(config-router-pim-sparse)#ipv4
switch(config-router-pim-sparse-ipv4)#anycast-rp 10.17.255.2 10.1.1.14
register-count 15
switch(config-router-pim-sparse-ipv4)#anycast-rp 10.17.255.2 10.1.2.14
register-count 15
switch(config-router-pim-sparse-ipv4)#anycast-rp 10.17.255.2 10.1.3.14
register-count 15
switch(config-router-pim-sparse-ipv4)#anycast-rp 10.17.255.2 10.1.4.14
register-count 15
switch(config-router-pim-sparse-ipv4)#
```

15.3.3.6 Hello Messages

PIM-SM multicast routers send PIM router query messages (hello messages) to elect a designated router (DR) for each subnet. The DR then sends registration messages to the RP.

The `pim ipv4 hello interval` command specifies the transmission interval between PIM hello messages originating from the specified VLAN interface.

Example

This command configures 45 second intervals between hello messages originating from VLAN interface 4.

```
switch(config)#interface vlan 4
switch(config-if-Vl4)#pim ipv4 hello interval 45
switch(config-if-Vl4)#
```

15.3.3.7 Hello Hold Time

A PIM interface maintains a hold timer for each of its neighbors. The timer is reset whenever a hello message is received from the neighbor. When the timer expires, the neighbor is considered DOWN. The PIM interface can advertise its neighbor to use a higher hold time by modifying the hello interval, or by setting a higher hello count using the `pim ipv4 hello count` command. The hello count specifies how many hello messages can be missed before the neighbor is considered down; the hold time is therefore the hello interval multiplied by the hello count.

Examples

- This command configures the PIM hold time on VLAN 2925 to 225 seconds (7.5 times the 30-second hello interval).

```
switch(config)#interface vlan2925
switch(config-if-Vl2925)#pim ipv4 hello count 7.5
```

- This command displays the hold time on VLAN 2925.

```
switch#show ip pim interface vlan2925 details
Interface Vlan2925 address is 1.0.1.1
Vif number is 0
PIM: enabled
PIM version: 2, mode: sparse
PIM neighbor count: 0
PIM Effective DR: 1.0.1.1 (this system)
PIM Effective DR Priority: 1
PIM Effective Propagation Delay: 500 milliseconds
PIM Effective Override Interval: 2500 milliseconds
PIM Effective Tracking Support: disabled
PIM Hello Interval: 30 seconds
PIM Hello Hold Time: 225 seconds <===== New Hold Time ( = 7.5 * 30 )
PIM Hello Priority: 1 seconds
PIM Hello Lan Delay: 500 milliseconds
PIM Assert Override Interval: 3 seconds
switch#
```

15.3.3.8 Designated Router Election

PIM-SM uses these criteria for electing a designated router (DR):

- If at least one router does not advertise a DR priority value, then PIM-SM elects the router with the highest IP address as the DR.
- If all routers advertise a DR priority value, then PIM-SM elects the router with the highest DR priority value as the DR.

The `group-expiry-timer` command sets the DR priority value that the switch advertises. If **running-config** does not contain a `pim ipv4 dr-priority` statement, the switch does not advertise a DR priority value.

Examples

- This command configures a DR priority value of 15 on VLAN interface 4.

```
switch(config-if-Vl4)#pim ipv4 dr-priority 15
switch(config-if-Vl4)#
```

- This command removes the DR priority from VLAN interface 4.

```
switch(config-if-Vl4)#no pim ipv4 dr-priority
switch(config-if-Vl4)#
```

15.3.3.9 Designated Forwarder Election

Designated forwarders (DFs) are elected based on route metrics in the unicast routing table; there are no configuration options that affect the selection of DFs.

15.3.3.10 Join-Prune Messages

Join/prune messages are sent by the PIM-SM designated router (DR) or the Bidir-PIM designated forwarder (DF) toward the rendezvous point (RP). These messages inform other PIM routers about clients that want to become receivers (join) or stop being receivers (prune) for the groups.

The `pim ipv4 join-prune interval` command specifies the period between join/prune messages that the switch originates from the specified VLAN interface and sends to the upstream RPF neighbor.

Example

This command configures 75 second intervals between join/prune messages originating from VLAN interface 4.

```
switch(config-if-Vl4)#pim ipv4 join-prune interval 75
switch(config-if-Vl4)#
```

15.3.3.11 Legacy PIM Configuration in Global Configuration Mode

Earlier versions of the EOS managed all non-interface-specific PIM configuration from Global Configuration Mode. Legacy configurations retain these global commands in **running-config** after upgrading to a newer version of the EOS, and the configurations are applied unchanged to the default VRF. PIM configuration commands entered in Global Configuration Mode which can be applied to either PIM-SM or Bidir-PIM will be applied to PIM-SM. If any commands are added to **running-config** using the new configuration modes, all legacy commands will be converted to the new modal commands and applied in the default VRF.



Note: Multicast configuration commands issued in Global Configuration Mode are now deprecated, and Arista recommends configuring all multicast parameters in the appropriate configuration mode (i.e., Router-Multicast Configuration, Router-PIM Sparse-mode Configuration, Router-PIM Bidirectional Configuration, Router-PIM BSR Configuration, or Router-MSDP Configuration).

15.3.3.12 Configuring PIM in a Non-default VRF

For PIM to function in a non-default VRF, the VRF must be created and configured for multicast traffic, and routed ports must be added to the VRF. Once this is accomplished, configure VRF-global PIM parameters by using the `vrf` command within a PIM configuration mode to place the switch in a PIM VRF configuration submode.

Interface-specific PIM parameters are configured in the interface-configuration mode for VRF-member interface.

Legacy multicast routing commands issued in Global Configuration Mode are applied to the default VRF, but are now deprecated and are available only for backward compatibility. If any PIM commands are issued in the new format, all legacy commands remaining in *running-config* will be replaced with their updated equivalents and applied to the default VRF.

15.3.3.12.1 Preparing the VRF for PIM Configuration

The following steps prepare a non-default VRF to use PIM:

1. Enable unicast routing in the default VRF.

```
switch(config)#ip routing vrf default
```

2. Create the non-default VRF if not already created.

```
switch(config)#vrf instance purple
```

3. Enable enable unicast routing on the new VRF.

```
switch(config-vrf-purple)#exit  
switch(config)#ip routing vrf purple
```

4. Add participating routed ports to the new VRF.

```
switch(config)#interface ethernet 9/2-9/4  
switch(config-if-Et9/2-4)#no switchport  
switch(config-if-Et9/2-4)#vrf purple  
switch(config-if-Et9/2-4)#exit
```

5. Enable multicast routing on the new VRF.

```
switch(config)#router multicast  
switch(config-router-multicast)#vrf purple  
switch(config-router-multicast-vrf-purple)#ipv4  
switch(config-router-multicast-vrf-purple-ipv4)#routing
```

15.3.3.12.2 Configuring Global PIM Parameters in a Non-default VRF

Global PIM parameters for non-default VRFs are configured in the VRF submode of the appropriate PIM configuration mode.

Example

These commands configure a switch as a candidate RP for the multicast group 235.1.1.0/24, with a priority of 48 and a RP advertisement interval of 45 seconds, in VRF purple.

```
switch(config)#router pim sparse-mode  
switch(config-router-pim-sparse)#vrf purple  
switch(config-router-pim-sparse)#ipv4  
switch(config-router-pim-sparse-vrf-purple-ipv4)#rp candidate vlan 24  
235.1.1.0/24 priority 48 interval 45  
switch(config-router-pim-sparse-vrf-purple-ipv4)#
```

15.3.3.12.3 Configuring Interface-specific PIM Parameters in a Non-default VRF

Interface-specific PIM parameters for member interfaces of a non-default VRF are configured just as they are for the default VRF: in the interface-configuration mode for the interface.

15.3.4 Multicast Example

This section provides an example network that implements multicast (PIM-SM) in the default VRF and includes the required commands.

15.3.4.1 Diagram

Figure 64: Multicast Example displays the multicast network example. The network contains four routers. Multicast routing (PIM-SM) is enabled on two switches. One switch has its IGMP Snooping Querier enabled.

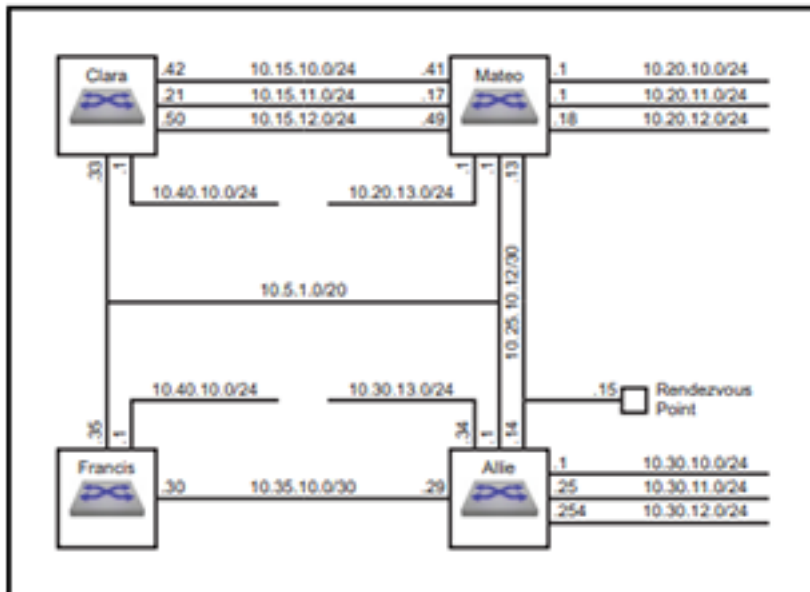

Figure 64: Multicast Example

The example multicast network implements these multicast parameters:

Rendezvous Point Address: 10.25.10.15

Switch Clara

- IGMP Snooping: disabled
- Subnet Summary:
 - 10.40.10.0/24: VLAN 11
 - 10.15.10.0/24: VLAN 12
 - 10.15.11.0/24: VLAN 13
 - 10.15.12.0/24: VLAN 14
 - 10.5.1.0/20: VLAN 10

Switch Mateo

- IGMP Snooping: disabled

-
- Subnet Summary:
 - 10.20.13.0/24: VLAN 18
 - 10.20.10.0/24: VLAN 15
 - 10.20.11.0/24: VLAN 16
 - 10.20.12.0/24: VLAN 17
 - 10.15.10.0/24: VLAN 12
 - 10.15.11.0/24: VLAN 13
 - 10.15.12.0/24: VLAN 14
 - 10.25.10.12/30: VLAN 19
 - 10.5.1.0/20: VLAN 10

Switch Allie

- IGMP Snooping: enabled
- Multicast Routing: enabled
- Querier: enabled
- Rendezvous Point Address: 10.25.10.15
- MFIB activity polling interval: 5 second
- Subnet Summary:
 - 10.30.13.0/24: VLAN 23
 - 10.30.10.0/24: VLAN 20 PIM-SM enabled
 - 10.30.11.0/24: VLAN 21 PIM-SM enabled
 - 10.30.12.0/24: VLAN 22
 - 10.25.10.12/30: VLAN 19
 - 10.35.10.0/30: VLAN 24 PIM-SM enabled
 - 10.5.1.0/20: VLAN 10 PIM-SM enabled

Switch Francis

- IGMP Snooping: enabled
- Multicast Routing: enabled
- Subnet Summary:
 - 10.40.10.0/24: VLAN 25 PIM-SM enabled
 - 10.35.10.0/30: VLAN 24 PIM-SM enabled
 - 10.5.1.0/20: VLAN 10

15.3.4.2 Example

This example configures PIM-SM.

1. Configure the interface addresses

a. Router Clara interfaces

```
Clara(config)#interface vlan 11
Clara(config-if-vl11)#ip address 10.40.10.1/24
Clara(config-if-vl11)#interface vlan 12
Clara(config-if-vl12)#ip address 10.15.10.42/24
Clara(config-if-vl12)#interface vlan 13
Clara(config-if-vl13)#ip address 10.15.11.21/24
Clara(config-if-vl13)#interface vlan 14
Clara(config-if-vl14)#ip address 10.15.12.50/24
Clara(config-if-vl14)#interface vlan 10
Clara(config-if-vl10)#ip address 10.5.1.33/20
```



```
Clara(config-if-vl10)#router ospf 1
Clara(config-router-ospf)#redistribute static
```

b. Router Mateo interfaces

```
Mateo(config)#interface vlan 18
Mateo(config-if-vl18)#ip address 10.20.13.1/24
Mateo(config-if-vl18)#interface vlan 15
Mateo(config-if-vl15)#ip address 10.20.10.1/24
Mateo(config-if-vl15)#interface vlan 16
Mateo(config-if-vl16)#ip address 10.20.11.1/24
Mateo(config-if-vl16)#interface vlan 17
Mateo(config-if-vl17)#ip address 10.20.12.16/24
Mateo(config-if-vl17)#interface vlan 12
Mateo(config-if-vl12)#ip address 10.15.10.41/24
Mateo(config-if-vl12)#interface vlan 13
Mateo(config-if-vl13)#ip address 10.15.11.17/24
Mateo(config-if-vl13)#interface vlan 14
Mateo(config-if-vl14)#ip address 10.15.12.49/24
Mateo(config-if-vl14)#interface vlan 19
Mateo(config-if-vl19)#ip address 10.25.10.13/30
Mateo(config-if-vl19)#interface vlan 10
Mateo(config-if-vl10)#ip address 10.5.1.1/20
Mateo(config-if-vl10)#router ospf 1
Mateo(config-router-ospf)#redistribute static
```

c. Router Allie interfaces

```
Allie(config)#interface vlan 23
Allie(config-if-vl23)#ip address 10.30.13.34/24
Allie(config-if-vl23)#interface vlan 20
Allie(config-if-vl20)#ip address 10.30.10.1/24
Allie(config-if-vl20)#interface vlan 21
Allie(config-if-vl21)#ip address 10.30.11.25/24
Allie(config-if-vl21)#interface vlan 22
Allie(config-if-vl22)#ip address 10.30.12.254/24
Allie(config-if-vl22)#interface vlan 19
Allie(config-if-vl19)#ip address 10.25.10.14/30
Allie(config-if-vl19)#interface vlan 24
Allie(config-if-vl24)#ip address 10.35.10.29/30
Allie(config-if-vl24)#interface vlan 10
Allie(config-if-vl10)#ip address 10.5.1.1/20
Allie(config-if-vl10)#router ospf 1
Allie(config-router-ospf)#redistribute static
```

d. Router Francis interfaces

```
Francis(config)#interface vlan 25
Francis(config-if-vl25)#ip address 10.40.10.1/24
Francis(config-if-vl25)#interface vlan 24
Francis(config-if-vl24)#ip address 10.35.10.30/24
Francis(config-if-vl24)#interface vlan 10
Francis(config-if-vl10)#ip address 10.5.1.35/24
Francis(config-if-vl10)#router ospf 1
Francis(config-router-ospf)#redistribute static
```

2. Configure the interface multicast parameters

a. Router Allie interfaces

```
Allie(config-router-ospf)#interface vlan 20
Allie(config-if-vl20)#pim ipv4 sparse-mode
```

```
Allie(config-if-vl20)#interface vlan 21
Allie(config-if-vl21)#pim ipv4 sparse-mode
Allie(config-if-vl21)#interface vlan 24
Allie(config-if-vl24)#pim ipv4 sparse-mode
Allie(config-if-vl24)#interface vlan 10
Allie(config-if-vl10)#pim ipv4 sparse-mode
```

b. Router Francis interfaces

```
Francis(config-router-ospf)#interface vlan 25
Francis(config-if-vl25)#pim ipv4 sparse-mode
Francis(config-if-vl25)#interface vlan 24
Francis(config-if-vl24)#pim ipv4 sparse-mode
```

3. Configure the router multicast parameters

a. Router Clara parameters

```
Clara(config-router-ospf)#exit
Clara(config)#no ip igmp snooping
```

b. Router Mateo router

```
Mateo(config-router-ospf)#exit
Mateo(config)#no ip igmp snooping
```

c. Router Allie router

```
Allie(config-if-vl10)#exit
Allie(config)#router multicast
Allie(config-router-multicast)#ipv4
Allie(config-router-multicast-ipv4)#routing
Allie(config-router-multicast-ipv4)#activity polling-interval 5
Allie(config-router-multicast-ipv4)#router pim sparse-mode
Allie(config-router-pim-sparse)#ipv4
Allie(config-router-pim-sparse-ipv4)#rp address 10.25.10.15
```

d. Router Francis router

```
Francis(config-if-vl24)#exit
Francis(config)#router multicast
Francis(config-router-multicast)#ipv4
Francis(config-router-multicast-ipv4)#routing
Francis(config-router-multicast-ipv4)#router pim sparse-mode
Francis(config-router-pim-sparse)#ipv4
Francis(config-router-pim-sparse-ipv4)#rp address 10.25.10.15
```

15.3.5 PIM Commands

PIM Configuration Commands (Global)

- `anycast-rp`
- `candidate`
- `fast-reroute`
- `group-expiry-timer`
- `holdtime`
- `ip pim dr-notify-delay`
- `log neighbors`
- `register local-interface`
- `router pim bidirectional`
- `router pim bsr`
- `router pim sparse-mode`
- `rp address`
- `rp allow`
- `rp candidate`
- `rp-candidate advertisement-filter`
- `rp hash algorithm modulo`
- `sg-expiry-timer`
- `spt threshold`
- `ssm range`

PIM Configuration Commands (Interface)

- `ipv4`
- `pim bsr ipv4 border`
- `pim ipv4 bidirectional`
- `pim ipv4 border-router`
- `pim ipv4 dr-priority`
- `pim ipv4 hello count`
- `pim ipv4 hello interval`
- `pim ipv4 join-prune count`
- `pim ipv4 join-prune interval`
- `pim ipv4 neighbor-filter`
- `pim ipv4 sparse-mode`
- `pim ipv6 sparse-mode`
- `sptimeout`

PIM Display Commands

- `show ip pim bsr`
- `show ip pim config-sanity`
- `show ip pim interface`
- `show ip pim neighbor`
- `show ip pim protocol counters`
- `show ip pim register-source`
- `show ip pim rp`
- `show ip pim rp-candidate`
- `show ip pim rp-hash`

-
- `show ip pim upstream joins`

15.3.5.1 anycast-rp

The **anycast-rp** command configures the switch as a member of an anycast-RP set and establishes a communication link with another member of the set.

When the command is issued in Router-Multicast IPv4 Configuration Mode it applies to the default VRF; to use this command in a non-default VRF, issue it in Router-Multicast VRF IPv4 Configuration Mode.

The **no anycast-rp** and **default anycast-rp** commands remove the corresponding **anycast-rp** command from **running-config**. When the **no** and **default** commands do not include a peer address, all commands for the specified RP address are removed.

Command Mode

Router-Multicast IPv4 Configuration

Router-Multicast VRF IPv4 Configuration

Command Syntax

```
anycast-rp rp_addr peer_addr [REGISTER]
```

```
no anycast-rp rp_addr [peer_addr]
```

```
default anycast-rp rp_addr [peer_addr]
```

Parameters

- **rp_addr** Rendezvous point IP address (dotted decimal notation).
- **peer_addr** IP address of another anycast-RP set member (dotted decimal notation). Note, the peer-addr for a local anycast RP must be a /32 address configured under a loopback interface. To enable anycast RP on the router, each RP requires one local peer address. Use the `show ip pim anycast-rp [vrf <vrfName>]` command to verify the configured local and remote peers.
- **REGISTER** Number of unacknowledged register messages the switch sends to the peer router.
 - *<no parameter>* register count is set to default value of 10.
 - **register-count r_num** where *r_num* is an integer that ranges from 1 to 4294967295.
 - **register-count infinity**

Example

These commands configure a switch (IP address 10.1.1.14) into an anycast-RP set with an RP address of 10.17.255.2 in the default VRF. The anycast-RP set contains three other routers, located at 10.1.2.14, 10.1.3.14, and 10.1.4.14. It sets the number of unacknowledged register messages it sends to each router at 15.

```
switch(config)#router pim sparse-mode
switch(config-router-pim-sparse)#ipv4
switch(config-router-pim-sparse-ipv4)#anycast-rp 10.17.255.2 10.1.1.14
register-count 15
switch(config-router-pim-sparse-ipv4)#anycast-rp 10.17.255.2 10.1.2.14
register-count 15
switch(config-router-pim-sparse-ipv4)#anycast-rp 10.17.255.2 10.1.3.14
register-count 15
switch(config-router-pim-sparse-ipv4)#anycast-rp 10.17.255.2 10.1.4.14
register-count 15
switch(config-router-pim-sparse-ipv4)#
```

15.3.5.2 candidate

The **candidate** command configures the switch as a candidate BSR router (C-BSR). A BSR is a PIM router within the PIM domain through which dynamic RP selection is implemented. The BSR selects RPs from a list of candidate RPs and exchange bootstrap messages (BSM) with all routers in the domain. The BSR is elected from one of the C-BSRs through an exchange of BSMs.

A subset of PIM routers within the domain are configured as candidate bootstrap routers (C-BSRs). Through the exchange of bootstrap messages (BSMs), the C-BSRs elect the BSR, which then uses BSMs to inform all domain routers of its status.

Command parameters specify the switchs BSR address, the interval between BSM transmissions, the length of the hash mask, and the priority assigned to the switch when electing a BSR.

Entering an **candidate** command replaces any previously configured **candidate** command. If the new command does not specify a priority, hash mask length, or interval, the previously configured values persist in **running-config**.

When the command is issued in Router-PIM BSR IPv4 Configuration Mode it applies to the default VRF; to use this command in a non-default VRF, issue it in Router-PIM BSR VRF IPv4 Configuration Mode for the appropriate VRF.

The **no candidate** and **default candidate** commands remove the corresponding **candidate** commands from **running-config**. The **no** and **default** commands restore the priority, hash mask length, and interval parameters to their default values.

Command Mode

Router-PIM BSR IPv4 Configuration

Router-PIM BSR VRF IPv4 Configuration

Command Syntax

```
candidate INTERFACE [HASHMASK_LENGTH][INTERVAL_PERIOD][PRIORITY_NUM]
no candidate [priority][interval]
default candidate [priority][interval]
```

Parameters

- **INTERFACE** Switch uses IP address of specified interface as its BSR address. Options include:
 - **ethernet** *e_num* Ethernet interface specified by *e_num*.
 - **loopback** *l_num* Loopback interface specified by *l_num*.
 - **management** *m_num* Management interface specified by *m_num*.
 - **port-channel** *p_num* Port-Channel Interface specified by *p_num*.
 - **vlan** *v_num* VLAN interface specified by *v_num*.
- **HASHMASK_LENGTH** Length (in bits) of the hash mask.
 - *<no parameter>* hash mask remains unchanged from previous setting.
 - **hashmask** *<0 - 32>* hash mask length (in bits). Default value is 30.
- **INTERVAL_PERIOD** Period between the transmission of BSMs (seconds). Default value is 60.
 - *<no parameter>* interval remains unchanged from previous setting.
 - **interval** *<10 - 536870906>* transmission interval in seconds.
- **PRIORITY_NUM** BSR election priority rating. Larger numbers denote higher priority. Default value is 64.
 - *<no parameter>* priority remains unchanged from previous setting.
 - **priority** *<0 - 255>* priority rating.

Example

These commands configure the switch as a BSR candidate in the default VRF, using the IP address assigned to VLAN interface 24 as its BSR address. The BSM transmission interval is set to 30 seconds and the priority is set to 192.

```
switch(config)#router pim bsr  
switch(config-router-pim-bsr)#ipv4  
switch(config-router-pim-bsr-ipv4)#candidate vlan 24 priority 192  
interval 30  
switch(config-router-pim-bsr-ipv4)#
```

15.3.5.3 fast-reroute

The **fast-reroute** command enables Multicast only Fast Re-Route (MoFRR) to minimize traffic loss in a network when a link or node failure occurs. Traffic loss is minimized by allowing the traffic to flow from the secondary path upon the failure of the primary path.

The **no fast-reroute** and **default fast-reroute** commands disable MoFRR by removing the corresponding fast-reroute command from **running-config**.

Command Mode

Router-PIM BSR IPv4 Configuration

Router-PIM BSR VRF IPv4 Configuration

Command Syntax

```
fast-reroute acl_name
```

```
no fast-reroute acl_name
```

```
default fast-reroute acl_name
```

Parameters

acl_name standard access list name.

Examples

- These commands enable fast reroute for ACL `acl2` in the default VRF under the IPv4 configuration.

```
switch(config)#router pim sparse-mode
switch(config-router-pim-sparse)#ipv4
switch(config-router-pim-sparse-ipv4)#fast-reroute acl2
switch(config-router-pim-sparse-ipv4)#
```

- These commands enable fast reroute for ACL `acl2` in VRF `red` under the IPv4 configuration.

```
switch(config)#router pim sparse-mode
switch(config-router-pim-sparse)#vrf red
switch(config-router-pim-sparse-vrf-red)#ipv4
switch(config-router-pim-sparse-vrf-red-ipv4)#fast-reroute acl2
switch(config-router-pim-sparse-vrf-red-ipv4)#
```

15.3.5.4 group-expiry-timer

The **group-expiry-timer** command sets the group-expiry-timer in seconds after which a group with no activity gets deleted from the PIM rendezvous point (RP) tree.

When the command is configured in Global Configuration Mode, the configuration is applied globally on the switch. To apply the configuration only in Bidir-PIM mode, the command is configured in Router-PIM Bidirectional Configuration Mode. To apply the configuration for a specific VRF, the command is configured in the VRF sub-mode of the Router-PIM Bidirectional Configuration Mode. Use the [pim ipv4 bidirectional](#) command to enter Router-PIM Bidirectional Configuration Mode.

The **no group-expiry-timer** and **default group-expiry-timer** applies the system default configuration and removes the corresponding **group-expiry-timer** command from *running-config*.

Command Mode

Router-PIM Bidirectional IPv4 Configuration

Router-PIM Bidirectional VRF IPv4 Configuration

Command Syntax

```
group-expiry-timer value
```

```
no group-expiry-timer value
```

```
default group-expiry-timer value
```

Parameter

value specifies the time in seconds after which a group with no activity expires from the PIM RP. Values range from 1 to 210. There is no default value.

Examples

- This command configures PIM expiry-timer of 40 seconds in PIM-bidirectional sub-mode.

```
switch(config)#router pim bidirectional
switch(config-router-pim-bidir)#ipv4
switch(config-router-pim-bidir-ipv4)#group-expiry-timer 40
```

- This command configures PIM expiry-timer of 120 seconds for VRF v1.

```
switch(config)#router pim bidirectional
switch(config-router-pim-bidir)#vrf v1
switch(config-router-pim-bidir-vrf-v1)#ipv4
switch(config-router-pim-bidir-vrf-v1-ipv4)#group-expiry-timer 120
```

15.3.5.5 holdtime

The **holdtime** command specifies the value the switch inserts in the **holdtime** parameter field in bootstrap messages (BSM) that it sends. The BSR holdtime defines the timeout period that an elected BSR remains valid after the receipt of a BSM and is also used in dynamic RP configuration. BSR holdtime is designated by the BSR router and communicated to other routers through BSMs.

When the command is issued in Router-PIM BSR IPv4 Configuration Mode it applies to the default VRF; to use this command in a non-default VRF, issue it in Router-PIM BSR VRF IPv4 Configuration Mode for the appropriate VRF.

The **no holdtime** and **default holdtime** commands restore the default holdtime parameter field insertion value of 130 seconds by removing the **holdtime** statement from **running-config**.

Command Mode

Router-PIM BSR IPv4 Configuration

Router-PIM BSR VRF IPv4 Configuration

Command Syntax

```
holdtime period
```

```
no holdtime
```

```
default holdtime
```

Parameters

period BSR holdtime (seconds). Value ranges from 12 to 1073741823 (1.073 billion seconds, approximately 34 years). Default is 130.

Example

These commands specify 75 seconds as the value that the switch inserts into BSM holdtime fields in the default VRF.

```
switch(config) #router pim bsr  
switch(config-router-pim-bsr) #ipv4  
switch(config-router-pim-bsr-ipv4) #holdtime 75  
switch(config-router-pim-bsr-ipv4) #
```

15.3.5.6 ip pim dr-notify-delay

The **ip pim dr-notify-delay** command configures the designated routers (DR) notification delay time. The command is more effective when all PIM routers on the LAN segment have PIM DR priority that is greater than 1.

When the command is issued in Router-Multicast Configuration Mode it applies to the default VRF; to use this command in a non-default VRF, issue it in Router-Multicast VRF Configuration Mode.

The **no ip pim dr-notify-delay** command removes the previously configured DR notification delay time.

Command Mode

Global Configuration

Router-Multicast VRF Configuration

Command Syntax

```
ip pim dr-notify-delay notify_delay_time  
no ip pim dr-notify-delay
```

Parameters

notify_delay_time The PIM-designated router notify delay time in seconds. The value ranges from -32767 to 32768.

Guidelines

The notification delay time is configured with a positive or negative value. The timer influences DR election timing when a router with the highest DR priority on a LAN segment is reloaded. In an MLAG configuration, the notification delay time begins shortly after the MLAG reload delay expires (before which the PIM hello messages are sent with a priority of 1). In a non-MLAG configuration, the notification delay time begins as soon as the PIM is configured first on the interface.

Positive values for notify delay time cause the device to send PIM hello messages with a priority of 1 until the time the notify delay time expires. During this time, DR responsibilities of the device will continue according to configured DR priority. Negative values configured for the notification delay time will not modify the priority sent in PIM hello messages, but the device will not perform any DR responsibility until the notify delay time expires. Positive values are used to avoid loss of multicast packets, but they may create a few duplicate packets from multiple PIM routers forwarding traffic for the same S,G. Negative values are used to avoid duplicate packets, but they may cause packet loss when there are no PIM routers forwarding traffic for an S,G.

Example

These commands configure a DR notification delay time of 2 seconds.

```
switch(config) #router multicast  
switch(config-router-multicast) #ip pim dr-notify-delay 2  
switch(config-router-multicast) #
```

15.3.5.7 ipv4

The **ipv4** command places the switch in the IPv4 submode for the PIM configuration mode in which it is entered.

Command Mode

Router Multicast Configuration

Router-PIM Bidirectional Configuration

Router-PIM BSR Configuration

Router-PIM Sparse-mode Configuration

Command Syntax

```
ipv4
```

Examples

- These commands place the switch in Router Multicast IPv4 Configuration Mode.

```
switch(config)#router multicast  
switch(config-router-multicast)#ipv4  
switch(config-router-multicast-ipv4)#
```

- These commands place the switch in Router-PIM Bidirectional IPv4 Configuration Mode.

```
switch(config)#router pim bidirectional  
switch(config-router-pim-bidir)#ipv4  
switch(config-router-pim-bidir-ipv4)#
```

- These commands place the switch in Router-PIM BSR IPv4 Configuration Mode.

```
switch(config)#router pim bsr  
switch(config-router-pim-bsr)#ipv4  
switch(config-router-pim-bsr-ipv4)#
```

- These commands place the switch in Router-PIM Sparse-mode IPv4 Configuration Mode.

```
switch(config)#router pim sparse-mode  
switch(config-router-pim-sparse)#ipv4  
switch(config-router-pim-sparse-ipv4)#
```

15.3.5.8 log neighbors

The **log neighbors** command configures the switch to generate a log message when a neighbor entry is added or removed from the PIM Neighbor table. This function is enabled by default.

The **no log neighbors** command disables log message generation based on changes to the PIM Neighbor table; this command is stored in the **running-config**. The **log neighbors** and **default log neighbors** commands restore the default setting of generating log messages by deleting the **no log neighbors** statement from **running-config**.

Command Mode

Router-PIM Sparse-mode IPv4 Configuration

Router-PIM Sparse-mode VRF IPv4 Configuration

Router-PIM Bidirectional IPv4 Configuration

Router-PIM Bidirectional VRF IPv4 Configuration

Command Syntax

```
log neighbors
```

```
no log neighbors
```

```
default log neighbors
```

Examples

- These commands configure the switch to stop generating log messages based on PIM Neighbor table changes in the default VRF.

```
switch(config)#router pim sparse-mode
switch(config-router-pim-sparse)#ipv4
switch(config-router-pim-sparse-ipv4)#no log neighbors
switch(config-router-pim-sparse-ipv4)#
```

- These commands configure the switch to generate log messages when a neighbor entry is added or removed from the PIM Neighbor table in the default VRF.

```
switch(config)#router pim sparse-mode
switch(config-router-pim-sparse)#ipv4
switch(config-router-pim-sparse-ipv4)#log neighbors
switch(config-router-pim-sparse-ipv4)#
```

15.3.5.9 pim bsr ipv4 border

The **pim bsr ipv4 border** command prevents the switch from sending bootstrap router messages (BSMs) over the configuration mode interface. By default, BSMs are transmitted over all PIM-enabled interfaces.

The **no pim bsr ipv4 border** and **default pim bsr ipv4 border** commands restore the transmission of BSMs over the configuration mode interface by removing the corresponding **pim bsr ipv4 border** statement from *running-config*.

Command Mode

Interface-Ethernet Configuration

Interface-Port-Channel Configuration

Interface-VLAN Configuration

Command Syntax

```
pim bsr ipv4 border
```

```
no pim bsr ipv4 border
```

```
default pim bsr ipv4 border
```

Example

This command prevents the switch from sending BSMs from VLAN interface 10.

```
switch(config)#interface vlan 10  
switch(config-if-Vl10)#pim bsr ipv4 border  
switch(config-if-Vl10)#
```

15.3.5.10 pim ipv4 bidirectional

The **pim ipv4 bidirectional** command enables PIM bidirectional and IGMP (router mode) on the configuration mode interface.

 **Note:** PIM and multicast border router (MBR) must be mutually exclusive on an interface. If the interface is configured as an MBR, do not enable PIM on the interface.

The **no pim ipv4 bidirectional**, **no pim ipv4**, **default pim ipv4 bidirectional**, and **default pim ipv4** commands restore the default PIM and IGMP (router mode) settings of **disabled** on the configuration mode interface by removing the **pim ipv4 bidirectional** statement from **running-config**.

Command Mode

Interface-Ethernet Configuration

Interface-Port-Channel Configuration

Interface-VLAN Configuration

Command Syntax

```
pim ipv4 bidirectional
no pim ipv4
no pim ipv4 bidirectional
default pim ipv4
default pim ipv4 bidirectional
```

Example

This command enables PIM bidirectional on VLAN 4 interface.

```
switch(config)#interface vlan 4
switch(config-if-Vl4)#pim ipv4 bidirectional
switch(config-if-Vl4)#
```

15.3.5.11 pim ipv4 border-router

The **pim ipv4 border-router** command configures the configuration mode interface as a PIM multicast border router (MBR). A PIM MBR interface allows multicast traffic from sources that are outside of the PIM domain.

This command does not control the transmission or reception of PIM protocol packets by the interface.

Sources learned through an MBR interface are treated as local sources (directly connected to the switch). The border-bit is set in all PIM register messages sent for these sources.

 **Note:** Configuration as an MBR and configuration in PIM sparse mode must be mutually exclusive. Ensure that PIM sparse mode is not configured by issuing the **pim ipv4 sparse-mode** command on the interface before issuing this command.

The **no pim ipv4 border-router** and **default pim ipv4 border-router** commands removes the PIM MBR configuration for the configuration mode interface by removing the corresponding **pim ipv4 border-router** statement from *running-config*.

Command Mode

Interface-Ethernet Configuration

Interface-Port-Channel Configuration

Interface-VLAN Configuration

Command Syntax

```
pim ipv4 border-router
no pim ipv4 border-router
default pim ipv4 border-router
```

Example

These commands configure VLAN interface 200 as a PIM MBR, then display its status.

```
switch(config)#interface vlan 200
switch(config-if-VL200)#ip address 10.44.2.1/24
switch(config-if-VL200)#no pim ipv4 sparse-mode
switch(config-if-VL200)#pim ipv4 border-router
switch(config-if-VL200)#show active
interface Vlan200
ip address 10.44.2.1/24
pim ipv4 border-router
switch(config-if-VL200)#exit
switch(config)#show ip pim interface
AddressInterfaceModeNeighborHello DRDR
AddressPktsQedPktsDropped
CountIntvl Pri
10.44.2.1Vlan200mbr030110.44.2.100
switch(config)#
```

15.3.5.12 pim ipv4 dr-priority

PIM-SM uses these criteria for electing a designated router (DR):

- If at least one router does not advertise a DR priority value, then PIM-SM elects the router with the highest IP address as the DR.
- If all routers advertise a DR priority value, then PIM-SM elects the router with the highest DR priority value as the DR.

The **pim ipv4 dr-priority** command sets the DR priority value that the configuration mode interface advertises. By default, the interface does not advertise a DR priority value.

The **no pim ipv4 dr-priority** and **default pim ipv4 dr-priority** commands force the use of IP addresses to elect the designated router by removing the corresponding **pim ipv4 dr-priority** statement from *running-config*.

Command Mode

Interface-Ethernet Configuration

Interface-Port-Channel Configuration

Interface-VLAN Configuration

Command Syntax

```
pim ipv4 dr-priority level  
no pim ipv4 dr-priority [level]  
default pim ipv4 dr-priority [level]
```

Parameters

level DR selection priority rating. Value ranges from 0 to 4294967295.

Examples

- This command configures the dr-priority value of 15 on VLAN interface 4.

```
switch(config)#interface vlan 4  
switch(config-if-Vl4)#pim ipv4 dr-priority 15  
switch(config-if-Vl4)#
```

- This command force the use of IP addresses to elect the designated router.

```
switch(config-if-Vl4)#no pim ipv4 dr-priority  
switch(config-if-Vl4)#
```

15.3.5.13 pim ipv4 hello count

The **pim ipv4 hello count** command sets the PIM hello count for the interface being configured. PIM hold time is calculated by multiplying the configured hello interval by the hello count, ensuring that the PIM neighbor stays up for the specified time after which the neighbor expires.

The **no pim ipv4 hello count** command removes the corresponding **pim ipv4 hello count** command from *running-config*.

Command Mode

Interface-Ethernet Configuration

Interface-Port-Channel Configuration

Interface-VLAN Configuration

Command Syntax

```
pim ipv4 hello count[multiple]
```

```
no pim ipv4 hello count[multiple]
```

Parameters

multiple hello count multiplier. Value ranges from 1.5 to 65535. The hello hold time is the configured hello interval multiplied by the hello count.

Examples

- This command configures a hold time interval of 225 seconds on VLAN interface 2925 by multiplying the default 30-second hello interval by a hello count of 7.5.

```
switch(config)#interface vlan2925
switch(config-if-Vl2925)#pim ipv4 hello count 7.5
switch(config-if-Vl2925)#
```

- This show command displays the hold time and other configuration details on VLAN 2925.

```
switch#show ip pim interface vlan2925 details
Interface Vlan2925 address is 1.0.1.1
Vif number is 0
PIM: enabled
PIM version: 2, mode: sparse
PIM neighbor count: 0
PIM Effective DR: 1.0.1.1 (this system)
PIM Effective DR Priority: 1
PIM Effective Propagation Delay: 500 milliseconds
PIM Effective Override Interval: 2500 milliseconds
PIM Effective Tracking Support: disabled
PIM Hello Interval: 30 seconds
PIM Hello Hold Time: 225 seconds <===== New Hold Time (= 7.5 * 30)
PIM Hello Priority: 1 seconds
PIM Hello Lan Delay: 500 milliseconds
PIM Assert Override Interval: 3 seconds
mrtrl#
```

15.3.5.14 pim ipv4 hello interval

The **pim ipv4 hello interval** command specifies the transmission interval between PIM hello messages originating from the configuration mode interface.

The **no pim ipv4 hello interval** and **default pim ipv4 hello interval** commands restore the default query interval of 30 seconds for the configuration mode interface by removing the corresponding **pim ipv4 hello interval** command from *running-config*.

Command Mode

Interface-Ethernet Configuration

Interface-Port-Channel Configuration

Interface-VLAN Configuration

Command Syntax

```
pim ipv4 hello interval period
```

```
no pim ipv4 hello interval [period]
```

```
default pim ipv4 hello interval [period]
```

Parameters

period query interval (seconds). Value ranges from 1 to 1000000 (1 million). Default is 30.

Example

This command configures 45 second intervals between hello messages originating from VLAN interface 4.

```
switch(config)#interface vlan 4  
switch(config-if-Vl4)#pim ipv4 hello interval 45  
switch(config-if-Vl4)#
```

15.3.5.15 pim ipv4 join-prune count

The **pim ipv4 join-prune count** command configures the number of times a join or prune messages can be missed before the upstream neighbor time expires.

The join-prune interval multiplied by the count is considered as join or prune hold time (specified in seconds), which is used in the join or prune messages. It is recommended to use the default configuration for **pim ipv4 join-prune interval**, and modify the **pim ipv4 join-prune count** to increase the join or prune holdtime. Increasing the join-prune hold time delays the deletion of an S,G route on the upstream neighbor when join-prune messages are not sent to the neighbor. The maximum possible value for join or prune hold-time is 65535.

The **no pim ipv4 join-prune count** and **default pim ipv4 join-prune count** commands restore the default join or prune count for the configuration mode interface by removing the corresponding **pim ipv4 join-prune count** command from *running-config*.

Command Mode

Interface-Ethernet Configuration

Interface-VLAN Configuration

Command Syntax

```
pim ipv4 join-prune count count_value  
no pim ipv4 join-prune count count_value  
default pim ipv4 join-prune count count_value
```

Parameters

count_value The number of missed join or prune after which the route expires. Value ranges from 1.5 to 65535.

Example

This command indicates the number of times a join or prune messages can be missed.

```
switch(config)# interface Ethernet 1/1  
switch(config-if-Et1/1)# pim ipv4 join-prune count 5  
switch(config-if-Et1/1)#
```

15.3.5.16 pim ipv4 join-prune interval

The **pim ipv4 join-prune interval** command specifies the period between join or prune messages that the configuration mode interface originates and sends to the upstream RPF neighbor.

The **no pim ipv4 join-prune interval** and **default pim ipv4 join-prune interval** commands restores the default join or prune interval to 60 seconds for the configuration mode interface by removing the corresponding **pim ipv4 join-prune interval** command from *running-config*.

Command Mode

Interface-Ethernet Configuration

Interface-Port-Channel Configuration

Interface-VLAN Configuration

Command Syntax

```
pim ipv4 join-prune interval [period]  
no pim ipv4 join-prune interval [period]  
default pim ipv4 join-prune interval [period]
```

Parameters

period join or prune interval (seconds). Value ranges from 1 to 18724. Default is 60.

Example

This command configures 75-second intervals between join or prune messages originating from VLAN interface 4.

```
switch(config)#interface vlan 4  
switch(config-if-Vl4)#pim ipv4 join-prune interval 75  
switch(config-if-Vl4)#
```

15.3.5.17 pim ipv4 neighbor-filter

The **pim ipv4 neighbor-filter** command configures the configuration mode interface to filter PIM control packets on the basis of neighbor addresses listed in a specified standard access list.

The **no pim ipv4 neighbor-filter** and **default pim ipv4 neighbor-filter** commands disable the configuration mode interface from filtering PIM control packets by removing the corresponding **ip pim ipv4 neighbor-filter** command from *running-config*.

Command Mode

Interface-Ethernet Configuration

Interface-Port-Channel Configuration

Interface-VLAN Configuration

Command Syntax

```
pim ipv4 neighbor-filter access_list
no pim ipv4 neighbor-filter
default pim ipv4 neighbor-filter
```

Parameters

access_list name of the standard IP access list.

Example

This command configures the IP access list named *filter_1* to filter neighbor PIM control messages for *VLAN 4*.

```
switch(config)#ip access-list standard filter_1
switch(config-std-acl-filter_1)#permit 10.13.24.9/24
switch(config-std-acl-filter_1)#exit
switch(config)#interface vlan 4
switch(config-if-Vl4)#pim ipv4 neighbor-filter filter_1
switch(config-if-Vl4)#
```

15.3.5.18 pim ipv4 sparse-mode

The **pim ipv4 sparse-mode** command enables PIM IPv4 Sparse Mode (PIM-SM) and IGMP (router mode) on the configuration mode interface.

 **Note:** PIM and multicast border router (MBR) must be mutually exclusive on an interface. If the interface is configured as an MBR, do not enable PIM on the interface.

The **no pim ipv4 sparse-mode**, **no pim ipv4**, **default pim ipv4 sparse-mode**, and **default pim ipv4** commands restore the default PIM and IGMP (router mode) settings of **disabled** on the configuration mode interface by removing the **pim ipv4 sparse-mode** statement from **running-config**.

Command Mode

Interface-Ethernet Configuration

Interface-Port-Channel Configuration

Interface-VLAN Configuration

Command Syntax

```
pim ipv4 sparse-mode
no pim ipv4
no pim ipv4 sparse-mode
default pim ipv4
default pim ipv4 sparse-mode
```

Example

This command enables PIM sparse mode on *VLAN 4* interface.

```
switch(config)#interface vlan 4
switch(config-if-Vl4)#pim ipv4 sparse-mode
switch(config-if-Vl4)#
```

15.3.5.19 pim ipv6 sparse-mode

The **pim ipv6 sparse-mode** command enables PIM IPv6 Sparse Mode (PIM-SM) on the configuration mode interface.

 **Note:** PIM and multicast border router (MBR) must be mutually exclusive on an interface. If the interface is configured as an MBR, do not enable PIM on the interface.

The **no pim ipv6 sparse-mode**, **no pim ipv6**, **default pim ipv6 sparse-mode**, and **default pim ipv6** commands restore the default PIM settings of **disabled** on the configuration mode interface by removing the **pim ipv6 sparse-mode** command from the *running-config*.

Command Mode

Interface-Ethernet Configuration

Interface-Port-Channel Configuration

Interface-VLAN Configuration

Command Syntax

```
pim ipv6 sparse-mode
no pim ipv6
no pim ipv6 sparse-mode
default pim ipv6
default pim ipv6 sparse-mode
```

Example

This command enables IPv6 PIM sparse mode on *VLAN 8* interface.

```
switch(config)#interface vlan 8
switch(config-if-Vl8)#pim ipv6 sparse-mode
switch(config-if-Vl8)#
```

15.3.5.20 register local-interface

The **register local-interface** command programs the switch to fill the source field in all outbound PIM SM register packets with the IP address of a specified interface or the incoming interface of the group specified by the message. By default, the source field is filled with the IP address from the interface associated with the best route to the RP.

When the command is issued in Router-PIM Sparse-mode IPv4 ConfigurationMode, it applies to the default VRF; to use this command in a non-default VRF, issue it in Router-PIM Sparse-mode VRF IPv4 Configuration.

The **no register local-interface** and **default register local-interface** commands restore the default method of filling the register packet source field by removing the **ip register local-interface** statement from *running-config*.

Command Mode

Router-PIM Sparse-mode IPv4 Configuration

Router-PIM Sparse-mode VRF IPv4 Configuration

Command Syntax

```
register local-interface INT_NAME
```

```
no register local-interface
```

```
default register local-interface
```

Parameters

- **INT_NAME** Interface type and number. Values include:
 - **ethernet** *e_num* Ethernet interface specified by *e_num*.
 - **loopback** *l_num* Loopback interface specified by *l_num*.
 - **management** *m_num* Management interface specified by *m_num*.
 - **port-channel** *p_num* Port channel interface specified by *p_num*.
 - **vlan** *v_num* VLAN interface specified by *v_num*.

Example

These commands program the switch to fill the source field of outbound PIM SM register packets in the default VRF with the IPv4 address of loopback interface 2.

```
switch(config)#router pim sparse-mode
switch(config-router-pim-sparse)#ipv4
switch(config-router-pim-sparse-ipv4)#register local-interface loopback 2
switch(config-router-pim-sparse-ipv4)#
```

15.3.5.21 router pim bidirectional

The `router pim bidirectional` command places the switch in Router-PIM Bidirectional Configuration Mode.

Command Mode

Global Configuration

Command Syntax

```
router pim bidirectional
```

Example

This command places the switch in Router-PIM Bidirectional Configuration Mode.

```
switch(config)#router pim bidirectional  
switch(config-router-pim-bidir)#
```

15.3.5.22 router pim bsr

The `router pim bsr` command places the switch in Router-PIM BSR Configuration Mode.

Command Mode

Global Configuration

Command Syntax

```
router pim bsr
```

Example

This command places the switch in Router-PIM BSR Configuration Mode.

```
switch(config)#router pim bsr  
switch(config-router-pim-bsr)#
```

15.3.5.23 router pim sparse-mode

The `router pim sparse-mode` command places the switch in Router-PIM Sparse-Mode Configuration Mode.

Command Mode

Global Configuration

Command Syntax

```
router pim sparse-mode
```

Example

This command places the switch in Router-PIM Sparse-Mode Configuration Mode.

```
switch(config)#router pim sparse-mode  
switch(config-router-pim-sparse)#
```

15.3.5.24 rp address

The **rp address** command configures the address of a Protocol Independent Multicast (PIM) static rendezvous point (RP) for a specified multicast subnet. If the command does not specify a subnet, the static RP maps to all multicast groups (224/4). Dynamic RPs override static RPs unless the static RP is given priority by using the **override** option of this command.

Multicast groups use RPs to connect sources and receivers. A PIM domain requires that all routers have consistently configured RP addresses.

The switch uses multiple **rp address** commands to configure multiple RPs or to assign multiple subnets to an RP. When the address of a multicast group falls within multicast subnets configured by multiple **rp address** commands, the groups RP address is selected by comparing the commands multicast subnet size.

- Different size subnets: group uses command with the largest subnet.
- Same size subnets: group uses command as determined by hash algorithm.

When the command is issued in Router-Multicast Configuration Mode it applies to the default VRF; to use this command in a non-default VRF, issue it in Router-Multicast VRF Configuration Mode.

The **no rp address** and **default rp address** commands remove the corresponding **rp address** command from **running-config**.

Command Mode

Router-PIM Sparse-mode IPv4 Configuration

Router-PIM Sparse-mode VRF IPv4 Configuration

Command Syntax

```
rp address rp_addr [MULTICAST_SUBNET][HASHMASK_LENGTH][BSR_OVERRIDE]
[PRIORITY_NUM]
```

```
no rp address rp_addr [MULTICAST_SUBNET]
```

```
default rp address rp_addr [MULTICAST_SUBNET]
```

Parameters

- **rp_addr** Rendezvous point IP address (dotted decimal notation).
- **MULTICAST_SUBNET** Multicast IP address space (CIDR or address-mask).
 - *<no parameter>* Default multicast group IP address of 224/4.
 - **gp_addr** Multicast group IP address (CIDR or address-mask).
 - **access-list acl_name** Standard access control list that specifies the multicast group address.
 - **acl_name** Standard access control list that specifies the multicast group address.
- **HASHMASK_LENGTH** Length (in bits) of the hash mask.
 - *<no parameter>* hash mask remains unchanged from previous setting.
 - **hashmask <0 - 32>** hash mask length (in bits). Default value is 30.
- **BSR_OVERRIDE** Configures priority relative to dynamic RPs selected by BSR.
 - *<no parameter>* Dynamic RPs have priority over specified RP.
 - **override** RP has priority over dynamic RPs.
- **PRIORITY_NUM** BSR election priority rating. Larger numbers denote higher priority. Default value is 0.
 - *<no parameter>* priority remains unchanged from previous setting.
 - **priority <0 - 255>** priority rating.

Example

These commands configure 10.17.255.2 as a static RP for all multicast groups in the default VRF.

```
switch(config)#router pim sparse-mode  
switch(config-router-pim-sparse)#ipv4  
switch(config-router-pim-sparse-ipv4)#rp address 10.17.255.2  
switch(config-router-pim-sparse-ipv4)#
```

15.3.5.25 rp allow

The **rp allow** command accepts and allows PIM (*,G) join message with an RP address that is different from the configured RPs for that particular (*,G).

The **no rp allow** and **default rp allow** commands disable this behavior by removing the corresponding **rp allow** command from *running-config*.

Command Mode

Router-PIM Sparse-mode IPv4 Configuration

Router-PIM Sparse-mode VRF IPv4 Configuration

Command Syntax

```
rp allow
```

```
no rp allow
```

```
default rp allow
```

Examples

- These commands configure the switch to accept PIM (*,G) join messages in the default VRF that include RP addresses not configured on the switch for that (*,G) route.

```
switch(config-router-pim-sparse)# ipv4  
switch(config-router-pim-sparse-ipv4)# rp allow
```

- These commands configure the switch to accept PIM (*,G) join messages in VRF blue that include RP addresses not configured on the switch for that (*,G) route.

```
switch(config-router-pim-sparse)# vrf blue  
switch(config-router-pim-sparse-vrf-blue)# ipv4  
switch(config-router-pim-sparse-vrf-blue-ipv4)# rp allow
```

15.3.5.26 rp candidate

The **rp candidate** command configures the switch as a candidate rendezvous point (C-RP). The BSR selects a multicast groups dynamic RP set from the list of C-RPs in the PIM domain. The command specifies the interface (used to derive the RP address), C-RP advertisement interval, and priority rating. The BSR selects the RP set by comparing C-RP priority ratings. The C-RP advertisement interval specifies the period between successive C-RP advertisement message transmissions to the BSR.

Running-config supports multiple multicast groups through multiple **rp candidate** statements:

- All commands must specify the same interface. Issuing a command with an interface that differs from existing commands removes all existing commands from **running-config**.
- **Running-config** stores the **interval** setting in a separate statement that applies to all **rp candidate** statements. When a command specifies an interval that differs from the previously configured value, the new value replaces the old value and applies to all configured **rp candidate** statements. The default **interval** value is 60 seconds.

When the command is issued in Router-Multicast Configuration Mode it applies to the default VRF; to use this command in a non-default VRF, issue it in Router-Multicast VRF Configuration Mode.

The **no rp candidate** and **default rp candidate** commands remove **rp candidate** from **running-config** for the specified group. When these commands do not specify a multicast group, all **rp candidate** statements are removed from **running-config**.

The **no rp candidate interval** and **default rp candidate interval** commands restore the interval setting to the default value of 60 seconds. The **no rp candidate priority** and **default rp candidate priority** commands restore the priority setting to the default value of 0.

Command Mode

Router-PIM Sparse-mode IPv4 Configuration

Router-PIM Sparse-mode VRF IPv4 Configuration

Router-PIM Bidirectional IPv4 Configuration

Router-PIM Bidirectional VRF IPv4 Configuration

Command Syntax

 **Note:** The **INTERFACE** parameter is always listed first. All other parameters can be placed in any order.

```
rp candidate INTERFACE [GROUP_ADDR][PRIORITY_NUM][INTERVAL_PERIOD]
```

```
no rp candidate [INTERFACE][GROUP_ADDR]
```

```
no rp candidate [INTERFACE] interval
```

```
no rp candidate [INTERFACE] priority
```

```
default rp candidate [INTERFACE][GROUP_ADDR]
```

```
default rp candidate [INTERFACE] interval
```

```
default rp candidate [INTERFACE] priority
```

Parameters

- **INTERFACE** Switch uses IP address of specified interface as its C-RP address. Options include:
 - **ethernet** *e_num* Ethernet interface specified by *e_num*.
 - **loopback** *l_num* Loopback interface specified by *l_num*.
 - **management** *m_num* Management interface specified by *m_num*.
 - **port-channel** *p_num* Port-Channel Interface specified by *p_num*.
 - **vlan** *v_num* VLAN interface specified by *v_num*.
 - **vxlan** *vx_num* VXLAN interface specified by *vx_num*.
- **GROUP_ADDR** address of multicast group for which candidate is configured. Options include:
 - *<no parameter>* default multicast group (224.0.0.0/4).
 - **net_addr** multicast IPv4 subnet address (CIDR or address mask).
 - **access-list** *acl_name* standard access control list that specifies the multicast group address.
- **PRIORITY_NUM** RP selection priority rating. Smaller numbers denote higher priority.
 - *<no parameter>* priority rating is set to the default value of 0.
 - **priority** *<0 - 255>* priority rating.
- **INTERVAL_PERIOD** Period between consecutive RP-advertisement message transmissions (seconds). Value also applies to previously configured **rp candidate** statements.
 - *<no parameter>* interval remains unchanged from previous setting.
 - **interval** *<10 - 16383>* transmission interval.

Example

These commands configure a switch as a candidate RP for the multicast group 235.1.1.0/24 with a priority of 48 and an RP advertisement interval of 45 seconds in the default VRF. The switch advertises the IP address assigned to VLAN 24 as its RP address.

```
switch(config)#router pim sparse-mode
switch(config-router-pim-sparse)#ipv4
switch(config-router-pim-sparse-ipv4)#rp candidate vlan 24 235.1.1.0/24
priority 48 interval 45
switch(config-router-pim-sparse-ipv4)#
```

15.3.5.27 rp hash algorithm modulo

The **rp hash algorithm modulo** command configures the load-balancing scheme across available rendezvous points (RP).

The configuration results in a round robin-based load balancing across available RPs, achieved by module operation of the destination group address with the number of RPs available.

The **no rp hash algorithm modulo** and **default rp hash algorithm modulo** commands result in the default load-balancing scheme which is to use a hash function to get a group-RP mapping.

Command Mode

Router-PIM Sparse-mode IPv4 Configuration

Router-PIM Sparse-mode VRF IPv4 Configuration

Router-PIM Sparse-mode IPv6 Configuration

Router-PIM Sparse-mode VRF IPv6 Configuration

Router-PIM Bidirectional VRF IPv4 Configuration

Command Syntax

```
rp hash algorithm modulo
no rp hash algorithm modulo
default rp hash algorithm modulo
```

Examples

- These commands configures the hash algorithm module for a VRF named blue in the Router-PIM sparse-mode IPv4 configuration mode.

```
switch(config)#router pim sparse-mode
switch(config-router-pim-sparse)#ipv4
switch(config-router-pim-sparse-ipv4)#vrf red
switch(config-router-pim-sparse-vrf-red-ipv4)#rp hash algorithm modulo
```

- These commands configures the hash algorithm module for a VRF named blue in the Router-PIM bidirectional-mode VRF IPv4 configuration mode.

```
switch(config)#router pim bidirectional
switch(config-router-pim-bidir)#ipv4
switch(config-router-pim-bidir-ipv4)#vrf red
switch(config-router-pim-bidir-vrf-red-ipv4)#rp hash algorithm modulo
```

15.3.5.28 rp-candidate advertisement-filter

The **rp-candidate advertisement-filter** command filters the RP candidate advertisements from certain IP addresses. When **rp-candidate advertisement-filter** command is configured, PIM BSR filters RP candidate messages from ip-addresses matching the prefix list from the access-list that is configured.

The **no rp-candidate advertisement-filter** and **default rp-candidate advertisement-filter** commands removes **rp-candidate advertisement-filter** from **running-config** for the specified group.

Command Mode

Router-PIM BSR IPv4 Configuration

Router-PIM BSR VRF IPv4 Configuration

Command Syntax

```
rp-candidate advertisement-filter access-list access-list_name
```

```
no rp-candidate advertisement-filter access-list access-list_name
```

```
default rp-candidate advertisement-filter access-list access-list_name
```

Parameters

access-list_name Standard access control list that specifies the multicast group address.

Example

These commands configure the switch as a candidate RP advertisement filter for the multicast group in the non-default VRF.

```
switch(config-router-pim-bsr) #ipv4  
switch(config-router-pim-bsr-ipv4) #rp-candidate advertisement-filter  
  access-list test1  
switch(config-router-pim-bsr-vrf-red-ipv4) #rp-candidate advertisement-  
  filter access-list test2
```

15.3.5.29 sg-expiry-timer

The **sg-expiry-timer** command configures the (S, G) expiry timer interval for PIM-SM (S, G) multicast routes. The command does not apply to (*, G) mroutes.

When the command is issued in Router-Multicast Configuration mode it applies to the default VRF; to use this command in a non-default VRF, issue it in Router-Multicast VRF Configuration mode.

The **no sg-expiry-timer** and **default sg-expiry-timer** commands restore the default setting of 210 seconds by removing the **sg-expiry-timer** statement from *running-config*.

Command Mode

Router-PIM Sparse-mode IPv4 Configuration

Router-PIM Sparse-mode VRF IPv4 Configuration

Command Syntax

```
sg-expiry-timer period
```

```
no sg-expiry-timer
```

```
default sg-expiry-timer
```

Parameters

period expiry timer interval (seconds). Value ranges from 120 to 65535 seconds. The default value is 210 seconds.

Example

These commands configure 150 seconds as the (S,G) expiry timer interval in the default VRF.

```
switch(config)#router pim sparse-mode
switch(config-router-pim-sparse)#ipv4
switch(config-router-pim-sparse-ipv4)#sg-expiry-timer 150
switch(config-router-pim-sparse-ipv4)#
```

15.3.5.30 show ip pim bsr

The `show ip pim bsr` command displays the switch's bootstrap router (BSR) information.

Command Mode

EXEC

Command Syntax

```
show ip pim bsr [GROUP_FILTER]
```

Parameters

- **GROUP_FILTER** specifies groups for which command displays information.
 - **<no parameter>** Displays data for all groups.
 - **net_addr** Displays message for specified group address. (CIDR or address mask).

Example

This command configures the switch's BSR information.

```
switch>show ip pim bsr
PIMv2 Bootstrap information
This system is the Bootstrap Router (BSR)
BSR address: 10.1.1.1
Uptime:      00:14:42, BSR Priority: 0, Hash mask length: 30
Next bootstrap message in 00:00:05
```

15.3.5.31 show ip pim config-sanity

The **show ip pim config-sanity** command displays diagnostic information about the switch's PIM configuration.

Command Mode

EXEC

Command Syntax

```
show ip pim config-sanity
```

Example

This command displays PIM configuration diagnostic information.

```
switch>show ip pim config-sanity  
DISCLAIMER: Below are only hints of potential PIM misconfiguration.  
They do not necessary imply that there is a real problem.  
  
The interfaces with PIM which are down: V14  
  
switch>
```

15.3.5.32 show ip pim interface

The **show ip pim interface** command displays information about interfaces configured for PIM.

Command Mode

EXEC

Command Syntax

```
show ip pim interface [INT_NAME][INFO_LEVEL]
```

Parameters

- **INT_NAME** Interface type and number. Values include
 - *<no parameter>* displays information for all interfaces.
 - **ethernet** *e_num* Ethernet interface specified by *e_num*.
 - **port-channel** *p_num* Port-Channel Interface specified by *p_num*.
 - **vlan** *v_num* VLAN interface specified by *v_num*.
 - **vxlan** *vx_num* VXLAN interface specified by *vx_num*.
- **INFO_LEVEL** specifies level of information detail provided by the command.
 - *<no parameter>* table of basic configuration information.
 - **detail** list of complete configuration information.

Examples

- This command displays information about all interfaces on which PIM is enabled.

```
switch>show ip pim interface
Address InterfaceModeNeighbor Hello DR DR Address PktsQed
PktsDropped Count Intvl Pri
10.17.254.30 Vlan3910 sparse1 30 1 10.17.254.30
0 0
10.17.254.162 Vlan3925 sparse2 30 1
10.17.254.163 0 0
10.17.254.106 Vlan3912 sparse1 30 1
10.17.254.106 0 0
10.17.254.137 Ethernet12 sparse1 30 1
10.17.254.138 0 0
switch>
```

- This command displays detailed PIM information for VLAN 26 interface.

```
switch>show ip pim interface vlan 26 detail
Interface address is 172.17.26.1
Vif number is 1
PIM: enabled
PIM version: 2, mode: sparse
PIM DR: 172.17.26.1 (this system)
PIM DR Priority: 1
PIM neighbor count: 0
PIM Hello Interval: 30 seconds
PIM Hello Priority: 1
PIM Hello Lan Delay: 500 milliseconds
PIM Hello Override Interval: 2500 milliseconds
PIM Hello Lan Prune Delay in use
PIM Hello Generation ID: 0x4a05aa0
PIM Hello Generation ID is not required
PIM Triggered Hello Delay: 5 seconds
PIM Join-Prune Interval: 60 seconds
PIM State-Refresh processing: disabled
PIM State-Refresh Interval: unknown seconds
PIM Graft Retry Interval: unknown seconds
```

```
PIM domain border: disabled  
switch>
```

15.3.5.33 show ip pim neighbor

The **show ip pim neighbor** command displays information about Protocol Independent Multicast (PIM) neighbors discovered by hello messages.

Command Mode

EXEC

Command Syntax

```
show ip pim neighbor [INT_NAME][BFD_DATA]
```

Parameters

- **INT_NAME** Interface type and number. Values include
 - *<no parameter>* displays information for all interfaces.
 - **ethernet** *e_num* Ethernet interface specified by *e_num*.
 - **loopback** *l_num* Loopback interface specified by *l_num*.
 - **management** *m_num* Management interface specified by *m_num*.
 - **port-channel** *p_num* Port-Channel Interface specified by *p_num*.
 - **vlan** *v_num* VLAN interface specified by *v_num*.
 - **vxlan** *vx_num* VXLAN interface specified by *vx_num*.
- **BFD_DATA** Specifies inclusion of BFD data.
 - *<no parameter>* BFD data is not displayed.
 - **bfd** BFD data is displayed.

Examples

- This command displays information about neighbor PIM routers.

```
switch>show ip pim neighbor
PIM Neighbor Table
Neighbor Address  Interface      Uptime      Expires      Mode
10.17.255.2      Vlan2028      21d22h      00:01:31     sparse
switch>
```

- This command displays information about neighbor PIM routers and the status of BFD.

```
switch>show ip pim neighbor bfd
PIM Neighbor Table
Flags: U - BFD is enabled and is UP
       I - BFD is enabled and is INIT
       D - BFD is enabled and is DOWN
       N - Not running BFD

Neighbor Address  Interface      Uptime      Expires      ModeFlags
10.17.255.2      Vlan2028      21d22h      00:01:31     sparseU
switch>
```

15.3.5.34 show ip pim protocol counters

The **show ip pim protocol** command displays statistics about Protocol Independent Multicast (PIM) control messages sent and received by the switch.

Command Mode

EXEC

Command Syntax

```
show ip pim protocol counters[INT_NAME]
```

Parameters

- **INT_NAME** Interface type and number. Values include
 - *<no parameter>* displays information for all interfaces.
 - **ethernet** *e_num* Ethernet interface specified by *e_num*.
 - **loopback** *l_num* Loopback interface specified by *l_num*.
 - **management** *m_num* Management interface specified by *m_num*.
 - **port-channel** *p_num* Port-Channel Interface specified by *p_num*.
 - **vlan** *v_num* VLAN interface specified by *v_num*.
 - **vxlan** *vx_num* VXLAN interface specified by *vx_num*.

Example

This command displays statistics about inbound and outbound PIM control messages.

```
switch>show ip pim protocol counters
PIM Control Counters

```

	Received	Sent	Invalid
Assert	0	37	0
Bootstrap Router	0	0	0
CRP Advertisement	0	0	0
Graft	0	0	0
Graft Ack	0	0	0
Hello	63168	126355	0
J/P	275714	143958	0
Join	0	0	0
Prune	0	0	0
Register	0	13643	0
Register Stop	11839	0	0
State Refresh	0	0	0

```
switch>
```

15.3.5.35 show ip pim register-source

The **show ip pim register-source** command displays the name of the interface from where the switch derives the IP address that it uses to fill the source field in all outbound PIM SM register packets. The [register local-interface](#) command specifies this interface.

By default, the source field is filled with the IP address from the interface associated with the best route to the RP. The **show ip pim register-source** command does not return a value when the source field is filled with the default value.

Command Mode

EXEC

Command Syntax

```
show ip pim register-source
```

Example

This command displays the register-source interface.

```
switch>show ip pim register-source
Ethernet22
switch>
```

15.3.5.36 show ip pim rp

The **show ip pim rp** command displays the status and multicast group of each cached rendezvous point (RP).

Command Mode

EXEC

Command Syntax

```
show ip pim rp
```

Example

This command displays the cached RPs.

```
switch>show ip pim rp  
show ip pim rp  
The PIM RP Set  
Group: 224.0.0.0/4  
RP: 10.1.2.3  
Uptime: 00:05:12, Expires: never, Priority: 1 Override: 1
```

15.3.5.37 show ip pim rp-candidate

The **show ip pim rp-candidate** command displays the rendezvous point (RP) that is used for a specified multicast group.

Command Mode

EXEC

Command Syntax

```
show ip pim rp-candidate
```

Example

This command displays the switch's candidate-RP information.

```
switch>show ip pim rp-candidate  
Candidate RP information  
Candidate RP Address: 10.0.12.2  
CRP Holdtime: 150 seconds  
Group 224.2.0.0/16 Priority 2
```

15.3.5.38 show ip pim rp-hash

The **show ip pim rp-hash** displays the group to RP-hash mapping for the specified group and the list of qualifying candidate RPs.

Command Mode

EXEC

Command Syntax

```
show ip pim rp-hash ipv4_addr[INFO_LEVEL]
```

Parameters

- ***ipv4_addr*** multicast group IPv4 address.
- **INFO_LEVEL** specifies level of information detail provided by the command.
 - *<no parameter>* RP-hash map and list of candidate RPs.
 - **detail** includes data about the selected RP.

Example

This command displays the RP that the switch uses for multicast group 224.1.0.0.

```
switch>show ip pim rp-hash 224.1.0.0  
RP 10.1.2.3
```

15.3.5.39 show ip pim upstream joins

The `show ip pim upstream joins` command displays the join messages that the switch is scheduled to send.

Command Mode

EXEC

Command Syntax

```
show ip pim upstream joins [JOIN_ADDRESSES] [NEIGHBOR_FILTER]
```

Parameters

- **JOIN_ADDRESSES** Filters messages by source and group addresses.
 - *<no parameter>* displays all join messages.
 - **source_addr** displays all join messages for specified source group IPv4 address.
 - **group_addr** displays all join messages for specified multicast IPv4 address.
 - **source_addr group_addr** displays join message with specified source and group addresses.
 - **group_addr source_addr** displays join message with specified group and source addresses.

group_addr must be a valid multicast IPv4 address.

- **NEIGHBOR_FILTER** specifies neighbors for which command provides data.
 - *<no parameter>* Displays messages for all neighbors.
 - **neighbor neighbor_addr** Displays message for specified neighbor address.

Example

This command displays the list of join messages the switch is scheduled to send. The example only displays the first two messages.

```
switch>show ip pim upstream joins

----- show ip pim upstream joins -----

Neighbor address: 10.1.1.1
Via interface: 10.1.1.2
Next message in 1 seconds
  Group: 10.10.10.3
    Joins:
      10.25.1.1/32 SPT
    Prunes:
      No prunes included
Neighbor address: 10.1.1.6
Via interface: 10.1.1.5
Next message in 1 seconds
  Group: 10.14.1.69
    Joins:
      10.105.14.3/32 SPT
    Prunes:
      No prunes included
switch>
```

15.3.5.40 spt threshold

The **spt threshold** command configures shortest path tree (SPT) threshold actions for IPv4 multicast groups. To specify the threshold action for multicast groups that match a specified access control list (ACL), use the **match list** option. When the command is issued without this option, it is applied throughout the configuration-mode VRF. Any ACL-based configuration overrides global configuration.

- When **running-config** does not list this command, the switch joins the SPT immediately after receiving the first PIM packet from a new source. The switch joins the SPT by sending PIM join message toward the source.
- When **running-config** lists this command with a value of infinity, the switch never joins the SPT.

The **no spt threshold** and **default spt threshold** commands remove the corresponding **spt threshold** command from **running-config**.

Command Mode

Router-PIM Sparse-mode IPv4 Configuration

Router-PIM Sparse-mode VRF IPv4 Configuration

Command Syntax

```
spt threshold {0 | infinity} [match list acl_name]
```

```
no spt threshold {0 | infinity} [match list acl_name]
```

```
default spt threshold {0 | infinity} [match list acl_name]
```

Parameters

- **0** The switch immediately joins the SPT. This is the default value.
- **infinity** The switch never joins the SPT.
- **acl_name** name of access control list. If no ACL is supplied, the configuration is applied to all multicast groups within the VRF which are not configured by an ACL.

Example

This command configures the switch in the default VRF to immediately join the SPT for multicast groups matched by the *ACL group-1*.

```
switch(config)#router pim sparse-mode
switch(config-router-pim-sparse)#ipv4
switch(config-router-pim-sparse-ipv4)#spt threshold 0 match list group-1
switch(config-router-pim-sparse-ipv4)#
```

15.3.5.41 ssm range

The **ssm range** command defines the source specific multicast (SSM) range of IP multicast addresses.

SSM is a multicast packet delivery method where only packets originating from a specific source address requested by a receiver are routed to that receiver. SSM explicitly excludes the use of (*,G) join for applicable multicast groups. Source-specific multicast differs from any-source multicast (ASM), where a receiver expresses interest in traffic to a multicast address, then receives traffic from all multicast sources sending to that address.

When the command is issued in Router-PIM Sparse-mode IPv4 Configuration Mode it applies to the default VRF; to use this command in a non-default VRF, issue it in Router-PIM Sparse-mode VRF IPv4 Configuration Mode.

The **no ssm range** and **default ssm range** commands remove the SSM IP multicast address range by deleting the **ssm range** statement from *running-config*.

Command Mode

Router-PIM Sparse-mode IPv4 Configuration

Router-PIM Sparse-mode VRF IPv4 Configuration

Command Syntax

```
ssm range {acl_name|standard}
```

```
no ssm range
```

```
default ssm range
```

Parameters

- **acl_name** sets the SSM range to address set specified by the standard ACL.
- **standard** sets the SSM range to 232/8.

Examples

- These commands configure the SSM address range to 232/8 in the default VRF.

```
switch(config)#router pim sparse-mode
switch(config-router-pim-sparse)#ipv4
switch(config-router-pim-sparse-ipv4)#ssm range standard
switch(config-router-pim-sparse-ipv4)#
```

- These commands configure the SSM address range to those permitted by the LIST_1 standard ACL in the default VRF. The ACL permits the subnet address range 233.0.0.0/24.

```
switch(config)#ip access-list standard LIST_1
switch(config-std-acl-LIST_1)#permit 233.0.0.0/24
switch(config-std-acl-LIST_1)#exit
switch(config)#router pim sparse-mode
switch(config-router-pim-sparse)#ipv4
switch(config-router-pim-sparse-ipv4)#ssm range LIST_1
switch(config-router-pim-sparse-ipv4)#
```

15.3.5.42 sptimeout

The `sptimeout` command configures the maximum span of active scope-zone.

The `no sptimeout` and `default sptimeout` commands delete the current scope zoned timeout configuration.

Command Modes

Router-PIM BSR IPv4 Configuration

Router-PIM BSR VRF IPv4 Configuration

Syntax

```
sptimeout timeout
```

```
no sptimeout
```

```
default sptimeout
```

Parameter

timeout Maximum span of active scope-zone in seconds. The value ranges from 120 to 4294967295. The default value is 1300.

Guideline

The scope zoned timeout must contain a minimum value of 10 times of configured holdtime; else the system displays a warning message.

Examples

- This command configures 600 seconds as the maximum of active scope-zone in router-pim bsr ipv4 configuration mode.

```
switch(config)#router pim bsr  
switch(config-router-pim-bsr)#ipv4  
switch(config-router-pim-bsr-ipv4)#sptimeout 600  
switch(config-router-pim-bsr-ipv4)#
```

- This command configures 2200 seconds as the maximum of active scope-zone in router-pim bsr vrf ipv4 configuration mode.

```
switch0(config)#router pim bsr  
switch(config-router-pim-bsr)#vrf vrf01  
switch(config-router-pim-bsr-vrf-vrf01)#ipv4  
switch(config-router-pim-bsr-vrf-vrf01-ipv4)#sptimeout 2200  
switch(config-router-pim-bsr-vrf-vrf01-ipv4)#
```

15.4 Multicast Source Discovery Protocol (MSDP)

Multicast Source Discovery Protocol (MSDP) describes a topology that connects multiple IPv4 Protocol Independent Multicast Sparse-Mode (PIM-SM) domains. Each PIM-SM domain uses its independent Rendezvous Point (RP) without depending on RPs in other domains.

These sections describe the Arista MSDP implementation.

- [MSDP Introduction](#)
- [MSDP Description](#)
- [MSDP Configuration](#)
- [MSDP Commands](#)

15.4.1 MSDP Introduction

Arista switches support these MSDP features:

- Basic MSDP speaker functions.
- MSDP peer configuration: description, connect-source interface, keepalive time, and hold time.
- ACL filtering of inbound and outbound Source-Active (SA) messages.
- Mesh groups.
- Display of peer status.
- Display of filtered SA messages received from MSDP peers.

These MSDP features are not supported:

- MSDP is not supported with Anycast-RP (RFC4610).
- IP packet encapsulation.

15.4.2 MSDP Description

The Multicast Source Discovery Protocol (MSDP) defines a topology connecting Protocol Independent Multicast sparse mode (PIM-SM) domains.

MSDP provides inter-domain access to multicast sources in all domains by enabling all rendezvous points (RPs) to discover multicast sources outside of their domains. RPs also use MSDP to announce sources that are sending to a multicast group.

- [MSDP Speakers](#)
- [Network Configuration](#)
- [MSDP Exchange Processes](#)

15.4.2.1 MSDP Speakers

An MSDP speaker is a router in a PIM-SM domain that has MSDP peering sessions with MSDP peers in other domains. An MSDP peering session is a TCP connection through which peers exchange MSDP control information. An MSDP peer is a router that is connected to the speaker through a peering session.

PIM uses MSDP to register a local source with remote domain RPs through Source Active (SA) messages, which originate at the local domain's RP. Receivers in remote PIM-SM domains depend only on RPs in their domains to learn of multicast data sources in other domains. Multicast data is subsequently delivered from a source to receivers in different domains through a PIM-SM source tree.

[MSDP Speaker Configuration](#) describes the process of configuring MSDP speakers.

15.4.2.2 Network Configuration

The TCP connections between RPs are defined either through an underlying unicast routing table or by configuring a default MSDP peer. A typical MSDP configuration utilizes a BGP specified routing table. SA messages are MSDP control messages that peers exchange during peering sessions.

- [Source Active Messages](#)
- [Reverse Path Forwarding](#)
- [Default MSDP Peers](#)

15.4.2.2.1 Source Active Messages

A Source Active (SA) message is a message that an RP creates and sends to MSDP peers when it learns of a new multicast source through a PIM register message. RPs that intend to originate or receive SA messages must establish MSDP peering with other RPs, either directly or through intermediate MSDP peers. An RP that is not a DR on a shared network should only originate SAs in

response to register messages it receives from the DR. It does not originate SA's for directly connected sources in its domain.

SA messages contain the following fields:

- Source address of the data source.
- Group address that receives data sent by the source.
- IP address of the RP.

The SA Cache is the repository of SA messages received by the MSDP speaker. The switch always stores received SA messages. [Managing the SA Cache](#) describes procedures that limit the size of the SA cache and options for displaying the cache.

15.4.2.2.2 Reverse Path Forwarding

Reverse path forwarding (RPF) is a multicast packet transport technique that ensures loop-free packet forwarding by using a router's unicast routing table. Traffic forwarding is based on source addresses instead of destination addresses. RPF is implemented as defined in RFC 3618.

Packet forwarding is based on the packet's unicast reverse path. An RPF router prevents network loops by only forwarding a packet when it enters through the interface holding its source routing entry.

When a multicast packet enters a router's interface, the router checks the reverse path of the packet by examining the list of networks that are reachable through the input interface. If the list contains a matching routing entry for the multicast packet's source IP address, the packet is forwarded to all other interfaces that are participants in the multicast group. Otherwise, the packet is dropped.

RPF requires that the unicast routing table is correct and converged. It also assumes that the use of symmetric forward and reverse paths between router and sender. RPF fails on uni-directional links.

[Displaying RPF Peers](#) describes commands that display RPF peers.

15.4.2.2.3 Default MSDP Peers

The default peer is the MSDP peer from which the MSDP speaker accepts SA messages. If there is only one MSDP peer, all of its SA messages will be accepted. When multiple default peers are configured the switch uses the first default peer to appear in *running-config*. Default MSDP peers invalidate the use of RPF over unicast routing tables.

Each default peer may be associated with a prefix list. The prefix list specifies the RPs from where the speaker accepts SA messages. When *running-config* contains multiple default peers with prefix lists, an SA is accepted from the first default peer in *running-config* whose prefix list contains the RP in the SA. The speaker accepts all remaining SAs from the first default peer that is not associated with a prefix list.

[Configuring the Default Peer](#) describes commands that configure default peers.

15.4.2.3 MSDP Exchange Processes

- [Control Information Exchange](#)
- [MSDP Data Exchange](#)

15.4.2.3.1 Control Information Exchange

An RP originates an SA message when a source registers with the RP to send data to a multicast group. RPs periodically originate SA messages while its registered sources send data to maintain messages in SA caches of its MSDP peers. RPs that have no registered sources periodically send keepalive messages to maintain TCP connections with its peers.

MSDP defines the following timers that specify the transmission frequency of control messages:

- SA Advertisement Time: Duration of SA Advertisement intervals. An RP sends periodic SA messages to reference each registered source once per interval. SA advertisement time is 60 seconds.
- Keepalive Time: Period between the transmission of consecutive keepalive messages. Default keepalive time is 60 seconds. Minimum keepalive time is one second.
- Hold Timer: Period an MSDP speaker maintains a peer TCP connection after receiving an SA or keepalive message from the peer. Default time is 75 seconds. Minimum hold time is three seconds.

15.4.2.3.2 MSDP Data Exchange

This sequence describes the exchange of multicast data across PIM domains through MSDP:

1. When a source's first data packet is registered by the first hop router, the RP extracts the data from the packet and forwards it down the shared tree in the PIM domain.
2. The RP informs MSDP peers of the new source by sending a Source-Active (SA) message that identifies the source, the recipient group, and the RP's address or originator ID.
3. Upon receiving the SA message, an MSDP peer which is the RP for a multicast tree that includes members interested in the multicast sends a PIM join message (S,G) toward the data source.
4. The PIM designated router (DR) sends subsequent data encapsulated in PIM register messages directly to the remote domain's RP when the source becomes active.
5. If the source times out, this process repeats when the source goes active again.

15.4.3 MSDP Configuration

These sections describe the configuration of the switch as an MSDP speaker and the establishment of MSDP peering sessions.

- [MSDP Speaker Configuration](#)
- [Establishing MSDP Peers](#)
- [MSDP Network Configuration](#)
- [Managing the SA Cache](#)
- [Configuring MSDP in a non-default VRF](#)

MSDP requires that TCP port 639 (MSDP) is open on the control plane. The default control-plane ACL includes a permit rule that allows TCP packets access through the MSDP port.

15.4.3.1 MSDP Speaker Configuration

The switch is configured as an MSDP speaker when MSDP is enabled. MSDP is enabled by configuring an MSDP peer. [Configuring an MSDP Peer](#) describes the process of configuring an MSDP peer.

Source-Address (SA) messages that an MSDP speaker originates contain the speaker's rendezvous point (RP) address, as configured through PIM statements and processes. MSDP provides a method of assigning an originator ID address, which the speaker uses in place of its RP address when advertising SA messages. The [originator-id local-interface](#) command configures the switch to set the RP address to the specified interface's IP address in SA messages that it originates as an MSDP speaker.

Only RPs originate SA messages and only for its registered sources. RPs do not originate periodic SA messages for sources in other PIM domains. MSDP speakers that are not RPs do not originate periodic SA messages. Intermediate MSDP speakers forward SA messages received from other domains. Intermediate speakers are not required to be RPs.

Example

These commands configure the switch to use the IP address assigned to loopback interface 100 as the RP address in SA messages that it originates.

```
switch(config)#router msdp
switch (config-router-msdp)#originator-id local-interface loopback 100
switch (config-router-msdp)#
```

15.4.3.2 Establishing MSDP Peers

These sections describe MSDP Peer configuration tasks.

- [Configuring an MSDP Peer](#)
- [Mesh Groups](#)
- [Filtering SA Messages](#)
- [Keep-alive, Hold Time, and Reset Time Configuration](#)
- [Displaying Peer Information](#)

15.4.3.2.1 Configuring an MSDP Peer

The switch attempts to establish MSDP peering sessions through IP addresses configured as MSDP peers. The **peer** command configures a specified address as an MSDP peer and enables the switch as an MSDP speaker if no other peers are configured. The peering session with the device at the specified network is established over a TCP connection. The **local-interface** command can be used to specify an interface through which the switch establishes the TCP session. When no interface is specified, the connection is established through an interface determined by existing routing algorithms.

To display MSDP peer information, enter **show ip msdp peer** .

Example

These commands assign an IP address to *loopback interface 100*, then configure *10.4.4.12* as an MSDP peer and establish the TCP peer session through the loopback.

```
switch(config)#interface loopback 100
switch(config-if-Lo100)#ip address 10.6.8.6/24
switch(config-if-Lo100)#exit
switch(config)#router msdp
switch(config-router-msdp)#peer 10.4.4.12
switch(config-router-msdp-peer-10.4.4.12)#local-interface loopback 100
switch(config-router-msdp-peer-10.4.4.12)#show ip msdp peer
MSDP Peer 10.4.4.12
Connection status:
  State: Connect
  Resets: 0
  Connection Source: Loopback100 ( 10.6.8.6 )
SAs accepted:
switch(config-router-msdp-peer-10.4.4.12)#
```

To associate descriptive text with the specified MSDP peer, use the **description (MSDP)** command.

Example

These commands associate the string NORTH with the MSDP peer located at *10.4.4.12*.

```
switch(config)#router msdp
switch(config-router-msdp)#peer 10.4.4.12
switch(config-router-msdp-peer-10.4.4.12)#description NORTH
```

```
switch(config-router-msdp-peer-10.4.4.12)#show ip msdp peer
MSDP Peer 10.4.4.12
Description: NORTH
Connection status:
  State: Connect
  Resets: 0
  Connection Source: Loopback100 (10.6.8.6)
SAs accepted:
switch(config-router-msdp-peer-10.4.4.12)#
```

To close the peering session with the specified MSDP peer, use the [disabled \(MSDP\)](#) command. This terminates the TCP connection between the switch and the peer. The peer remains configured and the peer session can be resumed by removing the `disabled` command from *running-config*.

Examples

- This command closes the peering session with the MSDP peer at *10.4.4.12*.

```
switch(config)#router msdp
switch(config-router-msdp)#peer 10.4.4.12
switch(config-router-msdp-peer-10.4.4.12)#disabled
switch(config-router-msdp-peer-10.4.4.12)#show ip msdp peer
MSDP Peer 10.4.4.12
Description: NORTH
Connection status:
  State: Disbled
  Resets: 0
  Connection Source: Loopback100 ( 10.6.8.6 )
SAs accepted:
switch(config-router-msdp-peer-10.4.4.12)#
```

- This command reopens the peering session with the peer at *10.4.4.12*.

```
switch(config)#router msdp
switch(config-router-msdp)#peer 10.4.4.12
switch(config-router-msdp-peer-10.4.4.12)#no disabled
switch(config-router-msdp-peer-10.4.4.12)#show ip msdp peer
MSDP Peer 10.4.4.12
Description: NORTH
Connection status:
  State: Connect
  Resets: 0
  Connection Source: Loopback100 ( 10.6.8.6 )
SAs accepted:
switch(config-router-msdp-peer-10.4.4.12)#
```

15.4.3.2.2 Mesh Groups

Each node in a fully meshed network is directly connected to every other node in the network. Each peer in a fully meshed MSDP speaker network can be configured as a member of a mesh group. SA messages received from a mesh group peer are not forwarded to other members of the mesh group.

To configure an MSDP peer connection as an MSDP mesh group member, use the [mesh-group](#) command. An MSDP peer can be assigned to multiple mesh groups. Multiple peer connections can be assigned to the same mesh group.



Note: Peer-specific mesh-group configuration is performed in Router MSDP Peer Configuration or Router MSDP Peer VRF Configuration Mode. To remove all configured connections from a mesh group, use the `no mesh-group` command in Router MSDP Configuration Mode.

To display the mesh group membership of configured MSDP peers, enter `show msdp mesh-group`.

Example

These commands configure the MSDP peer connection to `10.1.1.14` as a member of the `AREA-1` mesh group, then displays members of mesh groups to which configured MSDP peers belong.

```
switch(config)#router msdp
switch(config-router-msdp)#peer 10.1.1.14
switch(config-router-msdp-peer-10.1.1.14)#mesh-group AREA-1
switch(config-router-msdp-peer-10.1.1.14)#show msdp mesh-group
Mesh Group: AREA-1
    10.1.1.14
Mesh Group: tier_01
    10.24.18.13
Mesh Group: tier_02
    10.26.101.18
switch(config-router-msdp-peer-10.1.1.14)#
```

15.4.3.2.3 Filtering SA Messages

The switch can filter Source-Active (SA) messages that it sends and receives with access control lists (ACLs). The commands accept standard and extended ACLs. The address field in standard ACLs filter an SA message on its group address.

The `sa-filter in` command assigns an ACL to filter inbound SA messages from the MSDP peer connection being configured. The switch only accepts SA messages from the peer that pass the ACL. The switch accepts all SA messages from peers that are not assigned an input ACL. A peer can be assigned only one input filter ACL. Subsequent `sa-filter in` commands for a peer replace the existing command.

The `sa-filter out` command assigns an ACL as a filter for outbound SA messages to the MSDP peer connection being configured. The switch only sends SA messages to the peer that pass the ACL. The switch sends all specified SA messages to peers not assigned an output filter ACL. A peer can be assigned only one output ACL. Subsequent `sa-filter out` commands for a peer replace the existing command.

Example

These commands assign the IP ACLs named `LIST-IN` as the inbound SA message filter and `LIST-OUT` as the outbound SA message filter for the MSDP peer connection to `10.4.4.12`.

```
switch(config)#router msdp
switch(config-router-msdp)#peer 10.4.4.12
switch(config-router-msdp-peer-10.4.4.12)#sa-filter in list LIST-IN
switch(config-router-msdp-peer-10.4.4.12)#sa-filter out list LIST-OUT
switch(config-router-msdp-peer-10.4.4.12)#show ip msdp peer
MSDP Peer 10.4.4.12
Connection status:
    State: Listen
    Connection Source: Loopback100 (10.6.8.6)
SA Filtering:
Input Filter: LIST-IN
Output Filter: LIST-OUT
switch(config-router-msdp-peer-10.4.4.12)#
```

15.4.3.2.4 Keep-alive, Hold Time, and Reset Time Configuration

To configure the MSDP keep-alive and hold time intervals for a specified MSDP peer connection, use the [keepalive \(MSDP\)](#) command.

- Keep-alive time interval is the period between the transmission of consecutive keep-alive messages. The default keep-alive time interval is 60 seconds.
- Hold time interval is the period the switch waits for a KEEPALIVE or UPDATE message before it disables peering. The default hold time interval is 75 seconds.

The hold time interval must be longer than or equal to the keep-alive time interval.

Example

- This command sets the keep-alive time to 45 seconds and the hold time to 80 seconds for the MSDP peer connection to 10.4.4.12.

```
switch(config)#router msdp
switch(config-router-msdp)#peer 10.4.4.12
switch(config-router-msdp-peer-10.4.4.12)#keepalive 45 80
switch(config-router-msdp-peer-10.4.4.12)#
```

To specify the period that the switch waits after an MSDP peering session is reset before attempting to reestablish the session, enter [connection retry interval](#). The default period is 30 seconds.

Example

- This command configures the switch to wait 45 seconds after an MSDP peering session is reset before attempting to reestablish the session.

```
switch(config)#router msdp
switch(config-router-msdp)#connection retry interval 45
switch(config-router-msdp)#
```

15.4.3.2.5 Displaying Peer Information

To display the MSDP peers, enter [show ip msdp summary](#). The command also displays the operational status of each peer and the number of messages from the peers in the SA cache.

Example

This command displays the configured peers, the status of the peers, and the number of SA messages received from those peers.

```
switch(config)#show ip msdp summary
MSDP Peer Status Summary
Peer Address      State   SA Count
192.168.3.18     Up      0
192.168.3.16     Up      0
192.168.3.37     Listen  0
192.168.3.46     Up      0
192.168.3.47     Up      0
```

15.4.3.3 MSDP Network Configuration

- [Displaying RPF Peers](#)
- [Configuring the Default Peer](#)

15.4.3.3.1 Displaying RPF Peers

The switch uses the unicast routing table to define TCP connections between RPs by selecting the next hop peer toward the originating RP of an SA message as the reverse path forwarding (RPF) peer. The switch forwards SA messages that it receives from the RPF peer to all other MSDP peers. The switch rejects SA messages that it receives from non-RPF peers.

To display MSDP information for the peer from which the switch accepts SA messages for a specified rendezvous point (RP), enter `show msdp rpf-peer`.

Example

This command displays MSDP information for the peer from which the switch accepts SA messages for the RP at 10.5.29.4.

```
switch(config)#show msdp rpf-peer 10.5.29.4
Rpf Peer is 10.5.29.4 for RP 10.5.29.4
```

15.4.3.3.2 Configuring the Default Peer

The default peer is the MSDP peer from which the MSDP speaker is configured to accept all SA messages. A default peer may be associated with a prefix list. The prefix list specifies the RPs from where the speaker accepts SA messages.

The switch can designate multiple default peers:

- Switch defines one peer: A default peer statement is not required; the switch accepts SA traffic from the configured peer.
- Switch defines one default peer (no prefix list): The switch accepts all SA messages from only the default peer.
- Switch defines multiple default peers (no prefix lists): The switch accepts all SA messages from only the first default peer listed in `running-config`. Other listed default peers take effect only if the peer named in the first default-peer statement is not accessible.
- First default-peer statement includes a prefix list: The switch accepts all SA messages from the default peer whose originating RP is covered in the prefix list. The disposition of SA messages originating from other RPs is determined by subsequent `default-peer` statements.

To configure the specified MSDP peer connection as a default peer on the switch, use the `default-peer` command. The default peer address must be a previously configured MSDP peer (configured using the `peer` command).

Example

These commands configure an MSDP default peer.

```
switch(config)#router msdp
switch(config-router-msdp)#peer 10.5.2.2
switch(config-router-msdp-peer-10.5.2.2)#default-peer
switch(config-router-msdp-peer-10.5.2.2)#
```

15.4.3.4 Managing the SA Cache

The switch stores Source Active (SA) messages after forwarding the information. This allows new group members to learn about the source before the next SA message is received. The caching action is not configurable and cannot be disabled.

SA messages have an expiration period of 90 seconds and remain in the SA cache until they expire. A peer's SA limit defines the number of SA messages the switch stores from the peer. The switch does not store SA messages from a peer whose SA limit is reached until its cached messages start expiring.

- [Limiting SA Cache Contents](#)
- [Displaying SA Cache Contents](#)
- [Verifying Consistency Between the SA Cache and the Routing Table](#)

15.4.3.4.1 Limiting SA Cache Contents

To configure the maximum number of SA messages from a specified MSDP peer that the switch stores in the SA cache, use the [sa-limit](#) command. The default limit of SA messages that the switch can store from a specified peer is 40000.

Example

This command sets the SA limit of 500 for the MSDP peer at *10.1.1.5*.

```
switch(config)#router msdp
switch(config-router-msdp)#peer 10.1.1.5
switch(config-router-msdp-peer-10.1.1.5)#sa-limit 500
switch(config-router-msdp-peer-10.1.1.5)#
```

The maximum number of SA messages that the switch can store in the SA cache for a specified multicast group address is configured by the [group-limit](#) command. The default limit of SA messages that the switch can store from a specified group is 40000.

Example

This command sets the maximum number of 1000 SAs for multicast group *225.13.15.8/29*.

```
switch(config)#router msdp
switch(config-router-msdp)#group-limit 1000 source 225.13.15.8/29
```

The maximum number of rejected SA messages that the switch can store in the SA cache is configured by the [ip msdp rejected-limit](#) command. The default limit of rejected SA messages that the switch can store is 40000.

Example

This command sets 5000 as the maximum number of rejected SAs that the SA cache can contain.

```
switch(config)#router msdp
switch(config-router-msdp)#ip msdp rejected-limit 5000
```

Contents of the SA message cache are removed by the [clear ip msdp sa-cache](#) command. The command provides options for removing all cache contents or only contents of a specific multicast group.

Example

This command deletes all SA message cache contents.

```
switch(config)#router msdp
switch(config-router-msdp)#clear ip msdp sa-cache
```

15.4.3.4.2 Displaying SA Cache Contents

SA message cache contents are displayed by the [show ip msdp sa-cache](#) command. Filter options provided by the command for displaying partial cache contents include:

- multicast group address: multicast group

- source address and group address

The command can also display unexpired SAs rejected by ACL filters or cache limit exceeded conditions.

Example

This command displays the contents of the SA message cache.

```
switch(config)#show ip msdp sa-cache
MSDP Source Active Cache
(10.61.71.29, 234.1.4.2), RP 10.5.29.4, heard from 10.5.29.4
(10.51.71.23, 234.1.4.1), RP 10.5.29.4, heard from 10.5.29.4
(10.53.71.27, 234.1.4.2), RP 10.3.25.4, heard from 10.3.25.4
(10.10.101.24, 234.1.4.1), RP 10.2.44.4, heard from 10.2.44.4
(10.10.151.22, 234.1.4.1), RP 10.1.12.4, heard from 10.1.12.4
```

Information about specified MSDP peers, including SAs accepted from the peer is displayed by the [show ip msdp peer](#) command.

Example

This command displays data for the peer at *10.2.42.4*, including SAs accepted from the peer.

```
switch(config)#show ip msdp peer 10.2.42.4 accepted-sas
MSDP Peer 10.2.42.4
Connection status:
  State: Up
  Connection Source: Loopback4 (10.2.43.4)
SA Filtering:
Input Filter: allow-multicast-for-msdp
Output Filter: allow-multicast-for-msdp
SAs accepted:
(10.62.79.30, 234.1.4.2), RP 10.2.42.4
(10.61.79.29, 234.1.4.1), RP 10.2.42.4
(10.62.79.30, 234.1.4.1), RP 10.2.42.4
```

The SA cache for the local PIM domain is displayed by the [show ip msdp pim sa-cache](#) command.

Example

This command displays the SA cache for the local PIM domain.

```
switch(config)#show ip msdp pim sa-cache
MSDP Source Active Messages for local Pim RP
(10.51.71.23, 234.1.4.1), RP 10.2.43.4
(10.20.91.26, 234.1.4.1), RP 10.2.43.4
(10.20.91.26, 234.1.4.2), RP 10.2.43.4
(10.20.91.24, 234.1.4.1), RP 10.2.43.4
```

15.4.3.4.3 Verifying Consistency Between the SA Cache and the Routing Table

To check the consistency between the multicast routing table and the MSDP Source-Address (SA) caches, enter [show ip msdp sanity](#) . When the command detects inconsistencies, it displays the cache entries that are not in the table.

Example

This command displays a sanity check that detects inconsistencies between the SA cache and the multicast routing table.

```
switch(config)#show ip msdp sanity
PIM SA cache entries not in the MRT
Msdp-learnt MRT entries not in the SA cache
SA cache entries not in the MRT
(192.168.3.8, 224.1.154.1)
(192.168.3.35, 224.1.167.1)
(192.168.3.16, 224.1.226.1)
(192.168.3.12, 224.1.182.1)
(192.168.3.33, 224.1.150.1)
May-Notify-MSDP entries not in the PIM SA cache
(need not be an error condition)
4.1), RP 10.2.42.4
```

15.4.3.5 Configuring MSDP in a non-default VRF

The MSDP can also be configured in a non-default VRF, when the default VRF used does not have a name. The following commands configure MSDP in a non-default VRF.

Example

These commands configure MSDP peer *1.1.1.1* in a non-default VRF blue.

```
switch(config)#router msdp
switch(config-router-msdp)#vrf blue
switch(config-router-msdp-vrf-blue)#peer 1.1.1.1
```

15.4.4 MSDP Commands

MSDP Configuration Commands (Global)

- `connection retry interval`
- `group-limit`
- `ip msdp rejected-limit`
- `originator-id local-interface`
- `peer`
- `router msdp`

MSDP Peer Configuration Commands

- `default-peer`
- `description (MSDP)`
- `disabled (MSDP)`
- `keepalive (MSDP)`
- `local-interface`
- `mesh-group`
- `sa-filter in`
- `sa-filter out`
- `sa-limit`

MSDP SA Cache Commands

- `clear ip msdp sa-cache`

MSDP Display Commands

- `show ip msdp peer`
- `show ip msdp pim sa-cache`
- `show ip msdp sa-cache`
- `show ip msdp sanity`
- `show ip msdp summary`
- `show msdp mesh-group`
- `show msdp rpf-peer`

15.4.4.1 clear ip msdp sa-cache

The `clear ip msdp sa-cache` command removes contents of the Source-Active (SA) message cache. The command provides these filter options for removing partial cache contents:

- contents of a multicast group by specifying its group address.
- all cache contents.

Command Mode

Router MSDP Configuration

Router MSDP VRF Configuration

Command Syntax

```
clear ip msdp sa-cache [ADDRESS_FILTER]
```

Parameters

ADDRESS_FILTER IPv4 address used to select table entries for removal.

- *<no parameter>* All SA messages.
- *grp_addr* Multicast group address (IPv4 address). The *grp_addr* must be a valid multicast address.

Example

This command deletes all SA message cache contents.

```
switch(config) #router msdp  
switch(config-router-msdp) #clear ip msdp sa-cache
```

15.4.4.2 connection retry interval

The **connection retry interval** command specifies the period that the switch waits after an MSDP peering session is reset before trying to reestablish the session. The default period is 30 seconds.

The **no connection retry interval** and **default connection retry interval** commands reset the timer interval to the default period of 30 seconds by removing the **connection retry interval** command from *running-config*.

Command Mode

Router MSDP Configuration

Router MSDP VRF Configuration

Command Syntax

```
connection retry interval connect_retry  
no connection retry interval connect_retry  
default connection retry interval connect_retry
```

Parameter

connect_retry Reconnect period (seconds). Value ranges from 1 to 65535. Default is 30.

Example

This command configures the switch to wait 45 seconds after an MSDP peering session is reset before attempting to reestablish the session.

```
switch(config) #router msdp  
switch(config-router-msdp) #connection retry interval 45
```

15.4.4.3 default-peer

The **default-peer** command configures the specified MSDP peer connection as a default peer on the switch. The default peer configuration defines the peers from which the switch accepts Source-Active (SA) messages. When the command includes a **prefix list** parameter, the specified peer is the default peer for only SA messages originating from rendezvous points (RPs) covered by prefix list entries. The default peer address must be a previously configured MSDP peer (configured using the **peer** command).

Default peers provide an alternative to reverse packet forwarding (RPF) typically used by MSDP to specify the peers from which a switch accepts SA messages. However, RPF requires a unicast routing table that is correct and converged. RPF also assumes symmetric forward and reverse paths between router and sender. RPF fails on uni-directional links. Default MSDP peers invalidate the use of RPF over unicast routing tables.

The switch can designate multiple default peers:

- Switch defines one peer: A default peer statement is not required; the switch accepts SA traffic from the configured peer.
- Switch defines one default peer (no prefix list): The switch accepts all SA messages from only the default peer.
- Switch defines multiple default peers (no prefix lists): The switch accepts all SA messages from only the first default peer listed in **running-config**. Other listed default peers are used only when peers listed before them in **running-config** are not accessible.
- First default-peer statement includes a prefix list: The switch accepts all SA messages from the default peer whose originating RP is covered in the prefix list. The disposition of SA messages originating from other RPs is determined by subsequent **default-peer** statements.

The **no default-peer** and **default default-peer** commands remove the corresponding **default-peer** command from **running-config**.

Command Mode

Router MSDP Peer Configuration

Router MSDP Peer VRF Configuration

Command Syntax

```
default-peer [PREFIX]
no default-peer
default default-peer
```

Parameters

PREFIX List of RPs from the SA messages originate for which the default peer is valid.

- **<no parameter>** default peer is valid for SAs from all originating RPs.
- **prefix-list list_name** name of the prefix list that defines affected originating RP prefixes.

Example

These commands configure two MSDP peers and configure the peer at 10.5.2.2 as the default peer.

```
switch(config)#router msdp
switch(config-router-msdp)#peer 10.6.2.2
switch(config-router-msdp-peer-10.6.2.2)#exit
switch(config-router-msdp)#peer 10.5.2.2
switch(config-router-msdp-peer-10.5.2.2)#default-peer
switch(config-router-msdp-peer-10.5.2.2)#
```

15.4.4.4 description (MSDP)

The **description** command associates descriptive text with the configuration-mode MSDP peer.

The **no description** and **default description** commands remove the text association from the specified peer.

Command Mode

Router MSDP Peer Configuration

Router MSDP Peer VRF Configuration

Command Syntax

```
description description_string
```

```
no description
```

```
default description
```

Parameters

- *description_string* text string that is associated with the peer.

Example

These commands associate the string NORTH with the MSDP peer located at *10.4.4.12*.

```
switch(config)#router msdp
switch(config-router-msdp)#peer 10.4.4.12
switch(config-router-msdp-peer-10.4.4.12)#description NORTH
switch(config-router-msdp-peer-10.4.4.12)#show ip msdp peer
MSDP Peer 10.4.4.12
Description: NORTH
Connection status:
  State: Connect
  Resets: 0
  Connection Source: Loopback100 (10.6.8.6)
SAs accepted:
switch(config-router-msdp-peer-10.4.4.12)#
```

15.4.4.5 disabled (MSDP)

The **disabled** command closes the peering session with the specified MSDP peer by terminating the TCP connection between the switch and the peer. The connection is not resumed until the shutdown command is removed from **running-config**.

The **no disabled** and **default disabled** commands establish an MSDP peering session with the specified peer by removing the corresponding **disabled** command from **running-config**.

Command Mode

Router MSDP Peer Configuration

Router MSDP Peer VRF Configuration

Command Syntax

```
disabled
```

```
no disabled
```

```
default disabled
```

Examples

- This command closes the peering session with the MSDP peer at *10.4.4.12*.

```
switch(config)#router msdp
switch(config-router-msdp)#peer 10.4.4.12
switch(config-router-msdp-peer-10.4.4.12)#disabled
switch(config-router-msdp-peer-10.4.4.12)#show ip msdp peer
MSDP Peer 10.4.4.12
Description: NORTH
Connection status:
  State: Disbled
  Resets: 0
  Connection Source: Loopback100 ( 10.6.8.6 )
SAs accepted:
switch(config-router-msdp-peer-10.4.4.12)#
```

- This command reopens the peering session with the peer at *10.4.4.12*.

```
switch(config)#router msdp
switch(config-router-msdp)#peer 10.4.4.12
switch(config-router-msdp-peer-10.4.4.12)#no disabled
switch(config-router-msdp-peer-10.4.4.12)#show ip msdp peer
MSDP Peer 10.4.4.12
Description: NORTH
Connection status:
  State: Connect
  Resets: 0
  Connection Source: Loopback100 ( 10.6.8.6 )
SAs accepted:
switch(config-router-msdp-peer-10.4.4.12)#
```

15.4.4.6 group-limit

The **group-limit** command specifies the maximum number of Source-Active (SA) messages that the switch allows in the SA cache for a specified multicast group address.

SA messages have an expiration period of 90 seconds and remain in the SA cache until they expire. The switch does not accept SA messages for a group whose cache limit is reached until its cached messages start expiring.

The **no group-limit** and **default group-limit** command removes the maximum group limit for the specified prefix by removing the corresponding **group-limit** statement from **running-config**.

Command Mode

Router MSDP Configuration

Router MSDP VRF Configuration

Command Syntax

```
group-limit quantity source src_subnet
```

```
no group-limit quantity source src_subnet
```

```
default group-limit quantity source src_subnet
```

Parameters

- *quantity* maximum number of groups that can access the interface. Value ranges from 1 to 40000.
- *src_subnet* Source IPv4 subnet (CIDR or address-mask notation).

Example

This command sets the maximum number of 1000 SAs for multicast group *10.13.15.8/29*.

```
switch(config)#router msdp  
switch(config-router-msdp)#group-limit 1000 source 10.13.15.8/29
```

15.4.4.7 ip msdp rejected-limit

The **ip msdp rejected-limit** command specifies the maximum number of rejected Source-Active messages that the switch allows in the SA cache.

SA messages have an expiration period of 90 seconds. They remain in the SA cache during this time. The default limit of rejected SA messages that the switch can store is 40000.

The **no ip msdp rejected-limit** and **default ip msdp rejected-limit** commands restore the rejected SA limit of 40000 by removing the **ip msdp rejected-limit** statement from **running-config**.

Command Mode

Router MSDP Configuration

Router MSDP VRF Configuration

Command Syntax

```
ip msdp rejected-limit quantity
```

```
no ip msdp rejected-limit
```

```
default ip msdp rejected-limit
```

Parameter

quantity maximum rejected SA messages the SA cache can store. Value ranges from 0 to 40000.

Example

This command sets 5000 as the maximum number of rejected SAs that the SA cache can contain.

```
switch(config)#router msdp  
switch(config-router-msdp)#ip msdp rejected-limit 5000
```

15.4.4.8 keepalive (MSDP)

The **keepalive** command configures the MSDP keep-alive and hold time intervals for a specified MSDP peer connection.

- Keep-alive time interval is the period between the transmission of consecutive keep-alive messages. The default keep-alive time interval is 60 seconds.
- Hold time interval is the period the switch waits for a KEEPALIVE or UPDATE message before it disables peering. The default hold time interval is 75 seconds.

The **no keepalive** and **default keepalive** commands restore the default keep-alive and hold time intervals for the specified MSDP peer connection by removing the corresponding **keepalive** command from **running-config**.

Command Mode

Router MSDP Peer Configuration

Router MSDP Peer VRF Configuration

Command Syntax

```
keepalive keep_alive hold_time
```

```
no keepalive
```

```
default keepalive
```

Parameters

- *keep_alive* keep-alive period in seconds. Value ranges from 1 to 65535. Default value is 60.
- *hold_time* hold time in seconds. Value ranges from 1 to 65535. Default value is 75.

 **Note:** The hold time interval must be longer than or equal to the keep-alive time interval.

Example

This command sets the keep-alive time to 45 seconds and the hold time to 80 seconds for the connection with the MSDP peer at *10.4.4.12*.

```
switch(config)#router msdp
switch(config-router-msdp)#peer 10.4.4.12
switch(config-router-msdp-peer-10.4.4.12)#keepalive 45 80
switch(config-router-msdp-peer-10.4.4.12)#
```

15.4.4.9 local-interface

MSDP peering sessions are established over a TCP connection. The **local-interface** command specifies the interface through which the TCP connection is established with the configuration-mode MSDP peer. When the **local-interface** command is not used to specify an interface, the connection is established through an interface determined by existing routing algorithms.

The **no local-interface** and **default local-interface** commands remove the corresponding **local-interface** command from *running-config*, returning selection of the connecting interface to the routing algorithm.

Command Mode

Router MSDP Peer Configuration

Router MSDP VRF Peer Configuration

Command Syntax

```
local-interface interface
no local-interface
default local-interface
```

Parameters

interface local interface through which the TCP connection is established. Options include:

- ethernet *e_num* Ethernet interface.
- loopback *l_num* Loopback interface.
- management *m_num* Management interface.
- port-channel *p_num* Port-Channel Interface.
- vlan *v_num* VLAN interface.
- vxlan *vx_num* VXLAN interface.

Example

These commands assign an IP address to loopback interface 100, then establish the TCP peer session to the MSDP peer at *10.4.4.12* through the loopback in the default VRF.

```
switch(config)#interface loopback 100
switch(config-if-Lo100)#ip address 10.6.8.6/24
switch(config-if-Lo100)#exit
switch(config)#router msdp
switch(config-router-msdp)#peer 10.4.4.12
switch(config-router-msdp-peer-10.4.4.12)#local-interface loopback 100
switch(config-router-msdp-peer-10.4.4.12)#show ip msdp peer
MSDP Peer 10.4.4.12
Connection status:
  State: Connect
  Resets: 0
  Connection Source: Loopback100 (10.6.8.6)
SAs accepted:
switch(config-router-msdp-peer-10.4.4.12)#
```

15.4.4.10 mesh-group

The **mesh-group** command configures the configuration-mode MSDP peer connection as an MSDP mesh group member. A peer can be assigned to multiple mesh groups. Multiple MSDP peers can be assigned to a common mesh group.

An MSDP mesh group is a network of MSDP speakers where each speaker directly connects to every other speaker. The switch does not forward Source-Active (SA) messages that it receives from a mesh group peer to other peers of the same group.

The **no mesh-group** and **default mesh-group** commands delete the configuration-mode peer connection from a mesh group by removing the corresponding **mesh-group** command from **running-config** when issued in Router MSDP Peer Configuration or Router MSDP Peer VRF Configuration Mode.

 **Note:** To delete all configured connections from a specified mesh group, use the **no mesh-group** command in Router MSDP Configuration mode.

Command Mode

Router MSDP Configuration

Router MSDP Peer Configuration

Router MSDP Peer VRF Configuration

Command Syntax

```
mesh-group group_name
```

```
no mesh-group group_name
```

```
default mesh-group group_name
```

Parameters

group_name name of mesh group.

Related Command

[show msdp mesh-group](#) .

Examples

- These commands configure the MSDP peer connection to *10.1.1.14* as a member of the AREA-1 mesh group, then display members of mesh groups to which configured MSDP peers belong.

```
switch(config)#router msdp
switch(config-router-msdp)#peer 10.1.1.14
switch(config-router-msdp-peer-10.1.1.14)#mesh-group AREA-1
switch(config-router-msdp-peer-10.1.1.14)#show msdp mesh-group
Mesh Group: AREA-1
    10.1.1.14
Mesh Group: tier_01
    10.24.18.13
Mesh Group: tier_02
    10.26.101.18
switch(config-router-msdp-peer-10.1.1.14)#
```

- These commands delete all configured connections from the AREA-1 mesh group.

```
switch(config)#router msdp
switch(config-router-msdp)#no mesh-group AREA-1
switch(config-router-msdp)#
```

15.4.4.11 originator-id local-interface

The **originator-id local-interface** command configures an originator ID to replace the rendezvous point (RP) address in source-address (SA) messages that it originates as an MSDP speaker.

SA messages that an MSDP speaker originates contain the speaker's rendezvous point (RP) address, as configured through PIM statements and processes. An originator ID is an alternative IPv4 address that a speaker uses in place of its RP address when advertising SA messages. This command configures the switch to use the specified interface's IP address as the RP address in SA messages that it originates.

The **no originator-id local-interface** and **default originator-id local-interface** commands configure the switch to use its RP address in SA messages that it sends by removing the **originator-id local-interface** command from *running-config*.

Command Mode

Router MSDP Configuration

Router MSDP VRF Configuration

Command Syntax

```
originator-id local-interface INTERFACE
no originator-id local-interface INTERFACE
default originator-id local-interface INTERFACE
```

Parameters

INTERFACE Specifies the interface from which the IP address is derived. Options include:

- ethernet *e_num* Ethernet interface.
- loopback *l_num* Loopback interface.
- management *m_num* Management interface.
- port-channel *p_num* Port-Channel Interface.
- vlan *v_num* VLAN interface.
- vxlan *vx_num* VXLAN interface.

Example

These commands configure the switch to use the IP address assigned to loopback interface 100 as the RP address in SA messages that it originates.

```
switch(config)#router msdp
switch (config-router-msdp)#originator-id local-interface loopback 100
switch (config-router-msdp)#
```

15.4.4.12 peer

The **peer** command configures the specified address as an MSDP peer, enables MSDP on the switch if it was not previously enabled, and places the switch in Router MSDP Peer Configuration Mode for the specified peer.

The peering session with the device at the specified network is established over a TCP connection. The **local-interface** command can specify an interface through which the TCP connection is established. When the **local-interface** command is not used to specify an interface, the connection is established through an interface determined by existing routing algorithms.

The **no peer** and **default peer** commands remove the specified MSDP peer configuration by deleting the corresponding **peer** command from **running-config**. MSDP is disabled when the last **peer** command is removed.

Command Mode

Router MSDP Configuration

Command Syntax

```
peer ip_address
```

Parameters

ip_address IP address of the MSDP peer to be configured.

Commands Available in Router MSDP Peer Configuration Mode

- [default-peer](#)
- [description \(MSDP\)](#)
- [disabled \(MSDP\)](#)
- [keepalive \(MSDP\)](#)
- [local-interface](#)
- [mesh-group](#)
- [sa-filter in](#)
- [sa-filter out](#)
- [sa-limit](#)

Example

These commands establish an MSDP peer relationship with the peer at *192.168.3.17* and place the switch in the Router MSDP Peer Configuration Mode for that peer.

```
switch(config)#router msdp  
switch(config-router-msdp)#peer 192.168.3.17  
switch(config-router-msdp-peer-192.168.3.17)#
```

15.4.4.13 router msdp

The **router msdp** command places the switch in the router MSDP configuration mode, and allows to configure the global IP configuration commands and VRF commands in this mode.

The **no router msdp** and **default router msdp** commands removes the corresponding **router msdp** command from *running-config*.

Command Mode

Global Configuration

Command Syntax

```
router msdp
```

```
no router msdp
```

```
default router msdp
```

Example

This command places the switch in the router MSDP configuration mode.

```
switch(config)#router msdp  
switch(config-router-msdp)#
```

Related Commands

- [connection retry interval](#)
- [default-peer](#)
- [description \(MSDP\)](#)
- [disabled \(MSDP\)](#)
- [group-limit](#)
- [ip msdp rejected-limit](#)
- [keepalive \(MSDP\)](#)
- [mesh-group](#)
- [originator-id local-interface](#)
- [peer](#)
- [sa-filter in](#)
- [sa-filter out](#)
- [sa-limit](#)

15.4.4.14 sa-filter in

The **sa-filter in** command assigns an IP access control list (ACL) as a filter for inbound Source-Active (SA) messages from the configuration-mode MSDP peer connection. The switch only accepts SA messages from the peer that are accepted by the assigned ACL. The switch accepts all SA messages from the peer when an ACL is not assigned as an inbound filter.

Only one ACL can be assigned as an inbound filter to an MSDP peer. Any subsequent **sa-filter in** commands for the peer replace the existing command.

The **no sa-filter in** and **default sa-filter in** commands remove the ACL assignment as an inbound filter by removing the corresponding **sa-filter in** command from **running-config**.

Command Mode

Router MSDP Peer Configuration

Router MSDP Peer VRF Configuration

Command Syntax

```
sa-filter in list list_name
```

```
no sa-filter in
```

```
default sa-filter in
```

Parameters

- *peer_id* MSDP peer address (IPv4 address).
- *list_name* name of ACL that filters SA messages.

Related Command

[sa-filter out](#)

Guideline

The command accepts standard and extended ACLs. The address field in a standard ACL filters an SA message on its group address.

Example

These commands create an IP ACL named LIST-IN as the inbound SA message filter for the MSDP peer connection to *10.4.4.12*. The ACL permits SAs from the multicast group *239.14.4.2/28*.

```
switch(config)#ip access-list LIST-IN
switch(config-acl-LIST-IN)#permit ip any 239.14.4.2/28
switch(config-acl-LIST-IN)#exit
switch(config)#router msdp
switch(config-router-msdp)#peer 10.4.4.12
switch(config-router-msdp-peer-10.4.4.12)#sa-filter in list LIST-IN
switch(config-router-msdp-peer-10.4.4.12)#show ip msdp peer
MSDP Peer 10.4.4.12
Connection status:
  State: Listen
  Connection Source: Loopback100 (10.6.8.6)
SA Filtering:
Input Filter: LIST-IN
```

15.4.4.15 sa-filter out

The **sa-filter out** command assigns an IP access control list (ACL) as a filter for outbound Source-Active (SA) messages to the configuration-mode MSDP peer connection, after which the switch only sends SA messages to the peer that are accepted by the assigned ACL. The switch sends all SA messages to the peer when an ACL is not assigned as an output filter to the peer.

Only one ACL can be assigned as an outbound filter to an MSDP peer. Any subsequent **sa-filter out** commands for the peer replace the existing command.

The **no sa-filter out** and **default sa-filter out** commands remove the ACL assignment as an outbound filter by removing the corresponding **sa-filter out** command from **running-config**.

Command Mode

Router MSDP Peer Configuration

Router MSDP Peer VRF Configuration

Command Syntax

```
sa-filter out list list_name
```

```
no sa-filter out
```

```
default sa-filter out
```

Parameters

- *peer_id* MSDP peer address (IPv4 address).
- *list_name* name of ACL that filters SA messages.

Related Command

[sa-filter in](#) assigns an IP ACL to filter inbound SA messages from the MSDP peer being configured.

Guidelines

The command accepts standard and extended ACLs. The address field in a standard ACLs filters an SA message on its group address.

Example

These commands assign the IP ACL named LIST-OUT as the outbound SA message filter for the MSDP peer connection to *10.4.4.12*.

```
switch(config)#router msdp
switch(config-router-msdp)#ip access-list LIST-OUT
switch(config-acl-LIST-OUT)#permit ip any 239.14.4.2/28
switch(config-acl-LIST-OUT)#exit
switch(config)#router msdp
switch(config-router-msdp)#peer 10.4.4.12
switch(config-router-msdp-peer-10.4.4.12)#sa-filter out list LIST-OUT
switch(config-router-msdp-peer-10.4.4.12)#show ip msdp peer
MSDP Peer 10.4.4.12
Connection status:
  State: Listen
  Connection Source: Loopback100 ( 10.6.8.6 )
SA Filtering:
Output Filter: LIST-OUT
switch(config-router-msdp-peer-10.4.4.12)#
```

15.4.4.16 sa-limit

The **sa-limit** command specifies the maximum number of Source-Active messages from a specified MSDP peer that the switch allows in the SA cache. SA messages have an expiration period of 90 seconds, during which time they remain in the SA cache. The switch does not accept SA messages from a peer after the peer's SA limit is reached. By default, The limit to the number of SA messages that the switch can store from a specified peer is 40000, by default.

The **no sa-limit** and **default sa-limit** commands restore the SA limit of 40000 for the specified MSDP peer by removing the corresponding **sa-limit** statement from **running-config**.

Command Mode

Router MSDP Peer Configuration

Router MSDP Peer VRF Configuration

Command Syntax

```
sa-limit quantity
```

```
no sa-limit
```

```
default sa-limit
```

Parameters

- *peer_id* MSDP peer (IPv4 address).
- *quantity* maximum number of SA messages that the switch can store. Value ranges from 0 to 40000.

Example

This command sets the SA limit of 500 for the MSDP peer at *10.1.1.5*.

```
switch(config)#router msdp
switch(config-router-msdp)#peer 10.1.1.5
switch(config-router-msdp-peer-10.1.1.5)#sa-limit 500
switch(config-router-msdp-peer-10.1.1.5)#
```

15.4.4.17 show ip msdp peer

The **show ip msdp peer** command displays information about specified MSDP peers. The command includes an optional parameter for displaying SAs accepted from the peer.

Command Mode

EXEC Command Syntax

```
show ip msdp peer [PEER_ADDR][SA_ACCEPT]
```

Parameters

- *PEER_ADDR* Peers for which command displays information.
 - *<no parameter>* All peers configured on the switch.
 - *ipv4_addr* Address of specified MSDP peer.
- *SA_ACCEPT* Command displays SAs accepted from the specified peers.
 - *<no parameter>* Accepted SAs are not displayed.
 - *accepted-sas* Accepted SAs are displayed.

Example

This command displays MSDP information concerning the peer located at *10.2.42.4*, including SAs that the switch accepted from this peer.

```
switch(config)#show ip msdp peer 10.2.42.4 accepted-sas
MSDP Peer 10.2.42.4
Connection status:
  State: Up
  Connection Source: Loopback4 ( 10.2.43.4 )
SA Filtering:
Input Filter: allow-multicast-for-msdp
Output Filter: allow-multicast-for-msdp
SAs accepted:
(10.62.79.30, 234.1.4.2), RP 10.2.42.4
(10.61.79.29, 234.1.4.1), RP 10.2.42.4
(10.62.79.30, 234.1.4.1), RP 10.2.42.4
```

15.4.4.18 show ip msdp pim sa-cache

The **show ip msdp pim sa-cache** command displays the SA cache for the local PIM domain configured on the switch. An SA cache is a table of Source-Active messages that are generated or accepted by the PIM domain.

Command Mode

EXEC

Command Syntax

```
show ip msdp pim sa-cache
```

Example

This command displays the SA cache for the local PIM domain.

```
switch(config)#show ip msdp pim sa-cache
MSDP Source Active Messages for local Pim RP
(10.51.71.23, 234.1.4.1), RP 10.2.43.4
(10.20.91.26, 234.1.4.1), RP 10.2.43.4
(10.51.71.23, 234.1.4.2), RP 10.2.43.4
(10.20.91.21, 234.1.4.1), RP 10.2.43.4
(10.51.79.23, 234.1.4.1), RP 10.2.43.4
(10.20.91.24, 234.1.4.2), RP 10.2.43.4
(10.51.79.23, 234.1.4.2), RP 10.2.43.4
(10.20.91.21, 234.1.4.2), RP 10.2.43.4
(10.20.91.26, 234.1.4.2), RP 10.2.43.4
(10.20.91.24, 234.1.4.1), RP 10.2.43.4
```

15.4.4.19 show ip msdp sa-cache

The **show ip msdp sa-cache** command displays contents of the Source-Active (SA) message cache. The command provides these filter options for displaying partial cache contents:

- multicast group address: multicast group
- source address and group address

The command can also display unexpired SAs that were rejected by ACL filters or cache limit exceeded conditions.

Command Mode

EXEC

Command Syntax

```
show ip msdp sa-cache [ADDRESS_FILTER][CONTENTS]
```

Parameters

- ADDRESS_FILTER IPv4 address used to filter SA messages.
 - *<no parameter>* All SA messages.
 - *grp_addr* Multicast group address (IPv4 address).
 - *src_addr grp_addr* Source and multicast group addresses (two IPv4 addresses).

grp_addr must be a valid multicast address.

- CONTENTS type of SAs that the command displays.
 - *<no parameter>* Displays contents of SA Cache.
 - *rejected* Displays rejected SAs in addition to the SA cache contents.

Example

This command displays the contents of the SA message cache.

```
switch(config)#show ip msdp sa-cache
MSDP Source Active Cache
(10.61.71.29, 234.1.4.2), RP 10.5.29.4, heard from 10.5.29.4
(10.51.71.23, 234.1.4.1), RP 10.5.29.4, heard from 10.5.29.4
(10.61.79.29, 234.1.4.2), RP 10.5.29.4, heard from 10.5.29.4
(10.53.71.27, 234.1.4.2), RP 10.3.25.4, heard from 10.3.25.4
(10.10.101.24, 234.1.4.1), RP 10.2.44.4, heard from 10.2.44.4
(10.10.151.22, 234.1.4.2), RP 10.1.12.4, heard from 10.1.12.4
(10.61.71.29, 234.1.4.1), RP 10.5.29.4, heard from 10.5.29.4
(10.20.91.21, 234.1.4.1), RP 10.2.44.4, heard from 10.2.44.4
(10.61.79.29, 234.1.4.1), RP 10.2.42.4, heard from 10.2.42.4
(10.53.79.27, 234.1.4.2), RP 10.3.25.4, heard from 10.3.25.4
(10.10.151.28, 234.1.4.2), RP 10.3.25.4, heard from 10.3.25.4
(10.52.79.25, 234.1.4.2), RP 10.2.44.4, heard from 10.2.44.4
(10.52.71.25, 234.1.4.2), RP 10.2.44.4, heard from 10.2.44.4
(10.20.91.24, 234.1.4.1), RP 10.5.29.4, heard from 10.5.29.4
(10.10.151.22, 234.1.4.1), RP 10.1.12.4, heard from 10.1.12.4
```

15.4.4.20 show ip msdp sanity

The **show ip msdp sanity** command performs a consistency check between the multicast routing table and the MSDP Source-Address (SA) caches. When the command detects inconsistencies, it displays the cache entries that are not in the table.

Command Mode

EXEC

Command Syntax

```
show ip msdp sanity
```

Examples

- This command displays a sanity check that detects no inconsistencies between the SA cache and the multicast routing table.

```
switch(config)#show ip msdp sanity
PIM SA cache entries not in the MRT
Msdp-learned MRT entries not in the SA cache
SA cache entries not in the MRT
May-Notify-MSDP entries not in the PIM SA cache
(need not be an error condition)
```

- This command displays inconsistencies between the SA cache and the multicast routing table.

```
switch(config)#show ip msdp sanity
PIM SA cache entries not in the MRT
Msdp-learned MRT entries not in the SA cache
SA cache entries not in the MRT
(192.168.3.8, 224.1.154.1)
(192.168.3.35, 224.1.167.1)
(192.168.3.16, 224.1.226.1)
(192.168.3.19, 224.1.246.1)
(192.168.3.17, 224.1.204.1)
(192.168.3.12, 224.1.182.1)
(192.168.3.33, 224.1.150.1)
(192.168.3.26, 224.1.198.1)
(192.168.3.33, 224.1.195.1)
(192.168.3.4, 224.1.246.1)
(192.168.3.37, 224.1.188.1)
(192.168.3.12, 224.1.245.1)
(192.168.3.31, 224.1.206.1)
(192.168.3.35, 224.1.178.1)
(192.168.3.6, 224.1.155.1)
May-Notify-MSDP entries not in the PIM SA cache
(need not be an error condition)
4.1), RP 10.2.42.4
```

15.4.4.21 show ip msdp summary

The **show ip msdp summary** command displays a list of peer addresses, the operational status of the peer, and the number of Source-Active messages in the SA cache from that peer.

Command Mode

EXEC

Command Syntax

```
show ip msdp summary
```

Example

This command displays the configured peers, the status of the peers, and the number of SA message received from those peers.

```
switch(config)#show ip msdp summary
MSDP Peer Status Summary
Peer Address      State  SA Count
192.168.3.18     Up     0
192.168.3.16     Up     0
192.168.3.37     Listen 0
192.168.3.46     Up     0
192.168.3.47     Up     0
```

15.4.4.22 show msdp mesh-group

The **show msdp mesh-group** command displays the mesh group membership of MSDP peers that are configured on the switch. An MSDP mesh group is a network of MSDP speakers where each speaker is directly connected to every other speaker. The switch does not forward Source-Active (SA) messages that it receives from a mesh group peer to other peers of the same group.

Command Mode

EXEC

Command Syntax

```
show msdp mesh-group
```

Related Command

[mesh-group](#) configures the MSDP peer connection as an MSDP mesh group member.

Example

This command displays the mesh group membership of configured MSDP peers.

```
switch(config)#show msdp mesh-group
Mesh Group: tier_01
             10.24.18.13
Mesh Group: tier_02
             10.26.101.18
```

15.4.4.23 show msdp rpf-peer

The **show msdp rpf-peer** command displays MSDP information for the peer from which the switch accepts SA messages for a specified rendezvous point (RP).

The switch examines the BGP routing table to determine the next hop peer toward the originating RP of an SA message. This next hop peer is the reverse path forwarding (RPF) peer. Because the switch receives SA messages from the RPF peer, it forwards the message to all other MSDP peers. The switch rejects identical SA messages that it receives from a non-RPF peer.

Command Mode

EXEC

Command Syntax

```
show msdp rpf-peer rp_addr
```

Parameter

rp_addr PIM RP IPv4 address.

Example

This command displays MSDP information for the peer from which the switch accepts SA messages for the RP at *10.5.29.4*.

```
switch(config)#show msdp rpf-peer 10.5.29.4  
Rpf Peer is 10.5.29.4 for RP 10.5.29.4
```

15.5 Audio Video Bridging (AVB)

Arista switches support Audio Video Bridging (AVB) and the associated protocols. This section describes AVB concepts and the implementation of associated protocols.

Topics in this section include:

- [AVB Overview](#)
- [AVB Protocols](#)
- [AVB Configuration](#)
- [AVB Command Descriptions](#)

15.5.1 AVB Overview

Audio Video Bridging (AVB) is a protocol set that provides precision time synchronization, admission control, queuing reservation, and guaranteed bandwidth of professional grade quality audio and video across an IP network.

Supported AVB protocols include:

- Generalized Precision Time Protocol (gPTP)
- Multiple Stream Reservation Protocol (MSRP)
- Multiple VLAN Registration Protocol (MVRP)

These AVB features are supported on Arista 7280, 7150 Series, and 7500E Series switches:

- gPTP with hardware time stamping
- gPTP Grandmaster function
- MSRP protocol on Ethernet interfaces: stream admission control and propagation
- Control plane protection for PTP and MSRP control frames
- MVRP

-
- Traffic classes 2 and 3 for AVB traffic
 - Traffic shaping on egress ports

These AVB features are not available on Arista switches:

- MSRP protocol on LAGs
- MSRP co-ordination with gPTP; streams are allowed even when gPTP is not in sync
- MMRP
- Signaling message support in gPTP
- Running peer delay mechanism on STP blocked ports
- Grandmaster-specific state machines (gPTP)

15.5.2 AVB Protocols

This section describes supported AVB protocols:

- [gPTP](#)
- [MVRP](#)
- [MSRP](#)
- [MRP](#)

15.5.2.1 gPTP

Generalized Precision Time Protocol (gPTP) is a network time synchronization standard for bridged Local Area Networks based on the IEEE 1588v2 Precision Time Protocol and supports the AVB protocol standards.

Time synchronization in a gPTP domain is conducted the same way as in a PTP 1588 domain. A grandmaster is selected through the best grand master clock algorithm and distributes timing synchronization information to all directly attached peers. This information is propagated across the network to provide a common time reference to all Audio and Video end stations.

15.5.2.2 MVRP

Multiple VLAN Registration Protocol (MVRP) is an application of Multiple Registration Protocol used by AVB endpoints to dynamically register and unregister VLANs on an interface.

When an interface wishes to join a VLAN advertised by an MSRP talker (to receive a stream), MVRP sends a Join message. On receiving the Join message, the interface is added to the VLAN. If the VLAN does not already exist, MVRP dynamically creates the VLAN and propagates it through the network.

MVRP events post Syslog messages, with the severity level of **INFO** for each message.

- **MVRP_VLAN_JOIN**

MVRP VLAN Join received/transmitted on an interface.

- **MVRP_VLAN_LV**

MVRP VLAN Leave received/transmitted on an interface.

- **MVRP_ERROR**

MVRP Join was discarded due to an error.

15.5.2.3 MSRP

Multiple Stream Registration Protocol (MSRP) is a signaling protocol that allows end stations (nodes) to reserve network resources and ensure QoS for communicating with other end stations.

MSRP nodes are specified as talkers or listeners:

- Talker nodes transmit multimedia streams to other nodes in the AVB network.
- Listener nodes receive multimedia streams from the AVB talker nodes.

MSRP is implemented by the switch on individual interfaces. MSRP is active when it is enabled on at least one interface, and stopped when it is disabled on all interfaces. MSRP uses Multiple Registration Protocol (MRP) to facilitate attribute registrations and distribution across connected end points in a LAN environment.

MSRP events post Syslog messages, with the severity level of INFO for each message.

- **MSRP_SR_CLASS_TRANSITION**
MSRP SR Class state transition occurred on an interface.
- **MSRP_TALKER_ADV_JOIN**
Talker Advertise Join message for a stream was transmitted/received on an interface.
- **MSRP_TALKER_FAIL_JOIN**
Talker Failed Join message for a stream was transmitted/received on an interface.
- **MSRP_LISTENER_JOIN**
Listener Join message for a stream was transmitted/received on an interface.
- **MSRP_DOMAIN_JOIN**
Domain Join message was transmitted/received on an interface.
- **MSRP_TALKER_ADV_LV**
Talker Advertise Leave message for a stream was transmitted/received on an interface.
- **MSRP_TALKER_FAIL_LV**
Talker Failed Leave message for a stream was transmitted/received on an interface.
- **MSRP_LISTENER_LV**
Listener Leave message for a stream was transmitted/received on an interface.
- **MSRP_DOMAIN_LV**
Domain Leave message was transmitted/received on an interface.
- **MSRP_BW_ALLOC_SUCCESS**
MSRP Bandwidth was allocated for a listener on an interface.
- **MSRP_BW_ALLOC_FAIL**
MSRP Bandwidth could not be allocated for a listener on an interface.
- **MSRP_BW_DEALLOC**
MSRP Bandwidth was de-allocated for a listener on an interface.
- **MSRP_ERROR**
MSRP Join was discarded because of an error.

15.5.2.4 MRP

Multiple Registration Protocol (MRP) protocol includes MSRP and MVRP, and allows participants in an MRP application to register attributes with participants in a Bridged Local Area Network (BLAN).

15.5.3 AVB Configuration

This section describes the AVB configuration:

- [Enabling gPTP](#)
- [Enabling MSRP](#)
- [Displaying MSRP Configuration and Status](#)

- [Enabling MVRP](#)
- [Displaying MVRP Configuration and Status](#)

15.5.3.1 Enabling gPTP

Configure gPTP on the switch through the `ptp mode gptp` command. PTP is enabled on individual interfaces with the `ptp enable` command.

Example

- These commands configure gPTP on the switch and enable PTP on Ethernet interfaces 41-45.

```
switch(config)#ptp mode gptp
switch(config)#interface ethernet 41-45
switch(config-if-Et41-45)#ptp enable
switch(config)#show running-config
    <-----OUTPUT OMITTED FROM EXAMPLE----->
!
ptp mode gptp
!
    <-----OUTPUT OMITTED FROM EXAMPLE----->
end
switch(config-if-Et41-45)#show active
interface Ethernet41
    speed forced 10000full
    msrp
    ptp enable
interface Ethernet42
    speed forced 10000full
    msrp
    ptp enable
interface Ethernet43
    speed forced 10000full
    msrp
    ptp enable
interface Ethernet44
    speed forced 10000full
    ptp enable
interface Ethernet45
    ptp enable
switch(config-if-Et41-45)#
```

15.5.3.2 Enabling MSRP

MSRP is enabled on an interface with the `msrp` command.

Example

- These commands enable MSRP on Ethernet interfaces 41-43.

```
switch(config)#interface ethernet 41-43
switch(config-if-Et41-43)#msrp
switch(config-if-Et41-43)#show active
interface Ethernet41
    speed forced 10000full
    msrp
interface Ethernet42
    speed forced 10000full
    msrp
interface Ethernet43
```



```

speed forced 10000full
msrp
switch(config-if-Et41-43)#

```

15.5.3.3 Displaying MSRP Configuration and Status

MSRP configuration information and status is displayed with the `show msrp` command.

Example

- This command displays the MSRP status for Ethernet interfaces 41-43.

```

switch(config)#show msrp interfaces ethernet 41-43

MSRP Global Status : Enabled
Max Frame Size : 1522
Max Fan-In Ports : No limit

Class Supported Priority Delta
-----
A           Y           3           75%
B           Y           2           0%

Legend
-----
Adv       : Talker Advertise           Fail       : Talker Fail
AskFail   : Listener Asking Failed     Rdy        : Listener Ready
RdyFail   : Listener Ready Failed

Port      Admin   Sr      Class  Oper State      Talkers    Listeners   Bandwidth
-----
Et41     Active   5       A      Boundary        1          0           1          0          200kbps
Et41     Active   5       B      Core            0          0           0           1          100kbps
Et42     Active   3       A      Core            0          0           1          1          50kbps
Et42     Active   3       B      WaitingForPeer  1          0           0           0          20kbps
Et43     Disabled 3       A      Core            0          0           0           0           0kbps
Et43     Disabled 3       B      Core            0          0           0           0           0kbps

switch(config)#

```

Stream data is available for the talker and listener. The `show msrp interfaces` command displays the status and configuration information for each stream.

Examples

- This command displays data for listener station streams on Ethernet interfaces 1 and 2.

```

switch(config)#show msrp interfaces ethernet 1-2

MSRP Global Status : Enabled
Max Frame Size : 1522
Max Fan-In Ports : No limit

Class Supported Priority Delta
-----
A           Y           3           75%
B           Y           2           0%

Legend
-----
Adv       : Talker Advertise           Fail       : Talker Fail
AskFail   : Listener Asking Failed     Rdy        : Listener Ready
RdyFail   : Listener Ready Failed

Port      Stream Id      Listeners
-----
Port      Stream Id      Dec        Dir

```

```

-----
Et1      0000.0000.0000.002a  AskFail  Tx
         0000.0000.0000.029a  RdyFail  Rx
         0000.0000.0000.038f  AskFail  Rx
Et2      0000.0000.0000.002a  AskFail  Rx
         0000.0000.0000.029a  RdyFail  Rx
         0000.0000.0000.038f  AskFail  Tx

switch(config)#

```

- This command displays data for talker station streams on Ethernet interfaces 1 and 2.

```

switch(config)#show msrp interfaces ethernet 1-2 talkers
Legend
-----
Adv      : Talker Advertise          Fail      : Talker Fail

      Port      Stream Id      Dec      Dir      FailCode
-----
Et1      0000.0000.0000.002a  Adv      Rx      --
         0000.0000.0000.038f  Fail     Tx      7

Et2      0000.0000.0000.002a  Adv      Tx      --
         0000.0000.0000.038f  Adv      Rx      7

switch(config)#

```

15.5.3.4 Enabling MVRP

MVRP is disabled by default. To enable MVRP on an interface, use the **mvrp** command. MVRP is enabled globally if it is enabled on at least one interface.

Example

- These commands enable MVRP on Ethernet interface 34.

```

switch(config)#interface ethernet 34
switch(config-if-Et34)#mvrp
switch(config-if-Et34)#

```

15.5.3.5 Displaying MVRP Configuration and Status

MVRP configuration information and status are displayed with the **show mvrp** command.

Example

- This command displays the MVRP status for Ethernet interfaces 30 through 40.

```

switch(config)#show mvrp interfaces Ethernet 30-40

MVRP Global Status : Enabled

Port      Admin State  Registered Vlans  Declared Vlans
-----
Et30      Disabled
Et31      Disabled
Et32      Disabled
Et33      Disabled
Et34      Active

```

```
Et35      Disabled
Et36      Disabled
Et37      Disabled
Et38      Disabled
Et39      Disabled
Et40      Disabled
switch(config)#
```

15.5.4 AVB Command Descriptions

MSRP Commands

- [msrp](#)
- [msrp streams load-file](#)
- [show msrp](#)
- [show msrp interfaces](#)
- [show msrp streams](#)

MRP Commands

- [mrp leave-all-timer](#)
- [mrp leave-timer](#)

MVRP Commands

- [show mvrp](#)

15.5.4.1 mrp leave-all-timer

The **mrp leave-all-timer** command specifies the mrp leave all timer interval for the configuration mode interface.

When starting MRP, a participant starts its LeaveAll timer. Upon timer expiry, it sends a LeaveAll message and restarts its timer. When other participants receive the message, they register their attributes and restart their leave-all timers.

The default leave-all timer interval is a randomly selected value from 10 to 15 seconds. Under normal conditions, this value should not be adjusted.

The **no mrp leave-all-timer** and **default mrp leave-all-timer** commands restore the default leave-all timer interval on the configuration mode interface by removing the corresponding **mrp leave-all-timer** command from *running-config*.

Command Mode

Interface-Ethernet Configuration

Command Syntax

```
mrp leave-all-timer period
mrp leave-all-timer
default mrp leave-all-timer
no mrp leave-all-timer
```

Parameters

- ***period*** leave all timer interval (seconds). Values range from 10 to 60. Default value is a randomly selected value from 10 to 15.

Example

This command sets the MRP leave-all timer interval on Ethernet interface 17 to twelve seconds.

```
switch(config)#interface ethernet 17
switch(config-if-Et17)#mrp leave-all-timer 12
switch(config-if-Et17)#
```

15.5.4.2 mrp leave-timer

The leave-timer controls the deregistration of attributes. If an MRP participant needs other participants to unregister their attributes, it sends a Leave message. When receiving a Leave message, the Leave-timer starts and unregisters the attributes if it doesn't receive Join messages for the attributes before the Leave-timer expires.

The `mrp leave-timer` command specifies the mrp leave-timer interval for the configuration mode interface. The default leave-timer interval is 0.6 seconds. Under normal operation conditions, this value should not be adjusted.

The `no mrp leave-timer` and `default mrp leave-timer` commands restore the default leave-timer interval of 0.6 seconds on the configuration mode interface by removing the corresponding `mrp leave-timer` command from *running-config*.

Command Mode

Interface-Ethernet Configuration

Command Syntax

```
mrp leave-timer period
```

```
no mrp leave-timer
```

```
default mrp leave-timer
```

Parameters

- *period* leave timer interval (seconds). Values range from 10 to 60. Default value is a randomly selected value from 10 to 15.

Example

- This command sets the MRP leave timer interval on Ethernet interface 17 to 0.8 seconds.

```
switch(config)#interface ethernet 17  
switch(config-if-Et17)#mrp leave-timer 12  
switch(config-if-Et17)#
```

15.5.4.3 msrp streams load-file

The load-file for MSRP streams provides a file that contains an alias that can be substituted in the name (stream-id) of a string.

The `msrp streams load-file` command allows users to include a line in the file (example: **0102.0304.0506 XYZW4** or **0102.0304 XYZW5**) that causes the bytes to be replaced with the accompanying string in `show msrp streams` commands.

The `no msrp streams load-file` and `default msrp streams load-file` commands remove the alias assignment by removing the corresponding `msrp streams load-file` command from *running-config*.

Command Mode

Global Configuration

Command Syntax

```
msrp streams load-file [FILE TYPE]
```

```
no msrp streams load-file
```

```
default msrp streams load-file
```

Parameters

- **FILE TYPE** The options include:
 - **certificate:** device name, directory, or file name
 - **extension:** device name, directory, or file name
 - **file:** device name, directory, or file name
 - **flash:** device name, directory, or file name
 - **ftp:** device name, directory, or file name
 - **http:** device name, directory, or file name
 - **https:** device name, directory, or file name
 - **scp:** device name, directory, or file name
 - **sftp:** device name, directory, or file name
 - **sslkey:** device name, directory, or file name
 - **system:** device name, directory, or file name
 - **terminal:** device name, directory, or file name
 - **tftp:** device name, directory, or file name
 - **usb1:** device name, directory, or file name
- **Example**

This command indicates that the file named file1 contains the alias names that is used in MSRP stream names.

```
switch(config)#msrp streams load-file file1
switch(config)#
```

15.5.4.4 msrp

MSRP enables Multiple Stream Registration Protocol (MSRP), which is a signaling protocol that provides nodes with the ability to reserve network resources to ensure Quality of Service (QoS) between talker and listener endpoints. The Stream Reservation Protocol (SRP) utilizes MSRP to reserve bandwidth for data streams, and configure a complete path between endpoints.

The **msrp** command enables MSRP on the configuration mode interface. If MSRP was not previously enabled on any interface, the MSRP agent is launched by this command.

The **no msrp** and **default msrp** commands disable MSRP on the configuration mode interface, and removes the corresponding **msrp** command from *running-config*. The command stops the MSRP agent when MSRP is no longer enabled on any interface.

Command Mode

Interface-Ethernet Configuration

Command Syntax

```
msrp
no msrp
default msrp
```

Example

These commands enable MSRP on Ethernet interface 3/3/3. Because it was not previously enabled on any other interface, the command launches the MSRP agent.

```
switch(config)#interface ethernet 3/3/3
switch(config-if-Et3/3/3)#msrp
Launching MSRP Agent
switch(config-if-Et3/3/3)#show active
  interface Ethernet3/3/3
  msrp
switch(config-if-Et3/3/3)#
```

These commands disable the MSRP agent on Ethernet interface 3/3/3. Because it is not enabled on any other interface, the command stops the MSRP agent.

```
switch(config-if-Et3/3/3)#no msrp
Stopping MSRP agent
switch(config-if-Et3/3/3)#show active
  interface Ethernet3/3/3
switch(config-if-Et3/3/3)#msrp
```

15.5.4.5 show msrp interfaces

The **show msrp interfaces** command displays station stream information for the specified station type, interfaces and streams.

Command Mode

EXEC

Command Syntax

```
show msrp interfaces [INTERFACE_NAME] STATION_TYPE_NAME [STREAMS]
```

Parameters

- **INTERFACE_NAME** Interface type and number. Values include:

- <no parameter> all Ethernet interfaces.
- ethernet *e_range* Ethernet interface list.
- **STATION_TYPE** Endpoint type. Values include:
 - talker Command displays data for talker station streams.
 - listeners Command displays data for listener station streams.
 - streams Command displays data for talker and listener station streams.

STREAMS Streams for which command displays information. Options include:

- <no parameter> all streams.
- *stream-id hex_string* specifies the stream command for which command displays information.

Valid *e_range* formats include number, range, or comma-delimited list of numbers and ranges.

Valid *hex_string* formats include <H>, <H.H>, <H.H.H>, or <H.H.H.H>, where H is a four-digit hex number that ranges from 0 to FFFF.

Example

- This command displays data for listener station streams on Ethernet interfaces 1 and 2.

```
switch(config)#show msrp interfaces ethernet 1-2 listeners
Legend
-----
AskFail : Listener Asking Failed      Rdy      : Listener Ready
RdyFail : Listener Ready Failed

          Listeners
  Port    Stream Id          Dec      Dir
  -----
Et1       0000.0000.0000.002a  AskFail  Tx
          0000.0000.0000.029a  RdyFail  Rx
          0000.0000.0000.038f  AskFail  Rx

Et2       0000.0000.0000.002a  AskFail  Rx
          0000.0000.0000.029a  RdyFail  Rx
          0000.0000.0000.038f  AskFail  Tx

switch(config)#
```

- This command displays data for talker station streams on Ethernet interfaces 1 and 2.

```
switch(config)#show msrp interfaces ethernet 1-2 talkers
Legend
-----
Adv      : Talker Advertise          Fail     : Talker Fail

          Talkers
```

Port	Stream Id	Dec	Dir	FailCode
Et1	0000.0000.0000.002a	Adv	Rx	--
	0000.0000.0000.038f	Fail	Tx	7
Et2	0000.0000.0000.002a	Adv	Tx	--
	0000.0000.0000.038f	Adv	Rx	7

switch(config)#

15.5.4.6 show msrp streams

The **show msrp streams** command displays configuration and status information on the specified MSRP streams.

Command Mode

EXEC

Command Syntax

```
show msrp streams [STREAM_NAME] [INFO_LEVEL]
```

Parameters

- **STREAMS** Streams for which command displays information. Options include:
 - <no parameter> all streams.
 - **stream-id** *hex_string* specifies the stream command for which command displays information.

Valid *hex_string* formats include <H>, <H.H>, <H.H.H>, or <H.H.H.H>, where H is a four-digit hex number that ranges from **0** to **FFFF**.

- **INFO_LEVEL** type of information that the command displays. Options include:
 - <no parameter> command displays stream identification information.
 - **detail** command displays identification and transmission characteristics.
 - **propagation** command displays ingress and egress port information.

Examples

- This command displays stream identification information.

```
switch(config)#show msrp interfaces streams
Legend
-----
Adv      : Talker Advertise      Fail      : Talker Fail

Stream Id          DMAC                Port      Dec      Vlan  Class  Bandwidth
-----
0000.0000.0000.002a 00:11:22:33:44:55 Et1       Adv      24      A      8000kbps
0000.0000.0000.029a 22:33:44:55:66:77 --        --      4095    A      0kbps
0000.0000.0000.038f 11:22:33:44:55:66 Et2       Adv      119     B      1000kbps

switch(config)#
```

- This command displays stream identification and status information.

```
switch(config)#show msrp streams detail
Legend
-----
Adv      : Talker Advertise      Fail      : Talker Fail

Stream Id          DMAC                Port      Dec      Vlan  Class  Bandwidth
-----
0000.0000.0000.002a 00:11:22:33:44:55 Et1       Adv      24      A      8000kbps
                    Latency (nsec): 800
                    Max Frame Size: 1522
                    Max Interval Frames: 2

0000.0000.0000.029a 22:33:44:55:66:77 --        --      4095    A      0kbps
                    Latency (nsec): 0
                    Max Frame Size: 1100
                    Max Interval Frames: 3

switch(config)#
```

- This command displays stream ingress and egress port information.

```
switch(config)#show msrp streams propagation
Legend
-----
Adv      : Talker Advertise      Fail      : Talker Fail
```

```

AskFail : Listener Asking Failed      Rdy      : Listener Ready
RdyFail : Listener Ready Failed

Stream Id          DMAC          Port      Dec      Vlan Class Bandwidth
-----
0000.0000.0000.002a 00:11:22:33:44:55 Et1        Adv      24   A    8000kbps

  Talker Propagation:
    Ingress      Ingress      Propagated      Propagated      Egress
    Dec          Port          Dec             Port            Dec
    -----
    Adv          --> Et1          --> Adv          --> Et2          --> Adv
                                     --> Et4          --> Adv
                                     --> Et5          --> Adv

  Listener Propagation:
    Egress      Egress      Propagated      Listener      Ingress
    Dec          Port          Dec             Port            Dec
    -----
    AskFail <-- Et1          <-- AskFail <-- Et2          <-- AskFail
    AskFail <-- Et4          <-- AskFail
    AskFail <-- Et5          <-- AskFail

0000.0000.0000.029a 22:33:44:55:66:77 --          --          4095 A    0kbps

  Talker Propagation:
    Ingress      Ingress      Propagated      Propagated      Egress
    Dec          Port          Dec             Port            Dec
    -----

  Listener Propagation:
    Egress      Egress      Propagated      Listener      Ingress
    Dec          Port          Dec             Port            Dec
    -----
    RdyFail <-- Et1          <-- RdyFail
    RdyFail <-- Et2          <-- RdyFail

0000.0000.0000.038f 11:22:33:44:55:66 Et2        Adv      119  B    1000kbps

  Talker Propagation:
    Ingress      Ingress      Propagated      Propagated      Egress
    Dec          Port          Dec             Port            Dec
    -----
    Adv          --> Et2          --> Fail          --> Et1          --> Fail

  Listener Propagation:
    Egress      Egress      Propagated      Listener      Ingress
    Dec          Port          Dec             Port            Dec
    -----
    AskFail <-- Et2          <-- AskFail <-- Et1          <-- Rdy

switch(config)#

```

15.5.4.7 show msrp

The **show msrp** command displays MSRP operational information for the specified interfaces.

Command Mode

EXEC

Command Syntax

```
show MVRP [ INTERFACE_NAME]
```

Parameters

- **INTERFACE_NAME** Interface type and number. Values include
 - <no parameter> all Ethernet interfaces.
 - interfaces ethernet *e_range* Ethernet interface list.
 Valid *e_range* formats include number, range, or comma-delimited list of numbers and ranges.

Example

- This command displays the MSRP status for Ethernet interfaces 41 through 43.

```
switch(config)#show msrp interfaces ethernet 41-43

MSRP Global Status : Enabled
Max Frame Size : 1522
Max Fan-In Ports : No limit

Class Supported Priority Delta Bandwidth
-----
  A           Y       3      75%
  B           Y       2       0%

Legend
-----
Adv       : Talker Advertise           Fail       : Talker Fail
AskFail   : Listener Asking Failed     Rdy        : Listener Ready
RdyFail   : Listener Ready Failed

  Admin   Sr      Class Oper State      Talkers   Listeners   Bandwidth
  Port   State Pvid  Class Oper State      Adv  Fail  Rdy  AskFail  Allocated
-----
Et41 Active   5      A  Boundary      1     0     1     0     200kbps
          B  Core           0     0     0     1     100kbps
Et42 Active   3      A  Core           0     0     1     1     50kbps
          B  WaitingForPeer 1     0     0     0     20kbps
Et43 Disabled 3

switch(config)#
```

15.5.4.8 show mvrp

The **show mvrp** command displays MVRP operational information for the specified interfaces.

Command Mode

EXEC

Command Syntax

```
show MVRP [INTERFACE_NAME]
```

Parameters

- **INTERFACE_NAME** Interface type and number. Values include
 - <no parameter> all Ethernet interfaces.
 - **interfaces ethernet** *e_range* Ethernet interface list.

Valid *e_range* formats include number, range, or comma-delimited list of numbers and ranges.

Example

- This command displays the MVRP status for Ethernet interfaces 30 through 40.

```
switch(config)#show mvrp interfaces Ethernet 30-40

MVRP Global Status : Enabled

Port      Admin State   Registered Vlans  Declared Vlans
-----
Et30      Disabled
Et31      Disabled
Et32      Disabled
Et33      Disabled
Et34      Active
Et35      Disabled
Et36      Disabled
Et37      Disabled
Et38      Disabled
Et39      Disabled
Et40      Disabled

switch(config)#
```

Virtual Extensible LANs (VXLANs)

This chapter describes Arista's Virtual Extensible LAN (VXLAN) implementation. Sections in this chapter include:

- [VXLAN Introduction](#)
- [VXLAN Description](#)
- [VXLAN Configuration](#)
- [VXLAN Command Descriptions](#)

16.1 VXLAN Introduction

Virtual Extensible LAN (VXLAN) is a networking technology that encapsulates MAC-based Layer 2 Ethernet frames within Layer 3 UDP packets to aggregate and tunnel multiple layer 2 networks across a Layer 3 infrastructure. VXLAN scales up to 16 million logical networks and supports layer 2 adjacency across IP networks. Multicast transmission architecture is used for broadcast, multicast, and unknown unicast traffic.

For a list of VXLAN feature support in a specific EOS release, consult the appropriate release notes here: <https://www.arista.com/en/support/software-download>.

For a list of VXLAN feature support by platform in the latest EOS release, see <https://www.arista.com/en/support/product-documentation/supported-features>

 **Note:** VXLAN and NAT cannot co-exist.

16.2 VXLAN Description

These sections describe VXLAN architecture, the data objects that comprise a VXLAN network, and process of bridging packets through a VXLAN network.

- [VXLAN Architecture](#)
- [VXLAN Processes](#)
- [Multicast and Broadcast over VXLAN](#)
- [VXLAN Gateway](#)
- [VXLAN and MLAG](#)
- [VXLAN Bridging and Routing Support](#)
- [Data Structures](#)

16.2.1 VXLAN Architecture

The VXLAN architecture extends an L2 network by connecting VLANs from multiple hosts through UDP tunnels called VXLAN segments. VXLAN segments are identified by a 24-bit virtual network identifier (VNI). Within a host, each VLAN whose network is extended to other hosts is associated with a VNI. An extended L2 network comprises the devices attached to VLANs from all hosts that are on VLANs that are associated with the same VNI.

The following figure displays the data objects that comprise a VXLAN implementation on a local host.

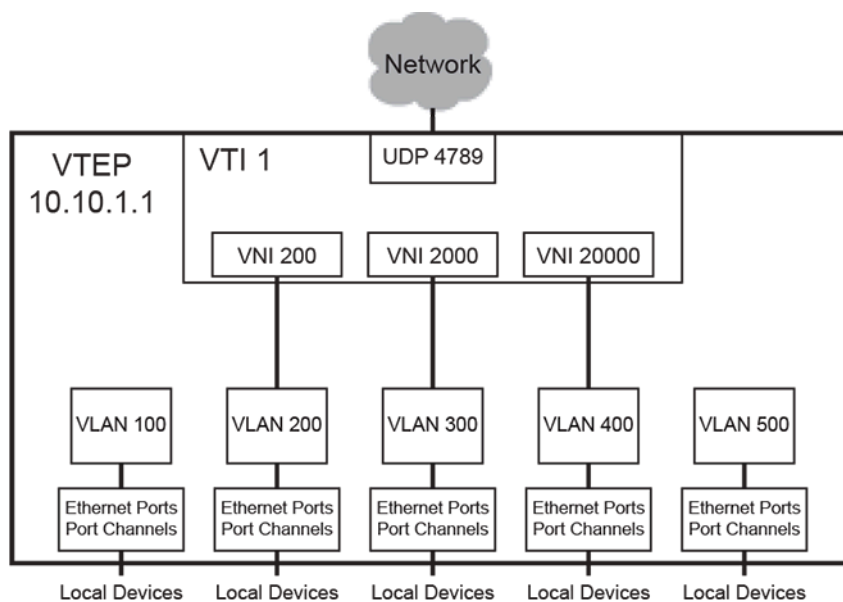

Figure 65: VXLAN Architecture

- **VXLAN Tunnel End Point (VTEP):** a host with at least one VXLAN Tunnel Interface (VTI).
- **VXLAN Tunnel Interface (VTI):** a switchport linked to a UDP socket that is shared with VLANs on various hosts. Packets bridged from a VLAN to the VTI are sent out the UDP socket with a VXLAN header. Packets arriving on the VTI through the UDP socket are demuxed to VLANs for bridging.
- **Virtual Network Identifier (VNI):** a 24-bit number that distinguishes between the VLANs carried on a VTI. It facilitates the multiplexing of several VLANs over a single VTI.

VNIs can be expressed in digital or dotted decimal formats. VNI values range from 1 to 16777215 or from 0.0.1 to 255.255.255.

The network in the figure above has the following assignments:

- VTEP IP address of 10.10.1.1
- UDP port of 4789
- One VTI that supports three VXLAN segments (UDP tunnels): VNI 200, VNI 2000, and VNI 20000
- Five VLANs, of which three VLANs can communicate with remote devices over Layer 2.

16.2.2 VXLAN Gateway

A VXLAN gateway is a service that exchanges VXLAN data and packets with devices connected to different network segments. VXLAN traffic must pass through a VXLAN gateway to access services on physical devices in a distant network.

A VXLAN gateway requires the following information:

- An IP address that is designated as the VXLAN interface source.
- VLAN to VNI mapping.
- VTEP list for each VNI.
- A method for handling broadcast, unknown unicast, and multicast (BUM) packets.

Arista switches manually perform VXLAN gateway services. The switch connects to VXLAN gateways that serve other network segments. MAC address learning is performed in hardware from inbound VXLAN packets.

16.2.3 VXLAN Processes

When a packet enters a VLAN from a member (ingress) port, the VLAN learns the source address by adding an entry to the MAC address table that associates the source to the ingress-port. The VLAN then searches the table for destination address. If the MAC address table lists the address, the packet is sent out the corresponding port. If the MAC address table does not list the address, the packet is flooded to all ports except the ingress port.

VXLANS extend VLANs through the addition of a VXLAN address table that correlates remote MAC addresses to their port and resident host IP address. Packets that are destined to a remote device are sent to the VXLAN tunnel interface (VTI), which is the switchport that is linked to the UDP socket. The packet is encapsulated with a VXLAN header which includes the VNI associated with the VLAN and the IP mapping of the destination host. The packet is sent through a UDP socket to the destination VTEP IP. The VTI on the remote host extracts the original packet and bridges it to the VLAN associated with the VNI on the remote host.

UDP port 4789 is recognized as the VXLAN socket and listed as the destination port on the UDP packets. The UDP source port field is filled with a hash of the inner header to facilitate load balancing.

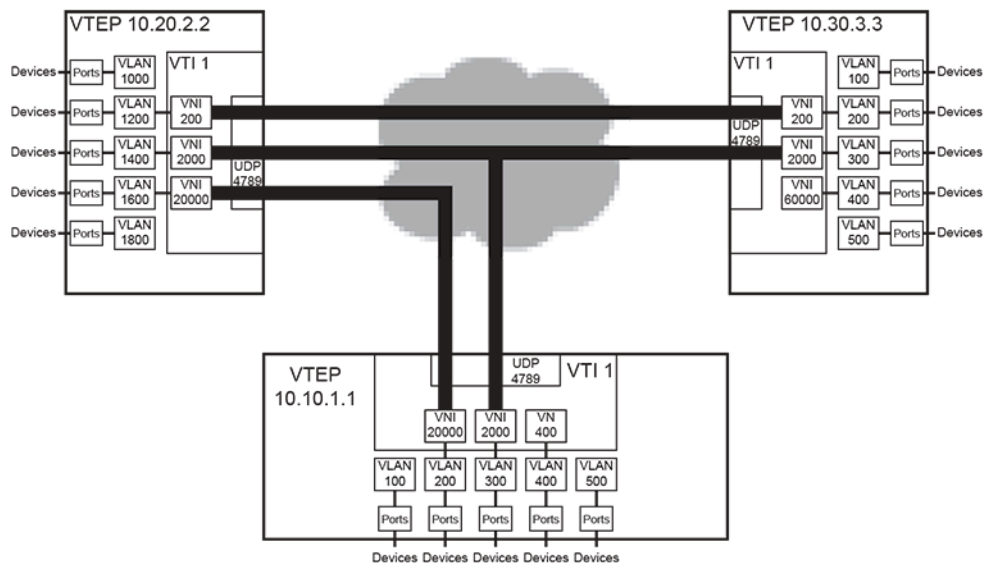

Figure 66: XLAN Implementation

The figure above displays a configuration that includes three VTEPs. The VXLAN defines three inter-host L2 networks. The VLANs that comprise the networks include:

- VNI 200: VTEP 10.20.2.2: VLAN 1200 and VTEP 10.30.3.3: VLAN 200
- VNI 2000: VTEP 10.10.1.1: VLAN 300, VTEP 10.20.2.2: VLAN 1400, and VTEP 10.30.3.3: VLAN 300
- VNI 20000: VTEP 10.10.1.1: VLAN 200, and VTEP 10.20.2.2: VLAN 1600

VXLAN Routing

VXLAN routing is enabled by creating a VLAN interface on the VXLAN-enabled VLAN and assigning an IP address to the VLAN interface. The IP address serves as VXLAN gateway for devices that are accessible from the VXLAN-enabled VLAN.

16.2.4 Multicast and Broadcast over VXLAN

These sections describe multicast and broadcast over VXLANs. Multicast packet flooding describes broadcast and multicast transmission by associating a multicast group to a VTI through a configuration command.

Head-end Replication (HER) optimizes flooding of inter VTEP broadcast, unknown unicast and broadcast (BUM) traffic by using hardware and flood lists to perform replication on the supported platform.

- [Multicast Packet Flooding](#)
- [Head-end Replication](#)

16.2.4.1 Multicast Packet Flooding

Multicast packet flooding is supported with VXLAN bridging without MLAG. A VTI is associated with a multicast group through a configuration command.

VXLAN and Broadcast

When a VLAN receives or sends a broadcast packet the VTI is treated as a bridging domain L2 interface. The packet is sent from this interface on the multicast group associated with the VTI. The VTIs on remote VTEPs that receive this packet extract the original packet, which is then handled by the VLAN associated with the packet's VNI. The VLAN floods the packet, excluding the VTI. When the broadcast results in a response, the resulting packet can be unicast back to the originating VTEP because the VXLAN address table obtained the host MAC to VTEP association from the broadcast packet.

VXLAN and Multicast

A VTI is treated as an L2 interface in the VLAN for handling multicast traffic, which is mapped from the VLAN to the multicast group associated with the VTI. All VTEPs join the configured multicast group for inter-VTEP communication within a VXLAN segment; this multicast group is independent of any other multicast groups that the hosts in the VLAN join.

The IP address space for the inter-host VXLAN communication may be sourced from a different VRF than the address space of the hosts in the VLAN. The multicast group for inter-VTEP transmissions must not be used for other purposes by any device in the VXLAN segment space.

16.2.4.2 Head-end Replication

Head-end replication uses a flood list to support broadcast, unknown unicast, and multicast (BUM) traffic over VXLAN. The flood list specifies a list of remote VTEPs. The switch replicates BUM data locally for bridging across the remote VTEPs specified by the flood list. This data flooding facilitates remote MAC address learning by forwarding data with unknown MAC addresses.

Head-end replication is required for VXLAN routing and to support VXLANs over MLAG.

16.2.5 VXLAN and MLAG

VXLAN over MLAG provides redundancy in hardware VTEPs. VTI configuration must be identical on each MLAG peer for them to act as a single VTEP. This also prevents the remote MAC from flapping between the remote VTEPs by ensuring that the rest of the network sees a host that is connected to the MLAG interface as residing behind a single VTEP.

Differences between VXLAN bridging and routing implementations over MLAG are applicable for the DCS-7050X series platform.

- VXLAN routing recirculates a packet twice, with the first iteration performing the routing action involving an L2 header rewrite, and the second recirculation performing VXLAN encap and decap operations. Recirculation is achieved by MAC loopback on dedicated loopback interfaces.
- The configuration for VXLAN routing on an MLAG VTEP includes separate Recirc-Channel configuration on both peers. The virtual IP, virtual MAC, and virtual VARP VTEP IP addresses are identical on both peers.

The following VTI elements must be configured identically on both MLAG peers:

- VLAN-VNI mappings
- VTEP IP address of the source loopback interface
- Flood VTEP list used for head-end replication

If OSPF is also in use, configure the OSPF router ID manually to prevent the switch from using the common VTEP IP address as the router ID.

The following rules are observed by MLAG switches so that they behave as a single VXLAN VTEP:

- Only the MLAG peer that receives a packet performs VXLAN encapsulation on it.
- Packets are not VXLAN encapsulated if they are received from the peer link.
- If a packet is decapsulated and sent over the peer link, it should not be flooded to active MLAG interfaces.
- If a packet is sent over the peer link to the CPU, it is not head-end replicated to other remote VTEPs.
- If a packet's destination is the VTEP IP address, it is terminated by the MLAG peer that receives it.

Example

These commands complete the configuration required for a VXLAN routing deployment.

```
switch(config)#interface Vxlan1
switch(config-if-Vx1)#vxlan source-interface Loopback0
switch(config-if-Vx1)#vxlan udp-port 4789
switch(config-if-Vx1)#vxlan vlan 2417 vni 8358534
switch(config-if-Vx1)#vxlan flood vtep 1.0.1.1 1.0.2.1
switch(config-if-Vx1)#interface Vlan2417
switch(config-if-Vl2417)#ip address 1.0.4.1/24
switch(config-if-Vl2417)#interface Loopback0
switch(config-if-Lo0)#ip address 1.0.1.1/32
switch(config-if-Lo0)#ip routing
switch(config)#interface Recirc-Channel627
switch(config-if-Re627)#switchport recirculation features vxlan
switch(config-if-Re627)#interface Ethernet 1
switch(config-if-Et1)#traffic-loopback source system device mac
switch(config-if-Et1)#channel-group recirculation 627
switch(config-if-Et1)#exit
switch(config)#interface Ethernet 2
switch(config-if-Et2)#traffic-loopback source system device mac
switch(config-if-Et2)#channel-group recirculation 627
switch(config-if-Et2)#
```

show running interface Loopback allows remote VTEP tunnels to be routed over L3 interfaces.

```
switch#show running interface Loopback298
interface Loopback298
  ip address 1.0.1.1/32
switch#
switch#show running interface Ethernet54/1.4095
interface Ethernet54/1.4095
  mtu 9214
  encapsulation dot1q vlan 267
  ip address 1.0.4.1/24
switch#
switch#show running interface Port-Channel1.4095
interface Port-Channel1.4095
  mtu 9214
  encapsulation dot1q vlan 1043
  ip address 1.0.88.1/24
switch#
```

```

switch#show running interface Vxlan1
interface Vxlan1
  vxlan source-interface Loopback298
  vxlan udp-port 4789
  vxlan vlan 2156 vni 15613244
  vxlan vlan 2393 vni 3610141
  vxlan vlan 2156 flood vtep 1.0.2.1 1.0.3.1
  vxlan vlan 2393 flood vtep 1.0.2.1 1.0.3.1
switch#
switch#show port-channel
Port Channel Port-Channel1:
  Active Ports: Ethernet51/1
switch#
switch#show ip route
VRF: default
Codes: C - connected, S - static, K - kernel,
       O - OSPF, IA - OSPF inter area, E1 - OSPF external type 1,
       E2 - OSPF external type 2, N1 - OSPF NSSA external type 1,
       . . .
       . . .
S       1.0.2.1/32 [1/0] via 1.0.4.2, Ethernet54/1.4095
S       1.0.3.1/32 [1/0] via 1.0.88.2, Port-Channel1.4095

```

There are 2 remote VTEPs configured 1.0.2.1, and 1.0.3.1. The remote VTEP 1.0.2.1 is reachable through Ethernet54/1.4095 and remote VTEP 1.0.3.1 is reachable through port-channel1.4095.

Configuring Unconnected Ethernet Interfaces for Recirculation

On systems where bandwidth is not fully used by the front panel ports, unused bandwidth is used for recirculation.

The following example is applicable to the DCS-7050X series platform.

Example

These commands expose unconnected Ethernet interfaces which are used for recirculation, in order to use them to replace or use along with front panel Ethernet interfaces.

```

switch(config)#service interface unconnected expose
switch(config)#interface UnconnectedEthernet 2
switch(config-if-Ue2)#traffic-loopback source system device mac
switch(config-if-Ue2)#channel-group recirculation 627

```

The following example enables display of the inactive interfaces using the show command.

Example

```

switch(config)#service interface inactive expose

```

Running a show command generates the following output:

```

switch(config)#switch(config)#sho int et21/1-4 stat

```

Port	Name	Status	Vlan	Duplex	Speed	Type	Flags
	Encapsulation						
Et21/1		connected	1	full	100G	100GBASE-CR4	
Et21/2		inactive	1	full	25G	100GBASE-CR4	
Et21/3		inactive	1	full	25G	100GBASE-CR4	
Et21/4		inactive	1	full	25G	100GBASE-CR4	

On previous releases, Ethernet21/2,21/4 do not exist and the output would be the following:

```
switch(config) #switch(config) #sho int et21/1-4 stat
```

Port	Name	Status	Vlan	Duplex	Speed	Type	Flags
	Encapsulation						
Et21/1		connected	1	full	100G	100GBASE-CR4	
Et21/3		inactive	1	full	25G	100GBASE-CR4	

16.2.6 VXLAN Bridging and Routing Support

Describes the support of VXLAN Bridging and Routing on the R3 series of DCS 7280, 7500, and 7800 Arista switches.

16.2.6.1 Platform Compatibility

VXLAN Bridging and Routing support is available on the following R3 Series platforms:

- DCS-7280R3
- DCS-7500R3 Linecards
- DCS-7800R3 Linecards

16.2.6.2 Differences with DCS-7500R2 Implementation

The following are notable differences with respect to implementation of VXLAN on the R3 Series of switches.

- There is no need to configure the VXLAN-routing TCAM profile to enable VXLAN routing on the R3 Series switches. The command is still accepted for backward compatibility reasons.
- CPU bound traffic after VXLAN decapsulation (such as routing protocol packets) use the same CoPP queues used by the non VXLAN decapsulated packets. This is an improvement over the R2 series behavior where the CPU bound traffic after VXLAN decapsulation took a different CoPP queue that was shared with other IP Unicast packets.

16.2.6.3 Limitations

There is no EVPN VxLAN Multicast (Type 6/7/8 NLRI) support.

16.2.7 Data Structures

VXLAN implementation requires two VXLAN tables and a MAC address table accommodation.

16.2.7.1 MAC Address Table VXLAN Support

MAC address table entries correlate MAC addresses with the port upon which packets arrive. In addition to Ethernet and port channels, the port column may specify a VTI for packets that arrive on a VLAN from a remote port through the VXLAN segment.

16.2.7.2 VTEP-MAC Address Table

VTEP-MAC address table entries correlate MAC address with the IP address of the VTEP from where packets bearing the MAC address arrive. The VTI uses this table to determine the destination address for packets that are sent to remote hosts.

16.2.7.3 VNI-VLAN Map

The VNI-VLAN map displays the one-to-one correspondence between the VNIs assigned on the switch and the VLANs to which they are assigned. Each VNI can be assigned to only one VLAN; each VLAN can be assigned a maximum of one VNI. Each VNI-VLAN assignment constitutes a VXLAN segment.

16.3 VXLAN Configuration

These sections describe VXLAN configuration tasks:

- [Configuring the VTI](#)
- [Head End Replication Configuration](#)
- [VXLAN Routing Configuration](#)
- [Configuring VXLAN Routing with Overlay VRFs](#)
- [Configuring VXLAN over MLAG](#)
- [Configuring VXLAN Control Service](#)
- [Configuring VXLAN Multicast Decapsulation](#)
- [VXLAN Rules Support for Mirror ACLs Configuration](#)
- [Configuring EVPN VXLAN](#)
- [Displaying VXLAN Configuration](#)
- [Displaying VXLAN Bridging and Routing Support](#)

16.3.1 Configuring the VTI

Configuring the VTI enables VXLAN bridging and is a requirement for VXLAN Routing. The following sections describe the steps required to enabling VXLAN bridging by bringing up the VXLAN line protocol. [VXLAN Routing Configuration](#) describes the additional steps required to enable VXLAN routing.

Instantiating the VTI and VXLAN Configuration Mode

The `interface vxlan` command places the switch in VXLAN-interface configuration mode for modifying the specified VXLAN tunnel interface (VTI). The command also instantiates the interface if it was not previously created.

VXLAN interface configuration mode is not a group change mode; `running-config` is changed immediately after commands are executed. The `exit` command does not affect the configuration.

Example

These commands create VXLAN tunnel interface 1, place the switch in VXLAN-interface configuration mode, and display parameters of the new VTI.

```
switch(config)#interface vxlan 1
switch(config-if-Vx1)#show active
interface Vxlan1
  vxlan udp-port 4789
switch(config-if-Vx1)#
```

Assigning an IP address to the VTEP

The `vxlan source-interface` command specifies the loopback interface from which the VTEP derives the source address (IP) that it uses when exchanging VXLAN frames. This address is used by UDP headers to specify source and destination addresses of hosts that send or receive VXLAN encapsulated packets.

There is no default source interface assignment. A valid VXLAN configuration requires the assignment of a loopback interface to the VTEP and the assignment of a valid IP address to the specified interface.

Example

These commands configure VTI 1 to use IP address 10.25.25.3 (loopback interface 15) as the source interface in the encapsulation fields of outbound VXLAN frames.

```
switch(config)#interface loopback 15
switch(config-if-Lo15)#ip address 10.25.25.3/24
switch(config-if-Lo15)#exit
switch(config)#interface vxlan 1
switch(config-if-Vx1)#vxlan source-interface loopback 15
switch(config-if-Vx1)#show active
interface Vxlan1
    vxlan source-interface Loopback15
    vxlan udp-port 4789
switch(config-if-Vx1)#
```

Assigning a UDP Port to the VTEP

Packets bridged to the VTI from a VLAN are encapsulated with a VXLAN header, then sent through a pre-configured UDP port. Packets that arrive through this port are assumed to be VXLAN encapsulated and sent to the bridging domain of the recipient VLAN as determined by the VNI in the VXLAN header and the VNI-VLAN map.

The `vxlan udp-port` command associates a UDP port with the configuration mode VXLAN interface (VTI). By default, UDP port 4789 is associated with the VTI.

 **Note:** UDP port 4789 is reserved by convention for VXLAN usage. Under most typical applications, this parameter should be set to the default value.

Examples

- This command associates UDP port 5500 with VXLAN interface 1.

```
switch(config)#interface vxlan 1
switch(config-if-Vx1)#vxlan udp-port 5500
switch(config-if-Vx1)#show active
interface Vxlan1
    vxlan udp-port 5500
switch(config-if-Vx1)#
```

- This command resets the VXLAN interface 1 UDP port association of 4789.

```
switch(config-if-Vx1)#no vxlan udp-port
switch(config-if-Vx1)#show active
interface Vxlan1
    vxlan udp-port 4789
switch(config-if-Vx1)#
```

Assigning a VNI to a VLAN

When a VLAN bridges a packet to the VTI, the packet is encapsulated with a VXLAN header that includes the VNI associated with the VLAN. Packets that arrive on the VTI's UDP socket are bridged to the VLAN that is associated with the VNI specified by the VXLAN header that encapsulates the packet.

The VTI requires a one-to-one correspondence between specified VLANs and VNI values. Commands that assign a new VNI to a previously configured VLAN replace existing VLAN assignment statements in **running-config**. Commands that attempt to assign a VNI value to a second VLAN generate a CLI error.

The `vxlan vlan vni` command associates a VLAN ID with a virtual network identifier (VNI).

Example

These commands associate VLAN 100 to VNI 100 and VLAN 200 to VNI 10.10.200.

```
switch(config)#interface vxlan 1
switch(config-if-Vx1)#vxlan vlan 100 vni 100
switch(config-if-Vx1)#vxlan vlan 200 vni 10.10.200
switch(config-if-Vx1)#show active
interface Vxlan1
  vxlan udp-port 4789
  vxlan vlan 200 vni 658120
  vxlan vlan 100 vni 100
switch(config-if-Vx1)#vxlan vni notation dotted
switch(config-if-Vx1)#show active
interface Vxlan1
  vxlan udp-port 4789
  vxlan vlan 100 vni 0.0.100
  vxlan vlan 200 vni 10.10.200
switch(config-if-Vx1)#
```

Verifying the VXLAN Configuration

The `show interface vxlan 1` displays the configuration and connection status of the VXLAN

Example

This command indicates that the VXLAN line protocol status is *up*.

```
switch(config-if-Vx1)#show interface vxlan 1
Vxlan1 is up, line protocol is up (connected)
  Hardware is Vxlan
  Source interface is Loopback15 and is active with 10.25.25.3
  Static vlan to vni mapping is
    [100, 0.0.100]    [200, 10.10.200]
switch(config-if-Vx1)#
```

16.3.2 Head End Replication Configuration

Head-end replication is a data distribution method that supports broadcast, unknown unicast traffic over VXLANs by replicating BUM data locally for transmission to the set of remote VTEPs specified by a flood list. This data flooding facilitates remote MAC address learning through the forwarding of data with unknown MAC addresses.

Each `vxlan flood vtep` statement in `running-config` associates a set of VTEP addresses to an access VNI. A default flood list is also configurable that applies to all VNIs for which a flood list is not configured.

The VTEP flood list is created and modified through the `vxlan flood vtep` command.

Examples

- These commands create a default VXLAN head-end replication flood list.

```
switch(config)#interface vxlan 1
switch(config-if-Vx1)#vxlan flood vtep 10.1.1.1 10.1.1.2
switch(config-if-Vx1)#show active
interface Vxlan1
  vxlan flood vtep 10.1.1.1 10.1.1.2
  vxlan udp-port 4789
switch(config-if-Vx1)#
```

- These commands create VXLAN head-end replication flood lists for the VNIs accessed through VLANs 101 and 102.

```
switch(config-if-Vx1)#vxlan vlan 101-102 flood vtep 11.1.1.1 11.1.1.2
11.1.1.3
switch(config-if-Vx1)#show active
interface Vxlan1
  vxlan flood vtep 10.1.1.1 10.1.1.2
  vxlan vlan 101 flood vtep 11.1.1.1 11.1.1.2 11.1.1.3
  vxlan vlan 102 flood vtep 11.1.1.1 11.1.1.2 11.1.1.3
  vxlan udp-port 4789
switch(config-if-Vx1)#
```

16.3.3 VXLAN Routing Configuration

- [Implementing VXLAN Routing](#)
- [Configuring Direct VXLAN Routing](#)
- [Configuring VXLAN VTEP counters](#)
- [VXLAN Auto Flood-List Construction](#)

16.3.3.1 Implementing VXLAN Routing

VXLAN routing is enabled by creating a VLAN interface (SVI) on a VLAN that is associated to a VNI. In the figure below, VXLAN routing is enabled on Switch A by configuring a VLAN interface with an IP address of 10.10.10.1. Packets from Devices A-1 and B-2 that have destinations other than 10.10.10.0/28 are VXLAN-bridged to the default gateway (10.10.10.1), then routed from Switch A.

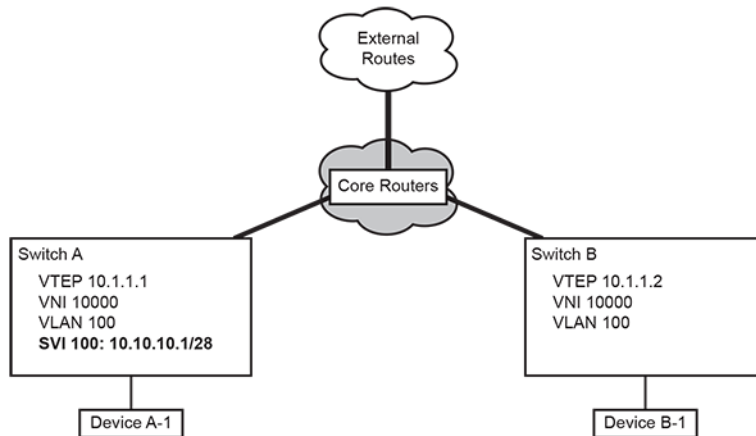

Figure 67: Implementing VXLAN Routing

Example

These commands configure Switch A to perform VXLAN routing. The example includes OSPF routing that is used for underlay routing.

```
switch-A(config)#route-map vxlanvlan permit 10
switch-A(config-route-map-vxlanvlan)#match interface loopb5
switch-A(config-route-map-vxlanvlan)#exit
switch-A(config)#route-map vxlanvlan permit 20
switch-A(config-route-map-vxlanvlan)#match interface vlan 100
switch-A(config-route-map-vxlanvlan)#exit
switch-A(config)#router ospf 1
switch-A(config-router-ospf)#redistribute connected route-map vxlanvlan
switch-A(config-router-ospf)#exit
switch-A(config)#interface loopback 5
```

```

switch-A(config-if-Lo5) #ip address 10.25.25.3/24
switch-A(config-if-Lo5) #exit
switch-A(config) #interface vxlan 1
switch-A(config-if-Vx1) #vxlan source-interface loopback 5
switch-A(config-if-Vx1) #vxlan vlan 100 vni 10000
switch-A(config) #interface vlan 100
switch-A(config-if-Vl100) #ip address 10.10.10.1/28
switch-A(config-if-Vl100) #exit

```

16.3.3.2 Configuring Direct VXLAN Routing

Figure [Implementing VXLAN Routing](#) , VXLAN routing is enabled on Switch A only; Switch B supports VXLAN bridging. Traffic from Switch B devices to the external routes must go through the core route twice: once as they are bridged to is VXLAN gateway and once when routed to its next hop device.

Direct VXLAN routing with VXLAN enabled addresses this issue by configuring each VTEP with all VLANs. This allows packets to be VXLAN-bridged to a local VTEP and routed to remote VTEPs. Indirect routing scales well but is complex to engineer efficiently, and naked routing provides the same scalability to indirect routing. Direct routing leads to the most efficient traffic flows, with the number of virtual subnets or virtual machines increasing at scale, and is thereby optimal from a data plane viewpoint.

The following sections describe conventions required to implement Direct VXLAN Routing, then presents a direct VXLAN routing implementation.

Configuring VARP addresses

For direct routing, an anycast IP address is used as the gateway address on the SVI for a VLAN on all hardware VTEPs associated with that VLAN.

Examples

- These commands configure an IP virtual-router and virtual MAC address.

```

switch(config) #interface Vlan2417
switch(config-if-Vl2417) #ip address 1.0.4.50/24
switch(config-if-Vl2417) #ip virtual-router address 1.0.4.1
switch(config-if-Vl2417) #ip virtual-router mac-address 00:00:11:11:2
2:22
switch(config) #

```

- These commands configure an IP virtual address (instead of IP virtual-router address) for the VLAN SVI, and a secondary address on the loopback interface for the virtual VTEP IP. The virtual VTEP IP is the logical VTEP hosting the virtual MAC address.

```

switch(config) #interface Vlan2417
switch(config-if-Vl2417) #ip address virtual 1.0.4.1/24
switch(config-if-Vl2417) #exit
switch(config) #interface Loopback0
switch(config-if-Lo0) #ip address 1.0.1.1/32
switch(config-if-Lo0) #ip address 1.0.1.2/32 secondary
switch(config-if-Lo0) #ip virtual-router mac-address 00:00:11:11:22:22
switch(config) #

```

Virtual IP and MAC Addresses

Virtual-router IP addresses can be configured on VLAN interfaces in addition to a primary address. All VTEPs in a direct VXLAN network can be configured with the same virtual router address. This allows devices to use a common IP address as their VXLAN gateway.

The `ip address virtual` command configures a specified address as the primary IPv4 address and as a virtual IP address for the configuration mode VLAN interface. This results in the virtual MAC address (`ip virtual-router mac-address`) assignment to the VLAN interface. In large VXLAN networks, using distinct primary IP addresses for each VTEP limits the number addresses on its subnet for connected hosts. Defining a common virtual IP address for all VTEPs and using that their primary addresses conserves subnet addresses

Example

These commands specify a virtual router address of 00:00:00:00:00:48 for the switch and, for VLAN 100, a primary address of 10.10.10.10/28 and a virtual IP address of 10.10.10.10.

```
switch(config)#ip virtual-router mac-address 00:00:00:00:00:48
switch(config)#interface vlan 100
switch(config-if-Vl100)#ip address virtual 10.10.10.10/28
switch(config-if-Vl100)#show active
  interface Vlan100
    ip address virtual 10.10.10.10/28
switch(config-if-Vl100)#
```

Virtual VTEP Configuration

A virtual VTEP address is specified by configuring a secondary address on the loopback interface designated as the VXLAN's source interface. All VTEPs in the direct routing topology share the same virtual VTEP address.

You must also configure the secondary VTEP IP on the flood-list of the downstream VXLAN VTEPS as shown below.

Example

These commands specify a primary (10.1.1.1) and virtual VTEP address (10.2.2.2).

```
switch1
switch(config)#interface loopback 5
switch(config-if-Lo5)#ip address 10.1.1.1/24
switch(config-if-Lo5)#ip address 10.2.2.2/24 secondary
switch(config-if-Lo5)#show active
  interface Loopback5
    ip address 10.1.1.1/24
    ip address 10.2.2.2/24 secondary
switch(config-if-Lo5)#exit
switch(config)#interface vxlan 1
switch(config-if-Vx1)#vxlan source-interface loopback 5
switch(config-if-Vx1)#show active
  interface Vxlan1
    vxlan source-interface Loopback5
    vxlan udp-port 4789
    vxlan vlan 100 vni 10000
switch(config-if-Vx1)#

switch2
switch(config)#interface vxlan1
switch(config-if-Vx1)#vxlan flood vtep 10.1.1.1
switch(config-if-Vx1)#vxlan flood vtep 10.2.2.2
```

Direct VXLAN Topology

The following figure displays a direct VXLAN topology, where each VTEP is configured with the same set of VNIs, VLAN interfaces, and virtual VTEP address.

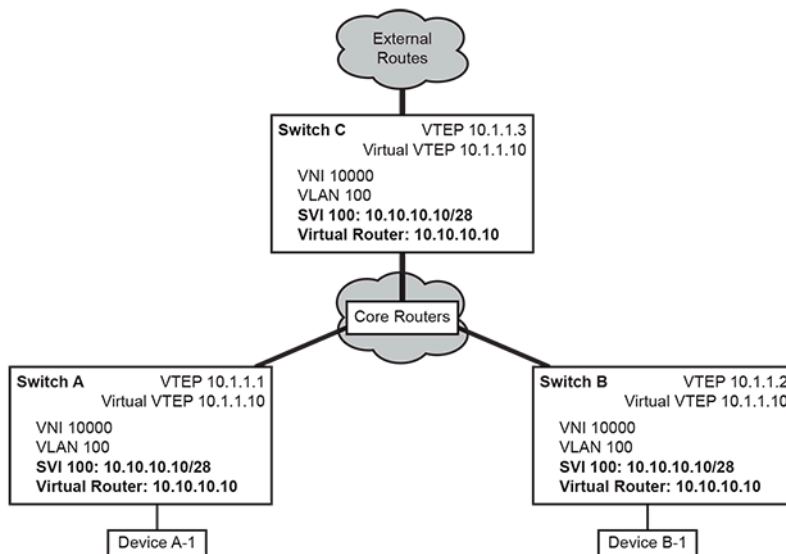

Figure 68: Direct VXLAN Routing

Example

These commands configure VXLAN parameters for Switch-A.

```
switch-A(config)#route-map vxlanvlan permit 10
switch-A(config-route-map-vxlanvlan)#match interface loopb5
switch-A(config-route-map-vxlanvlan)#exit
switch-A(config)#route-map vxlanvlan permit 20
switch-A(config-route-map-vxlanvlan)#match interface vlan 100
switch-A(config-route-map-vxlanvlan)#exit
switch-A(config)#router ospf 1
switch-A(config-router-ospf)#redistribute connected route-map vxlanvlan
switch-A(config-router-ospf)#exit
switch-A(config)#ip virtual-router mac-address 00:00:00:00:00:48
switch-A(config)#interface loopback 5
switch-A(config-if-Lo5)#ip address 10.1.1.3/24
switch-A(config-if-Lo5)#ip address 10.1.1.10/24 secondary
switch-A(config-if-Lo5)#exit
switch-A(config)#interface vxlan 1
switch-A(config-if-Vxl)#vxlan source-interface loopback 5
switch-A(config-if-Vxl)#vxlan vlan 100 vni 10000
switch-A(config)#interface vlan 100
switch-A(config-if-Vl100)#ip address virtual 10.10.10.10/28
switch-A(config-if-Vl100)#exit
```

16.3.3.3 Configuring VXLAN VTEP Counters

The switch platforms which use this feature are:

- DCS-7050X
- DCS-7250X
- DCS-7300X

The VXLAN VTEP counters feature enables a device to count VXLAN packets received and sent by the device on a per VTEP basis. Specifically, it enables the device to count bytes and packets that are getting encapsulated and decapsulated as they are passing through.

The counters are logically split up in the two VXLAN directions. Encapsulated on the device and directed to the core, “encap” counters count packets coming from the edge. Decapsulated on the device and heading towards the edge, “decap” counters count packets coming from the core.

To be able to count VXLAN packets the device has to support VXLAN and have a VXLAN interface correctly configured.

Examples

- This command configures the enabling of VXLAN VTEP counters for encap.

```
switch(config)#hardware counter feature vtep encap
switch(config)#
```

- This command configures the disabling of VXLAN VTEP counters for encap.

```
switch(config)#no hardware counter feature vtep encap
switch(config)#
```

- This commands configures the enabling of VXLAN VTEP counters for decap.

```
switch(config)#hardware counter feature vtep decap
switch(config)#
```

- This commands configures the disabling of VXLAN VTEP counters for decap.

```
switch(config)#no hardware counter feature vtep decap
switch(config)#
```

16.3.3.4 VXLAN Auto Flood-List Construction

With the introduction of wireless access points (APs), VXLAN flood-lists learned from the data-plane is added to or removed from the flood-lists created in the control-plane. When a VXLAN packet is received on a new VNI from a VTEP, it is added to the dynamic flood-list for that VNI and the flood-list is merged with flood-lists from other sources. When all MACs behind a remote VTEP have been removed through aging, for example, the remote VTEP is removed from all dynamic VXLAN flood-lists.

To restrict VTEPs from being added to dynamic flood-lists, when VXLAN traffic is received from untrusted sources, use the `vxlan learn-restrict` command. MAC learning is disabled from the specified IP ranges. The learning restrictions is placed on all platforms including APs.

VXLAN Configuration for Learning Data-plane Flood-lists

The following example is applicable to all platforms.

These commands enable VXLAN flood-lists learning from data-plane.

```
switch(config)#interface Vxlan1
switch(config-if-Vx1)#vxlan flood vtep learned data-plane
```

The following example restricts learning from VTEPs not in a prefix range.

```
switch(config-if-Vx1)#vxlan learn-restrict vtep <prefixes>
```

The following example restricts learning to VTEPs with IP in range.

```
switch(config-if-Vx1)#vxlan learn-restrict vtep 1.1.1.1/24
```

The following command shows the VXLAN flood-lists programmed in hardware.

```
switch(config) #switch(config) #show vxlan flood vtep
```

The following command shows the dynamic VXLAN flood-lists.

```
switch(config) #switch(config) #show l2Rib input vxlan-dynamic
```

The following command shows the VXLAN flood-lists sent to platform.

```
switch(config) #switch(config) #show l2Rib output floodset
```

The following command shows the VXLAN learning restrictions for all VLANs.

```
switch(config) #switch(config) #show vxlan learn-restrict vtep
```

The following command shows the VXLAN learning counters for all VLANs.

```
switch(config) #switch(config) #show vxlan counters learn-restrict all
```

16.3.4 Configuring VXLAN Routing with Overlay VRFs

The switch platforms which use this feature are:

- DCS-7050X
- DCS-7250X
- DCS-7300X

VXLAN SVIs configured in non-default VRFs are supported with VXLAN routing using overlay VRFs. Overlay SVIs are configured in non-default VRFs but underlay SVIs, which provide IP connectivity between VTEPs, must remain in the default VRF. VXLAN routing is deployable by allowing users to configure separate overlay routing domains using VRFs per tenant, thereby allowing support for overlapping IP addresses in the overlay. This provides separation between overlay and underlay traffic, including simpler and cleaner protocol configuration, without using complicated route-maps to control distribution of prefixes to peers in the overlay VRFs and underlay SVIs. IPv4 based VXLAN routing is currently supported.

16.3.5 Configuring VXLAN over MLAG

VTI configuration must be identical on each MLAG peer for them to act as a single VTEP.

The following VTI elements must be configured identically on both MLAG peers:

VLAN-VNI Mappings

Configure identical VLAN to VNI mappings on both MLAG peers using the `vxlan vlan vni` command.

Example

These commands associate VLAN 100 to VNI 100 and VLAN 200 to VNI 10.10.200.

```
switch(config) #interface vxlan 1
switch(config-if-Vx1) #vxlan vlan 100 vni 100
switch(config-if-Vx1) #vxlan vlan 200 vni 10.10.200
switch(config-if-Vx1) #
```

VTEP IP Address of the Source Loopback Interface

Configure the same VTEP IP address for the source loopback interface on both MLAG peers using the `vxlan source-interface` command.

Example

These commands configure a primary VTEP address.

```
switch(config)#interface loopback 5
switch(config-if-Lo5)#ip address 10.1.1.1/24
switch(config-if-Lo5)#exit
switch(config)#interface vxlan 1
switch(config-if-Vx1)#vxlan source-interface loopback 5
switch(config-if-Vx1)#
```

Flood VTEP List

Configure the same VTEP flood list on both MLAG peers using the `vxlan flood vtep` command.

Example

These commands create a default VXLAN head-end replication flood list.

```
switch(config)#interface vxlan 1
switch(config-if-Vx1)#vxlan flood vtep 10.1.1.1 10.1.1.2
switch(config-if-Vx1)#
```

OSPF Configuration

If OSPF is in use, configure the OSPF router ID using the `router-id (OSPFv2)` command to prevent the switch from using the common VTEP IP address as the router ID.

Example

These commands assign 10.0.0.1 as the OSPFv2 router ID.

```
switch(config)#router ospf 100
switch(config-router-ospf)#router-id 10.0.0.1
switch(config-router-ospf)#
```

16.3.6 Configuring VXLAN Control Service

The VXLAN Control Service (VCS) provides a mechanism by which hardware VTEPs share states between each other in order to establish VXLAN tunnels, without the need for a multicast control plane. This feature enables the use of a VCS client.

Examples

- These commands connect a switch to the VCS running on CVX. The server host IP address is the management IP address of the CVX controller or the IP address that CVX is listening on for client connections.

```
switch(config)#management cvx
switch(config-mgmt-cvx)#server host 172.27.6.248
switch(config-mgmt-cvx)#no shutdown
switch(config-mgmt-cvx)#
```

- These commands configure the VXLAN interface, except for the multicast group configuration, in order to learn from the controller.

```
switch(config)#interface vxlan 1
switch(config-if-Vx1)#vxlan controller-client
switch(config-if-Vx1)#
```

16.3.7 Configuring VXLAN Multicast Decapsulation

The switch platforms which use this feature are:

- DCS-7050X
- DCS-7250X
- DCS-7300X

VXLAN multicast decapsulation enables VTEPs that support Head End Replication (HER). Multicast encapsulated Broadcast/Unknown/Multicast (BUM) packets terminate VTEPs from remote VTEPs that do not support HER.

Examples

- These commands enable VXLAN multicast decapsulation.

```
switch(config)#interface vxlan 1
switch(config-if-Vx1)#vxlan multicast-group decap 230.1.1.1
switch(config-if-Vx1)#
```

- These commands disable VXLAN multicast decapsulation.

```
switch(config)#interface vxlan 1
switch(config-if-Vx1)#no vxlan multicast-group decap 230.1.1.1
switch(config-if-Vx1)#
```

16.3.8 VXLAN Rules Support for Mirror ACLs Configuration

The switch platforms which use this feature are:

- DCS-7150S

VXLAN rules support for mirror ACLs configuration permit VXLAN deep inspection rules to be specified in the mirroring ACLs when the switch is operating in normal mode.

Examples

The following are examples of VXLAN rules specified in mirroring ACLs.

- These commands permit all VXLAN traffic (udp protocol and destination port 4789).

```
switch(config)#ip access-list miracl
switch(config-acl-miracl)#permit vxlan any any
switch(config-acl-miracl)#
```

- These commands permit VXLAN traffic with vni 1001 only.

```
switch(config)#ip access-list miracl
switch(config-acl-miracl)#permit vxlan any any vni 1001 0x000000
switch(config-acl-miracl)#
```

- These commands deny VXLAN traffic with vni 0x1000 through 0x100f.

```
switch(config)#ip access-list miracl
switch(config-acl-miracl)#permit vxlan any any vni 0x1000 0x100f
```



```
switch(config-acl-miracl)#
```

16.3.9 Configuring EVPN VXLAN

Supported Configurations

EOS Release 4.23.1

1. [Static EVPN VXLAN Config.](#)
2. [VXLAN Bridging Config.](#)
3. Introduces the `ip virtual-router router-mac` command.

EOS Release 4.23.2

1. IPv6 overlay.
2. [VARP and Virtual VTEP with VxLAN routing.](#)
3. EVPN VXLAN (Single Active - No Multihoming support).
4. VXLAN with MLAG.

EOS Release 4.24.1

[Overlay Multicast using VXLAN underlay multicast tree.](#)

EOS Release 4.24.2F

[EVPN VXLAN All Active Multihoming.](#)

16.3.9.1 Static EVPN VxLAN Configuration

```
switch(config)#service routing protocols model multi-agent
switch(config)#interface Loopback0
switch(config-if-Lo0)#ip address 172.16.1.1/32
!
switch(config)#interface Vxlan1
switch(config-if-Vx1)#vxlan source-interface Loopback0
switch(config-if-Vx1)#vxlan udp-port 4789
switch(config-if-Vx1)#vxlan vrf test vni 12345
!
switch(config)#ip routing vrf test
switch(config)#Ipv6 unicast-routing vrf test
!
switch(config)#ip route vrf test 192.168.1.0/24 vtep 10.1.1.2 vni 20000
router-mac-address 00:00:78:01:00:00
switch(config)#ipv6 route vrf test 1:0:5::0/64 vtep 10.1.1.2 vni 30000
router-mac-address 00:00:80:01:00:00
```

16.3.9.2 VxLAN Bridging and Routing Configuration

```
switch(config)#interface Loopback0
switch(config-if-Lo0)#ip address 172.16.1.1/32
!
switch(config)#ip virtual-router mac-address 00:02:03:04:05:06
!

switch(config)#ip routing
!
switch(config)#interface Vxlan1
```

```
switch(config-if-Vx1) #vxlan source-interface Loopback0
switch(config-if-Vx1) #vxlan udp-port 65330
switch(config-if-Vx1) #vxlan vlan 300 vni 945438
switch(config-if-Vx1) #vxlan vlan 200 vni 654677
switch(config-if-Vx1) #vxlan flood vtep 172.16.1.2 172.16.1.3 172.16.1.1
```

16.3.9.3 EVPN VxLAN All Active Multihoming

Multi-homing is activated in an EVPN environment by assigning an ethernet segment identifier to the participating Ethernet or Port-Channel interfaces.

```
switch(config) #interface Ethernet1
switch(config-if-Et1) #evpn ethernet-segment
switch(config-evpn-es) #identifier 00aa:bbbb:cccc:dddd:eeee
switch(config-evpn-es) #route-target import 12:23:34:45:56:67
```

The optional `designated-forwarder election hold-time` command can configure a wait time before selecting the designated forwarder and allow potential forwarders a chance to advertise their EVPN ethernet segment (type 4) routes. The default hold time is three (3) seconds, as specified in section 8.5 of [RFC7432](#) [1].

The route target configured here is the ES import route target described in section 7.6 of [RFC7432](#) [1]. It can be set to any MAC address, but for each Ethernet segment every participating interface in the network must use the same ES import route target. A suggested value is the MAC address of the CE connected to the multi-homing PEs via this interface.

16.3.9.4 VARP and Virtual VTEP with VXLAN Routing

```
interface Loopback0
  ip address 172.16.1.1/32
  ip address 20.0.0.1/32 secondary
  !
ip virtual-router mac-address 00:02:03:04:05:06
  !
ip routing
  !
interface Vlan200
  ipv6 address 2000:0:0:41::2/64
  ip address virtual 1.0.7.1/24
  ipv6 virtual-router address 2000:0:0:41::1
  !
interface Vxlan1
  vxlan source-interface Loopback0
  vxlan udp-port 65330
  vxlan vlan 300 vni 945438
  vxlan vlan 200 vni 654677
  vxlan flood vtep 172.16.1.2 172.16.1.3 172.16.1.1 20.0.0.1
```

16.3.9.5 Overlay Multicast using VxLAN Underlay Multicast Tree

To inject a source route, configure the `ip multicast source route export` command on the incoming interface.

```
switch(config) #interface Vlan10
switch(config-Vl10) #ip pim sparse-mode
switch(config-Vl10) #ip multicast source route export
```

To redistribute the source routes in the MRIB via BGP while running multi-agent protocol model, configure the **redistribute attached-host** command for the IPv4 multicast address-family. Activate the neighbor to establish a BGP connection.

```
switch(config-router-bgp) #address-family ipv4 multicast
switch(config-router-bgp-af) #neighbor 3.0.0.2 activate
switch(config-router-bgp-af) #redistribute attached-host
```

To redistribute the source routes in the URIB via BGP while running ribd protocol model, configure the **redistribute attached-host** command under the **router bgp** mode.

```
switch(config-router-bgp) #redistribute attached-host
```

This following is a sample configuration for a VTEP for the setup above using multi-agent protocol model.

```
switch(config) #service routing protocol model multi-agent

switch(config) #ip pim rp-address 15.15.15.15 225.1.1.1/32

switch(config) #interface Loopback0
switch(config-if-Lo0) #ip address 1.1.1.1/32

switch(config) #interface vxlan1
switch(config-if-Vx1) #vxlan source-interface Loopback0
switch(config-if-Vx1) #vxlan vlan10 vni 10000

! Interface to the underlay
switch(config) #interface Ethernet1
switch(config-if-Et1) #ip address 3.0.0.1/24
switch(config-if-Et1) #ip pim sparse-mode

switch(config) #interface vlan10
switch(config-if-Vl10) #ip address 10.1.1.1/24
switch(config-if-Vl10) #ip pim sparse-mode
switch(config-if-Vl10) #ip multicast source route export

switch(config) #router bgp 10
switch(config-router-bgp) #router-id 0.0.0.2

switch(config-router-bgp) #address-family ipv4 multicast
switch(config-router-bgp-af) #neighbor 3.0.0.2 activate
switch(config-router-bgp-af) #redistribute attached-host
```

This following is a sample configuration for a VTEP for the setup above using the ribd protocol model.

```
switch(config) #service routing protocol model ribd

switch(config) #ip pim rp-address 15.15.15.15 225.1.1.1/32

switch(config) #interface Loopback0
switch(config-if-Lo0) #ip address 1.1.1.1/32

switch(config) #interface vxlan1
switch(config-if-Vx1) #vxlan source-interface Loopback0
switch(config-if-Vx1) #vxlan vlan10 vni 10000

! Interface to the underlay
switch(config) #interface Ethernet1
switch(config-if-Et1) #ip address 3.0.0.1/24
```

```

switch(config-if-Et1) #ip pim sparse-mode

switch(config) #interface vlan10
switch(config-if-Vl1) #ip address 10.1.1.1/24
switch(config-if-Vl1) #ip pim sparse-mode
switch(config-if-Vl1) #ip multicast source route export

switch(config) #router bgp 10
switch(config-router-bgp) #router-id 0.0.0.2
switch(config-router-bgp) #redistribute attached-host

```

16.3.10 Displaying VXLAN Configuration

The following section describes the commands that control the display format of VNIs and the commands that list VXLAN configuration and transmission information.

Configuring VNI Display Format

The `vxlan vni notation dotted` command configures the switch to display VNIs in dotted decimal notation. VNI values range from 1 to 16777215 in decimal notation and from 0.0.1 to 255.255.255 in dotted decimal notation.

The command affects the VNI number display in all `show` commands, including `show running-config`. Commands that include VNI as a parameter may use decimal or dotted decimal notation regardless of the setting of this command. By default, show commands display VNI number in decimal notation.

Examples

- These commands configure the switch to display vni numbers in dotted decimal notation, then displays a configuration that includes a VNI setting.

```

switch(config) #vxlan vni notation dotted
switch(config) #interface vxlan 1
switch(config-if-Vx1) #show active
interface Vxlan1
    vxlan udp-port 4789
    vxlan vlan 333 vni 3.4.5
switch(config-if-Vx1) #

```

- These commands configure the switch to display vni numbers in decimal notation, then displays a configuration that includes a VNI setting.

```

switch(config) #no vxlan vni notation dotted
switch(config) #interface vxlan 1
switch(config-if-Vx1) #show active
interface Vxlan1
    vxlan udp-port 4789
    vxlan vlan 333 vni 197637
switch(config-if-Vx1) #

```

MAC Address Table

The MAC address table indicates a MAC address from a device on a remote host by indicating Vx interface as the port that corresponds to the address.

Example

The `show mac address-table` command displays a MAC address table that includes entries of devices from remote hosts by specifying Vx1 as the corresponding port.

```
switch> show mac address-table
Mac Address Table
-----
Vlan    Mac Address          Type      Ports    Moves    Last Move
-----
 1      0050.5682.6725      DYNAMIC  Et16     1        0:02:01 ago
 1      0050.568e.58e9      DYNAMIC  Et23     2        0:08:53 ago
 1      0050.56a0.474a      DYNAMIC  Et16     1        0:18:04 ago
51      0000.0051.0004      DYNAMIC  Et5      1        12 days, 1:02:44 ago
51      0000.0051.0005      DYNAMIC  Et5      1        12 days, 1:02:44 ago
51      0000.0051.0101      DYNAMIC  Vx1      1        12 days, 0:17:30 ago
51      0000.0051.0102      DYNAMIC  Vx1      1        12 days, 0:17:30 ago
61      0000.0061.0005      DYNAMIC  Et5      1        12 days, 1:02:44 ago
Total Mac Addresses for this criterion: 8

Multicast Mac Address Table
-----
Vlan    Mac Address          Type      Ports
-----
Total Mac Addresses for this criterion: 0
switch>
```

VXLAN MAC Address Table

VXLAN MAC address table entries correlate MAC addresses accessible through remote VTEPs with the local VLAN and the IP address of the VTEP through which the addressed device is accessed. The VTI uses this table when constructing the VXLAN encapsulation to specify the destination IP address of the recipient VTEP and the VNI segment through which the device's remote VLAN is accessed.

The `show vxlan address-table` command displays the VXLAN MAC address table.

Example

This command displays the VXLAN address table.

```
switch> show vxlan address-table
Vxlan Mac Address Table
-----
Vlan    Mac Address          Type      Prt  Vtep          Moves    Last Move
-----
 51     0000.0051.0101      DYNAMIC  Vx1  10.25.2.12    1        4 days, 0:37:14 ago
 51     0000.0051.0102      DYNAMIC  Vx1  10.25.2.12    1        4 days, 0:37:14 ago
 51     0000.0051.0103      DYNAMIC  Vx1  10.25.2.12    1        4 days, 0:37:14 ago
 51     0000.0051.0104      DYNAMIC  Vx1  10.25.2.12    1        4 days, 0:37:14 ago
 51     0000.0051.0105      DYNAMIC  Vx1  10.25.2.12    1        4 days, 0:37:14 ago
 61     0000.0061.0103      DYNAMIC  Vx1  10.25.2.12    1        4 days, 0:37:14 ago
 61     0000.0061.0104      DYNAMIC  Vx1  10.25.2.12    1        4 days, 0:37:14 ago
 61     0000.0061.0105      DYNAMIC  Vx1  10.25.2.12    1        4 days, 0:37:14 ago
switch>
```

VXLAN MAC Address Table

The `show vxlan vtep` command displays information about remote VTEPs that the configured VTI has discovered and with whom it has exchanged packets.

Example

These commands display the VTEPs that have exchanged data with the configured VTI.

```
switch>show vxlan vtep
Remote vteps for Vxlan1:
10.52.2.12
Total number of remote vteps: 1
```

```
switch>
```

VXLAN Counters

The `clear vxlan counters` command resets the VXLAN counters. The `show vxlan counters` command displays the VXLAN counters.

Example

This command displays the VXLAN counters

```
switch>show vxlan counters software
encap_bytes:3452284
encap_pkts:27841
encap_read_err:1
encap_discard_runt:0
encap_discard_vlan_range:0
encap_discard_vlan_map:0
encap_send_err:0
encap_timeout:1427
decap_bytes_total:382412426
decap_pkts_total:2259858
decap_bytes:0
decap_pkts:0
decap_runt:0
decap_pkt_filter:45128
decap_bytes_filter:5908326
decap_discard_vxhdr:0
decap_discard_vlan_map:2214730
decap_timeout:0
decap_sock_err:1
switch>
```

16.3.11 Displaying VXLAN Bridging and Routing Support

All show commands applicable to prior VXLAN implementations on R2 series are also available on R3 series for VXLAN debugging.

The `show interfaces vxlan` command displays operational status and configuration information of the specified VXLAN.

```
switch(config)#show interfaces vxlan 1
Vxlan1 is up, line protocol is up (connected)
  Hardware is Vxlan
  Source interface is Loopback0 and is active with 172.16.1.1
  Replication/Flood Mode is headend with Flood List Source: CLI
  Remote MAC learning via Datapath
  VNI mapping to VLANs
  Static VLAN to VNI mapping is
    [100, 100]
  Note: All Dynamic VLANs used by VCS are internal VLANs.
    Use 'show vxlan vni' for details.
  Static VRF to VNI mapping is not configured
  Headend replication flood vtep list is:
    100 172.16.1.2 10.1.1.1
  MLAG Shared Router MAC is 0000.0000.0000
  VTEP address mask is Non
```

The `show arp` command displays all ARP tables on the configured VXLAN.

```
switch(config)#show arp interface vxlan 1
```

```

Address          Age (sec)  Hardware Addr  Interface
192.168.10.1    -         0000.abab.abab  Vlan100, Vxlan1

```

The **show arp interface summary** command displays a summary of all ARP tables on the configured VXLAN.

```

switch(config)#show arp interface vxlan 1 summary
Total: 1
Static: 1
Dynamic: 0
Not learned: 0

```

The **show vxlan counters software** command displays the VXLAN software counters.

```

switch(config)#show vxlan counters software
Rx bytes for encapsulation           : 0
Rx pkts for encapsulation            : 0
Rx high priority bytes for encapsulation : 0
Rx high priority pkts for encapsulation : 0
Rx low priority bytes for encapsulation  : 0
Rx low priority pkts for encapsulation   : 0
....

```

```

switch(config)#show vxlan vni
VNI to VLAN Mapping for Vxlan1
VNI          VLAN          Source          Interface          802.1Q Tag
-----
100          100          static          Ethernet2/1       untagged
                                   Vxlan1           100

```

Note: * indicates a Dynamic VLAN

The **show vxlan vtep** command displays information about remote VTEPs that the configured VTI has discovered and with whom it has exchanged packets.

```

switch(config)#show vxlan vtep
Remote VTEPS for Vxlan1:
10.1.1.1
Total number of remote VTEPS: 1

```

```

switch(config)#show platform fap vxlan vtep encapsulation
Tunnel Type: R(Vxlan-Routing), B(Vxlan-Bridging)
D - ECMP is divergent across switching chips
-----
|                                     VTEP Table                                     |
|-----|
|                                     FEC                                     |
|-----|
|                                     EEDB                                     |
|-----|
| Destination | Ecmp| Fec|Tunnel|Tunnel|  Arp|SIP|TTL| Cmd | Destination | VID | MAC / CPU |
| Code       |     |   |Type |Type |   |   |   |   |             |    |           |
|           |     |   |     |     |   |   |   |   |             |    |           | |
|---|---|---|---|---|---|---|---|---|---|---|---|---|
| 10.1.1.1 | -  |353900| 16382|   | B|65536| 0| 64|ROUTE| Et1/1 | 1006 | 00:00:aa:aa:a |
| a:aa |   |     |     |   |   |   |   |   |             |    |           |
| 10.1.1.1 | -  |353901| 16383|   | R|65536| 0| 64|ROUTE| Et1/1 | 1006 | 00:00:aa:aa:a |
| a:aa |   |     |     |   |   |   |   |   |             |    |           |
|-----|

```

```

switch(config)#show cpu counters queue | grep Vxlan

```

CoppSystemVxlanEncap	0	0	0	0
CoppSystemVxlanVtepLearn	0	0	0	0
CoppSystemVxlanEncap	0	0	0	0
CoppSystemVxlanVtepLearn	0	0	0	0

```
switch(config)#show platform fap vxlan mapping vni
  VNI      | VSI
-----+-----
      100 | 100
```

```
switch#show platform pkt | egrep -i "vxlan|vni"
rxpaccllog 0 rxraccllog 0 rxvteplearn 0 rxvxlan_encap 0
rx_vxlanbfd 0 rxcfm 0
rxvteprestore_drop 0 rxvxlan_encap_drop 0 rxmpc_nodev 0 rx_vxlanbfderr 0
rx_nonvxlan_arp_drop 0
fab.rvxvlan_decaperr 0 rx_macsecproxyerr 0 rx_macsecproxy_prune 0
CpuCodeVxlanVtepLearn: 0
CpuCodeVxlanEncapRequired: 0
CpuCodeVxlanArp: 0
CpuCodeVxlanUnknownVtepArp: 0
vxlan : sys_port -1 traffic_class 0 fdma - fapid 0 sflow_cookie 0
mark4 0000 mark6 0000 D
vxlan vni hashtable:
h: 201, i: 0, vni: 100, vlanid: 100
vxlan enabled vlans: 100,
```

use the

```
switch#show cpu counters vxlan l2 ecmp
VTEP Group      Member VTEP IP      ECMP      ECMP      Member      Next Level
ID              Size      FEC ID      FEC ID      FEC ID
-----
1              172.16.1.2    2          1          91752     353907
                10.1.1.1     91753     353908
```

16.4 VXLAN Command Descriptions

VXLAN Global Configuration Commands

- [interface vxlan](#)
- [ip address virtual](#)
- [vxlan vni notation dotted](#)

VXLAN Interface Configuration Commands

- [vxlan flood vtep](#)
- [vxlan multicast-group decap](#)
- [vxlan source-interface](#)
- [vxlan udp-port](#)
- [vxlan vlan vni](#)

VXLAN Bridging and Routing Commands

- [designated-forwarder election hold-time](#)
- [ip multicast source route export](#)
- [redistribute attached-host](#)
- [show arp](#)
- [show interfaces vxlan](#)

VXLAN Display and Clear Commands

- [clear vxlan counters](#)
- [show arp](#)
- [show interfaces vxlan](#)
- [show service vxlan](#)
- [show vxlan address-table](#)
- [show vxlan counters](#)
- [show vxlan flood vtep](#)
- [show vxlan vtep](#)

16.4.1 clear vxlan counters

The `clear vxlan counters` command resets the VXLAN counters.

Command Mode

Privileged EXEC

Command Syntax

```
clear vxlan counters ROUTE_TYPE
```

Parameters

- `ROUTE_TYPE` Specifies the type of VXLAN counter reset by the command.
 - `software` Command resets software counters.
 - `varp` Command resets virtual-ARP counters.

Related Commands

- [show vxlan counters](#) displays the VXLAN counters.

Example

This command resets the VXLAN counters

```
switch# clear vxlan counters software
switch# show vxlan counters software
encap_bytes:0
encap_pkts:0
encap_read_err:0
encap_discard_runt:0
encap_discard_vlan_range:0
encap_discard_vlan_map:0
encap_send_err:0
encap_timeout:0
decap_bytes_total:0
decap_pkts_total:0
decap_bytes:0
decap_pkts:0
decap_runt:0
decap_pkt_filter:0
decap_bytes_filter:0
decap_discard_vxhdr:0
decap_discard_vlan_map:0
decap_timeout:0
decap_sock_err:0
switch#
```

16.4.2 designated-forwarder election hold-time

The optional **designated-forwarder election hold-time** command can configure a wait time before selecting the designated forwarder and allow potential forwarders a chance to advertise their EVPN ethernet segment (type 4) routes. The **no** and **default** forms of the command removes the election hold time.

Command Mode

EVPN Ethernet segment identifier configuration mode

Command Syntax

```
designated-forwarder election hold-time sec
```

```
no designated-forwarder election hold-time sec
```

```
default designated-forwarder election hold-time sec
```

Parameters

sec Number of seconds for the timer waiting to receive updates from other PE. Range 0 -1800.

Example

```
switch(config) #interface Ethernet1  
switch(config-if-Et1) #evpn ethernet-segment  
switch(config-evpn-es) #designated-forwarder election hold-time 20
```

16.4.3 interface vxlan

The **interface vxlan** command places the switch in VXLAN-interface configuration mode for modifying the specified VXLAN tunnel interface (VTI). The command also instantiates the interface if it was not previously created.

VXLAN interface configuration mode is not a group change mode; **running-config** is changed immediately after commands are executed. The **exit** command does not affect the configuration.

The **no interface vxlan** deletes the specified VTI interface, including its configuration statements, from **running-config**. The **default interface vxlan** command removes all configuration statements for the specified VTI from **running-config** without deleting the interfaces.

Command Mode

Global Configuration

Command Syntax

```
interface vxlan vx_range
no interface vxlan vx_range
default interface vxlan vx_range
```

Parameter

- *vx_range* VXLAN interface number. The only permitted value is 1.

Commands Available in link-flap Configuration Mode

- [vxlan source-interface](#)
- [vxlan udp-port](#)
- [vxlan vlan vni](#)

Examples

- These commands create VXLAN tunnel interface 1, place the switch in VXLAN-interface configuration mode, then display parameters of the new VTI.

```
switch(config)# interface vxlan 1
switch(config-if-Vx1)# show active
interface Vxlan1
  vxlan udp-port 4789
switch(config-if-Vx1)#
```

- This command exits VXLAN-interface configuration mode, placing the switch in global configuration mode.

```
switch(config-if-Vx1)# exit
switch(config)#
```

16.4.4 ip address virtual

The `ip address virtual` command configures a specified address as the primary IPv4 address and as a virtual IP address for the configuration mode VLAN interface. The address resolves to the virtual MAC address configured through the `ip virtual-router mac-address` command. The command includes a subnet designation that is required in primary IP address assignments.

This command is typically used in VXLAN routing configurations as an alternative to assigning a unique IP address to each VTEP. All existing IPv4 addresses must be removed from the interface before executing this command.

The `no ip address virtual` and `default ip address virtual` commands remove the IPv4 address and virtual IP assignment from the configuration mode interface by deleting the `ip address virtual` command from *running-config*.

Removing the IPv4 address assignments from an interface disables IPv4 processing on that port.

Command Mode

Interface-VLAN Configuration

Command Syntax

```
ip address virtual ipv4_subnet
no ip address virtual
default ip address virtual
```

Parameters

- *ipv4_subnet* IPv4 and subnet address (CIDR or address-mask notation).

Related Commands

- `ip address`
- `ip virtual-router mac-address`

Example

This command configures 10.10.10.1 as the IPv4 address and virtual address for VLAN 100.

```
switch(config-if-Vl100) #show active
  interface Vlan100
    ip address virtual 10.10.10.1/28
switch(config-if-Vl100) #
```

16.4.5 ip multicast source route export

Use the `ip multicast source route export` command to inject a source route on the incoming interface.

Command Mode

Interface configuration mode

Command Syntax

```
ip multicast source route export num  
no ip multicast source route export num  
default ip multicast source route export num
```

Parameters

num Administrative distance for this route. Range **1-255**.

Example

```
switch(config)#interface Vlan10  
switch(config-Vl10)#ip pim sparse-mode  
switch(config-Vl10)#ip multicast source route export
```

16.4.6 redistribute attached-host

Use the `redistribute attached-host` to redistribute the source routes in the MRIB via BGP while running multi-agent protocol model for the IPv4 multicast address-family. This activates the neighbor to establish a BGP connection.

Command Mode

BGP router address-family configuration mode

Command Syntax

```
redistribute attached-host route-map name
```

```
no redistribute attached-host route-map name
```

```
default redistribute attached-host route-map name
```

Parameters

route-map *name* Name of the route map.

Example

```
switch(config-router-bgp) #address-family ipv4 multicast  
switch(config-router-bgp-af) #neighbor 3.0.0.2 activate  
switch(config-router-bgp-af) #redistribute attached-host
```

16.4.7 show arp

Use the **show arp** command to display and modify entries in the Address Resolution Protocol (ARP) cache.

Command Mode

EXEC

Command Syntax

```
show arp [ agent [ ipv4 | ipv6 ] | host name | A.B.C.D [ host | interface | mac-address | summary ] |  
interface [ Ethernet | Fabric | Loopback | Management | Port-Channel | Switch | Tunnel | Vlan | Vxlan ] |  
mac-address H.H.H | monitor [ summary | vrf ] | remote vlan | resolve [ host | interface | mac-address |  
A.B.C.D ] | summary total | vrf [ word | all ]]
```

Parameters

- **agent** ARP Agent information.
 - **ipv4** Details related to IPv4.
 - **ipv6** Details related to IPv6.
- **host *name*** Hostname filter name.
- ***A.B.C.D*** IP address filter.
 - **host** Hostname filter.
 - **interface** Interface selector.
 - **mac-address** MAC address filter.
 - **summary** Displays a summary of ARP entries.
- **interface** Interface selector.
 - **Ethernet** Ethernet interface.
 - **Fabric** Fabric interface.
 - **Loopback** Hardware interface used in looping packets.
 - **Management** Management interface.
 - **Port-Channel** Port-Channel sub interface.
 - **Switch** Switch interface.
 - **Tunnel** Tunnel interface.
 - **Vlan** Logical interface into a VLAN.
 - **Vxlan** VXLAN tunnel interface.
- **mac-address *H.H.H*** MAC address filter Ethernet address.
- **monitor** Monitored IP/IPv6 addresses.
 - **summary** Displays a summary of monitored IP/IPv6 addresses.
 - **vrf** Displays monitored IP/IPv6 addresses in a VRF.
- **remote vlan** Remote host bindings displaying information about the specified VLAN.
- **resolve** Resolves host names.
 - **host** Hostname filter.
 - **interface** Interface selector.
 - **mac-address** MAC address filter.
 - ***A.B.C.D*** IP address filter.
- **summary** Displays a summary of the ARP entries.
 - **total** Displays a count of the total ARP entries.
- **vrf** Displays ARP entries in a VRF.
 - ***word*** The VRF name.
 - **all** All virtual routing and forwarding instances.

Examples

- The **show interfaces vxlan** command displays operational status and configuration information of the specified VXLAN.

```
switch(config)#show interfaces vxlan 1
Vxlan1 is up, line protocol is up (connected)
Hardware is Vxlan
Source interface is Loopback0 and is active with 172.16.1.1
Replication/Flood Mode is headend with Flood List Source: CLI
Remote MAC learning via Datapath
VNI mapping to VLANs
Static VLAN to VNI mapping is
  [100, 100]
Note: All Dynamic VLANs used by VCS are internal VLANs.
      Use 'show vxlan vni' for details.
Static VRF to VNI mapping is not configured
Headend replication flood vtep list is:
  100 172.16.1.2 10.1.1.1
MLAG Shared Router MAC is 0000.0000.0000
VTEP address mask is Non
```

- The **show arp** command displays all ARP tables on the configured VXLAN.

```
switch(config)#show arp interface vxlan 1
Address      Age (sec)  Hardware Addr  Interface
192.168.10.1      -    0000.abab.abab  Vlan100, Vxlan1
```

- The **show arp interface summary** command displays a summary of all ARP tables on the configured VXLAN.

```
switch(config)#show arp interface vxlan 1 summary
Total: 1
Static: 1
Dynamic: 0
Not learned: 0
```

16.4.8 show interfaces vxlan

Use the **show interfaces vxlan** command to display the operational status and configuration information of the specified VXLAN.

Command Mode

EXEC

Command Syntax

```
show interfaces vxlan num
```

Parameters

num VXLAN tunnel interface number. Range 1-1.

Example

```
switch(config)#show interfaces vxlan 1
Vxlan1 is up, line protocol is up (connected)
  Hardware is Vxlan
  Source interface is Loopback0 and is active with 172.16.1.1
  Replication/Flood Mode is headend with Flood List Source: CLI
  Remote MAC learning via Datapath
  VNI mapping to VLANs
  Static VLAN to VNI mapping is
    [100, 100]
  Note: All Dynamic VLANs used by VCS are internal VLANs.
        Use 'show vxlan vni' for details.
  Static VRF to VNI mapping is not configured
  Headend replication flood vtep list is:
    100 172.16.1.2 10.1.1.1
  MLAG Shared Router MAC is 0000.0000.0000
  VTEP address mask is Non
```

16.4.9 show service vxlan

The **show service vxlan** command displays the status of the Vxlan Control Service (VCS) and the received (from all connected VTEPs) and advertised (to all connected VTEPs) MAC address reachability information.

Command Mode

EXEC

Command Syntax

```
show service vxlan [status | switch [SWITCH_TYPE] | vni [VNI_INFO]]
```

Parameters

- SWITCH_TYPE displayed by switch type. Options include:
 - word hostname, IP address, or ID of the switch.
 - all all switches.
- VNI_INFO displayed with VNI information. Options include:
 - advertised advertised MAC addresses.
 - received received MAC addresses.

Example

This command displays the status of the VCS.

```
switch(config)#show service vxlan status
Vxlan Controller Service is      : stopped
Mac learning                      : Control plane
Resync period                     : 300 seconds
Resync in progress               : No
Capability                        : VXLAN v4 overlay routing
                                  VXLAN v4 overlay indirect routing

fm319(config-if-Vx1)#show service vxlan status
Vxlan Controller Service is      : stopped
Mac learning                      : Control plane
Resync period                     : 300 seconds
Resync in progress               : No
Capability                        : VXLAN v4 overlay routing
                                  VXLAN v4 overlay indirect routing

switch(config)#
```

16.4.10 show vxlan address-table

The `show vxlan address-table` command displays the VXLAN address table. Entries are created by extracting information from packets received from remote VTEPs.

The VXLAN address table correlates MAC addresses that are accessible through remote VTEPs with the local VLAN and the IP address of the VTP through which the addressed device is accessible. The VTI uses this table when constructing the VXLAN encapsulation fields to specify the destination IP address of the recipient VTEP and the VNI segment through which the device's remote VLAN is accessed.

Command Mode

EXEC

Command Syntax

```
show vxlan address-table [ENTRY_TYPE][MAC_ADDR][VLANS][REMOTE_VTEP]
```

Parameters

- **ENTRY_TYPE** command filters display by entry type. Options include:
 - `<no parameter>` all table entries.
 - `configured` static entries; includes unconfigured VLAN entries.
 - `dynamic` entries learned through packet receipts.
 - `static` entries entered by CLI commands.
 - `unicast` entries with unicast MAC address.
- **MAC_ADDR** command uses MAC address to filter displayed entries.
 - `<no parameter>` all MAC addresses table entries.
 - `address mac_address` displays entries with specified address (dotted hex notation – H.H.H).
- **VLANS** command filters display by VLAN.
 - `<no parameter>` all VLANs.
 - `vlan v_num` VLAN specified by `v_num`.
- **REMOTE_VTEP** Filters entries by IP address of the remote VTEPs. Options include:
 - `<no parameter>` all items.
 - `vtep ipaddr_1 [ipaddr_2...ipaddr_n]` Identifies VTEPs by their IP address.

Example

This command displays the VXLAN address table.

```
switch>show vxlan address-table
      Vxlan Mac Address Table
-----
Vlan  Mac Address      Type      Prt  Vtep          Moves  Last Move
----  -
51    0000.0051.0101    DYNAMIC  Vx1  10.25.2.12    1      4 days, 0:37:14 ago
51    0000.0051.0102    DYNAMIC  Vx1  10.25.2.12    1      4 days, 0:37:14 ago
51    0000.0051.0103    DYNAMIC  Vx1  10.25.2.12    1      4 days, 0:37:14 ago
51    0000.0051.0104    DYNAMIC  Vx1  10.25.2.12    1      4 days, 0:37:14 ago
51    0000.0051.0105    DYNAMIC  Vx1  10.25.2.12    1      4 days, 0:37:14 ago
61    0000.0061.0102    DYNAMIC  Vx1  10.25.2.12    1      4 days, 0:37:14 ago
61    0000.0061.0103    DYNAMIC  Vx1  10.25.2.12    1      4 days, 0:37:14 ago
61    0000.0061.0104    DYNAMIC  Vx1  10.25.2.12    1      4 days, 0:37:14 ago
61    0000.0061.0105    DYNAMIC  Vx1  10.25.2.12    1      4 days, 0:37:14 ago
switch>
```

16.4.11 show vxlan counters

The `show vxlan counters` command displays the VXLAN counters.

Command Mode

EXEC

Command Syntax

```
show vxlan counters ROUTE_TYPE
```

Parameters

- `ROUTE_TYPE` Specifies the type of VXLAN counter displayed by the command.
 - `software` Command displays software routers.
 - `varp` Command displays virtual-ARP counters.
 - `vtep` Command displays counters for VTEPs which are identified by their IP address. An optional keyword allows the user to view a single direction of the counters:
 - `encap` “encap” counters count packets coming from the edge, encapsulated on the device and directed to the core.
 - `decap` “decap” counters count packets coming from the core, decapsulated on the device and heading towards the edge.

Related Command

[clear vxlan counters](#) resets the VXLAN counters.

Examples

- This command displays the VXLAN counters for software routers.

```
switch>show vxlan counters software
encap_bytes:3452284
encap_pkts:27841
encap_read_err:1
encap_discard_runt:0
encap_discard_vlan_range:0
encap_discard_vlan_map:0
encap_send_err:0
encap_timeout:1427
decap_bytes_total:382412426
decap_pkts_total:2259858
decap_bytes:0
decap_pkts:0
decap_runt:0
decap_pkt_filter:45128
decap_bytes_filter:5908326
decap_discard_vxhdr:0
decap_discard_vlan_map:2214730
decap_timeout:0
decap_sock_err:1
switch>
```

- This command displays the VXLAN counters for VTEPs.

```
switch>show vxlan counters vtep
```

VTEP	Decap Bytes	Decap Known Unicast Packets	Decap BUM Packets	Decap Drop or Exception Packets
1.0.14.1	62526968000	312632701	312636979	2
1.0.16.1	800	2	6	312279633
1.0.23.1	800	2	6	2
unlearned	0	0	0	0

VTEP	Encap Bytes	Encap Packets	Encap Drop or Exception Packets
1.0.14.1	30579308814	268239551	2
1.0.16.1	1140	10	2
1.0.23.1	0	0	0

switch>

16.4.12 show vxlan flood vtep

The `show vxlan flood vtep` command displays the flood list that the switch is using to perform head-end replication. Head-end replication is a data distribution method that supports broadcast, unknown unicast, and multicast (BUM) traffic over VXLANs by replicating BUM data locally for transmission to the set of remote VTEPs that a flood list specifies. The command displays the VLAN ID that references the configured VNIs (`vxlan vlan vni`).

The flood list is determined by the `vxlan flood vtep` command.

Command Mode

EXEC

Command Syntax

```
show vxlan flood vtep [VLANS]
```

Parameters

- `VLANS` command filters display by the reference VLAN.
 - `<no parameter>` all VLANs.
 - `vlan v_range` VLANs specified by `v_range`.

Valid `v_range` formats include number, range, or comma-delimited list of numbers and ranges.

Guidelines

The command displays flood list contents only when the VLAN line protocol status is **up**.

Related Commands

- `vxlan flood vtep` configures the flood list.

Example

These commands display the VTEPs that have exchanged data with the configured VTI.

```
switch> show vxlan flood vtep vlan 100-102

          Vxlan Flood Vtep Table
-----
Vlan    Ip Address
-----
100     3.3.3.3
101     11.1.1.1          11.1.1.2          11.1.1.3
102     11.1.1.1          11.1.1.2          11.1.1.3
        12.1.1.1
switch>
```

16.4.13 show vxlan vtep

The `show vxlan vtep` command displays information about remote VTEPs that the configured VTI has discovered and with whom it has exchanged packets.

Command Mode

EXEC

Command Syntax

```
show vxlan vtep
```

Example

These commands display the VTEPs that have exchanged data with the configured VTI.

```
switch>show vxlan vtep
Remote vteps for Vxlan1:
10.52.2.12
Total number of remote vteps: 1
switch>
```

16.4.14 vxlan flood vtep

The `vxlan flood vtep` command supports VXLAN head-end replication by creating or modifying a list that specifies remote VTEPs to which the switch bridges replicated traffic. Head-end replication is a data distribution method that supports broadcast, unknown unicast, and multicast (BUM) traffic over VXLANs by replicating BUM data locally for transmission to the set of remote VTEPs that a flood list specifies. This data flooding facilitates remote MAC address learning through the forwarding of data with unknown MACs.

Each `vxlan flood vtep` statement in *running-config* associates a set of VTEP addresses to an access VNI. A default flood list is also configurable that applies to all VNIs for which a flood list is not configured. The `vxlan flood vtep` command is available in the following formats to create or modify corresponding *running-config* statements:

- `vxlan flood vtep` creates a statement for a specified VNI and replaces existing statements for that VNI.
- `vxlan flood vtep add` modifies an existing flood statement by adding the specified VTEPs. This statement creates a list if it references a VNI that has no flood statement.
- `vxlan flood vtep remove` modifies an existing flood statement by deleting the specified VTEPs. This statement has no effect if it references a VNI that has no flood statement.

The `vxlan flood vtep` command specifies a VNI by referencing its associated VLAN ID (`vxlan vlan vni`). The command provides these options for specifying the reference VLANs:

- **a single VLAN:** creates or modifies a single statement referenced by the command.
- **a range of VLANs:** creates or modifies all statements referenced by the VLAN range.
- **no VLAN:** creates or modifies the default list

The `no vxlan flood vtep` and `default vxlan flood vtep` commands remove the specified flood list by deleting the corresponding `vxlan flood vtep` statements from *running-config*. Commands that specify a VLAN range remove all corresponding statements.

Command Mode

Interface-VXLAN Configuration

Command Syntax

```
vxlan [ ACCESS_VNI] flood vtep] MODIFY] VTEP_1 [VTEP_2]...[VTEP_N]
no vxlan [ACCESS_VNI] flood vtep
default vxlan [ACCESS_VNI] flood vtep
```

Parameters

- `ACCESS_VNI` VLAN ID associated to the flood list's target VNI. Value ranges from 1 to 4094.
 - `<no parameter >` default list.
 - `vlan vlan_range` List of VLANs. (Number, range, comma-delimited list of numbers and ranges). Numbers range from 1 to 4094.
- `MODIFY` Statement modification method. Options include:
 - `<no parameter >` creates new list for specified VLANs. Current list is overwritten.
 - `add` specified VTEPs are added to existing list.
 - `remove` specified VTEPs are deleted from existing list.
- `VTEP_X` IPv4 address of VTEPs that are added or removed from the list.

Examples

- These commands create a default VXLAN head-end replication flood list.

```
switch(config)# interface vxlan 1
switch(config-if-Vx1)# vxlan flood vtep 10.1.1.1 10.1.1.2
```

```
switch(config-if-Vx1)# show active
interface Vxlan1
  vxlan flood vtep 10.1.1.1 10.1.1.2
  vxlan udp-port 4789
switch(config-if-Vx1)#
```

- These commands create VXLAN head-end replication flood lists for the VNIs accessed through VLANs 101 and 102.

```
switch(config-if-Vx1)# vxlan vlan 101-102 flood vtep 11.1.1.1 11.1.1.2 11.1.1.3
switch(config-if-Vx1)# show active
interface Vxlan1
  vxlan flood vtep 10.1.1.1 10.1.1.2
  vxlan vlan 101 flood vtep 11.1.1.1 11.1.1.2 11.1.1.3
  vxlan vlan 102 flood vtep 11.1.1.1 11.1.1.2 11.1.1.3
  vxlan udp-port 4789
switch(config-if-Vx1)#
```

- These commands add two VTEPs for the VNI access through VLAN 102.

```
switch(config-if-Vx1)# vxlan vlan 102 flood vtep add 12.1.1.1
switch(config-if-Vx1)# show active
interface Vxlan1
  vxlan flood vtep 10.1.1.1 10.1.1.2
  vxlan vlan 101 flood vtep 11.1.1.1 11.1.1.2 11.1.1.3
  vxlan vlan 102 flood vtep 11.1.1.1 11.1.1.2 11.1.1.3 12.1.1.1
  vxlan udp-port 4789
switch(config-if-Vx1)#
```

16.4.15 vxlan multicast-group decap

The `vxlan multicast-group decap` command enables VXLAN multicast decapsulation.

VTEPs are enabled by VXLAN multicast decapsulation, supporting Head End Replication (HER). Multicast encapsulated Broadcast/Unknown/Multicast (BUM) packets terminate VTEPs from remote VTEPs that do not support HER.

The `no vxlan multicast-group decap` and `default vxlan multicast-group decap` commands disable VXLAN multicast decapsulation.

Command Mode

Interface-VXLAN Configuration

Command Syntax

```
vxlan multicast-group decap group_addr
```

```
no vxlan multicast-group decap
```

```
default vxlan multicast-group decap
```

Parameters

- *group_addr* IPv4 address of multicast group. Dotted decimal notation of a valid multicast address.

Examples

- This command enables VXLAN multicast decapsulation.

```
switch(config)# interface vxlan 1  
switch(config-config-if-Vx1) #vxlan multicast-group decap 230.1.1.1  
switch(config-config-if-Vx1) #
```

- This command disables VXLAN multicast decapsulation.

```
switch(config) #interface vxlan 1  
switch(config-config-if-Vx1) #no vxlan multicast-group decap 230.1.1.1  
switch(config-config-if-Vx1) #
```

16.4.16 vxlan source-interface

The `vxlan source-interface` command specifies the interface from which the configuration mode VXLAN interface (VTI) derives the source address (IP) that it uses when exchanging VXLAN frames. There is no default source interface assignment.

The `no vxlan source-interface` and `default vxlan source-interface` commands remove the source interface assignment from the configuration mode VXLAN interface by deleting the corresponding `ip vxlan source-interface` command from *running-config*.

Command Mode

Interface-VXLAN Configuration

Command Syntax

```
vxlan source-interface INT_NAME
no vxlan source-interface
default vxlan source-interface
```

Parameters

- INT_NAME Interface type and number. Options include:
 - loopback *I_num* Loopback interface specified by *I_num*.

Guidelines

A VXLAN interface is inoperable without the source-interface assignment.

Related Command

[interface vxlan](#) places the switch in VXLAN interface configuration mode.

Example

These commands configure VTI 1 to use the IP address 10.25.25.3 as the source address of outbound VXLAN frames.

```
switch(config)#interface loopback 15
switch(config-if-Lo15)#ip address 10.25.25.3/24
switch(config-if-Lo15)#exit
switch(config)#interface vxlan 1
switch(config-if-Vx1)#vxlan source-interface loopback 15
switch(config-if-Vx1)#show active
interface Vxlan1
  vxlan source-interface Loopback15
  vxlan udp-port 4789
switch(config-if-Vx1)#
```

16.4.17 vxlan udp-port

The `vxlan udp-port` command associates a UDP port with the configuration mode VXLAN interface (VTI). By default, UDP port 4789 is associated with the VTI.

Packets bridged to the VTI from a VLAN are encapsulated with a VXLAN header that includes the VNI associated with the VLAN and the IP address of the VTEP that connects to the recipient, then sent through the UDP port. Packets that arrive through the UDP port are sent to the bridging domain of the recipient VLAN as determined by the VNI number in the VXLAN header and the interface's VNI-VLAN map.

The `no vxlan udp-port` and `default vxlan udp-port` command restores the default UDP port association (4789) on the configuration mode interface by deleting the corresponding `vxlan udp-port` command from *running-config*.

Command Mode

Interface-VXLAN Configuration

Command Syntax

```
vxlan udp-port port_id
no vxlan udp-port
default vxlan udp-port
```

Parameters

- `port_id` UDP port number. Value ranges from 1024 to 65535.

Guidelines

UDP port 4789 is reserved by convention for VXLAN usage. Under most typical applications, this parameter should be set to the default value.

Related Commands

- [interface vxlan](#) places the switch in VXLAN interface configuration mode.

Examples

- This command associates UDP port 5500 with VXLAN interface 1.

```
switch(config)#interface vxlan 1
switch(config-if-Vx1)#vxlan udp-port 5500
switch(config-if-Vx1)#show active
interface Vxlan1
    vxlan udp-port 5500
switch(config-if-Vx1)#
```

- This command resets the VXLAN interface 1 UDP port association of 4789.

```
switch(config-if-Vx1)#no vxlan udp-port
switch(config-if-Vx1)#show active
interface Vxlan1
    vxlan udp-port 4789
switch(config-if-Vx1)#
```

16.4.18 vxlan vlan vni

The `vxlan vlan vni` command associates a VLAN ID with a virtual network identifier (VNI). A VNI is a 24-bit number that is assigned to a VLAN to distinguish it from other VLANs that are on a VXLAN tunnel interface (VTI). VNI values range from 1 to 16777215 in decimal notation and from 0.0.1 to 255.255.255 in dotted decimal notation.

When a VLAN bridges a packet to the VTI, the packet is encapsulated with a VXLAN header that includes the VNI that is associated with the VLAN. Packets that arrive on the VTI's UDP socket are bridged to the VLAN that is associated with the VNI specified by the VXLAN header that encapsulates the packet.

The VTI requires a one-to-one correspondence between specified VLANs and VNI values. Commands that assign a new VNI to a previously configured VLAN replace the existing VLAN assignment statement in *running-config*. Commands that attempt to assign a VNI value to a second VLAN generate a CLI error.

The `no vxlan vlan vni` and `default vxlan vlan vni` commands remove the specified VLAN-VNI association from the configuration mode interface by deleting the corresponding `vxlan vlan` command from *running-config*.

Command Mode

Interface-VXLAN Configuration

Command Syntax

```
vxlan vlan vlan_id vni [vni_id]
```

```
no vxlan vlan vlan_id vni [vni_id]
```

```
default vxlan vlan vlan_id vni [vni_id]
```

Parameters

- *vlan_id* number of access VLAN. Value ranges from 1 to 4094.
- *vni_id* VNI number. Valid formats: decimal <1 to 16777215> or dotted decimal <0.0.1 to 255.255.255>.

Example

- These commands associate VLAN 100 to VNI 100 and VLAN 200 to VNI 10.10.200.

```
switch(config)#interface vxlan 1
switch(config-if-Vx1)#vxlan vlan 100 vni 100
switch(config-if-Vx1)#vxlan vlan 200 vni 10.10.200
switch(config-if-Vx1)#show active
interface Vxlan1
  vxlan udp-port 4789
  vxlan vlan 200 vni 658120
  vxlan vlan 100 vni 100
switch(config-if-Vx1)#vxlan vni notation dotted
switch(config-if-Vx1)#show active
interface Vxlan1
  vxlan udp-port 4789
  vxlan vlan 200 vni 10.10.200
  vxlan vlan 100 vni 0.0.100
switch(config-if-Vx1)#
```

16.4.19 vxlan vni notation dotted

The `vxlan vni notation dotted` command configures the switch to display VNIs in dotted decimal notation. A virtual network identifier (VNI) is a 24-bit number that is assigned to a VLAN to distinguish it from other VLANs that are on a VXLAN tunnel interface. VNI values range from 1 to 16777215 in decimal notation and from 0.0.1 to 255.255.255 in dotted decimal notation.

The command affects the VNI number display in all `show` commands, including `show running-config`. Commands that include VNI as a parameter may use decimal or dotted decimal notation regardless of the setting of this command. By default, show commands display VNI number in decimal notation.

The `no vxlan vni notation dotted` and `default vxlan vni notation dotted` commands restore the default setting of displaying vni numbers in decimal notation by deleting the `vxlan vni notation dotted` command from *running-config*.

Command Mode

Global Configuration

Command Syntax

```
vxlan vni notation dotted
no vxlan vni notation dotted
default vxlan vni notation dotted
```

Examples

- These commands configure the switch to display vni numbers in dotted decimal notation, then displays a configuration that includes a vni setting.

```
switch(config)#vxlan vni notation dotted
switch(config)#interface vxlan 1
switch(config-if-Vx1)#show active
interface Vxlan1
    vxlan udp-port 4789
    vxlan vlan 333 vni 3.4.5
switch(config-if-Vx1)#
```

- These commands configure the switch to display vni numbers in decimal notation, then displays a configuration that includes a vni setting.

```
switch(config)#no vxlan vni notation dotted
switch(config)#interface vxlan 1
switch(config-if-Vx1)#show active
interface Vxlan1
    vxlan udp-port 4789
    vxlan vlan 333 vni 197637
switch(config-if-Vx1)#
```

Ethernet VPN (EVPN)

This chapter describes Arista's EVPN implementation. Sections in this chapter include:

- [EVPN Overview](#)
- [EVPN Layer 3 Core Operations](#)
- [Integrated Routing and Bridging](#)
- [VPN MPLS Transport Options](#)
- [EVPN Type-5 Routes: IP Prefix Advertisement](#)
- [BGP PIC Edge for EVPN VXLAN Routes for Remote VTEP Failures](#)
- [Inter-VRF Local Route Leaking](#)
- [Static Inter-VRF Route](#)
- [VCS to EVPN Hitless Migration](#)
- [Configuring EVPN](#)
- [Sharing Equivalence Class entry across multiple VRF](#)
- [Sample Configurations](#)
- [EVPN and VCS Commands](#)

17.1 EVPN Overview

Ethernet VPN (EVPN) is a standards-based BGP control plane to advertise MAC addresses, MAC and IP bindings and IP Prefixes. This document focuses on EVPN and its operation with a VXLAN data plane for building overlay networks in the data center.

A number of control planes exist today for VXLAN, based on specific use cases, whether it be a requirement to integrate with an SDN overlay controller, or operate in a standards based flood and learn control plane model.

Current flood and learn models operate either with a multicast control plane, or ingress replication, where the operator manually configures the remote VTEPs in the flood list. Both of these are data-plane driven, that is, MAC's are learned via flooding. In the IP multicast model MAC's are learned in the underlay via flooding to an IP multicast group, while ingress replication (HER) floods to configured VTEP endpoints and no IP Multicast is required in the underlay.

The controller based solution with cloud vision exchange (CVX), locally learned MAC's are published to a centralized controller and these MAC's are then programed to all participating VTEPs.

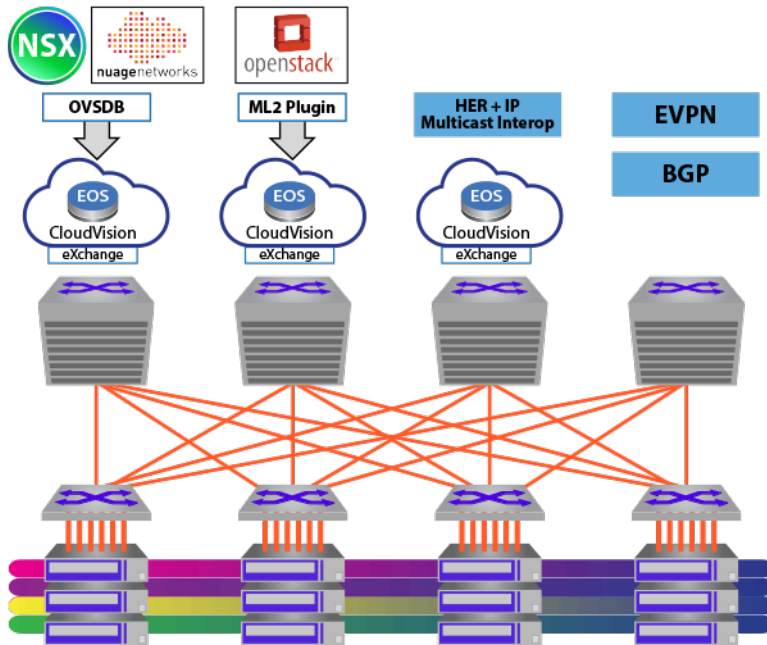

Figure 69: Different VXLAN Control Planes

A controller-less BGP EVPN MAC learning is a standards-based control-plane (MP-BGP) is used to discover remote VTEPs and advertise MAC address and MAC/IP bindings in the VXLAN overlay, thus eliminating the flood and learn paradigms of the previously mentioned (multicast or HER) controller-less approaches. As a standards-based approach, the discovery and therefore the advertisement of the EVPN service models can inter-operate amongst multiple vendors.

This highlights an important and powerful advantage of BGP EVPN; that being, it is a single control plane for multiple data-plane encapsulations and defines both Layer 2 and layer 3 VPN services. As network operators drive toward simplicity and automation, having one control plane protocol and address family for all data-planes and VPN services will prove extremely powerful.

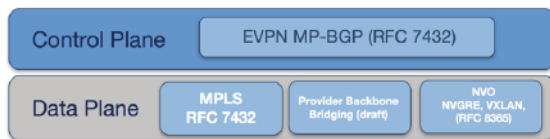

Figure 70: VXLAN Control Plane and Data-plane Definitions

The initial EVPN standard is RFC 7432 defined the BGP EVPN control plane and specifies an MPLS data-plane. The control plane with an MPLS data plane was extended to consider additional data plane encapsulations models including VXLAN, NVGRE and MPLS over GRE.

17.1.1 EVPN Terminology

The EVPN standard in the context of an NVO environment, defines the functionality for delivering multi-tenant Layer 2/3 VPN services using either VXLAN, NVGRE or MPLS over GRE encapsulation, across a common physical IP infrastructure. The standard introduces new terminology specific to a NVO environment, which are summarized below in relation to VXLAN encapsulation.

- **Network Virtualization Overlay (NVO):** The overlay network used to deliver the Layer 2 and Layer 3 VPN services. For VXLAN encapsulation, this would define a VXLAN domain, which

would include one or more VNIs, for the transportation of tenant traffic over a common IP underlay infrastructure.

- **Network Virtualization End-Point (NVE):** The provider edge node within the NVO environment responsible for the encapsulation of tenant traffic into the overlay network. For a VXLAN data plane, this defines the Virtual Tunnel End-Point (VTEP)
- **Virtual Network Identifier (VNI):** The label identifier within the VXLAN encapsulated frame, defining a Layer 2 domain in the overlay network.
- **EVPN instance (EVI):** A logical switch within the EVPN domain which spans and interconnects multiple VTEPs to provide tenant Layer 2 and layer 3 connectivity.
- **MAC-VRF:** A Virtual Routing and Forwarding table for storing Media Access Control (MAC) addresses on a VTEP for a specific tenant.

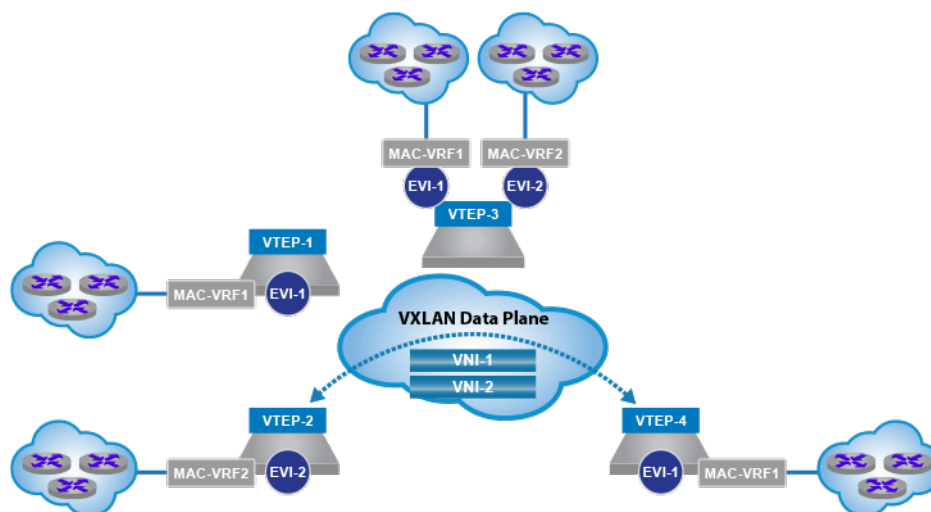

Figure 71: EVPN Terminology for a VXLAN Data Plane

The new EVPN Network Layer Reachability Information (NLRI) is carried in BGP using Multi-protocol BGP Extensions with a newly defined Address Family Identifier (AFI) and Subsequent Address Family Identifier (SAFI).

To provide multi-tenancy, the standard uses the above traditional VPN methods to control the import and export of routes and provide support for overlapping IP address between tenants.

- **Multi-protocol BGP for EVPN:** A new AFI and SAFI have been defined for EVPN. These are AFI=25 (Layer 2 VPN) and SAFI = 70 (EVPN)
 - **EVPN Layer 2/Layer 3 tenant segmentation:** Similar to standard MPLS VPN configurations Route Distinguisher's (RD's) and Route Targets (RT's) are defined for the VPN.
 - **Route Target (RT):** To control the import and export of routes across VRFs, EVPN routes are advertised with Route-Target (RT) (BGP extended communities). The RT can be auto derived to simplify the rule configuration, typically this is based on the AS number and the VNI of the MAC-VRF.
 - **Route Distinguisher (RD):** Unique number prepended to the advertised address within the VRF, ensuring support for overlapping IPs and MACs across different tenants.

The format of the MP_REACH_NLRI/MP_UNREACH_NLRI attribute, holding the new EVPN NLRI is illustrated below, where the next-hop address within the NLRI is the IP address of the VTEP advertising the EVPN route.

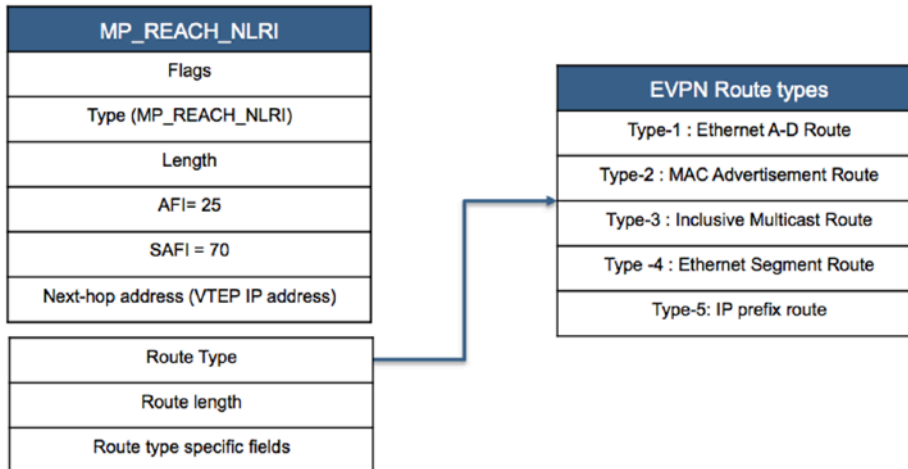

Figure 72: EVPN NLRI Route Format

As illustrated, the original MPLS RFC (7348) and subsequent IP prefix draft ([EVPN Terminology](#)), introduce five unique EVPN route types.

Type-1 Route: Ethernet A-D route

Ethernet A-D route per ESI route, announces the reachability of a multi-homed Ethernet Segment. The route type is used for fast convergence (ie: ‘mass withdraw’) functions, as well as split horizon filtering used for active-active multi-homing.

Ethernet A-D route per EVI route, is used to implement the Aliasing and Backup Path features of EVPN associated with active-active multi-homing.

Type-2 Route: Host advertisement Route

Used to advertise the reachability of a MAC address, or optionally a MAC and IP binding as learned by a specific EVI. With the advertisement of the optional IP address of the host, EVPN provides the ability for VTEPs to perform ARP suppression and ARP proxy to reduce flooding within the Layer 2 VPN.

Type-3 Route: Inclusive Multicast route

The type-3 route is used to advertise the membership of a specific Layer 2 domain (VNI within the VXLAN domain), allowing the dynamic discovery of remote VTEPs in a specific VNI and the population of a VTEP ingress flood list for the forwarding of Broadcast Unknown unicast and Multicast (BUM) traffic.

Type-4 Route: Ethernet Segment Route

The type-4 route is specific to VTEPs supporting the EVPN multi-homing model, for active-active and active-standby forwarding. The route is used to discover VTEPs which are attached to the same shared Ethernet Segment. Additionally, this route type is used in the Designated Forwarder (DF) election process.

Type-5 Route: IP-prefix route advertisement

The type-5 route is used to advertise IP prefixes rather the MAC and IP hosts addresses of the type-2 route. This advertisement of prefixes into the EVPN domain provides the ability to build classic layer 3 VPN topologies.

A detailed understanding of the function of each of these route types in the operation of EVPN to provide multi-tenant Layer 2 and 3 VPN services, is defined in Section 4 of this document.

While this guide focuses on EVPN with VXLAN data-plane encapsulation, it's important to note that, in addition to the new routes type, a BGP encapsulated extended community is included in all advertisements to determine the data-plane encapsulation.

The Encapsulation extended community is defined in RFC 5512. The different IANA registered tunnel types for an NVO environment are summarized in the table below.

Extended Community Value	Name	Reference
8	VXLAN	draft-ietf-bess-evpn-overlay-08
9	NVGRE	draft-ietf-bess-evpn-overlay-08
10	MPLS	RFC 7342
11	MPLSoGRE	draft-ietf-bess-evpn-overlay-08

Figure 73: Defined Data-Plane Encapsulations

17.1.2 EVPN Service Models

An EVPN instance (EVI), can contain, one or more Layer 2 broadcast domains (VLANs).

The association of a VLAN-IDs to a specific EVI instance and how a VLAN tag can be transported within the EVI if required, is defined by three EVPN service models: VLAN based, VLAN Bundle, and VLAN aware bundle.

17.1.2.1 VLAN Based Service Interface

In the VLAN based service there is a one-to-one mapping between the VLAN-ID and the MAC-VRF of the EVPN instance. With the MAC-VRF mapping directly to the associated VLAN, there will be a single bridge table within the MAC-VRF. The VLAN tag is not carried in any route update and the VNI label in the route advertisement is used to uniquely identify the bridge domain of the MAC-VRF in the VXLAN forwarding plane.

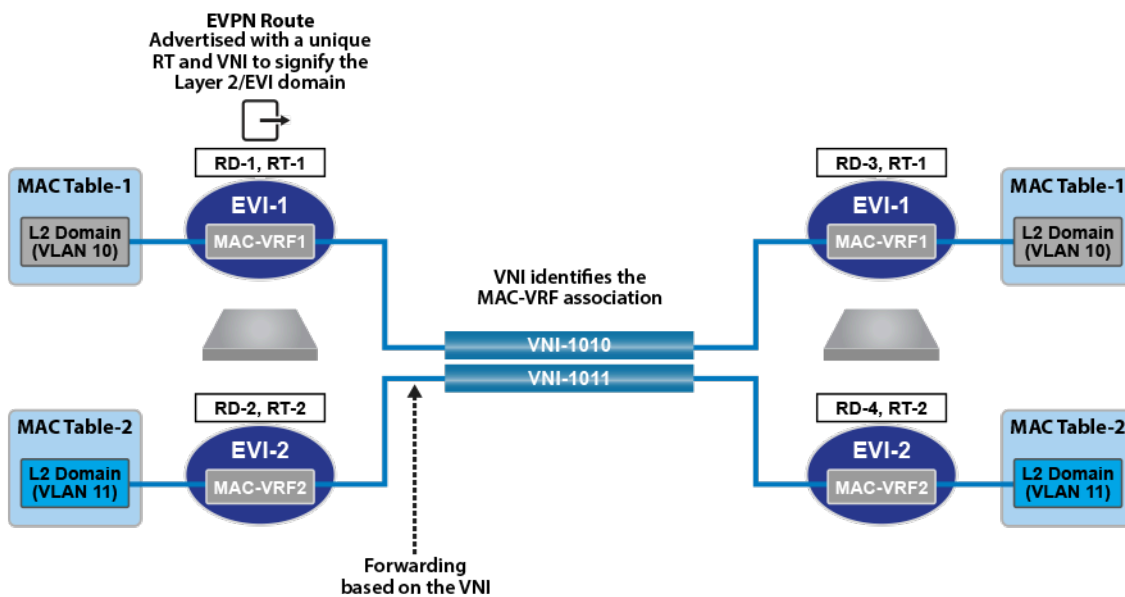

Figure 74: VLAN Based Service Interface

With a one-to-one mapping between the VLAN-ID and the MAC-VRF of EVI instance, the EVI will represent an individual tenant subnet/VLAN in the overlay. The one-to-one mapping also means the

route-target associated with the MAC-VRF, uniquely identifies the tenant's subnet/VLAN, providing granular importing of MAC routes on a per VLAN basis on each VTEP.

In this service, the associated MAC-VRF table is identified by the Route-Target in the control plane and by the VNI in the data plane and the MAC-VRF table corresponds to a single VLAN bridge domain.

17.1.2.2 VLAN Bundle Service Interface

In the VLAN bundle service, there is a many-to-one mapping between the VLAN-IDs and the MAC-VRF of the EVPN instance. The MAC-VRF however only contains a single Layer 2 bridge table and VNI label, thus MAC addresses must be unique across all associated VLANs.

With the MAC-VRF containing a single Layer 2 bridge table and a single VNI, the original VLAN tag has no significance in the control plane and is not carried in any EVPN route update. The original Ethernet tag and the VNI label are carried in the VXLAN data plane, to allow forwarding to the correct tenant VLAN.

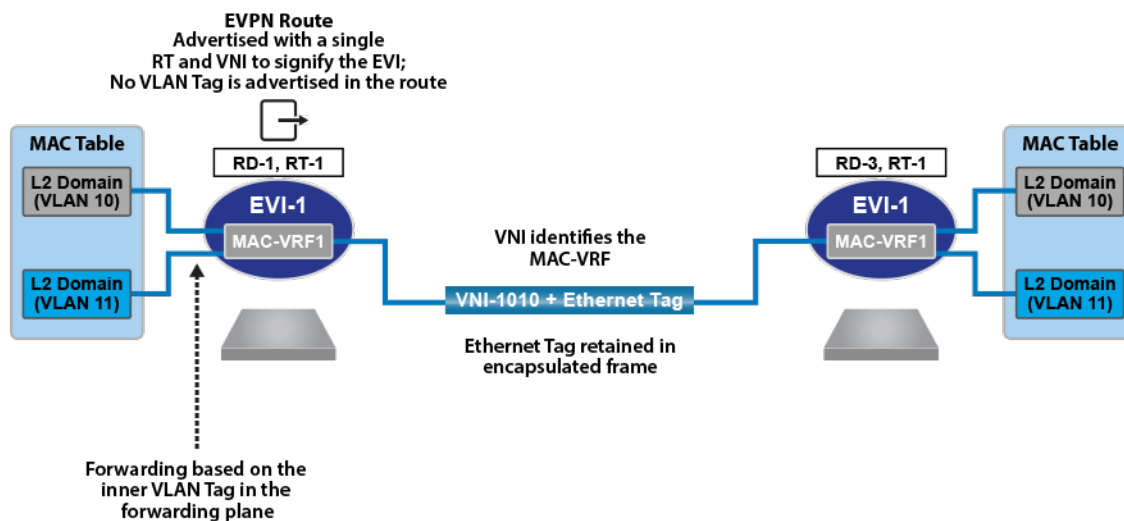

Figure 75: VLAN Bundle Service Interface

In this service, the Route-Target associated with the MAC-VRF identifies the tenant rather than an individual subnet/VLAN of a tenant. This means all MAC routes for the tenant will be imported on the VTEP regardless of whether or not the specific tenant VLAN exists. The MAC-VRF table is identified by the Route-Target in the control plane and forwarding to the appropriate tenant VLAN is achieved via a combination of the VNI and Ethernet tag in the VXLAN data plane.

17.1.2.3 VLAN Aware Bundle Service Interface

In the VLAN aware bundle service, there is a many-to-one mapping between the VLAN-IDs and the MAC-VRF of the EVPN instance. However, the MAC-VRF contains a unique Layer 2 bridge table for each associated VLAN-ID and a unique VNI label for each bridge domain.

With the MAC-VRF containing multiple Layer 2 bridge tables, the VLAN tag is carried in any EVPN route update to allow mapping to the correct tenant bridge table within the MAC-VRF. Only the unique VNI label is carried in the VXLAN data plane, to allow forwarding to the correct VLAN with the MAC-VRF.

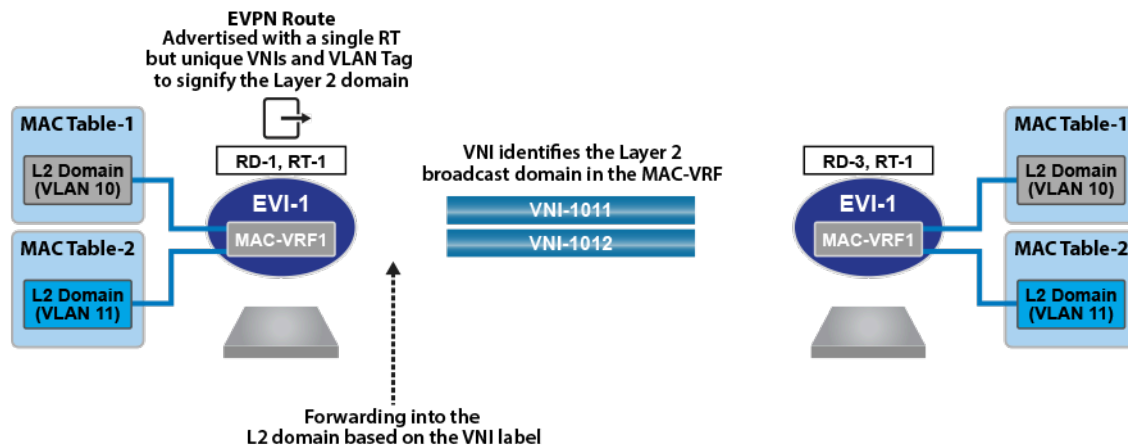

Figure 76: VLAN Aware Bundle Service

In this service, the MAC-VRF of the EVI instance represents multiple subnet/VLANs of the tenant. The Layer 2 bridge table of the MAC-VRF is identified by a combination of the Route-Target and the Ethernet tag in the control plane and by the unique VNI and in the VXLAN data plane.

This service type is a common DCI/WAN deployment, where a tenant's VLANs are bundled into single EVI instance, while VLAN "awareness" can be retained in the EVPN service as the VNI tag is advertised in the MAC-IP route (which now identifies the VLAN within the EVI). Bundling into a service like this reduces the number of EVI's that need to be configured, reducing complexity and the control-plane signaling between PE's.

17.1.3 VCS and EVPN in DCI

When VXLAN Control Services (VCS) is enabled on a CloudVision eXchange (CVX) of a Data Center (DC), each VXLAN Tunnel End Point (VTEP) connects to the corresponding CVX for sharing the Layer 2 bridging information of its attached hosts. In turn, CVX advertises this information to all VTEPs within the DC.

In a topology consisting of multiple DCs where each DC runs its own CVX instance as shown below, a federation of CVXs can be created by using BGP-EVPN. In such Data Center Interconnect (DCI) topologies, CVX in each DC performs the following functions to advertise the Layer 2 bridging information (MAC-VTEP bindings) to all VTEPs in different DCs:

- Receives the local Layer 2 bridging information in CVX control plane format from all VTEPs within the DC; and advertises it to remote CVXs in the BGP-EVPN NLRI format.
- Receives the Layer 2 bridging information in BGP-EVPN NLRI format from remote CVXs; and advertises it to local VTEPs in the CVX control plane format.

 **Note:** The distribution of Layer 2 bridging information as described above allows a Layer 2 overlay network to be stretched across multiple DCs without additional VTEP configurations.

The following graphic illustrates the federation of CVX across multiple DCs.

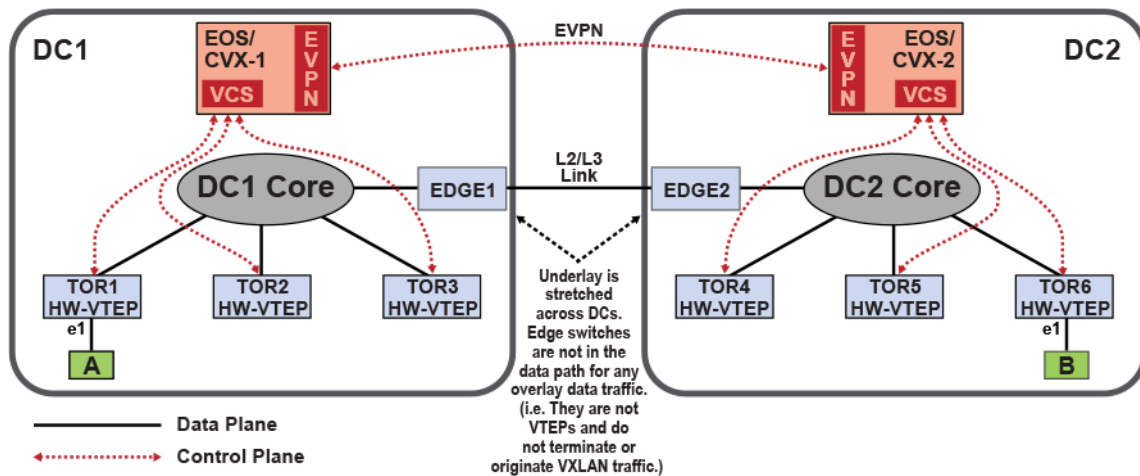

Figure 77: CVX Connected from Multiple DCs

17.1.4 EVPN MPLS LAYER 3 VPN (Type-5 Route)

Ethernet VPN (EVPN) is an extension of the BGP protocol introducing a new address family: Layer 2 VPN (address family number 25) / EVPN (subsequent address family number 70). It is used to exchange overlay MAC and IP address reachability information between BGP peers using type-2 routes. Additionally, EVPN supports the exchange of layer 3 IP overlay routes through the extensions described in (type 5 EVPN routes).

An IP VRF is used on a PE router for each layer 3 overlay. VRF IP routes are exported into the EVPN BGP table and advertised to remote VTEPs as type 5 routes. The exported EVPN routes carry the Route-Target (RT) extended communities that are configured as export route-targets on the IP VRF from which they were exported.

The RTs carried by the EVPN type 5 routes received by a PE are matched against the VRF import route-target configuration. When a received route carries an RT that is configured as an import route-target on an IP VRF, the route is imported into the IP table for that VRF.

PE routers allocate per-VRF and address family Labels that are advertised as part of the layer 3 (type 5) EVPN route NLRI. Forwarding of overlay packets between PEs across the underlay requires underlay MPLS connectivity provided by an IP backbone.

The type-5 routes provide the ability to decouple the advertisement of an IP prefix from any specific MAC address, providing the ability to support floating IP address, optimized the mechanism for advertising external IP prefixes, and reduce the churn when withdrawing IP prefixes.

The format of the new type-5 IP-prefix route is illustrated in the figure below. Unlike when VXLAN is used as a transport, BGP route update for MPLS does not specify the router-mac extended community and sets the tunnel encapsulation to MPLS. Unlike with VXLAN encapsulation, which uses the VNI as the overlay index, the MPLS Type-5 route uses the MPLS label.

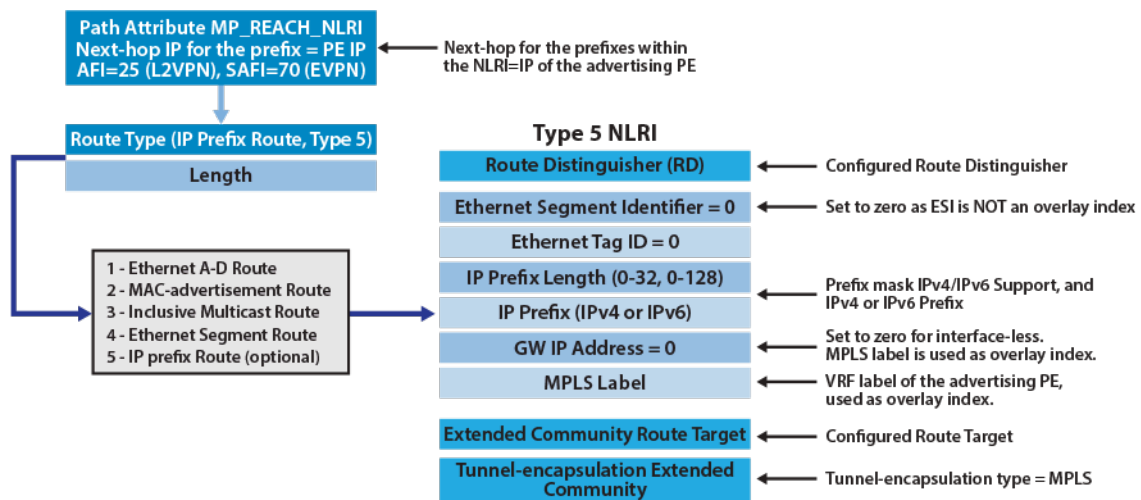

Figure 78: EVPN Route Type-5, for Advertisement of IP-Prefixes over MPLS

The following example offers a more detailed view of the route as displayed on a PE router.

```
dml-261sw24-backbone1.22:22:54#sh bgp evpn route-type ip-prefix ipv4 rd 6.6.6.6:64512 detail
BGP routing table information for VRF default
Router identifier 1.1.1.1, local AS number 64512
BGP routing table entry for ip-prefix 3.0.0.0/8, Route Distinguisher: 6.6.6.6:64512
Paths: 2 available
Local
 6.6.6.6 from 7.7.7.7 (7.7.7.7)
  Origin IGP, metric -, localpref 100, weight 0, valid, internal, ECMP head, best, ECMP contributor
  Originator: 6.6.6.6, Cluster list: 7.7.7.7
  Extended Community: Route-Target-AS:64512:11 TunnelEncap:tunnelTypeMpls
  MPLS label: 116384
Local
 6.6.6.6 from 6.6.6.6 (6.6.6.6)
  Origin IGP, metric -, localpref 100, weight 0, valid, internal, ECMP, ECMP contributor
  Extended Community: Route-Target-AS:64512:11 TunnelEncap:tunnelTypeMpls
  MPLS label: 116384
```

IP-prefix and RD being advertised

Next hop (6.6.6.6) for the prefix and advertising Router (7.7.7.7)

Route-target (64512:11), encapsulation (MPLS) label for the VPN route (116384)

Figure 79: EVPN Route Type-5 as Shown on PE

As shown in the example, the route contains the VPN route (prefix and RD), the next-hop for the route and the advertising router ID, along with the extended communities of tunnel type (MPLS), MPLS Label value and route-target.

Note: You require 4.21.1F release and later versions with Jericho/Jericho+ platforms.

17.1.5 EVPN VxLAN IPV6 Overlay

Beginning with **EOS Release 4.22.0F**, the EVPN VXLAN L3 Gateway using EVPN IRB supports routing traffic from one IPV6 host to another IPV6 host on a stretched VXLAN VLAN.

17.1.5.1 Platform Compatibility

Platforms supporting ND Proxy and ND Suppression:

- DCS-7280R/7280R2/DCS-7280R3/DCS-7500/DCS-7800 with R3 linecards
- DCS-7050CX3-32S-F
- DCS-7050SX3-48YC12-F (Starting in **EOS Release 4.22.1F**)
- DCS-7050SX3-48YC8 (Starting in **EOS Release 4.22.1F**)
- DCS-7050/7050X/7050X2 (Starting in **EOS Release 4.22.1F**)
- DCS-7260X/7260X3 (Starting in **EOS Release 4.22.1F**)
- DCS-7060X/7060X2 (Starting in **EOS Release 4.22.1F**)
- DCS-7250 (Starting in **EOS Release 4.22.1F**)
- DCS-7300/DCS-7320 (Starting in **EOS Release 4.22.1F**)

Platform not supporting ND Proxy, No ND Suppression:

- DCS-7020R
- DCS-7160
- DCS-7500R/7500R2/7500E

17.2 EVPN Layer 3 Core Operations

The EVPN standard defines a number of operations and functionality to allow the dynamic learning of MAC and IP bindings, management of MAC moves (VM/host mobility), ARP suppression, automated discovery of remote VTEPs and multi-homing to support active-active topologies.

17.2.1 MAC Address Learning

MAC address learning on the local interface of a VTEP is flow-based learning, however once the MAC addresses are learned locally they are advertised to BGP peers within the EVI via an EVPN route update. The next hop of the update is set to IP of the advertising VTEP. In the case of EVPN VXLAN the label advertised in the update is the VNI, which identifies the MAC-VRF in the case of a VLAN Based service, or the EVI for a VLAN aware bundle service.

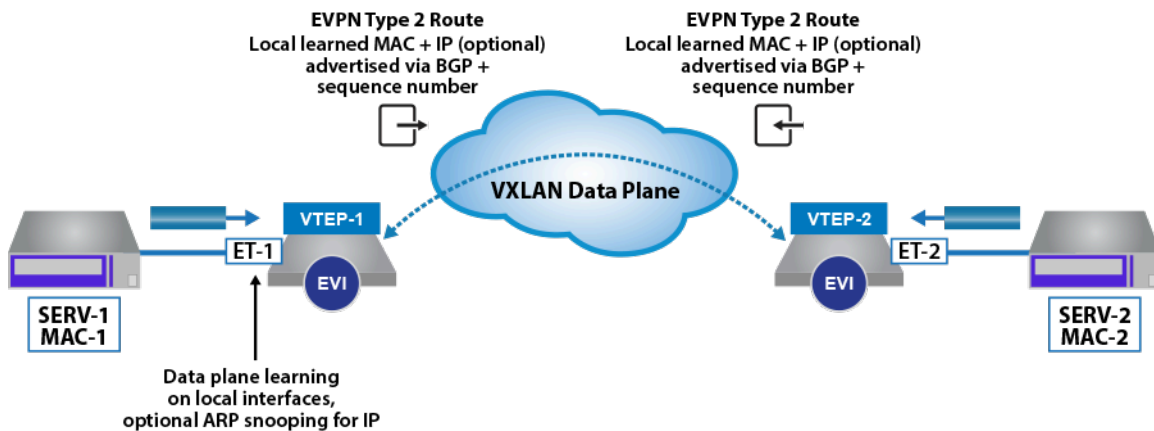

Figure 80: EVPN Type 2 Route Announcement

The route advertisements are EVPN type-2 routes, which can advertise just the MAC address of the host, or optionally the MAC and IP address of the host. The format of the type-2 route is illustrated in the figure below, along with the mandatory and optional extended community attached to the route.

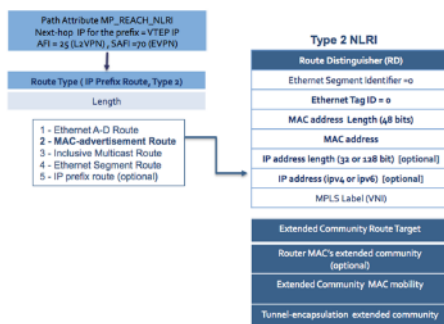

Figure 81: EVPN Type 2 MAC and IP Route Format

Notable fields:

- Multi-protocol Reachable NLRI (MP_REACH_NLRI) attribute of the route is used to carry the next-hop hop for the advertised route. In the context of a VXLAN forwarding plane, this will be the source address (VTI) of the advertising VTEP.
- Route Distinguisher of the advertising node's MAC-VRF.
- Ethernet Segment Identifier (ESI), this field is populated when the VTEP participating in a multi-homed topology. This is discussed in the following sections.
- Ethernet tag ID that will be 0 for VLAN-based service, and the customer VLAN ID in a VLAN-aware bundle service.
- IP address of the host which is associated with advertised MAC address. The advertisement of the Host's IP address is optional.
- Label in the context of a VXLAN forwarding plane is the VNI associated with the MAC-VRF/Layer 2 domain the advertised MAC address has been learned on.
- Route Target associated with the MAC-VRF advertised with route to allow the control of the import and export of routes.

The MAC mobility extended community, as discussed in the following section is used during MAC moves to update all VTEPs of the new location of the host.

17.2.2 ARP Suppression

Providing the option to advertise the MAC and IP binding in the type-2 route, ARP suppression can be supported on the remote VTEPs. The MAC to IP binding can be learned locally, via ARP snooping or DHCP traffic on the VTEP. Once the MAC and IP binding has been learned, it is advertised to the remote VTEPs as a type-2 route. This allows remote VTEPs to respond to any ARP requests for the host locally, thus reducing the amount of ARP traffic across the EVI.

Importantly, the optional MAC and IP route can be advertised separately from the MAC only type-2 route. This is done so that if the MAC and IP route is cleared, i.e. ARP flushed, or the ARP timeout is set to less than the MAC timeout, then the MAC only route will still exist.

17.2.3 MAC Mobility

A common scenario in a data center environment is virtual machines (VMs) moving between physical servers, for maintenance or performance reasons, this will result in the MAC of the VM being learned and advertised by a new VTEP.

To cater for this situation a sequence number is attached to the new MAC advertisement ensuring an EVI wide refresh of the MAC table, with VTEPs updating their forwarding tables to point to the advertising VTEP as the new next-hop for MAC address.

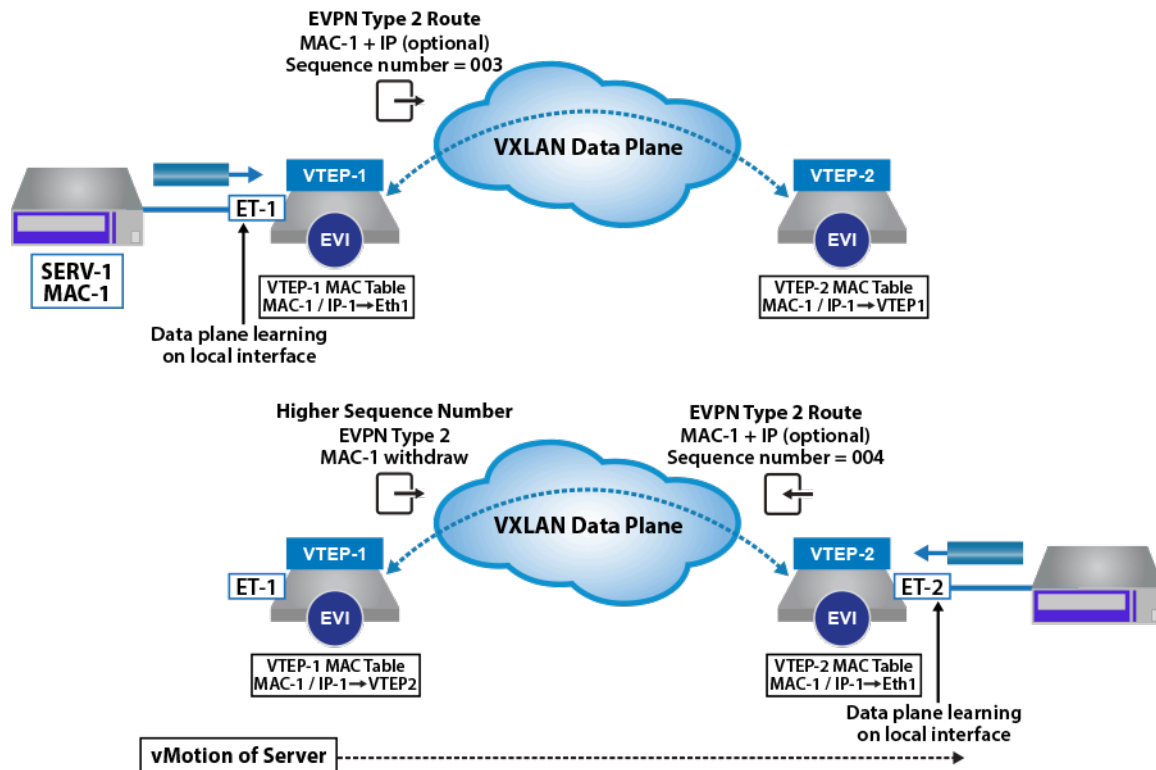

Figure 82: EVPN type-2 MAC Mobility Behavior

When a MAC address is learned and advertised for the first time, it is advertised without a sequence number and the receiving VTEP assume the sequence to be zero. On detection of a MAC move, i.e. a MAC is learned locally when the same MAC route is active via a type-2 advertisement, then the sequence number is incremented by one, and the MAC route is advertised to the remote peers. The original advertising VTEP, receives the MAC route with a now higher sequence number and withdraws its own local MAC route. All other VTEPs flush the original MAC route, and update their tables with the new higher sequence number route.

17.2.4 MAC Address Damping

In addition to MAC mobility, EVPN defines a protection mechanism to detect and prevent MAC routes flapping between VTEPs, which can occur during network instability or when hosts have been mis-configured with the same (duplicate) MAC address.

On advertising a locally learned MAC, the VTEP will start a M second counter (default is 180s), if the VTEP detects N MAC moves (default is 5) for the route within the M second window, it will generate a syslog message and stop sending and processing any further updates for the route.

17.2.5 Broadcast and Multicast Traffic

Broadcast, unknown unicast and Multicast (BUM) traffic is handled within the EVPN forwarding model using ingress replication. Where the BUM frame is replicated on the ingress VTEP to each of the remote VTEPs in the associated EVI/VNI. The VTEP replication list for the EVI, is dynamically populated based on Type-3 route advertisements (Inclusive Multicast Ethernet Tag Route), where VTEPs advertise type-3 routes for each EVI they are members.

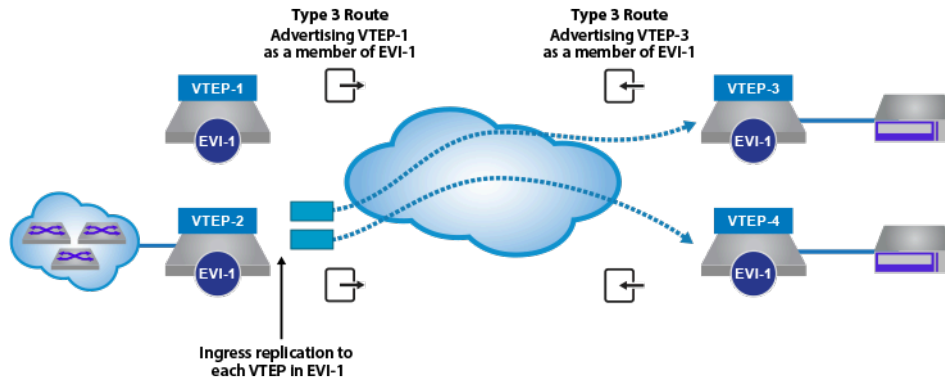

Figure 83: EVPN type-3 IMET Route Behavior for Ingress Replication

The format of the type-3 route is illustrated below.

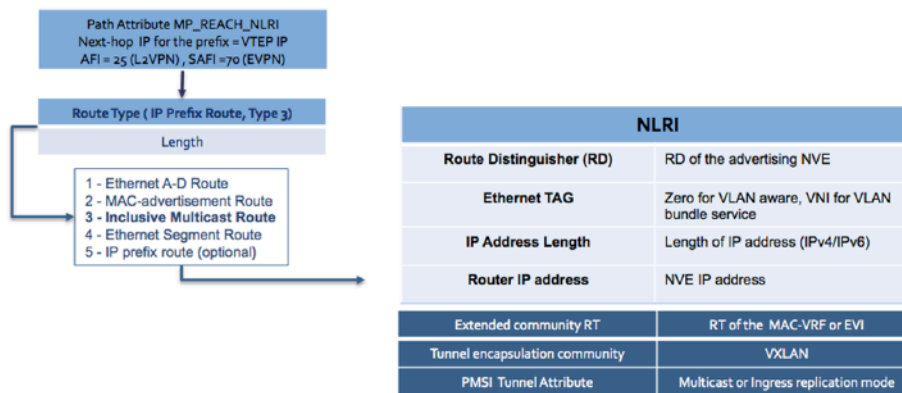

Figure 84: EVPN Type-3 IMET Route Format

Notable fields of the type-3 route:

- Multi-protocol Reachable NLRI (MP_REACH_NLRI) attribute of the route is used to carry the next-hop hop for the advertised route. In the context of a VXLAN forwarding plane, this will be the source address (VTI) of the advertising VTEP.
- Route Distinguisher of the advertising node’s MAC-VRF.
- Ethernet tag that will be 0 for VLAN-based service, and the MAC-VRF VNI for a VLAN-aware bundle service.
- IP address of the VTEP advertising the type 3 route.
- Route Target associated with the MAC-VRF or the EVI in a VLAN-aware bundle service.
- PMSI Tunnel Attribute, to advertise the replication model the VTEP is supporting. The supported options defined within the standard are ingress replication and IP multicast.

17.3 Integrated Routing and Bridging

In the traditional data center design, inter-subnet forwarding is provided by a centralized router, where traffic traverse across the network to a centralized routing node and back again to its final destination. In a large multi-tenant data center environment this operational model can lead to inefficient use of bandwidth and sub-optimal forwarding.

To provide a more optimal forwarding model and avoid traffic tromboning, the EVPN inter-subnet draft ([draft-sajassi-l2vpn-evpn-inter-subnet-forwarding](#)) proposes integrating the routing and bridging (IRB)

functionality directly onto the VTEP, thereby allowing the routing operation to occur as close to the end host as possible. The draft proposes two forwarding models for the IRB functionality, which are termed asymmetric IRB and symmetric IRB, these two models are described in the following sections.

In the asymmetric IRB model, the inter-subnet routing functionality is performed by the ingress VTEP, with the packet after the routing action being VXLAN bridged to the destination VTEP. The egress VTEP only then needs to remove the VXLAN header and forward the packet onto the local Layer 2 domain based on the VNI to VLAN mapping. In the return path, the routing functionality is reversed with the destination VTEP now performing the ingress routing and VXLAN bridging operation, hence the term asymmetric IRB.

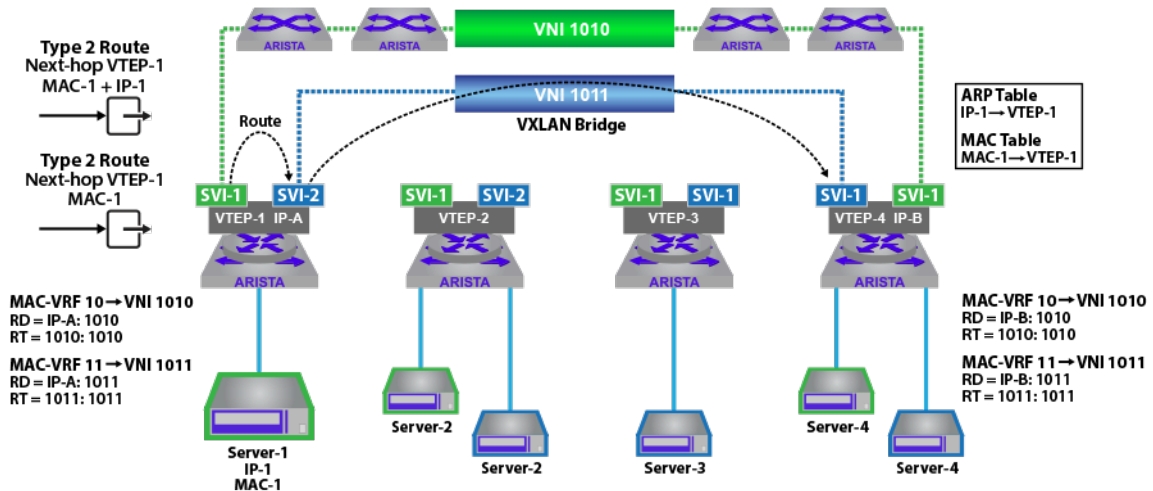

Figure 85: EVPN Asymmetric IRB

To provide inter-subnet routing on all VTEPs for all subnets, an anycast IP address is utilized for each subnet and configured on each VTEP. The anycast IP acts as the default gateway for the hosts, therefore regardless of where the host resides the directly attached VTEPs can act as the host's default gateway. The host MAC and MAC to IP bindings are learned by each VTEP based on a combination of local learning/ARP snooping and type-2 route advertisement from remote VTEPs.

In a typical implementation, the optional MAC and IP, type-2 route is advertised separately from the MAC only type-2 route. This is done so that if the MAC and IP route is cleared, for example the ARP flushed, or the ARP timeout is set to less than the MAC timeout, then the MAC only route will still exist.

The format of the two advertised type-2 routes for Server-1 are illustrated below, where the RD IP-A:1010 and route-target 1010:1010 are used to distinguish the uniqueness of the route and allow the route to be imported into the correct remote MAC-VRF based on the route-target import policy of the VTEP.

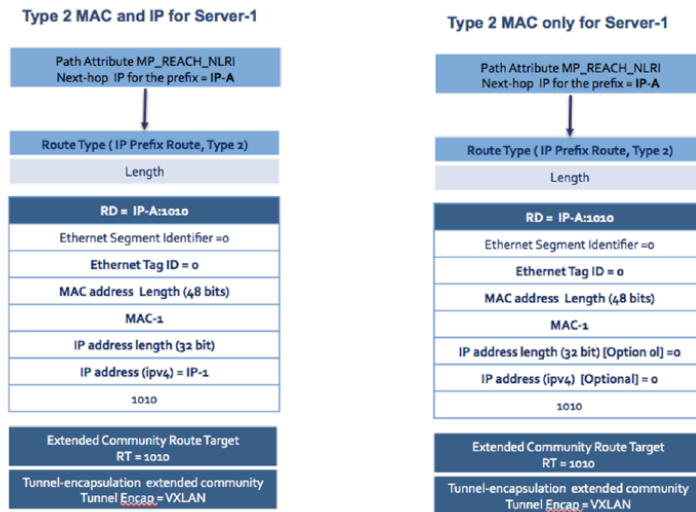

Figure 86: EVPN Comparison of MAC & MAC+IP Type 2 Route in Asymmetric IRB

For the traffic flow between Server-1 in subnet-10 and Server-4 in subnet-11, the ingress VTEP (VTEP-1) locally routes the packet into subnet-11/VNI 1011 and then VXLAN bridges the frame, inserting the VNI 1011 into the VXLAN header with an inner DMAC equal to the destination host, Server-4. This requires the receiving VTEP, (VTEP-4) to only perform a local Layer 2 lookup, based on the VNI to VLAN mapping, for the DMAC of Server-4.

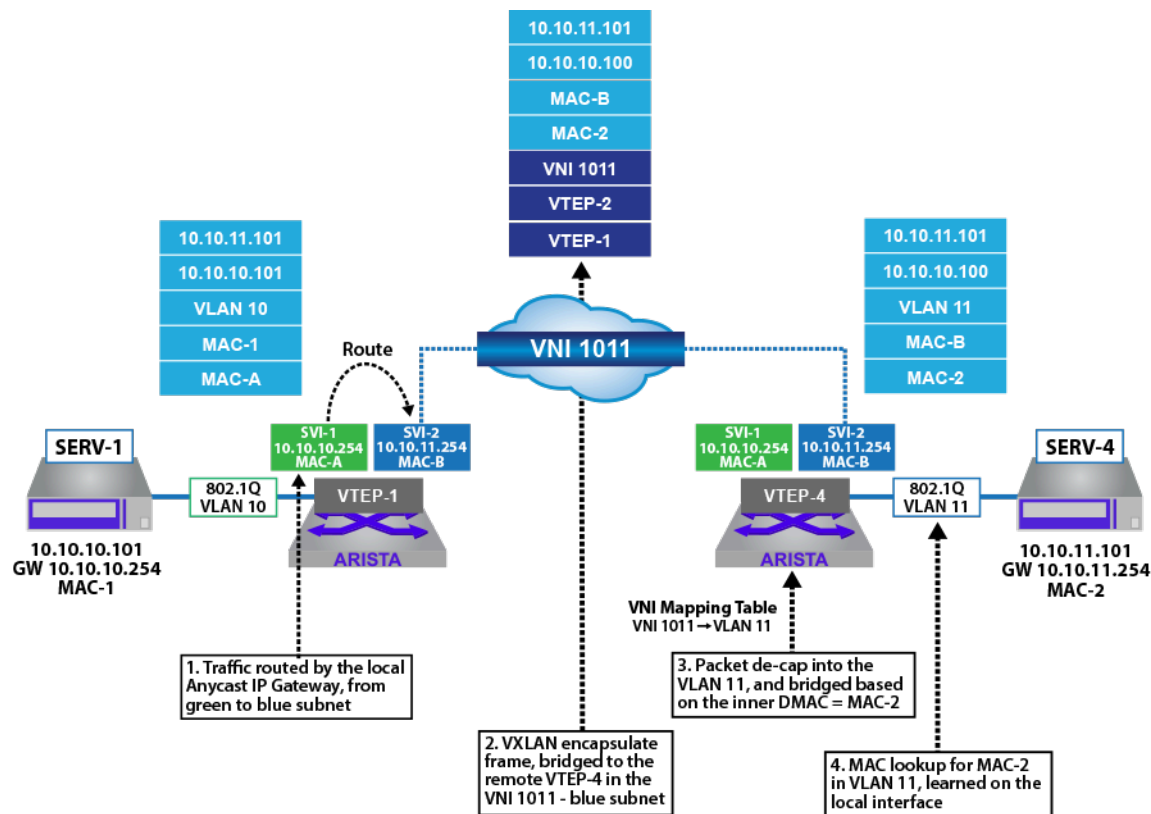

Figure 87: EVPN Asymmetric IRB VxLAN Data-plane Forwarding Detail

For the asymmetric model to operate the sending VTEP needs the information for all the tenant's hosts (MAC and MAC to IP binding), to route and bridge the packet. This means the VTEP needs to be member of all the tenant's subnets/VNI and have an associated SVI with anycast IP for all the

subnets, and this will be required on all VTEPs participating in the routing functionality for the tenant. This introduces scaling issues on multiple fronts.

- VNI Scaling: The number of VNIs supported on a hardware VTEP will be finite, so not all VNIs can reside on all VTEPs. This is especially true in data-center deployments, where the TOR's have traditionally been more resource constrained than chassis-based edge systems.
- Forwarding memory scaling: The VTEPs needs to store all host MACs and ARP entries for all subnets in the network, on leaf switch this is hardware resource which again will be a finite resource defined by the specific hardware platform deployed at the leaf.

Symmetric IRB

To address the scale issues of the asymmetric model, in the symmetric model the VTEP is only configured with the subnets that are present on the directly attached hosts. Connectivity to non-local subnets on a remote VTEP is achieved through an intermediate IP-VRF. The subsequent forwarding model for symmetric IRB is illustrated in the figure below, for traffic between Server-1 on subnet-10 (Green) and Server-4 on the remote subnet-11 (Blue). In this model, the ingress VTEP routes the traffic between the local subnet-10) and the IP-VRF, which both VTEPs are a member of, the egress VTEP then routes the frame from the IP-VRF to the destination subnet. The forwarding model results in both VTEPs performing a routing function, hence the term symmetric IRB.

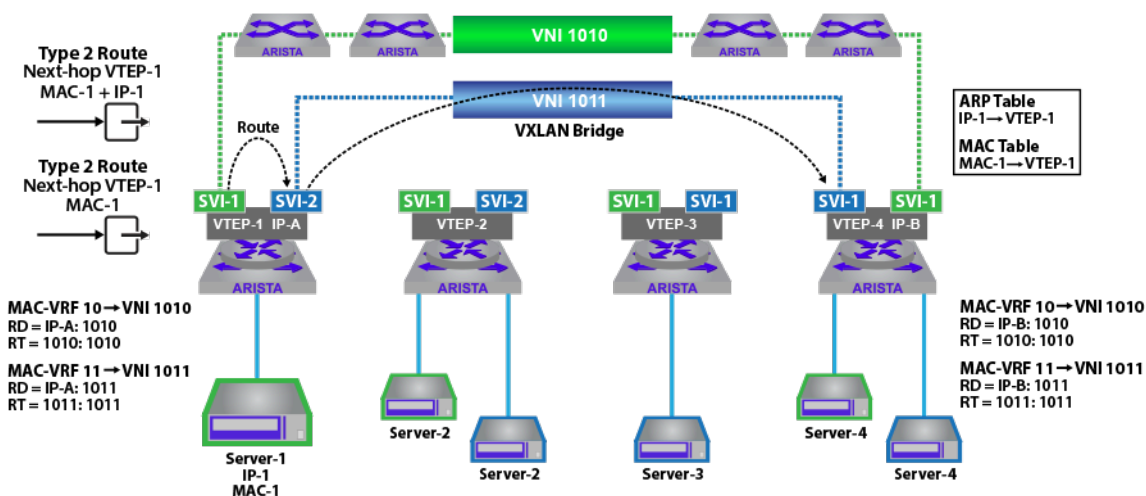

Figure 88: EVPN Symmetric IRB

To provide the inter-subnet routing, when the subnet is stretched across multiple VTEPs, an anycast IP address is utilized for each subnet, but only configured on the VTEP's where the subnet exists. The host MAC and MAC to IP bindings are learned by each VTEP based on a combination of local learning/ARP snooping and type-2 route advertisements.

For the symmetric IRB model the type-2 (MAC and IP) route is advertised with two labels and two route-targets corresponding to the MAC-VRF the MAC address is learned on and the IP-VRF. Remote VTEP's receiving the route, import the IP host route into the corresponding IP-VRF based on the IP-VRF route-target and if the corresponding MAC-VRF exists on the VTEP the MAC address is imported into the local MAC-VRF based on the MAC-VRF's Route-Target. The import behavior for the type-2 route is illustrated in the diagrams below for the host Server-1.

If the MAC-VRF exists locally on the receiving router, both the IP host route will be installed in the IP-VRF, and the MAC address will be installed in the MAC-VRF. As shown in Figure 30. With both a MAC route in the MAC-VRF and an IP host route in the IP-VRF, the VNI used in the data-path will depend on whether the traffic is being VXLAN bridged between hosts in the same VNI (1010) or VXLAN routed (VNI 2000).

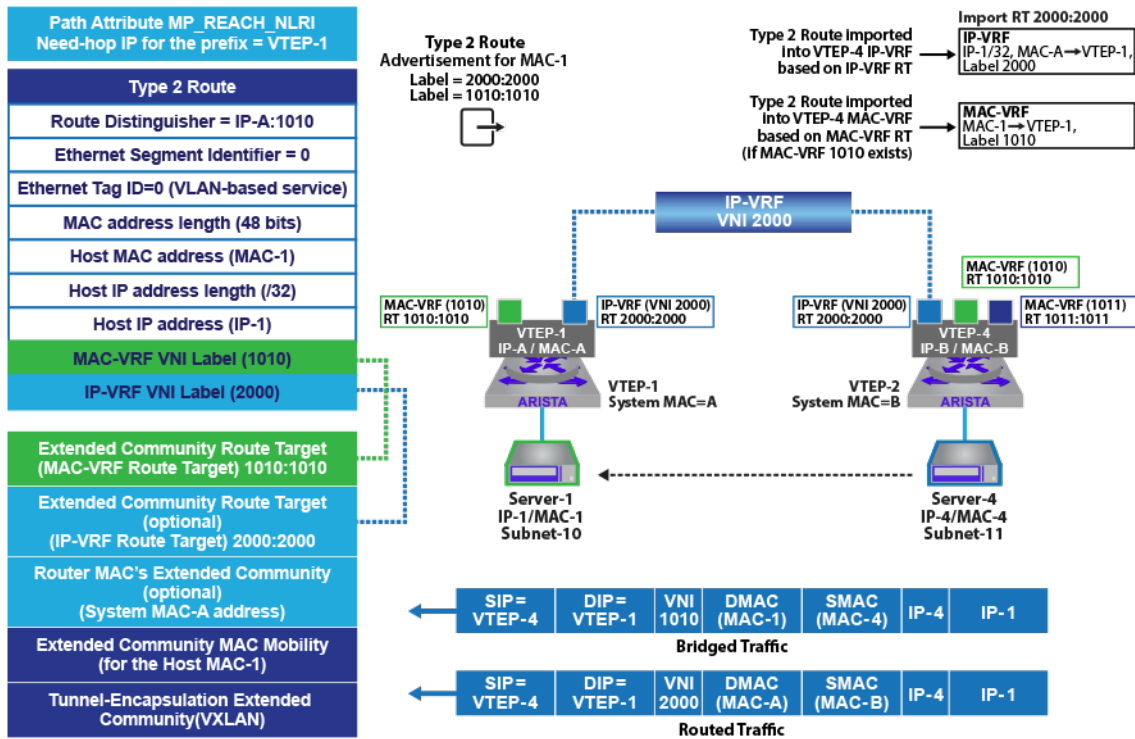

Figure 89: EVPN Type 2 Route in Symmetric IRB - MAC-VRF on Both VTEPs

Compare this to the figure below, where the MAC-VRF does not exist on the receiving VTEP (VTEP-2). In this case the MAC route is not installed and ignored, as there is no corresponding Route Target on the VTEP. In this scenario, only the IP-VRF host route is installed on VTEP-2. Traffic from VTEP-2 destined to hosts on subnet-10, are therefore always VXLAN routed via the IP-VRF, VNI 2000.

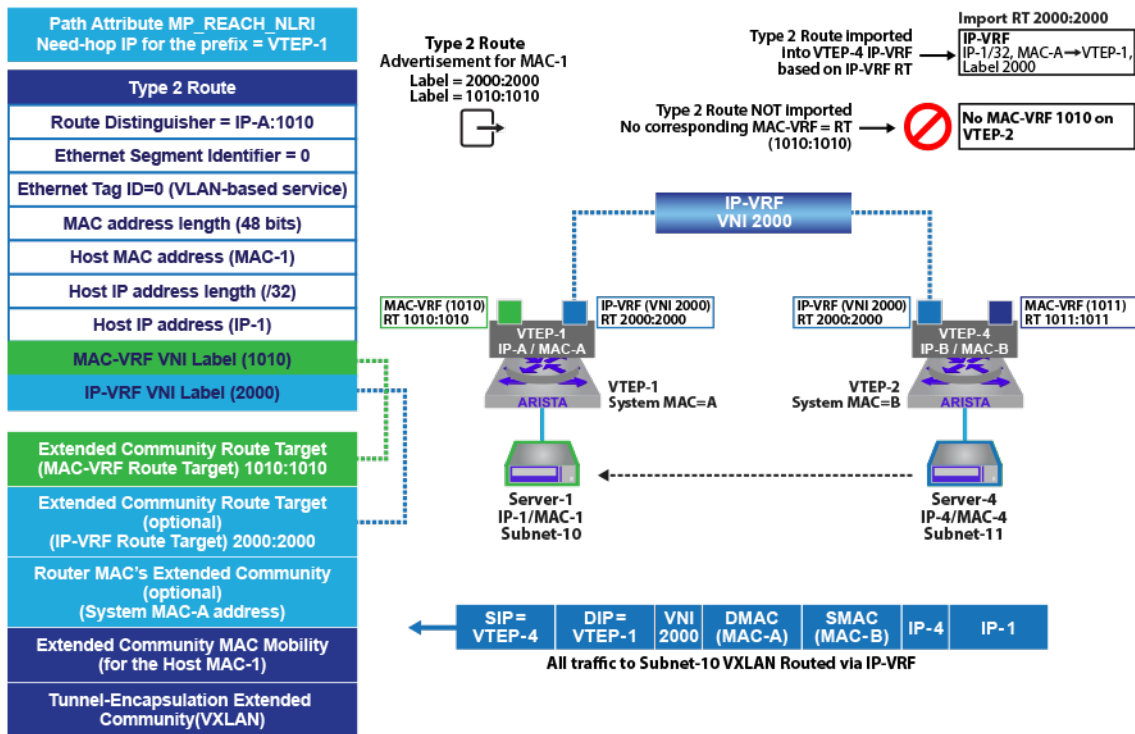

Figure 90: EVPN Type 2 Route in Symmetric IRB - MAC-VRF Only Exists on Sending VTEP

The symmetric IRB type-2 route contains a number of additional extended community attributes over the asymmetric IRB type-2 route, the salient fields of the route are summarized below.

- Multi-protocol Reachable NLRI (MP_REACH_NLRI) attribute is used to carry the next-hop hop for the advertised route. In the context of a VXLAN forwarding plane, this will be the source address of the advertising VTEP.
- Route Distinguisher of the advertising node's MAC-VRF. For Server-1 in the example above this would be IPA:1010.
- MAC address field contains the 48-bit MAC address of the host being advertised. For Server-1 in the example above this would be MAC-1.
- IP address and length field contain the IP address and 32-bit mask for the host being advertised. For Server-1 in the example above this would be IP-1.
- MAC-VRF label, this contains the VNI number (label) corresponding to the local Layer 2 domain/ MAC-VRF the host MAC was learned on. For Server-1 in the example above this would be VNI 1010.
- IP-VRF label, this contains the VNI number (label) corresponding to the MAC-VRF's associated IP-VRF. For MAC-VRF 10 in the example above this would be IP-VRF 2000.
- Extended community Route Target for the IP-VRF. This contains the route-target of the IP-VRF associated with the learned MAC address.
- Extended community Router MAC. This field advertises the system MAC of the advertising VTEP and is used as the DMAC for any packet sent to the VTEP via the IP-VRF.
- Extended community Route Target for the MAC-VRF. This contains the route-target of the MAC-VRF associated with the learned MAC address.

17.3.1 IP VPN

RFC 4364 allows Service Providers and Enterprises to use their backbone infrastructure to provide the services to multiple customers, or internal departments; while performing the following functions:

- Maintaining privacy
- Allowing for IP address overlap amongst customers
- Constraining route distribution - so that only the service provider routers which need the routes have them.

This is achieved through the usage of VRFs, Route Distinguishers and Route-Targets

The IPv4/IPv6 VPN Standard RFC 4364 does the following:

- Specifies an BGP IPv4 VPN control plane with a MPLS data plane
- BGP control plane, new address family to advertise IP VPN prefixes.
- This RFC obsoleted the original RFC 2547
- MPLS data-plane defined in multiple RFCs and drafts.

The RED circle in the figure below highlights the main Drafts and RFCs in use today for an MPLS data-plane.

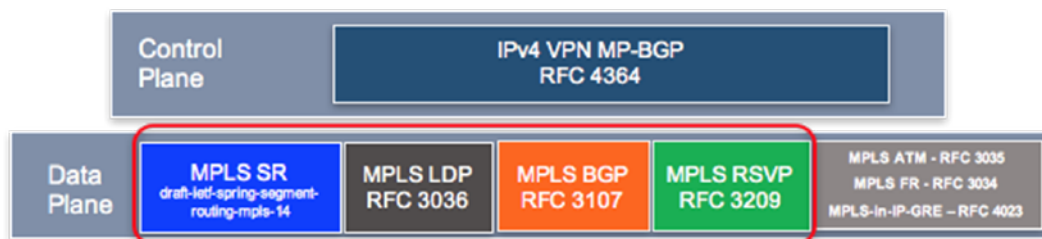

Figure 91: MPLS data-plane

IPv4 VPN and IPv6 VPN are an extensions of the BGP protocol introducing new address families: IPv4 (address family number 1), IPv6 (address family number 2), and a subsequent address family number

128: MPLS Layer 3 VPN unicast. It is used to exchange overlay IP prefix reachability information between MP-BGP peers.

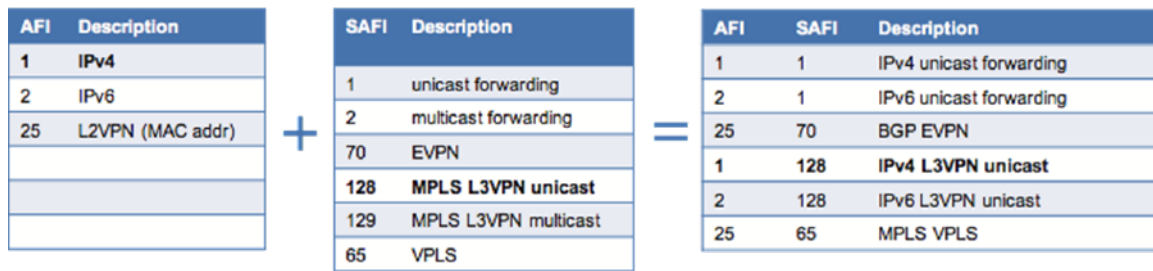

Figure 92: IPv4 VPN and IPv6 VPN

IPv4 VPN defines two route types:

- Update
- Withdrawal

Each route type has its own NLRI prefix format and each route type advertises its own set of prefixes to update/withdraw.

The format of the IPv4 VPN prefix update route is illustrated in the following figure. As detailed, the update route contains the VPN route (prefix and RD), the next-hop for the route and the advertising router ID, along with the MPLS Label, along with a number of path attributes (where the RT extended communities are defined), which are associated with these IPv4 NLRIs.

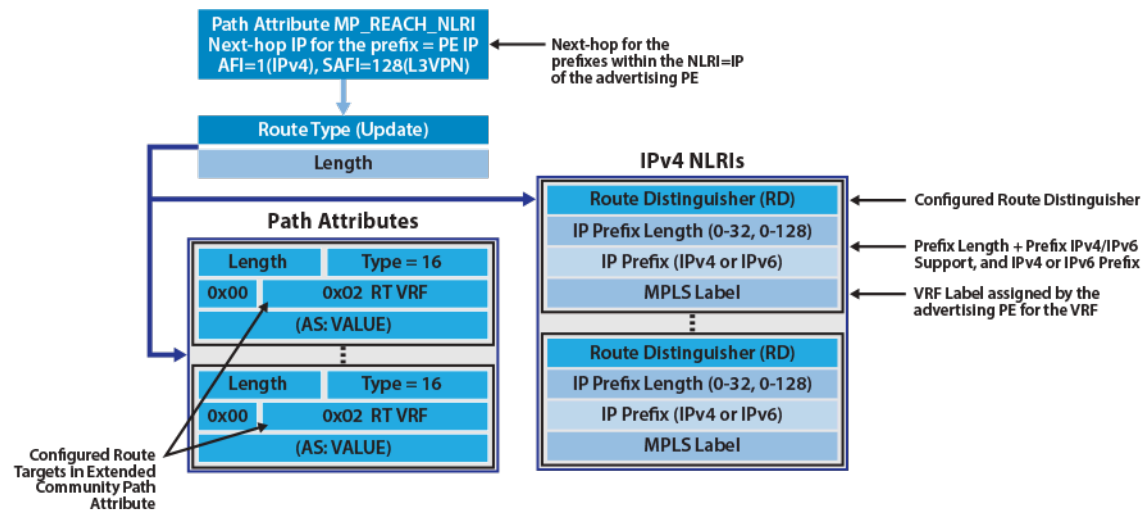

Figure 93: IPv4 and IPv6 VPN Update Route Detail

The output in P4 VPN Route as Shown on PE and IPv6 VPN Route as Shown on PE offer a more detailed view of the route as displayed on a PE router.

```
north-edge#sh bgp vpn-ipv4 206.0.0.0/24 detail
BGP routing table information for VRF default
Router identifier 1.1.1.1, local AS number 64512
BGP routing table entry for IPv4 prefix 206.0.0.0/24, Route Distinguisher: 6.6.6.6:4364
Paths: 1 available
  65010
    6.6.6.66 from 2.2.2.222 (2.2.2.222)
      Origin IGP, metric -, localpref 100, weight 0, valid, internal, best
      Extended Community: Route-target-AS164512:4364
      MPLS label: 967920
```

Figure 94: IPv4 VPN Route as Shown on PE

```

north-edge#sh bgp vni-ipv6 2006::/64 detail
BGP routing table information for VNI default
Route identifier 1.1.1.111, local AS number 65010
BGP routing table entry for IPv6 prefix 2006::/64, Route Distinguisher 6.6.6.6:65010
Path: 1 available
00000
6.6.6.66 from 2.2.2.222 [2.2.2.222]
  Origin IGP, metric -, localpref 100, weight 0, valid, internal, best
  Extended Community: Route-Target:AS774502:6364
  MPLS label: 915242

```

IPv6-prefix and RD being advertised
 Next hop (6.6.6.66) for the prefix and advertising Router (2.2.2.222)
 Route-Target (64512:6364), encapsulation (MPLS) label for the VPN route (915242)

Figure 95: IPv6 VPN Route as Shown on PE

The following is an illustration of a basic MPLS Layer 3 VPN topology.

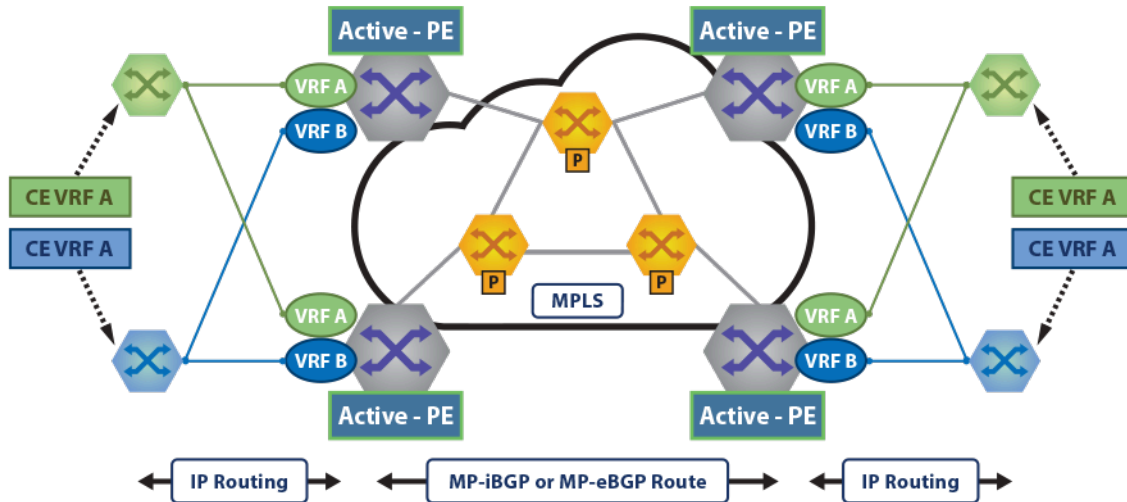

Figure 96: MPLS Layer 3 VPN Topology

An IP VRF is used on a PE router for each customer (Layer 3 overlay). VRF IP routes are exported into the MP-BGP table and advertised to remote PEs as VPN routes. The exported VPN routes carry the Route-Target (RT) extended communities that are configured as export route-targets on the IP VRF from which they were exported.

The RTs carried by the VPN routes received by a PE are matched against the VRF import route-target configuration. When a received route carries an RT that is configured as an import route-target on an IP VRF, the route is imported into the IPv4 or IPv6 table for that VRF.

PE routers allocate per-VRF and address family Labels that are advertised as part of the VPN route NLRI. Forwarding of overlay packets between PEs across the underlay requires underlay MPLS connectivity provided by a backbone.

Note: You require 4.21.1F release and later versions with Jericho/Jericho+ platforms.

17.4 VPN MPLS Transport Options

EVPN-MPLS and IP-VPN sample topologies illustrate co-existing LDP, BGP-SR, and ISIS-SR on the core.

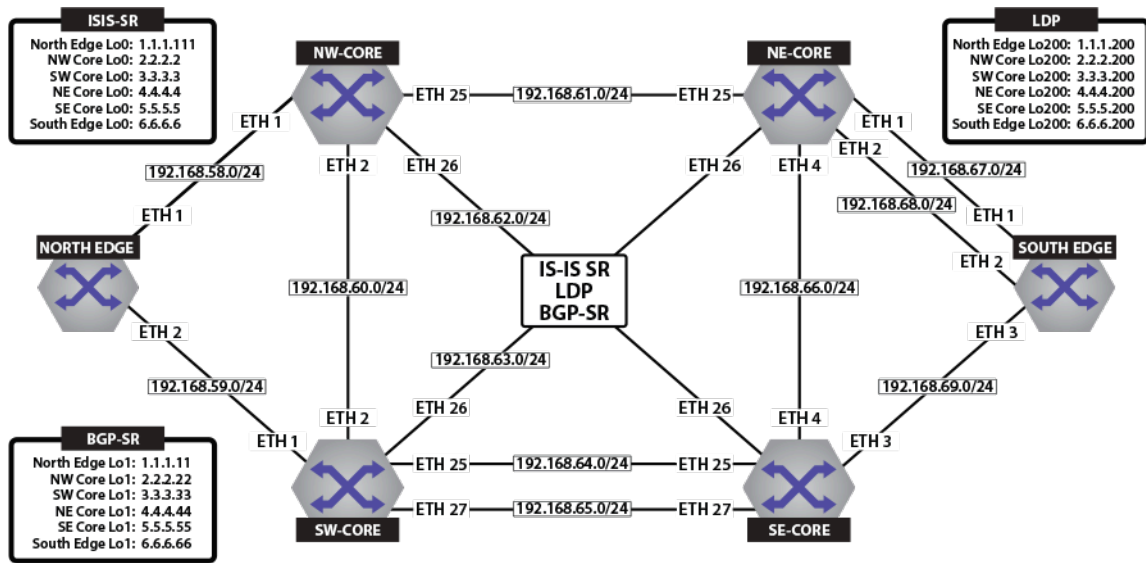

Figure 97: Physical Topology For ISIS-SR, LDP and BGP-SR Transport

LDP, ISIS-SR, and BGP-LU (BGP-SR) demonstrates the corresponding Label Switched Paths (LSPs) as the MPLS transport LSPs for Layer3 EVPN and IP VPN services.

EVPN Sample Topology

In the figures below **Tenant-A DCI** and **Tenant-B DCI**, the prefixes from each DC are transported over the WAN/DCI domain, maintaining the Layer 3 multi-tenancy in tenant-a and tenant-b.

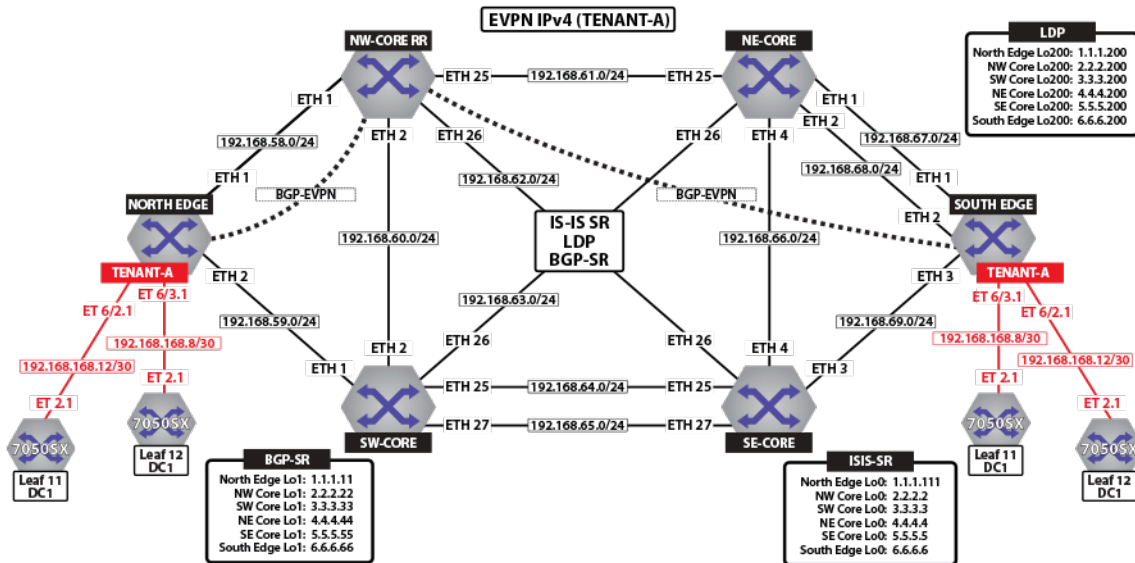

Figure 98: Tenant-A DCI

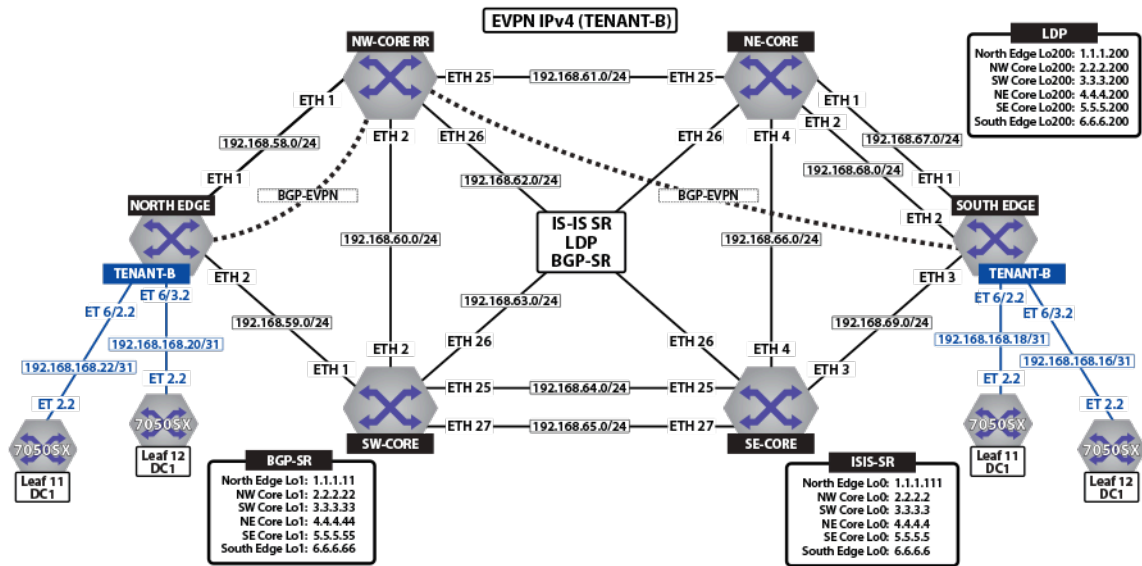

Figure 99: Tenant-B DCI

To provide external connectivity from the DC into the MPLS domain, leaf-11 and leaf-12 are eBGP peering via the tenants VRFs with the border routers. Both core routers are advertising external prefixes for Internet and any remote site connectivity (default route and ip-prefixes from the other DC for the tenant). To provide connectivity within the EVPN domain, the leaf switches (leaf-21 and leaf-2) re-advertise the prefixes into the tenant's VRF via a type-5 route advertisement, with a next-hop equal to the advertising PE.

Let us review the concepts of transport labels, advertised to provide the label switched path, or LSP, across the back-bone and the VPN, or tenant label, used by the provider edge (PE) routers to identify a particular tenant.

[EVPN MPLS Sample Configuration](#) displays BGP route updates and how the tenant VRF is transported over these transport LSPs.

IP VPN Sample Topology

Let us review the concepts of transport labels, advertised to provide the label switched path, or LSP, across the back-bone and the VPN, or tenant label, used by the Provider Edge (PE) routers to identify a particular tenant.

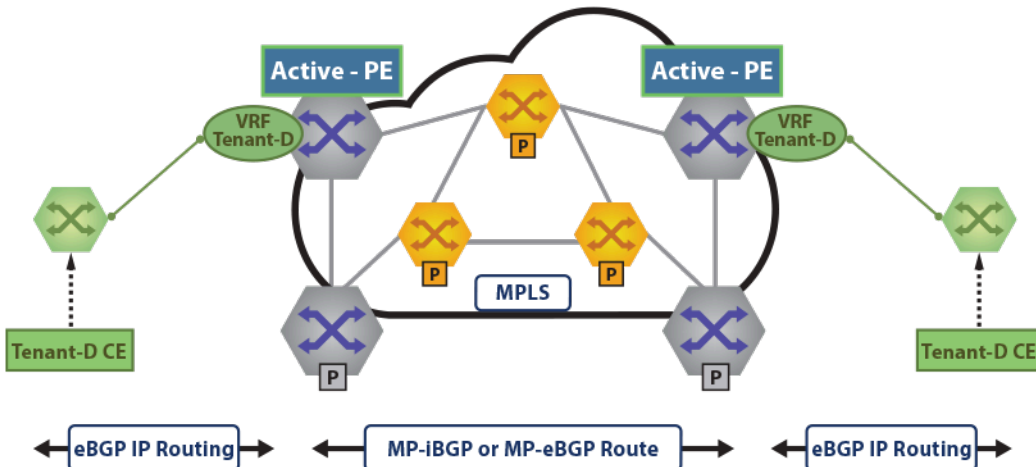

Figure 100: IPv4 & IPv6 VPN Sample Topology

In the figures **Tenant-D IPv4 VPN** and **Tenant-D IPv6 VPN**, the prefixes for VRF tenant-d are transported over the MPLS WAN between North Edge and South Edge routers.

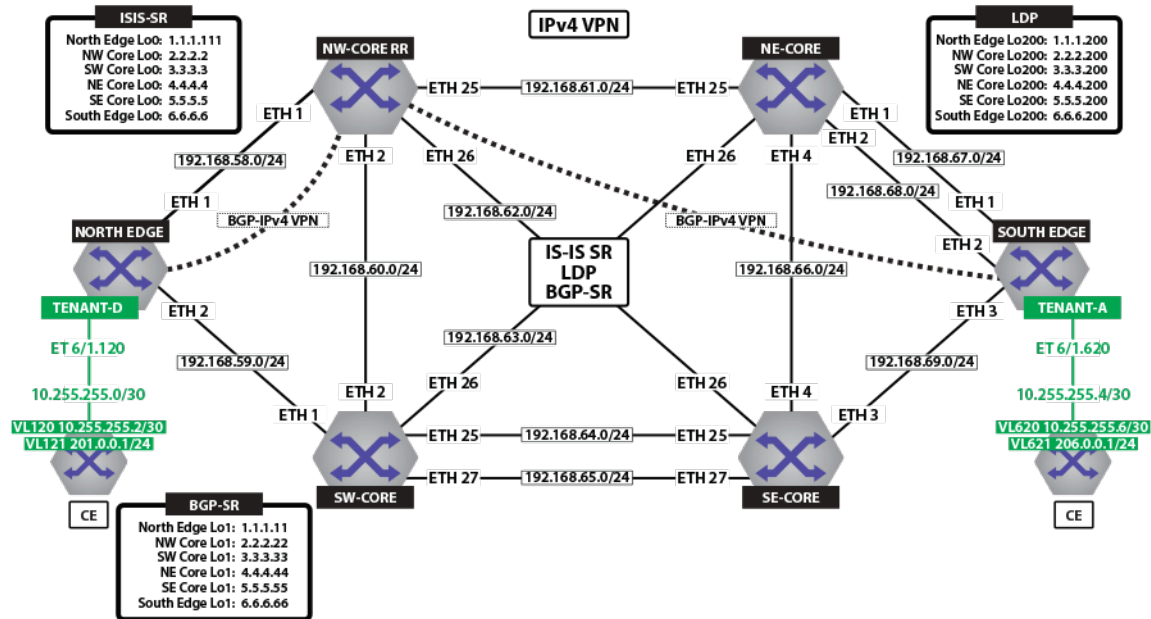

Figure 101: Tenant-D IPv4 VPN

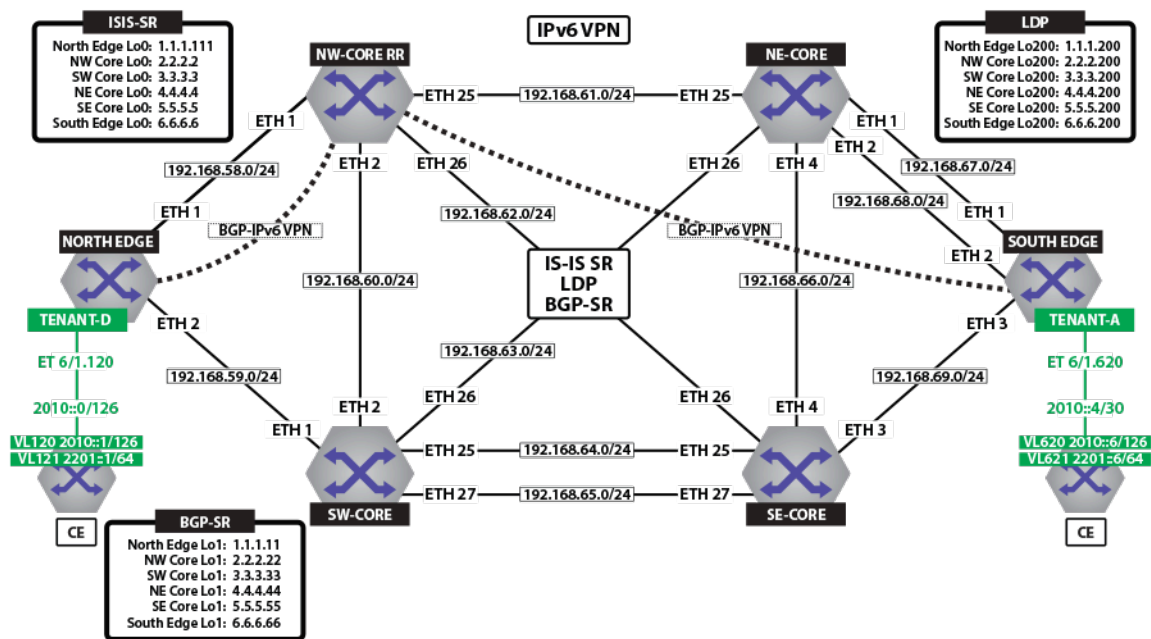

Figure 102: Tenant-D IPv6 VPN

17.4.1 LDP

The figure below illustrates how LDP neighbor relationships are built. First each router sends a discovery to a destination multicast address (TTL=1) 224.0.0.2 on port 646. This discovery contains the router-id and the transport IPv4 address the router wants to use. The second stage is building the TCP peering session using the transport IP addresses specified. This is normally loopback to loopback.

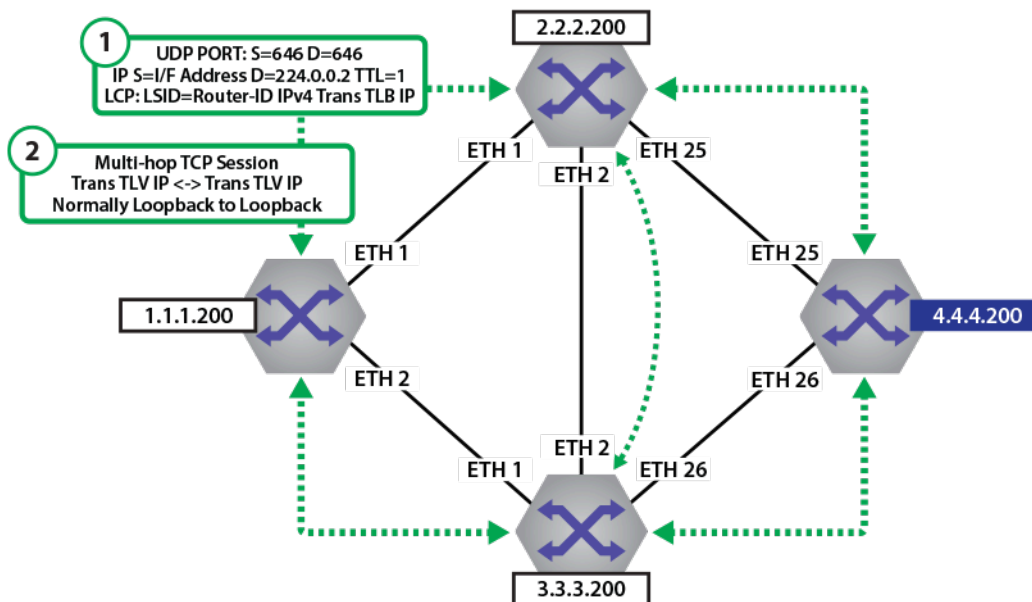

Figure 103: LDP Peering Establishment

Examples

- The `show mpls ldp neighbor` command on the North Edge router displays more detail on TCP session establishment, and the local addresses of the LDP neighbor for which it is binding a label.

Note: All connected interfaces are advertised as bound. However, EOS currently advertised labels for /32 addresses, and FEC filter is configured to install only x.x.x.200/32 prefixes.

```

North Edge.17:51:17#show mpls ldp neighbor
Peer LDP ID: 2.2.2.200:0; Local LDP ID: 1.1.1.200:0
TCP Connection: 2.2.2.200:38395 - 1.1.1.200:646
State: oper; Msgs sent/rcvd: 46/46; downstream unsolicited
Uptime: 0:06:17
KeepAlive expires in: 20.27 sec
LDP discovery sources:
  Ethernet1/1
Addresses bound to peer:
  2.2.2.200          2.2.2.2          192.168.1.177
192.168.62.11
  192.168.1.181     192.168.58.12   192.168.60.11
192.168.61.11
Peer LDP ID: 3.3.3.200:0; Local LDP ID: 1.1.1.200:0
TCP Connection: 3.3.3.200:38510 - 1.1.1.200:646
State: oper; Msgs sent/rcvd: 42/42; downstream unsolicited
Uptime: 0:05:51
KeepAlive expires in: 20.02 sec
LDP discovery sources:
  Ethernet2/1
Addresses bound to peer:
  192.168.65.11     192.168.59.12   3.3.3.200
192.168.60.12
  192.168.63.11     3.3.3.3         192.168.64.11

```

- The `show mpls lfib route 116384` command on the North Edge router displays the label POP and swap operations for any traffic traversing North Edge. As can be seen if traffic came in with label 116384 it would be swapped to the labels seen in the tunnel table.

```

North Edge.23:38:28(config)#show mpls lfib route 116384

```



```

MPLS forwarding table (Label [metric] Vias) - 1 routes
MPLS next-hop resolution allow default route: False
Via Type Codes:
    M - Mpls Via, P - Pseudowire Via,
    I - IP Lookup Via, V - Vlan Via,
    VA - EVPN Vlan Aware Via, ES - EVPN Ethernet Segment Via,
    VF - EVPN Vlan Flood Via, AF - EVPN Vlan Aware Flood Via
Source Codes:
    S - Static MPLS Route, B2 - BGP L2 EVPN,
    B3 - BGP L3 VPN, P - Pseudowire,
    L - LDP, IP - IS-IS SR Prefix Segment,
    IA - IS-IS SR Adjacency Segment, IL - IS-IS SR Segment to
LDP,
    LI - LDP to IS-IS SR Segment, BL - BGP LU,
    DE - Debug LFIB

L 116384 [1], 6.6.6.200/32
    via M, 192.168.58.12, swap 132768
    payload autoDecide, ttlMode autoDecide, apply
egress-acl
    interface Ethernet1/1
    via M, 192.168.59.12, swap 100000
    payload autoDecide, ttlMode autoDecide, apply
egress-acl
    interface Ethernet2/1

```

17.4.2 ISIS-SR

The figure below illustrates how ISIS-SR distributes the SID index information in the ISIS TLVs and sub-TLVs

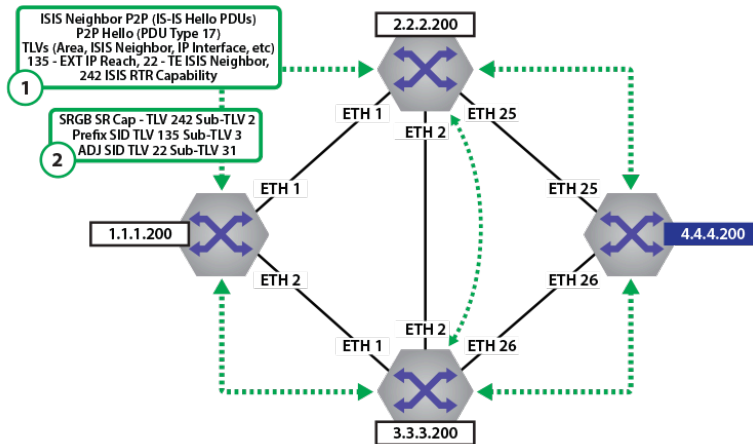

Figure 104: ISIS Neighbor Adj and TLVs

The Prefix SID index, SRGB, and ADJ SID values are populated in the sub-TLVs in the ISIS neighbor updates. Each router then builds its own database of Node (Prefix) segments (Labels) and locally assigned ADJ labels.

Examples

- The `show isis neighbors detail` command on the North Edge router displays the detailed information of all ISIS neighbors.

```

north-edge#show isis neighbors detail
Instance VRF      System Id      Type Interface      SNPA      State Hold time
Circuit Id
sr_instan default nw-core        L2  Ethernet1/1      P2P      UP      30      1D

```

```

Area Address(es): 49.0001
SNPA: P2P
Advertised Hold Time: 30
State Changed: 6d17h ago
IPv4 Interface Address: 192.168.58.12
IPv6 Interface Address: none
Interface name: Ethernet1/1
Graceful Restart: Supported
Segment Routing Enabled
  Router ID: 2.2.2.2
  SRGB Base: 408000 Range: 4096
  Adjacency Label IPv4: 953252
sr_instan default sw-core          L2  Ethernet2/1      P2P          UP    28      1E
Area Address(es): 49.0001
SNPA: P2P
Advertised Hold Time: 30
State Changed: 00:06:06 ago
IPv4 Interface Address: 192.168.59.12
IPv6 Interface Address: none
Interface name: Ethernet2/1
Graceful Restart: Supported
Segment Routing Enabled
  Router ID: 3.3.3.3
  SRGB Base: 408000 Range: 4096
  Adjacency Label IPv4: 953253

```

- The **show isis segment-routing adjacency-segments** command on the North Edge router displays the locally assigned Adjacency Segment Identifier (Adj-SIDs).

```

North Edge#show isis segment-routing adjacency-segments

System ID: north-edge          Instance: sr_instance
SR supported Data-plane: MPLS      SR Router ID: 1.1.1.111
Adj-SID allocation mode: SR-adjacencies
Adj-SID allocation pool: Base: 953249   Size: 16384
Adjacency Segment Count: 5
Flag Descriptions: F: Ipv6 address family, B: Backup, V: Value
                  L: Local, S: Set

Segment Status codes: L1 - Level-1 adjacency, L2 - Level-2 adjacency, P2P - Point-to-Point adjacency,
LAN -
Broadcast adjacency

Locally Originated Adjacency Segments
Adj IP Address      Local Intf      SID      SID Source      Flags      Type
-----
192.168.1.154      Et36/1          953249    Dynamic          F:0 B:0 V:1 L:1 S:0  P2P L2
192.168.1.174      Et23/1          953250    Dynamic          F:0 B:0 V:1 L:1 S:0  P2P L2
192.168.58.12      Et1/1           953252    Dynamic          F:0 B:0 V:1 L:1 S:0  P2P L2
192.168.59.12      Et2/1           953253    Dynamic          F:0 B:0 V:1 L:1 S:0  P2P L2
192.168.1.165      Et8/1           953254    Dynamic          F:0 B:0 V:1 L:1 S:0  P2P L2

```

17.4.3 BGP-LU (BGP-SR)

BGP-LU Label Distribution illustrates how BGP-LU distributes the label information in BGP.

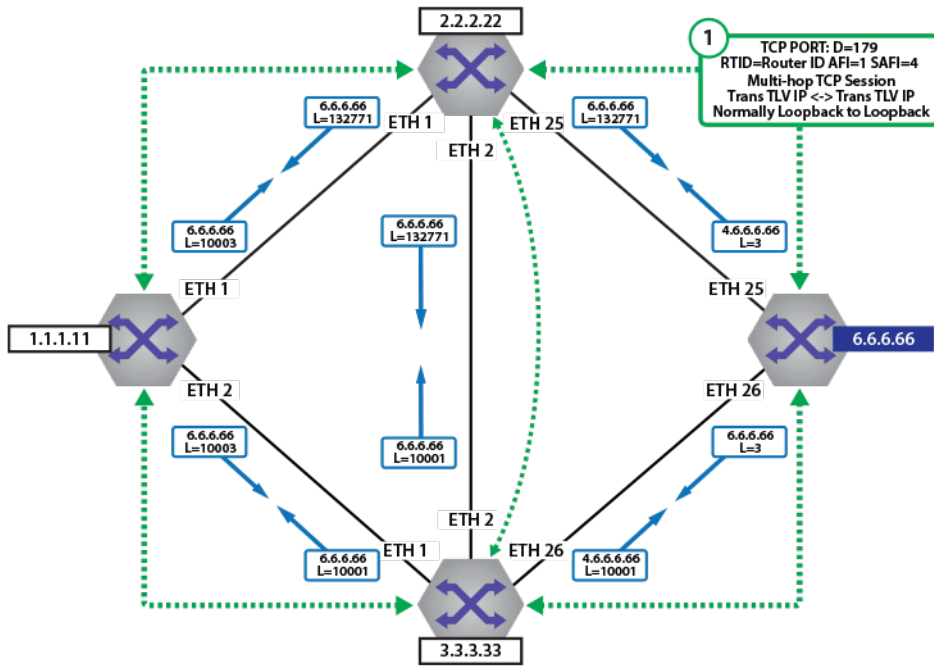

Figure 105: BGP-LU Label Distribution

BGP-SR Index and SRGB Distribution illustrates how BGP-LU distributes the Label SRGB and SID index information in BGP. This is known as BGP-SR.

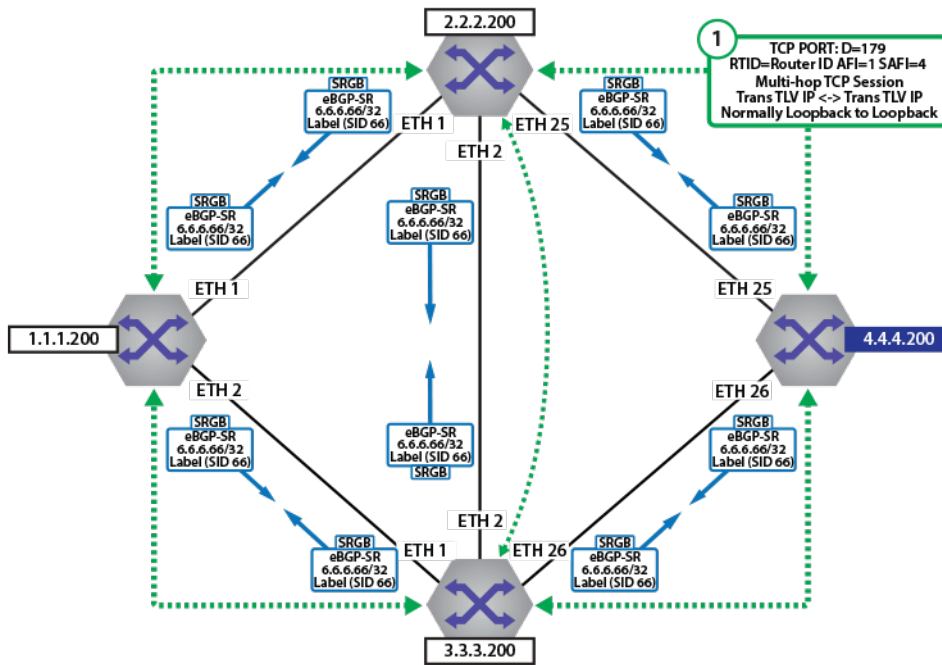

Figure 106: BGP-SR Index and SRGB Distribution

The Prefix SID index, and SRGB values are populated in the TLVs in the BGP neighbor updates. Each router then builds its own database of Node (Prefix) segments (Labels).

Examples

- The `show bgp neighbor` command displays BGP-SR neighbors.

```
north-edge#show bgp neighbor | include BGP neighbor|Multiprotocol IPv4
MplsLabel

BGP neighbor is 192.168.2.10, remote AS 64512, internal link
  Multiprotocol IPv4 MplsLabel: received
BGP neighbor is 192.168.3.9, remote AS 64512, internal link
  Multiprotocol IPv4 MplsLabel: advertised and received and
  negotiated
BGP neighbor is 192.168.3.10, remote AS 64512, internal link
  Multiprotocol IPv4 MplsLabel: advertised
BGP neighbor is 192.168.58.12, remote AS 2, external link
  Multiprotocol IPv4 MplsLabel: advertised and received and
  negotiated
BGP neighbor is 192.168.59.12, remote AS 3, external link
```

- The `show ip bgp labeled-unicast 6.6.6.66/32 detail` command displays the detailed information of BGP labeled routes unicast with 6.6.6.66/32.

```
north-edge(config-if-Et2/1)#show ip bgp labeled-unicast 6.6.6.66/32
detail
BGP routing table information for VRF default
Router identifier 1.1.1.111, local AS number 64512
BGP routing table entry for 6.6.6.66/32
  Paths: 2 available
    2 4 6
      192.168.58.12 labels [ 200066 ] from 192.168.58.12 (2.2.2.222)
        Origin IGP, metric -, localpref 100, weight 0, valid, external,
        ECMP head, best, ECMP contributor
        Local MPLS label: 200066, SR Label Index: 66
    3 4 6
      192.168.59.12 labels [ 200066 ] from 192.168.59.12 (3.3.3.200)
        Origin IGP, metric -, localpref 100, weight 0, valid, external,
        ECMP, ECMP contributor
        Not best: ECMP-Fast configured
        Local MPLS label: 200066, SR Label Index: 66
  Advertised to 2 peers:
    192.168.3.9      192.168.59.12
```

17.5 EVPN Type-5 Routes: IP Prefix Advertisement

The EVPN type 2 routes can be used to advertise IP prefixes by making use of the optional IP address and IP address length fields in the route, however they are explicitly linked to the MAC address advertised within the route. The EVPN type-5 route defined within the draft <https://tools.ietf.org/html/draft-ietf-bess-evpn-prefix-advertisement-04>, provides the ability to decouple the advertisement of an IP prefix from any specific MAC address, providing the ability to support floating IP address, optimize the mechanism for advertising external IP prefixes, and reduce the churn when withdrawing IP prefixes.

The figure below displays the format of the new type-5 IP-prefix route.

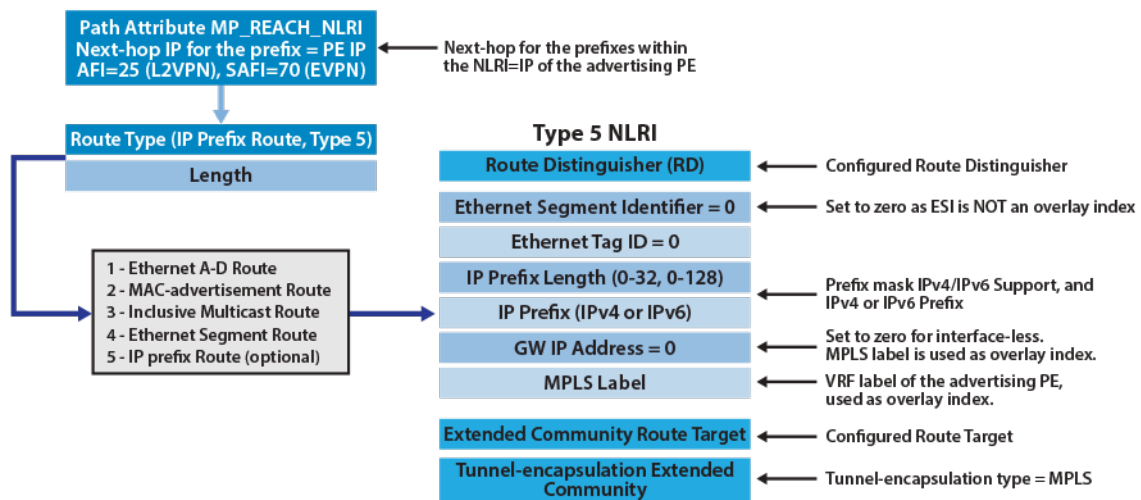

Figure 107: EVPN Route Type-5, for Advertisement of IP Prefixes

The IP prefix draft defines a number of specific use cases for the type-5 route, which consequently affect the format and content of the fields within the route. The different deployment scenarios and use cases defined within the draft are summarized below.

- Advertising of IP prefixes behind an appliance, when the appliance is not running a routing protocol and only supporting static routes. This could be the typical use case for a Virtual Firewall with a number of local subnets directly attached, but the firewall is only supporting static routes into the associated EVI.
- Support for active-standby deployment of appliances using a shared floating IP model. This is an extension of the previous case where there is now a virtual IP (or VIP) for clustering the appliances, rather than a dedicated physical IP address on the appliance.
- Support for Layer 2 appliances, acting as a “bump in the wire” with no physical IP addresses configured, where instead of the appliances having an IP next-hop there is only a MAC next-hop.
- IP-VRF to IP-VRF model, which is similar to inter-subnet forwarding for host routes (detailed in the symmetric/asymmetric section), except only Type-5 routes and IP prefixes are advertised, allowing announcement of IP prefixes into a tenant’s EVI domain for external connectivity outside the domain.

Interface-less

In interface-less mode, the IP prefixes within the type-5 route, whether they are local or learned from a connected router are advertised to remote peers via the shared IP-VRF, as illustrated in the figure below. The IP-VRF to IP-VRF model, is further divided in the draft into three distinct use cases.

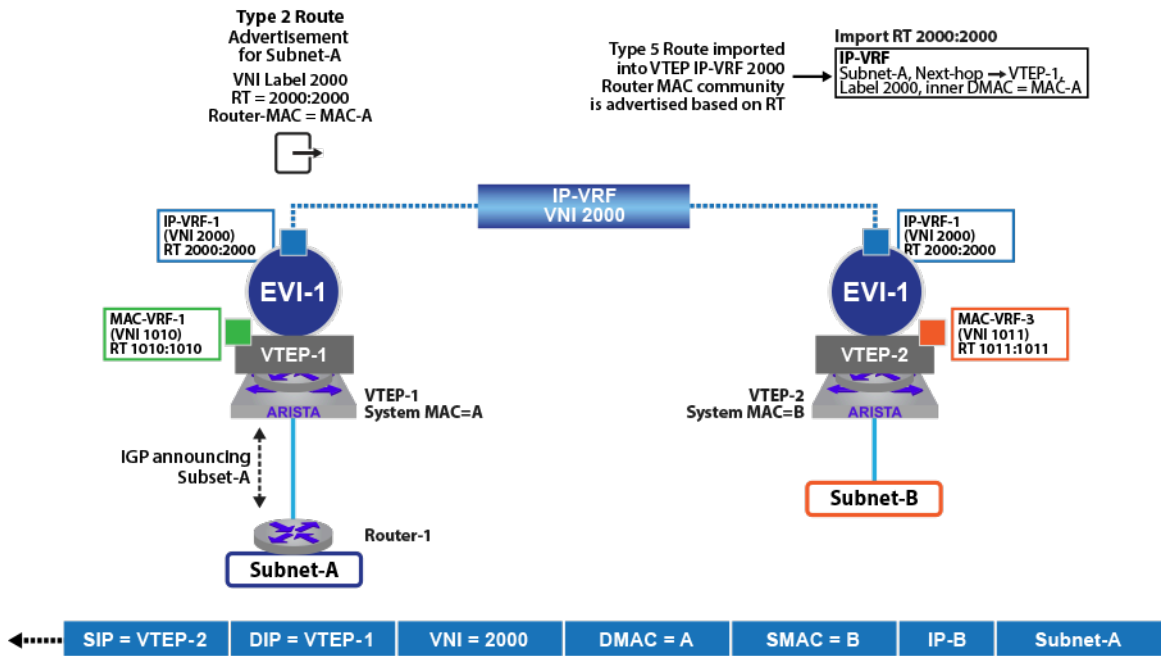

Figure 108: EVPN Route Type-5, Interface-less Update

As illustrated above, the IP prefix (subnet-A) residing behind the router (Rtr-1) is learned via an IGP in EVI-1 on VTEP-1. The prefix is announced and learned by the remote VTEPs residing in the same EVI, via the type-5 route announcement. The type-5 route, is advertised along with the prefix, with a route-target (2000:2000) and a VNI label (2000) equal to the IP-VRF which interconnects the VTEPs in the EVI, the router-mac extended community of the route is used to define the inner DMAC (equal to system MAC of VTEP-1) for any VXLAN frame destined to advertised IP prefix.

From a forwarding perspective, host residing on subnet-B communicating with a host on subnet-A, will send traffic to their default gateway which is the IRB interface on VTEP-2 in VLAN 11/VNI 1011. VTEP-2 performs a route lookup for the destination subnet-A), which has been learned in the IP-VRF with a next-hop of VTEP-1 and VNI label of 2000. The packet is thus VXLAN encapsulated with VNI label of 2000 an inner DMAC of A (VTEP-1 system/router MAC), and routed to VTEP-1, which is the next-hop for the prefix. Receiving the frame, VTEP-1 de-encapsulates the packet, with an inner DMAC of the VTEPs router MAC, it performs a local route lookup for the destination subnet-A), which has been learned with a next-hop of rtr-1. The frame is forwarded directly to rtr-1, which subsequently routes the packet to the local host on subnet-A. The format of the type-5 route in interface-less mode is illustrated in figure below.

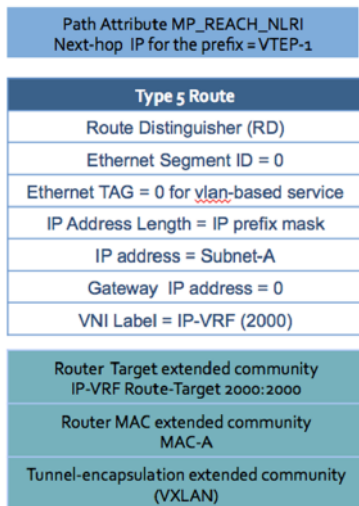

Figure 109: EVPN Type-5 Route Format for Interface-less Mode

In this model, the VTEPs forming the EVI are interconnected via an IP-VRF, meaning there is no IRB interface (MAC and IP) created for the interconnection on each of the VTEPs, hence the term “interface-less”. With no IRB interface the gateway IP address within the type-5 route is set to zero, traffic is routed to the prefix based on the next-hop of the route (VTEP IP) as well as MAC address conveyed within the Router MAC extended community, which represents the inner destination MAC of the VXLAN encapsulated frame.

17.6 BGP PIC Edge for EVPN VXLAN Routes for Remote VTEP Failures

When a remote VTEP goes down, this would require action by the IGP and BGP to recompute a new best path traffic destined to affected BGP prefixes originally reachable by the problematic VTEP. Currently, the BGP PIC is restricted to locally identifiable failures such as link failures.

To overcome such VTEP failure issues the above feature introduces support for EVPN learned VTEPs to improve convergence times in these scenarios by tying the liveness detection provided by the BFD sessions into existing BGP PIC support for software fast-failover. Without this feature, until the underlay route providing reachability to the problematic VTEP is removed from the FIB the overlay route could still forward traffic towards this VTEP. Once the underlay route is eventually removed the adjacency would be updated in place to avoid per-prefix updates so that any overlay routes containing the path to this VTEP would be corrected. However with this feature, upon detecting that a BFD session to a remote VTEP has gone down the hardware forwarding agents will update the affected adjacencies before the corresponding underlay route has been removed from the FIB which can improve convergence times.



The above diagram outlines a scenario in which CE-2 is sending traffic bound for 10.10.10.0/24 via PE-12 to PE-11 to CE-1. PE-11 goes down, however we have BFD sessions from PE-21 to the remote VTEPs of PE-11 and PE-12 and therefore detect that it goes down and quickly update the forwarding to send the traffic along the pre-computed backup path via PE-12 to CE-1.

Platform Compatibility

This feature is supported on:

- DCS-7020, DCS-7280, DCS-7500, DCS-7800 series
- DCS-7050, DCS-7060, DCS-7250, DCS-7260, DCS-7300 series

17.6.1 Configuring BGP PIC Edge for EVPN VXLAN Routes for Remote VTEP

Failures

Use the `bfd vtep evpn` command to configure the BGP PIC Edge for EVPN VXLAN routes for remote VTEPs. This command is configured under the VXLAN Tunnel Interface (VTI).

```
switch#config
switch(config)#interface Vxlan1
switch(config-if-Vxl)#bfd vtep evpn interval <interval> min-rx <min-rx>
multiplier <multiplier>
```

This configuration uses the specified timer values to initiate BFD sessions for all VTEPs learned through EVPN VXLAN for this VTI.

- `interval` – Transmit rate in milliseconds
- `min-rx` – Expected minimum incoming rate in milliseconds
- `multiplier` – BFD multiplier

Example

```
switch(config-if-Vxl)#bfd vtep evpn interval 100 min-rx 100 multiplier 3
```

In this example (assuming symmetric configuration on other PE devices) any BFD for VXLAN session initiated on the VTI would have a detect time of 300ms (interval of 100ms multiplied by 3).

To utilize these BFD sessions, there must also be an alternate path traffic can take in the event that the session goes down. This would include other paths in an ECMP group or a backup path.

As mentioned, by default the above configuration will initiate BFD sessions for all VTEPs learned through EVPN VXLAN for the VTI.

```
switch#config
switch(config)#interface Vxlan1
switch(config-if-Vxl)#bfd vtep evpn prefix-list <PREFIX-LIST>
```

This command uses a supplied prefix list to filter and select the candidate VTEPs. By default, an empty prefix list will act as a deny-all and not initiate BFD sessions with any learned VTEPs.

17.6.2 Show Commands

The existing `show interface <VTI>` command is used to view whether BFD is enabled on the VTI and to see the timers used for any of the BFD sessions or any prefix-list configured for filtering BFD sessions.

```
switch#show interface Vxlan1
Vxlan1 is up, line protocol is up (connected)
Hardware is Vxlan
Source interface is Loopback0 and is active with 10.1.1.1
Replication/Flood Mode is headend with Flood List Source: CLI
```



```

Remote MAC learning is disabled
VNI mapping to VLANs
Static VLAN to VNI mapping is
Dynamic VLAN to VNI mapping for 'evpn' is
  [4092, 30000]      [4093, 20000]
Dynamic VLAN to VNI mapping for 'vccbfd' is
  [4091, 0]
Note: All Dynamic VLANs used by VCS are internal VLANs.
      Use 'show vxlan vni' for details.
Static VRF to VNI mapping is
  [vrf0, 20000]
MLAG Shared Router MAC is 0000.0000.0000
BFD is enabled with transmit interval 50, receive interval 50,
multiplier 3, VTEP prefix list pl-example

```

The existing **show bfd peers** command is used to view the state of the BFD for VXLAN sessions.

```

switch#show bfd peers
VRF name: default
-----
DstAddr      MyDisc      YourDisc      Interface/Transport      Type
LastUp              LastDown      LastDiag      State
-----
-----
10.1.1.2      1965370229  3607849318    NA                        VXLAN
01/12/21 10:45              NA            No Diagnostic            Up
10.1.1.3      1355343148  2407539267    NA                        VXLAN
01/12/21 10:45              NA            No Diagnostic            Up

```

The **show ip route <VRF>** command can be used to determine which prefixes are eligible for fast-failover.

```

switch#show ip route vrf example-vrf

VRF: example-vrf
Codes: C - connected, S - static, K - kernel,
       O - OSPF, IA - OSPF inter area, E1 - OSPF external type 1,
       E2 - OSPF external type 2, N1 - OSPF NSSA external type 1,
       N2 - OSPF NSSA external type2, B - BGP, B I - iBGP, B E - eBGP,
       R - RIP, I L1 - IS-IS level 1, I L2 - IS-IS level 2,
       O3 - OSPFv3, A B - BGP Aggregate, A O - OSPF Summary,
       NG - Nexthop Group Static Route, V - VXLAN Control Service,
       DH - DHCP client installed default route, M - Martian,
       DP - Dynamic Policy Route, L - VRF Leaked,
       RC - Route Cache Route

Gateway of last resort is not set

C          20.0.2.0/24 is directly connected, Ethernet14/1
B E        99.99.0.0/24 [200/0] via VTEP 10.1.1.2 VNI 30000 router-mac
fc:bd:67:3d:21:fd
                                         via VTEP 10.1.1.3 VNI 30000 router-mac
ba:ed:43:3f:ca:8e backup

```

In the above example there is a prefix with the primary path using a VXLAN tunnel to VTEP 10.1.1.2 and has a backup VXLAN tunnel to VTEP 10.1.1.3. Both paths are monitored via BFD.

In other use cases the prefix may have multiple paths with ECMP in which one or multiple of the paths are VXLAN tunnels to remote VTEPs monitored by these BFD for VXLAN sessions.

```

switch#show ip route vrf example-vrf

```

```

VRF: example-vrf
Codes: C - connected, S - static, K - kernel,
       O - OSPF, IA - OSPF inter area, E1 - OSPF external type 1,
       E2 - OSPF external type 2, N1 - OSPF NSSA external type 1,
       N2 - OSPF NSSA external type2, B - BGP, B I - iBGP, B E - eBGP,
       R - RIP, I L1 - IS-IS level 1, I L2 - IS-IS level 2,
       O3 - OSPFv3, A B - BGP Aggregate, A O - OSPF Summary,
       NG - Nexthop Group Static Route, V - VXLAN Control Service,
       DH - DHCP client installed default route, M - Martian,
       DP - Dynamic Policy Route, L - VRF Leaked,
       RC - Route Cache Route

Gateway of last resort is not set

C      20.0.2.0/24 is directly connected, Ethernet14/1
B E    99.99.0.0/24 [200/0] via VTEP 10.1.1.2 VNI 30000 router-mac
fc:bd:67:3d:24:fe
                                     via VTEP 10.1.1.3 VNI 30000 router-mac
ba:ed:43:3f:ca:8e

```

MLAG

This feature is applicable only to the scenario when remote prefix is known via two different MLAG VTEP pairs.

Prior to 4.26.0F this feature is only supported on the primary switch of an MLAG pair due to use of Shared VTEP IP within MLAG pair as VXLAN tunnel source/destination. If BFD for VXLAN packets are received on the secondary MLAG switch, they will be forwarded to the primary MLAG switch for processing. Because only the primary MLAG switch will have BFD state for remote VTEPs, if a BFD session to a remote VTEP goes down only the primary MLAG switch will perform the fast-failover while the secondary MLAG switch will retain current behavior. Therefore it is not recommended to use this feature in conjunction with MLAG.

As of 4.26.0F, the primary MLAG switch will sync its BFD for VXLAN state to the secondary MLAG switch to allow the secondary to failover to an alternate path as well. To view the synced state, a new show command has been added.

```

switch#show bfd peers protocol vxlan mlag primary
Remote VTEPs for Vxlan1 on MLAG primary:
VTEP          BFD Status
-----
10.1.1.2      up
10.1.1.3      up

```

However, because this state is synced across devices, the secondary MLAG switch will not be as performant in reacting to the BFD state transitions as the primary MLAG switch which is natively responding to the BFD session.

Another exception is the multi-VTEP MLAG feature, which allows BFD for VXLAN to run on the secondary MLAG switch. More information on multi-VTEP MLAG can be found in the multi-VTEP MLAG TOI. When running with multi-VTEP MLAG both the primary and secondary switches will run independent BFD sessions to remote VTEPs and react to BFD state transitions separately. Each switch will use the local VTEP IP of the VTI as the source IP address for the BFD sessions, which must differ from the MLAG VTEP IP.

In summary, it is not recommended to use MLAG with this feature unless configured with the multi-VTEP IP feature referenced above.

17.6.3 Troubleshooting

- Ensure that BFD configuration is present on the relevant VTI and that the VTI status shows BFD as being enabled using the mentioned “show interface <VTI>” command.
- As mentioned in the prior section, BFD state transitions are Syslogged and will display if a BFD session to a remote VTEP goes down.
- Upon fast-failover to a separate path, **show ip route** will still display FIB state that may display the original path. To view the post failover prefix state, **show ip hardware ale vrf <VRF> <prefix>** can be used instead.

17.6.4 Limitations

- Support is limited to EVPN VXLAN.
- IPv6 VXLAN underlay with this feature is not supported.

17.7 Inter-VRF Local Route Leaking

Inter-VRF local route leaking allows the leaking of routes from one VRF (the source VRF) to another VRF (the destination VRF) on the same router. Inter-VRF routes can exist in any VRF (including the default VRF) on the system. Routes can be leaked using the following methods:

- [Inter-VRF Local Route Leaking using BGP VPN](#)
- [Inter-VRF Local Route Leaking using VRF-leak Agent](#)

17.7.1 Inter-VRF Local Route Leaking using BGP VPN

Inter-VRF local route leaking allows the user to export and import routes from one VRF to another on the same device. This is implemented by exporting routes from a VRF to the local VPN table using route target extended community list and then importing the same route target extended community lists from the local VPN table into the target VRF. VRF route leaking is supported on VPN-IPv4, VPN-IPv6, and EVPN types.

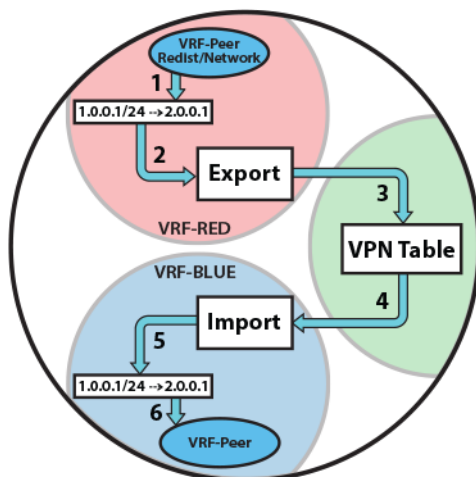

Figure 110: Inter-VRF Local Route Leaking using Local VPN Table

Accessing Shared Resources Across VPNs

To access shared resources across VPNs, all the routes from the shared services VRF must be leaked into each of the VPN VRFs and customer routes must be leaked into the shared services VRF for return traffic. Accessing shared resources allows one to export the route target of the shared services VRF into all customer VRFs, and allows the shared services VRF to import route targets from

customers A and B. The figure below shows how to provide customers, corresponding to multiple VPN domains, access to services like DHCP available in the shared VRF.

Route leaking across the VRFs is supported on VPN-IPv4, VPN-IPv6, and EVPN.

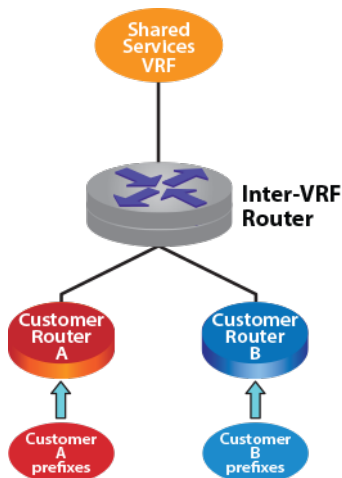

Figure 111: Accessing Shared Resources Across VPNs

17.7.1.1 Configuring Inter-VRF Local Route Leaking

Inter-VRF local route leaking is configured using VPN-IPv4, VPN-IPv6, and EVPN. Prefixes can be exported and imported using any of the configured VPN types. Ensure that the same VPN type that is exported is used while importing.

Leaking unicast IPv4 or IPv6 prefixes is supported and achieved by exporting prefixes locally to the VPN table and importing locally from the VPN table into the target VRF on the same device as shown in the figure titled **Inter-VRF Local Route Leaking using Local VPN Table** using the `route-target` command.

Exporting or importing the routes to or from the EVPN table is accomplished with the following two methods:

- Using VXLAN for encapsulation
- Using MPLS for encapsulation

Using VXLAN for Encapsulation

To use VXLAN encapsulation type, ensure that VRF to VNI mapping is present and the interface status for the VXLAN interface is up. This is the default encapsulation type for EVPN.

Example:

- The configuration for VXLAN encapsulation type is as follows:

```
switch(config)#router bgp 65001
switch(config-router-bgp)#address-family evpn
switch(config-router-bgp-af)#neighbor default encapsulation vxlan next-
hop-self source-interface Loopback0

switch(config)#hardware tcam
switch(config-hw-tcam)#system profile vxlan-routing
switch(config-hw-tcam)#interface Vxlan1
switch(config-hw-tcam-if-Vx1)#vxlan source-interface Loopback0
switch(config-hw-tcam-if-Vx1)#vxlan udp-port 4789
switch(config-hw-tcam-if-Vx1)#vxlan vrf vrf-blue vni 20001
switch(config-hw-tcam-if-Vx1)#vxlan vrf vrf-red vni 10001
```

Using MPLS for Encapsulation

To use MPLS encapsulation type to export to the EVPN table, MPLS needs to be enabled globally on the device and the encapsulation method needs to be changed from default type, that is VXLAN to MPLS under the EVPN address-family sub-mode.

Example:

```
switch(config)#router bgp 65001
switch(config-router-bgp)#address-family evpn
switch(config-router-bgp-af)#neighbor default encapsulation mpls next-
hop-self source-interface Loopback0
```

17.7.1.2 Route-Distinguisher

Route-Distinguisher (RD) is used to uniquely identify routes from a particular VRF. Route distinguisher is configured for every VRF from which routes are exported from or imported into.

The following commands are used to configure route distinguisher for a VRF.

```
Switch(config-router-bgp)#vrf vrf-services
Switch(config-router-bgp-vrf-vrf-services)#rd 1.0.0.1:1

Switch(config-router-bgp)#vrf vrf-blue
Switch(config-router-bgp-vrf-vrf-blue)#rd 2.0.0.1:2
```

17.7.1.3 Exporting Routes from a VRF

Use the **route-target export** command to export routes from a VRF to the local VPN or EVPN table using the route target extended community list.

Examples

- These commands export routes from vrf-red to the local VPN table.

```
switch(config)#service routing protocols model multi-agent
switch(config)#mpls ip
switch(config)#router bgp 65001
switch(config-router-bgp)#vrf vrf-red
switch(config-router-bgp-vrf-vrf-red)#rd 1:1
switch(config-router-bgp-vrf-vrf-red)#route-target export vpn-ipv4
10:10
switch(config-router-bgp-vrf-vrf-red)#route-target export vpn-ipv6
10:20
```

- These commands export routes from vrf-red to the EVPN table.

```
switch(config)#router bgp 65001
switch(config-router-bgp)#vrf vrf-red
switch(config-router-bgp-vrf-vrf-red)#rd 1:1
switch(config-router-bgp-vrf-vrf-red)#route-target export evpn 10:1
```

17.7.1.4 Importing Routes into a VRF

Use the **route-target import** command to import the exported routes from the local VPN or EVPN table to the target VRF using the route target extended community list.

Examples

- These commands import routes from the VPN table to vrf-blue.

```
switch(config)#service routing protocols model multi-agent
switch(config)#mpls ip
switch(config)#router bgp 65001
switch(config-router-bgp)#vrf vrf-blue
switch(config-router-bgp-vrf-vrf-blue)#rd 2:2
switch(config-router-bgp-vrf-vrf-blue)#route-target import vpn-ipv4
10:10
switch(config-router-bgp-vrf-vrf-blue)#route-target import vpn-ipv6
10:20
```

- These commands import routes from the EVPN table to vrf-blue.

```
switch(config)#router bgp 65001
switch(config-router-bgp)#vrf vrf-blue
switch(config-router-bgp-vrf-vrf-blue)#rd 2:2
switch(config-router-bgp-vrf-vrf-blue)#route-target import evpn 10:1
```

17.7.1.5 Exporting and Importing Routes using Route Map

To manage VRF route leaking, control the prefixes that are exported and imported with route-map export or import commands. The route map is effective only if the VRF paths or the VPN paths are already candidates for export or import. It is mandatory to have the route-target export or import command configured first. Setting BGP attributes using route maps is effective only on the export end.

 **Note:** Prefixes that are leaked are not re-exported to the VPN table from the target VRF.

Examples

- These commands export routes from vrf-red to the local VPN table.

```
switch(config)#service routing protocols model multi-agent
switch(config)#mpls ip
switch(config)#router bgp 65001
switch(config-router-bgp)#vrf vrf-red
switch(config-router-bgp-vrf-vrf-red)#rd 1:1
switch(config-router-bgp-vrf-vrf-red)#route-target export vpn-ipv4
10:10
switch(config-router-bgp-vrf-vrf-red)#route-target export vpn-ipv6
10:20
switch(config-router-bgp-vrf-vrf-red)#route-target export vpn-ipv4
route-map EXPORT_V4_ROUTES_TO_VPN_TABLE
switch(config-router-bgp-vrf-vrf-red)#route-target export vpn-ipv6
route-map EXPORT_V6_ROUTES_TO_VPN_TABLE
```

- These commands export routes to from vrf-red to the EVPN table.

```
switch(config)#router bgp 65001
switch(config-router-bgp)#vrf vrf-red
switch(config-router-bgp-vrf-vrf-red)#rd 1:1
switch(config-router-bgp-vrf-vrf-red)#route-target export evpn 10:1
switch(config-router-bgp-vrf-vrf-red)#route-target export evpn route-
map EXPORT_ROUTES_TO_EVPN_TABLE
```

- These commands import routes from the VPN table to vrf-blue.

```
switch(config)#service routing protocols model multi-agent
switch(config)#mpls ip
```

```

switch(config)#router bgp 65001
switch(config-router-bgp)#vrf vrf-blue
switch(config-router-bgp-vrf-vrf-blue)#rd 1:1
switch(config-router-bgp-vrf-vrf-blue)#route-target import vpn-ipv4
10:10
switch(config-router-bgp-vrf-vrf-blue)#route-target import vpn-ipv6
10:20
switch(config-router-bgp-vrf-vrf-blue)#route-target import vpn-ipv4
route-map IMPORT_V4_ROUTES_VPN_TABLE
switch(config-router-bgp-vrf-vrf-blue)#route-target import vpn-ipv6
route-map IMPORT_V6_ROUTES_VPN_TABLE

```

- These commands import routes from the EVPN table to *vrf-blue*.

```

switch(config)#router bgp 65001
switch(config-router-bgp)#vrf vrf-blue
switch(config-router-bgp-vrf-vrf-blue)#rd 2:2
switch(config-router-bgp-vrf-vrf-blue)#route-target import evpn 10:1
switch(config-router-bgp-vrf-vrf-blue)#route-target import evpn route-
map IMPORT_ROUTES_FROM_EVPN_TABLE

```

17.7.2 Inter-VRF Local Route Leaking using VRF-leak Agent

Inter-VRF local route leaking allows the leaking of routes from one VRF to another using route map as a VRF-leak agent. VRFs are leaked based on the preferences assigned to each VRF.

17.7.2.1 Configuring Route Maps

Use **router general** command to configure route maps to leak routes from one VRF to another. Routes in VRF “VRF1” that match the policy “RM1” are considered for leaking into VRF “VRF2”. If two or more policies specify leaking the same prefix to the same destination VRF, then the route with a higher (post-set-clause) distance and preference is chosen.

Example

These commands configure a route-map to leak routes from “VRF1” to “VRF2” using a route-map “RM1”.

```

switch(config)#router general
switch(config-router-general)#vrf VRF2
switch(config-router-general-vrf-VRF2)#leak routes source-vrf VRF1
subscribe-policy RM1

```

17.8 Static Inter-VRF Route

The Static Inter-VRF Route feature adds support for static inter-VRF routes. This enables the configuration of routes to destinations in one ingress VRF with an ability to specify a next-hop in a different egress VRF through a static configuration.

You can configure static inter-VRF routes in default and non-default VRFs. A different egress VRF is achieved by “tagging” the “**next-hop**” or “**forwarding via**” with a reference to an egress VRF (different from the source VRF) in which that next-hop should be evaluated. Static inter-VRF routes with ECMP next-hop sets in the same egress VRF or heterogeneous egress VRFs can be specified.

The Static Inter-VRF Route feature is independent and complementary to other mechanisms that can be used to setup local inter-VRF routes. The other supported mechanisms in EOS and the broader use-cases they support are documented here:

- [Local Route leaking using BGP VPN](#)
- [Local Route leaking using EOS RouteLeak Agent](#)

17.8.1 Platform Compatibility

Static inter-VRF routes are supported on all EOS devices, but only with the routing system in the multi-agent mode.

17.8.2 Configuration

The configuration to setup static-Inter VRF routes in an ingress (source) VRF to forward IP traffic to a different egress (target) VRF can be done in the following modes:

- This command creates a static route in one ingress VRF that points to a next-hop in a different egress VRF.

```
switch(config)#ip|ipv6 route [vrf vrf-name destination-prefix [egress-
vrf egress-next-hop vrf-name] next-hop
```

- This command creates a static route in one ingress VRF that points to an exit interface in a different egress VRF.

```
switch(config)#ip|ipv6 route [vrf vrf-name] destination-prefix [egress-
vrf egress-interface vrf-name] interface
```

- This command creates a static route in one ingress VRF that points to a next-hop that is bound to an interface in a different egress VRF.

```
switch(config)#ip|ipv6 route [vrf vrf-name] destination-prefix [egress-
vrf egress-interface vrf-name] interface
```

17.8.3 Show Commands

Use the `show ip route vrf` to display the egress VRF name if it is different from the source VRF.

Example

```
#show ip route vrf vrf1

VRF: vrf1
Codes: C - connected, S - static, K - kernel,
       O - OSPF, IA - OSPF inter area, E1 - OSPF external type 1,
       E2 - OSPF external type 2, N1 - OSPF NSSA external type 1,
       N2 - OSPF NSSA external type2, B - BGP, B I - iBGP, B E -
       eBGP,
       R - RIP, I L1 - IS-IS level 1, I L2 - IS-IS level 2,
       O3 - OSPFv3, A B - BGP Aggregate, A O - OSPF Summary,
       NG - Nexthop Group Static Route, V - VXLAN Control
Service,
       DH - DHCP client installed default route, M - Martian,
       DP - Dynamic Policy Route, L - VRF Leaked

Gateway of last resort is not set

S          1.0.1.0/24 [1/0] via 1.0.0.2, Vlan2180 (egress VRF
default)
```



```
S      1.0.7.0/24 [1/0] via 1.0.6.2, Vlan2507 (egress VRF
vrf3)
```

17.8.4 Limitations

For bidirectional traffic to work correctly between a pair of VRFs, static inter-VRF routes in both VRFs must be configured.

17.9 VCS to EVPN Hitless Migration

VCS to EVPN Hitless Migration enables support for migrating from only using VCS as the control plane to only using EVPN as a control plane in a hitless manner with respect to L2 reachability information.

17.9.1 Platform Compatability

VCS to EVPN hitless migration is platform independent. It is subject to all platform compatability limitations of both VCS and EVPN.

17.9.2 Configuration

To configure VCS to EVPN hitless migration, assume that initially only VCS is configured as the control plane. Complete the following migration process.

1. Check VCS L2 reachability information in L2Rib.

Use the following show commands to verify that L2 reachability information is in L2Rib's input and output:

- `show l2Rib input vxlan-control-service`
- `show l2rib input vxlan-control-service floodset`
- `show l2rib output`
- `show l2rib output floodset`

Also, verify that the L2 reachability information received from VCS is in the proper address tables using:

- `show mac address-table`
- `show vxlan address-table`
- `show vxlan flood vtep`

2. Configure EVPN.

See <https://eos.arista.com/eos-4-18-1f/evpn-vxlan/> for details on EVPN configuration.

3. Check L2Rib for L2 reachability information from both VCS and EVPN.

- For each MAC reachability entry received from VCS in L2Rib's input, there is an identical entry received from EVPN. Verify that entries received from VCS and EVPN in L2Rib's input are identical using the `show l2Rib input all` command.
- The floodset received from VCS in L2Rib's input include local VTEP IPs, while the floodset received from EVPN does not. Use the `show l2Rib input all floodset` command to check for identical floodset VTEP IPs (excluding local VTEP IPs).
- L2Rib's output now includes MAC reachability information received from EVPN, instead of the ones received from VCS. Verify this using the `show l2rib output` command.
- Verify that `show l2rib output floodset` output displays the same floodsets as when only VCS was configured as the control plane. Verify that information from L2Rib's output has been conveyed to the proper address tables using the following show commands:
 - `show mac address-table`
 - `show vxlan address-table`
 - `show vxlan flood vtep`

4. Gracefully shutdown VCS.

There are two options for shutting down VCS.

- The first option is to simply shutdown VCS using the `shutdown` command on the CVX node. However, if L2 reachability information is different from when only VCS is configured as the control plane (such as, due to EVPN misconfiguration), VCS must be reconfigured as a whole to rollback.
- The second option is to use a more gradual approach. To aid in importing only EVPN control plane information in particular L2 domains, a new configuration option was recently added to inhibit the import of VCS reachability information into specified VLANs. This configuration is in the VXLAN interface configuration mode, and is as follows:

```
switch(config)#interface vxlan1
switch(config-if-Vx1)#vxlan controller-client import vlan none
switch(config-if-Vx1)#vxlan controller-client import
  vlan import_enabled_vlans
switch(config-if-Vx1)#vxlan controller-client import vlan add
  import_enabled_vlans
switch(config-if-Vx1)#vxlan controller-client import vlan
  remove import_disabled_vlans
```

The commands above operate on a set of "import VLANs", or VLANs where the import of reachability information from VCS is allowed, with the following behavior:

- **none** disables import from all VLANs.
- simply specifying ***import_enabled_vlans*** results in replacing the set of allowed VLANs with ***import_enabled_vlans***.
- **add *import_enabled_vlans*** adds ***import_enabled_vlans*** to the current set of allowed VLANs.
- **remove *import_disabled_vlans*** removes ***import_disabled_vlans*** from the current set of allowed VLANs.
- having the prefix **no** or **default** re-enables import from all VLANs.

Any of the CLI subcommands that take a list take it in the form of a VLAN multi-range string (such as, "**1-4094**", "**1,5-100**", "**1-30,500-1000**", etc.)

Gradually inhibiting the import of VCS reachability information can be done using the above commands. For example, use the `vxlan controller-client import vlan remove 100`

command to inhibit the import of VCS reachability information subject to VLAN 100. To rollback, use the `vxlan controller-client import vlan add 100` command.

For each step of inhibiting the import of VCS reachability information, L2Rib's input/output and proper address-tables must be checked for correctness. The number of inhibited VLANs per step should be determined by the personnel who are performing the migration.

After verifying that all reachability information from VCS has been removed from L2Rib's input, use the `shutdown` command on the CVX node to gracefully shutdown VCS.

5. Disable controller-client mode on each switch.

VCS is shutdown, so each switch should no longer consider VCS as a control plane. This can be accomplished using the following command on each switch:

```
switch(config)#interface vxlan1
switch(config-if-Vx1)#no vxlan controller-client
```

17.9.3 Show Commands

The show commands used for the migration process are:

- `show l2Rib input vxlan-control-service`
- `show l2rib input vxlan-control-service floodset`
- `show l2rib input all`
- `show l2rib input all floodset`
- `show l2rib output`
- `show l2rib output floodset`
- `show mac address-table`
- `show vxlan address-table`
- `show vxlan flood vtep`

To enable the user to quickly view which control planes and sources are importing reachability information into which VLANs, use the following show command:

```
show vxlan control-plane [import | export] [vlan vlan_id]
```

This command displays a list of VLANs active in VXLAN on the device, along with which control planes are active in each VLAN, whether local reachability information is being advertised in a control plane (export), whether remote reachability information is being learned from a control plane (import), and what source (static configuration from CLI, VCS, EVPN, etc.) enabled distribution or learning in that VLAN. The **import** or **export** keywords may be provided to filter the output to only show sources that are importing from or exporting to the listed VLANs, respectively, and a VLAN multi-range string may be provided to filter the output to only show a subset of active VLANs.

17.9.4 Limitations

If the routing model is not set to the **multi-agent model** when only the VCS is configured as the control plane, switches may require a reboot during EVPN configuration to makes the migration no longer hitless.

17.10 Configuring EVPN

17.10.1 Configuring BGP-EVPN and VCS on CVX

17.10.1.1 Configuring BGP-EVPN

Configuring VNI Bundle

A VNI-aware-bundle represents a MAC-VRF that contains Layer 2 route entries from all VXLAN Network Identifiers (VNI) available across multiple DCs. Use the `vni-aware-bundle` command available on CVX to create a MAC-VRF.

 **Note:** This command is not available on switches.

Example

```
cvx(config)#router bgp 100
cvx(config-router-bgp)#vni-aware-bundle bundle1
cvx(config-macvrf-bundle1)#
```

Configuring RD and RT in VNI Bundle

Use the `rd` (Router-BGP VRF and VNI Configuration Modes) command to add a Route Distinguisher (RD) for uniquely identifying Layer 2 routes for the VNI bundle. Use the `route-target` command to configure a well-known extended community that is attached to the routes exported by BGP-EVPN; and to import routes with the specified well-known extended community into the MAC-VRF that corresponds to the VNI bundle.

Example

```
cvx(config)#router bgp 100
cvx(config-router-bgp)#vni-aware-bundle bundle1
cvx(config-macvrf-bundle1)# rd 530:12
cvx(config-macvrf-bundle1)# route-target both 530:12
```

Enabling Redistribution of Bridging Information

After the VNI aware bundle is created, use the `redistribute service vxlan` command to redistribute the Layer 2 bridging information received from VCS.

Example

```
cvx(config)#router bgp 100
cvx(config-router-bgp)#vni-aware-bundle bundle1
cvx(config-macvrf-bundle1)#redistribute service vxlan
```

Disabling Next-Hop Resolution in BGP-EVPN

When BGP-EVPN module receives a route from its BGP peer, it generally tries to resolve the next-hop indicated in the route. However in the DCI topology, the routes coming from a CVX in another DC contains next-hops (VTEP addresses) that may not be reachable from the CVX receiving the route. Use the `next-hop resolution disabled` command to disable the next-hop resolution on routes received from BGP-EVPN peers.

 **Note:** CVX is a part of the control plane and it is only connected to the VTEPs in its own DC. It does not have IP connectivity to the VTEPs in a different DC.

Example

```
cvx(config)#router bgp 100
cvx(config-router-bgp)#address-family evpn
cvx(config-router-bgp-af)#next-hop resolution disabled
```

17.10.1.2 Configuring VCS

Enabling Redistribution of BGP-EVPN Routes

Use the `redistribute bgp evpn vxlan` command to redistribute BGP-EVPN routes to VCS, which, in turn advertises them to all VTEPs within the DC.

Example

```
cvx(config)#cvx
cvx(config-cvx)#no shutdown
cvx(config-cvx)#service vxlan
cvx(config-cvx-vxlan)#no shutdown
cvx(config-cvx-vxlan)#redistribute bgp evpn vxlan
```

17.11 Sharing Equivalence Class entry across multiple VRF

This enables the sharing of the same Forwarding Equivalence Class (FEC) entry across multiple VRF's and achieves higher scale in VPN deployments by making optimal use of hardware resources. The VPN path routes are imported to multiple VRF for MPLS VPN address family in BGP, individual FEC entry in the hardware table is used for each VRF.

The following configuration in router BGP mode at BGP instance level allows sharing FEC, when the VPN path is imported to multiple VRFs.

```
switch# bgp fec skip in-place update
```

The following configures disable FEC and restores default configuration.

```
switch#[no| default] bgp fec skip in-place update
```

 **Note:** Changing the configuration in a production system may increase FEC usage.

The following example displays BGP VPN-IPv4 routes for prefix 20.0.1.0/24, which is imported to four VRFs.

```
switch #show bgp vpn-ipv4 20.0.1.0/24 detail
BGP routing table information for VRF default
Router identifier 0.0.0.1, local AS number 300
BGP routing table entry for IPv4 prefix 20.0.1.0/24, Route Distinguisher:
11.0.1.1:0
Paths: 1 available
 301
   11.0.1.1 from 10.0.0.2 (0.0.1.1)
      Origin IGP, metric -, localpref 100, weight 0, valid, external,
best
      Extended Community: Route-Target-AS:300:0 Route-Target-AS:301:0
```

MPLS label: 116507

This route was using 4 FEC entries for each VRF before the change.

```
switch# show platform jericho ip route 20.0.1.0/24
Tunnel Type: M(mpls), G(gre), MoG(mpls-over-gre),
              vxlan-o(vxlan outer-rewrite info), vxlan-i(vxlan inner-
rewrite info)
* - Routes in LEM
D - ECMP is divergent across switching chips
-----
|
|                               Routing Table
|-----
|
|VRF| Destination | ECMP| FEC | Tunnel |
| ID| Subnet      | Cmd |     |         |
| CPU Code | Index| Index|T Value | VID |Outlif | MAC /
|-----
| 1 | 20.0.1.0/24 |     | ROUTE| FEC 32776 | 10 | - |
|   |   - |49152 |M 116507 |
| 2 | 20.0.1.0/24 |     | ROUTE| FEC 32776 | 10 | - |
|   |   - |49154 |M 116507 |
| 3 | 20.0.1.0/24 |     | ROUTE| FEC 32776 | 10 | - |
|   |   - |49155 |M 116507 |
| 4 | 20.0.1.0/24 |     | ROUTE| FEC 32776 | 10 | - |
|   |   - |49156 |M 116507 |
```

The following uses single FEC entry For VPN routes imported to all VRFs after configuring `bgp fec skip in-place update event all` command.

```
switch# show platform jericho ip route 20.0.1.0/24
Tunnel Type: M(mpls), G(gre), MoG(mpls-over-gre),
              vxlan-o(vxlan outer-rewrite info), vxlan-i(vxlan inner-
rewrite info)
* - Routes in LEM
D - ECMP is divergent across switching chips
-----
|
|                               Routing Table
|-----
|
|VRF| Destination | ECMP| FEC | Tunnel |
| ID| Subnet      | Cmd |     |         |
| CPU Code | Index| Index|T Value | VID |Outlif | MAC /
|-----
| 1 | 20.0.1.0/24 |     | ROUTE| FEC 32780 | 10 | - |
|   |   - |49152 |M 116507 |
| 2 | 20.0.1.0/24 |     | ROUTE| FEC 32780 | 10 | - |
|   |   - |49152 |M 116507 |
| 3 | 20.0.1.0/24 |     | ROUTE| FEC 32780 | 10 | - |
|   |   - |49152 |M 116507 |
| 4 | 20.0.1.0/24 |     | ROUTE| FEC 32780 | 10 | - |
|   |   - |49152 |M 116507 |
```

17.12 Sample Configurations

17.12.1 EVPN VXLAN IRB Sample Configuration

In the topology below, we are connecting a Layer 2 site with a Layer 3 site using Layer 3 EVPN (type-5 route). Right side leaves are MLAG leaves and have SVI 10 in VRF-Blue. A number of directly connected hosts are simulated behind the right side leaf. The left side leaves are individual leaves that connect with a remote switch in `vrf` VRF-Blue to learn Layer 3 routes using BGP. The left side leaves are configured as two independent Layer 3 only VTEPs.

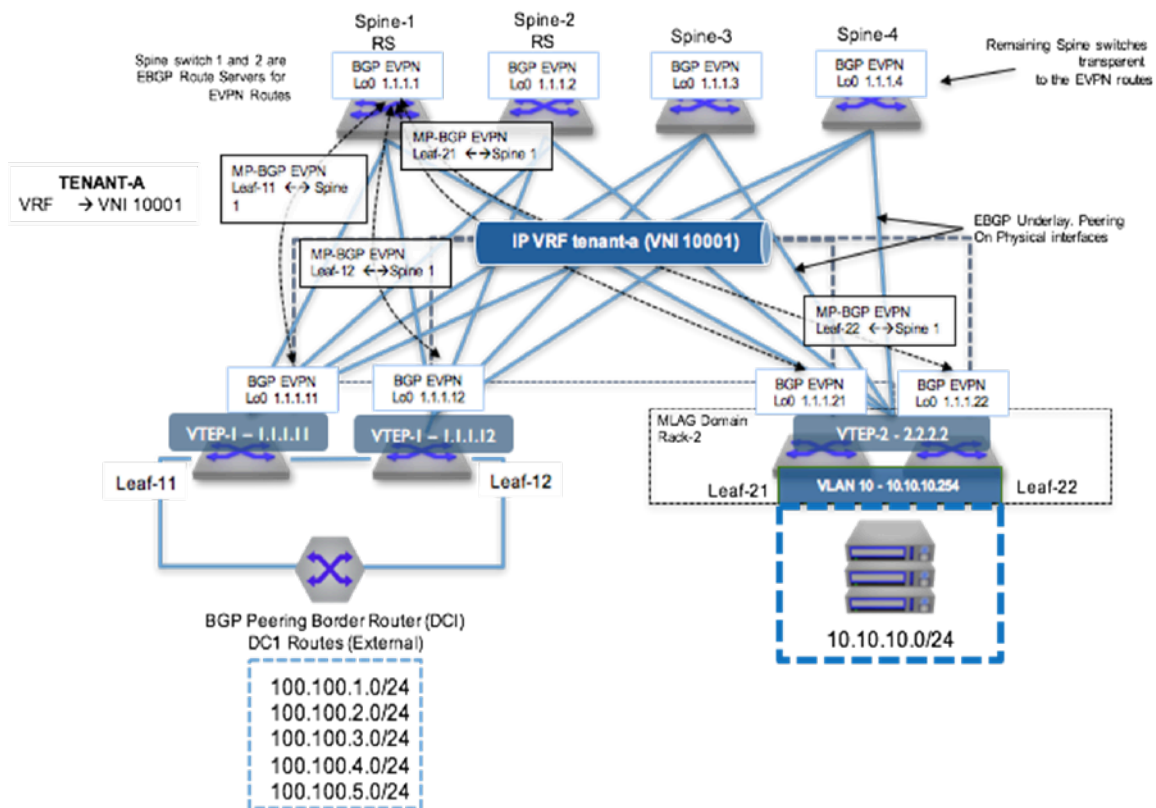

Figure 112: Layer 3 EVPN Configuration

To provide VXLAN routing and bridging between the two MLAG domains, each leaf switch is EVPN peering with the four spine switches via a loopback interface.

eBGP Underlay Configuration: Leaf-11

Underlay configuration is straightforward and all neighbors are eBGP. Since all leaves share the same AS number, the `allows-in` command was added in the leaf.

```
interface Ethernet1
  description Spine-1-et1/1
  mtu 9214
  no switchport
  ip address 172.168.1.1/31

interface Ethernet8/1
  description ck428-et8/1
  speed forced 40gfull
  no switchport
```

```

ip address 172.168.1.10/31

interface Loopback0
  ip address 1.1.1.11/32

ip prefix-list loopback
  seq 10 permit 1.1.1.0/24 ge 24
!
route-map loopback permit 10
  match ip address prefix-list loopback

router bgp 65004
neighbor SPINE peer-group
  neighbor SPINE remote-as 65001
  neighbor SPINE allowas-in 1
  neighbor SPINE soft-reconfiguration inbound all
  neighbor SPINE send-community
  neighbor 172.168.1.0 peer-group SPINE
  neighbor 172.168.1.11 remote-as 65003
  redistribute connected route-map loopback

```

eBGP Underlay Configuration: Spine-1

```

interface Ethernet1/1
  description Leaf-11-et1
  mtu 9214
  no switchport
  ip address 172.168.1.0/31

interface Loopback0
  ip address 1.1.1.1/32
!
ip prefix-list loopback
  seq 10 permit 1.1.1.0/24 ge 24
!
route-map loopback permit 10
  match ip address prefix-list loopback
!
router bgp 65001
  neighbor 172.168.1.1 remote-as 65004
  redistribute connected route-map loopback

```

VRF Configuration: Leaf-11

VRF-Blue is configured on all the left leaves. The left leaves have pure Layer 3 interfaces and the right side has SVI 10.

```

vrf instance VRF-Blue

ip routing vrf VRF-Blue

interface Ethernet36
  no switchport
  vrf VRF-Blue
  ip address 172.168.1.9/31

router bgp 65004
  vrf VRF-Blue
    neighbor 172.168.1.8 remote-as 65005

```

VRF Configuration: Leaf-21

```

vlan 10

vrf instance VRF-Blue

ip routing vrf VRF-Blue

interface Vlan10
  vrf VRF-Blue
  ip address virtual 10.10.10.1/24

ip virtual-router mac-address 00:aa:aa:aa:aa:aa

interface Port-Channel3
  switchport mode trunk
  mlag 3

```

VXLAN Configuration: Leaf-11

Make sure all VTEPs have unique loopback0 addresses to represent unique VTEP identifiers. For every VNI that EVPN receives, a dynamic VLAN is allocated, so it is a good practice to keep the same VNI.

```

interface Vxlan1
  vxlan source-interface Loopback0
  vxlan udp-port 4789
  vxlan vrf VRF-Blue vni 10001

```

VXLAN Configuration: Leaf-21

```

interface Vxlan1
  vxlan source-interface Loopback0
  vxlan udp-port 4789
  vxlan vrf VRF-Blue vni 10001

```

EVPN Configuration: Leaf-11

Leaf establishes the EVPN neighborship with all 4 spines for redundancy. EVPN neighborship is on the loopback address and the **multihop** keyword is used. Make sure to disable the IPv4 address family for EVPN neighbors.

Since the spine is acting like a route-reflector for EVPN routes, make sure to configure the next-hop-unchanged.

```

router bgp 65004
  neighbor SPINE_EVPN peer-group
  neighbor SPINE_EVPN remote-as 65001
  neighbor SPINE_EVPN update-source Loopback0
  neighbor SPINE_EVPN ebgp-multihop 3
  neighbor SPINE_EVPN send-community extended
  neighbor SPINE_EVPN maximum-routes 12000
  neighbor 1.1.1.1 peer-group SPINE_EVPN
  !
  address-family evpn
    neighbor SPINE_EVPN activate
  !
  address-family ipv4
    no neighbor SPINE_EVPN activate

```

EVPN Configuration: Leaf-21

```
router bgp 65002
  neighbor SPINE_EVPN peer-group
  neighbor SPINE_EVPN remote-as 65001
  neighbor SPINE_EVPN update-source Loopback0
  neighbor SPINE_EVPN allowas-in 1
  neighbor SPINE_EVPN ebgp-multihop 3
  neighbor SPINE_EVPN send-community extended
  neighbor SPINE_EVPN maximum-routes 12000
  neighbor 1.1.1.1 peer-group SPINE_EVPN
  !
  address-family evpn
    neighbor SPINE_EVPN activate
  !
  address-family ipv4
    no neighbor SPINE_EVPN activate
```

EVPN Configuration: Spine-1

```
router bgp 65004
  neighbor SPINE_EVPN peer-group
  neighbor SPINE_EVPN remote-as 65001
  neighbor SPINE_EVPN update-source Loopback0
  neighbor SPINE_EVPN ebgp-multihop 3
  neighbor SPINE_EVPN send-community extended
  neighbor SPINE_EVPN maximum-routes 12000
  neighbor 1.1.1.1 peer-group SPINE_EVPN
  !
  address-family evpn
    neighbor SPINE_EVPN activate
  !
  address-family ipv4
    no neighbor SPINE_EVPN activate
```

Advertise VRF Routes in EVPN: Leaf-11

By configuring VRF under **router-bgp**, you are advertising routes from that VRF into EVPN using the RD/RT. The remote end can install the route by importing the RT.

Leaf-11 has routes in VRF-Blue learned through eBGP with the neighbor down south. Since the routes are already in BGP VRF table, we don't configure the **redistribute** command.

```
router bgp 65004
  neighbor SPINE_EVPN peer-group
  neighbor SPINE_EVPN remote-as 65001
  neighbor SPINE_EVPN update-source Loopback0
  neighbor SPINE_EVPN ebgp-multihop 3
  neighbor SPINE_EVPN send-community extended
  neighbor SPINE_EVPN maximum-routes 12000
  neighbor 1.1.1.1 peer-group SPINE_EVPN
  !
  address-family evpn
    neighbor SPINE_EVPN activate
  !
  address-family ipv4
    no neighbor SPINE_EVPN activate
```

Advertise VRF Routes in EVPN: Leaf-21

On the other hand Leaf-21 wants to export the connected SVI into EVPN and hence require **redistribute connected** command.

```
router bgp 65002
  neighbor SPINE_EVPN peer-group
  neighbor SPINE_EVPN remote-as 65001
  neighbor SPINE_EVPN update-source Loopback0
  neighbor SPINE_EVPN allowas-in 1
  neighbor SPINE_EVPN ebgp-multihop 3
  neighbor SPINE_EVPN send-community extended
  neighbor SPINE_EVPN maximum-routes 12000
  neighbor 1.1.1.1 peer-group SPINE_EVPN
  !
  address-family evpn
    neighbor SPINE_EVPN activate
  !
  address-family ipv4
    no neighbor SPINE_EVPN activate
```

17.12.2 Multi-Tenant EVPN VXLAN IRB Sample Configuration

The following configuration example shows a deployment using both symmetric and asymmetric IRB with VLAN-based and VLAN-aware bundle services; and eBGP overlay and underlay.

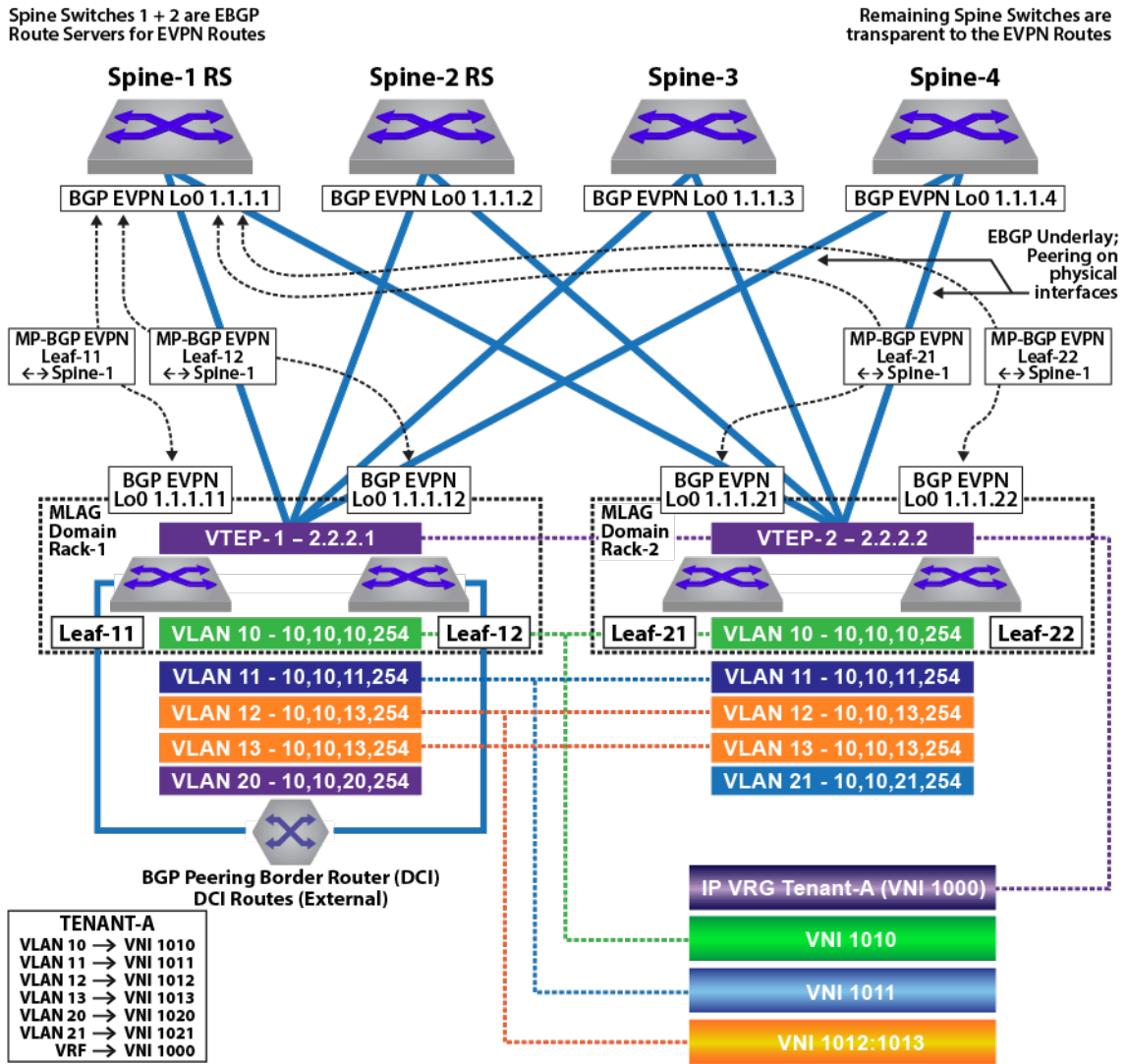

Figure 113: Tenant-A: Symmetric IRB

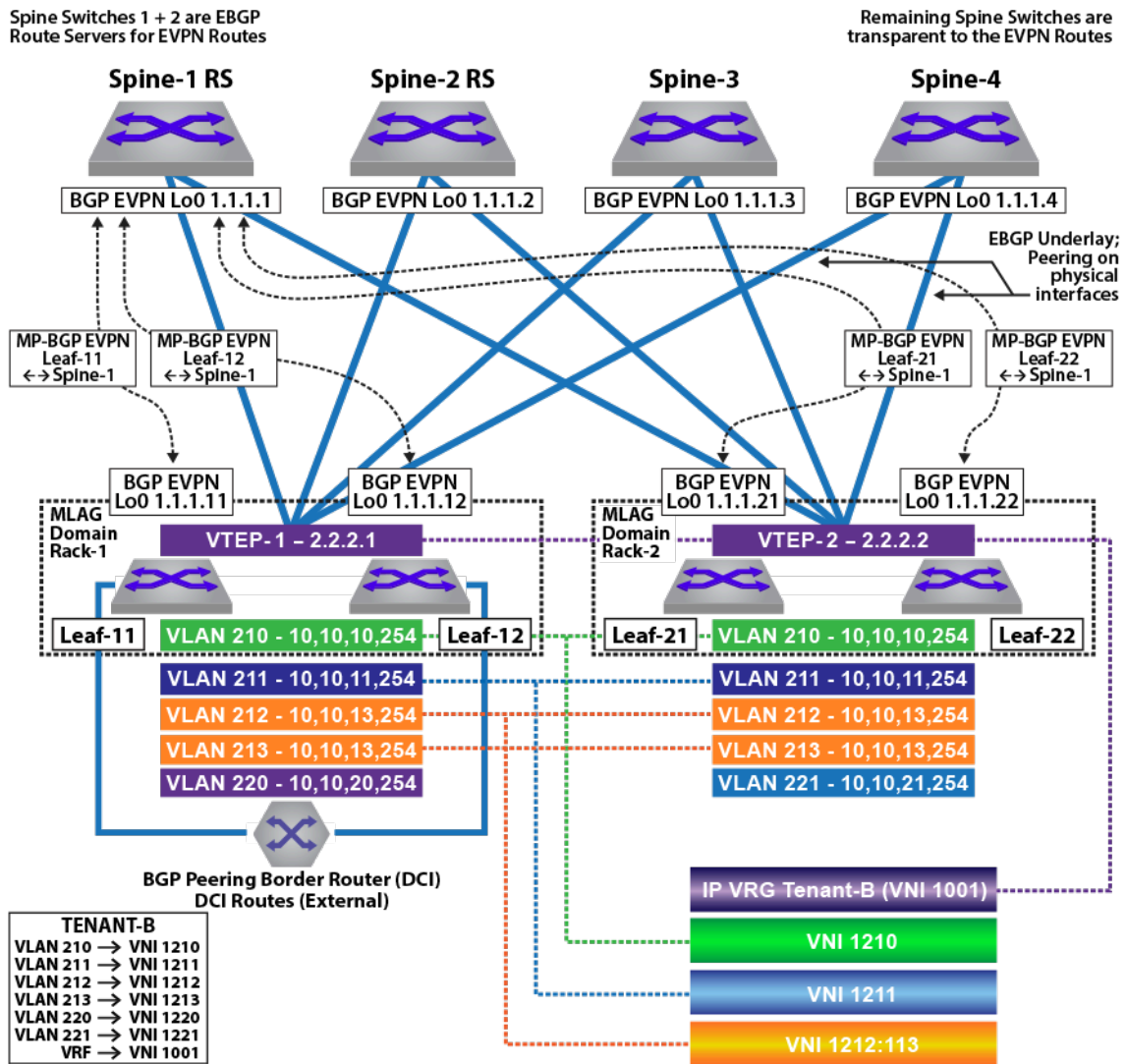

Figure 114: Tenant-B: Asymmetric IRB

In the symmetric and asymmetric IRB configurations illustrated in the figures above, for Tenant-A, four subnets are stretched across the two MLAG domains with two subnets (VLAN 10, 10.10.10.0/24 and VLAN 11, 10.10.11.0/24) configured as a VLAN-based service, and two other subnets (VLAN 12, 10.10.12.0/24 and VLAN 13, 10.10.13.0/24) as a VLAN-aware bundle service.

For Tenant-B, four subnets are stretched across the two MLAG domains with two subnets (VLAN 210, 10.10.10.0/24 and VLAN 211, 10.10.11.0/24) configured as a VLAN-based service, and two other subnets (VLAN 212, 10.10.12.0/24 and VLAN 213, 10.10.13.0/24) as a VLAN-aware bundle service.

In addition each MLAG domain has a single local subnet (Rack-1 subnet 10.10.20.0/24 and Rack-2 subnet 10.10.21.0/24) for the tenant. To provide direct distributed routing, each leaf switch is configured with the same virtual IP address for the four stretched subnets. For the local-only subnets, the virtual IP address is configured in both physical leaf switches of the relevant MLAG domain.

For each MLAG domain, a logical VTEP is created with the same shared loopback address. For Rack-1, the logical VTEP IP is 2.2.2.1 and for the Rack-2, the logical VTEP IP is 2.2.2.2. Directly connected to each leaf switch is a host, which is a member of one of the two IP subnets. To provide Layer 2 connectivity across the racks, VXLAN bridging is enabled by mapping VLAN to VNIs as detailed in the diagram.

To provide IP connectivity across all subnets both stretched and directly connected, an IP-VRF is shared between the two MLAG domains for the tenant. This is used as a transit network for announcing and forwarding the locally attached subnets. Each leaf switch is EVPN peering with the four spine switches via a loopback interface on the leaf and again on the spine switches. To provide external connectivity, Leaf-11 and Leaf-12 are eBGP peering via the tenants' VRFs with the border routers. Both core routers are advertising external prefixes for Internet and any remote site connectivity (default route and IP prefixes from the other DC for the tenant). To provide connectivity within the EVPN domain, the leaf switches (Leaf-21 and Leaf-22) re-advertise the prefixes into the tenant's VRF via a type-5 route advertisement, with a next-hop equal to the advertising VTEP.

17.12.2.1 MLAG Configuration: Leaf-11 and Leaf-12

Leaf-11 MLAG Configuration

```
spanning-tree mode mstp
no spanning-tree vlan-id 4093-4094
!
ip virtual-router mac-address mlag-peer
!
vlan 4094
  name MLAG_PEER
  trunk group MLAG
!
vlan 4093
  name LEAF_PEER_L3
  trunk group LEAF_PEER_L3
!
interface Vlan4094
  ip address 172.168.10.1/30
!
interface Port-Channel100
  description port-channel to access switch
  switchport trunk allowed vlan 10-13,20,210-213,220
  switchport mode trunk
  mlag 1
!
interface Port-Channel1000
  switchport mode trunk
  switchport trunk group LEAF_PEER_L3
  switchport trunk group MLAG
!
mlag configuration
  domain-id Rack-1
  local-interface Vlan4094
  peer-address 172.168.10.2
  peer-link Port-Channel1000
```

Leaf-12 MLAG Configuration

```
spanning-tree mode mstp
no spanning-tree vlan-id 4093-4094
!
ip virtual-router mac-address mlag-peer
!
vlan 4094
  name MLAG_PEER
  trunk group MLAG
!
vlan 4093
  name LEAF_PEER_L3
```

```

    trunk group LEAF_PEER_L3
    !
interface Vlan4094
    ip address 172.168.10.2/30
    !
interface Port-Channel100
    description port-channel to access switch
    switchport trunk allowed vlan 10-13,20,210-213,220
    switchport mode trunk
    mlag 1
    !
interface Port-Channel1000
    switchport mode trunk
    switchport trunk group LEAF_PEER_L3
    switchport trunk group MLAG
    !
mlag configuration
    domain-id Rack-1
    local-interface Vlan4094
    peer-address 172.168.10.1
    peer-link Port-Channel1000

```

17.12.2.2 MLAG Configuration: Leaf-21 and Leaf-22

Leaf-21 MLAG Configuration

```

spanning-tree mode mstp
no spanning-tree vlan-id 4093-4094
!
ip virtual-router mac-address mlag-peer
!
vlan 4094
    name MLAG_PEER
    trunk group MLAG
    !
vlan 4093
    name LEAF_PEER_L3
    trunk group LEAF_PEER_L3
    !
interface Vlan4094
    ip address 172.168.10.1/30
    !
interface Port-Channel100
    description port-channel to access switch
    switchport trunk allowed vlan 10-13,21,210-213,220-221
    switchport mode trunk
    mlag 1
    !
interface Port-Channel1000
    switchport mode trunk
    switchport trunk group LEAF_PEER_L3
    switchport trunk group MLAG
    !
mlag configuration
    domain-id Rack-1
    local-interface Vlan4094
    peer-address 172.168.10.2
    peer-link Port-Channel1000

```

Leaf-22 MLAG Configuration

```
spanning-tree mode mstp
no spanning-tree vlan-id 4093-4094
!
ip virtual-router mac-address mlag-peer
!
vlan 4094
    name MLAG_PEER
    trunk group MLAG
!
vlan 4093
    name LEAF_PEER_L3
    trunk group LEAF_PEER_L3
!
interface Vlan4094
    ip address 172.168.10.2/30
!
interface Port-Channel100
    description port-channel to access switch
    switchport trunk allowed vlan 10-13,21,210-213,220-221
    switchport mode trunk
    mlag 1
!
interface Port-Channel1000
    switchport mode trunk
    switchport trunk group LEAF_PEER_L3
    switchport trunk group MLAG
!
mlag configuration
    domain-id Rack-1
    local-interface Vlan4094
    peer-address 172.168.10.1
    peer-link Port-Channel1000hannel1000
```

17.12.2.3 VLAN and Distributed IP Address Configuration: Leaf-11 and Leaf-21

VLAN and interface configuration for VLAN 10 (virtual IP address 10.10.10.254) and VLAN 11 (virtual IP address 10.10.11.254), along with SVIs 12, 13 and 20, are similarly configured. To provide multi-tenancy, the two tenant VLANs are placed in a dedicated VRF, named “Tenant-A.” A further five tenant VLANs are configured and assigned to VRF “Tenant-B.”

The other VLANs are for peering, MLAG, and a unique VLAN SVI. These VLANs do not use virtual IP addresses.

The tenants’ stretched subnets (Tenant-A: VLANs 10,11,12 and 13; Tenant-B: VLANs 210, 211, 211, 212 and 213) are mapped to unique overlay VXLAN VNIs. The tenants’ IP-VRF (Tenant-A and Tenant-B) is associated with a VNI using the `vxlan vrf` command under the VXLAN interface. In the forwarding model for symmetric IRB, this VNI will be used as the transit VNI for routing to subnets which are not locally configured on the VTEP.

As a standard MLAG configuration, both leaf switches in each MLAG domain share the same logical VTEP IP address. Thus MLAG domain, Rack-1 (Leaf-11 + Leaf-12) has a shared logical VTEP IP of 2.2.2.1 and Rack-2 (Leaf-21 + Leaf-22) has a shared logical VTEP IP of 2.2.2.2

Leaf-11 VLAN and Distributed IP Address Configuration

```
!
ip virtual-router mac-address 00:aa:aa:aa:aa:aa
!
vlan 10-11,20,210-211,220,111,2111
```



```
!  
vlan 12-13  
    name VLAN-AWARE-BUNDLE-TENANT-A  
!  
vlan 212-213  
    name VLAN-AWARE-BUNDLE-TENANT-B  
!  
vrf instance tenant-a  
!  
vrf instance tenant-b  
!  
interface lan10  
    mtu 9164  
    vrf tenant-a  
    ip address virtual 10.10.10.254/24  
!  
interface Vlan11  
    mtu 9164  
    vrf tenant-a  
    ip address virtual 10.10.11.254/24  
!  
interface Vlan12  
    mtu 9164  
    vrf tenant-a  
    ip address virtual 10.10.12.254/24  
!  
interface Vlan13  
    mtu 9164  
    vrf tenant-a  
    ip address virtual 10.10.13.254/24  
!  
interface Vlan20  
    mtu 9164  
    vrf tenant-a  
    ip address virtual 10.10.20.254/24  
!  
interface Vlan210  
    mtu 9164  
    vrf tenant-b  
    ip address virtual 10.10.10.254/24  
!  
interface Vlan211  
    mtu 9164  
    vrf tenant-b  
    ip address virtual 10.10.11.254/24  
!  
interface Vlan212  
    mtu 9164  
    vrf tenant-b  
    ip address virtual 10.10.12.254/24  
!  
interface Vlan213  
    mtu 9164  
    vrf tenant-b  
    ip address virtual 10.10.13.254/24  
!  
interface Vlan220  
    mtu 9164  
    vrf tenant-b  
    ip address virtual 10.10.20.254/24  
!  
interface Vlan1111  
    description Unique-highest-IP-in-each-IP-Vrf  
    mtu 9164
```

```

vrf tenant-a
ip address 223.255.255.249/30
!
interface Vlan2111
description Unique-highest-IP-in-each-IP-Vrf
mtu 9164
vrf tenant-b
ip address 223.255.255.249/30
!
interface Vlan4093
ip address 172.168.11.1/30

```

Leaf-21 VLAN and Distributed IP Address Configuration

```

!
ip virtual-router mac-address 00:aa:aa:aa:aa:aa
!
vlan 10-11,20,210-211,220,111,2111
!
vlan 12-13
name VLAN-AWARE-BUNDLE-TENANT-A
!
vlan 212-213
name VLAN-AWARE-BUNDLE-TENANT-B
!
vrf instance tenant-a
!
vrf instance tenant-b
!
interface Vlan10
mtu 9164
vrf tenant-a
ip address virtual 10.10.10.254/24
!
interface Vlan11
mtu 9164
vrf tenant-a
ip address virtual 10.10.11.254/24
!
interface Vlan12
mtu 9164
vrf tenant-a
ip address virtual 10.10.12.254/24
!
interface Vlan13
mtu 9164
vrf tenant-a
ip address virtual 10.10.13.254/24
!
interface Vlan21
mtu 9164
vrf tenant-a
ip address virtual 10.10.21.254/24
!
interface Vlan210
mtu 9164
vrf tenant-b
ip address virtual 10.10.10.254/24
!
interface Vlan211
mtu 9164
vrf tenant-b

```

```

ip address virtual 10.10.11.254/24
!
interface Vlan212
  mtu 9164
  vrf tenant-b
  ip address virtual 10.10.12.254/24
!
interface Vlan213
  mtu 9164
  vrf tenant-b
  ip address virtual 10.10.13.254/24
!
interface Vlan221
  mtu 9164
  vrf tenant-b
  ip address virtual 10.10.21.254/24
!
interface Vlan1111
  description Unique-highest-IP-in-each-IP-Vrf
  mtu 9164
  vrf tenant-a
  ip address 223.255.255.253/30
!
interface Vlan2111
  description Unique-highest-IP-in-each-IP-Vrf
  mtu 9164
  vrf tenant-b
  ip address 223.255.255.253/30
!
interface Vlan4093
  ip address 172.168.11.1/30
!

```

17.12.2.4 VXLAN Interface Configuration: Leaf-11 and Leaf-21

The tenants' VLANs are mapped to unique overlay VXLAN VNIs. VLAN 10 is mapped to VNI 1010 on both MLAG domains, and VLAN 11 is mapped to VNI 1011. As standard MLAG configuration, both leaf switches in each MLAG domain share the same logical VTEP IP address. Thus MLAG domain Rack-1 (Leaf-11 + Leaf-12) has a shared logical VTEP IP of 2.2.2.1 and Rack-2 (Leaf-21 + Leaf-22) has a shared logical VTEP IP of 2.2.2.2. Also configured is the VRF-to-VXLAN mapping for Tenant-A.

Leaf-11 VXLAN Interface Configuration

```

!
interface Loopback1
  ip address 2.2.2.1/32
!
interface Vxlan1
  vxlan source-interface Loopback1
  vxlan udp-port 4789
  vxlan vlan 10 vni 1010
  vxlan vlan 11 vni 1011
  vxlan vlan 12 vni 1012
  vxlan vlan 13 vni 1013
  vxlan vlan 20 vni 1020
  vxlan vlan 210 vni 1210
  vxlan vlan 211 vni 1211
  vxlan vlan 212 vni 1212
  vxlan vlan 213 vni 1213
  vxlan vlan 220 vni 1220
  vxlan vrf tenant-a vni 1000

```

```
vxlan vrf tenant-b vni 1001
```

Leaf-21 VXLAN Interface Configuration

```
!  
interface Loopback1  
  ip address 2.2.2.2/32  
!  
interface Vxlan1  
  vxlan source-interface Loopback1  
  vxlan udp-port 4789  
  vxlan vlan 10 vni 1010  
  vxlan vlan 11 vni 1011  
  vxlan vlan 12 vni 1012  
  vxlan vlan 13 vni 1013  
  vxlan vlan 21 vni 1021  
  vxlan vlan 210 vni 1210  
  vxlan vlan 211 vni 1211  
  vxlan vlan 212 vni 1212  
  vxlan vlan 213 vni 1213  
  vxlan vlan 221 vni 1221  
  vxlan vrf tenant-a vni 1000  
  vxlan vrf tenant-b vni 1001
```



Note: This configuration uses VXLAN routing. For single-chip T2 and TH platforms, recirculation must be enabled. For R-Series platforms, the following configuration commands must be added:

```
hardware tcam
```

```
system profile vxlan-routing
```

Refer to diagrams for VLAN and SVI assignment to tenant; Leaf-11 also has peering out to the border router in addition to the connected SVIs.

17.12.2.5 eBGP Underlay Configuration on the Leaf Switches

The leaf switches for the underlay network peer with each spine on the physical interface. For EVPN route advertisement, the BGP EVPN session is between loopback addresses.

In this case, the underlay is all eBGP, and peering is on the physical interfaces. The MLAG leaves also peer with each other in the underlay to retain BGP EVPN connectivity (loopback reachability) in the very unlikely case that all spine links are down. This is a failover configuration that can be implemented if there is ever the chance a leaf could be “core isolated.” The configuration can be viewed on each leaf using the command **show running-configuration section bgp**.

The examples below show the underlay configuration on all four leaf switches, and also on two of the spine switches as an example of the underlay configuration on the spine.

The configuration uses the following peer groups:

SPINE configuration inherited for underlay (eBGP) peering to the spines

SPINE_EVPN overlay eBGP peering between spine and leaf, using loopbacks

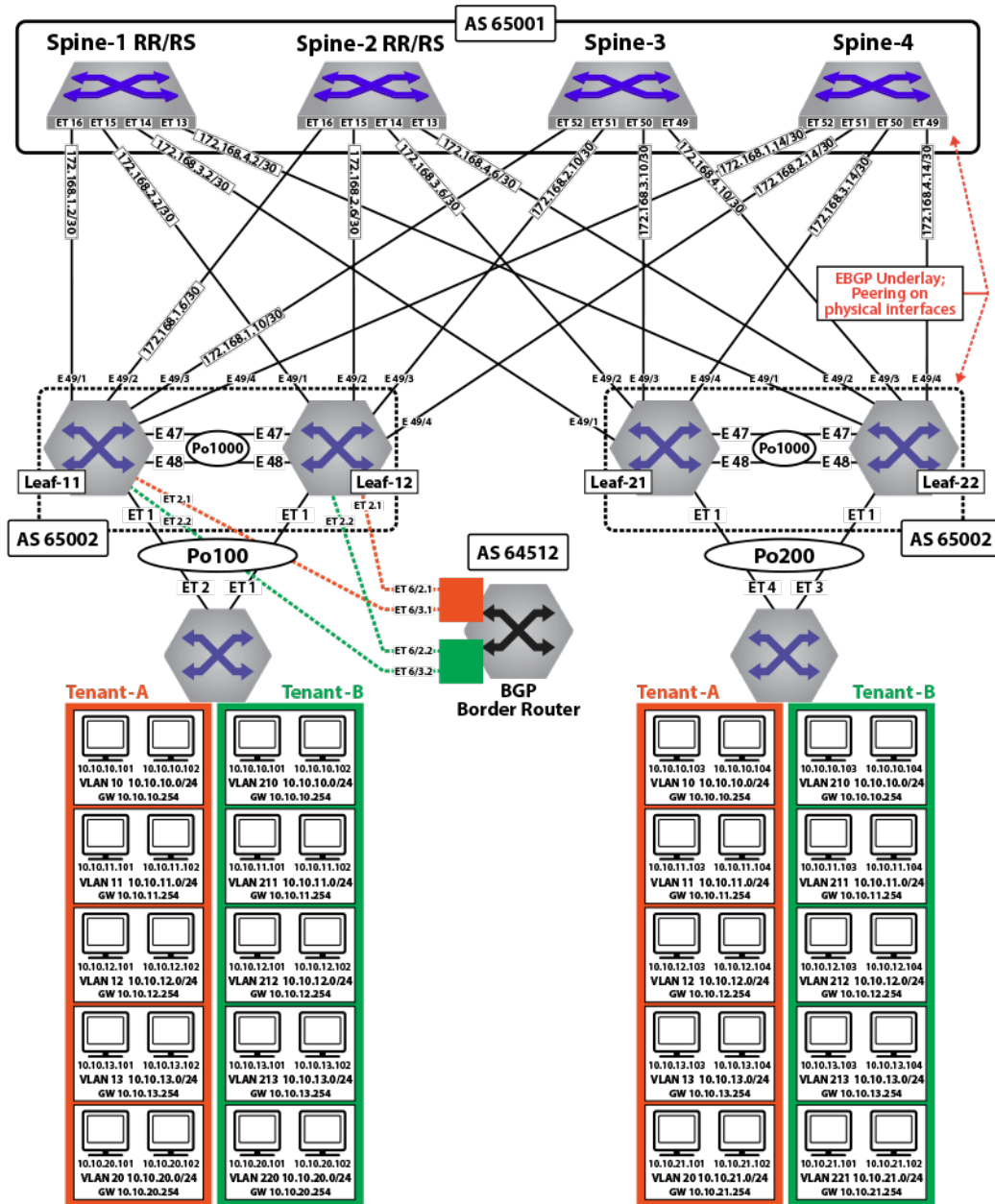

Figure 115: Physical Underlay Topology

eBGP Underlay Configuration: Leaf-11

```

route-map loopback permit 10
  match ip address prefix-list loopback
!
route-map dont_advertise_loopbacks deny 10
  match ip address prefix-list loopback
!
route-map dont_advertise_loopbacks permit 20
!
ip prefix-list loopback
  seq 10 permit 1.1.1.11/32
  seq 20 permit 1.1.1.12/32
  seq 30 permit 1.1.1.22/32
  seq 40 permit 1.1.1.21/32
    
```

```

    seq 50 permit 2.2.2.1/32
    seq 60 permit 2.2.2.2/32
!
router bgp 65002
  router-id 1.1.1.11
  maximum-paths 8 ecmp 16
  neighbor SPINE peer-group
  neighbor SPINE remote-as 65001
  neighbor SPINE allowas-in 1
  neighbor SPINE soft-reconfiguration inbound all
  neighbor SPINE route-map loopback out
  neighbor SPINE send-community
  neighbor 172.168.1.1 peer-group SPINE
  neighbor 172.168.1.5 peer-group SPINE
  neighbor 172.168.1.9 peer-group SPINE
  neighbor 172.168.1.13 peer-group SPINE
neighbor 172.168.11.2 remote-as 65004
neighbor 172.168.11.2 local-as 65002 no-prepend replace-as
  neighbor 172.168.11.2 allowas-in 1
  neighbor 172.168.11.2 maximum-routes 12000
  redistribute connected route-map loopback

```

eBGP Underlay Configuration: Leaf-12

```

route-map loopback permit 10
  match ip address prefix-list loopback
!
route-map dont_advertise_loopbacks deny 10
  match ip address prefix-list loopback
!
route-map dont_advertise_loopbacks permit 20
!
ip prefix-list loopback
  seq 10 permit 1.1.1.11/32
  seq 20 permit 1.1.1.12/32
  seq 30 permit 1.1.1.22/32
  seq 40 permit 1.1.1.21/32
  seq 50 permit 2.2.2.1/32
  seq 60 permit 2.2.2.2/32
!
router bgp 65002
  router-id 1.1.1.12
  maximum-paths 8 ecmp 16
  neighbor SPINE peer-group
  neighbor SPINE remote-as 65001
  neighbor SPINE allowas-in 1
  neighbor SPINE soft-reconfiguration inbound all
  neighbor SPINE route-map loopback out
  neighbor SPINE send-community
  neighbor 172.168.2.1 peer-group SPINE
  neighbor 172.168.2.5 peer-group SPINE
  neighbor 172.168.2.9 peer-group SPINE
  neighbor 172.168.2.13 peer-group SPINE
neighbor 172.168.11.1 remote-as 65002
neighbor 172.168.11.1 local-as 65004 no-prepend replace-as
  neighbor 172.168.11.1 allowas-in 1
  neighbor 172.168.11.1 maximum-routes 12000
  redistribute connected route-map loopback

```

eBGP Underlay Configuration: Leaf-21

```

route-map loopback permit 10
  match ip address prefix-list loopback
!
ip prefix-list loopback
  seq 10 permit 1.1.1.11/32
  seq 20 permit 1.1.1.12/32
  seq 30 permit 1.1.1.22/32
  seq 40 permit 1.1.1.21/32
  seq 50 permit 2.2.2.1/32
  seq 60 permit 2.2.2.2/32
!
router bgp 65002
  router-id 1.1.1.21
  maximum-paths 8 ecmp 16
  neighbor SPINE peer-group
  neighbor SPINE remote-as 65001
  neighbor SPINE allowas-in 1
  neighbor SPINE soft-reconfiguration inbound all
  neighbor SPINE route-map loopback out
  neighbor SPINE send-community
  neighbor SPINE maximum-routes 20000
  neighbor 172.168.3.1 peer-group SPINE
  neighbor 172.168.3.5 peer-group SPINE
  neighbor 172.168.3.9 peer-group SPINE
  neighbor 172.168.3.13 peer-group SPINE
  neighbor 172.168.11.2 remote-as 65004
  neighbor 172.168.11.2 local-as 65002 no-prepend replace-as
  neighbor 172.168.11.2 allowas-in 1
  neighbor 172.168.11.2 maximum-routes 12000
  redistribute connected route-map loopback

```

eBGP Underlay Configuration: Leaf-22

```

route-map loopback permit 10
  match ip address prefix-list loopback
!
ip prefix-list loopback
  seq 10 permit 1.1.1.11/32
  seq 20 permit 1.1.1.12/32
  seq 30 permit 1.1.1.22/32
  seq 40 permit 1.1.1.21/32
  seq 50 permit 2.2.2.1/32
  seq 60 permit 2.2.2.2/32
!
router bgp 65002
  router-id 1.1.1.22
  maximum-paths 8 ecmp 16
  neighbor SPINE peer-group
  neighbor SPINE remote-as 65001
  neighbor SPINE allowas-in 1
  neighbor SPINE soft-reconfiguration inbound all
  neighbor SPINE route-map loopback out
  neighbor SPINE send-community
  neighbor SPINE maximum-routes 20000
  neighbor 172.168.4.1 peer-group SPINE
  neighbor 172.168.4.5 peer-group SPINE
  neighbor 172.168.4.9 peer-group SPINE
  neighbor 172.168.4.13 peer-group SPINE
  neighbor 172.168.11.1 remote-as 65002
  neighbor 172.168.11.1 local-as 65004 no-prepend replace-as

```

```
neighbor 172.168.11.2 allowas-in 1
neighbor 172.168.11.1 maximum-routes 12000
redistribute connected route-map loopback
```

17.12.2.6 EVPN BGP Configuration on the Spine Switches

The EVPN BGP configuration on two of the spine switches is summarized below. Note that only the EVPN BGP sessions are listed for the two spine switches: the BGP underlay configuration is not included.

EVPN BGP Configuration: Spine-1

```
route-map loopback permit 10
  match ip address prefix-list loopback
!
ip prefix-list loopback
  seq 10 permit 1.1.1.11/32
  seq 20 permit 1.1.1.12/32
  seq 30 permit 1.1.1.22/32
  seq 40 permit 1.1.1.21/32
  seq 50 permit 2.2.2.1/32
  seq 60 permit 2.2.2.2/32
!
router bgp 65001
  router-id 1.1.1.1
  distance bgp 20 200 200
  maximum-paths 8 ecmp 16
  neighbor LEAF peer-group
  neighbor LEAF remote-as 65002
  neighbor LEAF maximum-routes 20000
  neighbor 172.168.1.2 peer-group LEAF
  neighbor 172.168.2.2 peer-group LEAF
  neighbor 172.168.3.2 peer-group LEAF
  neighbor 172.168.4.2 peer-group LEAF
  redistribute connected route-map loopback
```

EVPN BGP Configuration: Spine-2

```
route-map loopback permit 10
  match ip address prefix-list loopback
!
ip prefix-list loopback
  seq 10 permit 1.1.1.11/32
  seq 20 permit 1.1.1.12/32
  seq 30 permit 1.1.1.22/32
  seq 40 permit 1.1.1.21/32
  seq 50 permit 2.2.2.1/32
  seq 60 permit 2.2.2.2/32
!
router bgp 65001
  router-id 1.1.1.2
  distance bgp 20 200 200
  maximum-paths 8 ecmp 16
  neighbor LEAF peer-group
  neighbor LEAF remote-as 65002
  neighbor LEAF maximum-routes 20000
  neighbor 172.168.1.6 peer-group LEAF
  neighbor 172.168.2.6 peer-group LEAF
  neighbor 172.168.3.6 peer-group LEAF
  neighbor 172.168.4.6 peer-group LEAF
```



```
redistribute connected route-map loopback
```

17.12.2.7 eBGP Overlay on Leaf Switches

The MAC VRFs and IP VRF for the tenants' subnets are created in the BGP router context with unique Route-Distinguishers (RD) and Route-Targets (RT) attached to each MAC-VRF and IP-VRF. The RDs provide support for overlapping MAC and IP addresses across tenants, while the RTs allow control of the routes imported and exported between MAC VRFs.

To ensure all routes are correctly imported between VTEPs sharing the same Layer-2 domain, the import and export RTs are equal across the two MLAG domains. The **redistribute learned** statement under each MAC VRF ensures any locally learned MACs in the VLAN are automatically announced as type-2 routes.

The IP VRF (Tenant-A) is created on all leaf switches which have subnets attached to the tenant's VRF with the same route target ensuring that routes are correctly imported and exported between VTEPs in the VRF. On Leaf-21 and Leaf-22, to import the external routes an eBGP session with the BGP peering router is created under the IP VRF (Tenant-A) context, and a peering from each to the other is created on the overlay.

 **Note:** All MAC VRFs are unique, and each has its own RT, matched by the other leaves in the DC. The “tenants” as such are defined at layer 3 by assigning SVIs to the appropriate VRF. To view this assignment, use the **show ip route vrf <tenant> connected** command. Note below that VLANs 12-13 and 212-213 (shown in bold) are configured as a bundle-aware EVPN service. Also note the peering from Leaf-11 to the BGP border router in each tenant VRF.

EVPN BGP Overlay Configuration for the Tenants' MAC VRFs and IP VRF: Leaf-11

```
route-map loopback permit 10
  match ip address prefix-list loopback
!
route-map dont_advertise_loopbacks deny 10
  match ip address prefix-list loopback
!
route-map dont_advertise_loopbacks permit 20
!
ip prefix-list loopback
  seq 10 permit 1.1.1.11/32
  seq 20 permit 1.1.1.12/32
  seq 30 permit 1.1.1.22/32
  seq 40 permit 1.1.1.21/32
  seq 50 permit 2.2.2.1/32
  seq 60 permit 2.2.2.2/32
!
router bgp 65002
  router-id 1.1.1.11
  maximum-paths 4
  neighbor SPINE_EVPN peer-group
  neighbor SPINE_EVPN remote-as 65001
  neighbor SPINE_EVPN update-source Loopback0
  neighbor SPINE_EVPN allowas-in 2
  neighbor SPINE_EVPN ebgp-multihop 5
  neighbor SPINE_EVPN send-community extended
  neighbor SPINE_EVPN maximum-routes 12000
  neighbor 1.1.1.1 peer-group SPINE_EVPN
  neighbor 1.1.1.2 peer-group SPINE_EVPN
  redistribute connected route-map Loopback
!
vlan 10
  rd 1.1.1.11:1010
  route-target both 1010:1010
```

```

    redistribute learned
!
vlan 11
    rd 1.1.1.11:1011
    route-target both 1011:1011
    redistribute learned
!
vlan 20
    rd 1.1.1.11:1020
    route-target both 1020:1020
    redistribute learned
!
vlan 210
    rd 1.1.1.11:1210
    route-target both 1210:1210
    redistribute learned
    no redistribute host-route
!
vlan 211
    rd 1.1.1.11:1211
    route-target both 1211:1211
    redistribute learned
    no redistribute host-route
!
vlan 220
    rd 1.1.1.11:1220
    route-target both 1220:1220
    redistribute learned
    no redistribute host-route
!
vlan-aware-bundle Tenant-A-VLAN-12-13
    rd 1.1.1.11:1213
    route-target both 12:13
    redistribute learned
    vlan 12-13
!
vlan-aware-bundle Tenant-B-VLAN-212-213
    rd 1.1.1.11:21213
    route-target both 212:213
    redistribute learned
    no redistribute host-route
    vlan 212-213
!
address-family evpn
    neighbor SPINE_EVPN activate
!
address-family ipv4
    no neighbor SPINE_EVPN activate
!
vrf tenant-a
    rd 1.1.1.11:1000
    route-target import 1000:1000
    route-target export 1000:1000
    neighbor 192.168.168.9 remote-as 64512
    neighbor 192.168.168.9 local-as 65002 no-prepend replace-as
    neighbor 192.168.168.9 maximum-routes 12000
    neighbor 223.255.255.250 peer-group LEAF_PEER_OVERLAY
    neighbor 223.255.255.250 remote-as 65004
    neighbor 223.255.255.250 local-as 65002 no-prepend replace-as
    redistribute connected route-map dont_advertise_loopbacks
!
vrf tenant-b
    rd 1.1.1.11:1001

```

```

route-target import 1001:1001
route-target export 1001:1001
neighbor 192.168.168.21 remote-as 64513
neighbor 192.168.168.21 local-as 65002 no-prepend replace-as
neighbor 192.168.168.21 maximum-routes 12000
neighbor 223.255.255.249 peer-group LEAF_PEER_OVERLAY
neighbor 223.255.255.249 remote-as 65004
neighbor 223.255.255.249 local-as 65002 no-prepend replace-as
redistribute connected route-map dont_advertise_loopbacks

```

EVPN BGP Overlay Configuration for the Tenants' MAC VRFs and IP VRF: Leaf-12

```

route-map loopback permit 10
  match ip address prefix-list loopback
!
route-map dont_advertise_loopbacks deny 10
  match ip address prefix-list loopback
!
route-map dont_advertise_loopbacks permit 20
!
ip prefix-list loopback
  seq 10 permit 1.1.1.11/32
  seq 20 permit 1.1.1.12/32
  seq 30 permit 1.1.1.22/32
  seq 40 permit 1.1.1.21/32
  seq 50 permit 2.2.2.1/32
  seq 60 permit 2.2.2.2/32
!
router bgp 65002
  router-id 1.1.1.12
  maximum-paths 4
  neighbor SPINE_EVPN peer-group
  neighbor SPINE_EVPN remote-as 65001
  neighbor SPINE_EVPN update-source Loopback0
  neighbor SPINE_EVPN allowas-in 2
  neighbor SPINE_EVPN ebgp-multihop 5
  neighbor SPINE_EVPN send-community extended
  neighbor SPINE_EVPN maximum-routes 12000
  neighbor 1.1.1.1 peer-group SPINE_EVPN
  neighbor 1.1.1.2 peer-group SPINE_EVPN
  redistribute connected route-map loopback
!
vlan 10
  rd 1.1.1.12:1010
  route-target both 1010:1010
  redistribute learned
!
vlan 11
  rd 1.1.1.12:1011
  route-target both 1011:1011
  redistribute learned
!
vlan 20
  rd 1.1.1.12:1020
  route-target both 1020:1020
  redistribute learned
!
vlan 210
  rd 1.1.1.12:1210
  route-target both 1210:1210
  redistribute learned
  no redistribute host-route

```

```

!
vlan 211
  rd 1.1.1.12:1211
  route-target both 1211:1211
  redistribute learned
  no redistribute host-route
!
vlan 220
  rd 1.1.1.12:1220
  route-target both 1220:1220
  redistribute learned
  no redistribute host-route
!
vlan-aware-bundle Tenant-A-VLAN-12-13
  rd 1.1.1.12:1213
  route-target both 12:13
  redistribute learned
  vlan 12-13
!
vlan-aware-bundle Tenant-B-VLAN-212-213
  rd 1.1.1.12:21213
  route-target both 212:213
  redistribute learned
  no redistribute host-route
  vlan 212-213
!
address-family evpn
  neighbor SPINE_EVPN activate
!
address-family ipv4
  no neighbor SPINE_EVPN activate
!
vrf tenant-a
  rd 1.1.1.12:1000
  route-target import 1000:1000
  route-target export 1000:1000
  neighbor 192.168.168.13 remote-as 64512
  neighbor 192.168.168.13 local-as 65002 no-prepend replace-as
  neighbor 192.168.168.13 maximum-routes 12000
  neighbor 223.255.255.249 peer-group LEAF_PEER_OVERLAY
  neighbor 223.255.255.249 remote-as 65002
  neighbor 223.255.255.249 local-as 65004 no-prepend replace-as
  redistribute connected route-map dont_advertise_loopbacks
!
vrf tenant-b
  rd 1.1.1.12:1001
  route-target import 1001:1001
  route-target export 1001:1001
  neighbor 192.168.168.23 remote-as 64513
  neighbor 192.168.168.23 local-as 65002 no-prepend replace-as
  neighbor 192.168.168.23 maximum-routes 12000
  neighbor 223.255.255.249 peer-group LEAF_PEER_OVERLAY
  neighbor 223.255.255.249 remote-as 65002
  neighbor 223.255.255.249 local-as 65004 no-prepend replace-as
  redistribute connected route-map dont_advertise_loopbacks

```

EVPN BGP Overlay Configuration for the Tenants' MAC VRFs and IP VRF: Leaf-21

```

route-map loopback permit 10
  match ip address prefix-list loopback
!
route-map dont_advertise_loopbacks deny 10

```

```
    match ip address prefix-list loopback
!
route-map dont_advertise_loopbacks permit 20
!
router bgp 65002
  router-id 1.1.1.21
  maximum-paths 4
  neighbor SPINE_EVPN peer-group
  neighbor SPINE_EVPN remote-as 65001
  neighbor SPINE_EVPN update-source Loopback0
  neighbor SPINE_EVPN allowas-in 2
  neighbor SPINE_EVPN ebgp-multihop 5
  neighbor SPINE_EVPN send-community extended
  neighbor SPINE_EVPN maximum-routes 12000
  neighbor 1.1.1.1 peer-group SPINE_EVPN
  neighbor 1.1.1.2 peer-group SPINE_EVPN
  redistribute connected route-map loopback
!
vlan 10
  rd 1.1.1.21:1010
  route-target both 1010:1010
  redistribute learned
!
vlan 11
  rd 1.1.1.21:1011
  route-target both 1011:1011
  redistribute learned
!
vlan 21
  rd 1.1.1.21:1021
  route-target both 1021:1021
  redistribute learned
!
vlan 210
  rd 1.1.1.21:1210
  route-target both 1210:1210
  redistribute learned
  no redistribute host-route
!
vlan 211
  rd 1.1.1.21:1211
  route-target both 1211:1211
  redistribute learned
  no redistribute host-route
!
vlan 221
  rd 1.1.1.21:1221
  route-target both 1221:1221
  redistribute learned
  no redistribute host-route
!
vlan-aware-bundle Tenant-A-VLAN-12-13
  rd 1.1.1.21:1213
  route-target both 12:13
  redistribute learned
  vlan 12-13
!
vlan-aware-bundle Tenant-B-VLAN-212-213
  rd 1.1.1.21:21213
  route-target both 212:213
  redistribute learned
  redistribute host-route
  vlan 212-213
```

```

!
address-family evpn
    neighbor SPINE_EVPN activate
!
address-family ipv4
    no neighbor SPINE_EVPN activate
!
vrf tenant-a
    rd 1.1.1.21:1000
    route-target import 1000:1000
    route-target export 1000:1000
    neighbor 223.255.255.254 remote-as 65002
    neighbor 223.255.255.254 next-hop-self
    neighbor 223.255.255.254 update-source Vlan1111
    neighbor 223.255.255.254 allowas-in 1
    neighbor 223.255.255.254 maximum-routes 12000
    redistribute connected route-map dont_advertise_loopbacks
!
vrf tenant-b
    rd 1.1.1.21:1001
    route-target import 1001:1001
    route-target export 1001:1001
    neighbor 223.255.255.254 remote-as 65002
    neighbor 223.255.255.254 next-hop-self
    neighbor 223.255.255.254 update-source Vlan2111
    neighbor 223.255.255.254 allowas-in 1
    neighbor 223.255.255.254 maximum-routes 12000
    redistribute connected route-map dont_advertise_loopbacks

```

EVPN BGP Overlay Configuration for the Tenants' MAC VRFs and IP VRF: Leaf-22

```

route-map loopback permit 10
    match ip address prefix-list loopback
!
route-map dont_advertise_loopbacks deny 10
    match ip address prefix-list loopback
!
route-map dont_advertise_loopbacks permit 20
!
router bgp 65002
    router-id 1.1.1.22
    maximum-paths 4
    neighbor SPINE_EVPN peer-group
    neighbor SPINE_EVPN remote-as 65001
    neighbor SPINE_EVPN update-source Loopback0
    neighbor SPINE_EVPN allowas-in 2
    neighbor SPINE_EVPN ebgp-multihop 5
    neighbor SPINE_EVPN send-community extended
    neighbor SPINE_EVPN maximum-routes 12000
    neighbor 1.1.1.1 peer-group SPINE_EVPN
    neighbor 1.1.1.2 peer-group SPINE_EVPN
    redistribute connected route-map loopback
!
vlan 10
    rd 1.1.1.22:1010
    route-target both 1010:1010
    redistribute learned
!
vlan 11
    rd 1.1.1.22:1011
    route-target both 1011:1011
    redistribute learned

```

```
!  
vlan 21  
  rd 1.1.1.22:1021  
  route-target both 1021:1021  
  redistribute learned  
!  
vlan 210  
  rd 1.1.1.22:1210  
  route-target both 1210:1210  
  redistribute learned  
  no redistribute host-route  
!  
vlan 211  
  rd 1.1.1.22:1211  
  route-target both 1211:1211  
  redistribute learned  
  no redistribute host-route  
!  
vlan 221  
  rd 1.1.1.22:1221  
  route-target both 1221:1221  
  redistribute learned  
  no redistribute host-route  
!  
vlan-aware-bundle Tenant-A-VLAN-12-13  
  rd 1.1.1.22:1213  
  route-target both 12:13  
  redistribute learned  
  vlan 12-13  
!  
vlan-aware-bundle Tenant-B-VLAN-212-213  
  rd 1.1.1.22:21213  
  route-target both 212:213  
  redistribute learned  
  no redistribute host-route  
  vlan 212-213  
!  
address-family evpn  
  neighbor SPINE_EVPN activate  
!  
address-family ipv4  
  no neighbor SPINE_EVPN activate  
!  
vrf tenant-a  
  rd 1.1.1.22:1000  
  route-target import 1000:1000  
  route-target export 1000:1000  
  neighbor 223.255.255.253 remote-as 65002  
  neighbor 223.255.255.253 next-hop-self  
  neighbor 223.255.255.253 update-source Vlan1111  
  neighbor 223.255.255.253 allowas-in 1  
  neighbor 223.255.255.253 maximum-routes 12000  
  redistribute connected route-map dont_advertise_loopbacks  
!  
vrf tenant-b  
  rd 1.1.1.22:1001  
  route-target import 1001:1001  
  route-target export 1001:1001  
  neighbor 223.255.255.253 remote-as 65002  
  neighbor 223.255.255.253 next-hop-self  
  neighbor 223.255.255.253 update-source Vlan2111  
  neighbor 223.255.255.253 allowas-in 1  
  neighbor 223.255.255.253 maximum-routes 12000
```

```
redistribute connected route-map dont_advertise_loopbacks
```

17.12.2.8 eBGP Overlay on Spine Switches

The EVPN BGP configuration on the spine switches is summarised in the examples below. Note that only the EVPN BGP sessions are listed for two spine switches; the BGP underlay configuration is not included.

EVPN BGP Overlay Configuration: Spine-1

```
!  
router bgp 65001  
  router-id 1.1.1.1  
  distance bgp 20 200 200  
  maximum-paths 8 ecmp 16  
  neighbor LEAF_EVPN peer-group  
  neighbor LEAF_EVPN remote-as 65002  
  neighbor LEAF_EVPN update-source Loopback0  
  neighbor LEAF_EVPN ebgp-multihop 5  
  neighbor LEAF_EVPN send-community extended  
  neighbor LEAF_EVPN next-hop-unchanged  
  neighbor LEAF_EVPN maximum-routes 12000  
  neighbor 1.1.1.11 peer-group LEAF_EVPN  
  neighbor 1.1.1.12 peer-group LEAF_EVPN  
  neighbor 1.1.1.21 peer-group LEAF_EVPN  
  neighbor 1.1.1.22 peer-group LEAF_EVPN  
  !  
  address-family evpn  
    neighbor LEAF_EVPN activate  
  !  
  address-family ipv4  
    no neighbor LEAF_EVPN activate  
  !  
  address-family ipv6  
    no neighbor LEAF_EVPN activate  
  !
```

EVPN BGP Overlay Configuration: Spine-2

```
!  
router bgp 65001  
  router-id 1.1.1.2  
  distance bgp 20 200 200  
  maximum-paths 8 ecmp 16  
  neighbor LEAF_EVPN peer-group  
  neighbor LEAF_EVPN remote-as 65002  
  neighbor LEAF_EVPN update-source Loopback0  
  neighbor LEAF_EVPN ebgp-multihop 5  
  neighbor LEAF_EVPN send-community extended  
  neighbor LEAF_EVPN next-hop-unchanged  
  neighbor LEAF_EVPN maximum-routes 12000  
  neighbor 1.1.1.11 peer-group LEAF_EVPN  
  neighbor 1.1.1.12 peer-group LEAF_EVPN  
  neighbor 1.1.1.21 peer-group LEAF_EVPN  
  neighbor 1.1.1.21 peer-group LEAF_EVPN  
  !  
  address-family evpn  
    neighbor LEAF_EVPN activate  
  !  
  address-family ipv4
```



```

    no neighbor LEAF_EVPN activate
!
    address-family ipv6
        no neighbor LEAF_EVPN activate
!

```

17.12.2.9 Symmetric IRB Configuration (Tenant-A)

In symmetric IRB, the host routes are generated by advertising type-2 routes with both the MAC VRF VNI and the routing (or VRF) VNI. On Leaf-11, the MAC VRFs for Tenant-A are left in their default configuration (i.e., redistributing host routes). The example below shows the configuration for the MAC VRF.

MAC VRF Configuration for Tenant-A: Leaf-11

The **redistribute learned** commands below cause type-2 routes to be advertised with two labels: in VLAN 10, 1010 and 1000; in VLAN 11, 1011 and 1000; in VLAN 21, 1021 and 1000.

```

vlan 10
    rd 1.1.1.11:1010
    route-target both 1010:1010
    redistribute learned
!
    vlan 11
        rd 1.1.1.11:1011
        route-target both 1011:1011
        redistribute learned
!
    vlan 21
        rd 1.1.1.11:1021
        route-target both 1021:1021
        redistribute learned
!

```

With this configuration, any locally learned MAC-IP binding on a leaf switch will be advertised as a type-2 route with two labels. For example, on switches Leaf-21 and Leaf-22, any MAC-IP binding locally learned on subnets 10.10.10.0/24, 10.10.11.0/24, or 10.10.21.0/24 will be advertised as type-2 routes with two labels (the MAC VRF of 1010, 1011, or 1021 and the IP VRF of 1000) and two route targets equal to the relevant MAC VRF for the host and IP VRF for the tenant (1000:1000). The remote leaf switches (Leaf-11 and Leaf-12), will now learn the host route in the IP VRF.

In addition to advertising the type-2 routes with dual labels, the switch will still advertise type-5 routes. This ensures connectivity to the remote subnet even when no host on the subnet has been learned. With both a layer-2 route and layer-3 host route for Server-3 learned on the MAC VRF(1010) and the IP VRF (1000) on Leaf-11, traffic ingressing on Leaf-11 from the local subnet 10.10.10.103 (i.e., VLAN 10) will be VXLAN bridged based on the MAC VRF entry. Traffic ingressing from outside the subnet (i.e., VLAN 11,12,13, or 20) will be routed to the host via the IP VRF host route.

The VLAN-aware bundle VLAN type-2 routes are advertised with the VNI ID within the update.

The type-5 routes are advertised with the IP VRF Route Distinguisher and the VNI label, signifying that the forwarding path for the prefix would be the IP VRF. The imported routes from the eBGP peering with the BGP border router in Leaf-11 and Leaf-12 are imported by both switches respectively and redistributed via type-5 advertisements to Leaf-21 and Leaf-22.

17.12.2.10 Asymmetric IRB Configuration (Tenant-B)

In asymmetric IRB, the host routes are generated by advertising type-2 routes with just the MAC VRF VNI. On leaf 11, the MAC VRFs for Tenant-B are configured with no redistribute host route within the MAC VRF configuration. The example below shows the configuration for the MAC VRF.

MAC VRF Configuration for Tenant-B: Leaf-11

The `no redistribute host-route` commands below cause type-2 routes to be advertised with a single label: in VLAN 210, 1110; in VLAN 211, 1211; in VLAN 220, 1220; and in the VLAN-aware bundle (Tenant-B-VLAN-212-213), 1212 and 1213.

```
vlan 210
  rd 1.1.1.11:1210
  route-target both 1210:1210
  redistribute learned
  no redistribute host-route
!
vlan 211
  rd 1.1.1.11:1211
  route-target both 1211:1211
  redistribute learned
  no redistribute host-route
!
vlan 220
  rd 1.1.1.11:1220
  route-target both 1220:1220
  redistribute learned
  no redistribute host-route
!
vlan-aware-bundle Tenant-B-VLAN-212-213
  rd 1.1.1.11:21213
  route-target both 212:213
  redistribute learned
  no redistribute host-route
  vlan 212-213
!
```

With this configuration, any locally learned MAC-IP binding on a leaf switch will be advertised as a type-2 route with a single label. For example, on Leaf-11 and Leaf-12, any MAC-IP binding locally learned on subnets 10.10.10.0/24, 10.10.11.0/24, or 10.10.21.0/24 will be advertised as type-2 routes with a single label, the MAC VRF (1210,1211,1220,1212,1213 or 21111). The IP VRF (1001) still advertises the type-5 prefix routes. This ensures connectivity to the remote subnet even when no host on the subnet has been learned.

The VLAN-aware bundle VLAN type-2 routes are advertised with the VNI ID within the update.

17.12.3 EVPN MPLS Sample Configuration

This section describes configuring and verifying BGP VPN which has steps similar to the EVPN VXLAN demonstration. Here, we examine BGP EVPN layer 3 VPN over LDP, Segment Routing (ISIS-SR), and BGP-SR transport LSPs. This highlights the difference between the transport and the VPN overlay service.

17.12.3.1 Layer 3 VPN Over ISIS-SR

The following figures illustrate the overview of combined control and data planes.

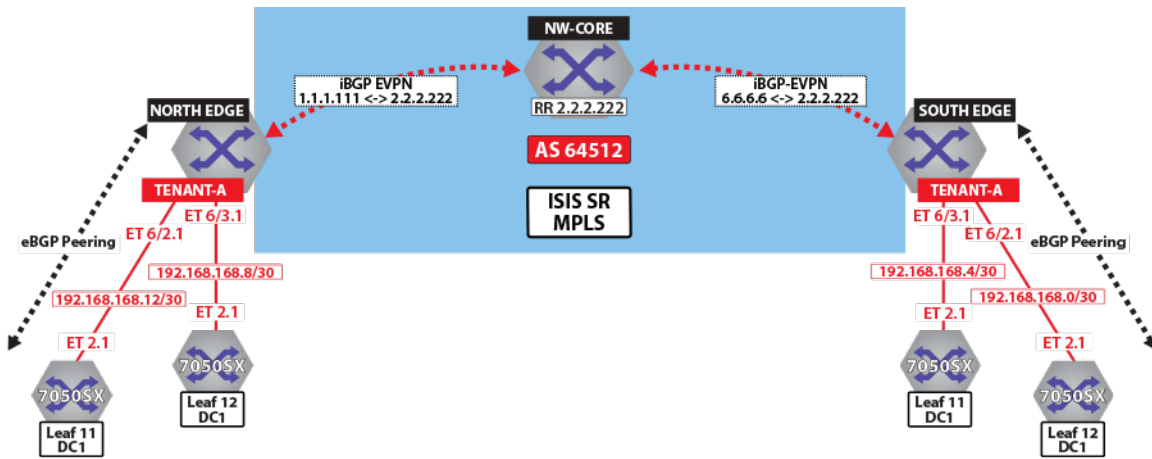

Figure 116: Control Plane Tenant-A Over ISIS-SR

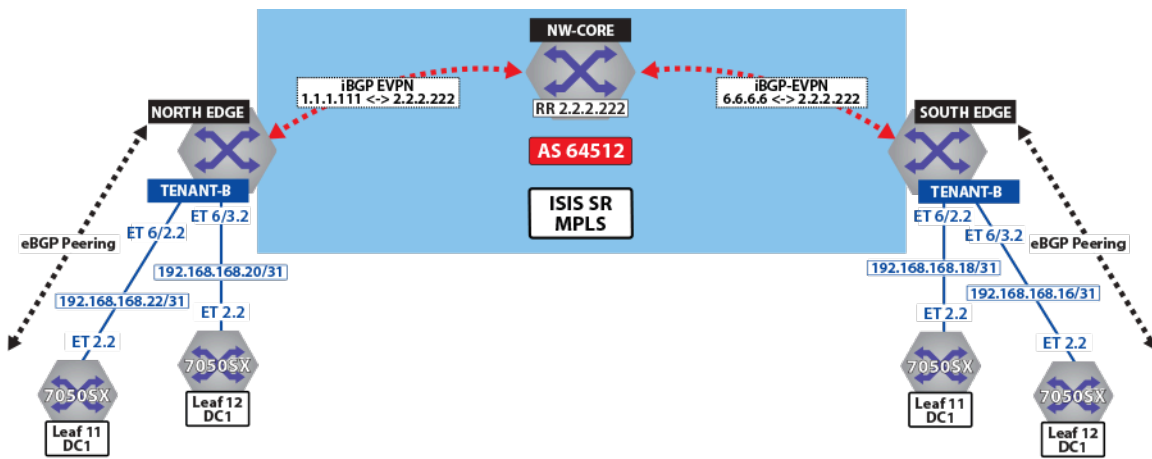

Figure 117: Control Plane Tenant-B over ISIS-SR

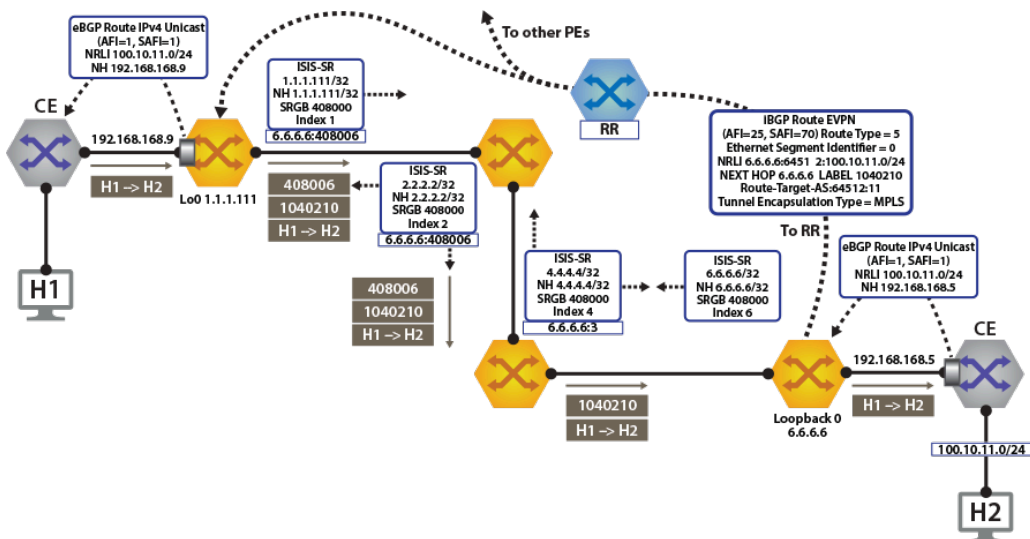

Figure 118: Control Plane & Forwarding Tenant-A Over ISIS-SR

The North Edge router has an eBGP peering session out to leaf-11 and leaf-12 in DC1, while the South Edge router has peerings to leaf-11 and leaf-12 in DC2. Tenant-a has few additional local interfaces used for testing.

Example

The **show ip route vrf tenant-a connected** command displays the interfaces assigned to the tenant-a of North Edge router.

```
north-edge#show ip route vrf tenant-a connected

VRF: tenant-a
Codes: C - connected, S - static, K - kernel,
       O - OSPF, IA - OSPF inter area, E1 - OSPF external type 1,
       E2 - OSPF external type 2, N1 - OSPF NSSA external type 1,
       N2 - OSPF NSSA external type2, B I - iBGP, B E - eBGP,
       R - RIP, I L1 - IS-IS level 1, I L2 - IS-IS level 2,
       O3 - OSPFv3, A B - BGP Aggregate, A O - OSPF Summary,
       NG - Nexthop Group Static Route, V - VXLAN Control Service,
       DH - DHCP client installed default route, M - Martian,
       DP - Dynamic Policy Route

C       192.168.168.8/30 is directly connected, Ethernet6/3.1
C       192.168.168.12/30 is directly connected, Ethernet6/2.1
```

Activating EVPN

In all scenarios, the EVPN must be activated under BGP and neighbors configured to exchange Layer 2 VPN/EVPN NLRI. The tenant's VRF (tenant-a and tenant-b) is associated with a dynamically assigned label by BGP.

An activated EVPN provides the following functionalities:

- Enables the multi-agent routing protocol model, which is required for EVPN support.
- Sets the local autonomous system number to 64512 and configures IBGP neighbors that are activated for the Layer 2 VPN/EVPN address family.
- Sets the EVPN encapsulation type to MPLS.
- Specifies that Loopback0 will be used as the next-hop for all advertised EVPN routes. The underlay configuration must provide MPLS LSPs from remote PEs to this loopback interface address.

Example

The **service routing protocols model multi-agent** command activates EVPN on the north edge router.

```
service routing protocols model multi-agent

router bgp 64512
  router-id 1.1.1.111
  maximum-paths 128 ecmp 128
  neighbor 2.2.2.222 remote-as 64512
  neighbor 2.2.2.222 update-source Loopback0
  neighbor 2.2.2.222 fall-over bfd
  neighbor 2.2.2.222 send-community extended
  !
  address-family evpn
    neighbor default encapsulation mpls next-hop-self source-interface
    Loopback0
    neighbor default graceful-restart
    neighbor 2.2.2.222 activate
```

!

Layer 3 Overlay Configuration

Distribution of layer 3 routes over BGP is enabled by configuring one or more IP VRFs under the router bgp configuration mode. Additionally, IP routing must be enabled in the VRF.

The VRF is assigned a unique Route-Distinguisher (RD). The RD allows the PE to advertise EVPN routes for the same IP prefix that have been exported by different VRFs. The NLRI RouteKey of a route exported from the VRF's IPv4 table into EVPN consists of both the RD and the original IP prefix.

The Route-Target (RT) extended communities for the VRF. The RTs are associated with all routes exported from the VRF. Received EVPN type-5 routes carrying at least one RT matching the VRFs configuration are imported into the VRF. The route target directives are configured under the IPv4 or IPv6 address- family.

Example

The `vrf tenant-a` and `vrf tenant-b` commands define overlay VRFs (tenant-a and tenant-b) on the VTEP of North Edge router and enables IPv4 routing within them.

```
vrf tenant-a
  rd 1.1.1.1:64512
  route-target import evpn 64512:11
  route-target export evpn 64512:11
  router-id 1.1.1.111
  neighbor 192.168.168.10 remote-as 65002
  neighbor 192.168.168.10 local-as 64512 no-prepend replace-as
  neighbor 192.168.168.10 default-originate
  neighbor 192.168.168.10 maximum-routes 12000
  neighbor 192.168.168.14 remote-as 65002
  neighbor 192.168.168.14 local-as 64512 no-prepend replace-as
  neighbor 192.168.168.14 default-originate
  neighbor 192.168.168.14 maximum-routes 12000
  redistribute connected
  redistribute static
!
vrf tenant-b
  rd 1.1.1.1:64513
  route-target import evpn 64513:11
  route-target export evpn 64513:11
  router-id 1.1.1.111
  neighbor 192.168.168.20 remote-as 65002
  neighbor 192.168.168.20 local-as 64513 no-prepend replace-as
  neighbor 192.168.168.20 maximum-routes 12000
  neighbor 192.168.168.22 remote-as 65002
  neighbor 192.168.168.22 local-as 64513 no-prepend replace-as
  neighbor 192.168.168.22 maximum-routes 12000
  redistribute connected
  redistribute static
!
```

Verifying BGP EVPN Layer 3 VPN

Show commands are executed in the North Edge router to view routes to the South Edge router. Execute the same commands in the South Edge router to view vice-versa routes.

Examples

- The **show bgp evpn summary** command displays the status of EVPN peers in North Edge router.

```
north-edge#show bgp evpn summary
BGP summary information for VRF default
Router identifier 1.1.1.111, local AS number 64512
Neighbor Status Codes: m - Under maintenance
Neighbor      V  AS      MsgRcvd  MsgSent  InQ  OutQ  Up/Down  State
PfxRcd PfxAcc
2.2.2.222    4  64512    195      127     0    0 01:13:31 Estab  78    78
```

- The **show bgp evpn route-type ip-prefix ipv4 next-hop 6.6.6.6** command displays all BGP EVPN ip prefix routes received from the South Edge router (6.6.6.6). Not all are advertised via the RR 2.2.2.222.



Note:

Each entry in the table represents a BGP path. The path specific information includes Route-Distinguisher and IP prefix. Paths are either received from EVPN peers or exported from local VRFs.

```
north-edge#show bgp evpn route-type ip-prefix ipv4 next-hop 6.6.6.6
BGP routing table information for VRF default
Router identifier 1.1.1.111, local AS number 64512
Route status codes: s - suppressed, * - valid, > - active, # - not installed, E -
  ECMP head, e - ECMP
                   S - Stale, c - Contributing to ECMP, b - backup
                   % - Pending BGP convergence
Origin codes: i - IGP, e - EGP, ? - incomplete
AS Path Attributes: Or-ID - Originator ID, C-LST - Cluster List, LL Nexthop - Link
  Local Nexthop

* >      Network      Next Hop      Metric  LocPref Weight Path
RD: 6.6.6.6:64512 ip-prefix 0.0.0.0/0
        6.6.6.6      0          100    0      ? Or-ID:
6.6.6.6 C-LST: 2.2.2.222
* >      RD: 6.6.6.6:64513 ip-prefix 0.0.0.0/0
        6.6.6.6      0          100    0      ? Or-ID:
6.6.6.6 C-LST: 2.2.2.222
* >      RD: 6.6.6.6:64514 ip-prefix 10.255.255.0/30
        6.6.6.6      -          100    0      65010 i Or-
ID: 6.6.6.6 C-LST: 2.2.2.222
* >      RD: 6.6.6.6:64512 ip-prefix 100.10.10.0/24
        6.6.6.6      -          100    0      65006 i Or-
ID: 6.6.6.6 C-LST: 2.2.2.222
* >      RD: 6.6.6.6:64513 ip-prefix 100.10.10.0/24
        6.6.6.6      -          100    0      65006 i Or-
ID: 6.6.6.6 C-LST: 2.2.2.222
* >      RD: 6.6.6.6:64512 ip-prefix 100.10.10.103/32
        6.6.6.6      -          100    0      65006 65005
65006 i Or-ID: 6.6.6.6 C-LST: 2.2.2.222
* >      RD: 6.6.6.6:64512 ip-prefix 100.10.10.104/32
        6.6.6.6      -          100    0      65006 65005
65006 i Or-ID: 6.6.6.6 C-LST: 2.2.2.222
* >      RD: 6.6.6.6:64512 ip-prefix 100.10.11.0/24
        6.6.6.6      -          100    0      65006 i Or-
ID: 6.6.6.6 C-LST: 2.2.2.222
* >      RD: 6.6.6.6:64513 ip-prefix 100.10.11.0/24
        6.6.6.6      -          100    0      65006 i Or-
ID: 6.6.6.6 C-LST: 2.2.2.222
* >      RD: 6.6.6.6:64512 ip-prefix 100.10.11.103/32
        6.6.6.6      -          100    0      65006 65005
65006 i Or-ID: 6.6.6.6 C-LST: 2.2.2.222
* >      RD: 6.6.6.6:64512 ip-prefix 100.10.11.104/32
        6.6.6.6      -          100    0      65006 65005
65006 i Or-ID: 6.6.6.6 C-LST: 2.2.2.222
```

- The **show bgp evpn route-type ip-prefix 100.10.11.0/24 detail** command displays a detailed view of the IP prefix route for 100.10.11.0/24. The output again includes the RD

and IP prefix identifying the route. As seen above the route is received from the route reflector, and the VPN label for tenant-a is 958810.

```
north-edge#show bgp evpn route-type ip-prefix 100.10.11.0/24 detail
BGP routing table information for VRF default
Router identifier 1.1.1.111, local AS number 64512
BGP routing table entry for ip-prefix 100.10.11.0/24, Route
  Distinguisher: 6.6.6.6:64512
  Paths: 1 available
    65006
      6.6.6.6 from 2.2.2.222 (2.2.2.222)
        Origin IGP, metric -, localpref 100, weight 0, valid, internal,
        best
        Extended Community: Route-Target-AS:64512:11 TunnelEncap:t
        unnelTypeMpls
        MPLS label: 958810
BGP routing table entry for ip-prefix 100.10.11.0/24, Route
  Distinguisher: 6.6.6.6:64513
  Paths: 1 available
    65006
      6.6.6.6 from 2.2.2.222 (2.2.2.222)
        Origin IGP, metric -, localpref 100, weight 0, valid, internal,
        best
        Extended Community: Route-Target-AS:64513:11 TunnelEncap:t
        unnelTypeMpls
        MPLS label: 953372
```



Note: Tenant-a and tenant-b share the same route. Hence, both route with RD 6.6.6.6:64513 and RT 64513:11.

- The **show ip bgp vrf tenant-a** command displays the BGP table for VRF in tenant-a containing imported EVPN routes. Each entry in the table represent a BGP path that is either locally redistributed / received into the VRF or imported from the EVPN table.

```
north-edge#show ip bgp vrf tenant-a
BGP routing table information for VRF tenant-a
Router identifier 1.1.1.111, local AS number 64512
Route status codes: s - suppressed, * - valid, > - active, # - not installed, E - ECMP
head, e - ECMP
                    S - Stale, c - Contributing to ECMP, b - backup, L - labeled-unicast
                    % - Pending BGP convergence
Origin codes: i - IGP, e - EGP, ? - incomplete
AS Path Attributes: Or-ID - Originator ID, C-LST - Cluster List, LL Nexthop - Link Local
Nexthop

* >      Network          Next Hop          Metric  LocPref  Weight  Path
LST: 2.2.2.222
* >Ec    10.10.10.0/24      192.168.168.14   -        100      0       65002 i
* ec     10.10.10.0/24          192.168.168.10   -        100      0       65002 i
* >Ec    10.10.10.103/32       192.168.168.14   -        100      0       65002 i
* ec     10.10.10.103/32       192.168.168.10   -        100      0       65002 i
* >Ec    10.10.10.104/32       192.168.168.14   -        100      0       65002 i

* >Ec    10.10.44.1/32         192.168.168.14   -        100      0       65002 i
* ec     10.10.44.1/32         192.168.168.10   -        100      0       65002 i
* >      100.10.10.0/24       6.6.6.6           -        100      0       65006 i Or-ID:
6.6.6.6 C-LST: 2.2.2.222
* >      100.10.10.103/32    6.6.6.6           -        100      0       65006 65005 65006 i
Or-ID: 6.6.6.6
C-LST: 2.2.2.222
* >      100.10.10.104/32    6.6.6.6           -        100      0       65006 65005 65006 i
Or-ID: 6.6.6.6
C-LST: 2.2.2.222
* >      100.10.21.102/32   6.6.6.6           -        100      0       65006 65005 65006 i
Or-ID: 6.6.6.6
C-LST: 2.2.2.222
* >      100.10.30.0/24     6.6.6.6           -        100      0       65006 i Or-ID:
6.6.6.6 C-LST: 2.2.2.222
```

```

* > 100.10.32.0/24 6.6.6.6 - 100 0 65006 i Or-ID:
6.6.6.6 C-LST: 2.2.2.222
* > 192.168.168.0/30 6.6.6.6 - 100 0 i Or-ID: 6.6.6.6 C-
LST: 2.2.2.222
* > 192.168.168.4/30 6.6.6.6 - 100 0 i Or-ID: 6.6.6.6 C-
LST: 2.2.2.222
* > 192.168.168.8/30 - - - 0 i
* Ec 192.168.168.8/30 192.168.168.14 - 100 0 65002 i
* ec 192.168.168.8/30 192.168.168.10 - 100 0 65002 i
* > 192.168.168.12/30 - - - 0 i
* Ec 192.168.168.12/30 192.168.168.14 - 100 0 65002 i
* ec 192.168.168.12/30 192.168.168.10 - 100 0 65002 i
* > 223.255.254.248/30 6.6.6.6 - 100 0 65006 i Or-ID:
6.6.6.6 C-LST: 2.2.2.222
* > 223.255.254.252/30 6.6.6.6 - 100 0 65006 65005 65006 i
Or-ID: 6.6.6.6
C-LST: 2.2.2.222
* >Ec 223.255.255.248/30 192.168.168.14 - 100 0 65002 i
* ec 223.255.255.248/30 192.168.168.10 - 100 0 65002 i
* >Ec 223.255.255.252/30 192.168.168.14 - 100 0 65002 i
* ec 223.255.255.252/30 192.168.168.10 - 100 0 65002 i

```



Note: EVPN routes are received from router 2.2.2.222 C-List (cluster list - basically identifying this route as from a route-reflector) with originating router being 6.6.6.6.

- The `show ip route vrf tenant-b` command displays the BGP table for VRF in tenant-b containing imported EVPN routes.

```

north-edge#show ip route vrf tenant-b

VRF: tenant-b
Codes: C - connected, S - static, K - kernel,
       O - OSPF, IA - OSPF inter area, E1 - OSPF external type 1,
       E2 - OSPF external type 2, N1 - OSPF NSSA external type 1,
       N2 - OSPF NSSA external type2, B I - iBGP, B E - eBGP,
       R - RIP, I L1 - IS-IS level 1, I L2 - IS-IS level 2,
       O3 - OSPFv3, A B - BGP Aggregate, A O - OSPF Summary,
       NG - Nexthop Group Static Route, V - VXLAN Control Service,
       DH - DHCP client installed default route, M - Martian,
       DP - Dynamic Policy Route

Gateway of last resort:
B I   0.0.0.0/0 [200/0] via 6.6.6.6/32, IS-IS SR tunnel index 6, label 953372
                        via 192.168.58.12, Ethernet1/1, label 408006
                        via 192.168.59.12, Ethernet2/1, label 408006

B E   10.10.10.0/24 [200/0] via 192.168.168.22, Ethernet6/2.2
                        via 192.168.168.20, Ethernet6/3.2

B E   10.10.21.0/24 [200/0] via 192.168.168.22, Ethernet6/2.2
                        via 192.168.168.20, Ethernet6/3.2

B I   100.10.10.0/24 [200/0] via 6.6.6.6/32, IS-IS SR tunnel index 6, label 953372
                        via 192.168.58.12, Ethernet1/1, label 408006
                        via 192.168.59.12, Ethernet2/1, label 408006

C     192.168.168.20/31 is directly connected, Ethernet6/3.2
C     192.168.168.22/31 is directly connected, Ethernet6/2.2
B I   223.255.254.248/30 [200/0] via 6.6.6.6/32, IS-IS SR tunnel index 6, label 953372
                        via 192.168.58.12, Ethernet1/1, label 408006
                        via 192.168.59.12, Ethernet2/1, label 408006
B I   223.255.254.252/30 [200/0] via 6.6.6.6/32, IS-IS SR tunnel index 6, label 953372
                        via 192.168.58.12, Ethernet1/1, label 408006
                        via 192.168.59.12, Ethernet2/1, label 408006
B E   223.255.255.248/30 [200/0] via 192.168.168.22, Ethernet6/2.2
                        via 192.168.168.20, Ethernet6/3.2
B E   223.255.255.252/30 [200/0] via 192.168.168.22, Ethernet6/2.2
                        via 192.168.168.20, Ethernet6/3.2

```



Note: If we look at the routes in the VRF for tenant-b, we see that the VPN label has now changed, whilst the transport label for NH 6.6.6.6 is the same. The only difference seen in tenant-b, aside from the different VPN label, is that there are no host-routes in tenant-b because within each DC tenant-b is running in asymmetric mode, therefore no host routes are generated/installed in the IP VRF.

17.12.3.2 Layer 3 EVPN Over LDP

The following figures illustrate an overview of the combines control and data planes.

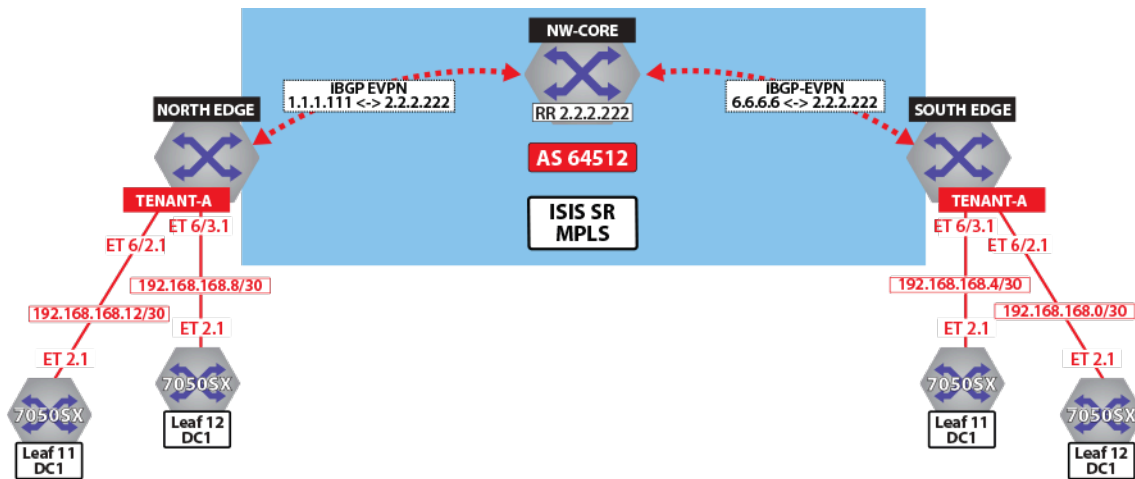

Figure 119: Control Plane Tenant-A Over LDP

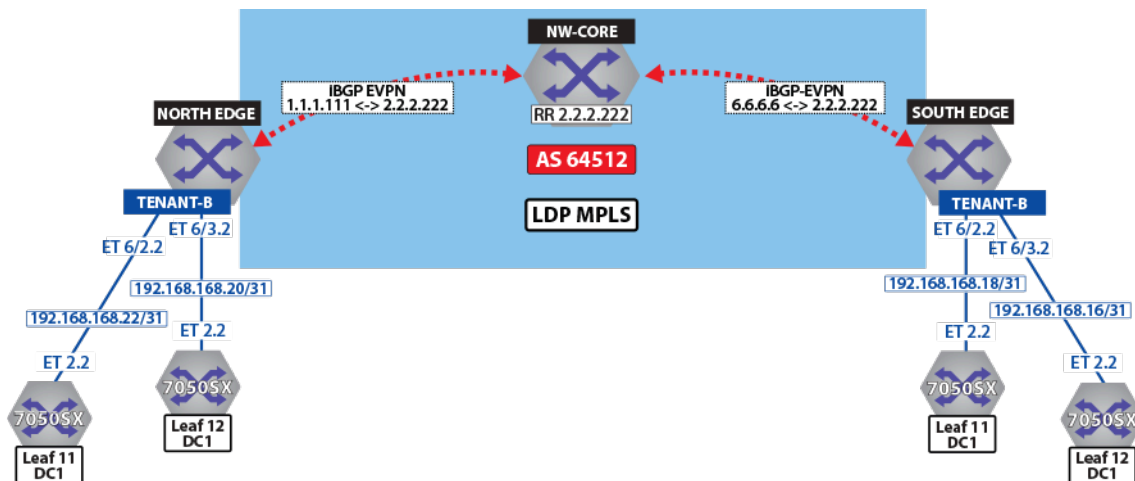

Figure 120: Control Plane Tenant-B over LDP

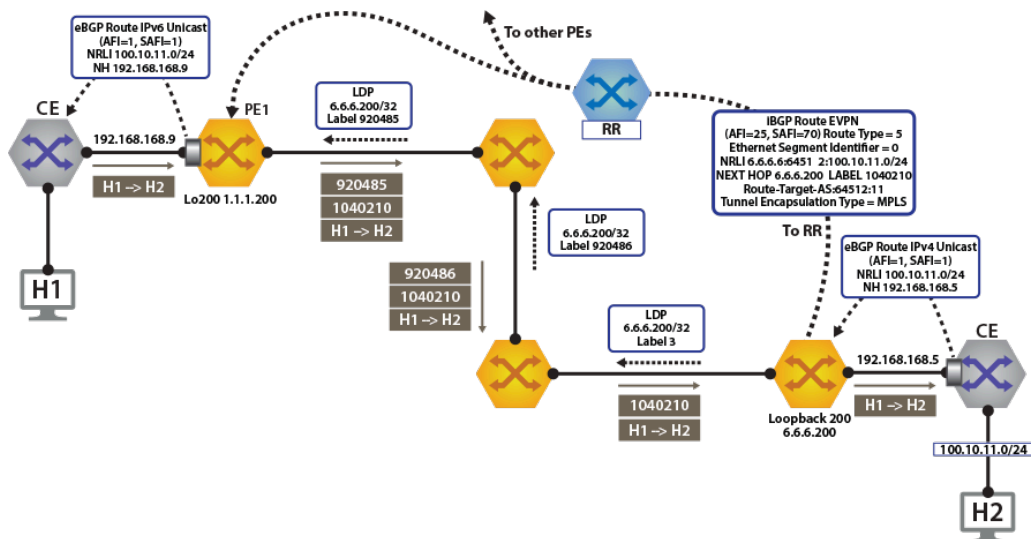

Figure 121: Control Plane & Forwarding Tenant-A Over LDP

To switch to using the MPLS LDP transport, we simply need to change the next-hop advertised for EVPN routes. As illustrated above, the next hop needs to be set to loopback 200 to use the LDP LSP.

This is simply achieved by configuring the next-hop for EVPN routes on both North Edge and South Edge routes. The output again includes the RD and IP prefix identifying the route. As seen in the output, we now have the NH set to 6.6.6.200 for tenant-a and tenant-b.

```
router bgp 64512
!
  address-family evpn
    neighbor default encapsulation mpls next-hop-self source-interface
    Loopback200
```

Once this is configured, we can check the BGP updates and the routes in the VRF.

```
north-edge#show bgp evpn route-type ip-prefix 100.10.11.0/24 detail
BGP routing table information for VRF default
Router identifier 1.1.1.111, local AS number 64512
BGP routing table entry for ip-prefix 100.10.11.0/24, Route Distinguisher: 6.6.6.6:64512
Paths: 1 available
65006
 6.6.6.200 from 2.2.2.222 (2.2.2.222)
  Origin IGP, metric -, localpref 100, weight 0, valid, internal, best
  Extended Community: Route-Target-AS:64512:11 TunnelEncap:tunnelTypeMpls
  MPLS label: 958810
BGP routing table entry for ip-prefix 100.10.11.0/24, Route Distinguisher: 6.6.6.6:64513
Paths: 1 available
65006
 6.6.6.200 from 2.2.2.222 (2.2.2.222)
  Origin IGP, metric -, localpref 100, weight 0, valid, internal, best
  Extended Community: Route-Target-AS:64513:11 TunnelEncap:tunnelTypeMpls
  MPLS label: 953372
```

Note: Again, we have the same route in tenant-a and tenant-b in DC2. Hence, the two other routes with RD 6.6.6.6:64513 and RT 64513:11. The VPN label has not changed, reinforcing the fact that the BGP VPN label is orthogonal to the transport label.

Finally, let us look at the routes in the VRF tenant-a.

```
north-edge#show ip route vrf tenant-a
VRF: tenant-a
Codes: C - connected, S - static, K - kernel,
O - OSPF, IA - OSPF inter area, E1 - OSPF external type 1,
E2 - OSPF external type 2, N1 - OSPF NSSA external type 1,
```

```

N2 - OSPF NSSA external type2, B I - iBGP, B E - eBGP,
R - RIP, I L1 - IS-IS ----level 1, I L2 - IS-IS level 2,
O3 - OSPFv3, A B - BGP Aggregate, A O - OSPF Summary,
NG - Nexthop Group Static Route, V - VXLAN Control Service,
DH - DHCP client installed default route, M - Martian,
DP - Dynamic Policy Route

Gateway of last resort:
B I   0.0.0.0/0 [200/0] via 6.6.6.200/32, LDP tunnel index 1, label 958810
                        via 192.168.58.12, Ethernet1/1, label 904097
                        via 192.168.59.12, Ethernet2/1, label 904098

B E   10.10.10.103/32 [200/0] via 192.168.168.14, Ethernet6/2.1
                                via 192.168.168.10, Ethernet6/3.1
B E   10.10.10.104/32 [200/0] via 192.168.168.14, Ethernet6/2.1
                                via 192.168.168.10, Ethernet6/3.1
B I   100.10.10.103/32 [200/0] via 6.6.6.200/32, LDP tunnel index 1, label 958810
                                via 192.168.58.12, Ethernet1/1, label 904097
                                via 192.168.59.12, Ethernet2/1, label 904098

B I   192.168.168.4/30 [200/0] via 6.6.6.200/32, LDP tunnel index 1, label 958810
                                via 192.168.58.12, Ethernet1/1, label 904097
                                via 192.168.59.12, Ethernet2/1, label 904098
C     192.168.168.8/30 is directly connected, Ethernet6/3.1
C     192.168.168.12/30 is directly connected, Ethernet6/2.1
B I   223.255.254.248/30 [200/0] via 6.6.6.200/32, LDP tunnel index 1, label 958810
                                via 192.168.58.12, Ethernet1/1, label 904097
                                via 192.168.59.12, Ethernet2/1, label 904098

B I   223.255.254.252/30 [200/0] via 6.6.6.200/32, LDP tunnel index 1, label 958810
                                via 192.168.58.12, Ethernet1/1, label 904097
                                via 192.168.59.12, Ethernet2/1, label 904098

B E   223.255.255.248/30 [200/0] via 192.168.168.14, Ethernet6/2.1
                                via 192.168.168.10, Ethernet6/3.1
B E   223.255.255.252/30 [200/0] via 192.168.168.14, Ethernet6/2.1
                                via 192.168.168.10, Ethernet6/3.1

```

 **Note:** As can be seen from the highlighted route above the label stack, the route has the same VPN route 958810, but the transport labels are now 904097 and 904098 on top (this is the ECMP label path to reach NH 6.6.6.200).

As a comparison, let us look at the routes for tenant-b.

```

north-edge#show ip route vrf tenant-b

VRF: tenant-b
Codes: C - connected, S - static, K - kernel,
        O - OSPF, IA - OSPF inter area, E1 - OSPF external type 1,
        E2 - OSPF external type 2, N1 - OSPF NSSA external type 1,
        N2 - OSPF NSSA external type2, B I - iBGP, B E - eBGP,
        R - RIP, I L1 - IS-IS level 1, I L2 - IS-IS level 2,
        O3 - OSPFv3, A B - BGP Aggregate, A O - OSPF Summary,
        NG - Nexthop Group Static Route, V - VXLAN Control Service,
        DH - DHCP client installed default route, M - Martian,
        DP - Dynamic Policy Route

Gateway of last resort:
B I   0.0.0.0/0 [200/0] via 6.6.6.200/32, LDP tunnel index 1, label 953372
                        via 192.168.58.12, Ethernet1/1, label 904097
                        via 192.168.59.12, Ethernet2/1, label 904098

B E   10.10.10.0/24 [200/0] via 192.168.168.22, Ethernet6/2.2
                                via 192.168.168.20, Ethernet6/3.2
                                via 192.168.168.20, Ethernet6/3.2
B I   100.10.10.0/24 [200/0] via 6.6.6.200/32, LDP tunnel index 1, label 953372
                                via 192.168.58.12, Ethernet1/1, label 904097
                                via 192.168.59.12, Ethernet2/1, label 904098
                                via 192.168.59.12, Ethernet2/1, label 904098
B I   192.168.168.18/31 [200/0] via 6.6.6.200/32, LDP tunnel index 1, label 953372
                                via 192.168.58.12, Ethernet1/1, label 904097
                                via 192.168.59.12, Ethernet2/1, label 904098
C     192.168.168.20/31 is directly connected, Ethernet6/3.2
C     192.168.168.22/31 is directly connected, Ethernet6/2.2
B I   223.255.254.248/30 [200/0] via 6.6.6.200/32, LDP tunnel index 1, label 953372
                                via 192.168.58.12, Ethernet1/1, label 904097

```

```

B I 223.255.254.252/30 [200/0] via 192.168.59.12, Ethernet2/1, label 904098
    via 6.6.6.200/32, LDP tunnel index 1, label 953372
    via 192.168.58.12, Ethernet1/1, label 904097
    via 192.168.59.12, Ethernet2/1, label 904098
B E 223.255.255.248/30 [200/0] via 192.168.168.22, Ethernet6/2.2
    via 192.168.168.20, Ethernet6/3.2
B E 223.255.255.252/30 [200/0] via 192.168.168.22, Ethernet6/2.2

```

Note: The only difference apart from the missing host routes (no host-route inject for this tenant), is the VPN label.

17.12.3.3 Layer 3 EVPN Over BGP-SR

The following figures illustrate an overview of the combined control and data planes.

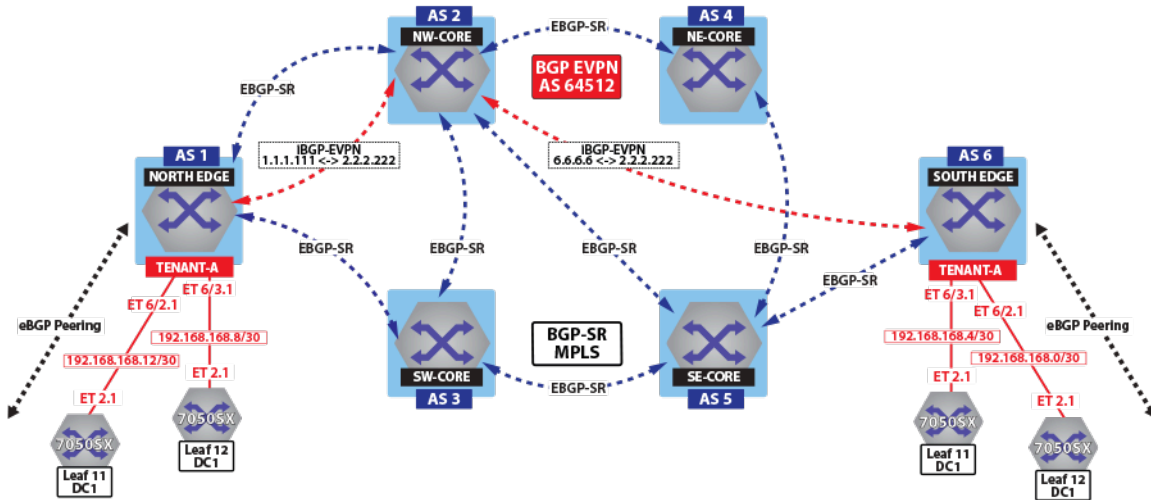

Figure 122: Control Plane Tenant-A Over BGP-SR

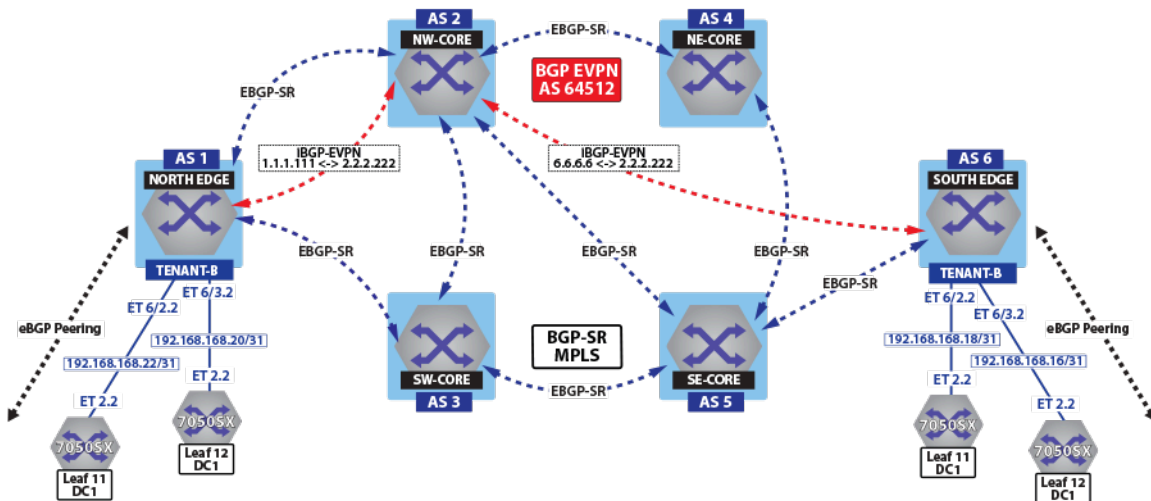

Figure 123: Control Plane Tenant-B Over BGP-SR

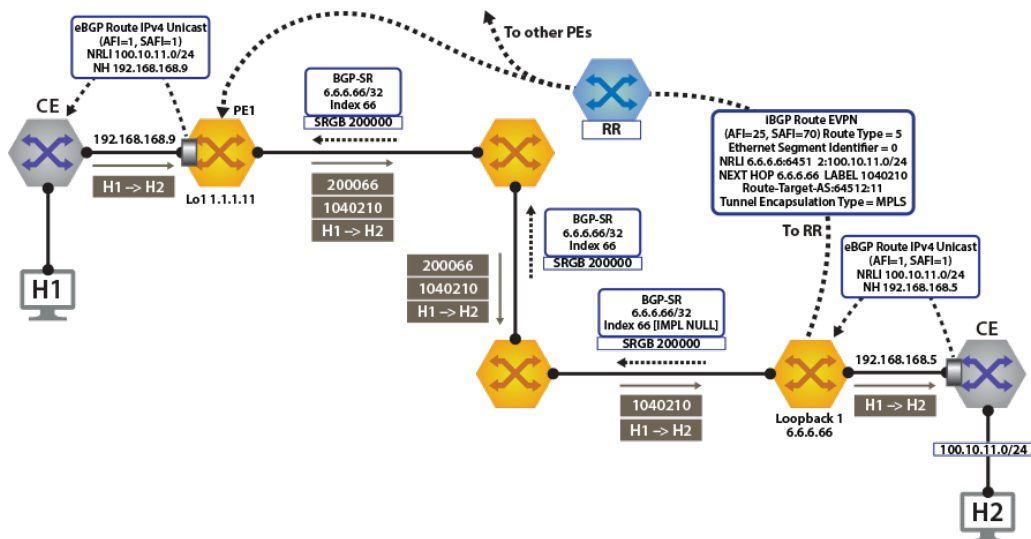

Figure 124: Control Plane & Forwarding Tenant-A Over BGP-SR

To switch to using the MPLS BGP-SR transport, we simply need to change the next-hop advertised for the EVPN routes. As shown in Control Plane Tenant-b Over BGP-SR, the next hop needs to be set to loopback 1 for using the BGP-SR LSP. This is achieved by configuring the next-hop for the EVPN routes.

```
router bgp 64512
!
 address-family evpn
  neighbor default encapsulation mpls next-hop-self source-interface
  Loopback1
```

Once the next-hop for the EVPN routes are configured, we can check the BGP updates and the routes in the VRF. The output again includes the RD and IP prefix identifying the route. As seen in the output, we now have the NH set to 6.6.6.66 for tenant-a and tenant-b.

```
North Edge.17:52:30#show bgp evpn route-type ip-prefix 100.10.11.0/24
detail

north-edge(config-if-Et2/1)#show bgp evpn route-type ip-prefix
100.10.11.0/24 detail
BGP routing table information for VRF default
Router identifier 1.1.1.111, local AS number 64512
BGP routing table entry for ip-prefix 100.10.11.0/24, Route Distinguisher
: 6.6.6.6:64512
Paths: 1 available
65006
6.6.6.66 from 2.2.2.222 (2.2.2.222)
Origin IGP, metric -, localpref 100, weight 0, valid, internal,
best
Extended Community: Route-Target-AS:64512:11 TunnelEncap:t
unnelTypeMpls
MPLS label: 958810
BGP routing table entry for ip-prefix 100.10.11.0/24, Route Distinguisher
: 6.6.6.6:64513
Paths: 1 available
65006
6.6.6.66 from 2.2.2.222 (2.2.2.222)
Origin IGP, metric -, localpref 100, weight 0, valid, internal,
best
```

```
Extended Community: Route-Target-AS:64513:11 TunnelEncap:t  
unnelTypeMpls  
MPLS label: 953372
```

 **Note:** Again, we have the same route in tenant-a and tenant-b in DC2. Hence, the two other routes with RD 6.6.6:64513 and RT 64513:11. The VPN label has not changed, reinforcing the fact that the BGP VPN label is orthogonal to the transport label.

Finally, let us look at the routes in the VRF tenant-a.

```
North Edge.17:55:01#show ip route vrf tenant-a  
  
VRF: tenant-a  
Codes: C - connected, S - static, K - kernel,  
O - OSPF, IA - OSPF inter area, E1 - OSPF external type 1,  
E2 - OSPF external type 2, N1 - OSPF NSSA external type 1,  
N2 - OSPF NSSA external type2, B I - iBGP, B E - eBGP,  
R - RIP, I L1 - IS-IS level 1, I L2 - IS-IS level 2,  
O3 - OSPFv3, A B - BGP Aggregate, A O - OSPF Summary,  
NG - Nexthop Group Static Route, V - VXLAN Control Service,  
DH - DHCP client installed default route, M - Martian,  
DP - Dynamic Policy Route  
  
Gateway of last resort:  
B I 0.0.0.0/0 [200/0] via 6.6.6.66/32, BGP LU tunnel index 8, label  
958810  
via 192.168.58.12, Ethernet1/1, label 200066  
via 192.168.59.12, Ethernet2/1, label 200066  
  
B E 10.10.10.103/32 [200/0] via 192.168.168.14, Ethernet6/2.1  
via 192.168.168.10, Ethernet6/3.1  
B E 10.10.10.104/32 [200/0] via 192.168.168.14, Ethernet6/2.1  
via 192.168.168.10, Ethernet6/3.1  
via 192.168.168.10, Ethernet6/3.1  
B I 100.10.10.103/32 [200/0] via 6.6.6.66/32, BGP LU tunnel index 8,  
label 958810  
via 192.168.58.12, Ethernet1/1, label  
200066  
via 192.168.59.12, Ethernet2/1, label  
200066  
  
B I 192.168.168.4/30 [200/0] via 6.6.6.66/32, BGP LU tunnel index 8,  
label 958810  
via 192.168.58.12, Ethernet1/1, label  
200066  
via 192.168.59.12, Ethernet2/1, label  
200066  
C 192.168.168.8/30 is directly connected, Ethernet6/3.1  
C 192.168.168.12/30 is directly connected, Ethernet6/2.1  
B I 223.255.254.248/30 [200/0] via 6.6.6.66/32, BGP LU tunnel index  
8, label 958810  
via 192.168.58.12, Ethernet1/1,  
label 200066  
via 192.168.59.12, Ethernet2/1,  
label 200066  
B I 223.255.254.252/30 [200/0] via 6.6.6.66/32, BGP LU tunnel index  
8, label 958810  
via 192.168.58.12, Ethernet1/1,  
label 200066  
via 192.168.59.12, Ethernet2/1,  
label 200066  
B E 223.255.255.248/30 [200/0] via 192.168.168.14, Ethernet6/2.1
```

```

B E    223.255.255.252/30 [200/0] via 192.168.168.10, Ethernet6/3.1
                                     via 192.168.168.14, Ethernet6/2.1
                                     via 192.168.168.10, Ethernet6/3.1

```

As can be seen from the highlighted route above the label stack, the route are the transport labels 958810 and 200066 on top (this is the ECMP label path to reach NH 6.6.6.66), with the tenant-a VPN label 958810 next in the stack, identifying the route as belonging to tenant-a.

As a comparison, let us look at the routes for tenant-b. As seen in the output, the VPN label assigned to tenant-b is 953372.

```

north-edge#show bgp evpn route-type ip-prefix 100.10.11.0/24 detail
BGP routing table information for VRF default
Router identifier 1.1.1.111, local AS number 64512
BGP routing table entry for ip-prefix 100.10.11.0/24, Route Distinguisher
: 6.6.6.6:64512
  Paths: 1 available
    65006
      6.6.6.66 from 2.2.2.222 (2.2.2.222)
        Origin IGP, metric -, localpref 100, weight 0, valid, internal,
        best
        Extended Community: Route-Target-AS:64512:11 TunnelEncap:t
unnelTypeMpls
        MPLS label: 958810
BGP routing table entry for ip-prefix 100.10.11.0/24, Route Distinguisher
: 6.6.6.6:64513
  Paths: 1 available
    65006
      6.6.6.66 from 2.2.2.222 (2.2.2.222)
        Origin IGP, metric -, localpref 100, weight 0, valid, internal,
        best
        Extended Community: Route-Target-AS:64513:11 TunnelEncap:t
unnelTypeMpls
        MPLS label: 953372
north-edge#

```

If we now look at the routes in the VRF for tenant-b, we see that the VPN label has now changed, while the transport label (for NH 6.6.6.66 is the same). The only difference seen in tenant-b, aside from the different VPN label, is that there are no host-routes in tenant-b because within each DC tenant-b is running in asymmetric mode; therefore, no host routes are generated/installed in the IP VRF.

```

north-edge#show ip route vrf tenant-b

VRF: tenant-b
Codes: C - connected, S - static, K - kernel,
       O - OSPF, IA - OSPF inter area, E1 - OSPF external type 1,
       E2 - OSPF external type 2, N1 - OSPF NSSA external type 1,
       N2 - OSPF NSSA external type2, B I - iBGP, B E - eBGP,
       R - RIP, I L1 - IS-IS level 1, I L2 - IS-IS level 2,
       O3 - OSPFv3, A B - BGP Aggregate, A O - OSPF Summary,
       NG - Nexthop Group Static Route, V - VXLAN Control Service,
       DH - DHCP client installed default route, M - Martian,
       DP - Dynamic Policy Route

Gateway of last resort:
B I    0.0.0.0/0 [200/0] via 6.6.6.66/32, BGP LU tunnel index 8, label
953372
                                     via 192.168.58.12, Ethernet1/1, label 200066
                                     via 192.168.59.12, Ethernet2/1, label 200066

B E    10.10.10.0/24 [200/0] via 192.168.168.22, Ethernet6/2.2
                                     via 192.168.168.20, Ethernet6/3.2

```

```

B E    10.10.21.0/24 [200/0] via 192.168.168.22, Ethernet6/2.2
                                via 192.168.168.20, Ethernet6/3.2
B I    100.10.10.0/24 [200/0] via 6.6.6.66/32, BGP LU tunnel index 8,
label 953372
                                via 192.168.58.12, Ethernet1/1, label
200066
                                via 192.168.59.12, Ethernet2/1, label
200066
B I    192.168.168.18/31 [200/0] via 6.6.6.66/32, BGP LU tunnel index 8,
label 953372
                                via 192.168.58.12, Ethernet1/1,
label 200066
                                via 192.168.59.12, Ethernet2/1,
label 200066
C      192.168.168.20/31 is directly connected, Ethernet6/3.2
C      192.168.168.22/31 is directly connected, Ethernet6/2.2
B I    223.255.254.248/30 [200/0] via 6.6.6.66/32, BGP LU tunnel index
8, label 953372
                                via 192.168.58.12, Ethernet1/1,
label 200066
                                via 192.168.59.12, Ethernet2/1,
label 200066
B I    223.255.254.252/30 [200/0] via 6.6.6.66/32, BGP LU tunnel index
8, label 953372
                                via 192.168.58.12, Ethernet1/1,
label 200066
                                via 192.168.59.12, Ethernet2/1,
label 200066
B E    223.255.255.248/30 [200/0] via 192.168.168.22, Ethernet6/2.2
                                via 192.168.168.20, Ethernet6/3.2
B E    223.255.255.252/30 [200/0] via 192.168.168.22, Ethernet6/2.2
                                via 192.168.168.20, Ethernet6/3.2

```

17.12.4 EVPN VxLAN IPv6 Overlay

The EVPN VxLAN L3 Gateway using EVPN IRB supports routing traffic from one IPv6 host to another IPv6 host on a stretched VxLAN VLAN on platforms that support ND Proxy and ND suppression. The `ipv6 address virtual` command enables the use of one MAC address for all SVI instead of one per SVI. Both EVPN IRB and VxLAN tunnel interface are required for the feature to work. The VxLAN must be configured with a VNI or the VRF for the VLAN must be configured with a VRF/VNI mapping.

Configuring for Overlay

The following configures the switches for global IPv6 unicast routing and IPv6 unicast routing for each VRF.

```

Switch(config)# ipv6 unicast-routing
Switch(config)# ipv6 unicast-routing vrf tenant-c

```

The following configures the switches with a virtual MAC address, which is used for mapping all virtual router IP addresses. For VARP configs, the address is receive-only; the switch never sends packets with this address as the source. For `ip address virtual`, the address is also used as the source for ARP packets.

```

Switch(config)# ipv6 virtual-router mac-address <mac>

```

The following shows the switch with IPv6 configured where one SVI uses one physical IP address.

```
Switch# sh run int vlan 501
interface Vlan501
    vrf forwarding tenant-c
    ipv6 enable
    ipv6 address 2004:220::1:2/112
    ipv6 virtual-router address 2004:220::1:10
```

The following shows configuration for the switch such that all SVI use the virtual MAC address and only one physical IP address.

```
Switch# sh run int vlan 501
interface Vlan501
    vrf forwarding tenant-c
    ipv6 enable
    ipv6 address virtual 2004:220::1:10/112
```

Limitations

Any topology that requires a VXLAN Virtual VTEP address configuration is not supported.

Example Configurations

VRF-TO-VNI MAP and VLAN-TO-VNI MAP

Under Vxlan1 interface:

```
Switch(config)#
interface vxlan1
    vxlan vrf tenant-c vni 4001
    vxlan vlan 501 vni 10501
```

MAC-VRF

Under BGP router configuration mode:

```
Switch(config)#
Router bgp 65000
vlan 501
    rd 20.1.1.1:10501
    route-target both 1:10501
    redistribute learned
```

IPv6 VRF BGP

```
Switch(config)#
router bgp 65000
vrf tenant-c
    rd 2.0.0.1:4001
    router-target import evpn 4001:4001
    router-target export evpn 4001:4001

! configure IPv4 router ID under the BGP VRF configuration
! for activating V6-only VRF
!
router-id 4.0.0.1
```

The selective installation configuration is the same for ARP and IPv6 ND.

```
Switch(config)# router l2-vpn
Switch(config-rtr-l2-vpn)#arp ?
```

```
proxy Proxy ARP
selective-install Install ARP entries for remote hosts on demand
Switch(config-rtr-l2-vpn)#arp selective-install
```

The following disables the ND proxy reply to an NS for the specified target IPv6 address(es).

```
Switch(config)#
ipv6 prefix-list list-test
seq 10 deny 2000:0:0:69::19/64
! do not perform ND proxy on 2000:0:0:69::19/64

Switch(config)# router l2-vpn
Switch(config-rtr-l2-vpn)#nd proxy prefix-list list-test
```

The following restores the proxy behavior.

```
Switch(config)# router l2-vpn
Switch(config-rtr-l2-vpn)#no nd proxy prefix-list list-test
```

The following disables router solicitation packets sent by a host from getting flooded to all VTEPs.

```
Switch(config)# router l2-vpn
Switch(config-rtr-l2-vpn)#nd rs flooding disabled
```

The following restores the default behavior.

```
Switch(config)# router l2-vpn
Switch(config-rtr-l2-vpn)#no nd rs flooding disabled
```

The following disables duplicate-address-detection (DAD) multicast packets from getting flooded to all VTEPs when there is no matching IP to MAC binding found in EVPN published IP to MAC bindings. When there is a match found, a DAD frame is flooded to all VTEPs (instead of doing a proxy reply) to confirm that host liveliness.

```
Switch(config)# router l2-vpn
Switch(config-rtr-l2-vpn)#nd dad flooding disabled
```

The following restores the default behavior.

```
Switch(config)# router l2-vpn
Switch(config-rtr-l2-vpn)#no nd dad flooding disabled
```

The following disables Neighbor Advertisement (NA) multicast packets from the SVI configured as a virtual router from getting flooded to all VTEPs.

```
Switch(config)# router l2-vpn
Switch(config-rtr-l2-vpn)#virtual-router neighbor advertisement flooding disabled
```

The following restores the default behavior.

```
Switch(config)# router l2-vpn
Switch(config-rtr-l2-vpn)#no virtual-router neighbor advertisement flooding disabled
```

The following disables Gratuitous ARP multicast packets from the SVI configured as a virtual router from getting flooded to all VTEPs.

```
Switch(config)# router l2-vpn
```

```
Switch(config-rtr-l2-vpn) #virtual-router arp advertisement flooding
disabled
```

The following restores the default behavior.

```
Switch(config) # router l2-vpn
Switch(config-rtr-l2-vpn) #no virtual-router arp advertisement flooding
disabled
```

Checking the Status of the Switches

IPv6 Local Host

The following displays the ND bindings for a given VRF. The output shows that the local host “002c.0100.0001” has an IPv6 link local address “fe80::22c:1ff:fe00:1” and a global IPv6 address “2004:220::1:50”. The host is connected to the MLAG port-channel 20.

```
Switch# show ipv6 neighbors vrf tenant-c vlan 501 | i 002c.0100.0001
2004:220::1:50          N/A 002c.0100.0001    REACH V1501, Port-Channel20
fe80::22c:1ff:fe00:1   N/A 002c.0100.0001    REACH V1501, Port-Channel20
```

EVPN IRB redistributes all the local hosts in VLAN 501. The MAC address of the host is advertised as EVPN Type 2 MAC-only route advertisement. The global IPv6 to MAC binding is advertised using MAC-IP route.

 **Note:** By default, the IPv6 link local binding is not advertised by EVPN.

The following displays the two MAC-only routes and two MAC-IP routes. In both cases, one route is locally originated and the second one advertised by the MLAG peer with the same VTEP IP “10.0.0.1”.

```
Switch# show bgp evpn route-type mac-ip 002c.0100.0001
BGP routing table information for VRF default
Router identifier 1.0.1.1, local AS number 65000
Route status codes: s - suppressed, * - valid, > - active, # - not
                    installed, E - ECMP head, e - ECMP
                    S - Stale, c - Contributing to ECMP, b - backup
                    % - Pending BGP convergence
Origin codes: i - IGP, e - EGP, ? - incomplete
AS Path Attributes: Or-ID - Originator ID, C-LST - Cluster List, LL
                    Nexthop - Link Local Nexthop
```

Weight	Network	Next Hop	Metric	LocPref
* >	RD: 20.1.1.1:10501	mac-ip 002c.0100.0001	-	0
i	RD: 20.1.1.2:10501	mac-ip 002c.0100.0001	-	0
65002 65003 i		10.0.0.1	-	100
* >	RD: 20.1.1.1:10501	mac-ip 002c.0100.0001	2004:220::1:50	0
i	RD: 20.1.1.2:10501	mac-ip 002c.0100.0001	2004:220::1:50	0
65002 65003 i		10.0.0.1	-	100

IPv6 Link Local Redistribution

The following configures `link-local redistribution` command under BGP router MAC-VRF configuration mode to redistribute IPv6 link local binding.

```
vlan 501
rd 20.1.1.1:10501
route-target both 1:10501
redistribute learned
redistribute link-local ipv6
```

When this is configured, NS from a local host for a link local target will get proxy-replied by the ingress VTEP if the binding is published to EVPN by a remote VTEP. The NS in that case will not get replicated to other VTEPs.

IPv6 Remote Host

The following displays the MAC-only and MAC-IP routes for remote host "002d.0100.0001". These two routes originated from VTEP 10.0.0.2.

```
Switch# show bgp evpn route-type mac-ip 002d.0100.0001 detail
BGP routing table information for VRF default
Router identifier 1.0.1.1, local AS number 65000

BGP routing table entry for mac-ip 002d.0100.0001, Route Distinguisher:
20.1.1.3:10501
Paths: 1 available
 65002 65004
 10.0.0.2 from 1.0.1.111 (1.0.1.111)
   Origin IGP, metric -, localpref 100, weight 0, valid, external,
  best
   Extended Community: Route-Target-AS:1:10501 TunnelEncap:t
unnelTypeVxlan
   VNI: 10501 ESI: 0000:0000:0000:0000:0000

BGP routing table entry for mac-ip 002d.0100.0001 2004:220::1:151, Route
Distinguisher: 20.1.1.3:10501
Paths: 1 available
 65002 65004
 10.0.0.2 from 1.0.1.111 (1.0.1.111)
   Origin IGP, metric -, localpref 100, weight 0, valid, external,
  best
   Extended Community: Route-Target-AS:1:10501 Route-Target-
AS:4001:4001 TunnelEncap:tunnelTypeVxlan
EvpnRouterMac:28:99:3a:be:53:42
   VNI: 10501 L3 VNI: 4003 ESI: 0000:0000:0000:0000:0000
```

IPv6 Remote Binding for Asymmetric IRB

The following displays the local MAC-VRF *Vlan 501* is configured to import RT *two octets ASN RT 1:10501*. The MAC-IP route is imported into remote binding for *Vlan 501*.

```
Switch# show ipv6 neighbors remote vlan 501
ARP remote bindings
VLAN IP Address          MAC Address
-----
501 2004:220::1:151 002d.0100.0001
```

Without ARP Selective install, always install the remote IPv6 ND binding.

The following displays the ND bindings installed in the IPv6 cache. The interface for remote hosts is always *Vxlan1 501* and age is displayed with a '-'.

```
Switch# show ipv6 neighbors vrf tenant-c vlan 501 2004:220::1:151
```

```
IPv6 Address      Age Hardware Addr  State Interface
2004:220::1:151  - 002d.0100.0001  REACH V1501, Vxlan1
```

IPv6 Remote Host for Symmetric IRB

The following displays the BGP information for a specific IPv6 prefix in a VRF.

```
Switch# show ipv6 bgp 2004:220::1:151 vrf tenant-c
BGP routing table information for VRF tenant-c
Router identifier 100.52.7.254, local AS number 65000
BGP routing table entry for 2004:220::1:151/128
  Paths: 2 available
        65002 65004
        10.0.0.2 from 1.0.1.111 (1.0.1.111), imported EVPN route, RD
        20.1.1.3:10501
        Origin IGP, metric -, localpref 100, weight 0, valid, external, best
Extended Community: Route-Target-AS:1:10501 Route-Target-AS:4001:4001
TunnelEncap:tunnelTypeVxlan
EvpnRouterMac:28:99:3a:be:53:42
  Remote VNI: 4003
  65000 65002 65004
  2005:951:1:1::1:2 from 2005:951:1:1::1:2 (100.52.7.254)
  Origin IGP, metric -, localpref 100, weight 0, valid, external
  Not best: As path length
```

The following displays the route for a specific IPv6 prefix in a VRF.

```
Switch# show ipv6 route vrf tenant-c 2004:220::1:151
VRF: tenant-c
Routing entry for 2004:220::1:151
Codes: C - connected, S - static, K - kernel, O3 - OSPFv3, B - BGP, R -
RIP, A B - BGP Aggregate,
I L1 - IS-IS level 1, I L2 - IS-IS level 2, DH - DHCP, NG - Nexthop Group
Static Route, M - Martian,
DP - Dynamic Policy Route, L - VRF Leaked

B          2004:220::1:151/128 [200/0]
           via VTEP 10.0.0.2 VNI 4003 router-mac 28:99:3a:be:53:42
```

The following displays the VXLAN SW counters for IPv6 Neighbor Discovery Packets.

```
Switch# show vxlan counters software | egrep 'ND|neighbor'
ND NS pkts skipped HER as target Ip matched SVI IP      : 0
ND NS proxy errors during transmit                      : 0
ND NS proxy neighbor remote binding misses              : 0
ND NS proxy neighbor cache misses                       : 0
ND NS proxy denied due to ACL                           : 0
ND NS proxy not applied as neighbor entry is dynamic   : 0
ND NS proxy not applied as target link is local         : 0
ND NS proxy not applied as target IP is local           : 0
ND NS proxy not applied as sender link not in fdb      : 0
ND NS proxy not applied as pkt is invalid               : 0
ND NS proxy DAD frames suppressed                       : 0
ND NS proxy neighbor advt sent                          : 0
ND NS pkts from unspecified source                      : 9
ND NS pkts total suppressed                             : 0
ND NS pkts total received                               : 9
ND NA pkts total suppressed                             : 0
ND NA pkts total received                               : 0
ND NA pkts invalid                                      : 0
ND NA pkts not suppressed as source is SVI             : 0
ND NA pkts suppressed as source is SVI                 : 0
ND RS pkts total suppressed                             : 0
```

```
total dynamic neighbor cache entries added in error : 0
```

The following displays the VXLAN VARP packets for IPv6 **ipv6 address virtual** configurations.

```
Switch# show vxlan counters varp | grep 'neighbor'
neighbor advertisements received : 0
neighbor advertisements received in error : 0
neighbor advertisements not headend replicated : 0
neighbor sync msgs sent to mlag-peer : 0
neighbor cache installed : 0
neighbor cache install err : 0
neighbor cache install conflicts : 0
neighbor sync msgs received from mlag-peer : 0
neighbor cache synced install err : 0
neighbor cache synced install conflicts : 0
```

17.12.5 IP VPNs Sample Configuration

Here, we examine BGP EVPN layer 3 VPN over an LDP, ISIS-SR, and BGP-SR transport LSPs. This highlights the separation between the transport and the VPN overlay service.

The following figures illustrate the sample VPN Physical Topology.

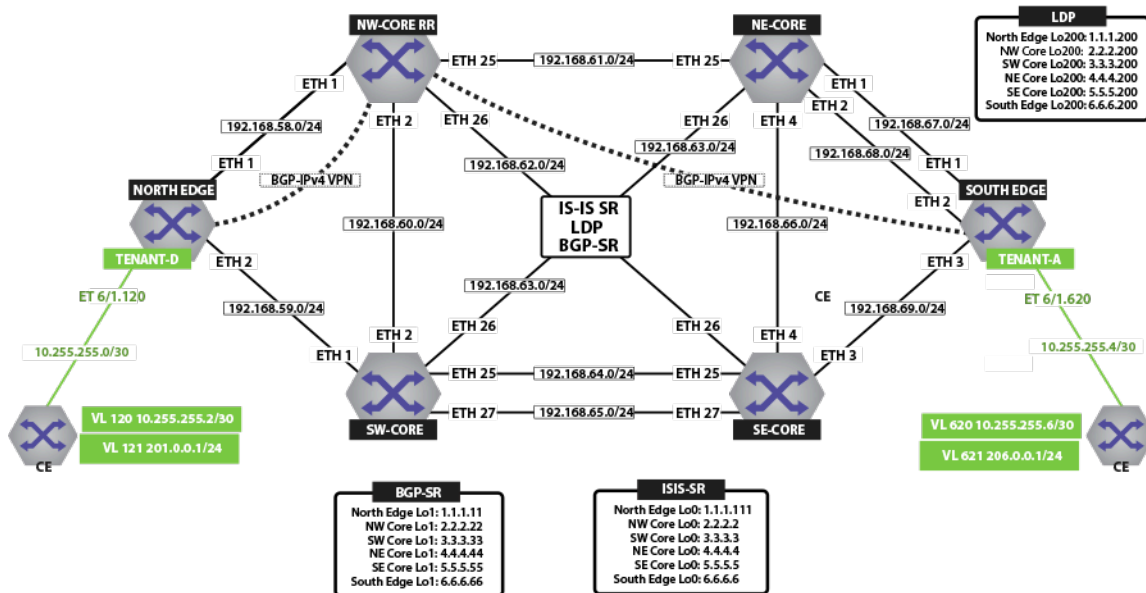

Figure 125: IPv4 VPN Physical Topology

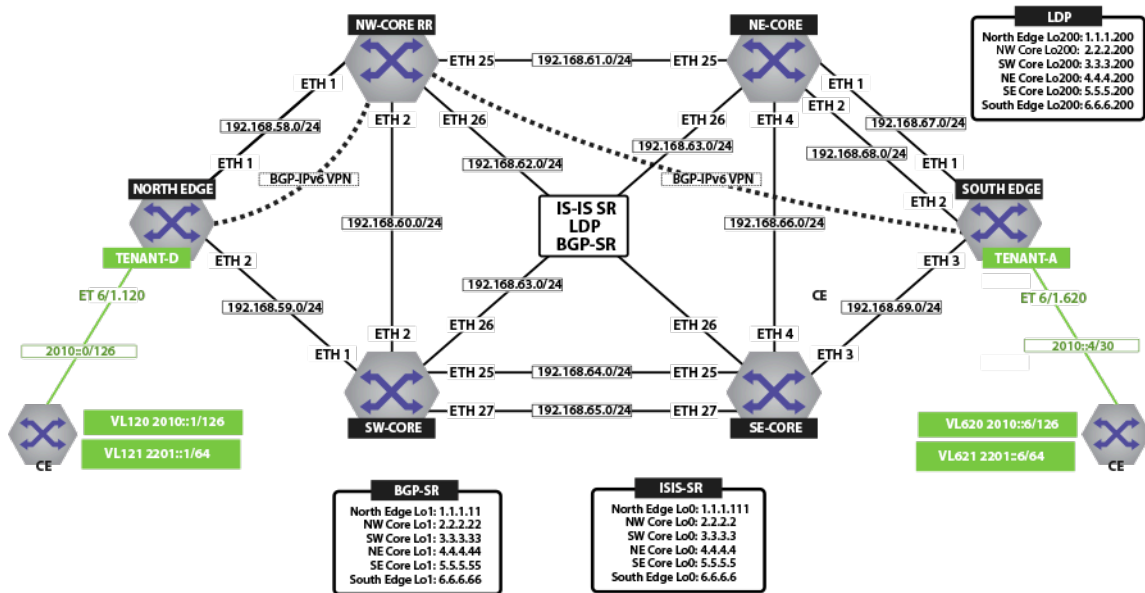

Figure 126: IPv6 VPN Physical Topology

17.12.5.1 IP VPN over ISIS-SR

The figure below illustrates an overview of the combined control and data planes.

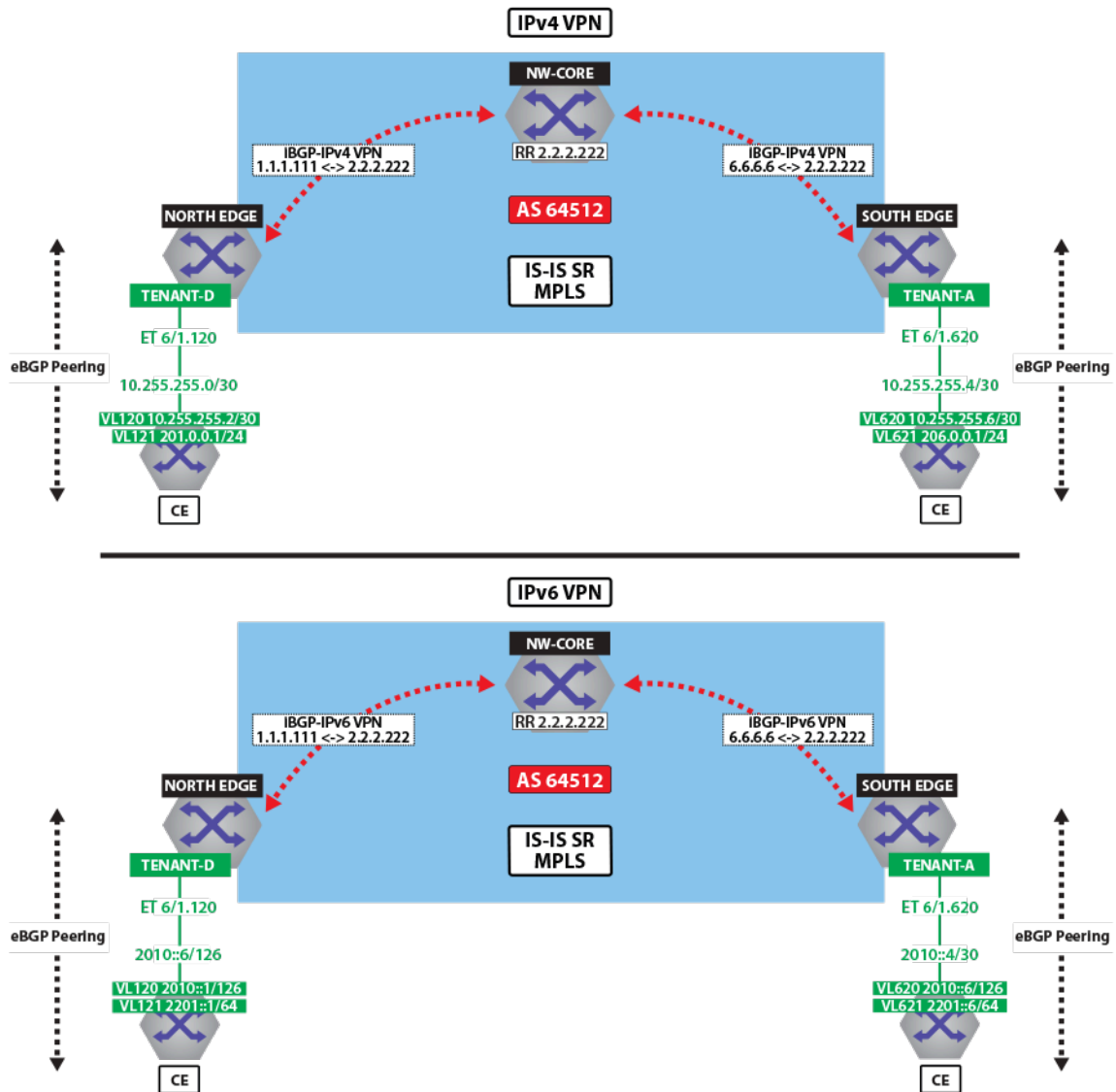

Figure 127: IPv4 VPN and IPv6 VPN Over IS-IS SR MPLS

The next two figures illustrate the forwarding path and control plane for both IP traffic over IS-IS MPLS segment routing.

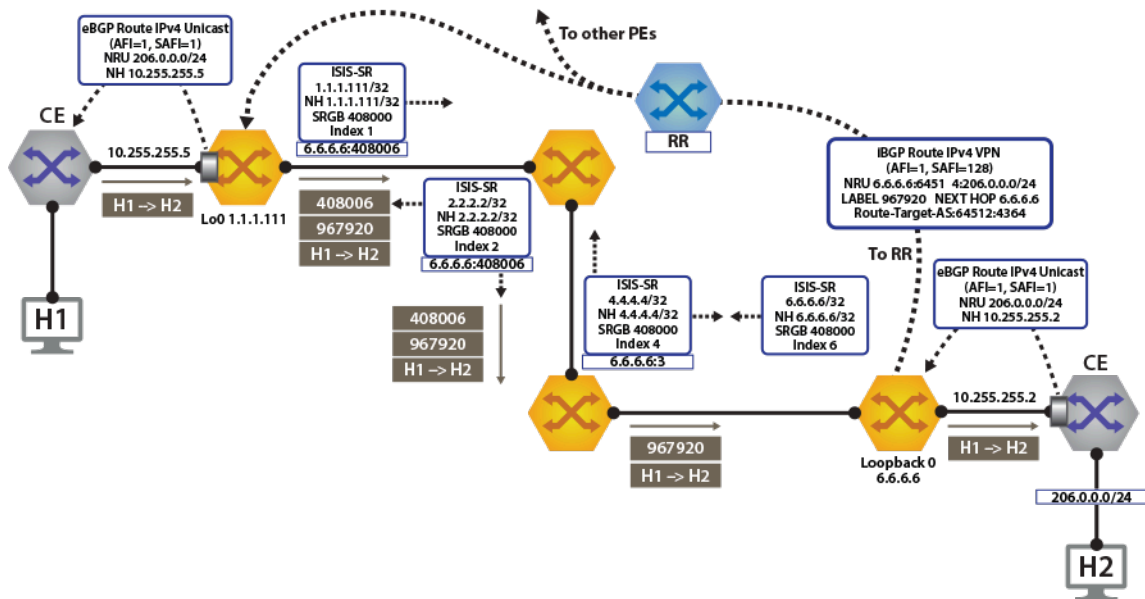

Figure 128: IPv4 VPN Forwarding Over ISIS-SR MPLS

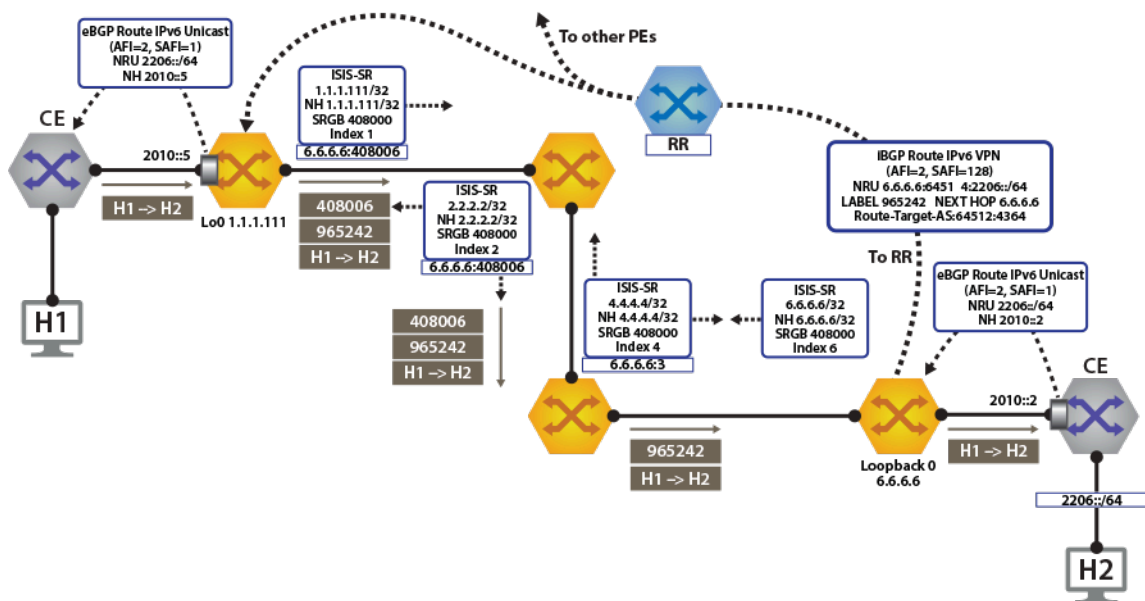

Figure 129: IPv6 VPN Forwarding Over ISIS-SR MPLS

View IPv4 and IPv6 Routes in the VRF

Both North Edge and South Edge routers have an eBGP peering session out to the CE; and learning routes from CE and remote PE.

- The `show ip route vrf tenant-d` command displays IPv4 Routes in the VRF of North Edge.

```
north-edge#show ip route vrf tenant-d

VRF: tenant-d
Codes: C - connected, S - static, K - kernel,
O - OSPF, IA - OSPF inter area, E1 - OSPF external type 1,
E2 - OSPF external type 2, N1 - OSPF NSSA external type 1,
```

```
N2 - OSPF NSSA external type2, B I - iBGP, B E - eBGP,
R - RIP, I L1 - IS-IS level 1, I L2 - IS-IS level 2,
O3 - OSPFv3, A B - BGP Aggregate, A O - OSPF Summary,
NG - Nexthop Group Static Route, V - VXLAN Control Service,
DH - DHCP client installed default route, M - Martian,
DP - Dynamic Policy Route
```

Gateway of last resort is not set

```
B I 10.255.255.0/30 [200/0] via 6.6.6.6/32, IS-IS SR tunnel index
6, label 967920
via 192.168.58.12, Ethernet1/1,
label 408006
C 10.255.255.4/30 is directly connected, Ethernet6/1.120
B E 201.0.0.0/24 [200/0] via 10.255.255.6, Ethernet6/1.120
B I 206.0.0.0/24 [200/0] via 6.6.6.6/32, IS-IS SR tunnel index 6,
label 967920
via 192.168.58.12, Ethernet1/1, label
408006
```

- The **show ip route vrf tenant-d** command displays IPv4 Routes in the VRF of South Edge.

```
south-edge#show ip route vrf tenant-d
```

VRF: tenant-d

```
Codes: C - connected, S - static, K - kernel,
O - OSPF, IA - OSPF inter area, E1 - OSPF external type 1,
E2 - OSPF external type 2, N1 - OSPF NSSA external type 1,
N2 - OSPF NSSA external type2, B I - iBGP, B E - eBGP,
R - RIP, I L1 - IS-IS level 1, I L2 - IS-IS level 2,
O3 - OSPFv3, A B - BGP Aggregate, A O - OSPF Summary,
NG - Nexthop Group Static Route, V - VXLAN Control Service,
DH - DHCP client installed default route, M - Martian,
DP - Dynamic Policy Route
```

Gateway of last resort is not set

```
C 10.255.255.0/30 is directly connected, Ethernet6/1.620
B I 10.255.255.4/30 [200/0] via 1.1.1.111/32, IS-IS SR tunnel index
5, label 951536
via 192.168.68.11, Ethernet2/1,
label 408001
B I 201.0.0.0/24 [200/0] via 1.1.1.111/32, IS-IS SR tunnel index 5,
label 951536
via 192.168.68.11, Ethernet2/1, label
408001
B E 206.0.0.0/24 [200/0] via 10.255.255.2, Ethernet6/1.620
```

- The **show ipv6 route vrf tenant-d** command displays IPv6 Routes in the VRF of North Edge.

```
north-edge#show ipv6 route vrf tenant-d
```

VRF: tenant-d

Displaying 4 of 7 IPv6 routing table entries

```
Codes: C - connected, S - static, K - kernel, O3 - OSPFv3, B - BGP, R -
RIP, A B - BGP Aggregate, I L1 -
IS-IS level 1, I L2 - IS-IS level 2, DH - DHCP, NG - Nexthop Group
Static Route, M - Martian, DP - Dynamic
Policy Route
```

```
B 2010::/126 [200/0]
via 6.6.6.6/32, IS-IS SR tunnel index 6, label 965242
via 192.168.58.12, Ethernet1/1, label 408006
```

```

C    2010::4/126 [0/0]
     via Ethernet6/1.120, directly connected
B    2201::/64 [200/0]
     via 2010::6, Ethernet6/1.120
B    2206::/64 [200/0]
     via 6.6.6.6/32, IS-IS SR tunnel index 6, label 965242
     via 192.168.58.12, Ethernet1/1, label 408006

```

- The `show ipv6 route vrf tenant-d` command displays IPv6 Routes in the VRF of South Edge.

```

south-edge#show ipv6 route vrf tenant-d

VRF: tenant-d
Displaying 4 of 7 IPv6 routing table entries
Codes: C - connected, S - static, K - kernel, O3 - OSPFv3, B - BGP, R -
RIP, A B - BGP Aggregate, I L1 -
IS-IS level 1, I L2 - IS-IS level 2, DH - DHCP, NG - Nexthop Group
Static Route, M - Martian, DP - Dynamic
Policy Route

C    2010::/126 [0/0]
     via Ethernet6/1.620, directly connected
B    2010::4/126 [200/0]
     via 1.1.1.111/32, IS-IS SR tunnel index 5, label 948858
     via 192.168.68.11, Ethernet2/1, label 408001
B    2201::/64 [200/0]
     via 1.1.1.111/32, IS-IS SR tunnel index 5, label 948858
     via 192.168.68.11, Ethernet2/1, label 408001
B    2206::/64 [200/0]
     via 2010::2, Ethernet6/1.620

```

Activating IP VPN

In all scenarios, the IP VPN must be activated under BGP and neighbors configured to exchange the IP VPN NLRI's. The tenant's VRF (tenant-d) is associated with a dynamically assigned label by BGP.

North Edge

```

service routing protocols model multi-agent

router bgp 64512
  router-id 1.1.1.111
  maximum-paths 128 ecmp 128
  neighbor 2.2.2.222 remote-as 64512
  neighbor 2.2.2.222 update-source Loopback0
  neighbor 2.2.2.222 fall-over bfd
  neighbor 2.2.2.222 send-community extended
  neighbor 2.2.2.222 maximum-routes 12000
  !
  address-family vpn-ipv4
    neighbor 2.2.2.222 activate
    neighbor default encapsulation mpls next-hop-self source-interface
Loopback0
  !
  address-family vpn-ipv6
    neighbor 2.2.2.222 activate
    neighbor default encapsulation mpls next-hop-self source-interface
Loopback0
  !

```

South Edge

```
service routing protocols model multi-agent

router bgp 64512
  router-id 6.6.6.6
  maximum-paths 128 ecmp 128
  neighbor 2.2.2.222 remote-as 64512
  neighbor 2.2.2.222 update-source Loopback0
  neighbor 2.2.2.222 fall-over bfd
  neighbor 2.2.2.222 send-community extended
  neighbor 2.2.2.222 maximum-routes 12000
  !
  address-family vpn-ipv4
    neighbor 2.2.2.222 activate
    neighbor default encapsulation mpls next-hop-self source-interface
Loopback0
  !
  address-family vpn-ipv6
    neighbor 2.2.2.222 activate
    neighbor default encapsulation mpls next-hop-self source-interface
Loopback0
  !
```

The configuration above provides the following:

- It enables the multi-agent routing protocol model, which is required for BGP VPN support.
- It sets the local autonomous system number to 64512 and configured the route-reflector for both IPv4 VPN and IPv6 VPN capabilities.
- It sets the IP VPN encapsulation type to MPLS (default).
- It specifies that Loopback0 will be used as the next-hop for all advertised VPN routes. The underlay configuration must provide MPLS LSPs from remote PEs to this loopback interface address.

Layer 3 Overlay Configuration

Distribution of Layer 3 routes over BGP is enabled by configuring one or more IP VRFs under the router bgp configuration mode. Additionally, either IPv4 or IPv6 routing must be enabled in the VRF.

- Configure IP VRF in the North Edge router.

```
vrf instance tenant-d
ip routing vrf tenant-d
ipv6 unicast-routing vrf tenant-d
!
router bgp 64512
  vrf tenant-d
    rd 1.1.1.1:64514
    route-target import vpn-ipv4 64512:4364
    route-target import vpn-ipv6 64512:4364
    route-target export vpn-ipv4 64512:4364
    route-target export vpn-ipv6 64512:4364
    neighbor 10.255.255.6 remote-as 65011
    neighbor 10.255.255.6 maximum-routes 12000
    neighbor 2010::6 remote-as 65011
    neighbor 2010::6 maximum-routes 12000
  !
  address-family ipv6
    neighbor 2010::6 activate
    redistribute connected
  !
```

- Configure IP VRF in the South Edge router.

```
vrf instance tenant-d
ip routing vrf tenant-d
ipv6 unicast-routing vrf tenant-d
!
router bgp 64512
  vrf tenant-d
    rd 6.6.6.6:64514
    route-target import vpn-ipv4 64512:4364
    route-target import vpn-ipv6 64512:4364
    route-target export vpn-ipv4 64512:4364
    route-target export vpn-ipv6 64512:4364
    neighbor 10.255.255.2 remote-as 65010
    neighbor 10.255.255.2 maximum-routes 12000
    neighbor 2010::2 remote-as 65010
    neighbor 2010::2 maximum-routes 12000
  !
  address-family ipv6
    neighbor 2010::2 activate
  redistribute connected
  !
```

These IP VRF configurations provide the following functionalities:

- It defines overlay VRFs (tenant-d) on the PE and enables IP unicast routing.
- The VRF is assigned a unique Route-Distinguisher (RD). The RD allows the PE to advertise VPN routes for the same IP prefix that have been exported by different VRFs. The NLRI RouteKey of a route exported from the VRFs IPv4 table into VPN consists of both the RD and the original IP prefix.
- The Route-Target (RT) extended communities for the VRF. The RTs are associated with all routes exported from the VRF. Received VPN routes carrying at least one RT matching the VRFs configuration are imported into the VRF.

Verifying IP VPNs over ISIS-SR

- The **show bgp vpn-ipv4 summary** command displays the status of the VPN IP peers in the North Edge router with the BGP VPN enabled.

```
north-edge#show bgp vpn-ipv4 summary
BGP summary information for VRF default
Router identifier 1.1.1.111, local AS number 64512
Neighbor Status Codes: m - Under maintenance
Neighbor      V  AS      MsgRcvd  MsgSent  InQ  OutQ  Up/Down
State
PfxRcd PfxAcc
 2.2.2.222    4  64512    172      45      0    0 00:17:16
  Estab 2      2
north-edge# sh bgp vpn-ipv6 summary
BGP summary information for VRF default
Router identifier 1.1.1.111, local AS number 64512
Neighbor Status Codes: m - Under maintenance
Neighbor      V  AS      MsgRcvd  MsgSent  InQ  OutQ  Up/Down
State
PfxRcd PfxAcc
 2.2.2.222    4  64512    172      45      0    0 00:17:20
  Estab 2      2
```

- The **show bgp vpn-ipv4** command displays routes sent and received through IP VPN.

```
north-edge#show bgp vpn-ipv4
BGP routing table information for VRF default
Router identifier 1.1.1.111, local AS number 64512
```

Route status codes: s - suppressed, * - valid, > - active, # - not installed, E - ECMP head, e - ECMP
 S - Stale, c - Contributing to ECMP, b - backup
 % - Pending BGP convergence
 Origin codes: i - IGP, e - EGP, ? - incomplete
 AS Path Attributes: Or-ID - Originator ID, C-LST - Cluster List, LL
 Nexthop - Link Local Nexthop

Path	Network	Next Hop	Metric	LocPref	Weight
* >	RD: 6.6.6.6:64514	IPv4 prefix 10.255.255.0/30			
		6.6.6.6	-	100	0
65010 i	Or-ID: 6.6.6.6	C-LST: 2.2.2.222			
* >	RD: 1.1.1.1:64514	IPv4 prefix 10.255.255.4/30			
		-	-	100	0
65011 i					
* >	RD: 1.1.1.1:64514	IPv4 prefix 201.0.0.0/24			
		-	-	100	0
65011 i					
* >	RD: 6.6.6.6:64514	IPv4 prefix 206.0.0.0/24			
		6.6.6.6	-	100	0
65010 i	Or-ID: 6.6.6.6	C-LST: 2.2.2.222			

north-edge#**show bgp vpn-ipv6**
 BGP routing table information for VRF default
 Router identifier 1.1.1.111, local AS number 64512
 Route status codes: s - suppressed, * - valid, > - active, # - not installed, E - ECMP head, e - ECMP
 S - Stale, c - Contributing to ECMP, b - backup
 % - Pending BGP convergence
 Origin codes: i - IGP, e - EGP, ? - incomplete
 AS Path Attributes: Or-ID - Originator ID, C-LST - Cluster List, LL
 Nexthop - Link Local Nexthop

Path	Network	Next Hop	Metric	LocPref	Weight
* >	RD: 6.6.6.6:64514	IPv6 prefix 2010::/126			
		6.6.6.6	-	100	0
65010 i	Or-ID: 6.6.6.6	C-LST: 2.2.2.222			
* >	RD: 1.1.1.1:64514	IPv6 prefix 2010::4/126			
		-	-	100	0
65011 i					
* >	RD: 1.1.1.1:64514	IPv6 prefix 2201::/64			
		-	-	100	0
65011 i					
* >	RD: 6.6.6.6:64514	IPv6 prefix 2206::/64			
		6.6.6.6	-	100	0
65010 i	Or-ID: 6.6.6.6	C-LST: 2.2.2.222			

 **Note:** Each entry in the table represents a BGP path. The path specific information includes the Route-Distinguisher and the IP prefix. Paths are either received from VPN peers or exported from local VRFs.

- The **show bgp vpn-ipv4 206.0.0.0/24 detail** and **show bgp vpn-ipv6 2206::/64 detail** commands display detailed view of the IP prefix route for 206.0.0.0/24 and 2206::/64 of the North Edge router.

```
north-edge#show bgp vpn-ipv4 206.0.0.0/24 detail
BGP routing table information for VRF default
Router identifier 1.1.1.111, local AS number 64512
BGP routing table entry for IPv4 prefix 206.0.0.0/24, Route
Distinguisher: 6.6.6.6:64514
Paths: 1 available
```

```

65010
  6.6.6.6 from 2.2.2.222 (2.2.2.222)
    Origin IGP, metric -, localpref 100, weight 0, valid, internal,
  best
    Extended Community: Route-Target-AS:64512:4364
    MPLS label: 967920

north-edge#show bgp vpn-ipv6 2206::/64 detail
BGP routing table information for VRF default
Router identifier 1.1.1.111, local AS number 64512
BGP routing table entry for IPv6 prefix 2206::/64, Route Distinguisher:
6.6.6.6:64514
Paths: 1 available
  65010
    6.6.6.6 from 2.2.2.222 (2.2.2.222)
      Origin IGP, metric -, localpref 100, weight 0, valid, internal,
    best
      Extended Community: Route-Target-AS:64512:4364
      MPLS label: 965242

```

 **Note:** The output includes the RD and IP prefix identifying the route. As seen in the output, the IPv4 VPN route is received from 2.2.2.222 because it is set-up to be a route-reflector, but the next hop is 6.6.6.6. Both are advertised with tenant VPN label 967920 and 965242 and an RT.

- The `show ip bgp vrf tenant-d` command displays the BGP table for the VRF containing the imported EVPN routes.

```

north-edge#show ip bgp vrf tenant-d
BGP routing table information for VRF tenant-d
Router identifier 1.1.1.1, local AS number 64512
Route status codes: s - suppressed, * - valid, > - active, # - not
  installed, E - ECMP head, e - ECMP
                   S - Stale, c - Contributing to ECMP, b - backup, L
  - labeled-unicast
                   % - Pending BGP convergence
Origin codes: i - IGP, e - EGP, ? - incomplete
AS Path Attributes: Or-ID - Originator ID, C-LST - Cluster List, LL
  Nexthop - Link Local Nexthop

```

Path	Network	Next Hop	Metric	LocPref	Weight
* >Ec	10.255.255.0/30	6.6.6.6	-	100	0
65010 i	Or-ID: 6.6.6.6 C-LST: 2.2.2.222				
* ec	10.255.255.0/30	6.6.6.6	-	100	0
65010 i	Or-ID: 6.6.6.6 C-LST: 2.2.2.222				
* >	10.255.255.4/30	10.255.255.6	-	100	0
65011 i					
* >	201.0.0.0/24	10.255.255.6	-	100	0
65011 i					
* >Ec	206.0.0.0/24	6.6.6.6	-	100	0
65010 i	Or-ID: 6.6.6.6 C-LST: 2.2.2.222				
* ec	206.0.0.0/24	6.6.6.6	-	100	0
65010 i	Or-ID: 6.6.6.6 C-LST: 2.2.2.222				

 **Note:** Each entry in the table represent a BGP path that is either locally redistributed and received into the VRF or imported from the IPv4 VPN table. VPN routes are received from router 2.2.2.222 C-List (cluster list - basically identifying this route as from a route-reflector) with originating router being 6.6.6.6.

Finally, let us look at the routes in the VRF tenant-d.

```

VRF: tenant-d
Codes: C - connected, S - static, K - kernel,

```

O - OSPF, IA - OSPF inter area, E1 - OSPF external type 1,
 E2 - OSPF external type 2, N1 - OSPF NSSA external type 1,
 N2 - OSPF NSSA external type2, B I - iBGP, B E - eBGP,
 R - RIP, I L1 - IS-IS level 1, I L2 - IS-IS level 2,
 O3 - OSPFv3, A B - BGP Aggregate, A O - OSPF Summary,
 NG - Nexthop Group Static Route, V - VXLAN Control Service,
 DH - DHCP client installed default route, M - Martian,
 DP - Dynamic Policy Route

Gateway of last resort is not set

```

B I    10.255.255.0/30 [200/0] via 6.6.6.6/32, IS-IS SR tunnel index 6,
label 967920
                                     via 192.168.58.12, Ethernet1/1, label
408006
C      10.255.255.4/30 is directly connected, Ethernet6/1.120
B E    201.0.0.0/24 [200/0] via 10.255.255.6, Ethernet6/1.120
B I    206.0.0.0/24 [200/0] via 6.6.6.6/32, IS-IS SR tunnel index 6,
label 967920
                                     via 192.168.58.12, Ethernet1/1, label
408006
  
```

 **Note:** As displayed in the highlighted route above the label stack, the route is the transport label 408006 on top (this is the label to reach NH 6.6.6.6), with the tenant-a VPN label 967920 next in the stack, identifying the route as belonging to tenant-d.

A check of the Tunnel FIB confirms that 408006 is the ISIS-SR LSP.

```

north-edge#show mpls tunnel fib
! 'show mpls tunnel fib' has been deprecated. Please use 'show tunnel fib
[options]' moving forward.

```

Tunnel Type Interface	Index Labels	Endpoint Forwarding	Nexthop
IS-IS SR IPv4	9	2.2.2.22/32	192.168.58.12
Ethernet1/1	[3]	None	
LDP	4	2.2.2.200/32	192.168.58.12
Ethernet1/1	[3]	None	
IS-IS SR IPv4	2	2.2.2.222/32	192.168.58.12
Ethernet1/1	[3]	None	
IS-IS SR IPv4	4	3.3.3.3/32	192.168.58.12
Ethernet1/1	[408003]	None	
BGP LU	5	3.3.3.33/32	192.168.58.12
Ethernet1/1	[200033]	None	
LDP	5	3.3.3.200/32	192.168.58.12
Ethernet1/1	[904099]	None	
IS-IS SR IPv4	8	4.4.4.4/32	192.168.58.12
Ethernet1/1	[408004]	None	
IS-IS SR IPv4	5	4.4.4.44/32	192.168.58.12
Ethernet1/1	[408044]	None	
LDP	2	4.4.4.200/32	192.168.58.12
Ethernet1/1	[904098]	None	
IS-IS SR IPv4	3	5.5.5.5/32	192.168.58.12
Ethernet1/1	[408005]	Primary	
BGP LU	7	5.5.5.55/32	192.168.58.12
Ethernet1/1	[200055]	None	
LDP	3	5.5.5.200/32	192.168.58.12
Ethernet1/1	[904100]	None	
IS-IS SR IPv4	6	6.6.6.6/32	192.168.58.12
Ethernet1/1	[408006]	Primary	
BGP LU	8	6.6.6.66/32	192.168.58.12
Ethernet1/1	[200066]	None	

LDP	1	6.6.6.200/32	192.168.58.12
Ethernet1/1	[904097]	None	
IS-IS SR IPv4	1	23.1.1.11/32	192.168.1.154
Ethernet36/1	[3]	Primary	
IS-IS SR IPv4	7	23.1.1.33/32	192.168.1.174
Ethernet23/1	[3]	Primary	

17.12.5.2 IP VPNs Over LDP

The following figures illustrate an overview of the combined control and data planes.

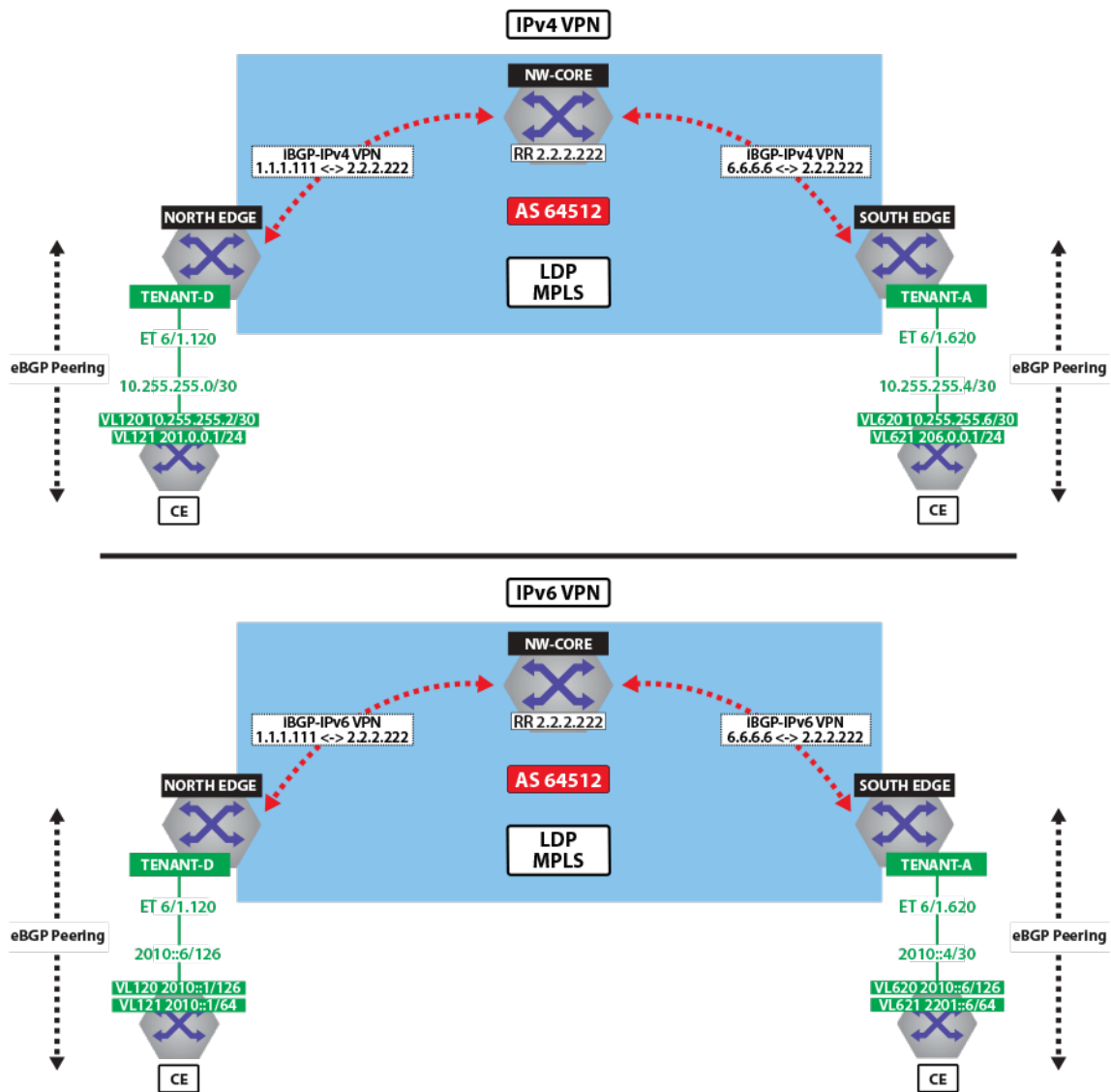

Figure 130: IPv4 VPN and IPv6 VPN Over LDP MPLS

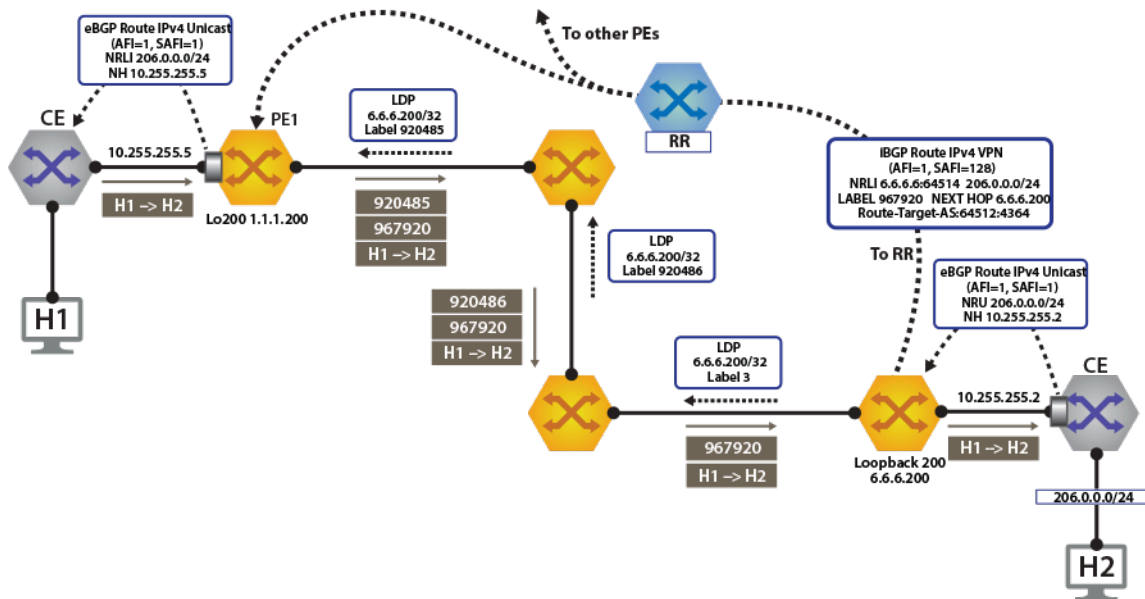

Figure 131: IPv4 VPN Forwarding Over LDP MPLS

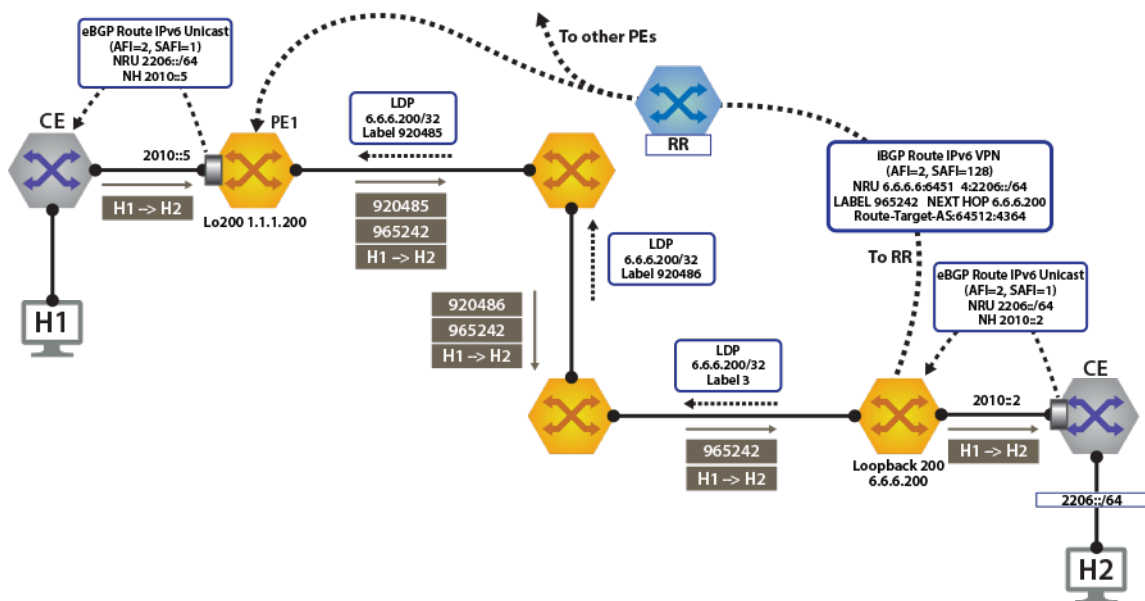

Figure 132: IPv6 VPN Forwarding Over LDP MPLS

To switch to using the MPLS LDP transport, we just need to change the next-hop we advertised for the VPN routes. As shown above, the next hop needs to be set to loopback 200 for using the LDP LSP.

This is achieved by configuring the next-hop for the EVPN routes on both north and south edge routers.

```
router bgp 64512
!
 address-family evpn
  neighbor default encapsulation mpls next-hop-self source-interface
  Loopback200
```

Once this is configured, we can check the BGP updates and the routes in the VRF. The output again includes the RD and IP prefix identifying the route. We now have the NH set to 6.6.6.200 for tenant-d.

```
north-edge#show bgp vpn-ipv4 206.0.0.0/24 detail
BGP routing table information for VRF default
Router identifier 1.1.1.111, local AS number 64512
BGP routing table entry for IPv4 prefix 206.0.0.0/24, Route Distinguisher
: 6.6.6.6:64514
  Paths: 1 available
    65010
      6.6.6.200 from 2.2.2.222 (2.2.2.222)
        Origin IGP, metric -, localpref 100, weight 0, valid, internal,
        best
        Extended Community: Route-Target-AS:64512:4364
        MPLS label: 967920
north-edge#

north-edge#show bgp vpn-ipv6 2206::/64 detail
BGP routing table information for VRF default
Router identifier 1.1.1.111, local AS number 64512
BGP routing table entry for IPv6 prefix 2206::/64, Route Distinguisher:
6.6.6.6:64514
  Paths: 1 available
    65010
      6.6.6.200 from 2.2.2.222 (2.2.2.222)
        Origin IGP, metric -, localpref 100, weight 0, valid, internal,
        best
        Extended Community: Route-Target-AS:64512:4364
        MPLS label: 965242
north-edge#
```



Note: The VPN label has not changed from the ISIS-SR case above (967920 & 965242), reinforcing the fact that the BGP VPN label is orthogonal to the transport label.

```
north-edge#show ip route vrf tenant-d

VRF: tenant-d
Codes: C - connected, S - static, K - kernel,
       O - OSPF, IA - OSPF inter area, E1 - OSPF external type 1,
       E2 - OSPF external type 2, N1 - OSPF NSSA external type 1,
       N2 - OSPF NSSA external type2, B I - iBGP, B E - eBGP,
       R - RIP, I L1 - IS-IS level 1, I L2 - IS-IS level 2,
       O3 - OSPFv3, A B - BGP Aggregate, A O - OSPF Summary,
       NG - Nexthop Group Static Route, V - VXLAN Control Service,
       DH - DHCP client installed default route, M - Martian,
       DP - Dynamic Policy Route

Gateway of last resort is not set

B I    10.255.255.0/30 [200/0] via 6.6.6.200/32, LDP tunnel index 1,
label 967920
                                             via 192.168.58.12, Ethernet1/1, label
904097
C      10.255.255.4/30 is directly connected, Ethernet6/1.120
B E    201.0.0.0/24 [200/0] via 10.255.255.6, Ethernet6/1.120
B I    206.0.0.0/24 [200/0] via 6.6.6.200/32, LDP tunnel index 1, label
967920
                                             via 192.168.58.12, Ethernet1/1, label
904097

north-edge(config-router-bgp)#show ipv6 route vrf tenant-d
```

```

VRF: tenant-d
Displaying 4 of 7 IPv6 routing table entries
Codes: C - connected, S - static, K - kernel, O3 - OSPFv3, B - BGP, R -
RIP, A B - BGP Aggregate, I L1 - IS-IS level 1, I L2 - IS-IS level 2,
DH - DHCP, NG - Nexthop Group Static Route, M - Martian, DP - Dynamic
Policy Route

B    2010::/126 [200/0]
     via 6.6.6.6/32, IS-IS SR tunnel index 6, label 965242
     via 192.168.58.12, Ethernet1/1, label 408006
C    2010::4/126 [0/0]
     via Ethernet6/1.120, directly connected
B    2201::/64 [200/0]
     via 2010::6, Ethernet6/1.120
B    2206::/64 [200/0]
     via 6.6.6.6/32, IS-IS SR tunnel index 6, label 965242
     via 192.168.58.12, Ethernet1/1, label 408006

```

 **Note:** As seen from the highlighted route above the label stack, the route are the transport label 904097 on top (this is the label path to reach NH 6.6.6.200), with the tenant-d VPN label 967920 next in the stack, and identifying the route as belonging to tenant-a.

A capture of the dataplane on North-Edge matching on the LDP transport label confirms the encapsulated traffic on the wire. 904097:976920:[Source IP Address][Destination IP Address].

17.12.5.3 IP VPNs Over BGP-SR

The following figures illustrate an overview of the combined control and data planes.

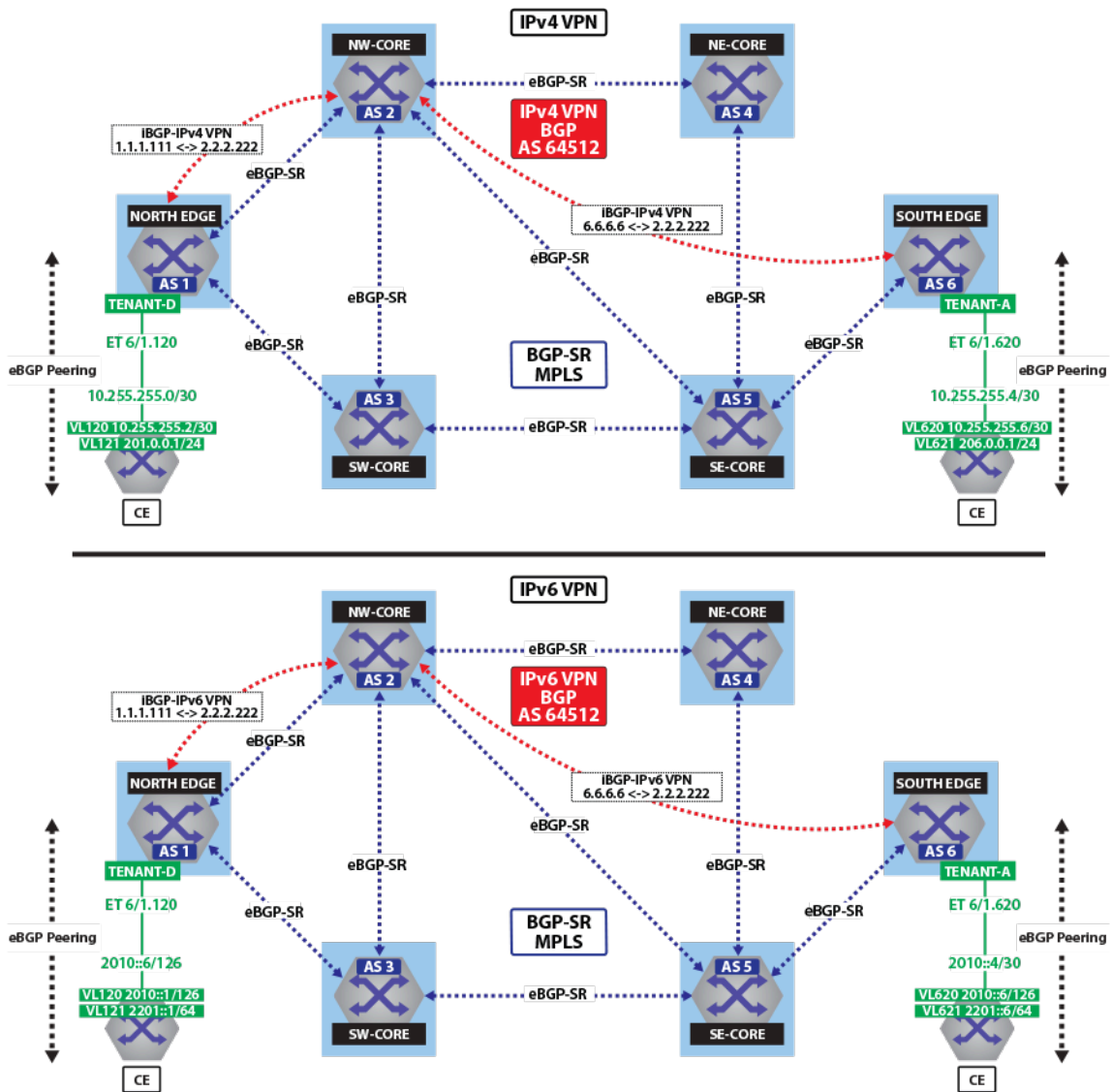

Figure 133: IPv4 VPN and IPv6 VPN Over BGP-SR MPLS

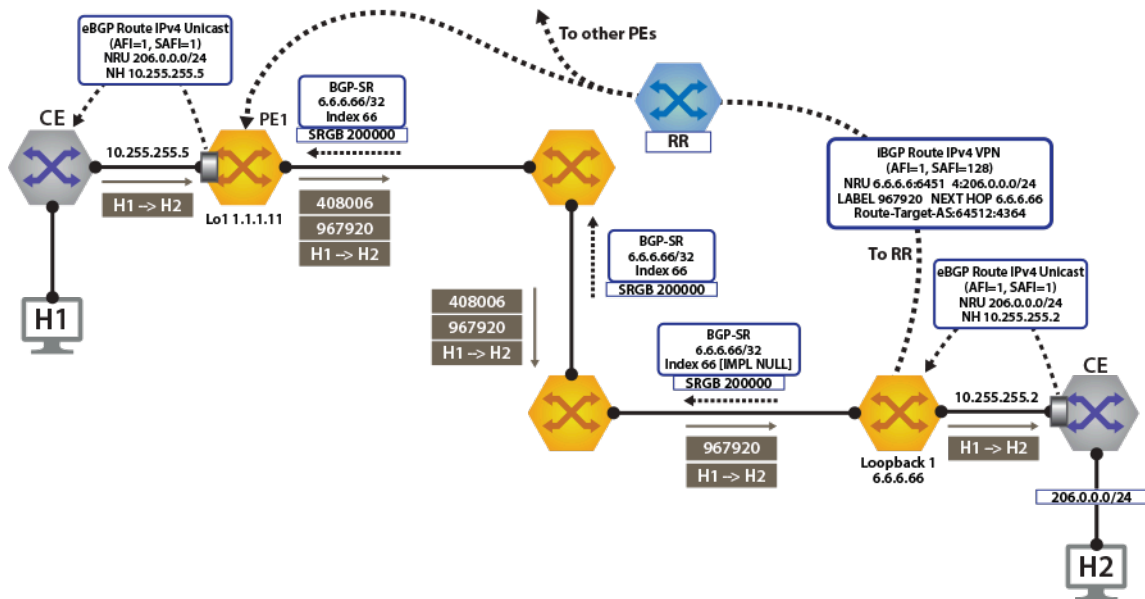

Figure 134: IPv4 VPN Forwarding Over BGP-SR MPLS

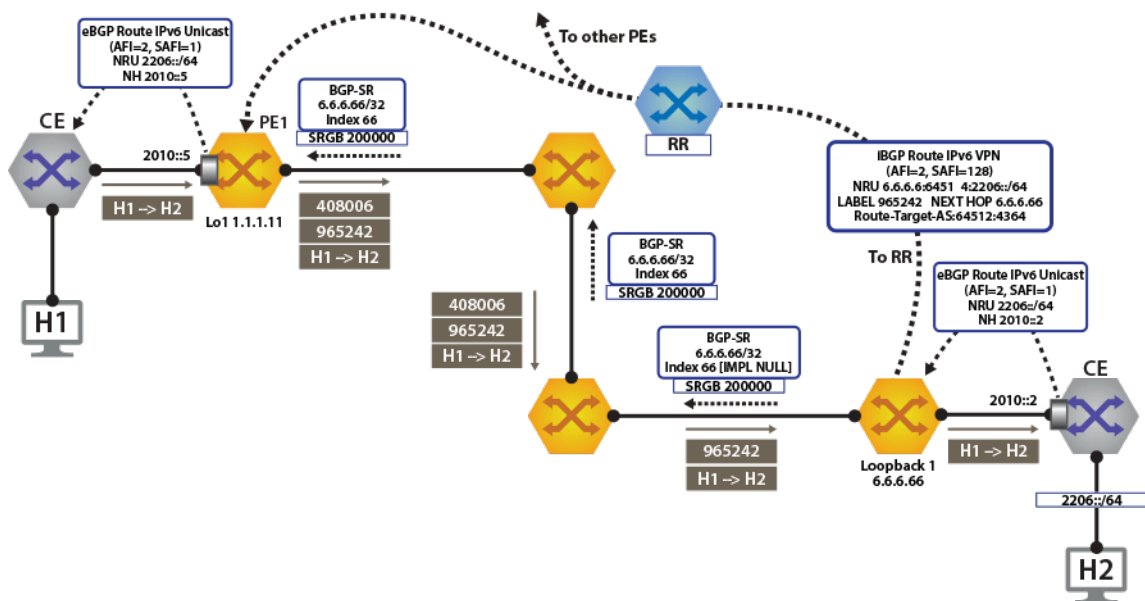

Figure 135: IPv6 VPN Forwarding Over BGP-SR MPLS

To switch to using the MPLS BGP-SR transport, we just need to change the next-hop we advertised for the VPN routes. As shown above, the next hop needs to be set to loopback 1 for using the BGP-SR LSP.

This is achieved by configuring the next-hop for EVPN routes.

```
router bgp 64512
!
 address-family evpn
  neighbor default encapsulation mpls next-hop-self source-interface
  Loopback1
```

Once this is configured, we can check the BGP updates and the routes in the VRF. The output again includes the RD and IP prefix identifying the route. As seen in the output, we now have the NH set to 6.6.6.66 for tenant-d.

```
north-edge#show bgp vpn-ipv4 206.0.0.0/24 detail
BGP routing table information for VRF default
Router identifier 1.1.1.111, local AS number 64512
BGP routing table entry for IPv4 prefix 206.0.0.0/24, Route Distinguisher: 6.6.6.6:64514
  Paths: 1 available
    65010
      6.6.6.66 from 2.2.2.222 (2.2.2.222)
        Origin IGP, metric -, localpref 100, weight 0, valid, internal, best
        Extended Community: Route-Target-AS:64512:4364
        MPLS label: 967920
north-edge#
north-edge#show bgp vpn-ipv6 2206::/64 detail
BGP routing table information for VRF default
Router identifier 1.1.1.111, local AS number 64512
BGP routing table entry for IPv6 prefix 2206::/64, Route Distinguisher: 6.6.6.6:64514
  Paths: 1 available
    65010
      6.6.6.66 from 2.2.2.222 (2.2.2.222)
        Origin IGP, metric -, localpref 100, weight 0, valid, internal, best
        Extended Community: Route-Target-AS:64512:4364
        MPLS label: 965242
north-edge#
```

 **Note:** The VPN label has not changed from the ISIS-SR case above (967920 & 965242), reinforcing the fact that the BGP VPN label is orthogonal to the transport label.

The output again includes the RD and IP prefix identifying the route. As seen in the output, we now have the NH set to 6.6.6.66 for tenant-d.

```
north-edge#show bgp vpn-ipv4 206.0.0.0/24 detail
BGP routing table information for VRF default
Router identifier 1.1.1.111, local AS number 64512
BGP routing table entry for IPv4 prefix 206.0.0.0/24, Route Distinguisher: 6.6.6.6:64514
  Paths: 1 available
    65010
      6.6.6.66 from 2.2.2.222 (2.2.2.222)
        Origin IGP, metric -, localpref 100, weight 0, valid, internal, best
        Extended Community: Route-Target-AS:64512:4364
        MPLS label: 967920
north-edge#
north-edge#show bgp vpn-ipv6 2206::/64 detail
BGP routing table information for VRF default
Router identifier 1.1.1.111, local AS number 64512
BGP routing table entry for IPv6 prefix 2206::/64, Route Distinguisher: 6.6.6.6:64514
  Paths: 1 available
    65010
      6.6.6.66 from 2.2.2.222 (2.2.2.222)
        Origin IGP, metric -, localpref 100, weight 0, valid, internal, best
        Extended Community: Route-Target-AS:64512:4364
        MPLS label: 965242
north-edge#
```

 **Note:** The VPN label has not changed from the ISIS-SR case above (967920 & 965242), reinforcing the fact that the BGP VPN label is orthogonal to the transport label.

As displayed in the highlighted route above the label stack, the route are the transport label 200066 on top (this is the label path to reach NH 6.6.6.66), with the tenant-d VPN label 967920 next in the stack, and identifying the route as belonging to tenant-a.

```
north-edge#show ip route vrf tenant-d

VRF: tenant-d
Codes: C - connected, S - static, K - kernel,
        O - OSPF, IA - OSPF inter area, E1 - OSPF external type 1,
        E2 - OSPF external type 2, N1 - OSPF NSSA external type 1,
        N2 - OSPF NSSA external type2, B I - iBGP, B E - eBGP,
        R - RIP, I L1 - IS-IS level 1, I L2 - IS-IS level 2,
        O3 - OSPFv3, A B - BGP Aggregate, A O - OSPF Summary,
        NG - Nexthop Group Static Route, V - VXLAN Control Service,
```

```

DH - DHCP client installed default route, M - Martian,
DP - Dynamic Policy Route

Gateway of last resort is not set

B I   10.255.255.0/30 [200/0] via 6.6.6.66/32, BGP LU tunnel index 8, label 967920
      via 192.168.58.12, Ethernet1/1, label 200066
      via 192.168.59.12, Ethernet2/1, label 200066
C     10.255.255.4/30 is directly connected, Ethernet6/1.120
B E   201.0.0.0/24 [200/0] via 10.255.255.6, Ethernet6/1.120
B I   206.0.0.0/24 [200/0] via 6.6.6.66/32, BGP LU tunnel index 8, label 967920
      via 192.168.58.12, Ethernet1/1, label 200066
      via 192.168.59.12, Ethernet2/1, label 200066

north-edge(config-router-bgp)#show ipv6 route vrf tenant-d

VRF: tenant-d
Displaying 4 of 7 IPv6 routing table entries
Codes: C - connected, S - static, K - kernel, O3 - OSPFv3, B - BGP, R - RIP, A B - BGP
Aggregate, I L1 -
IS-IS level 1, I L2 - IS-IS level 2, DH - DHCP, NG - Nexthop Group Static Route, M -
Martian, DP - Dynamic
Policy Route

B     2010::/126 [200/0]
      via 6.6.6.66/32, BGP LU tunnel index 8, label 965242
      via 192.168.58.12, Ethernet1/1, label 200066
      via 192.168.59.12, Ethernet2/1, label 200066
C     2010::4/126 [0/0]
      via Ethernet6/1.120, directly connected
B     2201::/64 [200/0]
      via 2010::6, Ethernet6/1.120
B     2206::/64 [200/0]
      via 6.6.6.66/32, BGP LU tunnel index 8, label 965242
      via 192.168.58.12, Ethernet1/1, label 200066
      via 192.168.59.12, Ethernet2/1, label 200066

```

A capture of the data-plane on North-Edge matching on the BGP-SR transport label confirms the encapsulated traffic on the wire. 200066:976920:[Source IP Address][Destination IP Address].

```

monitor session 1 source Ethernet1/1 tx
monitor session 1 destination Cpu

north-edge(config-router-bgp)# bash tcpdump -nei mirror0 -q -c 10 mpls 200066
tcpdump: verbose output suppressed, use -v or -vv for full protocol decode
listening on mirror0, link-type EN10MB (Ethernet), capture size 262144 bytes
16:37:15.074916 28:99:3a:4d:3e:f1 > 28:99:3a:4d:3a:f3, MPLS unicast, length 122: MPLS (label
200066, exp 0,
ttl 63) (label 967920, exp 0, [S], ttl 63) 10.255.255.6 > 206.0.0.1: ICMP echo request, id
22573, seq 1,
length 80

16:37:15.075088 28:99:3a:4d:3e:f1 > 28:99:3a:4d:3a:f3, MPLS unicast, length 122: MPLS (label
200066, exp 0,
ttl 63) (label 967920, exp 0, [S], ttl 63) 10.255.255.6 > 206.0.0.1: ICMP echo request, id
22573, seq 2, length 80

```

17.13 EVPN and VCS Commands

Router BGP Configuration Mode

- `next-hop resolution disabled`
- `redistribute service vxlan`
- `router general`
- `route-target`
- `route-target export`
- `route-target import`
- `route-target route-map`
- `vlan (VLAN-AWARE-Bundle configuration mode)`
- `vni-aware-bundle`

VCS Commands

- `redistribute bgp evpn vxlan`

EVPN VXLAN Command

- `bfd vtep evpn`

Display Commands

- `show bgp evpn`
- `show ip bgp vrf`
- `show ip route vrf`
- `show ipv6 bgp vrf`
- `show ipv6 route vrf`
- `show l2rib input all`
- `show l2Rib input vxlan-control-service`
- `show l2rib output`
- `show service vxlan address-table`
- `show vrf leak flapping`
- `show vxlan control-plane`

17.13.1 bfd vtep evpn

The `bfd vtep evpn` command to configure the BGP PIC Edge for EVPN VXLAN routes for remote VTEPs. This command is configured under the VXLAN Tunnel Interface (VTI).

The `no bfd vtep evpn` command removes bfd vtep evpn configuration from the `running-config`.

Command Mode

VXLAN Tunnel Interface (VTI) Mode

Command Syntax

`bfd vtep evpn interval interval-milliseconds min-rx min-rx-milliseconds multiplier multiplier-range`

`no bfd vtep evpn interval interval-milliseconds min-rx min-rx-milliseconds multiplier multiplier-range`

Parameters

- `interval` Set transmit rate in milliseconds.
- `interval-milliseconds` Rate in milliseconds. Value ranges from 50 to 60000 milliseconds.
- `min-rx` Set expected minimum incoming rate in milliseconds.
- `min-rx-milliseconds` Rate in milliseconds. Value ranges from 50 to 60000 milliseconds.
- `multiplier` Sets the BFD multiplier.
- `multiplier-range` The value ranges from 3 to 50.

Example

- In this example (assuming symmetric configuration on other PE devices) any BFD for VXLAN session initiated on the VTI would have a detect time of 300ms (interval of 100ms multiplied by 3).

```
switch(config-if-Vx1)#bfd vtep evpn interval 100 min-rx 100 multiplier
3
```

17.13.2 next-hop resolution disabled

The `next-hop resolution disabled` command disables the next-hop resolution in routes received from BGP-EVPN peers.

The `no next-hop resolution disabled` and the `default next-hop resolution disabled` commands enable the next-hop resolution in routes received from BGP-EVPN peers.

Command Mode

Router-BGP Address-Family Configuration

Command Syntax

```
next-hop resolution disabled
```

Example

This command disables the next-hop resolution in routes received from BGP-EVPN peers.

```
cvx(config) #router bgp 65002  
cvx(config-router-bgp) #address-family evpn  
cvx(config-router-bgp-af) #next-hop resolution disabled  
cvx(config-router-bgp-af) #
```

17.13.3 redistribute bgp evpn vxlan

The **redistribute bgp evpn vxlan** command enables BGP-EVPN routes to be redistributed to VCS which in turn advertises them to all VTEPs within the DC.

The **no redistribute bgp evpn vxlan** and the default **redistribute bgp evpn vxlan** commands disable the redistribution of BGP-EVPN routes to VCS.

Command Mode

CVX-VXLAN Configuration

Command Syntax

```
redistribute bgp evpn vxlan
```

Example

This command enables redistribution of BGP-EVPN routes to VCS.

```
cvx(config)#cvx  
cvx(config-cvx)#no shutdown  
cvx(config-cvx)#service vxlan  
cvx(config-cvx-vxlan)#no shutdown  
cvx(config-cvx-vxlan)#redistribute bgp evpn vxlan
```

17.13.4 redistribute service vxlan

The **redistribute service vxlan** command enables BGP to redistribute the Layer 2 bridging information received from VCS.

The **no redistribute service vxlan** and the **default redistribute service vxlan** commands disable the redistribution of the bridging information received from VCS.

Command Mode

Router-BGP VNI Configuration

Command Syntax

```
redistribute service vxlan
```

Example

This command enables redistribution of the Layer 2 bridging information received from VCS.

```
cvx(config) #router bgp 100  
cvx(config-router-bgp) #vni-aware-bundle bundle1  
cvx(config-macvrf-bundle1) #redistribute service vxlan
```

17.13.5 router general

The **router general** command configures a route-map to leak routes from one VRF to another VRF using a route-map named “RM1”.

The **no router general** and **default router general** commands disable the router general configuration from the running-config.

Command Mode

Router General Configuration

Command Syntax

```
router general
```

```
no router general
```

```
default router general
```

Examples

- These commands configure a route-map to leak routes from “VRF1” to “VRF2” using a route-map “RM1”.

```
switch(config)#router general
switch(config-router-general)#vrf VRF2
switch(config-router-general-vrf-VRF2)#leak routes source-vrf VRF1
subscribe-policy RM1
```

- These commands configure a route-map with the prefix 10.0.0.0/8 and the administrative distance to 10 in the destination VRF.

```
switch(config)#ip prefix-list PL1
switch(config-ip-pfx)#permit 10.0.0.0/8
switch(config)#ip route-map RM1
switch(config-route-map-RM1)#match ip address prefix-list PL1
switch(config-route-map-RM1)#set distance 10
```

17.13.6 route-target export

The **route-target export** command allows the user to export routes from a VRF to the local VPN table using the route target extended community list.

The **no route-target export** and **default route-target export** commands remove the routes from the VPN table.

Command Mode

Router-BGP VNI Configuration

Syntax

```
route-target export [evpn | vpn-ipv4 | vpn-ipv6] <RT>
```

```
no route-target export
```

```
default route-target export
```

Parameters

- *evpn* EVPN address family.
- *vpn-ipv4* MPLS L3 VPN IPv4 unicast address family.
- *vpn-ipv6* MPLS L3 VPN IPv6 unicast address family.
- *RT* route-target extended community.

Examples

- These commands export routes from vrf-red to the VPN table.

```
switch(config)#service routing protocols model multi-agent
switch(config)#mpls ip
switch(config)#router bgp 65001
switch(config-router-bgp)#vrf vrf-red
switch(config-router-bgp-vrf-vrf-red)#rd 1:1
switch(config-router-bgp-vrf-vrf-red)#route-target export vpn-ipv4
10:10
switch(config-router-bgp-vrf-vrf-red)#route-target export vpn-ipv6
10:20
```

- These commands export routes from vrf-red to the EVPN table.

```
switch(config)#router bgp 65001
switch(config-router-bgp)#vrf vrf-red
switch(config-router-bgp-vrf-vrf-red)#rd 1:1
switch(config-router-bgp-vrf-vrf-red)#route-target export evpn 10:1
```

17.13.7 route-target import

The `route-target import` command allows the user to import route target extended community lists from the local VPN table to the target VRF.

The `no route-target import` and `default route-target import` commands remove the routes from the VPN table.

Command Mode

Router-BGP VNI Configuration

Syntax

```
route-target import [evpn | vpn-ipv4 | vpn-ipv6] <RT>
```

```
no route-target import
```

```
default route-target import
```

Parameters

- `evpn` EVPN address family.
- `vpn-ipv4` MPLS L3 VPN IPv4 unicast address family.
- `vpn-ipv6` MPLS L3 VPN IPv6 unicast address family.
- `RT` route-target extended community.

Examples

- These commands import routes from the VPN table to `vrf-blue`.

```
switch(config)#service routing protocols model multi-agent
switch(config)#mpls ip
switch(config)#router bgp 65001
switch(config-router-bgp)#vrf vrf-blue
switch(config-router-bgp-vrf-vrf-blue)#rd 2:2
switch(config-router-bgp-vrf-vrf-blue)#route-target import vpn-ipv4
10:10
switch(config-router-bgp-vrf-vrf-blue)#route-target import vpn-ipv6
10:20
```

- These commands import routes from the EVPN table to `vrf-blue`.

```
switch(config)#router bgp 65001
switch(config-router-bgp)#vrf vrf-blue
switch(config-router-bgp-vrf-vrf-blue)#rd 2:2
switch(config-router-bgp-vrf-vrf-blue)#route-target import evpn 10:1
```

17.13.8 route-target route-map

The `route-target route-map` command allows the user to export and import route target extended community lists from one VRF to another using route maps.

The `no route-target route-map` and `default route-target route-map` commands remove the routes from the VPN table.

Command Mode

Router-BGP VNI Configuration

Syntax

```
route-target {import | export} [evpn | vpn-ipv4 | vpn-ipv6] route-map RM
```

```
no route-target route-map
```

```
default route-target route-map
```

Parameters

- `evpn` EVPN address family.
- `vpn-ipv4` MPLS L3 VPN IPv4 unicast address family.
- `vpn-ipv6` MPLS L3 VPN IPv6 unicast address family.
- `RM` route-map extended community.

Examples

- These commands export routes from `vrf-red` to the VPN table.

```
switch(config)#service routing protocols model multi-agent
switch(config)#mpls ip
switch(config)#router bgp 65001
switch(config-router-bgp)#vrf vrf-red
switch(config-router-bgp-vrf-vrf-red)#rd 1:1
switch(config-router-bgp-vrf-vrf-red)#route-target export vpn-ipv4
10:10
switch(config-router-bgp-vrf-vrf-red)#route-target export vpn-ipv6
10:20
switch(config-router-bgp-vrf-vrf-red)#route-target export vpn-ipv4
route-map EXPORT_V4_ROUTES_TO_VPN_TABLE
switch(config-router-bgp-vrf-vrf-red)#route-target export vpn-ipv6
route-map EXPORT_V6_ROUTES_TO_VPN_TABLE
```

- These commands export routes from `vrf-red` to the EVPN table.

```
switch(config)#router bgp 65001
switch(config-router-bgp)#vrf vrf-red
switch(config-router-bgp-vrf-vrf-red)#rd 1:1
switch(config-router-bgp-vrf-vrf-red)#route-target export evpn 10:1
switch(config-router-bgp-vrf-vrf-red)#route-target export evpn route-
map EXPORT_ROUTES_TO_EVPN_TABLE
```

- These commands import routes from the VPN table to `vrf-blue`.

```
switch(config)#service routing protocols model multi-agent
switch(config)#mpls ip
switch(config)#router bgp 65001
switch(config-router-bgp)#vrf vrf-blue
switch(config-router-bgp-vrf-vrf-blue)#rd 1:1
switch(config-router-bgp-vrf-vrf-blue)#route-target import vpn-ipv4
10:10
```

```
switch(config-router-bgp-vrf-vrf-blue)#route-target import vpn-ipv6
10:20
switch(config-router-bgp-vrf-vrf-blue)#route-target import vpn-ipv4
route-map IMPORT_V4_ROUTES_VPN_TABLE
switch(config-router-bgp-vrf-vrf-blue)#route-target import vpn-ipv6
route-map IMPORT_V6_ROUTES_VPN_TABLE
```

- These commands import routes from the EVPN table to *vrf-blue*.

```
switch(config)#router bgp 65001
switch(config-router-bgp)#vrf vrf-blue
switch(config-router-bgp-vrf-vrf-blue)#rd 2:2
switch(config-router-bgp-vrf-vrf-blue)#route-target import evpn 10:1
switch(config-router-bgp-vrf-vrf-blue)#route-target import evpn route-
map IMPORT_ROUTES_FROM_EVPN_TABLE
```

17.13.9 route-target

The **route-target** command configures a well-known extended community that is used by BGP-EVPN to export routes from or import routes into MAC-VRF.

The **no route-target** and **default route-target** commands delete the route-target configuration.

Command Mode

Router-BGP VNI Configuration

Syntax

```
route-target {export | import | both} rt
```

```
no route-target
```

```
default route-target
```

Parameters

- **export** configures a well-known extended community that is attached to the routes exported by BGP-EVPN.
- **import** configures a well known extended community that identifies the received routes that need to be imported into the MAC-VRF specified by the VNI bundle.
- **both** configures the same extended community for import and export of routes.
- **rt** route-target extended community.

Example

This command configures a well-known extended community for import and export of routes.

```
cvx(config)#router bgp 100  
cvx(config-router-bgp)#vni-aware-bundle bundle1  
cvx(config-macvrf-bundle1)#route-target both 503:12  
cvx(config-macvrf-bundle1)#
```

17.13.10 show bgp evpn

The `show bgp evpn` command displays information about the BGP-EVPN routes of the switch.

Command Mode

Global Configuration

Command Syntax

```
show bgp evpn [community | detail | esi esid | extcommunity | host-flap | instance | large-community AS:nn:nn | next-hop | rt | admin:local-assignment | route-type | summary | vni vni_num]
```

Parameters

- <no parameters> displays all routes of the switch.
- community displays routes filtered by the specified community. Options include:
 - GSHUT well known GSHUT community.
 - aa:nn AS and network number, separated by colon. The value ranges from 1 to 4294967295.
 - internet advertises route to the Internet community.
 - local-as advertises route only to local peers.
 - no-advertise does not advertise the route to any peer.
 - no-export advertises route only within the BGP-EVPN AS boundary
 - comm_num community number. Values range from 1 to 4294967040.
- detail displays detailed information of routes.
- esi esid displays routes filtered by the specified Ethernet Segment Identifier (ESI).
- extcommunity displays routes that match with BGP or VPN extended community list. Options include:
 - esi-label esid displays routes filtered by the specified value of ESI label. The value ranges from 0 to 16777215.
 - mac-mobility displays routes filtered by the specified MAC mobility.
 - rt displays routes filtered by the specified route target.
 - tunnel-encap vxlan displays routes filtered by the VXLAN tunnel encapsulation.
 - router-mac H.H.H displays routes filtered by the specified router MAC address.
- host-flap displays routes that contains MAC addresses that are blacklisted due to duplication.
- instance displays routes with EVPN instances.
- large-community **AS:nn:nn** displays routes filtered by the specified large community.
- next-hop displays routes filtered by next-hop IPv4 or IPv6 addresses of remote VTEP.
- rd admin:local-assignment displays routes filtered by the specified Route Distinguisher (RD).
- route-type displays routes filtered by NLRI route type.
- summary displays summary of routes.
- vni vni_num displays routes filtered by the specified VXLAN Network Identifier (VNI). Value ranges from 1 to 4294967294.

Examples

- This command displays BGP-EVPN routes filtered by the VNI 3011.

```
cvx(config-router-bgp-af)#show bgp evpn vni 3011
BGP routing table information for VRF default
Router identifier 2.0.2.2, local AS number 65002
Route status codes: s - suppressed, * - valid, > - active, # - not installed, E - ECMP
                    head, e - ECMP
                        S - Stale, c - Contributing to ECMP, b - backup
                        % - Pending BGP convergence
Origin codes: i - IGP, e - EGP, ? - incomplete
AS Path Attributes: Or-ID - Originator ID, C-LST - Cluster List, LL Nexthop - Link Local
                    Nexthop

Network                Next Hop                Metric  LocPref Weight  Path
```

```

* >Ec RD: 3.3.3.1:3011 auto-discovery 0 009a:f13b:53bb:8800:0000
      1.1.1.1 - 100 0 65999 65001
i
* ec RD: 3.3.3.1:3011 auto-discovery 0 009a:f13b:53bb:8800:0000
      1.1.1.1 - 100 0 65999 65001
i
* > RD: 3.3.3.2:3011 auto-discovery 0 009a:f13b:53bb:8800:0000
      - - 0 i
* >Ec RD: 3.3.3.1:3011 imet 1.1.1.1
      1.1.1.1 - 100 0 65999 65001
i
* ec RD: 3.3.3.1:3011 imet 1.1.1.1
      1.1.1.1 - 100 0 65999 65001
i
* > RD: 3.3.3.2:3011 imet 1.1.1.2
      - - 0 i
cvx(config-router-bgp-af)#

```

- This command displays the prefixes that are exported to the respective VPN table, along with the route distinguisher.

```

switch(config)#show bgp evpn
BGP routing table information for VRF default
Router identifier 1.1.1.1, local AS number 65001
Route status codes: s - suppressed, * - valid, > - active, # - not installed, E - ECMP
                    head, e - ECMP
                    S - Stale, c - Contributing to ECMP, b - backup
                    % - Pending BGP convergence
Origin codes: i - IGP, e - EGP, ? - incomplete
AS Path Attributes: Or-ID - Originator ID, C-LST - Cluster List, LL Nexthop - Link Local
Nexthop

```

	Network	Next Hop	Metric	LocPref	Weight	Path
* >	RD: 400:1 ip-prefix 45.0.0.1/32	-	-	-	0	i
* >	RD: 400:1 ip-prefix 52.0.0.1/32	-	-	-	0	i
* >	RD: 400:1 ip-prefix 120.0.0.0/24	-	-	-	0	i
* >	RD: 400:1 ip-prefix 130.0.0.0/24	-	-	-	0	i
* >	RD: 400:1 ip-prefix 130.0.1.0/24	-	-	-	0	i

17.13.11 show ip bgp vrf

The `show ip bgp vrf` command displays the type of VPN from the imported route. It shows an indication that the IPv4 route has been leaked and source VRF information is displayed.

Command Mode

Global Configuration

Command Syntax

```
show ip bgp vrf {vrf_name | all | default}
```

Parameters

- `vrf_name` name of the VRF.
- `all` displays summary of all VRFs.
- `default` **default virtual routing and forwarding instance.**

Example

This command displays the leaked and source VRF information.

```
switch(config)#show ip bgp 13.0.0.0/24 vrf vrf-blue
BGP routing table information for VRF vrf-blue
Router identifier 5.0.0.2, local AS number 65001
BGP routing table entry for 130.110.61.0/24
  4.0.0.3 from 4.0.0.3 (52.0.0.1), imported EVPN route, RD 400:1
    Origin IGP, metric -, localpref 100, weight 0, valid, external,best
    Extended Community: Route-Target-AS:4000:1 TunnelEncap:t
unnelTypeVxlan
EvpnRouterMac:74:83:ef:0b:70:f3
  Leaked from VRF vrf-red
```

17.13.12 show ip route vrf

The `show ip route vrf` command displays leaked prefixes with the label “L” in the output that indicates that the IPv4 route has been leaked. It also displays information about the source VRF from which these prefixes have been leaked.

Command Mode

Global Configuration

Command Syntax

```
show ip route vrf {vrf_name | all}
```

Parameters

- `vrf_name` name of the VRF.
- `all` displays summary of all VRFs.

Example

These commands display the OSPF or OSPFv3 leaked routes as “redistribute ospf” and “redistribute ospfv3” are configured on the source VRF vrf-red.

```
switch(config)#show ip route vrf vrf-blue
VRF: vrf-blue
Codes: C - connected, S - static, K - kernel,
        O - OSPF, IA - OSPF inter area, E1 - OSPF external type 1,
        E2 - OSPF external type 2, N1 - OSPF NSSA external type 1,
        N2 - OSPF NSSA external type2, B I - iBGP, B E - eBGP,
        R - RIP, I L1 - IS-IS level 1, I L2 - IS-IS level 2,
        O3 - OSPFv3, A B - BGP Aggregate, A O - OSPF Summary,
        NG - Nexthop Group Static Route, V - VXLAN Control Service,
        DH - DHCP client installed default route, M - Martian,
        DP - Dynamic Policy Route, L - VRF Leaked
Gateway of last resort is not set
C      5.0.0.2/31 is directly connected, Ethernet14
B L    57.0.0.3/32 [200/0] (source VRF vrf-red) via 4.0.0.3, Ethernet11
B L    45.0.0.1/32 [200/0] (source VRF vrf-red) via 4.0.0.3, Ethernet11
B L    52.0.0.1/32 [200/0] (source VRF vrf-red) via 4.0.0.3, Ethernet11
B L    120.0.0.0/24 [200/0] (source VRF vrf-red) via 4.0.0.3, Ethernet11
B L    130.0.0.0/24 [200/0] (source VRF vrf-red) via 4.0.0.3, Ethernet11
B L    130.0.1.0/24 [200/0] (source VRF vrf-red) via 4.0.0.3, Ethernet11
B L    130.0.2.0/24 [200/0] (source VRF vrf-red) via 4.0.0.3, Ethernet11
B L    130.0.3.0/24 [200/0] (source VRF vrf-red) via 4.0.0.3, Ethernet11
```

17.13.13 show ipv6 bgp vrf

The `show ipv6 bgp vrf` command displays the type of VPN from the imported route. It shows an indication that the IPv6 route has been leaked and source VRF information is displayed.

Command Mode

Global Configuration

Command Syntax

```
show ipv6 bgp vrf {vrf_name | all | default}
```

Parameters

- `vrf_name` name of the VRF.
- `all` displays summary of all VRFs.
- `default` default virtual routing and forwarding instance.

Example

This command displays the leaked and source VRF information.

```
switch(config)#show ipv6 bgp 2001:10:1:0::102/64 vrf default
BGP routing table information for VRF default
Router identifier 218.218.218.218, local AS number 34
Route status codes: s - suppressed, * - valid, > - active, # - not installed, E
- ECMP head, e - ECMP
                    S - Stale, c - Contributing to ECMP, b - backup, L -
labeled-unicast
                    % - Pending BGP convergence
Origin codes: i - IGP, e - EGP, ? - incomplete
AS Path Attributes: Or-ID - Originator ID, C-LST - Cluster List, LL Nexthop -
Link Local Nexthop

* >      Network          Next Hop          Metric  LocPref  Weight  Path
*        2000:0:14:120::/64  2001:db8:1111:9000::  -      100     109    i
*        2000:0:14:120::/64  2001:db8:156:1010::2  -      100     0      i
*        2000:0:14:120::/64  2001:db8:152:1010::2  -      100     0      i
*        2000:0:14:120::/64  2001:db8:203:1010::2  -      100     0      i
```

17.13.14 show ipv6 route vrf

The `show ipv6 route vrf` command displays leaked prefixes with the label “L” in the output that indicates that the IPv6 route has been leaked. It also displays information about the source VRF from which these prefixes have been leaked.

Command Mode

Global Configuration

Command Syntax

```
show ipv6 route vrf{vrf_name | all}
```

Parameters

- `vrf_name` name of the VRF.
- `all` displays summary of all VRFs.

Example

These commands display the OSPF or OSPFv3 leaked routes as “redistribute ospf” and “redistribute ospfv3” are configured on the source VRF `vrf-red`.

```
switch(config)#show ipv6 route vrf vrf-blue
VRF: vrf-blue
Displaying 802 of 802 IPv6 routing table entries
Codes: C - connected, S - static, K - kernel, O3 - OSPFv3, B - BGP, R -
RIP, A B - BGP Aggregate,
I L1 - IS-IS level 1, I L2 - IS-IS level 2, DH - DHCP, NG - Nexthop Group
Static Route, M - Martian,
DP - Dynamic Policy Route, L - VRF Leaked
B L 18::1/128 [200/0] (source VRF vrf-red)
    via 4::3, Ethernet11
B L 6::2/127 [200/0] (source VRF vrf-red)
    via fe80::7683:efff:fe0b:963d, Ethernet11
B L 45::1/128 [200/0] (source VRF vrf-red)
    via fe80::7683:efff:fe0b:963d, Ethernet11
B L 130::/64 [200/0] (source VRF vrf-red)
    via fe80::7683:efff:fe0b:963d, Ethernet11
B L 130:0:0:1::/64 [200/0] (source VRF vrf-red)
    via fe80::7683:efff:fe0b:963d, Ethernet11
B L 130:0:0:2::/64 [200/0] (source VRF vrf-red)
    via fe80::7683:efff:fe0b:963d, Ethernet11
B L 130:0:0:3::/64 [200/0] (source VRF vrf-red)
```

17.13.15 show l2rib input all

Use the `show l2rib input all` command to display the Layer 2 RIB input tables migration process.

Command Mode

EXEC

Command Syntax

```
show l2rib input all [ detail | floodset [ vlan | vtep ] | interface [ Ethernet | Port-Channel ] | mac  
H.H.H | vlan vlan_id | vtep [ A.B.C.D | A:B:C:D:E:F:G:H ]
```

Parameters

- **detail** Displays a more comprehensive output.
- **floodset** Displays L2Rib floodset from input source.
 - **vlan** Filter by VLAN ID.
 - **vtep** Filter by VTEP.
- **interface** Filter by destination interface.
 - **Ethernet** Ethernet interface.
 - **Port-Channel** Link Aggregation Group (LAG).
- **mac *H.H.H*** Filter by MAC address.
- **vlan *vlan_id*** Filter by VLAN ID.
- **vtep** Filter by VTEP.
 - **A.B.C.D** IP address of VTEP.
 - **A:B:C:D:E:F:G:H** IP address of VTEP.

17.13.16 show l2Rib input vxlan-control-service

Use the `show l2Rib input vxlan-control-service` to display the migration processes for the VXLAN control service.

Command Mode

EXEC

Command Syntax

```
show l2Rib input vxlan-control-service [ detail | floodset [ vlan | vtep ] | interface [ Ethernet | Port-Channel ] | mac H.H.H | vlan vlan_id | vtep [A.B.C.D | A:B:C:D:E:F:G:H ]
```

Parameters

- **detail** Displays a more comprehensive output.
- **floodset** Displays L2Rib floodset from input source.
 - **vlan** Filter by VLAN ID.
 - **vtep** Filter by VTEP.
- **interface** Filter by destination interface.
 - **Ethernet** Ethernet interface.
 - **Port-Channel** Link Aggregation Group (LAG).
- **mac** Filter by MAC address.
 - ***H.H.H*** Ethernet address.
- **vlan *vlan_id*** Filter by VLAN ID.
- **vtep** Filter by VTEP.
 - ***A.B.C.D*** IP address of VTEP.
 - ***A:B:C:D:E:F:G:H*** IP address of VTEP.

17.13.17 show l2rib output

Use the `show l2rib output` command to display the the Layer 2 RIB utput tables migration process.

Command Mode

EXEC

Command Syntax

```
show l2rib output [ detail | floodset [ vlan | vtep ] | mac H.H.H | vlan vlan_id | vtep [ A.B.C.D | A:B:C:D:E:F:G ]
```

Parameters

- **detail** Displays a more comprehensive output.
- **floodset** Displays L2Rib floodset from input source.
 - **vlan** Filter by VLAN ID.
 - **vtep** Filter by VTEP.
- **interface** Filter by destination interface.
 - **Ethernet** Ethernet interface.
 - **Port-Channel** Link Aggregation Group (LAG).
- **mac *H.H.H*** Filter by MAC address.
- **vlan *vlan_id*** Filter by VLAN ID.
- **vtep** Filter by VTEP.
 - **A.B.C.D** IP address of VTEP.
 - **A:B:C:D:E:F:G:H** IP address of VTEP.

17.13.18 show service vxlan address-table

The **show service vxlan address-table** command displays route entries in the MAC forwarding table that are added through the CVX.

Command Mode

CVX Global Configuration

Command Syntax

```
show service vxlan address-table {advertised | received}[address H.H.H | evpn | hsc | mss |
switch [Word | all] | vni vniid | vtep A.B.C.D]
```

Parameters

- **advertised** displays the advertised route entries in the MAC forwarding table.
- **received** displays the received route entries in the MAC forwarding table.
- **address *H.H.H*** displays route entries that are filtered by the specified MAC addresses.
- **evpn** displays route entries filtered by BGP-EVPN.
- **hsc** displays route entries filtered by Hardware Switch Controller (HSC).
- **mss** displays route entries filtered by Macro Segmentation Service (MSS).
- **switch** displays route entries that are filtered by the specified switch or all switches. Options include:
 - ***Word*** Hostname, IP address or ID of the switch.
 - **all** all switches
- **vni *vniid*** displays route entries filtered by the specified VXLAN Network Identifier (VNI). Value ranges from 1 to 4294967294.
- **vtep *A.B.C.D*** displays route entries filtered by the specified IP address of the remote Virtual Tunnel End Point (VTEP).

Examples

- This command displays the route entries in MAC forwarding table advertised to BGP-EVPN peers.

```
cvx#show service vxlan address-table advertised evpn
```

```

      Advertised Mac Address Table
-----
VNI           Mac Address      VTEP           Moves
-----
1000          02:01:62:01:00:00 10.0.0.1       1
Total Mac Addresses for this criterion: 1

      Advertised Flood Table
-----
VNI           Mac Address      VTEP(s)
-----
1000          00:00:00:00:00:00 10.0.0.1      10.0.0.2
Total Mac Addresses for this criterion: 1
cvx#
```

- This command displays the route entries in MAC forwarding table received from BGP-EVPN peers.

```
cvx#show service vxlan address-table received evpn
```

```

      Received Mac Address Table
-----
Source        VNI           Mac Address      VTEP           Moves
-----
EVPN          1000          02:01:62:02:00:00 10.0.0.3       1
Total Mac Addresses for this criterion: 1
```

Received Flood Table

```
-----  
Source          VNI      Mac Address      VTEP  
-----  
EVPN            1000     00:00:00:00:00:00 10.0.0.3  
EVPN            1000     00:00:00:00:00:00 10.0.0.4  
Total Mac Addresses for this criterion: 2  
cvx#
```

17.13.19 show vrf leak flapping

The **show vrf leak flapping** command displays the flapping prefixes of the routes leaked from one VRF to another VRF. Routes that are detected as “flapping” are blocked considering the future leaking policy execution.

Command Mode

EXEC

Command Syntax

```
show vrf leak flapping
```

Parameters

- **destination** displays flapping prefixes destined to a VRF.
- **prefix** displays flapping routes for a prefix.
- **source** displays flapping prefixes sourced from a VRF.
- **vrf** displays flapping prefixes associated with a VRF

Example

This command displays the flapping prefixes of the leaked routes.

```
switch#show vrf leak flapping  
  
Age          Source VRF      Destination VRF      Prefix              Created At  
-----  
141         VRF1            VRF2                 10.0.2.0/24        3357281.40992
```

17.13.20 show vxlan control-plane

To enable the user to quickly view which control planes and sources are importing reachability information into which VLANs, use the following show command:

Command Mode

EXEC

```
show vxlan control-plane [ export vlan [ $ | vlan_id ] | import vlan [ $ | vlan_id ] ] [vlan [ $ | vlan_id ]
```

Parameters

- **export** Restricts output to VLANs exporting to a control plane.
 - **vlan** Specifies specific VLANs to display control plane information.
 - **\$** List end.
 - ***vlan_id*** VLAN ID. Range 1-4094.
- **import** Restricts output to VLANs importing from a control plane.
 - **\$** List end.
 - ***vlan_id*** VLAN ID. Range 1-4094.
- **vlan** Specifies specific VLANs to display control plane information.
 - **\$** List end.
 - ***vlan_id*** VLAN ID. Range 1-4094.

17.13.21 vlan (VLAN-AWARE-Bundle configuration mode)

The `vlan add/ remove` command configures the VLAN range string in a VLAN-AWARE-BUNDLE. When the add and remove options are not used, the currently configured range is replaced by the new one. The add and remove options update the currently configured range-aware bundles by adding or removing the provided VLAN range from the currently configured range respectively.

Command Mode

VLAN-AWARE-BUNDLE Configuration

Command Syntax

```
vlan [add | remove] range
```

Parameters

- *range* is the range specified.

Example

These commands take an existing vlan-aware-bundle configuration, corporate_100, and modify it with the add and remove options.

```
(Existing configuration for corporate_100)
vlan-aware-bundle corporate_100
  rd 1.1.1.1:100
  route-target both 100:100
  vlan 1-10

switch(config-vlan-aware-bundle) #vlan add 1000

(Modified configuration for corporate_100)
vlan-aware-bundle corporate_100
  rd 1.1.1.1:100
  route-target both 100:100
```

```
vlan 1-10, 1000

switch(config-vlan-aware-bundle)#vlan remove 5

(Updated configuration for corporate_100)
vlan-aware-bundle corporate_100
  rd 1.1.1.1:100
  route-target both 100:100
  vlan 1-4, 6-10, 1000
```

17.13.22 vni-aware-bundle

The **vni-aware-bundle** command configures a BGP MAC-VRF containing Layer 2 routes from a group of VXLAN Network Identifiers (VNI).

Command Mode

Router BGP Configuration

Command Syntax

```
vni-aware-bundle vni_bundle_name
```

Parameter

vni_bundle_name VNI bundle name.

Example

This command configures MAC-VRF BGP to support VNI bundle1.

```
cvx(config) #router bgp 100  
cvx(config-router-bgp) #vni-aware-bundle bundle1  
cvx(config-macvrf-bundle1) #
```

Multiprotocol Label Switching (MPLS)

Tunneling protocols encapsulate packets of a different protocol as the payload of a larger frame for delivery within networks utilizing the encapsulating protocol. Tunneling facilitates the delivery of payload over an incompatible delivery network and creates a secure path through an untrusted network. Protocols that this chapter describes include MPLS, Decap Groups, and Nexthop Groups.

Sections in this chapter include:

- [MPLS](#)
- [BGP/MPLS L3 VPN](#)
- [EVPN MPLS Shared ESI Label](#)
- [RSVP-TE LSR](#)
- [LDP Pseudowire](#)
- [LDP Entropy Label](#)
- [MPLS Commands](#)

18.1 MPLS

These sections describe the Arista MPLS implementation:

- [MPLS Description](#)
- [MPLS Configuration](#)

18.1.1 MPLS Description

18.1.1.1 MPLS Overview

Multiprotocol Label Switching (MPLS) is a networking process that replaces complete network addresses with short path labels for directing data packets to network nodes. The labels identify virtual links (paths) between distant nodes rather than endpoints. MPLS is scalable and protocol-independent. Data packets are assigned labels, which are used to determine packet forwarding destinations without examining the packet.

Arista switches utilize MPLS to improve efficiency and control from servers through data centers and to the WAN. The MPLS implementation supports static MPLS tunneling that is manually configured on each switch or established over a network by an SDN controller. The configuration is specified by a set of rules that filter packets based on matching criteria. Each rule applies MPLS-related actions to packets that match the rule's criteria. Each rule includes a metric that the switch uses to select an action when multiple rules match a packet.

18.1.1.2 MPLS Implementation

MPLS static rule parameters contain the following:

- A 20-bit value that is compared to the top header label of each MPLS packet. Other rule parameters may be applied to packets whose top label match this value.
- A nexthop location that specifies the packet's next destination (IPv4 or IPv6) and the interface through which the switch forwards the packet.

- An MPLS label stack management action that is performed on filtered packets:
 - pop-payload: removes the top label from stack; this terminates an LSP (label-switched path).
 - swap-label: replaces top label with a specified new label; this passes a packet along an LSP.
- A rule metric that the switch uses to select a rule when multiple rules match an MPLS packet.

Packets that do not match any MPLS rules are dropped.

18.1.1.3 MPLSoGRE Filtered Mirroring

In MPLS over Generic Routing Encapsulation (MPLSoGRE) filtered mirroring, IPv4 over MPLS over GRE (IPv4oMPLSoGRE) and IPv6 over MPLS over GRE (IPv6oMPLSoGRE) packets that enter a GRE tunnel endpoint on which MPLS lookup is performed, are selected for mirroring based on the destination IP address field in the inner IPv4 or IPv6 header.

 **Note:** These packets are not selected for mirroring if they are forwarded based on either the L2 or outer L3 header destination address.

the image below shows the header format of the packets that are selected for mirroring.

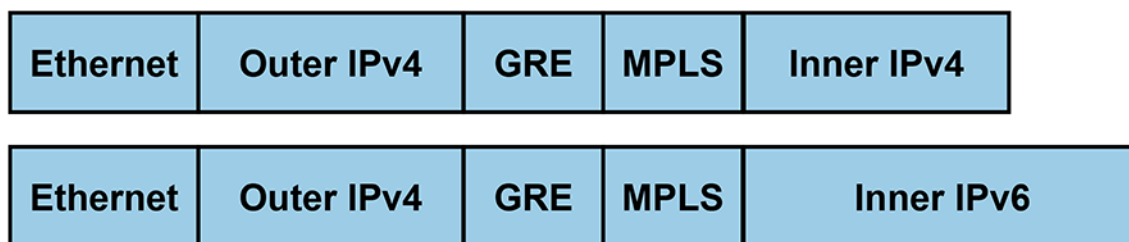

Figure 136: Header Format of Packets

When mirroring to a GRE tunnel, the payload of the outgoing GRE packet contains the payload of the incoming source packet starting from the MPLS header. L2 and outer L3 headers are stripped from the mirror copy. When the MPLS lookup fails, the packet is still eligible for mirroring based on the selection criteria defined in the ACL.

18.1.1.4 Mixed TTL/DSCP in MPLS Tunnel Termination

A Label Edge Router (LER) decapsulating an MPLS packet may choose to source the TTL and DSCP fields from either the MPLS header or the original inner IPv4 header. However, some applications need the TTL field value from the MPLS header, while retaining the DSCP from the original IPv4 header. Mixed TTL/DSCP in MPLS Tunnel Termination enables tunnel termination to select this specific mix of two modes.

This section contains the following topics:

- [Platform Compatibility](#)
- [Configuration](#)
- [Packet Support for IPv6](#)

18.1.1.4.1 Platform Compatibility

Support for mixed TTL/DSCP in MPLS tunnel termination is available on the following platforms:

- DCS-7020R
- DCS-7280R/R2
- DCS-7500R/R2

18.1.1.5 Support for MPLS Packets in IP ACLs

Ingress and egress IPv4 and IPv6 access-lists do not automatically match the inner IP header when processing IP over MPLS traffic.

Support is now available to allow matching of the inner IP header in an access-list by adding the proper packet types to the corresponding TCAM features.

18.1.1.5.1 Platform Compatability

The following platforms support MPLS Packets in IP ACLs:

- DCS-7280R/R2
- DCS-7500R/R2

18.1.2 MPLS Configuration

MPLS routing is enabled through the `mpls ip` command.

- This command enables MPLS routing.

```
switch(config)#mpls ip
switch(config)#show running-config mpls ip
!

end
switch(config)#
```

MPLS rules are created by the `mpls static` command. MPLS static rules identify a set of MPLS packets by a common top label and defines the method of handling these packets.

These commands create an MPLS rule that matches packets with a top label value of 3400 and causes the removal of the top label from the header stack. The nexthop destination of the IPv4 payload is IP address 10.14.4.4 through Ethernet interface 3/3/3. This rule has a metric value of 100.

```
switch(config)#mpls static top-label 3400 ethernet 3/3/3
10.14.4.4 pop
payload-type ipv4
switch(config)#show running-config

!
mpls static top-label 3400 Ethernet3/3/3 10.14.4.4 pop payload-
type ipv4
!

end
switch(config)#
```

These commands create a backup rule that forwards the packet through Ethernet interface 4/3. This rule's metric value of 150 assigns it backup status prior to the first rule.

```
switch(config)#mpls static top-label 3400 ethernet 4/3 10.14.4.4  
pop payload-type  
ipv4 metric 150  
switch(config)#show running-config  
  
!  
mpls static top-label 3400 Ethernet4/3 10.14.4.4 pop payload-type  
  ipv4 metric 150  
mpls static top-label 3400 Ethernet3/3/3 10.14.4.4 pop payload-  
type ipv4  
!  
  
end  
switch(config)#
```

These commands create an MPLS rule that forwards the packet to the nexthop address through any interface.

```
switch(config)#mpls static top-label 4400 10.15.46.45 pop  
payload-type ipv4  
switch(config)#show running-config  
  
!  
mpls static top-label 3400 Ethernet4/3 10.14.4.4 pop payload-type  
  ipv4 metric 150  
mpls static top-label 3400 Ethernet3/3/3 10.14.4.4 pop payload-  
type ipv4  
mpls static top-label 4400 10.15.46.45 pop payload-type ipv4  
!  
  
end  
switch(config)#
```

This command configures a static tunnel for the tunnel endpoint 64.0.0.1 and pushes a label 11111 to it.

```
switch(config)#mpls static STATIC 64.0.0.1/32 54.0.0.1 Port-  
Channel7 label-stack 11111
```

This example shows MPLS swap route configuration. The following CLI swaps a packet with MPLS top label 3400 to 5600 for forwarding to 10.14.4.4.

```
switch(config)#mpls static top-label 3400 10.14.4.4 swap 5600  
switch(config)#
```

This example shows MPLS next-hop groups configuration for MPLS. The following CLI shows the specification of a next hop group called TestGrp1 with two entries.

```
switch(config)#nexthop-group TestGrp1 type MPLS
switch(config-nexthop-group-TestGrp1)#size 2
switch(config-nexthop-group-TestGrp1)#entry 0 push label-stack 70
  nexthop 10.20.30.5
switch(config-nexthop-group-TestGrp1)#entry 1 push label-stack 71
  nexthop 10.20.30.6
switch(config-nexthop-group-TestGrp1)#exit
switch(config)#
```

The label-stack keyword can take only one label. Tunnel-source and ttl config commands do not apply to MPLS NexthopGroups and are disabled. The nexthop entry is recursively resolved when the specified entry is a remote nexthop. The show command indicates the resolved, directly-attached nexthop.

The switch's MPLS static rule configuration for specified routes and rules is displayed by `show mpls route`.

This command displays the MPLS rule configuration.

```
switch>show mpls config route
In-Label  Out-Label  Metric  Payload  NextHop
3400      pop        100     ipv4     10.14.4.4,Et3/3/3
3400      pop        150     ipv4     10.14.4.4,Et4/3
switch>
```

Statistics about the configuration and implementation of MPLS rules are displayed by the `show mpls route summary` command.

This command displays a summary of MPLS rule implementation.

```
switch>show mpls route summary
Number of Labels: 1 (1 unprogrammed)
Number of adjacencies in hardware: 0
Number of backup adjacencies: 2
switch>
```

The `show mpls lfib route` command displays the Label Forward Information Base of the switch.

```
switch(config)#show mpls lfib route
MPLS forwarding table (Label [metric] Vias) - 1 routes
MPLS next-hop resolution allow default route: False
Via Type Codes:
    M - MPLS via, P - Pseudowire via,
    I - IP lookup via, V - VLAN via,
    VA - EVPN VLAN aware via, ES - EVPN ethernet segment
via,
```

```

via,          VF - EVPN VLAN flood via, AF - EVPN VLAN aware flood
              NG - Nexthop group via
Source Codes:
              G - gRIBI, S - Static MPLS route,
              B2 - BGP L2 EVPN, B3 - BGP L3 VPN,
              R - RSVP, LP - LDP pseudowire,
              L - LDP, M - MLDP,
              IP - IS-IS SR prefix segment, IA - IS-IS SR adjacency
segment,
              IL - IS-IS SR segment to LDP, LI - LDP to IS-IS SR
segment,
              BL - BGP LU, ST - SR TE policy,
              DE - Debug LFIB

S   300          [100]
              via M, 192.0.2.2, swap 500
              payload mpls, bypass egress-acl
              interface Ethernet3/1
switch(config)#

```

The `show ip route` command displays all IP routes along with static MPLS push routes and Nexthop Group routes.

```

switch(config)#show ip route
VRF name: default
Codes: C - connected, S - static, K - kernel,
O - OSPF, IA - OSPF inter area, E1 - OSPF external type 1,
E2 - OSPF external type 2, N1 - OSPF NSSA external type 1,
N2 - OSPF NSSA external type2, B I - iBGP, B E - eBGP,
R - RIP, I L1 - ISIS level 1, I L2 - ISIS level 2,
O3 - OSPFv3, A B - BGP Aggregate, A O - OSPF Summary,
NG - Nexthop Group Static Route, V - VXLAN Control Service

Gateway of last resort is not set
C 192.0.2.0/24 is directly connected, Ethernet1/1
S 3.3.3.0/24 [1/0] via 192.0.2.2, Ethernet1/1 label 200
S 10.80.0.0/13 [1/0] via 172.24.0.1, Management1
S 10.95.0.0/20 [1/0] via 172.24.0.1, Management1
C 172.24.0.0/18 is directly connected, Management1
S 172.16.0.0/12 [1/0] via 172.24.0.1, Management1
switch(config)#

```

The MPLS push routes are of type static so the `show ip route static` command also displays the output for an MPLS Nexthop Group assuming there is a route pointing to the NexthopGroup and the entries in the NexthopGroup are resolved. The output for `show nexthop-group TestGrp1` for the test group configured earlier is shown below.

```

switch(config)#show nexthop-group TestGrp1
TestGrp1
  Id 2
  Type MPLS
  Size 2
  Entries
    0 push label-stack 70 nexthop 10.20.30.5
    Tunnel destination directly connected, Ethernet2

```



```

52:14:a3:a6:50:e8, Ethernet2
 1 push label-stack 71 nexthop 10.20.30.6
Tunnel destination directly connected, Ethernet2
52:14:a3:a6:50:e8, Ethernet2
switch(config)#

```

18.1.2.1 LSP Ping/Traceroute for MPLS Nexthop Group Tunnels

The `ping/traceroute mpls tunnel nexthop-group` command checks the liveness of Nexthop Group tunnel endpoint for an MPLS Nexthop Group.

The following displays the output for the `ping` command where the endpoint is specified.

```

switch(config)#rtrmpls1
switch(config-rtrmpls1)#ping mpls tunnel nexthop-group 100.0.116.1/32
LSP ping to nexthop-group tunnel 100.0.116.1/32

100.0.116.1/32: nexthop-group tunnel index 1 (nexthop-group name:
nhg-100)
Entry 0
Via 10.0.16.2
Reply from 10.0.108.1: seq=1, time=507.546ms
Entry 1
Via 10.0.16.8
Reply from 10.0.113.1: seq=1, time=516.131ms

--- nexthop-group tunnel index 1, nexthop-group nhg-100: lsping
statistics
---
Entry 0
Via 10.0.16.2
1 packets transmitted, 1 received, 0% packet loss, time 652ms
1 received from 10.0.108.1, rtt min/max/avg 507.546/507.546/507.546 ms

Entry 1
Via 10.0.16.8
1 packets transmitted, 1 received, 0% packet loss, time 652ms
1 received from 10.0.113.1, rtt min/max/avg 516.131/516.131/516.131ms

```

The following displays the output where the endpoint is specified for `traceroute` command.

```

switch(config)#rtrmpls1
switch(config-rtrmpls1)#traceroute mpls tunnel nexthop-group
100.0.116.1/32
LSP traceroute to nexthop-group tunnel 100.0.116.1/32
Traceroute over nexthop-group tunnel index 1, nexthop-group nhg-100 Entry
1
Entry 1
 1 10.0.225.1          32.571ms
    label stack (top label first): 89
 2 10.0.227.1          42.866ms
    label stack (top label first): 109
 3 10.0.229.1          54.893ms
    label stack (top label first): 110
 4 10.0.231.1          15.946ms
    label stack (top label first): 111
 5 10.0.233.1          27.72ms
    label stack (top label first): 112
 6 10.0.113.1          36.383ms

```

The following displays the output for the `ping` command where the static route resolves over Nexthop Group tunnel(s).

```
switch(config-rtrmpls1)#ping mpls static ip 100.0.77.0/24
LSP ping to static MPLS push label route 100.0.77.0/24

100.0.77.0/24: nexthop-group tunnel index 1 (nexthop-group name: nhg-46)
Entry 0
  Via 10.0.25.5
  Reply from 10.0.51.1: seq=1, time=112.171ms

100.0.77.0/24: nexthop-group tunnel index 2 (nexthop-group name: nhg-64)
Entry 0
  Via 10.0.25.4
  Reply from 10.0.68.1: seq=1, time=121.809ms
Entry 1
  Via 10.0.25.9
  Reply from 10.0.76.1: seq=1, time=133.668ms

--- nexthop-group tunnel index 1, nexthop-group nhg-46: lsping
statistics ---
Entry 0
  Via 10.0.25.5
  1 packets transmitted, 1 received, 0% packet loss, time 251ms
  1 received from 10.0.51.1, rtt min/max/avg 112.171/112.171/112.171 ms

--- nexthop-group tunnel index 2, nexthop-group nhg-64: lsping
statistics ---
Entry 0
  Via 10.0.25.4
  1 packets transmitted, 1 received, 0% packet loss, time 251ms
  1 received from 10.0.68.1, rtt min/max/avg 121.809/121.809/121.809 ms

Entry 1
  Via 10.0.25.9
  1 packets transmitted, 1 received, 0% packet loss, time 251ms
  1 received from 10.0.76.1, rtt min/max/avg 133.668/133.668/133.668 ms
```

The following displays the output for the `traceroute` command where the static route resolves over Nexthop Group tunnel(s). The command randomly selects a tunnel.

```
switch(config-rtrmpls1)#traceroute mpls static ip 100.0.77.0/24LSP
traceroute to 100.0.77.0/24
100.0.77.0/24: nexthop-group tunnel index 1 (nexthop-group name: nhg-46)
100.0.77.0/24: nexthop-group tunnel index 2 (nexthop-group name: nhg-64)
Traceroute over nexthop-group tunnel index 1, nexthop-group nhg-46 Entry
0
Entry 0
  1 10.0.83.1          382.798ms
    label stack (top label first): 35
  2 10.0.85.1          42.7ms
    label stack (top label first): 47
  3 10.0.87.1          55.815ms
    label stack (top label first): 48
  4 10.0.89.1          17.728ms
    label stack (top label first): 49
  5 10.0.91.1          29.452ms
    label stack (top label first): 50
  6 10.0.51.1          38.686ms
```

18.1.2.2 Egress IPv4/IPv6 over MPLS ACLs

IPv4/IPv6 over MPLS packets are now eligible for ACLs at the egress stage by default, applicable only to IPv4/IPv6 over MPLS packets that are MPLS label popped (such as if the label is at the bottom of stack). The user can override this behavior if required, thereby disabling egress ACLs for certain MPLS labels by configuration. No special configuration is required to enable egress ACLs on IPv4/IPv6 over MPLS packets.

- This command disables egress ACLs for MPLS top-label 12000 on the egress interface *120.1.1.1* nexthop address.

```
switch(config)#no mpls static top-label 12000 120.1.1.1 pop
payload-type ipv6
switch(config)#
```

- This command enables egress ACLs for MPLS top-label 12000 on the egress interface *120.1.1.1* nexthop address.

```
switch(config)#mpls static top-label 12000 120.1.1.1 pop
payload-type ipv6
switch(config)#
```

18.1.2.3 Configuring MPLSoGRE Filtered Mirroring

The filtered mirroring of terminated MPLSoGRE packets is configured by creating an IPv4 access-list, and then attaching the IPv4 access-list to a monitor session source where a tunnel decap group has been configured. This IPv4 access-list has rules that match to either inner IPv4 or IPv6 destination addresses.

Enabling the TC-Counters TCAM Profile

The following limitations are applicable to MPLSoGRE filtered mirroring in tc-counters TCAM profile:

- Security ACLs are not enforced on IPv4oMPLSoGRE and IPv6oMPLSoGRE terminated packets.
- The rules of a mirroring-ACL are set to match either inner IPv4 or inner IPv6 header fields, but not both.

The ACLs containing rules to match both inner IPv4 and inner IPv6 header fields are not applicable to a single source interface in multiple mirroring sessions. In other words, all ACLs applied to a shared source interface must contain either inner IPv4 rules or inner IPv6 rules.

The commands below switch to the tc-counters TCAM profile in the running configuration.

```
switch(config)#hardware tcam
switch(config-hw-tcam)#system profile tc-counters
switch(config-hw-tcam)#exit
```

Defining Two IPv4 Access-Lists

The `ip access-list` command places the switch in ACL configuration mode, which is a group change mode that modifies an IPv4 access control list. The command specifies the name of the IPv4 ACL that subsequent commands modify and creates an ACL if it references a nonexistent list. All changes in a group change mode edit session are pending till the end of the session.

The `permit (Role)` command configures one access-list to match the inner IPv4 address, and the other access-list to match the inner IPv6 address.

```
switch(config)#ip access-list dIPv4
switch(config)#10 permit ip any any inner ip any host 5.5.5.5
switch(config)#exit

switch(config)#ip access-list dIPv6
switch(config)#10 permit ip any any inner ipv6 any host 55::55
switch(config)#exit
```

Attaching Access-Lists

The `monitor session source` and `monitor session destination` commands allow to attach two access-lists to two different monitor session sources.

```
switch(config)#monitor session sess1 source et1 rx ip access-group dIPv4
switch(config)#monitor session sess1 destination tunnel mode gre source 1.1.1.1
destination 2.2.2.2
switch(config)#monitor session sess2 source et2 rx ip access-group dIPv6
switch(config)#monitor session sess2 destination tunnel mode gre source 3.3.3.3
destination 4.4.4.4
switch(config)#show monitor session

Session sess1
-----

Source Ports:

  Rx Only:      Et1 (IP ACL: dIPv4)

Destination Ports:

      status   source   dest     TTL   DSCP   proto   VRF     fwd-drop
Gre1 : active   1.1.1.1  2.2.2.2  128   0      0x88be  default no

Session sess2
-----

Source Ports:

  Rx Only:      Et2 (IP ACL: dIPv6), Et5 (IP ACL: dIPv6)

Destination Ports:

      status   source   dest     TTL   DSCP   proto   VRF     fwd-drop
Gre2 : active   3.3.3.3  4.4.4.4  128   0      0x88be  default no

switch(config)#
```

18.1.2.4 Configuration

Mixed TTL/DSCP in MPLS tunnel termination is intended to be used with MPLS VRF decapsulation. Therefore, a static VRF-to-MPLS-label map is expected to be provided, similar to the following:

```
switch(config)#mpls ip
switch(config)#mpls static vrf-label mpls-label vrf vrf-name
switch(config)#ip routing vrf vrf-name
```

TTL=uniform and DSCP=pipe options have been added to the existing `mpls tunnel termination` command:

```
switch(config)#mpls tunnel termination model ttl uniform dscp pipe
```

Also, a new TCAM profile packet type has been introduced:

```
switch(config)#packet mpls ipv4 forwarding routed decap
```

Configuration occurs under the “qos ip” feature section of a user defined TCAM profile:

```
switch(config)#hardware tcam
# May use any profile that provides “qos ip”
switch(config-tcam)#profile name copy default
switch(config-tcam-profile-name)#feature qos ip
switch(config-tcam-profile-name-feature-qos-ip)#packet mpls ipv4
forwarding routed decap

switch(config-tcam)#system profile name
```

18.1.2.4.1 Packet Support for IPv6

RFE 391109 brings mixed TTL/DSCP support for IPv6 over MPLS packets as well. The TCAM profile configuration is similar to the above IPv4 configuration:

```
switch(config)#hardware tcam
# May use any profile that provides “qos ipv6”
switch(config-tcam)#profile name copy default
switch(config-tcam-profile-name)#feature qos ipv6
switch(config-tcam-profile-name-ipv4)#packet mpls ipv6 forwarding routed
decap
switch(config-tcam)#system profile name
```

18.1.2.5 Configurations to Support IP ACLs for MPLS Packets

18.1.2.5.1 Ingress IP Access-List Support

To facilitate inner IP header matching, there are two TCAM profile packet types:

```
packet mpls ipv4 forwarding bridged
packet mpls ipv4 forwarding mpls
```

The ingress inner IP header matching creates a user-defined profile with these new packet types. Although MAC access-lists do not match on the inner IP header, you must add this packet type in order to generate a lookup for MPLS packets (if using MAC ACLs).

```
hardware tcam
#May use any profile that provides ACL features
profile <name> copy default
feature acl port ip
packet mpls ipv4 forwarding bridged
packet mpls ipv4 forwarding mpls
feature acl port ipv6
packet mpls ipv6 forwarding bridged
packet mpls ipv6 forwarding mpls
feature acl port mac
packet mpls ipv4 forwarding bridged
```

```
packet mpls ipv4 forwarding mpls
packet mpls ipv6 forwarding bridged
packet mpls ipv6 forwarding mpls
system profile <name>
```

Starting in the EOS 4.23.1 Release, ingress on inner IP header matching in MPLS packets is also supported on PBR ACLs. In order to enable this, the following must be configured in a user-defined TCAM profile:

```
hardware tcam
#May use any profile that provides ACL features
profile <name> copy default
feature pbr ip
packet mpls ipv4 forwarding mpls
feature pbr ipv6
packet mpls ipv6 forwarding mpls
```

18.1.2.5.2 Egress IPv4/IPv6 over MPLS ACLs

IPv4/IPv6 over MPLS packets are now eligible for ACLs at the egress stage by default, applicable only to IPv4/IPv6 over MPLS packets that are MPLS label popped (such as if the label is at the bottom of stack). The user can override this behavior if required, thereby disabling egress ACLs for certain MPLS labels by configuration. No special configuration is required to enable egress ACLs on IPv4/IPv6 over MPLS packets.

- This command disables egress ACLs for MPLS top-label 12000 on the egress interface `120.1.1.1` nexthop address.

```
switch(config)#no mpls static top-label 12000 120.1.1.1 pop
payload-type ipv6
switch(config)#
```

- This command enables egress ACLs for MPLS top-label 12000 on the egress interface `120.1.1.1` nexthop address.

```
switch(config)#mpls static top-label 12000 120.1.1.1 pop
payload-type ipv6
switch(config)#
```

18.1.2.5.3 MPLS Pop Terminated Packets

To enable the use of these qualifiers on MPLS-terminated packets by last label pop, this feature must be applied to the current TCAM profile, as illustrated below:

```
feature acl port ip egress mpls-tunnelled-match
```

No functionality is lost, however, this feature is not enabled by default on all system profiles. Some TCAM profiles may also use the resources required by this feature. Verification is required to ensure the current user-defined TCAM profile supports this feature.

```
hardware tcam
#May use any profile that provides ACL features
profile <name> copy <some-system-profile>
feature acl port ip egress mpls-tunnelled-match
system profile <name>
```

18.1.2.5.4 MPLS VRF-Decapsulated Packets

To enable the use of these new qualifiers on MPLS-terminated packets by last label VRF-label mapping, the packet type `mpls ipv4 forwarding routed decap` must be applied to at least one feature in the TCAM profile. For example:

```
hardware tcam
  profile <name> copy default
    feature qos ip
      packet mpls ipv4 forwarding routed decap
  system profile <name>
```

18.2 BGP/MPLS L3 VPN

Border Gateway Protocol/ Multiprotocol Label Switching (BGP/MPLS) L3 Virtual private Network (VPN) allows a Service Provider (SP) or an Enterprise to provide the service of interconnecting geographically dispersed customer sites. This type of service can be provided to multiple customers over the common network backbone infrastructure of the Service Provider, while:

- Maintaining privacy of each customer
- Allowing for overlapping IP addresses among customers
- Having constrained route distribution – such as, only those routers in the Service Provider's network that need the customer routes, have them.

Achieve the above through the extensions to BGP as defined in RFC 4364 for IPv4 and RFC 4659 for IPv6, and the use of VPN Routing and Forwarding Tables (VRFs), Route Distinguishers (RDs), and Route Targets (RTs).

BGP/MPLS L3 VPN is available when configuring BGP in the multi-agent routing protocol model.

- [Platform Compatibility](#)
- [Operation](#)
- [Configuration](#)
- [Show Commands](#)
- [Limitations](#)

18.2.1 Platform Compatibility

MPLS tunnel support for traceroute and PMTU discovery is available on the following platforms:

7280CR	7280QR	7280SR2K	7280TRA	7508	7500R2M
7280CR2	7280QRA	7280SR2L	7500E	7508N	7500RA
7280CR2A	7280SE	7280SRA	7500R	7512N	7500RM
7280CR2K	7280SR	7280SRAM	7500R2	7516N	
7280CR2M	7280SR2	7280SRM	7504	7500R2A	
7280CRA	7280SR2A	7280TR	7504N	7500R2AK	

18.2.2 Operation

A Virtual Private Network, or VPN, is a set of geographically dispersed sites attached to the Service Provider's (SP) backbone, with IP interconnectivity amongst the sites. Using this scenario, the customer can obtain "VPN service" from the SP. The SP will provide a VPN service to multiple customers, using this common backbone network infrastructure. The sample VPN topology diagram below illustrates three sites where a customer is being interconnected over the SP backbone network.

At each site, the Customer Edge router (CE) attaches to the Provider's Edge router (PE). The CE can attach to more than one PE, and in these cases the CE is said to be "multi-homed". The routers in the SP core network, those which do not attach to any CE, are referred to as "P" routers. The "P" routers do not need to know about the customer routes.

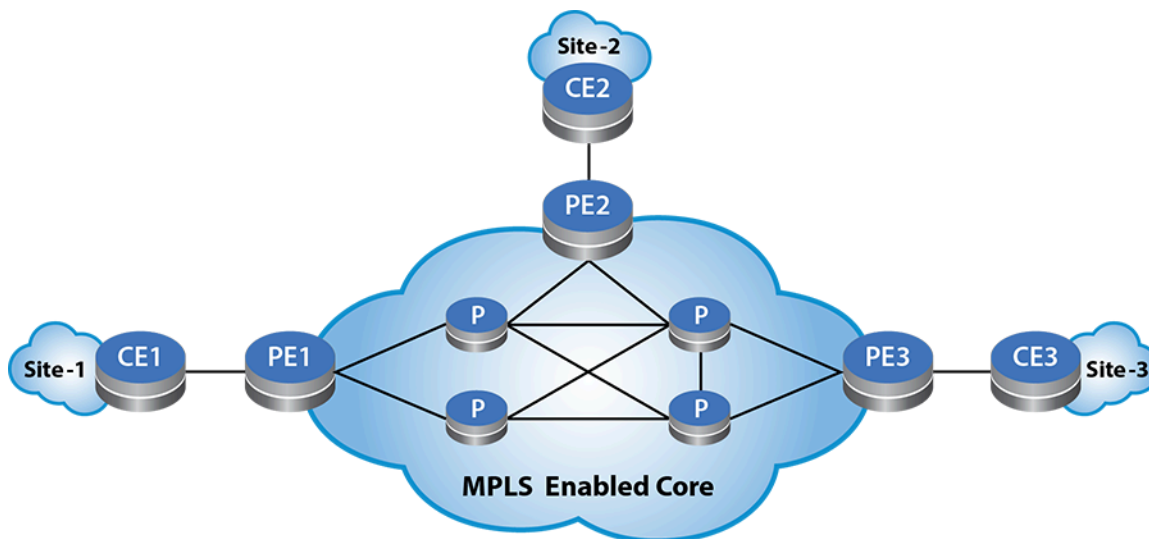

Figure 137: MPLS Enabled Core Schematic

The CE attaches to PE in a VRF. The routes learned from the CE are programmed in the corresponding VRF and the PE then distributes the routes to other PEs as "VPN routes" using MP-BGP. This is done by using two new BGP address families, VPN-IPv4 (AFI=1, SAFI=128) and VPN-IPv6 (AFI=2, SAFI=128).

On the PEs, corresponding to the VPN, VRFs configure with the RD and one or more import and export RTs. The RD attaches to the customer route to create a VPN route. By picking a unique RD for each VRF and attaching it to the customer route, the VPN route is unique. This allows for customers with overlapping IP addresses to be managed by the Service Provider. This unique VPN route is advertised to other PEs along with the configured export RT and the VPN label. The PE router allocates a VPN label per VRF and address family. The PE router programs its Label FIB (LFIB) with this label information. When the PE router receives an incoming MPLS packet with the VPN label as the topmost label, it pops the label and does an IP lookup in the associated VRF. The PE router also maintains a mapping of import RTs to the corresponding VRFs. This mapping is used later when deciding into which VRFs a received VPN route should be imported into.

The PE learns customer routes from the CE through the PE-CE routing protocol, which could be Static routing, EBGP, OSPF, or ISIS. The PE will install those customer routes in the associated VRF, with the CE as the next hop. The customer routes in the VRF are exported into the BGP VPN table as VPN routes, along with the VPN label and the configured export RTs as BGP path attributes. These VPN routes are then advertised to other PEs which have been activated for the VPN address-families (VPN-IPv4/VPN-IPv6). The PE then sets itself as the next hop while advertising the VPN routes. The PE which receives those VPN routes strips out the RD and import them as IPv4 or IPv6 routes into the VRFs. The list of VRFs into which the route is imported is determined based on the mapping of import RTs to VRFs. These routes will be programmed into the FIB along with the VPN label and the remote PE as the next hop. Once these routes are installed in the VRF, the CE connected to that VRF

will learn those routes (based on the PE-CE routing protocol) and make it available in the customer network that it is attached to. This way the geographically dispersed customer sites learn of each other's networks and IP reachability is established between them.

18.2.2.1 Forwarding

In the Service Provider's core network there should be MPLS LSPs between the PEs. That is, the connection to the VPN next-hop should be over an MPLS tunnel. The MPLS LSPs in the core could be setup using RSVP-TE or LDP in conjunction with OSPF/ISIS or ISIS-SR.

When the PE receives an IP packet from the CE destined to the remote site, it does an IP lookup in the VRF to which the CE is connected. This lookup provides the VPN label to be used and the nexthop, which would be the remote-PE. The VPN label is imposed on the IP packet and the resulting MPLS packet is then tunneled through the MPLS LSP to the remote PE. As result of penultimate hop popping, the MPLS packet arrives at the remote PE with the VPN label as the topmost label. The label lookup results in the VPN label being popped and an IP lookup will be done in the associated VRF. Note that the PE would have programmed this label action when it allocated the label to start with. That IP lookup will result in the IP packet being forwarded out to the CE.

18.2.3 Configuration

Configuring BGP/MPLS L3 VPN involves enabling the SP core for MPLS and then configuring the PEs with the required BGP configuration.

It is assumed that the SP core network is enabled for MPLS. This involves configuring an IGP (OSPF/ISIS) followed by a label distribution protocol such as LDP, RSVP-TE or ISIS-SR. Typically, loopback interfaces are configured on all the PE and the P routers and the IGP's exchange reachability to those loopback interfaces. And then the MPLS Label Distribution Protocol will set up MPLS LSPs/tunnels between all those loopbacks.

This section includes the following topics:

- [LDP Hello Redundancy](#)
- [Enabling BGP to Exchange the Routing Tables with the Peer](#)
- [Configuring the VRF Information](#)
- [Configuring the Route Distinguisher](#)
- [Configuring Route Targets](#)
- [Configuring Import / Export Route-maps](#)
- [VPN Next-hop](#)

Enabling MPLS and LDP on the PE involves the following steps:

1. Configure terminal.

```
switch#configure terminal
```

2. Enter the **Loopback0** interface config mode.

```
switch(config)#interface Loopback0
```

3. Enter destination IP address.

```
switch(config)#ip address 11.0.0.1/32
```

4. Enable MPLS routing.

```
switch(config)#mpls ip
```

5. Configure MPLS LDP.

```
switch(config)#mpls ldp
```

6. Configure the router ID interface.

```
switch(config-mpls-ldp)#router-id interface Loopback0
```

7. Configure for no shutdown.

```
switch(config-mpls-ldp)#no shutdown
```

Example:

```
switch#configure terminal
switch(config)#interface Loopback0
switch(config-if)#ip address 11.0.0.1/32
switch(config)#mpls ip
switch(config)#mpls ldp
switch(config-mpls-ldp)#router-id interface Loopback0
switch(config-mpls-ldp)#no shutdown
```

18.2.3.1 LDP Hello Redundancy

LDP Hello Redundancy establishes a redundant target Hello adjacency for each neighbor discovered through the Basic Discovery Mechanism using the LDP Extended Discovery mechanism. For the mechanism to work, the following must be true:

- Devices must have a loopback interface configured to serve as the transport address interface, which must be routable through all interfaces on the device.
- Devices must be reachable via a redundant path through other devices on the network.
- Both devices must have Hello Redundancy configured or the targeted Hello messages will be ignored.

After a Hello adjacency is established using LDP Basic Discovery, devices with Hello Redundancy will start sending Targeted Hello messages to the Transport Address found in the received Link Hello message of Basic Discovery. The Targeted Hello adjacency can support the session established between peers even when all Link Hello adjacencies have timed out. The FEC label bindings between two peers with no Link Hello adjacency will not be active because the Interior Gateway Protocol will not use the other peer as the next hop. Maintaining the FEC label bindings and the session between the two peers can save significant time when the Link Hello adjacency is reestablished.

The `neighbor hello-redundancy` command configures Hello Redundancy on all platforms under the LDP configuration mode. If a Link Hello adjacency is restored within 600 seconds of being lost, the Target Hello adjacency and the session associated with it will be dropped. The timeout can be configured using the **duration** option of the command. An infinite value for the **duration** disables the timeout.

Configuration for LDP Hello Redundancy

The following example is applicable to all platforms.

These commands enable Targeted Hello redundancy with a duration of 300 seconds.

```
switch(config-mpls-ldp)#neighbor hello-redundancy
switch(config-mpls-ldp)#neighbor hello-redundancy duration 300
```

Either of the following commands in the example below disable Hello Redundancy.

```
switch(config-mpls-ldp)#neighbor hello-redundancy none
switch(config-mpls-ldp)#default neighbor hello-redundancy
```

The following command shows the Targeted Hello adjacencies established.

```
switch(config)#show mpls ldp discovery detail
LDP MD5 Password Not Set
Local LDP Identifier: 2.2.2.2:0
Discovery Sources:
  Interfaces:
    Ethernet1 (ldp):
      Hello interval: 5 sec; Source IP addr: 192.168.2.1
      LDP ID: 3.3.3.3:0
      Source IP addr: 192.168.2.2; Transport IP addr: 3.3.3.3
      Hold time: 15 sec; Proposed local/peer: 15/15 sec; Expires
in: 11.96 sec
    Ethernet2 (ldp):
      Hello interval: 5 sec; Source IP addr: 192.168.1.2
      LDP ID: 1.1.1.1:0
      Source IP addr: 192.168.1.1; Transport IP addr: 1.1.1.1
      Hold time: 15 sec; Proposed local/peer: 15/15 sec; Expires
in: 12.00 sec
  Targeted Hellos:
    Targeted neighbor 1.1.1.1:
      Hello interval: 15 sec; Source IP addr: 2.2.2.2
      LDP ID: 1.1.1.1:0
      Source IP addr: 1.1.1.1; Transport IP addr: 1.1.1.1
      Hold time: 45 sec; Proposed local/peer: 45/45 sec; Expires
in: 40.78 sec
      Target configuration source: Hello Redundancy
    Targeted neighbor 3.3.3.3:
      Hello interval: 15 sec; Source IP addr: 2.2.2.2
      LDP ID: 3.3.3.3:0
      Source IP addr: 3.3.3.3; Transport IP addr: 3.3.3.3
      Hold time: 45 sec; Proposed local/peer: 45/45 sec; Expires
in: 35.89 sec
      Target configuration source: Hello Redundancy
```

18.2.3.2 Enabling BGP to Exchange the Routing Tables with the Peer

- Enabling the send-community extended knob on the neighbor. This essentially enables BGP to exchange the RTs with the peer.
 - Activating the peer (the remote PE) under the address-family VPN-IPv4 and address-family VPN-IPv6 modes enables BGP to negotiate the MPLS L3 VPN address families.
 - Specify the address for the VPN next-hop using the command, neighbor default encapsulation mpls next-hop-self source-interface Loopback0.

In the preceding configuration example, the system uses the address *11.0.0.1* from interface *Loopback0* as the nexthop in the VPN route advertisements.

18.2.3.3 Configuring the VRF Information

First, the VRF must be configured in the global mode and IPv4 and IPv6 routing must be enabled in the VRF. After that, under the router bgp mode, we need to configure the VRF and provide the information related to RD and import and export RTs.

1. Configure terminal.

```
switch#configure terminal
```

2. Enable IP routing.

```
switch(config)#ip routing
```

3. Enable IP routing for the VRF.

```
switch(config)#ip routing vrf vrf1
```

4. Enable IPv6 routing for the VRF.

```
switch(config)#ipv6 unicast-routing vrf vrf1
```

```
switch#configure terminal
switch(config)#ip routing
switch(config)#ip routing vrf vrf1
switch(config)#ipv6 unicast-routing vrf vrf1
```

The VRF configuration under router BGP mode is shown below.

```
switch(config-router-bgp-vrf-vrf1)#show active
router bgp 300
  vrf vrf1
    rd 11.0.0.1:0
    route-target import vpn-ipv6 300:0
    route-target import vpn-ipv4 300:0
    route-target import vpn-ipv4 300:0
    route-target import vpn-ipv4 300:0
    route-target export vpn-ipv6 300:0
    route-target export vpn-ipv4 300:0
    redistribute connected
    redistribute static
switch(config-router-bgp-vrf-vrf1)#
```

18.2.3.4 Configuring the Route Distinguisher

The Route Distinguisher (RD) is structured such that it can be easily configured and managed. It is configured by specifying two fields separated by a colon, as in administrative-subfield: assigned-number-subfield.

The administrative subfield could contain either an IP address, as shown in the example (the PEs loopback address), or the AS number. The assigned-number-subfield can be any number which is determined by the SP. The primary requirement of the RD is that it must be unique per VRF. It is possible to have overlapping address space between VRFs, the intent of the RD is to ensure that a VPN route can be uniquely identified as it is received by a remote PE. However, the identification of which VRF(s) the received VPN route should be imported into is handled by the import RTs configured on the remote PE.

18.2.3.5 Configuring Route Targets

Next is the import and export Route Target configuration. The RTs are structured similar to the RDs. They too are made up of administrative-subfield: assigned-number-subfield. In the example shown, the AS number has been used as the administrative subfield. And the value 0 has been used for the assigned number subfield. It is the RT that plays an important role in identifying the VPN.

- Received VPN routes with the import RT as path attributes will be imported into the VRF will have RTs has extended-community BGP path attributes. They will be imported into VRFs which import RT configuration for RTs in the received VPN route.
- And while advertising the routes from the VRF as VPN routes, the export RT will be attached to the route as an extended-community BGP attribute.
 1. In the example, the connected and static routes in the VRF are redistributed into BGP. And these routes will be exported as VPN routes.
 2. It is also possible to have a BGP session with the CE. In that case, routes received over that session are exported as VPN routes. And imported routes are advertised to the CE.

18.2.3.6 Configuring Import / Export Route-maps

The routes that are imported into a VRF can be further controlled by applying an import route-map. And the routes that are exported from the VRF can be controlled by applying an export route-map.

Complete the following steps:

1. Configure terminal.

```
switch#configure terminal
```

2. Configure BGP. In this example, BGP is configured AS 4274781899.

```
switch(config)#router bgp 4274781899
```

3. Configure the VRF under router bgp mode.

```
switch(config-router-bgp)#vrf vrf1
```

4. Select the BGP route distinguisher. In this example, 36351:268450419 is selected.

```
switch(config-router-bgp-vrf-vrf1)#rd 36351:268450419
```

5. Configure the import route-target VPN-IPv4, unicast address family. In this example, 36351:1001 is selected.

```
switch(config-router-bgp-vrf-vrf1)#route-target import vpn-ipv4 36351:1001
```

6. Configure another import route-target for VPN-IPv4 unicast address family. In this example, 36351:268450419 is selected.

```
switch(config-router-bgp-vrf-vrf1)#route-target import vpn-ipv4 36351:268450419
```

7. Configure the export route-target for VPN-IPv4 unicast address family. In this example, 36351:268450419 is selected.

```
switch(config-router-bgp-vrf-vrf1)#route-target export vpn-ipv4 36351:268450419
```

8. Configure the import route-map. In this example, the import router-map name is *BGP-IMPORT-VRF-SERVICES*.

```
switch(config-router-bgp-vrf-vrf1)#route-target import vpn-ipv4 route-map BGP-IMPORT-VRF-SERVICES
```

9. Configure the export route-map. In this example, the export route-map name is *BGP-EXPORT-VRF-VRF1*.

```
switch(config-router-bgp-vrf-vrf1)#route-target export vpn-ipv4 route-  
map BGP-EXPORT-VRF-VRF1
```

10. Optionally, redistribute connected routes in the VRF into BGP, with the associated route-map *BGP-ANNOUNCE-CONNECTED*.

```
switch(config-router-bgp-vrf-vrf1)#redistribute connected route-map  
BGP-ANNOUNCE-CONNECTED
```

11. Optionally, redistribute static routes in the vrf into BGP, with associated route-map *BGP-ANNOUNCE-STATIC*.

```
switch(config-router-bgp-vrf-vrf1)#redistribute static route-map BGP-  
ANNOUNCE-STATIC
```

12. The import and export route-maps should be separately configured. The configuration snippet below shows the configuration of the same route-map *BGP-IMPORT-VRF-SERVICES*.

```
switch(config-router-bgp-vrf-vrf1)#route-map BGP-IMPORT-VRF-SERVICES  
permit 10  
switch(config-route-map-BGP-IMPORT-VRF-SERVICES)#match extcommunity  
SERVICES  
switch(config-route-map-BGP-IMPORT-VRF-SERVICES)#match ip address  
prefix-list SERVICES
```

Example:

```
switch#configure terminal  
switch(config)#router bgp 4274781899  
switch(config-router-bgp)#vrf vrf1  
switch(config-router-bgp-vrf-vrf1)#rd 36351:268450419  
switch(config-router-bgp-vrf-vrf1)#route-target import vpn-ipv4  
36351:1001  
switch(config-router-bgp-vrf-vrf1)#route-target import vpn-ipv4  
36351:268450419  
switch(config-router-bgp-vrf-vrf1)#route-target export vpn-ipv4  
36351:268450419  
switch(config-router-bgp-vrf-vrf1)#route-target import vpn-ipv4  
route-map BGP-IMPORT-VRF-SERVICES  
switch(config-router-bgp-vrf-vrf1)#route-target export vpn-ipv4  
route-map BGP-EXPORT-VRF-VRF1  
switch(config-router-bgp-vrf-vrf1)#redistribute connected route-  
map BGP-ANNOUNCE-CONNECTED  
switch(config-router-bgp-vrf-vrf1)#redistribute static route-map  
BGP-ANNOUNCE-STATIC  
switch(config-router-bgp-vrf-vrf1)#route-map BGP-IMPORT-VRF-  
SERVICES permit 10  
switch(config-route-map-BGP-IMPORT-VRF-SERVICES)#match  
extcommunity SERVICES  
switch(config-route-map-BGP-IMPORT-VRF-SERVICES)#match ip address  
prefix-list SERVICES
```

18.2.3.7 VPN Next-hop

By default, the system uses the source address of the BGP session as the nexthop in the VPN advertisements. This source address is determined by the system while establishing the TCP session between the PEs. If the SP want to use a different address as the VPN next-hop, then an interface with that address must be specified under the BGP address-family VPN-IPv4 or address-family VPN-IPv6 configuration modes. For example,

```
switch(config-router-bgp) #address-family vpn-ipv4
switch(config-router-bgp-af) #neighbor 10.0.0.2 activate
switch(config-router-bgp-af) #neighbor default encapsulation mpls next-
hop-self
source-interface Loopback0
```

```
switch(config-router-bgp) #address-family vpn-ipv6
switch(config-router-bgp-af) #neighbor 10.0.0.2 activate
switch(config-router-bgp-af) #neighbor default encapsulation mpls next-
hop-self
source-interface Loopback0
```

In the previous example, the interface **Loopback 0** has been specified. The system picks the VPN next-hop address from the interface based on the following rules:

- For VPN-IPv4, the IPv4 address from the interface is picked.
- For VPN-IPv6,
 - For an IPv4 peer,
 - Pick the IPv4 address from the interface.
 - If the interface does not have a IPv4 address, pick the IPv6 address.
 - For an IPv6 peer,
 - Pick the IPv6 address from the interface.
 - If the interface does not have an IPv6 address, pick the IPv4 address.

For VPN-IPv6, when an IPv4 address is picked as the next-hop, it is encoded as a IPv4-mapped IPv6 address in the VPN route advertisement. This is as per RFC 4659.

18.2.4 Show Commands

Use the **show bgp instance vrf vrf1** command to show the BGP instance status for a specific VRF to verify the route-targets and import/export route-maps being used. The command also displays the locally allocated MPLS label that the system has allocated for IPv4 and IPv6.

```
switch#show bgp instance vrf vrf1
BGP instance information for VRF vrf1
BGP Local AS: 4274781899, Router ID: 169.254.156.10
Total peers:                                0
  Static peers:                             0
  Dynamic peers:                            0
  Disabled peers:                           0
  Established peers:                         0
Four Octet ASN mode enabled
Graceful restart helper mode disabled
Graceful restart mode disabled
Graceful restart timer timeout: 00:05:00
End of rib timer timeout: 00:05:00
Attributes of the reflected routes are not preserved
UCMP mode: disabled
Peer mac resolution timeout: 00:00:00
```

```

BGP IPv4 Listen Port Status: listening on port 179
BGP IPv6 Listen Port Status: listening on port 179
BGP Convergence information:
  BGP has converged:   yes,      Time taken to converge: 00:00:31
  Outstanding EORs:   0,        Outstanding Keepalives: 0
  Convergence timeout: 00:05:00
BGP Convergence timer is inactive
BGP Convergence based update synchronization is disabled
BGP Convergence slow-peer timeout: 00:01:30
Address-family IPv4 Unicast:
  Redistributed routes into BGP:
    Static
    Connected
  Route Distinguisher: 36351:268450419
  Route targets to import:
    VPN-IPv4:
      36351:1001
      36351:268450419
  Route targets to export:
    VPN-IPv4:
      36351:268450419
  Route maps to apply on import:
    VPN-IPv4: BGP-IMPORT-VRF-SERVICES
  Route maps to apply on export:
    VPN-IPv4: BGP-EXPORT-VRF-DI-0056
  Local IP lookup MPLS VRF label: 135275
  Additional-paths installation is disabled
  Extended next-hop capability is disabled
Address-family IPv6 Unicast:
  Redistributed routes into BGP:
    Static
    Connected
  Route Distinguisher: 36351:268450419
  Route targets to import:
    VPN-IPv6:
      36351:1001
  Route targets to export:
    VPN-IPv6:
      36351:268450419
  Local IP lookup MPLS VRF label: 135896
  Additional-paths installation is disabled

```

Use the **show bgp neighbors** command to verify that the VPN address families have negotiated with the neighbor.

```

switch#show bgp neighbors
BGP neighbor is 10.0.0.2, remote AS 300, internal link
  BGP version 4, remote router ID 0.0.1.1, VRF default
  Last read 00:00:15, last write 00:00:31
  Hold time is 180, keepalive interval is 60 seconds
  Configured hold time is 180, keepalive interval is 60 seconds
  Hold timer is active, time left: 00:02:02
  Keepalive timer is active, time left: 00:00:16
  Connect timer is inactive
  Idle-restart timer is inactive
  BGP state is Established, up for 00:44:18
  Number of transitions to established: 1
  Last state was OpenConfirm
  Last event was HoldTime
  Neighbor Capabilities:
    Multiprotocol IPv4 Unicast: advertised and received and negotiated
    Multiprotocol VPN-IPv4: advertised and received and negotiated
    Multiprotocol VPN-IPv6: advertised and received and negotiated

```



```

Four Octet ASN: advertised and received and negotiated
Route Refresh: advertised and received and negotiated
Send End-of-RIB messages: advertised and received and negotiated
Additional-paths rcv capability:
  IPv4 Unicast: advertised
  VPN-IPv4: advertised
  VPN-IPv6: advertised
Additional-paths send capability:
  IPv4 Unicast: received
  VPN-IPv4: received
  VPN-IPv6: received
Restart timer is inactive
End of rib timer is inactive
  IPv4 Unicast End-of-RIB received: Yes
  VPN-IPv4 End-of-RIB received: Yes
  VPN-IPv6 End-of-RIB received: Yes
Message Statistics:
      Sent      Rcvd
Opens:          1        1
Notifications: 0         0
Updates:        6         6
Keepalives:    53        54
Route-Refresh: 0         0
Total messages: 60        61
Prefix Statistics:
      Sent      Rcvd
IPv4 Unicast:  1         1
IPv6 Unicast:  0         0
Configured maximum total number of routes is 12000
Inbound updates dropped by reason:
  AS path loop detection: 0
  Malformed MPBGP routes: 0
  Originator ID matches local router ID: 0
  Nexthop matches local IP address: 0
Local AS is 300, local router ID 0.0.0.1
Local TCP address is 10.0.0.1, local port is 179
Remote TCP address is 10.0.0.2, remote port is 47400

```

Use the **show bgp vpn-ipv4 summary** command to show the status of VPN-IPv4 peers. While the examples below are with respect to VPN-IPv4, the same set of commands are applicable to VPN-IPv6.

```

switch#show bgp vpn-ipv4 summary
BGP summary information for VRF default
Router identifier 0.0.0.1, local AS number 300
Neighbor Status Codes: m - Under maintenance
Neighbor  V AS  MsgRcvd  MsgSent  InQ  OutQ  Up/Down  State  PfxRcd  PfxAcc
10.0.0.2  4 300  3379    60      0    0    1d23h   Estab  1      1

```

Use the **show bgp vpn-ipv4** command to show how the VPN-IPv4 routes sent and received.

```

switch#show bgp vpn-ipv4
BGP routing table information for VRF default
Router identifier 0.0.0.1, local AS number 300
Route status codes: s - suppressed, * - valid, > - active, # - not
installed, E -
ECMP head, e - ECMP
                S - Stale, c - Contributing to ECMP, b - backup
                % - Pending BGP convergence
Origin codes: i - IGP, e - EGP, ? - incomplete
AS Path Attributes: Or-ID - Originator ID, C-LST - Cluster List, LL Nexthop-
Link

```

Local	Nexthop	Network	Next Hop	Metric	LocPref	Weight	Path
* >		RD: 11.0.0.1:0 IPv4	prefix 20.0.0.0/24	-	-	0	i
* >		RD: 11.0.1.1:0 IPv4	prefix 20.0.1.0/24	-	0		i
		11.0.1.1	-	100	0		i

Each entry in the output represent a VPN path in the VPN table. For each VPN path, the RD and actual prefix along with the nexthop information is shown. Paths in the VPN table are either received from other VPN-IPv4 peers (other PEs) or exported from local VRFs.

In the above output, **20.0.0.0/24** is a local route that has been exported. Notice that it has been prepended with the RD **11.0.0.1:0** to make it a VPN-IPv4 route. And the prefix of **20.0.1.0/24** has been received from another PE. It has the RD of **11.0.1.1:0** with a nexthop of **11.0.1.1**. Looking at each of those prefixes in detail:

20.0.0.0/24 is a local route from one of the VRFs that has been exported. Notice that along with the prefix, the RD, the export RT and the MPLS label information is displayed. In this case, the MPLS label is a locally allocated label.

```
switch#show bgp vpn-ipv4 20.0.1.0/24
BGP routing table information for VRF default
Router identifier 0.0.0.1, local AS number 300
BGP routing table entry for IPv4 prefix 20.0.1.0/24, Route Distinguisher
:
11.0.1.1:0
  Paths: 1 available
    Local
      11.0.1.1 from 10.0.0.2 (0.0.1.1)
        Origin IGP, metric -, localpref 100, weight 0, valid, internal,
        best
        Extended Community: Route-Target-AS:300:0
        MPLS label: 100123
```

20.0.1.0/24 is a prefix that has been received from the VPN-IPv4 peer, **10.0.0.2**. The next-hop in this case is **11.0.1.1**. This VPN route is imported into a VRF based on the import RT configuration matching the RT received in the VPN route (**300:0**).

 **Note:** Route-Distinguishers for the non-default VRFs must be configured under the **router bgp** mode. Route-Distinguisher configured under the VRF definition mode are ignored.

The route is installed in the VRF only when the VPN next-hop is reachable through an MPLS tunnel. The presence of such an MPLS tunnel can be verified using the **show tunnel fib** command. The output below shows that there is an MPLS tunnel setup by LDP to the VPN nexthop **11.0.1.1**.

```
switch#show tunnel fib
Type 'LDP', index 1, endpoint 11.0.1.1/32, forwarding None
  via 10.0.0.2, 'Ethernet6'
  label stack 3
```

Use the **show ip bgp vrf vrf1** command to show the BGP table for the VRF which contains the imported VPN-IPv4 route.

```
switch#show ip bgp vrf vrf1
BGP routing table information for VRF vrf1
Router identifier 11.0.0.1, local AS number 300
Route status codes:s-suppressed,*-valid,>-active,#-not installed, E-ECMP
  head,e-ECMP
      S - Stale, c - Contributing to ECMP, b - backup, L - labeled-unicast
      % - Pending BGP convergence
Origin codes: i-IGP, e-EGP, ?-incomplete
```

```
AS Path Attributes: Or-ID-Originator ID, C-LST-Cluster List, LL Nexthop-
Link Local Nexthop
```

	Network	Next Hop	Metric	LocPref	Weight	Path
* >	20.0.0.0/24	-	-	-	0	i
* >	20.0.1.0/24	11.0.1.1	-	100	0	i

Each entry in the table represents a path either locally redistributed/received into the VRF (from a BGP peer) or imported from the VPN table.

Use the **show ip bgp 20.0.1.0/24 vrf vrf1** command for a more detailed view of the imported IP prefix **20.0.1.0/24**:

```
switch#show ip bgp 20.0.1.0/24 vrf vrf1
BGP routing table information for VRF vrf1
Router identifier 11.0.0.1, local AS number 300
BGP routing table entry for 20.0.1.0/24
  Paths: 1 available
    Local
      11.0.1.1 from 10.0.0.2 (0.0.1.1), imported VPN-IPv4 route, RD
      11.0.1.1:0
        Origin IGP, metric -, localpref 100, weight 0, valid, internal,
        best
        Extended Community: Route-Target-AS:300:0
        Remote MPLS label: 100123
```

Use the **show ip route vrf vrf1** command to view the prefix installed in route table of the VRF:

```
switch#show ip route vrf vrf1
VRF: vrf1
Codes: C - connected, S - static, K - kernel,
        O - OSPF, IA - OSPF inter area, E1 - OSPF external type 1,
        E2 - OSPF external type 2, N1 - OSPF NSSA external type 1,
        N2 - OSPF NSSA external type2, B I - iBGP, B E - eBGP,
        R - RIP, I L1 - IS-IS level 1, I L2 - IS-IS level 2,
        O3 - OSPFv3, A B - BGP Aggregate, A O - OSPF Summary,
        NG - Nexthop Group Static Route, V - VXLAN Control Service,
        DH - DHCP client installed default route, M - Martian,
        DP - Dynamic Policy Route
Gateway of last resort is not set
C      20.0.0.0/24 is directly connected, Ethernet5
B I    20.0.1.0/24 [200/0] via 11.0.1.1/32,LDP tunnel index 1,label
100123
                                     via 10.0.0.2,Ethernet3,label imp-null(3)
```

The output displays both the VPN label, as well as the underlay tunnel (LDP) information.

18.2.5 Limitations

- While configuring a BGP Route-Reflector for the VPN-IPv4/VPN-IPv6 address families, the route-reflector must have transport MPLS LSPs to reach the PE nexthop addresses. Even though the route-reflector may not be in the data path and does not use the transport LSPs to forward traffic, the LSPs are required in order for the BGP nexthops to be considered as reachable valid candidates in the bestpath computation.
- When configuring eBGP peers, which receive routes over an eBGP session and re-advertise the same to a different eBGP peer, next-hop-unchanged knob must be configured, so that the original nexthop is retained.
- With iBGP route-reflector topology, next-hop-self knob must not be configured.

- Even with directly connected PEs, the VPN nexthops should be the loopback on the directly connected PEs with an MPLS tunnel between them.
 - For a VPN route to be installed in the VRF, the VPN nexthop must resolve over a MPLS tunnel.
- With OSPF as the PE-CE protocol, RFC 4576, setting of the DN bit in the LSA, is not supported.
- Internal BGP (iBGP) as the PE-CE protocol, RFC 6368, is not supported.

18.3 EVPN MPLS Shared ESI Label

In a multihomed EVPN MPLS configuration, BUM packets sent from a non-designated forwarder (Non-DF) PE to a designated forwarder (DF) PE must carry the ESI label advertised by the egress DF PE. When the egress DF PE receives a packet with the ESI label that it has advertised, it does not forward the packet on the ethernet segment (ES) corresponding to that ESI label. This avoids sending the packet back to the same ES from which the BUM packet originated.

However, when a DF election is triggered, a PE may change its role from being Non-DF to DF. Since the DF election is run on each PE distributively, some PE(s) may not have updated their view of the new DF PE and add no ESI label in the BUM packet. In such a case, the BUM packets in transit may get sent back to the same ES where they originated. To overcome this, ESI labels are included to Non-DF PEs as well. This shared ESI label provides a mechanism to achieve sending ESI label to Non-DF PEs on platforms which cannot support sending different ESI labels to its multihomed peers.

Platform Compatibility

- DCS-7280R
- DCS-7280R2
- DCS-7500R
- DCS-7500R2
- DCS-7020

18.3.1 Configuring EVPN MPLS Shared ESI Label

An ethernet-segment (ES) must be configured with a shared-index to allocate an ESI label value based on the shared-index configuration.

Example

```
switch(config)#interface Ethernet4
switch(config-if-Et1)#switchport access vlan 1000
switch(config-if-Et1)#evpn ethernet-segment
switch(config-evpn-es)#identifier 0022:2222:2222:2222:2222
switch(config-evpn-es)#mpls shared index 100
switch(config-evpn-es)#route-target import 00:02:00:02:00:02
```

- If all PEs which are provisioned with the same ES carry the same shared-index value, then they will allocate the same ESI label value for that ethernet-segment.
- Having this configuration consistent on all PEs will enable the hardware to encapsulate the ESI label on all BUM packets towards its multi-homed peers. This is essential to implement split-horizon filtering during DF role change events.
- The shared index value is used as an offset into the reserved “l2evpn ethernet-segment” range where the label value is derived as follows:
 - ESI label = label-range base value + shared-index value – 1

The ESI labels are allocated from **l2evpn ethernet-segment** label range which has a **default configuration** as shown below.

```
switch# show running-config all
```

```

mpls label range bgp-sr 900000 65536
mpls label range dynamic 100000 262144
mpls label range isis-sr 900000 65536
mpls label range l2evpn 1036288 12288
mpls label range l2evpn ethernet-segment 1031072 1024
mpls label range srlb 965536 65536
mpls label range static 16 99984

```

18.3.2 EVPN MPLS Shared ESI Label Show Commands

The following show command displays the operational state on whether the ESI label is shared amongst all the PEs in that ethernet-segment:

Example

```

switch# show bgp evpn instance
EVPN instance: VLAN 1000
Route distinguisher: 100.0.0.1:1000
Route target import: Route-Target-AS:64500:1000
Route target export: Route-Target-AS:64500:1000
Service interface: VLAN-based
Local IP address: 100.0.0.1
Encapsulation type: MPLS
Label allocation mode: per-instance
MAC route label: 1040210
IMET route label: 1042201
AD route label: 1040210
Local ethernet segment:
  ESI: 0022:2222:2222:2222:2222
  Interface: Ethernet4
  Mode: all-active
  State: up
  ESI label: 1031171
  Shared ESI label: on
  ES-Import RT: 00:02:00:02:00:02
  Designated forwarder: 100.0.0.1
  Non-Designated forwarder: 100.0.0.2

```

- Shared ESI label state for an ES is **ON** when the following conditions are satisfied.
 - ES is configured with shared-index i.e, **mpls shared index <value>**.
 - All PEs in that ES carry the same ESI label.
- **l2evpn shared ethernet-segment** label range space can be looked up using the command below:

```

switch# show mpls label ranges
Start      End        Size      Usage
-----
0          15         16        reserved
16         99999     99984     static mpls
100000    116383    16384     ldp (dynamic)
116384    132767    16384     bgp (dynamic)
132768    362143    229376    free (dynamic)
362144    899999    537856    unassigned
900000    965535    65536     isis-sr
900000    965535    65536     bgp-sr
965536    1031071   65536     srlb
1031072  1032095  1024      l2evpn shared ethernet-segment
1032096    1036287   4192     unassigned
1036288    1048575   12288    l2evpn

```

18.3.3 Troubleshooting

When the local PE's ethernet-segment is configured with **mpls shared index <value>**, but **show bgp evpn instance** indicates that **Shared ESI label: off**, then we need to check these states:

- Ensure all multi-homed PEs have consistent “mpls shared index <value>” configuration i.e, same shared-index value.
- Verify that “I2evpn ethernet-segment” label range size is at least 1024. Configuring a non-default label range whose size is less than the default value will cause the ESI labels to be de-allocated.

18.3.4 Limitations

When the PE switch is multihomed to more than six PEs and each one of those PEs have an ethernet segment in shared ESI configuration, the PE switch may not be able to push the ESI label into the MPLS label stack of BUM packets ingressing on every ethernet segment. In such a case, the syslog `EVPN-3-MPLS_SHARED_ESI_HW_RESOURCE_FULL` is emitted.

18.4 RSVP-TE LSR

RSVP-TE applies the Resource Reservation Protocol (RSVP) for Traffic Engineering (TE), that is, to distribute MPLS labels for steering traffic and reserving bandwidth.

The EOS implementation supports:

- RSVP-TE core protocol (*RFC 2205, RFC 3209*), transit role
- Hello messages (*RFC 3209*)
- Refresh overhead reduction (*RFC 2961*)
- Cryptographic authentication (*RFC 2747*)
- Fast Reroute: facility backup, link-protection/NHOP (*RFC 4090*)
- LSP Ping/Traceroute (*RFC 4379*)
- Fast Reroute node-protection (Starting in *EOS Release 4.22.1F*)
- Bandwidth management (Starting in *EOS Release 4.22.1F*)
- SRLG for Fast Reroute (Starting in *EOS Release 4.23.1F*)
- MTU signaling (Starting in *EOS Release 4.23.1F*)
- Soft preemption (Starting in *EOS Release 4.23.1F*)
- Support for OSPFv2 as the IGP (Starting in *EOS Release 4.24.2F*)
- Support for LDP entropy label (Starting in *EOS Release 4.26.0F, RFC 6790*)

18.4.1 Platform Compatibility

RSVP-TE is supported on the Arista 7500R and the 7280R family of switches.

18.4.2 RSVP-TE LSR Configuration

There is a dedicated configuration sub-mode for RSVP:

```
(config) #mpls rsvp
(config-mpls-rsvp) #
```

18.4.2.1 Enabling RSVP-TE

Enable RSVP-TE globally by issuing **no shutdown** in the configuration sub-mode. This is the only mandatory setting for RSVP-TE to work. This also globally enables MPLS.

```
(config-mpls-rsvp) #no shutdown
```

To disable RSVP-TE, use the **shutdown** command, which is the default.

```
(config-mpls-rsvp) #shutdown
```

There is no per-interface knob to enable and disable RSVP. However, you can only enable RSVP on interfaces that MPLS is also enabled.

18.4.2.2 State Refresh Parameter

You can configure the state refresh interval. It describes parameter R in seconds, leading to a state refresh (Path and Resv messages) every $0.5 \cdot R$ to $1.5 \cdot R$ seconds (randomly chosen). The default value is 30 seconds.

```
(config-mpls-rsvp) #refresh interval 30
```

18.4.2.3 Hello Messages

To configure the Hello message interval (sec) and timeout multiplier (integer), refer to the following example.

In this example, hello messages are sent to all known neighbors every 10 seconds. If no hello responses are received from a neighbor for $4 \cdot 10 = 40$ seconds, communication is considered to be lost and the neighbor is reset.

```
(config-mpls-rsvp) #hello interval 10 multiplier 4
```

The default of 10 seconds with multiplier 4 can be reset with:

```
(config-mpls-rsvp) #default hello interval
```

To explicitly disable Hello messages, use the following command:

```
(config-mpls-rsvp) #no hello interval
```

18.4.2.4 Refresh Overhead Reduction

Setting the refresh method to **bundled** enables the Refresh Overhead Reduction (*RFC 2961*) that supports the sending of message IDs and refreshing state with refresh messages.

```
(config-mpls-rsvp) #refresh method bundled
```

This is also the default setting. To turn off refresh overhead reduction, use **explicit**.

```
(config-mpls-rsvp) #refresh method explicit
```

18.4.2.5 Cryptographic Authentication Extension

Cryptographic Authentication (*RFC 2747*) is enabled by setting the **authentication type** to **md5** and configuring an active password.

```
(config-mpls-rsvp) #authentication type md5
```

The default is **none**, which disables cryptographic authentication.

Authentication secrets are configured with an index. One of the indices should be chosen as the actively used password:

```
(config-mpls-rsvp) #authentication index 1 password s3cr3t
(config-mpls-rsvp) #authentication index 1 active
```

The **active** password is used to authenticate outgoing messages. All configured passwords are accepted for authentication of incoming packets, which allows smooth key rollover.

Password obfuscation is available:

```
(config-mpls-rsvp) #authentication index 1 password 7 07092E43
```

The size of the sequence number reorder window can be changed to accommodate a larger number of out-of-order packets. A value of N means that a packet is accepted if all earlier received packets with a higher sequence number are within the preceding $N-1$ packets.

```
(config-mpls-rsvp) #authentication sequence-number window 5
```

The default value is 5. A value of 1 effectively turns off support for packet reordering.

18.4.2.6 Fast Reroute Extension

Support for Fast Reroute (FRR) link protection/NHOP (*RFC 4090*) is enabled by setting the Fast Reroute mode to **link-protection**.

```
(config-mpls-rsvp) #fast-reroute mode link-protection
```

To turn off FRR, change the mode to the default setting **none**.

```
(config-mpls-rsvp) #fast-reroute mode none
```

This setting only applies to Point of Local Repair (PLR) behavior, for example, the router is the upstream node relative to a to-be-protected link over which an LSP is routed. Merge Point (MP) behavior is always enabled and not affected by this setting.

Support for Node Protection is present starting in *EOS Release 4.22.1F*, so the above CLI also accepts an additional mode **node-protection**.

You can change the revertive behavior of the FRR from the **global** revertive mode to the **local** revertive mode. In the **global** revertive mode, an LSR that is re-routed over a bypass tunnel because its downstream link is dead keeps using the bypass tunnel even after the link has recovered. This expects the headend router to set up a new LSP upon notification that a link is not available anymore. In the **local** revertive mode, the LSR switches back to using the primary link after recovery.

```
(config-mpls-rsvp) #fast-reroute reversion local
```

The default for reversion is **global**.

```
(config-mpls-rsvp) #fast-reroute reversion global
```

18.4.2.7 Shared Risk Link Group

Starting in *EOS Release 4.23.1F*, there is an additional config command to configure SRLG mode.

```
srlg [strict]
```

```
no srlg [strict]
```



```
default srlg [strict]
```

This command specifies if link SRLGs of a primary LSP are to be considered as constraints while creating a fast-reroute bypass tunnel with either link or node protection. When `srlg` is specified with the **strict** keyword, then if a path for a bypass tunnel excluding SRLGs of the next-hop interface of primary LSP can not be found, RSVP does not setup the bypass tunnel. When `srlg` is specified without a **strict** keyword, then a bypass tunnel is setup with as many links as possible that exclude the SRLGs of the next-hop interface of primary LSP and where such links are not available, links that have the least number of SRLGs which are to be excluded are used.

When this CLI is not configured, the behavior remains the same as before, which is to turn off SRLG processing. Therefore, the **no** and **default** versions of the command take you back to the default of SRLG processing being turned off.

The SRLGs of an interface can be configured using the following traffic-engineering CLI as below:

```
(config) #interface Et1
(config-if-Et1) #traffic-engineering srlg 100

(config) #interface Et2
(config-if-Et2) #traffic-engineering srlg 200
```

 **Note:** Although a large number of SRLGs can be configured on an interface (ranging from 0 to $2^{32}-1$), CSPF only takes into account a maximum of 16 SRLGs for finding a path with SRLG constraints.

18.4.2.8 CSPF configuration command

RSVP-TE uses CSPF to compute the FRR backup path. CSPF can be throttled to avoid frequent path changes when there are frequent network events. The following CLI command is used under the **router traffic-engineering** mode to specify how frequently CSPF is to run after a network event by specifying the initial wait interval, back-off interval, and maximum wait interval for CSPF.

```
cspf delay [initial n back-off n] max n
```

All three values are in milliseconds and default to **100**, **200**, and **1000** milliseconds, respectively.

18.4.2.9 Traffic-engineering Configuration Commands

For CSPF to compute the FRR backup path to a particular destination, enable traffic-engineering on all the IGP enabled interfaces, and enable globally the traffic engineering extensions. For IS-IS, enable under **router isis** mode, and for OSPFv2, enable under **router ospf**. This is required for the IGP to start exchanging TE-related attributes with peers and build its topology database.

Also, CSPF needs some notion of router ID to uniquely identify a router, so that it can find a path to it. CSPF also uses self router-id as a source for running SPF. So a router-id is required to be configured under **router traffic-engineering** mode for CSPF to function properly.

18.4.2.10 MTU Signaling

Starting in **EOS Release 4.23.1F**, MTU along a path can be signaled using RSVP.

Example

```
(config-mpls-rsvp)#[no|default]mtu signaling
```

RSVP can discover the lowest MTU used along an LSP by evaluating and updating, at each hop, the composed MTU, stored in the General Parameters fragment of an AdSpec object in RSVP Path messages.

At each RSVP hop, when MTU signaling is enabled, the value is updated by taking the minimum between the downstream interface for an LSP and the composed MTU value from the incoming Path message.

When the feature is disabled, the composed MTU is not updated.

18.4.2.11 Soft Preemption

Starting in **EOS Release 4.23.1F**, soft preemption is supported, which enables deferred failure of RSVP-TE LSPs on link oversubscription. A preemption timer value can be used to configure a delay on a transit router to support LSPs signaled with soft preemption enabled by the headend (**RFC 5712**).

```
preemption method [ hard | soft ] timer t
no preemption method [ hard | soft ] timer t
default preemption method [ hard | soft ] timer t
```

The default preemption method is soft preemption with a timer value of **30** seconds.

In this example, the preemption method is soft preemption with a timer value of **10** seconds.

```
(config-mpls-rsvp) #preemption method soft timer 10
```

Setting the preemption method to hard preemption results in a timer value of **0** seconds and disables the feature.

```
(config-mpls-rsvp) #preemption method hard
```

Sample Configuration

```
switch(config) #ip routing
!
switch(config) #mpls ip
!
switch(config) #interface Ethernet1
switch(config-if-Et1) #no switchport
switch(config-if-Et1) #ip address 10.0.0.1/24
switch(config-if-Et1) #isis enable isis
switch(config-if-Et1) #traffic-engineering
switch(config-if-Et1) #traffic-engineering bandwidth 100 percent
switch(config-if-Et1) #traffic-engineering metric 5
!
switch(config) #router traffic-engineering
switch(config-te) #router-id ipv4 0.1.1.1
!
switch(config) #router isis isis
switch(config-router-isis) #net 49.0000.0000.0000.1111.00
switch(config-router-isis) #is-type level-2
!
switch(config-router-isis) #address-family ipv4 unicast
switch(config-router-isis-af) #maximum-paths 32
!
switch(config-router-isis-af-te) #traffic-engineering
switch(config-router-isis-af-te) #no shutdown
switch(config-router-isis-af-te) #is-type level-2
!
switch(config) #mpls rsvp
switch(config-mpls-rsvp) #no shutdown
!
```

The following displays the overall state of RSVP.

```
switch>show mpls rsvp
Administrative state: enabled
Operational state: up
Refresh interval: 30 seconds
Refresh reduction: enabled
Hello messages: enabled
  Hello interval: 10 seconds
  Hello multiplier: 4
Fast Re-Route: disabled
  Mode: none
  Hierarchical FECs: enabled
Cryptographic authentication: disabled
MTU signaling: disabled
Number of sessions: 1
  Ingress/Transit/Egress: 0/1/0
Number of LSPs: 1
  Operational: 1
  Ingress/Transit/Egress: 0/1/0
  Currently using bypass tunnels: 0
Number of bypass tunnels: 0
Number of neighbors: 2
Number of interfaces: 2
```

The following displays the RSVP neighbors.

```
switch>show mpls rsvp neighbor
Neighbor 10.0.1.1
  Upstream for
    Session #1 LSP #1
  Downstream for
  Neighbor uptime: 00:01:24
  Authentication type: disabled
  Last hello received: 1 seconds ago
  Last hello sent: 1 seconds ago
  Bypass tunnel: not requested
Neighbor 10.0.2.2
  Upstream for
  Downstream for
  Session #1 LSP #1
  Neighbor uptime: 00:01:24
  Authentication type: disabled
  Last hello received: -
  Last hello sent: 31 seconds ago
  Bypass tunnel: not requested
```

The following displays a summary of RSVP neighbors by IP address.

```
switch>show mpls rsvp neighbor summary
Neighbor                               Role    Sessions LSPs
=====
10.0.1.1                               Upstream  1      1
10.0.2.2                               Downstream 1      1
```

The following displays RSVP sessions.

```
switch>show mpls rsvp session
Session #1
  Destination address: 0.4.4.4
  Tunnel ID: 0
  Extended Tunnel ID: 0.1.1.1
  Role: transit
```

```

LSP #1
  State: up
  Type: primary
  Source address: 0.1.1.1
  LSP ID: 1
  LSP uptime: 00:02:38
  Session name: Session1
  Local label: 100000
  Downstream label: 100000
  Upstream neighbor: 10.0.1.1
    Last refresh received: 17 seconds ago
    Last refresh sent: 10 seconds ago
  Downstream neighbor: 10.0.2.2
    Last refresh received: 7 seconds ago
    Last refresh sent: 9 seconds ago
  Bypass tunnel: not requested

```

The following displays a summary of RSVP sessions.

```

switch>show mpls rsvp session summary
Session Destination          LSP      Name
  Role      Bypass State
=====
=====
1          0.4.4.4                1        Session1
  transit n/req up

```

The following displays details of RSVP sessions.

```

switch>show mpls rsvp session detail
Session #1
  Destination address: 0.4.4.4
  Tunnel ID: 0
  Extended Tunnel ID: 0.1.1.1
  Role: transit
  LSP #1
    State: up
    [...]
  MTU Signaling: enabled
    Received Path MTU: 1800 bytes
    Sent Path MTU: 1500 bytes
  [...]

```

The following displays RSVP message counters per interface.

```

switch>show mpls rsvp counters
Received Messages:

Interface Path PathTear PathErr Resv ResvTear ResvErr Srefresh
Other Errors
-----
-----
Ethernet1 5      0      0      0      0      0      8      51
  1
Ethernet2 0      0      0      14     0      0      0      0
  0

Sent Messages:

Interface Path PathTear PathErr Resv ResvTear ResvErr Srefresh
Other Errors

```

Ethernet1	0	0	0	4	0	0	9	49
0								
Ethernet2	13	0	0	0	0	0	0	4
0								

18.4.2.12 Show Commands

18.4.2.12.1 RSVP Show Commands

Use the **show mpls rsvp** command to display the overall state of the RSVP.

```
switch>show mpls rsvp
Administrative state: enabled
Operational state: up
Refresh interval: 30 seconds
Refresh reduction: enabled
Hello messages: enabled
  Hello interval: 10 seconds
  Hello multiplier: 4
Fast Re-Route: disabled
  Mode: none
  Hierarchical FECs: enabled
Cryptographic authentication: disabled
MTU signaling: disabled
Number of sessions: 1
  Ingress/Transit/Egress: 0/1/0
Number of LSPs: 1
  Operational: 1
  Ingress/Transit/Egress: 0/1/0
  Currently using bypass tunnels: 0
Number of bypass tunnels: 0
Number of neighbors: 2
Number of interfaces: 2
```

Use the **show mpls rsvp neighbor** command to display RSVP neighbors.

```
switch>show mpls rsvp neighbor
Neighbor 10.0.1.1
  Upstream for
    Session #1 LSP #1
  Downstream for
  Neighbor uptime: 00:01:24
  Authentication type: disabled
  Last hello received: 1 seconds ago
  Last hello sent: 1 seconds ago
  Bypass tunnel: not requested
Neighbor 10.0.2.2
  Upstream for
  Downstream for
  Session #1 LSP #1
  Neighbor uptime: 00:01:24
  Authentication type: disabled
  Last hello received: -
  Last hello sent: 31 seconds ago
  Bypass tunnel: not requested
```

Use the `show mpls rsvp neighbor summary` command to display neighbors filtered by IP address.

```
switch>show mpls rsvp neighbor summary
Neighbor          Role           Sessions LSPs
=====
10.0.1.1          Upstream      1         1
10.0.2.2          Downstream    1         1
```

or use the `show mpls rsvp session` command.

```
switch>show mpls rsvp session
Session #1
  Destination address: 0.4.4.4
  Tunnel ID: 0
  Extended Tunnel ID: 0.1.1.1
  Role: transit
  LSP #1
    State: up
    Type: primary
    Source address: 0.1.1.1
    LSP ID: 1
    LSP uptime: 00:02:38
    Session name: Session1
    Local label: 100000
    Downstream label: 100000
    Upstream neighbor: 10.0.1.1
      Last refresh received: 17 seconds ago
      Last refresh sent: 10 seconds ago
    Downstream neighbor: 10.0.2.2
      Last refresh received: 7 seconds ago
      Last refresh sent: 9 seconds ago
    Bypass tunnel: not requested
```

Session #ID and LSP #ID are internal values that are locally significant. Use these to filter sessions in the `show mpls rsvp session summary` command and in LSP ping and traceroute commands (see below). Sessions can further be filtered by name, destination, router role (transit/ingress/egress), and state.

```
switch>show mpls rsvp session summary
Session Destination      LSP      Name           Role      Bypass State
=====
1         0.4.4.4                1        Session1      transit n/req up
```

Beginning with ***EOS Release 4.23.1F***, use the `show mpls rsvp session detail` command to display detailed information of RSVP sessions.

```
switch>show mpls rsvp session detail
Session #1
  Destination address: 0.4.4.4
  Tunnel ID: 0
  Extended Tunnel ID: 0.1.1.1
  Role: transit
  LSP #1
    State: up
    [...]
    MTU Signaling: enabled
      Received Path MTU: 1800 bytes
      Sent Path MTU: 1500 bytes
  [...]
[...]
```

Use the `show mpls rsvp counters` command to display RSVP message counters by interface.

```
switch>show mpls rsvp counters
Received Messages:

Interface  Path  PathTear  PathErr  Resv  ResvTear  ResvErr  Srefresh
Other  Errors
-----  -
-----  -
Ethernet1  5    0         0        0     0         0        8        51
  1
Ethernet2  0    0         0        14    0         0        0        0
  0

Sent Messages:

Interface  Path  PathTear  PathErr  Resv  ResvTear  ResvErr  Srefresh
Other  Errors
-----  -
-----  -
Ethernet1  0    0         0        4     0         0        9        49
  0
Ethernet2  13   0         0        0     0         0        0        4
  0
```

18.4.2.12.2 CSPF Show Commands

RSVP-TE uses CSPF to compute the FRR backup path. Starting from **EOS Release 4.23.1F**, if `srlg` is configured in `RSVPconfig` to exclude SRLG, then details about the SRLG related constraint attributes are also shown as in the following show commands.

Use the `show traffic-engineering cspf path` command to display all the paths computed by CSPF. In the following example, path **20.0.0.1** is selected for display.

```
switch>show traffic-engineering cspf path 20.0.0.1 20.0.0.1

Destination      Constraint                                     Path
20.0.0.1         exclude Ethernet1                             0.1.1.1
                 exclude SRLG of Ethernet1                    0.1.1.2
                                                         0.2.2.2
                                                         3.3.3.2
                 exclude Ethernet2                             0.1.1.1
                                                         0.1.1.2
                                                         0.2.2.2
                                                         3.3.3.2
```

Using the `show traffic-engineering cspf path detail` command, path **20.0.0.1** is displayed in detail.

```
switch>show traffic-engineering cspf path 20.0.0.1 detail

Destination: 20.0.0.1
  Path Constraint: exclude Ethernet1
                  exclude SRLG of Ethernet1: orange-link (500),
                  green-link (400), 100, red-link (200), 600
  Request Sequence number: 1
  Response Sequence number: 1
  Number of times path updated: 2
  Last updated: 00:01:58
  Reoptimize: Always
```

```

Path:
0.1.1.1
0.1.1.2
0.2.2.2
3.3.3.2

Path Constraint: exclude Ethernet2
Request Sequence number: 2
Response Sequence number: 2
Number of times path updated: 3
Last updated: 00:00:38
Reoptimize: Always
Path:
0.1.1.1
0.1.1.2
0.2.2.2
3.3.3.2

```

18.4.2.12.2. Displaying the Traffic-engineering Database

You can display the topology used for CSPF computations by using the `show traffic-engineering database` command. Starting from **EOS Release 4.23.1F**, the SRLG group details of a neighbor are shown if it is advertised.

Beginning with **EOS Release 4.24.2F**, information for the OSPFv2 topology, if configured, displays.

```

switch#show traffic-engineering database

TE Router-ID: 1.0.0.2
Source: IS-IS Level-1 IPv4 Topology Database
IS-IS System-ID: 1111.1111.1001
Number of Links: 2
Network type: P2P
Neighbor: 1111.1111.1002
Administrative group (Color): 0x123a
TE Metric: 30
IPv4 Interface Addresses:
20.20.20.1
192.168.20.1
IPv4 Neighbor Addresses:
20.20.20.2
192.168.20.2
Maximum link BW: 25.00 Gbps
Maximum reservable link BW: 10.00 Mbps
Unreserved BW:
TE class 0: 9.00 Mbps      TE class 1: 9.00 Mbps
TE class 2: 8.500 Mbps    TE class 3: 8.00 Mbps
TE class 4: 7.00 Mbps     TE class 5: 7.50 Mbps
TE class 6: 6.00 Mbps     TE class 7: 6.00 Mbps

Network Type: LAN
Neighbor: 1111.1111.1003.02
TE Metric: 30
Administrative Group: 0x12
IPv4 Local Addresses:
30.30.30.1

Maximum Link BW: 10.00 Gbps

Maximum Reservable Link BW: 10.50 Gbps

```



```

Unreserved BW:
    TE-Class 0: 8.50 Gbps      TE-Class 1: 8.70 Gbps
    TE-Class 2: 7.50 Gbps      TE-Class 3: 7.25 Gbps
    TE-Class 4: 6.50 Gbps      TE-Class 5: 7.30 Gbps
    TE-Class 6: 3.50 Gbps      TE-Class 7: 7.20 Gbps
Source: IS-IS Level-2 IPv4 Topology Database
IS-IS System-ID: 1111.1111.1003
Number of Links: 1
Network Type: LAN
Neighbor: 1111.1111.1003.16
IPv4 Local Addresses:
    40.40.40.1
Maximum link BW: 10.00 Gbps
Maximum reservable link BW: 5.00 Gbps
Unreserved BW:
    TE class 0: 4.00 Gbps      TE class 1: 4.00 Gbps
    TE class 2: 4.00 Gbps      TE class 3: 4.00 Gbps
    TE class 4: 3.00 Gbps      TE class 5: 3.00 Gbps
    TE class 6: 3.00 Gbps      TE class 7: 3.00 Gbps
Source: OSPFv2 Instance ID 33 Area-ID 0.0.0.0 Topology Database
OSPFv2 Router-ID: 1.2.3.4
Number of Links: 2
Network type: P2P
Neighbor: 3.4.5.6
Administrative group (Color): 0x123a
TE metric: 30
IPv4 Interface Addresses:
    20.20.20.1
    192.168.20.1
IPv4 Neighbor Addresses:
    20.20.20.2
    192.168.20.1
Maximum link BW: 25.00 Gbps
Maximum reservable link BW: 10.00 Mbps
Unreserved BW:
    TE class 0: 9.00 Mbps      TE class 1: 9.00 Mbps
    TE class 2: 8.50 Mbps      TE class 3: 8.00 Mbps
    TE class 4: 7.00 Mbps      TE class 5: 7.50 Mbps
    TE class 6: 6.00 Mbps      TE class 7: 6.00 Mbps
Network type: LAN
Neighbor: 2.3.4.5
Administrative group (Color): 0x12
TE metric: 30
IPv4 Interface Addresses:
    30.30.30.1
IPv4 Neighbor Addresses:
    0.0.0.0
Maximum link BW: 10.00 Gbps
Maximum reservable link BW: 10.5 Gbps
Unreserved BW:
    TE class 0: 8.50 Gbps      TE class 1: 8.70 Gbps
    TE class 2: 7.50 Gbps      TE class 3: 7.25 Gbps
    TE class 4: 6.50 Gbps      TE class 5: 7.30 Gbps
    TE class 6: 3.50 Gbps      TE class 7: 7.20 Gbps

TE Router-ID: 1.0.0.3
Source: IS-IS Level-1 IPv4 Topology Database
IS-IS System-ID: 1111.1111.1004
Number of Links: 2

```

```

Network type: P2P
Neighbor: 1111.1111.1002
IPv4 Interface Addresses:
  1.0.5.1
IPv4 Neighbor Addresses:
  1.0.5.2
Maximum link BW: 50.00 Gbps
Maximum reservable link BW: 10.00 Gbps
Unreserved BW:
  TE class 0: 8.00 Gbps      TE class 1: 8.00 Gbps
  TE class 2: 8.00 Gbps      TE class 3: 8.00 Gbps
  TE class 4: 7.00 Gbps      TE class 5: 7.00 Gbps
  TE class 6: 7.00 Gbps      TE class 7: 7.00 Gbps
Shared Risk Link Group:
  Group: 100
  Group: green-link (150)

```

18.4.2.13 Limitations

RSVP-TE LSR contains the following limitations:

- Supports only IPv4.
- Supports only the default VRF.
- Supports only strict EROs with host hops (/32).
- Supports only transit role functionality.
- Traffic Engineering links with secondary IP addresses are not supported.
- The maximum number of supported RSVP sessions and LSPs is 5000.
- For FRR, the maximum number of supported LSPs per interface is 2000.
- Changing the RSVP FRR mode while a bypass tunnel is already in use can bring down both primary and bypass tunnels which cause traffic loss.
- Changing the RSVP SRLG mode while a bypass tunnel is already in use could bring down both primary and bypass tunnels which cause traffic loss.
- The maximum number of IS-IS/OSPFv2 routers supported by CSPF on a single broadcast network is 30.
- The maximum number of IS-IS/OSPFv2 adjacencies supported by CSPF for a single router is 500.
- CSPF only takes into account a maximum of 16 SRLGs per TE link, when excluding SRLGs while computing a path.

18.5 LDP Pseudowire

LDP pseudowire provides support for emulating Ethernet connections over a Multiprotocol Label Switching (MPLS) network, and controlled using the extension of the MPLS Label Distribution Protocol (LDP) specified in [RFC4447](#).

The `patch panel` command allows "patching" a local interface "connector" to an LDP pseudowire "connector", terminating on the local switch. The LDP pseudowire itself is defined under the `pseudowires` configuration mode, under the `mpls ldp` configuration mode.

LDP pseudowire also supports locally patching traffic between two interfaces and is configured under the `patch panel` command.

Both these features support tagged (type 4) and raw (type 5) modes as highlighted in <https://tools.ietf.org/html/rfc4448>.

18.5.1 Platform Compatibility

The following platforms support LDP Pseudowire:

	Ethernet Tagged Mode (type 4)	Ethernet Raw Mode (type 5)
DCS-7500R	<i>EOS Release 4.17.1</i>	<i>EOS Release 4.20.1</i>
DCS-7280R	<i>EOS Release 4.17.1</i>	<i>EOS Release 4.20.1</i>
DCS-7500R2	<i>EOS Release 4.18.4</i>	<i>EOS Release 4.20.1</i>
DCS-7280R2	<i>EOS Release 4.18.4</i>	<i>EOS Release 4.20.1</i>
DCS-7020R	<i>EOS Release 4.22.0</i>	<i>EOS Release 4.22.0</i>

18.5.2 Configurations

18.5.2.1 Local-Remote Patch Configuration

To configure an LDP pseudowire, complete the following task.

1. Enter the pseudowire configuration section under the *mpls ldp* configuration section, and specify an LDP pseudowire name using the `pseudowire` command. In this example, the selected LDP pseudowire name is *ldppw*.

```
switch(config)#mpls ldp
switch(config-mpls-ldp)#pseudowire
switch(config-mpls-ldp-pw)#pseudowire ldppw
```

2. Once an LDP pseudowire has been configured, configure the neighbor IP address, pseudowire ID, and pseudowire MTU using the `neighbor`, `pseudowire-id`, and `mtu` configuration commands.

```
switch(config-mpls-ldp-pw-ldppw)#neighbor 1.2.3.4
switch(config-mpls-ldp-pw-ldppw)#pseudowire-id 1
switch(config-mpls-ldp-pw-ldppw)#mtu 9000
```

3. To configure a cross-connection between two connectors, configure a pseudowire patch by specifying a patch name in the `patch panel` configuration section.

```
switch(config)#patch panel
switch(config-patch)#patch example
```

4. After entering a *patch* configuration mode, configure a type 4 LDP pseudowire by specifying a VLAN tagged interface connector and an LDP pseudowire connector using the `connector` command.

```
switch(config-patch-example)#connector interface ethernet1 dot1q vlan
100
switch(config-patch-example)#connector pseudowire ldp ldppw
```

5. After entering a *patch* configuration mode, configure a type 5 LDP pseudowire by specifying an interface connector and an LDP pseudowire connector using the `connector` command.

```
switch(config-patch-example)#connector interface ethernet1
switch(config-patch-example)#connector pseudowire ldp ldppw
```



Note: IP routing must be enabled and the interface used for the local connector must be routed.

```
switch(config)#ip routing
switch(config)#interface ethernet1
switch(config-if-Et1)#no switchport
```

18.5.2.2 Local-Local Patch Configuration

The patch can also consist of two interface connectors or two VLAN tagged interface connectors to configure local stitching.

```
switch(config-patch) #patch example
switch(config-patch-example) #connector conn1 ethernet1
switch(config-patch-example) #connector conn2 ethernet2
switch(config-patch) #patch example2
switch(config-patch-example2) #connector conn1 ethernet1 dot1q vlan 100
switch(config-patch-example2) #connector conn2 ethernet2 dot1q vlan 200
```



Note: IP routing must be enabled and both interfaces used for the local connectors must be routed.

```
switch(config) #ip routing
switch(config) #interface ethernet1
switch(config-if-Et1) #no switchport
switch(config) #interface ethernet2
switch(config-if-Et2) #no switchport
```

18.5.2.3 Additional Patch Configuration Commands

The **shutdown** configuration command can be used to disable a pseudowire patch.

Example

```
switch(config-patch-example) #shutdown
```

18.5.2.4 Forwarding Behavior For Layer 2 Control Packets

There are differences in forwarding behavior for reserved MACs between the Ethernet Tagged Mode and the Ethernet Raw Mode. Some Layer 2 control packets are terminated and consumed at the Provider Edge, while others are encapsulated and forwarded on the pseudowire. Below is a list of the common Layer 2 control packets, and a summary of their forwarding behavior.

	Ethernet Tagged Mode (type 4)	Ethernet Raw Mode (type 5)
STP	When STP is enabled, STP packets are terminated. Otherwise, they are forwarded.	Forwarded
LLDP	Terminated	Forwarded
LACP	Terminated	Terminated
MACsec	Not supported	Forwarded

In addition, custom Layer 2 Control Packet forwarding behavior for type 5 pseudowire can be configured using the Layer 2 Protocol Forwarding functionality.

18.5.3 Show Commands

Use the **show patch panel** command to display the overall status of the configured pseudowire patches.

Example

```
switch#show patch panel
Patch      Connector      Status
-----
example    1: Ethernet3   Up
           2: Port-Channel2
example2   1: Ethernet1 802.1Q VLAN 100   Up
           2: LDP neighbor 1.1.1.1 PW ID 1111
example3   1: LDP neighbor 4.4.4.4 PW ID 1040   Up
           2: Ethernet2
```

Use the **show patch panel detail** command to display the detailed status of the configured pseudowire patches.

Example

```
switch#show patch panel detail
PW Fault Legend:
  ET-IN - Ethernet receive fault
  ET-OUT - Ethernet transmit fault
  TUN-IN - Tunnel receive fault
  TUN-OUT - Tunnel transmit fault
  NF - Pseudowire not forwarding (other reason)
Patch: example, Status: Up
  Connector 1: Ethernet3
    Status: Up
  Connector 2: Port-Channel2
    Status: Up
Patch: example2, Status: Up
  Connector 1: Ethernet1 802.1Q VLAN 100
    Status: Up
  Connector 2: LDP neighbor 1.1.1.1 PW ID 1111
    Status: Up
    Local MPLS label: 100032, Group ID: 0
    MTU: 9000, 802.1Q VLAN request sent: -
    Neighbor MPLS label: 900000, Group ID: 0x0
    MTU: 9000, 802.1Q VLAN request received: -
    PW type: 4 (tagged), Control word: N
    Tunnel type: LDP, Tunnel index: 198
Patch: example3, Status: Up
  Connector 1: LDP neighbor 4.4.4.4 PW ID 1040
    Status: Up
    Local MPLS label: 100002, Group ID: 0x0
    MTU: 1500, 802.1Q VLAN request sent: -
    Neighbor MPLS label: 400000, Group ID: 0x0
    MTU: 9213, 802.1Q VLAN request received: -
    PW type: 5 (raw), Control word: N
    Tunnel type: LDP, Tunnel index: 2
  Connector 2: Ethernet2
    Status: Up
```

Use the **show patch panel forwarding** command to display the forwarding information for configured pseudowire connectors.

Example

```
switch#show patch panel forwarding
```

```
Legend:
```

```
  Type - Pseudowire type: 4 (tagged)
                        5 (raw)
```

```
  CW - Control word used
```

In/Out	Type	CW	VLAN	Status	Patch
Et1 802.1Q VLAN 100 Label 900000, LDP Tun 198	4			Up	example2
Et2 Label 400000, LDP Tun 2	5			Up	example3
Et3 Po2				Up	example
Po2 Et3				Up	example

PW Label	Out	Source	Type	CW	Status	Patch
100002	Et2	LDP		5	Up	example3
100032	Et1 802.1Q VLAN 100	LDP		4	Up	example2

18.5.4 Limitations

When a subinterface has been configured with the same VLAN tag as a pseudowire connector on the same parent interface, or vice versa, only the first configured feature will be active.

When a port-based connector is used for a pseudowire or local cross-connect patch, dot1q-tagged packets will have the outer tag incorrectly removed on ingress/encap if any one of several other features are configured on the switch (on any interface) including Layer 2 subinterfaces, Dot1q Tunnel, VLAN Mapping, and VXLAN. The only workaround is to unconfigure these other features.

When a VLAN-based connector (or subinterface with dot1q encapsulation) is used for a pseudowire or local cross-connect patch, tagged packets will have incorrect tags after forwarding if any one of several other features are configured on the switch (on any interface) including Layer 2 subinterfaces, Dot1q Tunnel, VLAN Mapping, and VXLAN. The only workaround is to unconfigure these other features.

18.6 LDP Entropy Label

If a network device uses deep packet inspection for load balancing, it is recommended to use entropy label in LDP to improve load balancing in MPLS networks by providing sufficient entropy in the label stack itself.

Platform Compatibility

- DCS-7800R3 series
- DCS-7500R3 series.
- DCS-7280PR3 & DCS-7280DR3 & DCS-7280CR3 series.

```

'| - |353896|ROUTE| Et1/1 |0 |20480 | 00:00:00:00:0
0:01 |Mpush 501 401 301 ELI EL 201'

B. show platform fap ip route
Tunnel Type: M(mpls), G(gre), MoG(mpls-over-gre),
             vxlan-o(vxlan outer-rewrite info), vxlan-i(vxlan inner-
rewrite info)
'CW - Control word',
'FL - Flow label',
'EL - Entropy label',
'ELI - Entropy label indicator',
'* - Routes in LEM',
'D - ECMP is divergent across switching chips',
'-----',
'-----',
'| Routing Table
|-----',
'|-----',
'|VRF| Destination | | | | |
| ECMP| FEC | Tunnel',
'| ID| Subnet | Cmd | Destination | VID |Outlif |
MAC / CPU Code |Index| Index|T Value',
'-----',
'|0 |192.168.1.3/32 |ROUTE| Et1/2 |100 |8188 |
00:00:00:00:00:02 | - |353897| - ',
'|0 |200.0.0.0/24 |ROUTE| Et1/2 |100 |20484 |
00:00:00:00:00:02 | - |353898|M 501 401 301 ELI EL 201',
'|0 |0.0.0.0/0 |TRAP | CoppSystemL3LpmOver|0 | - |
SlowReceive | - |576815| - ',

```

18.6.3 Troubleshooting

1. Check transceiver type – make sure it is 400GBASE-ZR
2. Check peer transceiver – make sure it is also 400GBASE-ZR.
3. Check that channel/frequency is configured and interfaces are not in errdisabled state
4. Check that the selected frequency is matching on both sides of the optical link
5. Check that transmit output is not disabled
6. If Tx power is not configured, check that it is in the range of -6 dB to -12 dB.
7. If Tx power is configured, check that matches its configured values on both sides of the optical link.
8. Check Rx power. The best performance of an optical link is achieved when the received power is -10dB.
9. Collect the output of CLI commands listed in the “Show commands” section before making a request for support from the development team.
10. Check that pre-FEC BER (‘show transceiver dom’ command) is in the correctable range (less than 1e-2).
11. ‘show transceiver status interface’ - check that module state is ‘Ready’, datapath state is ‘Activated’. Check for possible alarms and faults

Link Issues

If a link has issues, the following commands and files are useful for debugging and Arista TAC.

- show interfaces <interfaceName> phy detail
- show interfaces <interfaceName> transceiver detail
- show idprom transceiver <interfaceName> ext
- files in /var/log/agents/*
- files in /var/log/qt/*

- /var/log/messages*

18.6.4 Limitations

- When the Transit LSR is acting as a PHP hop for a given LDP tunnel with entropy label pushed onto it by an Ingress LSR, only the LDP tunnel label will be popped at PHP whenever the Egress LSR has signaled implicit-null in LDP.
- Egress LSR should be capable of handling ELI as top label in the label stack like [ELI, EL, VPN, Payload].

18.7 MPLS Commands

MPLS Commands

- **MPLS Commands**
 - entropy-label
 - mpls ip
 - mpls static
 - mpls static vrf-label
 - mpls shared index
 - mpls tunnel termination
 - show mpls route
 - show mpls route summary
- **RSVP-TE LSR**
 - authentication
 - cspf delay
 - fast-reroute
 - fast-reroute reversion
 - ping mpls rsvp session
 - preemption method
 - shutdown
 - srlg
- **RSVP-TE LSR Show Commands**
 - show mpls rsvp counters
 - show mpls rsvp neighbor
 - show mpls rsvp session detail
 - show mpls rsvp session summary
 - show mpls rsvp session
 - show mpls rsvp
 - show traffic-engineering cspf path
 - show traffic-engineering database

18.7.1 authentication

Use the **authentication** command to enable cryptographic authentication. The **no** form and the **default** form of the command removes cryptographic authentication.

Command Mode

MPLS RSVP sub-mode (mpls-rsvp)

Command Syntax

```
authentication [ index 1-4294967295 [ active | password ] ] [ sequence-number window 1-255 ] [ type [ md5 | none ] ] ]
```

```
no authentication [ index 1-4294967295 [ active | password ] ] [ sequence-number window 1-255 ] [ type [ md5 | none ] ] ]
```

```
default authentication [ index 1-4294967295 [ active | password ] ] [ sequence-number window 1-255 ] [ type [ md5 | none ] ] ]
```

Parameters

- **index 1-4294967295** Password index.
 - **active** Use index as the active password.
 - **password** password.
- **sequence-number** Index in the sequence.
 - **window 1-255** Reorder window size. The default value is 5. A value of 1 turns off support for packet reordering.
- **type** Authentication mechanism.
 - **md5** MD5 hash.
 - **none** No authentication mechanism. Disables cryptographic authentication.

Examples

- Cryptographic Authentication (**RFC 2747**) is enabled by setting the **authentication type** to **md5** and configuring an active password.

```
(config-mpls-rsvp) #authentication type md5
```

- Authentication secrets are configured with an index. One of the indices should be chosen as the actively used password:

```
(config-mpls-rsvp) #authentication index 1 password s3cr3t
(config-mpls-rsvp) #authentication index 1 active
```

The **active** password is used to authenticate outgoing messages. All configured passwords are accepted for authentication of incoming packets, which allows smooth key rollover.

- Password obfuscation is available:

```
(config-mpls-rsvp) #authentication index 1 password 7 07092E43
```

- The size of the sequence number reorder window can be changed to accommodate a larger number of out-of-order packets. A value of *N* means that a packet is accepted if all earlier received packets with a higher sequence number are within the preceding *N-1* packets.

```
(config-mpls-rsvp) #authentication sequence-number window 5
```

The default value is 5. A value of 1 effectively turns off support for packet reordering.

18.7.2 cspf delay

RSVP-TE uses CSPF to compute the FRR backup path. CSPF can be throttled to avoid frequent path changes when there are frequent network events. Use the **cspf delay** command to specify how frequently CSPF is to run after a network event by specifying the initial wait interval, back-off interval, and maximum wait interval for CSPF. The **no** form and the **default** form of the command removes the CSPF delay.

Command Mode

Router traffic engineering mode

Command Syntax

```
cspf delay [initial n back-off n] max n
```

```
no cspf delay [initial n back-off n] max n
```

```
default cspf delay [initial n back-off n] max n
```

Parameters

- **initial** Specify initial wait interval for CSPF.
 - ***n*** Time in milliseconds. 1-300000.
 - **back-off** specify back-off interval for CSPF.
 - ***n*** Time in milliseconds. 1-300000.
- **max** Specify maximum wait interval for CSPF.
 - ***n*** Time in milliseconds. 1-300000.

18.7.3 entropy-label

The `entropy-label` command enables the MPLS LDP Entropy Label.

The `no entropy-label` command removes the MPLS LDP Entropy Label configurations from the `running-config`.

Command Mode

MPLS LDP Configuration Mode

Command Syntax

`entropy-label`

`no entropy-label`

Example

- This command enables the MPLS LDP Entropy Label.

```
switch(config)#mpls ldp
switch(config-mpls-ldp)#entropy-label
switch(config-mpls-ldp)#exit
```

18.7.4 fast-reroute

Use the **fast-reroute** command to support Fast Reroute (FRR) link protection/NHOP (**RFC 4090**). You can enable FRR protection by setting the Fast Reroute mode to **link-protection**.

Command Mode

MPLS RSVP sub-mode (mpls-rsvp)

Command Syntax

```
fast-reroute [mode [ link-protection | node-protection | none ] | [ reversion [ global | local ]]
```

Parameters

- **mode** Fast reroute mode.
 - **link-protection** Protects against failure of the next link.
 - **node-protection** protects against failure of the next node.
 - **none** Disables fast reroute.
- **reversion** Select reversion behavior.
 - **global** Global revertive repair (default).
 - **local** Local revertive repair.

Examples

- Support for Fast Reroute (FRR) link protection/NHOP (**RFC 4090**) is enabled by setting the Fast Reroute mode to **link-protection**.

```
(config-mpls-rsvp) #fast-reroute mode link-protection
```

- To turn off FRR, change the mode to the default setting **none**.

```
(config-mpls-rsvp) #fast-reroute mode none
```

- You can change the revertive behavior of the FRR from the **global** revertive mode to the **local** revertive mode. In the **global** revertive mode, an LSR that is re-routed over a bypass tunnel because its downstream link is down keeps using the bypass tunnel even after the link has recovered. This expects the headend router to set up a new LSP upon notification that a link is not available anymore. In the **local** revertive mode, the LSR switches back to using the primary link after recovery

```
(config-mpls-rsvp) #fast-reroute reversion local
```

- The default for reversion is **global**.

```
(config-mpls-rsvp) #fast-reroute reversion global
```

18.7.5 fast-reroute reversion

You can change the revertive behavior of the FRR from the **global** revertive mode to the **local** revertive mode. In the **global** revertive mode, an LSR that is re-routed over a bypass tunnel because its downstream link is dead keeps using the bypass tunnel even after the link has recovered. This expects the headend router to set up a new LSP upon notification that a link is not available anymore. In the **local** revertive mode, the LSR switches back to using the primary link after recovery.

The default for reversion is **global**.

Command Mode

Configuration sub-mode for RSVP

Command syntax

```
fast-reroute reversion [ global | local ]
```

Parameters

- **global** Global revertive repair.
- **local** Local revertive repair.

Examples

- Setting the fast-reroute reversion to local:

```
(config-mpls-rsvp)#fast-reroute reversion local
```

- The default for reversion is **global**.

```
(config-mpls-rsvp)#fast-reroute reversion global
```

18.7.6 hello interval

The **hello interval** command sets the time between the hello packets. The **no** form of the command explicitly disables the Hello messages, while the **default** form of the command resets to the default setting of 10 seconds with a multiplier of 4.

Command Mode

Configuration sub-mode for RSVP.

Command Syntax

```
hello interval [interval [sec]] [multiplier [num]]
```

```
no hello interval [interval [sec]] [multiplier [num]]
```

```
default hello interval [interval [sec]] [multiplier [num]]
```

Parameters

- **interval sec** The interval in units of seconds.
 - **multiplier num** The number of missed hellos after which the neighbor is expired.

Examples

- In this example, hello messages are sent to all known neighbors every 10 seconds. If no hello responses are received from a neighbor for $4 \times 10 = 40$ seconds, communication is considered to be lost and the neighbor is reset.

```
(config-mpls-rsvp)#hello interval 10 multiplier 4
```

- In this example, the default of 10 seconds with multiplier 4 is reset.

```
(config-mpls-rsvp)#default hello interval
```

- in this example, the command to explicitly disables the Hello messages.

```
(config-mpls-rsvp)#no hello interval
```

18.7.7 mpls ip

The `mpls ip` command enables MPLS routing. Multiprotocol Label Switching (MPLS) is a networking process that avoids complex lookups in a routing table by replacing complete network addresses with short path labels for directing data packets to network nodes. MPLS data paths are serviced through a tunnel encapsulation data structure that adds four-byte label headers to packets.

The `no mpls ip` and `default mpls ip` commands disable MPLS routing by removing the `mpls ip` command from *running-config*. When MPLS routing is disabled, routed MPLS packets are dropped and all MPLS routes and adjacencies are removed. MPLS routing is disabled by default.

Command Mode

Global Configuration

Command Syntax

```
mpls ip
```

```
no mpls ip
```

```
default mpls ip
```

Examples:

- This command enables MPLS routing. Previous commands enabled IP routing and configured MPLS static routes.

```
switch(config)#mpls ip
switch(config)#show running-config

! Command: show running-config

!
ip routing
!
mpls ip
!
mpls static top-label 3400 10.14.4.4 pop payload-type ipv4
mpls static top-label 4400 10.15.46.45 pop payload-type ipv4
!

!
end
switch(config)#
```

- This command disables MPLS routing.

```
switch(config)#no mpls ip
switch(config)#show running-config

! Command: show running-config
<-----OUTPUT OMITTED FROM EXAMPLE----->

!
ip routing
!
mpls static top-label 3400 10.14.4.4 pop payload-type ipv4
mpls static top-label 4400 10.15.46.45 pop payload-type ipv4
!

!
end
switch(config)#
```

18.7.8 mpls shared index

The `mpls shared index` command configures an ethernet-segment (ES) shared-index to allocate an ESI label value based on the shared-index configuration.

The `no mpls shared index` command removes mpls shared index configuration from the `running-config`.

Command Mode

EVPN Ethernet-Segment Mode

Command Syntax

```
mpls shared index index-value
```

```
no mpls shared index index-value
```

Parameter

- *index-value* Label index value. Value ranges from 1 to 1024.

Example

- These commands place the switch on ethernet-segment (ES) configuration mode and configure an MPLS shared index value of 100.

```
switch(config)#interface Ethernet4
switch(config-if-Et1)#switchport access vlan 1000
switch(config-if-Et1)#evpn ethernet-segment
switch(config-evpn-es)#identifier 0022:2222:2222:2222:2222
switch(config-evpn-es)#mpls shared index 100
switch(config-evpn-es)#route-target import 00:02:00:02:00:02
```

18.7.9 mpls static

The `mpls static` command creates an MPLS rule that specifies the method of handling of inbound MPLS traffic. Multiprotocol Label Switching (MPLS) is a networking process that replaces complete network addresses with short path labels for directing data packets to network nodes.

Static rules specify these parameters:

- **MPLS filter:** The top-label parameter specifies the 20-bit value that the MPLS packet's top header label must match to be handled by the rule.
- **Nexthop location:** Specifies the destination nexthop address (IPv4 or IPv6) and the interface through which the switch forwards the packet.
- **MPLS action:** Specifies the MPLS label stack management action performed on the packet:
 - **pop-payload:** removes the top label from stack; this terminates an LSP (label-switched path).
 - **swap-label:** replaces top label with a specified new label; this passes a packet along an LSP.
- **Rule priority:** Specifies the rule to be used when an MPLS packet matches multiple rules.

The `no mpls static` and `default mpls static` commands delete the specified MPLS rule from *running-config*.

- Commands that include only a top label tag remove all MPLS rules with the matching top label.
- Commands with no **PRIORITY** parameter remove all matching routes of every metric value.

Command Mode

Global Configuration

Command Syntax

```
mpls static top-label top_tag [DEST_INTF] NEXTHOP_ADDR ACTION [PRIORITY]
```

```
no mpls static top-label top_tag
```

```
no mpls static top-label top_tag [DEST_INTF] NEXTHOP_ADDR ACTION [PRIORITY]
```

```
default mpls static top-label top_tag
```

```
default mpls static top-label top_tag [DEST_INTF] NEXTHOP_ADDR ACTION [PRIORITY]
```

Parameters

- **top_tag** Top header's label field contents. Value ranges from 0 to 1048575 (20 bits).
- **DEST_INTF** Specifies interface through which **NEXTHOP_ADDR** is accessed. Options include:
 - **<no parameter>** Any interface.
 - **ethernet e_num** Ethernet interface specified by **e_num**.
 - **loopback l_num** Loopback interface specified by **l_num**.
 - **management m_num** Management interface specified by **m_num**.
 - **port-channel p_num** Port-channel interface specified by **p_num**.
 - **vlan v_num** VLAN interface specified by **v_num**.
 - **vxlan vx_num** VXLAN interface specified by **vx_num**.
- **NEXTHOP_ADDR** Nexthop address for MPLS for filtered MPLS packets. Options include:
 - **ipv4_addr** IPv4 address.
 - **ipv6_addr** IPv6 address.
- **ACTION** MPLS header stack management action performed on packet. Options include:
 - **pop payload-type ipv4** Removes top layer from stack. Payload is handled as IPv4 packet.
 - **pop payload-type ipv6** Removes top layer from stack. Payload is handled as IPv6 packet.
 - **swap-label <0 to 1048575>** Replaces header label with specified label value (20 bits).

- **PRIORITY** Specifies rule priority when multiple rules match a packet. Options include:
 - **<no parameter>** Assigns a metric value of 100 to the rule.
 - **metric <1 to 255>** Lower values denote higher priority. Value ranges from **1** to **255**.

The `mpls static` command does not support push label actions.

Examples:

- These commands create an MPLS rule that matches packets with a top label value of `3400` and causes the removal of the top label from the header stack. The nexthop destination of the IPv4 payload is IP address `10.14.4.4` through Ethernet interface `3/3/3`. This rule has a metric value of `100`.

```
switch(config)#mpls static top-label 3400 ethernet 3/3/3 10.14.4.4 pop
payload-type ipv4
switch(config)#show running-config

!
mpls static top-label 3400 Ethernet3/3/3 10.14.4.4 pop payload-type
  ipv4
!

end
switch(config)#
```

- These commands create a backup rule that forwards the packet through Ethernet interface `4/3`. This rule's metric value of `150` assigns it backup status prior to the first rule.

```
switch(config)#mpls static top-label 3400 ethernet 4/3 10.14.4.4 pop
payload-type
  ipv4 metric 150
switch(config)#show running-config

!
mpls static top-label 3400 Ethernet4/3 10.14.4.4 pop payload-type ipv4
  metric 150
mpls static top-label 3400 Ethernet3/3/3 10.14.4.4 pop payload-type
  ipv4
!

<-----OUTPUT OMITTED FROM EXAMPLE----->

end
switch(config)#
```

- These commands create an MPLS rule that forwards the packet to the nexthop address through any interface.

```
switch(config)#mpls static top-label 4400 10.15.46.45 pop payload-type
  ipv4
switch(config)#show running-config

<-----OUTPUT OMITTED FROM EXAMPLE----->

!
mpls static top-label 3400 Ethernet4/3 10.14.4.4 pop payload-type ipv4
  metric 150
mpls static top-label 3400 Ethernet3/3/3 10.14.4.4 pop payload-type
  ipv4
mpls static top-label 4400 10.15.46.45 pop payload-type ipv4
!
```

```
end  
switch(config)#
```

18.7.10 mpls static vrf-label

Use the `mpls static vrf-label` command to configure a static VRF label route. The `no` and `default` versions of the command removes the configuration.

Command Mode

Global configuration mode

Command Syntax

```
mpls static vrf-label mpls-label [ vrf vrf-name ]
```

```
no mpls static vrf-label mpls-label [ vrf vrf-name ]
```

```
default mpls static vrf-label mpls-label [ vrf vrf-name ]
```

Parameters

- *mpls-label* Value of the MPLS label.
- *vrf vrf-name* VRF instance name.

Example

```
switch(config) #mpls static vrf-label 100 vrf default  
switch(config) #mpls static vrf-label 200 vrf v1
```

18.7.11 mpls tunnel termination

Command Mode

Global configuration mode

Command Syntax

```
mpls tunnel termination [ model [ php model ] [ ttl [[ pipe | uniform ] dscp ] | pipe | uniform ]
```

```
no mpls tunnel termination [ model [ php model ] [ ttl [[ pipe | uniform ] dscp ] | pipe | uniform ]
```

```
default mpls tunnel termination [ model [ php model ] [ ttl [[ pipe | uniform ] dscp ] | pipe | uniform ]
```

Parameters

- **model** Tunnel termination TTL and DSCP model.
- **php** Penultimate hop popping configuration.
- **ttl** Model for TTL.
- **pipe** Preserve the inner value.
- **uniform** Propagate value from outer header.
- **dscp** mode for DSCP.

Example

```
switch(config)#mpls tunnel termination model ttl uniform dscp pipe
```

18.7.12 ping mpls rsvp session

LSP Ping allows the user to check if the remote endpoint of an RSVP session is reachable through the LSP. Running ping on an RSVP LSP creates an LSP Ping Request packet with the label programmed by RSVP and that packet will follow the MPLS path until it reaches the end of the tunnel. If the node that receives this Request is the intended destination, it replies with an RSVP Ping Reply through normal IP routing. When the source receives the Reply it indicates that there are no apparent data plane failures and that the endpoint of that LSP is reachable.

Command Mode

Configuration sub-mode for RSVP

Command Syntax

```
ping mpls rsvp session [id num | name word] [ lsp | pad-reply | repeat | source | standard | tos |
tos ]
```

Parameters

- **id** Specifies the session by ID
 - **num** RSVP session ID.
 - **lsp** Specifies LSP
 - **pad-reply** Indicates that the reply should copy the pad TLV.
 - **repeat** Specifies repeat count.
 - **source** Specifies source address.
 - **standard** Sets the standard to comply with.
 - **tos** Specifies ToS value.
 - **tos** Specifies MPLS traffic class field.
- **name** Specifies session by name.
 - **word** RSVP session name.
 - **lsp** Specifies LSP
 - **pad-reply** Indicates that the reply should copy the pad TLV.
 - **repeat** Specifies repeat count.
 - **source** Specifies source address.
 - **standard** Sets the standard to comply with.
 - **tos** Specifies ToS value.
 - **traffic-class** Specifies MPLS traffic class field.

Examples

- A user can invoke the ping utility for a specific LSP by using the session and LSP IDs displayed in the CLI show commands.

```
switch#ping mpls rsvp session id 1 lsp 1 repeat 3
LSP ping to RSVP session #1 LSP #1
  timeout is 5000ms, interval is 1000ms
Via 10.0.12.2, Ethernet1, label 100000
  Reply from 10.0.34.4: seq=1, time=53.294ms, success: egress ok
Via 10.0.12.2, Ethernet1, label 100000
  Reply from 10.0.34.4: seq=2, time=75.329ms, success: egress ok
Via 10.0.12.2, Ethernet1, label 100000
  Reply from 10.0.34.4: seq=3, time=85.574ms, success: egress ok

--- RSVP target fec 0.4.4.4 : lsping statistics ---
Via 10.0.12.2, Ethernet1, label 100000
  3 packets transmitted, 3 received, 0% packet loss, time 2272ms
  3 received from 10.0.34.4, rtt min/max/avg 53.294/85.574/71.399 ms
```

- For the `ping mpls rsvp session` command, the argument `lsp` is optional. If unspecified, the utility pings all LSPs within that session.

```
switch#ping mpls rsvp session id 1 repeat 2
LSP ping to RSVP session #1
  timeout is 5000ms, interval is 1000ms
LSP 1
Via 10.0.12.2, Ethernet1, label 100000
  Reply from 10.0.34.4: seq=1, time=60.28ms, success: egress ok
LSP 2
Via 10.0.12.2, Ethernet1, label 100002
  Reply from 10.0.34.4: seq=1, time=81.701ms, success: egress ok
LSP 1
Via 10.0.12.2, Ethernet1, label 100000
  Reply from 10.0.34.4: seq=2, time=52.807ms, success: egress ok
LSP 2
Via 10.0.12.2, Ethernet1, label 100002
  Reply from 10.0.34.4: seq=2, time=62.814ms, success: egress ok

--- RSVP target fec 0.4.4.4 : lsping statistics ---
LSP 1
Via 10.0.12.2, Ethernet1, label 100000
  2 packets transmitted, 2 received, 0% packet loss, time 1262ms
  2 received from 10.0.34.4, rtt min/max/avg 52.807/60.280/56.544 ms

LSP 2
Via 10.0.12.2, Ethernet1, label 100002
  2 packets transmitted, 2 received, 0% packet loss, time 1262ms
  2 received from 10.0.34.4, rtt min/max/avg 62.814/81.701/72.257 ms
```

- Similarly, the session can be specified by name and the utility pings all the LSPs within that session.

```
switch#ping mpls rsvp session name Session1to4 repeat 2
LSP ping to session Session1to4
  timeout is 5000ms, interval is 1000ms
LSP 1
Via 10.0.12.2, Ethernet1, label 100000
  Reply from 10.0.34.4: seq=1, time=63.314ms, success: egress ok
LSP 2
Via 10.0.12.2, Ethernet1, label 100002
  Reply from 10.0.34.4: seq=1, time=75.639ms, success: egress ok
LSP 1
Via 10.0.12.2, Ethernet1, label 100000
  Reply from 10.0.34.4: seq=2, time=60.875ms, success: egress ok
LSP 2
Via 10.0.12.2, Ethernet1, label 100002
  Reply from 10.0.34.4: seq=2, time=77.135ms, success: egress ok

--- RSVP target fec 0.4.4.4 : lsping statistics ---
LSP 1
Via 10.0.12.2, Ethernet1, label 100000
  2 packets transmitted, 2 received, 0% packet loss, time 1262ms
  2 received from 10.0.34.4, rtt min/max/avg 60.875/63.314/62.094 ms

LSP 2
Via 10.0.12.2, Ethernet1, label 100002
  2 packets transmitted, 2 received, 0% packet loss, time 1262ms
  2 received from 10.0.34.4, rtt min/max/avg 75.639/77.135/76.387 ms
```

18.7.13 preemption method

The **preemption method** command enables deferred failure of RSVP-TE LSPs on link oversubscription. Use a preemption timer value to configure a delay on a transit router to support LSPs signaled with soft preemption enabled by the headend (**RFC 5712**).

The default preemption method is soft preemption with a timer value of 30 seconds.

Command Mode

Configuration sub-mode for RSVP

Command Syntax

```
preemption method [ hard | soft ] timer t
no preemption method [ hard | soft ] timer t
default preemption method [ hard | soft ] timer t
```

Parameters

- **hard** Hard preemption.
- **soft** Soft preemption.
 - **timer** Time limit for LSP teardown.
 - **t** <1-65535> Timer value in units of seconds.

Example

- In this example, the preemption method is soft preemption with a timer value of **10** seconds.

```
(config-mpls-rsvp) #preemption method soft timer 10
```

- Setting the preemption method to hard preemption results in a timer value of **0** seconds and disables the feature.

```
(config-mpls-rsvp) #preemption method hard
```

18.7.14 refresh method

Using the **refresh method** command with the **bundled** keyword enables the Refresh Overhead Reduction that supports the sending of message IDs and refreshing state with refresh messages.

Command Mode

Configuration sub-mode for RSVP

Command Syntax

```
refresh method [ bundled | explicit ]
```

Parameters

- **bundled** Refresh states using message identifiers lists. This is the default setting.
- **explicit** Send each message individually.

Examples

- Use the **bundled** keyword to enable the Refresh Overhead Reduction.

```
(config-mpls-rsvp) #refresh method bundled
```

- To turn off refresh overhead reduction, use the **explicit** keyword.

```
(config-mpls-rsvp) #refresh method explicit
```

18.7.15 show mpls route summary

The `show mpls route summary` command displays statistics about the configuration and implementation of MPLS rules.

Command Mode

EXEC

Command Syntax

```
show mpls route summary
```

Example:

This command displays a summary of MPLS rule implementation.

```
switch>show mpls route summary
Number of Labels: 1 (1 unprogrammed)
Number of adjacencies in hardware: 0
Number of backup adjacencies: 2
switch>
```

18.7.16 show mpls route

The `show mpls config route` command displays the switch's MPLS static rule configuration for the specified routes and rules.

Command Mode

EXEC

Command Syntax

```
show mpls [INFO_LEVEL] route [header_label]
```

Parameters

- **INFO_LEVEL** Specifies the filters that are used to select the routes to display. Options include:
 - **<no parameter>** Displays routes published by the forwarding agent.
 - **config** Displays all configured routes.
 - **lfib** Displays routes stored to the Label Forwarding Information Base (LFIB).
- **header_label** Filters routes by MPLS top header label. Options include:
 - **<no parameter>** Displays routes for all header values.
 - **<0 to 1048575>** Specifies header for which command displays information.

Example:

This command displays the MPLS rule configuration.

```
switch>show mpls config route
In-Label  Out-Label  Metric  Payload  NextHop
3400      pop        100     ipv4     10.14.4.4,Et3/3/3
3400      pop        150     ipv4     10.14.4.4,Et4/3
switch>
```

18.7.17 show mpls rsvp

Use the `show mpls rsvp` to display the overall state of the RSVP.

Command Mode

EXEC

Command Syntax

```
show mpls rsvp [ bandwidth | counters | ip | ipv6 | neighbor | session ]
```

Parameters

- **bandwidth** Displays RSVP bandwidth information.
- **counters** Displays RSVP message counters.
- **ip** Displays details related to IPv4.
- **ipv6** Displays details related to IPv6.
- **neighbor** Displays RSVP neighbors.
- **session** Displays RSVP session information.

Examples

```
switch>show mpls rsvp
Administrative state: enabled
Operational state: up
Refresh interval: 30 seconds
Refresh reduction: enabled
Hello messages: enabled
  Hello interval: 10 seconds
  Hello multiplier: 4
Fast Re-Route: disabled
  Mode: none
  Hierarchical FECs: enabled
Cryptographic authentication: disabled
MTU signaling: disabled
Number of sessions: 1
  Ingress/Transit/Egress: 0/1/0
Number of LSPs: 1
  Operational: 1
  Ingress/Transit/Egress: 0/1/0
  Currently using bypass tunnels: 0
Number of bypass tunnels: 0
Number of neighbors: 2
Number of interfaces: 2
```

18.7.18 show mpls rsvp counters

Use the `show mpls rsvp counters` command to display RSVP message counters, per interface.

Command Mode

EXEC

Command Syntax

```
show mpls rsvp counters [[ interface [ Ethernet | Fabric | Loopback | Management | Port-Channel  
| Switch | Tunnel | Vlan | Vxlan ]]]| ipv4 interface | ipv6 interface
```

Parameters

- **interface** Filter by interface.
 - **Ethernet** Hardware Ethernet interface.
 - **Fabric** Fabric interfaces.
 - **Loopback** Hardware interface used for looping packets.
 - **Management** Management interface.
 - **Port-Channel** Lag interface.
 - **Switch** Switch interface.
 - **Tunnel** Tunnel interface.
 - **Vlan** Logical interface into a VLAN.
 - **Vxlan** VXLAN tunnel interface.
- **ipv4** Filter by IPv4.
 - **interface** Filter by interface.
- **ipv6** Filter by IPv6.
 - **interface** Filter by interface.

Example

```
switch>show mpls rsvp counters
```

```
Received Messages:
```

Interface	Path	PathTear	PathErr	Resv	ResvTear	ResvErr	Srefresh	
Other	Errors							
-----	----	-----	-----	----	-----	-----	-----	
-----	-----							
Ethernet1	5	0	0	0	0	0	8	51
1								
Ethernet2	0	0	0	14	0	0	0	0
0								

```
Sent Messages:
```

Interface	Path	PathTear	PathErr	Resv	ResvTear	ResvErr	Srefresh	
Other	Errors							
-----	----	-----	-----	----	-----	-----	-----	
-----	-----							
Ethernet1	0	0	0	4	0	0	9	49
0								
Ethernet2	13	0	0	0	0	0	0	4
0								

18.7.19 show mpls rsvp neighbor

Use the `show mpls rsvp neighbor` command to display a summary of all RSVP neighbors, or the list of active LSPs for a specific neighbor.

Command Mode

EXEC

Command Syntax

```
show mpls rsvp neighbor [ A.B.C.D | A:B:C:D:E:F:G:H | summary ]
```

Parameters

- **A.B.C.D** IP (v4 or v6) address of neighbor.
- **A:B:C:D:E:F:G:H** IP (v4 or v6) address of neighbor.
- **summary** Displays summarized information.

Example

- Use the `show mpls rsvp neighbor` command to display a summary of all RSVP neighbors.

```
switch>show mpls rsvp neighbor
Neighbor 10.0.1.1
  Upstream for
    Session #1 LSP #1
  Downstream for
  Neighbor uptime: 00:01:24
  Authentication type: disabled
  Last hello received: 1 seconds ago
  Last hello sent: 1 seconds ago
  Bypass tunnel: not requested
Neighbor 10.0.2.2
  Upstream for
  Downstream for
  Session #1 LSP #1
  Neighbor uptime: 00:01:24
  Authentication type: disabled
  Last hello received: -
  Last hello sent: 31 seconds ago
  Bypass tunnel: not requested
```

- Use the `show mpls rsvp neighbor summary` command to display summarized information.

```
switch>show mpls rsvp neighbor summary
Neighbor          Role          Sessions  LSPs
=====
10.0.1.1          Upstream     1         1
10.0.2.2          Downstream   1         1
```

18.7.20 show mpls rsvp session detail

Use the `show mpls rsvp session detail` to display the detailed information of RSVP sessions.

Command Mode

EXEC

Command Syntax

```
show mpls rsvp session detail
```

Example

```
switch>show mpls rsvp session detail
Session #1
  Destination address: 0.4.4.4
  Tunnel ID: 0
  Extended Tunnel ID: 0.1.1.1
  Role: transit
  LSP #1
    State: up
    [...]
    MTU Signaling: enabled
      Received Path MTU: 1800 bytes
      Sent Path MTU: 1500 bytes
  [...]

```

18.7.21 show mpls rsvp session summary

Use the `show mpls rsvp session summary` command to filter sessions in the show command and in LSP ping and traceroute commands. Sessions can further be filtered by name, destination, router role (transit/ingress/egress), and state.

Command Mode

EXEC

Command Syntax

```
show mpls rsvp session summary
```

Example

```
switch>show mpls rsvp session summary
Session  Destination          LSP      Name          Role      Bypass State
=====  =====
1         0.4.4.4                    1        Session1     transit n/req up

```

18.7.22 show mpls rsvp session

Use the `show mpls rsvp session` command to list the current RSVP sessions filtered by IP address.

Command Mode

EXEC

Command Syntax

```
show mpls rsvp session
```

Example

```
switch>show mpls rsvp session
Session #1
  Destination address: 0.4.4.4
  Tunnel ID: 0
  Extended Tunnel ID: 0.1.1.1
  Role: transit
  LSP #1
    State: up
    Type: primary
    Source address: 0.1.1.1
    LSP ID: 1
    LSP uptime: 00:02:38
    Session name: Session1
    Local label: 100000
    Downstream label: 100000
    Upstream neighbor: 10.0.1.1
      Last refresh received: 17 seconds ago
      Last refresh sent: 10 seconds ago
    Downstream neighbor: 10.0.2.2
      Last refresh received: 7 seconds ago
      Last refresh sent: 9 seconds ago
    Bypass tunnel: not requested
```

18.7.23 show traffic-engineering cspf path

Use the `show traffic-engineering cspf path` command to display all the paths conuted by CSPF.

Command Mode

EXEC

Command Syntax

```
show traffic-engineering cspf path [ destination-IP ][detail ]
```

Parameters

- **A.B.C.D** CSPF path to this destination IP address.
- **detail** Show detailed path information.

Examples

In this example, the CSPF destination path **20.0.0.1** is selected to display.

```
switch>show traffic-engineering cspf path 20.0.0.1

Destination      Constraint                                     Path
20.0.0.1         exclude Ethernet1                             0.1.1.1
                 exclude SRLG of Ethernet1                    0.1.1.2
                                                         0.2.2.2
                                                         3.3.3.2
                 exclude Ethernet2                          0.1.1.1
                                                         0.1.1.2
                                                         0.2.2.2
                                                         3.3.3.2
```

In this example, the CSPF destination path **20.0.0.1** is selected to display detailed information.

```
switch>show traffic-engineering cspf path 20.0.0.1 detail

Destination: 20.0.0.1
  Path Constraint: exclude Ethernet1
                  exclude SRLG of Ethernet1: orange-link (500),
                  green-link (400), 100, red-link (200), 600
  Request Sequence number: 1
  Response Sequence number: 1
  Number of times path updated: 2
  Last updated: 00:01:58
  Reoptimize: Always
  Path:
  0.1.1.1
  0.1.1.2
  0.2.2.2
  3.3.3.2

  Path Constraint: exclude Ethernet2
  Request Sequence number: 2
  Response Sequence number: 2
  Number of times path updated: 3
  Last updated: 00:00:38
  Reoptimize: Always
  Path:
  0.1.1.1
  0.1.1.2
  0.2.2.2
  3.3.3.2
```

18.7.24 show traffic-engineering database

Use the `show traffic-engineering database` to display the topology used for CSPF computations. Starting from **EOS Release 4.23.1F**, the SRLG group details of a neighbor are shown if it is advertised.

Command Mode

EXEC

Command Syntax

```
show traffic-engineering database
```

Special Considerations

- Beginning with **EOS Release 4.23.1F**, the SRLG group details of a neighbor are shown if it is advertised.
- Beginning with **EOS Release 4.24.2F**, information for the OSPFv2 topology is displayed if configured.

Example

```
switch#show traffic-engineering database

TE Router-ID: 1.0.0.2
  Source: IS-IS Level-1 IPv4 Topology Database
    IS-IS System-ID: 1111.1111.1001
      Number of Links: 2
        Network type: P2P
          Neighbor: 1111.1111.1002
            Administrative group (Color): 0x123a
              TE Metric: 30
                IPv4 Interface Addresses:
                  20.20.20.1
                  192.168.20.1
                IPv4 Neighbor Addresses:
                  20.20.20.2
                  192.168.20.2
              Maximum link BW: 25.00 Gbps
              Maximum reservable link BW: 10.00 Mbps
              Unreserved BW:
                TE class 0: 9.00 Mbps      TE class 1: 9.00 Mbps
                TE class 2: 8.5.00 Mbps    TE class 3: 8.00 Mbps
                TE class 4: 7.00 Mbps      TE class 5: 7.50 Mbps
                TE class 6: 6.00 Mbps      TE class 7: 6.00 Mbps

            Network Type: LAN
              Neighbor: 1111.1111.1003.02
                TE Metric: 30
              Administrative Group: 0x12
                IPv4 Local Addresses:
                  30.30.30.1

              Maximum Link BW: 10.00 Gbps

              Maximum Reservable Link BW: 10.50 Gbps

              Unreserved BW:

                TE-Class 0: 8.50 Gbps      TE-Class 1: 8.70 Gbps
```

```

        TE-Class 2: 7.50 Gbps          TE-Class 3: 7.25 Gbps
        TE-Class 4: 6.50 Gbps          TE-Class 5: 7.30 Gbps
        TE-Class 6: 3.50 Gbps          TE-Class 7: 7.20 Gbps
Source: IS-IS Level-2 IPv4 Topology Database
IS-IS System-ID: 1111.1111.1003
  Number of Links: 1
  Network Type: LAN
  Neighbor: 1111.1111.1003.16
  IPv4 Local Addresses:
    40.40.40.1
  Maximum link BW: 10.00 Gbps
  Maximum reservable link BW: 5.00 Gbps
  Unreserved BW:
    TE class 0: 4.00 Gbps          TE class 1: 4.00 Gbps
    TE class 2: 4.00 Gbps          TE class 3: 4.00 Gbps
    TE class 4: 3.00 Gbps          TE class 5: 3.00 Gbps
    TE class 6: 3.00 Gbps          TE class 7: 3.00 Gbps
Source: OSPFv2 Instance ID 33 Area-ID 0.0.0.0 Topology Database
OSPFv2 Router-ID: 1.2.3.4
  Number of Links: 2
  Network type: P2P
  Neighbor: 3.4.5.6
  Administrative group (Color): 0x123a
  TE metric: 30
  IPv4 Interface Addresses:
    20.20.20.1
    192.168.20.1
  IPv4 Neighbor Addresses:
    20.20.20.2
    192.168.20.1
  Maximum link BW: 25.00 Gbps
  Maximum reservable link BW: 10.00 Mbps
  Unreserved BW:
    TE class 0: 9.00 Mbps          TE class 1: 9.00 Mbps
    TE class 2: 8.50 Mbps          TE class 3: 8.00 Mbps
    TE class 4: 7.00 Mbps          TE class 5: 7.50 Mbps
    TE class 6: 6.00 Mbps          TE class 7: 6.00 Mbps
  Network type: LAN
  Neighbor: 2.3.4.5
  Administrative group (Color): 0x12
  TE metric: 30
  IPv4 Interface Addresses:
    30.30.30.1
  IPv4 Neighbor Addresses:
    0.0.0.0
  Maximum link BW: 10.00 Gbps
  Maximum reservable link BW: 10.5 Gbps
  Unreserved BW:
    TE class 0: 8.50 Gbps          TE class 1: 8.70 Gbps
    TE class 2: 7.50 Gbps          TE class 3: 7.25 Gbps
    TE class 4: 6.50 Gbps          TE class 5: 7.30 Gbps
    TE class 6: 3.50 Gbps          TE class 7: 7.20 Gbps

TE Router-ID: 1.0.0.3
Source: IS-IS Level-1 IPv4 Topology Database
IS-IS System-ID: 1111.1111.1004
  Number of Links: 2
  Network type: P2P
  Neighbor: 1111.1111.1002
  IPv4 Interface Addresses:
    1.0.5.1

```

```
IPv4 Neighbor Addresses:
 1.0.5.2
Maximum link BW: 50.00 Gbps
Maximum reservable link BW: 10.00 Gbps
Unreserved BW:
  TE class 0: 8.00 Gbps      TE class 1: 8.00 Gbps
  TE class 2: 8.00 Gbps      TE class 3: 8.00 Gbps
  TE class 4: 7.00 Gbps      TE class 5: 7.00 Gbps
  TE class 6: 7.00 Gbps      TE class 7: 7.00 Gbps
Shared Risk Link Group:
 Group: 100
 Group: green-link (150)
```

18.7.25 shutdown

The **shutdown** command disables the RSVP-TE protocol instance or the RSVP-related functions for the interface. The RSVP-TE configuration information associated with the interface is retained.

RSVP-TE is enabled globally by issuing **no shutdown** in the configuration sub-mode. This is the only mandatory setting for RSVP-TE to work. There is no per-interface knob to enable or disable RSVP. However, RSVP is only enabled on interfaces on which MPLS is enabled.

Command Mode

Configuration sub-mode for RSVP

Command Syntax

```
shutdown
```

```
no shutdown
```

Examples

- You can enable RSVP-TE globally by issuing the **no shutdown** command.

```
(config-mpls-rsvp) #no shutdown
```

- Similarly, it is disabled with the **shutdown** command, which is the default.

```
(config-mpls-rsvp) #shutdown
```

18.7.26 srlg

The **srlg** command specifies if link SRLGs of a primary LSP are to be considered as constraints while creating a fast-reroute bypass tunnel with either link or node protection. When the **srlg** command is specified with **strict** keyword, then when a path for a bypass tunnel excluding SRLGs of next-hop interface of primary LSP can not be found, RSVP does not setup the bypass tunnel. When the **srlg** command is specified without the **strict** keyword, then a bypass tunnel is setup with as many links as possible that exclude the SRLGs of next-hop interface of primary LSP and where such links are not available, links that have the least number of SRLGs which are to be excluded are used.

When this CLI is not configured, the behavior remains the same as before, which is to turn off SRLG processing. Therefore, the **no** and **default** versions of the command takes you back to the default of SRLG processing being turned off.

Command Mode

Configuration sub-mode for RSVP

Command Syntax

```
srlg strict
```

```
no srlg strict
```

```
default srlg strict
```

Parameters

strict Applies strict SRLG constraints.

Example

- The SRLGs of an interface can be configured using the following traffic-engineering CLIs.

```
(config)#interface Et1
(config-if-Et1)#traffic-engineering srlg 100

(config)#interface Et2
(config-if-Et2)#traffic-engineering srlg 200
```

Visibility and Monitoring Services

The Visibility and Monitors Services chapter contains the following sections:

- [Test Access Point \(TAP\) Aggregation](#)
- [Latency Analyzer \(LANZ\)](#)
- [Sampled Flow Tracking](#)
- [sFlow](#)
- [SNMP](#)
- [VM Tracer](#)
- [MapReduce Tracer](#)

19.1 Test Access Point (TAP) Aggregation

This section describes test access point (TAP) aggregation and the data structures that it requires. Topics in this section include:

- [TAP Aggregation Introduction](#)
- [TAP Aggregation Description](#)
- [TAP Aggregation Extra MPLS Pop \(4 to 6 Labels\)](#)
- [TAP Aggregation Configuration](#)
- [TAP Aggregation Traffic Steering](#)
- [TAP Aggregation GUI](#)
- [TAP Aggregation Keyframe and Timestamp Configuration](#)
- [TapAgg GRE Tunnel Termination](#)
- [TAP Aggregation Commands](#)

Port mirroring is described in [Test Access Point \(TAP\) Aggregation](#).

19.1.1 TAP Aggregation Introduction

Ethernet-based switches are commonly deployed in dedicated networks to support tool access point (TAP) and mirror port traffic toward one or more analysis applications. Ports configured to mirror data can simultaneously switch traffic to its primary destination while directing a copy of that traffic to analysis or test devices. TAP ports are typically part of a dedicated environment that allows for the aggregation of data streams from multiple sources that can be directed to multiple destinations.

Arista switches support port mirroring and TAP aggregation and the data structures required by these functions.

19.1.2 TAP Aggregation Description

These sections describe TAP aggregation, timestamps, and keyframes:

- [TAP Aggregation](#)
- [Timestamps and Keyframes](#)

19.1.2.1 TAP Aggregation

Tool access point (TAP) aggregation is the accumulation of data streams and the subsequent dispersal of these streams to devices and applications that analyze, test, verify, parse, detect, or store data. TAP aggregation requires an environment free from switching operations. Arista switches operate in one of two device modes:

- **Switching mode:** the switch performs normal switching and routing operations. Data mirroring is supported in switching mode. Tap aggregation is not available in switching mode.
- **TAP aggregation mode:** The switch is a data-monitoring device and does not provide normal switching and routing services. Data mirroring is not available in tap aggregation mode.

Access control lists, port channels, LAGs, QoS, and VLANs function normally in both modes.

Ethernet and port channel interfaces are configured as **TAP** and **tool** ports to support tap aggregation.

- **TAP ports:** a tap port is an interface that receives a data stream that two network ports exchange. TAP ports prohibit egress traffic. MAC learning is disabled. All control plane interaction is prevented. Traps for inbound traffic are disabled. Tap ports are in STP forwarding mode.
- **Tool ports:** A tool port is an interface that replicates data streams received by one or more tap ports. Tool ports connect to devices that process the monitored data streams.

Tool ports prohibit ingress traffic. MAC learning is disabled. All control plane interaction is prevented. Tool ports are in STP forwarding mode.

TAP and tool ports are configured with the **switchport mode** command. These ports are active when the switch is in tap aggregation mode and error-disabled when the switch is in switching mode.

TAP and tool ports are designated through switchport mode commands and act similar to trunk ports, in that they can allow access to VLANs specified through allowed-VLAN lists. Tap ports also specify a native VLAN for handling untagged frames.

Access, trunk, and dot1q-tunnel mode ports are active when the switch is in switching mode and error-disabled when the switch is in tap aggregation mode.

TAP and tool mode ports are active when the switch is in TAP aggregation mode and error-disabled when the switch is in switching mode.

TAP aggregation groups are data structures that map a set of TAP ports to a set of tool ports. Both TAP and tool ports may belong to multiple TAP aggregation groups, and a TAP aggregation group may contain multiple TAP and tool ports.

19.1.2.2 Timestamps and Keyframes

FM6000 platform switches support packet timestamping of packets sent from any port at line rate. Timestamps are used to correlate network events and in performance analysis. Keyframes provide information to assist in the interpretation of timestamps.

The switch contains two 64-bit counters to maintain ASIC time and UTC time. ASIC time is based on an internal 350 MHz counter. UTC is absolute time that is maintained by a precision oscillator and synchronized through PTP.

Timestamps are derived from the least significant 31 bits of ASIC time. Based on the 350 MHz counter period and 31-bit resolution, timestamp values repeat every 6.135 seconds.

Keyframes are periodically inserted into the data stream to provide context for interpreting timestamps. Keyframes contain the 64-bit value of the ASIC time counter, the corresponding 64-bit value of the UTC time counter, and the elapsed time since the last PTP synchronization of the UTC counter. Inserting one keyframe every second into the data stream assures that the timestamp value in each egress packet can be associated with values of the complete 64-bit ASIC time counter and the corresponding UTC counter.

19.1.2.2.1 Timestamps

Timestamps are based on a frame's ingress time and applied to frames sent on egress ports, ensuring that timestamps on monitored traffic reflect ingress timing of the original frames. Timestamping is configured on the egress port where the timestamp is applied to the frame.

A timestamp consists of the least significant 31 bits of the ASIC time counter. The most significant bit of the least significant byte is a 0 pad, resulting in a 32-bit timestamp with 31 bits of data. The keyframe mechanism provides recovery of the most significant 33 bits of the ASIC counters and a map to UTC time. Applications use this mechanism to determine the absolute time of the frame timestamp.

The switch supports three timestamp modes, which are configurable on individual Ethernet ports. The modes differ in the management of the egress frame's 32-bit frame check sequence (FCS):

- **Disabled:** timestamping is disabled.
- **FCS Replacement Mode:** the original FCS is discarded, and the ingress timestamp is appended to frame data, followed by a new FCS that is based on the appended timestamp. The result is a valid Ethernet frame, but the headers of all nested protocols are not updated to reflect the timestamp.
- **FCS Appending Mode:** the original FCS is discarded and replaced by the ingress timestamp. The size of the original frame is maintained without any latency impact, but the FCS is not valid.

19.1.2.2.2 Keyframes

Keyframes contain routable IP packets that provide information to relate timestamps with the complete ASIC counter and absolute UTC time. Keyframes have valid L2 and L3 headers. Keyframes contain these header fields:

- MAC fields (12 bytes):
 - Source MAC address is the address of the egress interface transmitting the keyframe.
 - Destination MAC address is configured through a CLI command.
- IP Header (20 bytes):
 - Source IP address is configured through CLI; default is management interface IP address.
 - Destination IP address is configured through a CLI command.
 - TTL is set to 64.
 - TOS is set to 0.
 - Protocol field is set to 253.
 - IP header's ID field is set to 0.

Keyframes contain these payload fields:

- **ASIC time:** (64 bits) ASIC time counter. (2.857 ns resolution).
- **UTC time:** (64 bits) Unix time that corresponds to ASIC time (ns).
- **Last sync time:** (64 bits) ASIC time of most recent PTP synchronization.
- **Keyframe time:** (64 bits) ASIC time of the keyframe's egress (ns).
- **Egress interface drops:** (64 bits) Number of dropped frames on keyframe's egress interface.
- **Device ID:** (16 bits) device ID (user defined).
- **Egress interface:** (16 bits) Keyframe's egress switchport.
- **FCS type (8 bits):** Timestamping mode configured on keyframe's egress port.
 - **0:** timestamping disabled.
 - **1:** timestamp is appended to payload; new FCS is added to the frame.
 - **2:** timestamp overwrites the existing FCS.
- **Reserved (8 bits):** reserved for future use.
- **Skew numerator/skew denominator:** form a ratio indicating the ASIC clock skew. If the ratio is greater than 1, the clock is skewed fast; if the ratio is less than 1, the clock is skewed slow.

Last sync time equals 0 when there was no previous synchronization or the time since the last synchronization is greater than 8 hours.

The 31-bit frame timestamp provides high-resolution timing, rolling over about every 6.135 seconds (31 bits at 2.857ns per tick). To obtain the full ASIC time and to correlate the timestamp to an absolute UTC time, the switch sends keyframes. Each keyframe contains the current ASIC time and UTC time; hence an application can compute the high order bits of the ASIC time (for precise, relative timing) from the ASIC to UTC time mapping, and then determine absolute time.

ASIC to UTC time conversion is not quite immediate, so the UTC time in the frame will not be the current time. A keyframe timestamp is provided for this purpose. The frame also includes the timestamping mode (FCS type) so applications can dynamically determine the timestamp's byte offset. Each field is shown in the following table.

Table 76: Keyframe Payload

0 7	8 15	16 31
ASIC time		
UTC time		
Last sync time		
Skew numerator		
Skew denominator		
Keyframe timestamp		
Drop count		
Device ID		Egress interface
FCS type	Reserved	

19.1.3 TAP Aggregation Extra MPLS Pop (4 to 6 Labels)

Available starting with **EOS Release 4.23.1F** extra MPLS pop for TAP Aggregation allows you to remove four to six MPLS labels from a packet. Previously, only one to three labels were able to be popped.

When configured, popping four to six MPLS labels will work in all the cases where popping one to three MPLS labels works. MPLS pop for 1 to 3 labels can be found here: <https://eos.arista.com/eos-4-15-0f/tap-aggregation-mpls-pop/>.

19.1.3.1 TAP Aggregation Extra MPLS Pop Platform Compatibility

The following platforms support TAP aggregation extra MPLS pop:

- DCS-7020
- DCS-7280/R/R2 series
- DCS-7500/R/R2 series

19.1.3.2 Limitations

19.1.3.2.1 IP Steering

IP steering does not work for MPLS packets with four or more labels. Currently, you must work around this limitation with a configuration similar to the [Configuration for IP Steering](#) below. This workaround does not work when MPLS pop is not enabled.

19.1.3.2.2 Configuration for IP Steering

When MPLS pop is enabled, you can enable IP steering for for to six MPLS labels by adding an extra port into the configuration as a tap-tool port.

For example, you want to perform IP steering from interface **Ethernet1** to a set of interfaces and also want MPLS labels to be popped. Add a new interface **Ethernet2**, which will not receive any external traffic, as a tap-tool port with traffic loopback. Then configure **Ethernet1** to forward to **Ethernet2** as its default interface. The commands would look similar to the following:

```
(config-if-Et2)#swi mode tap-tool
(config-if-Et2)#traffic-loopback source system device phy
(config-if-Et2)#int et1
(config-if-Et1)#swi tap default interface et2
```

All of **Ethernet1**'s old tool ports should be disabled and become **Ethernet2**'s tool ports. Then, all IP steering configuration that was originally meant to be between **ET1** and its old tool ports should be configured with **Ethernet2** in place of **Ethernet1**. Finally, configure MPLS pop on **Ethernet1**.

19.1.3.3 TAP Aggregation Extra MPLS POP (4 to 6 Labels) Commands

[show hardware tcam profile](#)

19.1.4 TAP Aggregation Configuration

These sections describe TAP aggregation configuration tasks:

- [Enabling Tap Aggregation Mode](#)
- [Tap Aggregation Mixed Mode](#)
- [Tap Port Configuration](#)
- [Tool Port Configuration](#)
- [Per-linecard TCAM Profile Configuration](#)
- [Two-Way Ports for Tap Aggregation](#)
- [Tap Aggregation QoS Handling on Tap Ports](#)
- [Identity VLAN Tagging](#)
- [Tap Aggregation Group Configuration](#)

19.1.4.1 Enabling Tap Aggregation Mode

The switch supports switching mode and TAP aggregation mode. In switching mode, normal switching and routing functions are supported while TAP aggregation functions are disabled. In TAP aggregation mode, TAP aggregation functions are enabled while normal switching and routing functions are disabled. By default, the switch is in switching mode.

A ports switchport status depends on its switchport mode and the switch's TAP aggregation mode.

- Tap aggregation mode enabled: TAP and tool ports are enabled. Switching ports are errdisabled.
- Tap aggregation mode disabled: TAP and tool ports are errdisabled. Switching ports are enabled.

To enable the switch to carry out TAP aggregation, first enter TAP aggregation configuration mode using the [tap aggregation](#) command, then set the mode to exclusive.

 **Note:** The switch can also perform TAP aggregation in mixed mode. See [Mixed Mode Configuration](#).

Example

- These commands enter TAP aggregation configuration mode, then place the switch in TAP aggregation exclusive mode.

```
switch(config)#tap aggregation
switch(config-tap-agg)#mode exclusive
switch(config-tap-agg)#show active
tap aggregation
  mode exclusive
switch(config-tap-agg)#
```

To return the switch to switching mode, remove the `mode` command from *running-config*.

Examples

- These commands enter TAP aggregation configuration mode, then place the switch in switching mode.

```
switch(config)#tap aggregation
switch(config-tap-agg)#no mode
switch(config-tap-agg)#show active
switch(config-tap-agg)#
```

- These commands enter switching mode and remove all TAP aggregation configuration mode statements.

```
switch(config)#no tap aggregation
switch(config)#
```

19.1.4.2 TAP Aggregation Mixed Mode

On a modular switch, the user can configure TAP Aggregation on some linecards and leave other linecards to operate normally. This is referred to as TAP aggregation mixed mode.

- [Mixed Mode Platform Compatibility](#)
- [Mixed Mode Configuration](#)

19.1.4.2.1 Mixed Mode Platform Compatibility

The following platforms support TAP Aggregation Mixed Mode.

- DCS-7500R
- DCS-7500R2

19.1.4.2.2 Mixed Mode Configuration

Complete the following steps to configure Linecard 3 as a TAP aggregation linecard in mixed mode.

1. Enable the switch for configuration.

```
switch>configure terminal
```

2. Enable TAP aggregation.

```
switch(config)#tap aggregation
```

3. Enable TAP aggregation mixed mode, selecting the targeted linecard module using the TAP aggregation default.

```
switch(config-tap-agg)#mode mixed module linecard 3 tap-aggregation-default
```



Note: Changing modes may affect available functionality. Unsupported configuration elements will be ignored.

The profile selection in mixed mode is the same as in exclusive mode. The user can configure multiple linecards for TAP aggregation in mixed mode.

The user can check TAP Aggregation Mixed Mode status by executing the following show commands:

```
switch(config)#show running-config section tap
tap aggregation
  mode mixed module linecard 3 profile tap-aggregation-default
switch(config)#show hardware tcam profile
Linecard4          Configuration      Status
Linecard3          default           default
Linecard6          default           tap-aggregation-default
switch(config)#
```

19.1.4.3 TAP Port Configuration

TAP ports function when the switch is in TAP aggregation mode. TAP ports receive traffic for replication to one or more tool ports. In TAP aggregation mode, TAP ports are in STP forwarding state and prohibit egress traffic. MAC learning, control plane interaction and traps for inbound traffic are disabled.

TAP mode ports are configured through switchport mode commands. TAP mode command settings persist in *running-config* without taking effect when the switch is not in TAP aggregation mode or the interface is not in TAP aggregation mode.

This section describes the following tap port configuration steps.

- [Configuring an Interface as a TAP Mode Port](#)
- [TAP Port Allowed VLAN List Configuration](#)
- [TAP Port Native VLAN](#)
- [TAP Port Packet Truncation](#)

Configuring an Interface as a Tap Mode Port

Ethernet and port-channel interfaces are configured as TAP ports with the `switchport mode` command.

Example

- These commands configure Ethernet interfaces 41 through 43 as TAP mode ports.

```
switch(config)#interface ethernet 41-43
switch(config-if-Et41-43)#switchport mode tap
switch(config-if-Et41-43)#show interface ethernet 41-43 tap
```

Port	Configured	Status	Native	Id
Truncation	Default		Vlan	Vlan
Group	Mode			
Et41	tap	tap	1	1 0
Et42	tap	tap	1	1 0
Et43	tap	tap	1	1 0

```
switch(config-if-Et41-43)#
```

TAP Port Allowed VLAN List Configuration

By default, TAP mode interfaces handle tagged traffic for all VLANs. The `switchport tap allowed vlan` command creates or modifies the set of VLANs for which a TAP port handles tagged traffic.

Example

These commands create TAP-mode allowed VLAN lists for Ethernet interfaces 41 through 43.

```
switch(config)#interface ethernet 41
switch(config-if-Et41)#switchport tap allowed vlan 401-410
switch(config-if-Et41)#interface ethernet 42
switch(config-if-Et42)#switchport tap allowed vlan 411-420
switch(config-if-Et41)#interface ethernet 41-42
switch(config-if-Et41-42)#show active
interface Ethernet41
  switchport mode tap
  switchport tap allowed vlan 401-410
interface Ethernet42
  switchport mode tap
  switchport tap allowed vlan 411-420
switch(config-if-Et41-42)#
```

TAP Port Native VLAN

Tap mode Interfaces associate untagged frames with the tap mode native VLAN. The `switchport tap native vlan` command specifies the TAP-mode native VLAN for the configuration-mode interface. The default TAP-mode native VLAN for all interfaces is VLAN 1.

Example

These commands assign VLAN 400 as the TAP-mode native VLAN for Ethernet interface 41.

```
switch(config)#interface ethernet 41
switch(config-if-Et41)#switchport tap native vlan 400
switch(config-if-Et41)#show interface ethernet 41-43 tap
Port      Configured  Status      Native  Id  Truncation
Default
```

Group	Mode		Vlan	Vlan	
Et41	tap	tap	400	1	0
Et42	tap	tap	1	1	0
Et43	tap	tap	1	1	0

```
switch(config-if-Et41)#
```

TAP Port Packet Truncation

TAP ports can be configured to truncate inbound packets. The `switchport tap truncation` command configures the configuration-mode interface, as a TAP port, to truncate inbound packets to the specified packet size. By default, TAP ports do not truncate packets.

Examples

- These commands configure Ethernet interface 41 to truncate packets to 150 bytes.

```
switch(config)#interface ethernet 41
switch(config-if-Et41)#switchport tap truncation 150
switch(config-if-Et41)#show interface ethernet 41-43 tap
Port      Configured   Status      Native   Id
Truncation Default
          Mode
          Group
-----
Et41     tap         tap         400     1     150
---
Et42     tap         tap         1       1     0
---
Et43     tap         tap         1       1     0
---
switch(config-if-Et41)#
```

- These commands configure Ethernet interface 41 to send complete packets for replication.

```
switch(config-if-Et41)#no switchport tap truncation
switch(config-if-Et41)#show interface ethernet 41 tap
Port      Configured   Status      Native   Id
Truncation Default
          Mode
          Group
-----
Et41     tap         tap         400     1     0
---
switch(config-if-Et41)#
```

19.1.4.4 Tool Port Configuration

Tool ports replicate traffic received by TAP ports. Tool ports are mapped to the TAP ports through TAP aggregation groups. A tool port may belong to multiple aggregation groups and an aggregation group may contain multiple tool ports.

Tool ports function when the switch is in TAP aggregation mode. In this switch mode, tool ports are in STP forwarding state and ingress traffic is prohibited. MAC learning, control plane interaction, and traps for inbound traffic are disabled. All control plane interaction is prevented and L2 agents do not send PDUs to tool-mode interfaces. When the switch is in switching mode, tool ports are error-disabled.

Tool-mode ports are configured through switchport commands. Tool-mode command settings persist in **running-config** without taking effect when the switch is not in TAP aggregation mode or the interface is not in TAP aggregation mode.

This section describes the following tool port configuration steps.

- [Configuring an Interface as a Tool-mode Port](#)
- [Tool Port Allowed VLAN List Configuration](#)
- [Tool Port Packet Truncation](#)

Configuring an Interface as a Tool-mode Port

Ethernet and port channel interfaces are configured as tool ports with the `switchport mode` command.

Example

These commands configure port-channel interfaces 101 through 103 as tool-mode ports and display the result.

```
switch(config)#interface port-channel 101-103
switch(config-if-Po101-103)#switchport mode tool
switch(config-if-Po101-103)#show interface port-channel 101-103
tool
Port          Configured      Status          Allowed          Id
Timestamp
Mode          Mode           Vlans           Tag
-----
-----
Po101        tool           tool           All              Off
---
Po102        tool           tool           All              Off
---
Po103        tool           tool           All              Off
---
switch(config-if-Po101-103)#
```

Tool Port Allowed VLAN List Configuration

By default, tool mode interfaces handle tagged traffic for all VLANs. The `switchport tool allowed vlan` command creates or modifies the set of VLANs for which a tool port handles tagged traffic.

Example

These commands create tool mode allowed VLAN lists for port-channel interfaces 101 through 103.

```
switch(config)#interface port-channel 101-103
switch(config-if-Po101-103)#switchport tool allowed vlan
1010-1020
switch(config-if-Po101-103)#interface port-channel 101
switch(config-if-Po101)#switchport tool allowed vlan add
1001-1009
switch(config-if-Po103)#interface port-channel 102
switch(config-if-Po102)#switchport tool allowed vlan remove
1016-1020
switch(config-if-Po102)#interface port-channel 103
switch(config-if-Po103)#switchport tool allowed vlan add
1021-1030
switch(config-if-Po103)#show interface port-channel 101-103 tool
Port      Configured      Status      Allowed      Id
Timestamp
Mode      Mode            Vlans       Tag
-----
-----
Po101     tool            tool        1001-1020    Off
---
Po102     tool            tool        1010-1015    Off
---
Po103     tool            tool        1010-1030    Off
---
switch(config-if-Po103)#
```

Tool Port Packet Truncation

Tool ports can be configured to truncate outbound packets. The `switchport tool truncation` command configures the configuration-mode interface, as a tool port, to truncate outbound packets to 160 bytes. By default, tool ports do not truncate packets.

Tool port packet truncation is supported only on the 7150 series platform.

Examples

- These commands configure Ethernet interface 41, as a tool port, to truncate packets on egress to 160 bytes.

```
switch(config)#interface ethernet 41
switch(config-if-Et41)#switchport mode tool
switch(config-if-Et41)#switchport tool truncation 160
switch(config-if-Et41)#
```

- These commands configure Ethernet interface 41 to send complete packets.

```
switch(config-if-Et41)#no switchport tool truncation
switch(config-if-Et41)#
```

19.1.4.5 Per-linecard TCAM Profile Configuration

This feature gives the ability to specify different profiles for different linecards in mixed mode. The following platforms support per-linecard TCAM profile configuration:

- DCS-7500
- DCS-7500R
- DCS-7500R2

To enable the TAP aggregation mode and configure a TCAM profile for a linecard set, complete the following steps:

1. Enable the switch for configuration.

```
switch>configure terminal
```

2. Enable TAP aggregation mode.

```
switch(config)#tap aggregation
```

3. Configure the TCAM profile for a linecard set.

```
switch(config-tap-agg)#mode mixed module linecard 3,4 profile tap-  
aggregation-default  
switch(config-tap-agg)#mode mixed module linecard 5,6 profile tap-  
aggregation-extended  
switch(config-tap-agg)#
```

To disable TAP aggregation on a linecard set, complete the following steps:

1. Enable the switch for configuration.

```
switch>configure terminal
```

2. Enable TAP aggregation mode.

```
switch(config)#tap aggregation
```

3. Disable TAP aggregation for a linecard set.

```
switch(config-tap-agg)#no mode mixed module linecard 3,4  
switch(config-tap-agg)#
```



Note: If a TAP is a port-channel, its members must all come from linecards using the same profile.

19.1.4.6 Two-Way Ports for TAP Aggregation

While in TAP aggregation mode, there is support for traffic only in one direction through either TAP ports that receive packets from mirroring, or through optical TAP or tool ports that send out packets to customer devices. Two-way ports for TAP aggregation allow bidirectional transmit and receive capability on a single port in TAP aggregation mode. Using the TAP-tool switchport mode enables both TAP and tool configurations simultaneously on an interface.

- [Two-Way Ports Platform Compatibility](#)
- [Two-Way Ports Configuration](#)

19.1.4.6.1 Two-Way Ports Platform Compatibility

The following platforms support two-way ports for TAP aggregation.

- DCS-7280R
- DCS-7280R2
- DCS-7500R
- DCS-7500R2

19.1.4.6.2 Two-Way Ports Configuration

To enable a two-way port, use the **tap-tool** option of the `switchport mode` command.

Example

The following commands configure Ethernet interface 4/1 as a two-way port, allowing it to function as both a TAP and a tool port.

```
switch(config)#interface ethernet 4/1
switch(config-if-Et4/1)#switchport mode tap-tool
switch(config-if-Et4/1)#
```

Additional configurations for TAP and tool functionality on the interface remain the same. Once the user enables the TAP-tool switchport mode on the interface, they can use the existing TAP and tool mode commands to enable their respective configurations.

Arista recommends using this feature with unidirectional send-receive enabled on the interface, which allows the receiver and transmitter for the interface to operate independently. If one goes down, the other remains active. To enable unidirectional send-receive on an interface, use the **unidirectional send-receive** command.

Example

These commands enable unidirectional send-receive on Ethernet interface 4/1.

```
switch(config)#interface ethernet 4/1
switch(config-if-Et4/1)#unidirectional send-receive
switch(config-if-Et4/1)#
```

19.1.4.7 TAP Aggregation QoS Handling on TAP Ports

Before EOS 4.20.5F, QoS behavior was not enforced for TAP aggregation ports, meaning that QoS behavior for packets passing through the device was not changed.

- [QoS Handling Platform Compatibility](#)
- [QoS Handling Configuration](#)
- [Displaying QoS Handling Status](#)

19.1.4.7.1 QoS Handling Platform Compatibility

The following platforms support QoS handling on TAP ports.

- DCS-7280E
- DCS-7280R
- DCS-7500E
- DCS-7500R
- DCS-7280R2



Note: QoS is not available on TAP aggregation ports on the DCS-7150.

19.1.4.7.2 QoS Handling Configuration

Trust Mode of TAP Ports

TAP ports are in QoS untrusted mode by default. This means that the QoS marking of an incoming packet is not trusted when determining the QoS attributes of the packet. Therefore, the default QoS handling takes place. Consider the default CoS to traffic class mapping in the following example.

```
switch(config)#show qos maps
[...]
Cos-tc map:
  cos:  0  1  2  3  4  5  6  7
  -----
  tc:   1  0  2  3  4  5  6  7
[...]
```

The Class of Service (CoS) field of incoming packets is ignored and is assumed to be zero. In this example, all packets are assigned to traffic class 1 when using the above mapping.

To override the default trust mode behavior on a TAP port, use the `qos trust` command.

Example

The following commands override the default trust mode behavior on Ethernet port 1, configuring it to use Class of Service (CoS) trust mode instead so that incoming packets will be placed in their CoS-marked classes.

```
switch(config-if-Et1)#qos trust cos
switch(config-if-Et1)#
```

Class of Service Rewrite of TAP Ports

By default, TAP ports do not override the existing Class of Service (CoS) field of incoming packets. In other words, the CoS marking of steered packets is not changed in any way.

However, the CoS field of added tags may change according to the traffic class to CoS mapping. For example, the identity tag added by TAP ports may have the CoS value from the global traffic class to CoS mapping. Consider the following mapping:

```
switch(config)#show qos maps
[...]
Tc-cos map:
  tc:   0  1  2  3  4  5  6  7
  -----
  cos:  1  7  2  3  4  5  6  0
[...]
```

Using this mapping, the added tag CoS field of packets assigned to traffic class 1 may be set to 7.

19.1.4.7.3 Displaying QoS Handling Status

Use the [Displaying QoS Handling Status](#) to see the active QoS mappings.

Example

This command displays the QoS maps that are configured on the switch.

```

switch#show qos maps
Number of Traffic Classes supported: 8
Number of Transmit Queues supported: 8
Cos Rewrite: Disabled
Dscp Rewrite: Disabled

Cos-tc map:
cos:  0  1  2  3  4  5  6  7
-----
tc:   1  0  2  3  4  5  6  7

Dscp-tc map:
d1 :  d2 0  1  2  3  4  5  6  7  8  9
-----
0 :    1  1  1  1  1  1  1  1  0  0
1 :    0  0  0  0  0  0  2  2  2  2
2 :    2  2  2  2  3  3  3  3  3  3
3 :    3  3  4  4  4  4  4  4  4  4
4 :    5  5  5  5  5  5  5  5  6  6
5 :    6  6  6  6  6  6  7  7  7  7
6 :    7  7  7  7

Tc-cos map:
tc:   0  1  2  3  4  5  6  7
-----
cos:  1  0  2  3  4  5  6  7

Tc-dscp map:
tc:    0  1  2  3  4  5  6  7
-----
dscp:  8  0 16 24 32 40 48 56

Tc - tx-queue map:
tc:          0  1  2  3  4  5  6  7
-----
tx-queue:  0  1  2  3  4  5  6  7

switch#

```

19.1.4.8 Identity VLAN Tagging

By default, tool port output packets are identical to the replicated packets they receive from the tap ports to which they are associated. Identity tagging modifies packets sent by tool ports by adding a dot1q VLAN tag that identifies the originating TAP port. Each TAP port is associated with an identity number. Tool ports that are configured to add an identity tag append the originating TAP port's identity number in the outer layer (or s-VLAN) tag.

The following sections describe identity VLAN tagging on TAP and tool ports.

- [Tap Port Identity Value Configuration](#)
- [Tool Port Identity Tag Configuration](#)

Tap Port Identity Value Configuration

The `switchport tap identity` command configures the TAP port identity value for the configuration-mode interface. The default identity value for all TAP ports is 1.

Example

These commands configure 1042 as the identity value for Ethernet interface 42 and display the result.

```
switch(config)#interface ethernet 42
switch(config-if-Et42)#switchport tap identity 1042
switch(config-if-Et42)#show interface ethernet 41-43 tap
Port      Configured      Status          Native  Id  Truncation
  Default
  Mode
  Group
-----
Et41      tap             tap            400    1  0
---
Et42      tap             tap             1      1042 0
---
Et43      tap             tap             1      1  0
---
switch(config-if-Et42)#
```

Tool Port Identity Tag Configuration

The `switchport tool identity` command configures the configuration-mode interface to include a tier-1 VLAN tag (dot1q) in packets it transmits. The VLAN number on the dot1q tag is the identity value configured for the TAP port that supplies the packets. By default, tool ports do not encapsulate packets with the tier-1 VLAN tag.

Example

These commands configure port channel 102 to include the identity tag in packets it transmits.

```
switch(config)#interface port-channel 102
switch(config-if-Po102)#switchport tool identity dot1q
switch(config-if-Po102)#show interface port-channel 101-103 tool
Port      Configured      Status          Allowed  Id
  Timestamp
  Mode
  Vlans
  Tag
-----
Po101     tool           tool           1001-1020  Off
---
Po102     tool           tool           1010-1015  On
---
Po103     tool           tool           1010-1030  Off
---
switch(config-if-Po102)#
```

19.1.4.9 TAP Aggregation Group Configuration

TAP aggregation groups associate a set of TAP ports with a set of tool ports. A tool port replicates packets it receives from TAP ports that are in the aggregation groups to which it belongs. A TAP port can be configured to send data to multiple TAP aggregation groups. Tool ports may belong to multiple TAP aggregation groups. TAP aggregation groups may contain multiple TAP ports and multiple tool ports.

The following sections describe the configuration of TAP aggregation groups:

- [Assigning a Tool Port to a TAP Aggregation Group](#)
- [Assigning TAP Ports to a TAP Aggregation Group](#)
- [Viewing TAP Aggregation Group Assignments](#)
- [LAGs in Tool Groups](#)

Assigning a Tool Port to a TAP Aggregation Group

Tool ports are assigned to a TAP aggregation group through the `switchport tool group` command. Each command either creates a list or alters the existing list of groups to which a tool port belongs.

Examples

- These commands create the list of TAP aggregation groups for port-channel interface 101.

```
switch(config)#interface port-channel 101
switch(config-if-Po101)#switchport tool group set analyze1
analyze2 analyze3
switch(config-if-Po101)#show active
interface Port-Channel101
  switchport mode tool
  switchport tap identity 2101
  switchport tool allowed vlan 1001-1020
  switchport tap default group tag-9
  switchport tool group set analyze3 analyze1 analyze2
switch(config-if-Po101)#
```

- These commands remove “analyze-1” from port channel 101’s TAP aggregation group list.

```
switch(config-if-Po101)#switchport tool group remove analyze1
switch(config-if-Po101)#show active
interface Port-Channel101
  switchport mode tool
  switchport tap identity 2101
  switchport tool allowed vlan 1001-1020
  switchport tap default group tag-9
  switchport tool group set analyze3 analyze2
switch(config-if-Po101)#
```

Assigning TAP Ports to a TAP Aggregation Group

TAP ports are assigned to a TAP aggregation group using the `switchport tap default group` command. Multiple ports are added to a group by entering the command in interface configuration mode for each port.

Example

These commands assign Ethernet interfaces 41 through 43 to TAP aggregation groups “analyze2” (41 and 42) and “analyze3” (43).

```
switch(config)#interface ethernet 41-42
switch(config-if-Et41-42)#switchport tap default group analyze2
switch(config-if-Et41-42)#interface ethernet 43
switch(config-if-Et43)#switchport tap default group analyze3
switch(config-if-Et43)#show interface ethernet 41-43 tap
Port          Configured      Status          Native  Id  Truncation
  Default
  Mode
  Group
-----
Et41         tap            tap            400    1  0
  analyze2
Et42         tap            tap             1    1042 0
  analyze2
Et43         tap            tap             1     1  0
  analyze3
switch(config-if-Et43)#
```

Viewing TAP Aggregation Group Assignments

TAP aggregation group membership is displayed by `show tap aggregation groups`. Options allow the display of individual groups or of all configured groups. The command displays active tool and TAP ports by default, and provides an option to display configured ports that are not active.

Example

This command displays the contents of all configured TAP aggregation groups.

```
switch#show tap aggregation groups
Group Name                               Tool Members
-----
analyze2                                 Po101, Po102
analyze3                                 Po101, Po103

Group Name                               Tap Members
-----
analyze2                                 Et41, Et42
analyze3                                 Et43
switch#
```

LAGs in Tool Groups

Link Aggregation Groups (LAGs) can be included in tool groups for load balancing. A tool group can contain both LAGs and regular ports. Each member of a tool group receives one copy of the traffic destined to the group. Traffic is replicated to tool group members using multicast replication. The traffic replicated to LAGs is then load balanced to their members as per load-balance policies configured on the system.

If a tool group has no more than 60 members with at least one hardware LAG, then the replication mode of the tool group is set to ingress-only. Otherwise, the replication mode of the tool group is set to the configured system default multicast replication mode. See [platform sand multicast replication default](#) for more information on configuration of the system default replication mode.

Example

The following command changes the system-wide default multicast replication mode to ingress.

```
switch(config)#platform sand multicast replication default
ingress
switch(config)#
```

19.1.5 TAP Aggregation Extra MPLS Pop Configuration

MPLS pop is configurable per tap port as follows to pop one to three labels:

```
(config-if-Et1/1)#switchport tap mpls pop all
```

However, MPLS pop for four to six labels requires a user defined TAP Aggregation profile based on off of tap-aggregation-extended. This profile must have one action and three fields configured under the tapagg port feature, such as the following:

```
(config)#hardware tcam
(config-hw-tcam)#profile foo copy tap-aggregation-extended
(config-profile-foo)#feature tapagg port
(config-profile-foo-feature-tapagg-port)#action set-fwd-header
(config-profile-foo-feature-tapagg-port)#key field mpls-label1-l
ower-24b mpls-label2-lower-24b mpls-label3-lower-24b
(config-profile-foo-feature-tapagg-port)#tap aggregation
Saving new profile 'foo'
(config-tap-agg)#mode exclusive profile foo
```

With the above profile changes, four to six MLPS label pop is additionally supported when the MPLS pop feature is configured on a tap port.

To check if a profile is installed correctly, use the `show hardware tcam profile` command.

```
(config-tap-agg)#show hardware tcam profile
```

Upon successful installation of a TAP Aggregation profile, you should see a display similar to the following:

Configuration	Status
FixedSystem	foo* foo

```
* configuration overridden by TapAgg
```

19.1.5.1 Configuring a Local LFIB Convergence Delay for Protected Node or Adjacency Segments

The point of local repair (PLR) switches to the TI-LFA backup path on link failure or BFD neighbor failure but switches back to the post-convergence path once the PLR computes SPF and updates its LFIB. This sequence of events can lead to micro-loops in the topology if the PLR converges faster than other routers along the post-convergence path. So a configuration option is provided to apply a delay, after which the LFIB route being protected by the TI-LFA loop-free repair path will be replaced by the post-convergence LFIB route.

To configure a convergence delay only to LFIB routes that are being protected, the following command is used either in the router IS-IS mode or the router IS-IS address-family sub-mode. A default of 10 seconds is used when using the command without an explicitly specified delay.

```
switch(config-router-isis-af)#timers local-convergence-delay  
[<delay_in_seconds>] protected-prefixes
```

19.1.6 TAP Aggregation Traffic Steering

Traffic steering is a TAP aggregation process that uses class maps and policy maps to direct data streams at tool ports that are not otherwise associated to the ingress TAP port. A policy map is a data structure that filters data streams upon which identity VLAN tagging or TAP aggregation group assignment is implemented.

TAP-aggregation class maps and policy maps are similar to QoS and control-plane maps. However, policy maps and their components are not interchangeable among function types.

19.1.6.1 TAP Aggregation Policies

A policy map filters data packets by using classes and match rules. Each class contains an eponymous class map and a traffic resolution command. Each match rule contains packet content descriptors and a traffic resolution parameter.

- A class map uses ACLs that identify packets that comprise a specified data stream
- Packet content descriptors specify packet field values that are compared to inbound packets.
- A traffic resolution command or parameter specifies data handling methods for filtered traffic.

Each data packet entering an entity to which a policy map is assigned is managed as defined by the traffic resolution command of the highest priority class or rule that matches the packet.

Class maps are user-created and can be edited or deleted. They filter traffic with IPv4 ACLs and are listed in *running-config*. TAP aggregation traffic resolution commands do one the following:

- specify a TAP aggregation group to direct the packet.
- specify a VLAN number for identity tagging the packet.

TAP aggregation policy maps do not define an implicit deny statement. Packets that do not match a policy map class or rule are replicated and sent out tool ports specified by the default aggregation group assigned to the ingress TAP port. If no default group is selected, these packets are dropped.

19.1.6.2 Configuring TAP Aggregation Traffic Policies

TAP aggregation traffic policies are implemented by creating class maps and policy maps, then applying the policy maps to Ethernet and port-channel interfaces.

Creating Class Maps

A class map is an ordered list of IPv4 access control lists (ACLs). Each ACL is assigned a sequence number that specifies its priority in the class map. TAP aggregation class maps utilize ACL permit rules to pass packets and deny rules to drop packets.

Class maps are created and modified in class-map configuration mode, which is entered using the `class-map type tapagg`. The `match (class-map (tapagg))` command inserts a specified ACL into the class map, assigning it a sequence number that denotes its placement.

Class-map configuration mode is a group-change mode. Changes made in a group-change mode are saved by exiting the mode. The `show active` command displays the saved version of class map. The `exit` command returns the switch to global configuration mode and saves pending class-map changes. The `abort` command returns the switch to global configuration mode and discards pending changes.

Examples

- This command creates a TAP aggregation class map named `t-class_1` and places the switch in class-map configuration mode.

```
switch(config)#class-map type tapagg match-any t-class_1
switch(config-cmap-t-class_1)#
```

- These commands add two IPv4 ACLs (`tacl-1` and `tacl-2`) to the `t-class_1` class map. The commands use the default method of assigning sequence numbers to the ACLs.

```
switch(config-cmap-t-class_1)#match ip access-group tacl-1
switch(config-cmap-t-class_1)#match ip access-group tacl-2
switch(config-cmap-t-class_1)#
```

- These commands exit class-map configuration mode, store pending changes to `running-config`, then display the class map.

```
switch(config-cmap-t-class_1)#exit
switch(config)#class-map type tapagg match-any t-class_1
switch(config-cmap-t-class_1)#show active
class-map type tapagg match-any t-class_1
10 match ip access-group tacl-1
20 match ip access-group tacl-2
switch(config-cmap-t-class_1)#
```

Creating Policy Maps

Policy maps are created and modified in policy-map configuration mode. A policy map is an ordered list of classes and match rules. Policy maps are edited by adding or removing map elements. Data packets are managed by commands of the highest priority class or rule that matches the packet.

Classes

Each class contains a class map, a set command, and a sequence number:

- The **class map** identifies a data stream by using an ordered list of ACLs. Class maps are configured in class-map (tapagg) configuration mode.
- The **set** command specifies the replication method for filtered data packets, either through an associated aggregation group or identity VLAN tagging.
- The **sequence number** specifies the class's priority within the policy map. Lower sequence numbers denote higher priority.

Matching Rules

Each rule contains a filter list, an action, and a sequence number:

- The **filter list** identifies a data stream by using a set of packet field values.
- The action, (**SET_VALUE** parameter) specifies the replication method of filtered data packets, either through an associated aggregation group or identity VLAN tagging.
- The **sequence number** specifies the rule's priority within the policy map. Lower sequence numbers denote higher priority.

Policy-map and policy-map-class configuration modes are group-change modes. Changes are saved with the **exit** command or discarded with the **abort** command. The **show active** and **show pending** commands display the saved and modified policy map versions respectively.

The **class (policy-map (tapagg))** command enters policy-map configuration mode.

Example

This command creates the TAP aggregation policy map named **t-policy_1** and places the switch in policy-map configuration mode.

```
switch(config)#policy-map type tapagg t-policy_1
switch(config-pmap-t-policy_1)#
```

The **class (policy-map (tapagg))** command adds a class to the configuration mode policy map and places the switch in policy-map-class configuration mode for adding a traffic resolution command to the class. The **set (policy-map-class (tapagg))** command specifies the data replication method for traffic filtered by the associated class map in the configuration-mode policy map. The **set** command performs one of the following replication actions for filtered data packets.

- specifies an aggregation group.
- specifies a VLAN identity tag for replicated packets.
- specifies an aggregation group and a VLAN identity tag.

Examples

- These commands add the **t-class_1** class map to the **t-policy_1** policy map, associate a set statement with the class, then save the policy map by exiting the modes. Packets filtered by the class map are identity tagged with **VLAN 444** and replicated as specified by the **t-grp** aggregation group.

```
switch(config-pmap-t-policy_1)#class t-class_1
switch(config-pmap-c-t-policy_1-t-class_1)#set aggregation-group
t-grp id-tag 444
switch(config-pmap-c-t-policy_1-t-class_1)#exit
switch(config-pmap-t-policy_1)#exit
switch(config)#policy-map type tapagg t-policy_1
switch(config-pmap-t-policy_1)#show active
policy-map type tapagg t-policy_1
10 class t-class_1
set aggregation-group t-group id-tag 444
switch(config-pmap-t-policy_1)#
```

The **match (policy-map (tapagg))** command adds a match rule to the configuration-mode TAP aggregation policy map.

- This command enters policy-map configuration mode for **t-policy_1**, then creates a match rule for the policy map that filters OSPF packets and replicates them as specified by **t-grp** TAP aggregation group.

```
switch(config-pmap-t-policy_1)#match ip ospf any any set
aggregation-group t-grp
```



```
switch(config-pmap-t-policy_1)#
```

Applying Policy Maps to an Interface

The `service-policy type tapagg (Interface mode)` command applies a specified policy map to the configuration-mode interface.

Example

These commands apply the `t-policy_1` policy map to *interface ethernet 17*.

```
switch(config)#interface ethernet 17
switch(config-if-Et17)#service-policy type tapagg input tpolicy_1
switch(config-if-Et17)#
```

Stripping VLAN Tags

The traffic-steering policies in tap aggregation mode allows steering traffic from tap ports to tool ports using `set (policy-map-class (tapagg))` command, while the 'set id-tag' tags the traffic with the specified VLAN ID in the dot1q format. The `class (policy-map (tapagg))` command allows removing VLAN tags from the steered traffic. It supports all traffic types that the traffic steering policies support such as IPv4, IPv6, and MAC.

A tap port is an interface that receives a data stream where two network ports exchange.

A tool port is an interface that replicates data streams received by one or more tap ports. Tool ports connect to the devices that process monitored data streams.

Example

These commands place the switch in policy-map-class to add the t-class_1 class map to the t-policy_1 policy map. The first, second, or both of the 2 outer-most VLAN tags are stripped.

```
switch(config)#policy-map type tapagg t-policy_1
switch(config-pmap-t-policy_1)#class t-class_1
switch(config-pmap-t-policy_1-t-class_1)#set aggregation-group t-group
remove dot1q outer 1-2
switch(config-pmap-c-t-policy_1-t-class_1)#set aggregation-group t-group
id-tag 10
switch(config-pmap-c-t-policy_1-t-class_1)#set id-tag 10 remove dot1q
outer 1
switch(config-pmap-c-t-policy_1-t-class_1)#set aggregation-group t-group
switch(config-pmap-c-t-policy_1-t-class_1)#set id-tag 10
switch(config-pmap-c-t-policy_1-t-class_1)#set aggregation-group t-group
id-tag 10 remove dot1q outer 1-2
```

19.1.6.3 Traffic Steering to Match Inner Header Fields

This feature allows matching the inner header fields (either IPv4 or IPv6 inner fields) of encapsulated traffic.

The following convention is adopted when describing an encapsulated traffic: <inner-protocol>-over-<outer-protocol>. For example, the IPv4-over-IPv6 packet indicates that the inner fields belong to IPv4 protocol and the outer fields belong to IPv6 protocol.

Platform Compatibility

- DCS-7280R/R2/R3 series
- DCS-7500R/R2/R3 series
- DCS-7020R series

Supported Packet Types and Inner Header Fields

The types of traffic for which inner header field matching is supported are:

1. IP-over-IP traffic
2. IP-over-GRE traffic, with the following packet format supported:
 - [Eth | IPv4 or IPv6 | GRE | Inner IPv4 or IPv6]
 - [Eth | IPv4 | GRE | Inner Eth | Inner IPv4], which will be referred to as L2-GRE packet
3. IP-over-GTP traffic (only in DCS-7280R3 and DCS-7500R3 series), with the following packet format supported
 - [Eth | IPv4 | GTP | Inner IPv4 or IPv6]
 - [Eth | IPv6 | GTP | Inner IPv4 or IPv6]

The following inner header fields are supported:

- inner source IP address
- inner destination IP address
- inner TCP/UDP protocol
- inner source port number
- inner destination port number.

19.1.6.3.1 Configuring Traffic Steering to Match Inner Header Fields

To enable traffic steering with an ACL rule that matches the inner IP addresses, a user-defined TCAM profile must be configured for each type of IP protocol to which the inner IP addresses belong. For example, to match the inner IPv4 addresses of an IPv4 packet (i.e. IPv4-over-IPv4 traffic) or the inner IPv4 addresses of an IPv6 packet (i.e. IPv4-over-IPv6 traffic), one user-defined TCAM profile must be configured. A different user-defined TCAM profile is needed if matching the inner IPv6 addresses of an IPv4 packet or the inner IPv6 addresses of an IPv6 packet is desired.

The following commands show how to configure different TCAM profiles needed to enable support for matching inner IP headers, depending on the desired inner IP version, and inner IP header fields to be matched. These TCAM profiles are referred to as user-defined TCAM profiles and created based on the existing TCAM profile `tap-aggregation-extended`.

TCAM Profile to Match Inner IPv4 Header Fields

Match inner IPv4 addresses only.

The following commands configure the TCAM profile for matching only the inner source and destination IP addresses of IPv4 traffic based on the existing TCAM profile `tap-aggregation-extended`.

Example

```
switch(config)#hardware tcam
switch(config-hw-tcam)#profile tap-aggregation-user-inner-ip4 copy tap-
aggregation-extended
switch(config-hw-tcam-profile-tap-aggregation-user-inner-ip4)#feature
tapagg ip
switch(config-hw-tcam-profile-tap-aggregation-user-inner-ip4-feature-
tapagg-ip)#no key field src-ip dst-ip
switch(config-hw-tcam-profile-tap-aggregation-user-inner-ip4-feature-ta
pagg-ip)#key field inner-src-ip-high inner-src-ip-low inner-dst-ip-high
inner-dst-ip-low
switch(config-hw-tcam-profile-tap-aggregation-user-inner-ip4-feature-
tapagg-ip)#feature tapagg ipv6
switch(config-hw-tcam-profile-tap-aggregation-user-inner-ip4-feature-tapa
gg-ipv6)#no key field src-ipv6 src-ipv6-high dst-ipv6
```

```
switch(config-hw-tcam-profile-tap-aggregation-user-inner-ip4-feature-
tapagg-ipv6)#key field inner-src-ip-high inner-src-ip-low inner-dst-ip-
high inner-dst-ip-low
switch(config-hw-tcam-profile-tap-aggregation-user-inner-ip4-feature-
tapagg-ipv6)#exit
switch(config-hw-tcam-profile-tap-aggregation-user-inner-ip4)#exit
```

Match inner IPv4 addresses, inner TCP/UDP protocol and inner port numbers for IP-over-IP and IP-over-GRE traffic.

In addition to matching inner IPv4 addresses, the previous user-defined TCAM profile can also be configured to match the inner TCP/UDP protocol and their corresponding port numbers. The commands to configure these inner fields are shown below.

Note that, due to hardware limitation, the feature “tapagg mac” is disabled in this TCAM profile to make room for matching additional inner header fields.

Example

```
switch(config-hw-tcam)#profile tap-aggregation-user-inner-ip4
switch(config-hw-tcam-profile-tap-aggregation-user-inner-ip4)#no feature
tapagg mac
switch(config-hw-tcam-profile-tap-aggregation-user-inner-ip4)#feature
tapagg ip
switch(config-hw-tcam-profile-tap-aggregation-user-inner-ip4-feature-
tapagg-ip)#no key field outer-vlan-id inner-vlan-id l4-src-port l4-dst-
port udf-16b-1 udf-16b-2 udf-16b-3 udf-16b-4 udf-32b-1 udf-32b-2
switch(config-hw-tcam-profile-tap-aggregation-user-inner-ip4-feature-
tapagg-ip)#key field inner-ip-protocol inner-l4-src-port inner-l4-dst-
port
switch(config-hw-tcam-profile-tap-aggregation-user-inner-ip4-feature-tapa
gg-ip)#feature tapagg ipv6
switch(config-hw-tcam-profile-tap-aggregation-user-inner-ip4-feature-tapa
gg-ipv6)#no key field l4-src-port l4-dst-port
switch(config-hw-tcam-profile-tap-aggregation-user-inner-ip4-feature-
tapagg-ipv6)#key field inner-ip-protocol inner-l4-src-port inner-l4-dst-
port
switch(config-hw-tcam-profile-tap-aggregation-user-inner-ip4-feature-tapa
gg-ipv6)#exit
switch(config-hw-tcam-profile-tap-aggregation-user-inner-ip4)#exit
```

Match inner IPv4 addresses, inner TCP/UDP protocol and inner port numbers for L2-GRE packets.

The same user-defined TCAM profile can be updated to support traffic steering that matches on inner header fields for L2-GRE packets, simply by adding a new packet type.

Example

```
switch(config-hw-tcam)#profile tap-aggregation-user-inner-ip4
switch(config-hw-tcam-profile-tap-aggregation-user-inner-ip4)#feature
tapagg ip
switch(config-hw-tcam-profile-tap-aggregation-user-inner-ip4-feature-
tapagg-ip)#packet ipv4 eth ipv4 forwarding bridged
switch(config-hw-tcam-profile-tap-aggregation-user-inner-ip4)#feature
tapagg port
switch(config-hw-tcam-profile-tap-aggregation-user-inner-ip4-feature-tapa
gg-port)#packet ipv4 eth ipv4 forwarding bridged
```

Match inner IPv4 addresses, inner TCP/UDP protocol and inner port numbers for IP-over-GTP packets.

We can re-use the same user-defined TCAM profile and update it to support traffic steering that matches on inner header fields for IP-over-GTP packets, simply by adding a new packet type.

Example

```
switch(config-hw-tcam) #profile tap-aggregation-user-inner-ip4
switch(config-hw-tcam-profile-tap-aggregation-user-inner-ip4) #feature
tapagg ip
switch(config-hw-tcam-profile-tap-aggregation-user-inner-ip4-feature-
tapagg-ip) #no packet ipv4 eth ipv4 forwarding bridged
switch(config-hw-tcam-profile-tap-aggregation-user-inner-ip4-feature-t
apagg-ip) #packet ipv4 gtpv1 ipv4 forwarding bridged
switch(config-hw-tcam-profile-tap-aggregation-user-inner-ip4) #feature
tapagg port
switch(config-hw-tcam-profile-tap-aggregation-user-inner-ip4-feature-tapa
gg-port) #no packet ipv4 eth ipv4 forwarding bridged
switch(config-hw-tcam-profile-tap-aggregation-user-inner-ip4-feature-t
apagg-port) #packet ipv4 gtpv1 ipv4 forwarding bridged
switch(config-hw-tcam-profile-tap-aggregation-user-inner-ip4) #feature
tapagg ipv6
switch(config-hw-tcam-profile-tap-aggregation-user-inner-ip4-feature-tapa
gg-port) #packet ipv6 gtpv1 ipv4 forwarding bridged
```

Match inner and outer IPv4 addresses.

If matching a combination of inner and outer IP header fields is desired, the user-defined TCAM profile must be updated to include the desired fields. For example, instead of matching both inner source and inner destination IPv4 addresses as illustrated by this TCAM profile, if users would like to match outer source IPv4 address and inner destination IPv4 address only (and ignoring outer destination and inner source IPv4 addresses). The following commands show how to configure a TCAM profile for such filtering.

Example

```
switch(config) #hardware tcam
switch(config-hw-tcam) #profile tap-aggregation-user-outer-inner-ip4 copy
tap-aggregation-extended
switch(config-hw-tcam-profile-tap-aggregation-user-outer-inner-ip4
) #feature tapagg ip
switch(config-hw-tcam-profile-tap-aggregation-user-outer-inner-ip4-
feature-tapagg-ip) #no key field dst-ip
switch(config-hw-tcam-profile-tap-aggregation-user-outer-inner-ip4-feat
ure-tapagg-ip) #key field inner-src-ip-high inner-src-ip-low
switch(config-hw-tcam-profile-tap-aggregation-user-outer-inner-ip4-
feature-tapagg-ip) #exit
switch(config-hw-tcam-profile-tap-aggregation-user-outer-inner-ip4) #exit
```

TCAM Profile to Match Inner IPv6 Header Fields

Match inner IPv6 addresses only.

These commands are to configure a TCAM profile that can match inner IP addresses of IPv6 traffic are as follows:

Example

```
switch(config) #hardware tcam
switch(config-hw-tcam) #profile tap-aggregation-user-inner-ip6 copy tap-
aggregation-extended
switch(config-hw-tcam-profile-tap-aggregation-user-inner-ip6) #feature
tapagg ip
switch(config-hw-tcam-profile-tap-aggregation-user-inner-ip6-feature-
tapagg-ip) #no key field dst-ip src-ip udf-16b-1 udf-16b-2 udf-16b-3
```

```

udf-16b-4 udf-32b-1 udf-32b-2 outer-vlan-id inner-vlan-id l4-src-port
l4-dst-port l4-ops
switch(config-hw-tcam-profile-tap-aggregation-user-inner-ip6-feature-
tapagg-ip)#key field inner-src-ipv6-high-high-32b inner-src-ipv6-high-
low-32b inner-src-ipv6-low-high-32b inner-src-ipv6-low-low-32b
switch(config-hw-tcam-profile-tap-aggregation-user-inner-ip6-feature-
tapagg-ip)#key field inner-dst-ipv6-high-high-32b inner-dst-ipv6-high-
low-32b inner-dst-ipv6-low-high-32b inner-dst-ipv6-low-low-32b
switch(config-hw-tcam-profile-tap-aggregation-user-inner-ip6-feature-
tapagg-ip)#exit
switch(config-hw-tcam-profile-tap-aggregation-user-inner-ip6)#feature
tapagg ipv6
switch(config-hw-tcam-profile-tap-aggregation-user-inner-ip6-feature-tapa
gg-ipv6)#no key field src-ipv6 src-ipv6-high dst-ipv6 l4-dst-port l4-src-
port
switch(config-hw-tcam-profile-tap-aggregation-user-inner-ip6-feature-
tapagg-ipv6)#key field inner-src-ipv6-high-high-32b inner-src-ipv6-high-
low-32b inner-src-ipv6-low-high-32b inner-src-ipv6-low-low-32b
switch(config-hw-tcam-profile-tap-aggregation-user-inner-ip6-feature-
tapagg-ipv6)#key field inner-dst-ipv6-high-high-32b inner-dst-ipv6-high-
low-32b inner-dst-ipv6-low-high-32b inner-dst-ipv6-low-low-32b
switch(config-hw-tcam-profile-tap-aggregation-user-inner-ip6-feature-
tapagg-ipv6)#exit
switch(config-hw-tcam-profile-tap-aggregation-user-inner-ip6)#exit

```

Match inner IPv6 addresses, inner TCP/UDP protocol and inner port numbers.

In addition to matching inner IPv6 addresses, the previous user-defined TCAM profile can also be configured to match the inner TCP/UDP protocol and their corresponding port numbers. The commands to configure these inner fields are shown below.

Note that, due to hardware limitation, the feature **tapagg mac** is disabled in this TCAM profile to make room for matching additional inner header fields.

Example

```

switch(config-hw-tcam)#profile tap-aggregation-user-inner-ip6
switch(config-hw-tcam-profile-tap-aggregation-user-inner-ip6)#no feature
tapagg mac
switch(config-hw-tcam-profile-tap-aggregation-user-inner-ip6)#feature
tapagg ip
switch(config-hw-tcam-profile-tap-aggregation-user-inner-ip6-feature-
tapagg-ip)#key field inner-ipv6-next-header inner-l4-src-port inner-l4-
dst-port
switch(config-hw-tcam-profile-tap-aggregation-user-inner-ip6-feature-tapa
gg-ip)#feature tapagg ipv6
switch(config-hw-tcam-profile-tap-aggregation-user-inner-ip6-feature-tapa
gg-ipv6)#key field inner-ipv6-next-header inner-l4-src-port inner-l4-dst-
port
switch(config-hw-tcam-profile-tap-aggregation-user-inner-ip6-feature-tapa
gg-ipv6)#exit
switch(config-hw-tcam-profile-tap-aggregation-user-inner-ip6)#exit

```

Match inner IPv6 addresses, inner TCP/UDP protocol and inner port numbers for IP-over-GTP packets.

We can re-use the same user-defined TCAM profile and update it to support traffic steering that matches on inner header fields for IP-over-GTP packets, simply by adding a new packet type.

```

switch(config-hw-tcam)#profile tap-aggregation-user-inner-ip6
switch(config-hw-tcam-profile-tap-aggregation-user-inner-ip6)#feature
tapagg ip

```

```

switch(config-hw-tcam-profile-tap-aggregation-user-inner-ip6-feature-
tapagg-ip)#packet ipv4 gtpv1 ipv6 forwarding bridged
switch(config-hw-tcam-profile-tap-aggregation-user-inner-ip6)#feature
tapagg port
switch(config-hw-tcam-profile-tap-aggregation-user-inner-ip6-feature-tapa
gg-port)#packet ipv4 gtpv1 ipv6 forwarding bridged
switch(config-hw-tcam-profile-tap-aggregation-user-inner-ip6)#feature
tapagg ipv6
switch(config-hw-tcam-profile-tap-aggregation-user-inner-ip6-feature-tapa
gg-port)#packet ipv6 gtpv1 ipv6 forwarding bridged

```

Apply TCAM Profile

To apply the newly-defined TCAM profile use **tap-aggregation-user-inner-ip4** or **tap-aggregation-user-inner-ip6** command.

```

switch(config)#tap aggregation
switch(config-tap-agg)#mode exclusive profile tap-aggregation-user-inner-
ip4

```

For modular systems

```

switch(config)#tap aggregation
switch(config-tap-agg)#mode mixed module Linecard <linecard number>
profile tap-aggregation-user-inner-ip4

```

Set-Up ACL Rules for Matching Inner Header Fields

In order to apply traffic steering for particular packets based on their inner header fields, ACL rules that can filter such traffic must be created, as shown in the example.

1. ACL rule for filtering an IPv4-over-IPv4 traffic based on the inner addresses.

```

switch(config)#ip access-list acl1
switch(config-acl-acl1)#permit ip any any inner ip host 1.2.3.4 host
5.6.7.8

```

2. ACL rule for filtering an IPv4-over-IPv4 traffic based on the outer source and inner destination addresses.

```

switch(config)#ip access-list acl1
switch(config-acl-acl1)#permit ip host 1.2.3.4 any inner ip host any
host 5.6.7.8

```

3. ACL rule for filtering an IPv6-over-IPv4 traffic based on the inner addresses.

```

switch(config)#ip access-list acl2
switch(config-acl-acl2)#permit ip any any inner ipv6 host 1001::abcd
host 2002::cafe

```

4. ACL rule for filtering an IPv4-over-IPv6 traffic based on the inner addresses, inner TCP/UDP protocol, and inner TCP/UDP ports.

```

switch(config)#ipv6 access-list acl3
switch(config-ipv6-acl-acl3)#permit ipv6 any any inner ip tcp host
10.11.12.13 eq 9999 host 20.22.24.26 eq 8888

```

5. ACL rule for filtering an IPv6-over-GRE(IPv4) traffic based on the inner addresses, inner TCP/UDP protocol, and inner TCP/UDP ports.

```

switch(config)#ip access-list acl4

```

```
switch(config-acl-acl4)#permit gre any any inner ipv6 udp host
2019::baba eq 9999 host 1986::deca eq 8888
```

6. ACL rule for filtering an IPv4-over-GTP traffic based on the inner addresses.

```
switch(config)#ip access-list acl5
switch(config-acl-acl5)#permit gtp any any version 1 protocol gtp-u
inner ip host 1.2.3.4 host 5.6.7.8
```

19.1.6.3.2 Limitations

- Only IP (IPv4 and IPv6), GRE and GTP outer protocols are supported.
 - Other outer protocols are not supported.
- Only IP (IPv4 and IPv6), TCP and UDP inner protocols are supported.
 - Other inner protocols are not supported.
- To configure support for matching inner IPv4 addresses (for either IPv4 or IPv6 outer packets), a custom user-defined TCAM profile is required. A different user-defined TCAM profile is needed if matching inner IPv6 addresses is desired.
- The total size of fields to match must not exceed the TCAM key size limitation (which is 320 bit if tap-aggregation-extended system profile is used as the base profile, or 160 bit for tap-aggregation-default system profile). For example, it is not possible to create a user-defined TCAM profile that matches both outer and inner source/destination address pairs for an IPv6-over-IPv6 packet. This is because each IPv6 address is 128 bit, requiring at least 512 bit to match all 4 addresses, and the TCAM key size is limited to 320 bit.

19.1.7 TAP Aggregation GUI

The switch provides a graphical user interface (GUI) for creating and viewing a TAP aggregation configuration and displaying LANZ traffic statistics.

All commands available on the GUI are accessible through the CLI. The TAP aggregation configuration created through either the CLI or the GUI can be viewed and modified through either medium.

This section provides a brief description of the TAP aggregation GUI.

19.1.7.1 Accessing the TAP Aggregation GUI

The URL for the TAP aggregation GUI is: **//hostname/apps/TapAgg/index.html** where the hostname is the switch's configured hostname. The "TAP Aggregation GUI Initial Panel" displays the initial TAP aggregation GUI panel for the switch with the hostname "ro402."

The TAP aggregation panel contains two sections:

- The **configuration section** displays the TAP aggregation configuration, including the TAP interfaces, tool interfaces, and aggregation groups. Links are displayed to indicate interface group membership.
- The component section displays information and control buttons for the active configuration entity. When an entity is not selected, the section displays information for the switch (device).

The configuration section displays TAP aggregation components only when the switch is in TAP aggregation mode. To enter TAP aggregation mode, click the TAP Aggregation icon in the component section for the device. The icon is a toggle mechanism; clicking it again disables TAP aggregation mode.

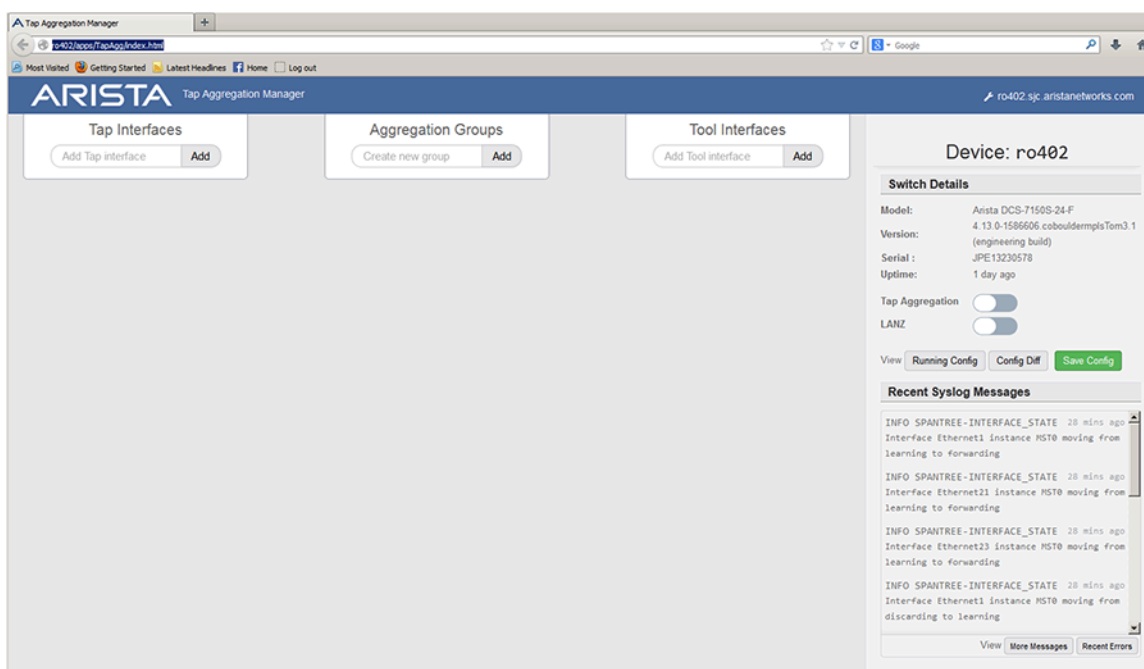

Figure 138: TAP Aggregation GUI Initial Panel

19.1.7.2 Viewing TAP Aggregation Component Details

“[TAP Aggregation GUI Panel with TAP Aggregation Mode Enabled](#)” displays the TAP aggregation panel when the switch is in TAP aggregation mode. The configuration section indicates that the TAP aggregation configuration consists of three tool interfaces, one TAP interface, and four aggregation groups. Ethernet port 10 is the active component; configuration control and traffic information for this interface is available in the component section.

The active component is changed by clicking on the desired component in the configuration section. To display device (switch) information, click on any configuration section outside of any component.

19.1.7.3 Modifying a TAP Aggregation Configuration

The TAP aggregation configuration can be modified only when the switch is in TAP aggregation mode, (see [Accessing the TAP Aggregation GUI](#)). The following is a partial list of configuration tasks that are available from the GUI:

- **adding a TAP or tool interface:** begin typing the interface name in the desired add-interface data entry area to access a drop-down list of available interfaces. Select the desired interface and press the **Add** button.
- **removing an interface from the configuration:** select the desired interface in the configuration section and click the deconfigure button in that interface’s component section.
- **adding an aggregation group:** type the desired name of the new group in the data entry area and press the **Add** button. The TAP aggregation group name can consist of alphanumeric characters and specific special characters (- _ [] { } :) only.
- **adding an interface to an aggregation group:** select the desired interface in the configuration section, then press the icon of the group in the group membership area of the interface’s component section.

Group icons are toggle buttons; clicking the icon of a group to which the interface belongs removes that interface from the group.

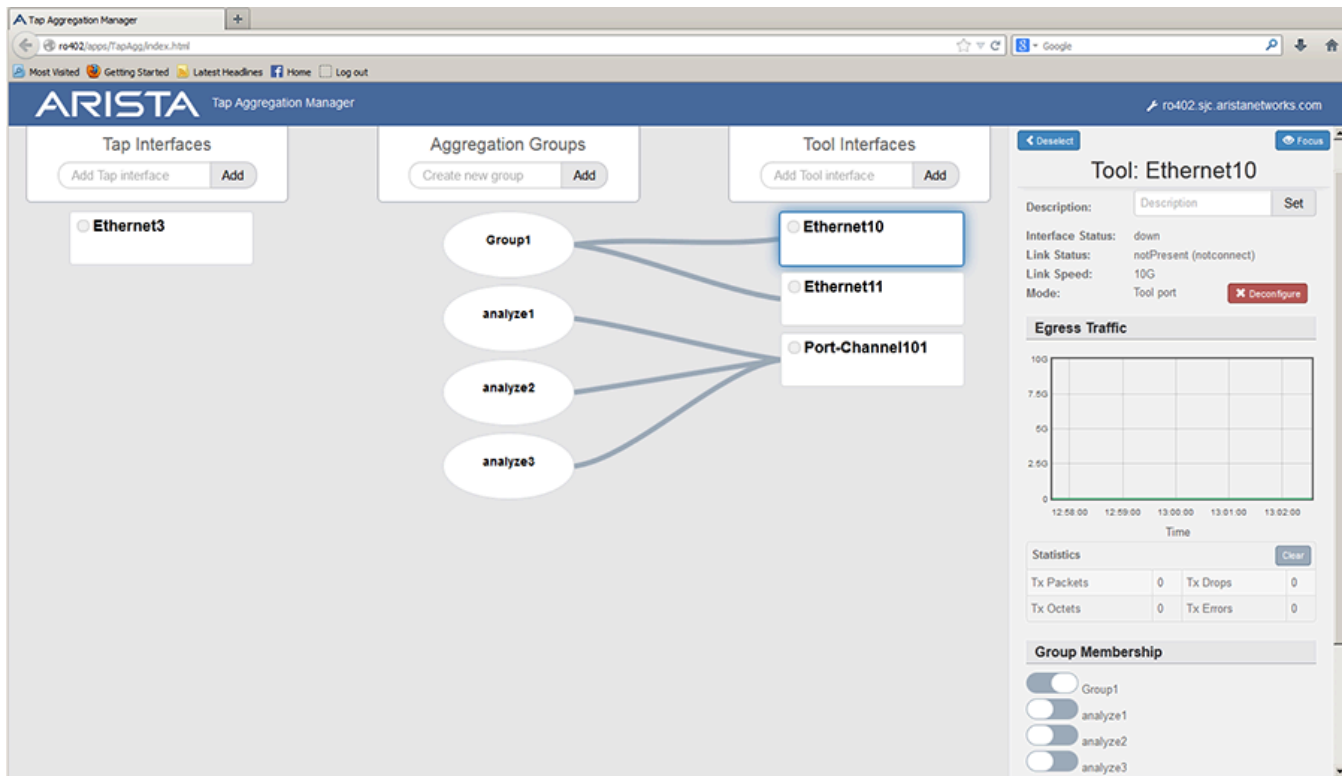

Figure 139: TAP Aggregation GUI Panel with TAP Aggregation Mode Enabled

19.1.8 TAP Aggregation Keyframe and Timestamp Configuration

This section contains the following topics:

- [TAP Aggregation Keyframe and Timestamp Configuration](#)
- [Enabling Timestamp Insertion on an Interface](#)

19.1.8.1 TAP Aggregation Keyframe Generation

Keyframes contain routable IP packets that provide information to relate timestamps with the complete ASIC counter and absolute UTC time. The switch supports a maximum of ten keyframes, which are distinguished by their name label. Each keyframe can egress from every Ethernet port.

Keyframe generation is enabled by the `platform fm6000 keyframe` command. Command options specify ports that transmit keyframes along with the destination MAC address and IP address in the keyframe's header. Other keyframe commands specify the transmission rate and the frame's source:

- the `platform fm6000 keyframe rate` command configures the keyframe's transmission rate.
- the `platform fm6000 keyframe source` command configures the source IP address that is placed in each keyframe's header. The management interface IP address is the default source address.

The source MAC address is the MAC address of the egress interface transmitting the keyframe.

- the `platform fm6000 keyframe device` command configures the 16-bit number that keyframes list as the device ID in their payload.
- the `platform fm6000 keyframe fields skew` command enables the inclusion of clock skew fields in the keyframe.
- the `show platform fm6000 keyframe` command displays keyframe configuration information.

Examples

- This command enables the generation of a keyframe named “key-1” and configures it to egress from Ethernet interfaces 11 through 15 with a source IP address of 10.21.1.4 and a MAC address of 10.4E21.9F11.

```
switch(config)#platform fm6000 keyframe key-1 interface
ethernet 11-15 10.21.1.4 10.4E21.9F11
switch(config)#
```

- This command configures the generation rate for the keyframe of 10 frames per second on each of the five interfaces that it is configured to egress.

```
switch(config)#platform fm6000 keyframe key-1 rate 10
switch(config)#
```

- This command enables the generation of a keyframe named “key-1” and configures 100 as the value that is placed in the keyframe’s device ID field.

```
switch(config)#platform fm6000 keyframe key-1 device 100
switch(config)#
```

- This command enables the inclusion of clock skew fields in the keyframe named “key-1.”

```
switch(config)#platform fm6000 keyframe key-1 fields skew
switch(config)#
```

- This command displays configuration information for keyframe “key-1.”

```
switch(config)#show platform fm6000 keyframe

Keyframe key-1
-----
Egress Interface(s): Ethernet11, Ethernet12, Ethernet13,
Ethernet14, Ethernet15
Source IP: 172.22.30.142
Destination IP: 10.21.1.4
Destination MAC: 00:10:4e:21:9f:11
Device ID: 100
Rate: 10 packet(s) per second

switch(config)#
```

19.1.8.2 Enabling Timestamp Insertion on an Interface

Timestamps are based on a frame’s ingress time and applied to frames sent on egress ports, ensuring that timestamps on monitored traffic reflect ingress timing of the original frames. Time-stamping is configured on the egress port where the timestamp is applied to the frame.

When timestamping is enabled on an egress interface, packets leave the interface with timestamps that were applied in hardware when the packet arrived at the switch. This is facilitated by applying a hardware timestamp to all frames arriving on all interfaces when timestamping is enabled on any interface, then removing timestamps on packets egressing interfaces where timestamping is not enabled.

The `mac timestamp` command enables time-stamping on the configuration-mode interface. The switch supports two timestamp modes, which differ in managing the egress frame's 32-bit frame check sequence (FCS):

- **before-fcs:** the switch discards the original FCS, appends the ingress timestamp at the end of the frame data, recalculates a new FCS based on the appended timestamp, then appends the new FCS to the end of the frame. This creates a valid Ethernet frame but does not update headers of any nested protocols.
- **replace-fcs:** the switch replaces the original FCS with the timestamp. This mode maintains the size of the original frame without any latency impact, but the FCS is not valid.

Examples

- These commands enable timestamping in before-fcs mode on Ethernet interface 44.

```
switch(config)#interface ethernet 44
switch(config-if-Et44)#mac timestamp before-fcs
switch(config-if-Et44)#show active
interface Ethernet44
    mac timestamp before-fcs
switch(config-if-Et44)#
```

- These commands disable timestamping on Ethernet interface 44.

```
switch(config-if-Et44)#no mac timestamp
switch(config-if-Et44)#show active
interface Ethernet44
switch(config-if-Et44)#
```

19.1.9 TapAgg GRE Tunnel Termination

The TapAgg GRE Tunnel Termination feature terminates the GRE packets on a TapAgg switch by stripping the GRE header and then letting the decapped packets go through the normal TapAgg path. With this feature, we can use an L3 GRE tunnel to transit tapped traffic to the TapAgg switch over an L3 network. That would widely extend the available use cases for TapAgg.

- Support IPv4 GRE tunnel interfaces only.
- Support the following GRE types: IPoGRE, L2GRE, GREenSPAN, ERSPAN Type I, ERSPAN Type II, and GREenTAP.
- Do packet forwarding/steering on the decapped packets. Not routing.
- Packets can be forwarded to a set of tool ports.
- Have a command to configure for not stripping the GRE header, so that the TapAgg side may use the information present in the GRE metadata.

Platform Compatibility

- DCS-7280R
- DCS-7280R2
- DCS-7280R3 (starting EOS-4.26.1F)
- DCS-7500R
- DCS-7500R2
- DCS-7500R3 (starting EOS-4.26.1F)
- DCS-7800R3 (starting EOS-4.26.1F)

19.1.9.1 Configuring TapAgg GRE Tunnel Termination

The TapAgg GRE Tunnel Termination is allowed to be configured in the following two modes:

- TapAgg Exclusive Mode
- TapAgg Mixed Mode

19.1.9.1.1 TapAgg Exclusive Mode

In Tapagg Exclusive mode, GRE tunnel termination is enabled on a selected tap ports through CLI. When traffic comes into those tap ports, the matched GRE packets is decapped and forwarded to the tap port's default forwarding destinations or the steering destinations if it matches the policy ACLs applied.

Adding the TCAM Feature

Tap tunnel termination on tapAgg exclusive mode is supported by built-in profiles **tap-aggregation-default** and **tap-aggregation-extended**. Custom profiles can support tap tunnel termination with the configuration of the tapagg tunnel termination feature through the following steps:

```
switch#conf
switch(config)#hardware tcam
switch(config-tcam)#profile tap-aggregation-gre copy tap-aggregation-
profile
switch(config-tcam-profile-tap-aggregation-gre)#feature tapagg tunnel
termination copy system-feature-source-profile
switch(config-tcam-feature-tapagg-tunnel-termination)#exit
switch(config-tcam-profile-tap-aggregation-gre)#exit
Saving new profile 'tap-aggregation-gre'
switch(config-tcam)#exit
switch(config)#
```

To check if a TCAM profile has the feature, use the following command:

```
switch(config)#show hardware tcam profile tap-aggregation-gre
Features enabled in TCAM profile tap-aggregation-gre:
mpls
acl port ipv6
tapagg port
tapagg mac
tapagg ip
tapagg ipv6
tapagg tunnel termination
acl port ip
tunnel vxlan
acl port mac
forwarding-destination mpls
```

Change Hardware Forwarding Profile

On DCS-7280R3, DCS-7500R3 and DCS-7800R3 systems, the hardware forwarding profile needs to be set to **system-profile-tap-aggregation** on all linecards.

Enable GRE Termination on a Tap Port

Use `switchport tap encapsulation gre [tunnel destination <dst IP address> [source <src IP address>]] strip` to enable GRE termination on a tap port. The command allows specification of tunnel endpoints, to support termination on a specific tunnel.

```
switch(config-if-Et7/1)#switchport tap encapsulation gre destination
<dst-ip> source <src-ip> strip
```

Without the specification of tunnel endpoints, it will terminate GRE packets for all tunnels. If only the destination endpoint is specified, then any GRE packet that matches this destination is terminated.

Example

In this example the following configuration tap port et7/1 will strip GRE packets for all GRE tunnels and forward the decapped packets to tool group "tool1".

```
switch(config-if-Et7/1)#switchport mode tap
switch(config-if-Et7/1)#switchport tap default group tool1
switch(config-if-Et7/1)#switchport tap encapsulation gre strip
```

GRE Termination into Traffic Steering

If the matched GRE packet also hits the policy map that is applied on the tap port, after stripping the GRE header, the packets are forwarded to the steering destination configured for the policy map. In the example below, a policy map named 'pm' is applied on the tap port which has gre strip enabled on it. Then the GRE packets with an outer destination IP <dst-ip> and source IP <src-ip>, matching the permit rule in the policy map, is forwarded to the tool group 'tool2' after stripping the GRE header.

 **Note:** The ACLs are applied on the original GRE packet, and not the one after the GRE header is stripped.

```
switch(config)#show policy-map type tapagg
Service policy pm
  Configured on:
  Applied on:
    10: Class-map: cm (match-any)
      Match: 10 IP Access List testAcl
            10 permit ip host 1.1.1.1 host 2.2.2.2

  Configured actions: set group tool2

switch(config-if-Et7/1)#show active
interface Ethernet7/1
  service-policy type tapagg input pm
  switchport mode tap
  switchport tap encapsulation gre strip
  switchport tap default group tool1
```

GRE Termination with Ingress/Egress Truncation

When there is truncation enabled, either on the tap port that has GRE termination configured or on the tool port that is configured to egress out the decapped packets, the GRE header is stripped from the truncated packets. In other words, the GRE header stripping occurs after truncation. That means the size of the egress packet will be less than the original expectation. For example, if we have configured to truncate packets to a size of 178 bytes, after enabling GRE termination, the egress out packet for a GREenSpan will have a size of 136. It is 178 minus 42 (the total bytes stripped for GREenSpan).

Configuring the Upstream Switch

In TapAgg exclusive mode, the routing protocols are not running so TapAgg Switch will rely on its upstream switch which has routing protocol enabled to forward the GRE packets to it. Tap ports which are selected to receive the GRE packets should be connected to the upstream switch. The upstream switch needs to configure a static route to forward the GRE packets to the link.

Example

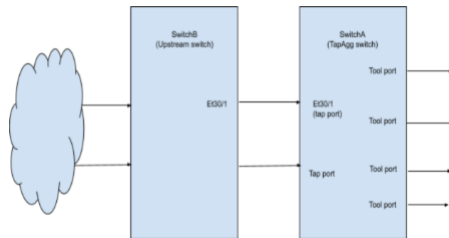

If TapAgg switch A is connected to the upstream switch B through the link between A-et30/1 and B-et30/1 then the static route for forwarding GRE packets with Destination IP address 40.1.1.2 terminated on TapAgg switch A can be configured with the following commands:

```
switchB(config-if-Et30/1)#show active
interface Ethernet30/1
  speed forced 100gfull
  no switchport
  ip address 10.10.10.1/24
SwitchB(config-if-Et30/1)#ip route 40.1.1.2/32 ethernet 30/1
```

The static route should be present in the output of the **show ip route** command.

```
SwitchB#show ip route

VRF: default
Codes: C - connected, S - static, K - kernel,
       O - OSPF, IA - OSPF inter area, E1 - OSPF external type 1,
       E2 - OSPF external type 2, N1 - OSPF NSSA external type 1,
       N2 - OSPF NSSA external type2, B - BGP, B I - iBGP, B E - eBGP,
       R - RIP, I L1 - IS-IS level 1, I L2 - IS-IS level 2,
       O3 - OSPFv3, A B - BGP Aggregate, A O - OSPF Summary,
       NG - Nexthop Group Static Route, V - VXLAN Control Service,
       DH - DHCP client installed default route, M - Martian,
       DP - Dynamic Policy Route, L - VRF Leaked,
       RC - Route Cache Route

Gateway of last resort is not set

C      10.10.10.0/24 is directly connected, Ethernet30/1
S      10.80.0.0/13 [1/0] via 10.240.25.1, Management1
S      10.95.0.0/16 [1/0] via 10.240.25.1, Management1
C      10.240.25.0/25 is directly connected, Management1
S      10.240.0.0/15 [1/0] via 10.240.25.1, Management1
S      10.242.0.0/15 [1/0] via 10.240.25.1, Management1
S      40.1.1.2/32 is directly connected, Ethernet30/1
S      172.16.0.0/12 [1/0] via 10.240.25.1, Management1
```

Setup static ARP entry for the route. **44:4c:a8:be:35:e9** is the MAC address of **A-et30/1**. Please note that any unicast MAC address can be used for static ARP entry.

```
switchB(config)#arp 40.1.1.2 44:4c:a8:be:35:e9 arpa
```

Use the following command to check ARP entries.

```
switchB# show arp
Address                               HWtype  HWaddress          Flags Mask
  Iface
10.240.25.1                           ether   28:99:3a:67:7f:93  C
  mal
40.1.1.2                               ether  44:4c:a8:be:35:e9 CM
  et30_1
```

With the above configurations, the upstream switch B can forward the GRE packets to TapAgg switch A.

19.1.9.1.2 TapAgg Mixed Mode

For a modular system, such as the DCS-7500R or DCS-7500R2, routed ports on a non-TapAgg linecard is used to receive GRE packets. In order to use the tap tunnel termination feature, **dbTapTunnelTermination** must be added to the TCAM profile for the non-TapAgg linecards.

Adding the TCAM Feature

For example, if the current system profile is profile **default**, we can use the following commands to create a new profile **default-with-tap-gre**, which is copied from the current system profile, and add the new feature that we need.

```
switch(config)#hardware tcam
switch(config-tcam)#profile default-with-tap-gre copy default
switch(config-tcam-profile-default-with-tap-gre)#feature tapagg tunnel
  termination copy system-feature-source-profile
switch(config-tcam-feature-tapagg-tunnel-termination)#exit
switch(config-tcam-profile-default-with-tap-gre)#exit
Saving new profile 'default-with-tap-gre'
switch(config-tcam)#exit
```

Use the following command to apply the new TCAM profile.

```
switch(config)#hardware tcam
switch(config-tcam)#system profile default-with-tap-gre
```

Configure TapAgg mixed mode. In the below example, we configure TapAgg mixed mode and leave the linecard 6 in normal mode.

```
switch(config)#tap agg
switch(config-tap-agg)#mode mixed module linecard 3,4,5
! Changing modes may affect available functionality. Unsupported
  configuration elements will be ignored.
switch(config)#show hardware tcam profile
Configuration                               Status
Linecard3 tap-aggregation-default* tap-aggregation-default
Linecard4 tap-aggregation-default* tap-aggregation-default
Linecard5 tap-aggregation-default* tap-aggregation-default
Linecard6 default-with-tap-gre default-with-tap-gre
* configuration overridden by TapAgg
```

There could be some cases where we need to remove some features from the TCAM profile in order to have room to fit the feature 'tapagg tunnel termination' in. This kind of 'tradeoff' is needed when we want this feature to be with a specific user-defined tcam profile.

Below is an example of solving that problem.

```
switch(config)#tap agg
switch(config-tap-agg)#mode mixed module linecard 3,4,5
! Changing modes may affect available functionality. Unsupported
  configuration elements will be ignored.
switch(config)#show hardware tcam profile

```

	Configuration	Status
Linecard3	tap-aggregation-default*	tap-aggregation-default
Linecard4	tap-aggregation-default*	tap-aggregation-default
Linecard5	tap-aggregation-default*	tap-aggregation-default
Linecard6	default-with-tap-gre	ERROR

```
* configuration overridden by TapAgg

switch(config)#hardware tcamswitch(config-tcam)#profile default-with-tap-gre
switch(config-tcam-profile-default-with-tap-gre)#no feature mirror ip
switch(config-tcam-profile-default-with-tap-gre)#no feature pbr ip
switch(config-tcam-profile-default-with-tap-gre)#exitswitch(config-tcam)#show hardware tcam profile

```

	Configuration	Status
Linecard3	tap-aggregation-default*	tap-aggregation-default
Linecard4	tap-aggregation-default*	tap-aggregation-default
Linecard5	tap-aggregation-default*	tap-aggregation-default
Linecard6	default-with-tap-gre	default-with-tap-gre

```
* configuration overridden by TapAgg
```

Change Hardware Forwarding Profile

On DCS-7280R3, DCS-7500R3 and DCS-7800R3 systems, the hardware forwarding profile needs to be set to system-profile-tap-aggregation on all tap agg linecards. Detailed instructions on how to set it can be found in the Resources section.

Configure GRE Tunnel Interface

Configure the GRE tunnel interface that we want the packets it received to be terminated and redirected.

In the below example, the GRE packets for this tunnel interface should have destination IP address "40.1.1.1" and source IP address "40.1.1.2"

```
switch(config)#interface tunnel 1
switch(config-if-Tu1)#tunnel mode gre
switch(config-if-Tu1)#tunnel source 40.1.1.1
switch(config-if-Tu1)#tunnel destination 40.1.1.2
```

For a tunnel interface, if **tunnel source** is configured but **tunnel destination** is not, then any GRE packet with destination IP address matching the tunnel source will be stripped and redirected. In the example below, the GRE packet with destination IP "40.1.1.1" is what we are interested in.

```
switch(config-if-Tu1)#show active
  tunnel mode gre
  tunnel source 40.1.1.1
  tap default group gr1
  tap default interface Ethernet3/1
```

If neither **tunnel source** nor **tunnel destination** is configured, then the GRE packets for any endpoints will be stripped and redirected.

```
switch(config-if-Tu1)#show active
 tunnel mode gre
 tap default group gr1
 tap default interface Ethernet3/1
```

Use the **tap default group** and **tap default interface** commands to configure the redirecting destination. In the example below, the GRE packets sent to interface tunnel 1 will be redirected to tool group gr1 and tool interface et3/1 after stripping the GRE header. (In current version, the target interfaces must be tool ports on TapAgg linecards. A non tool port putting in this command will not take effect.)

```
switch(config)#interface tunnel 1
switch(config-if-Tu1)#tap default group gr1
switch(config-if-Tu1)#tap default interface ethernet 3/1
switch(config-if-Tu1)#
```

If we want to redirect the packets but don't want to strip the GRE header, command "tap encapsulation gre preserve" can be configured for that purpose, not stripping the GRE header.

```
switch(config)#interface tunnel 1
switch(config-if-Tu1)#tap encapsulation gre preserve
switch(config-if-Tu1)#
```

The show command below is used to check the tunnel interface status. In TapAgg mixed mode, routing protocols can run on non-TapAgg linecards, and any routed port in non-TapAgg linecards can be used to receive the GRE packets. For Tap tunnel termination feature, the status of the tunnel interface doesn't have to be **connected**, but there must be some routes to help the GRE packets find the way to the routed ports on this switch.

```
switch(config)#show interfaces tunnel 1
Tunnell is up, line protocol is up (connected)
 Hardware is Tunnel, address is 2801.0102.0800
 Tunnel source 40.1.1.2, destination 40.1.1.1
 Tunnel protocol/transport GRE/IP
 Hardware forwarding enabled
 Tunnel transport MTU 1476 bytes (default)
 Up 35 minutes, 57 seconds
```

Enable Tap Tunnel Termination on TapAgg Linecards in Mixed Mode

If you do want to enable GRE Termination on a specific tap port in TapAgg mixed mode, please follow the **TapAgg exclusive mode** section and refer to configuring TCAM profile and GRE termination for the TapAgg linecard.

19.1.10 TAP Aggregation Commands

Global Configuration Commands

- platform fm6000 keyframe
- platform fm6000 keyframe device
- platform fm6000 keyframe fields skew
- platform fm6000 keyframe rate
- platform fm6000 keyframe source
- platform sand multicast replication default
- platform sand multicast replication ingress maximum
- tap aggregation

Interface Configuration Commands

- mac timestamp
- switchport tap allowed vlan
- switchport tap default group
- switchport tap identity
- switchport tap native vlan
- switchport tap truncation
- switchport tool allowed vlan
- switchport tool group
- switchport tool identity
- switchport tool truncation

Tap Aggregation Configuration Mode

- mode (tap-agg configuration mode)
- mode exclusive no-errdisable (tap-agg configuration mode)

Tap Aggregation Traffic Steering

- class (policy-map (tapagg))
- class-map type tapagg
- match (class-map (tapagg))
- match (policy-map (tapagg))
- policy-map type tapagg
- resequence (class-map (tapagg))
- resequence (policy-map (tapagg))
- service-policy type tapagg (Interface mode)
- set (policy-map-class (tapagg))

Display Commands EXEC Mode

- show hardware tcam profile
- show interfaces tap
- show interfaces tool
- show platform fm6000 keyframe
- show platform sand mcast capacity
- show tap aggregation groups

19.1.10.1 class (policy-map (tapagg))

The **class (policy-map (tapagg))** command places the switch in policy-map-class (TAPagg) configuration mode, which is a group-change mode that defines a TAP aggregation class by associating the class's eponymous class-map to a **set** statement. Upon exiting the policy-map-class mode, the class is placed in the policy-map as specified by an assigned sequence number.

A policy map is an ordered list of classes and match rules. Each class contains a class map, a **set** command, and a sequence number:

- The class map identifies a data stream by using an ordered list of ACLs. Class maps are configured in class-map (tapagg) configuration mode. Data packets are managed by commands of the highest priority class or rule that matches the packet.
- **set** commands specify the replication method of filtered data packets, either through an associated aggregation group or identity VLAN tagging.
- Sequence numbers specify the class's priority within the policy map. Lower sequence numbers denote higher priority.

The **exit** command returns the switch to policy-map configuration mode. However, saving policymap-class changes also requires an exit from policy-map mode. This saves all pending policy map and policy-map-class changes to **running-config** and returns the switch to global configuration mode. The **abort** command discards pending changes and returns the switch to global configuration mode.

The **no class** and **default class** commands remove the class assignment from the configuration mode policy map by deleting the corresponding class configuration from **running-config**.

Command Mode

Policy-Map (tapagg) Configuration accessed through **class (policy-map (tapagg))**

Command Syntax

```
[SEQ_NUM] class class_name
```

```
default [SEQ_NUM] class class_name
```

```
no [SEQ_NUM] class class_name
```

Parameters

- **SEQ_NUM** priority of the class within the policy map. Lower numbers denote higher priority.
 - **<no parameter>** number is derived by adding 10 to number of the map's last class or rule.
 - **1 to 4294967295** number assigned to class.
- **class_name** name of the class.

Guidelines

When a class is not associated with a **set (policy-map-class (tapagg))** command, the filtered traffic is managed as specified by the TAP port's default aggregation group.

Commands Available in Policy-map-class (tapagg) Configuration Mode

- **set (policy-map-class (tapagg))** assigns VLAN identity tag or tap aggregation group to class.
- **exit** returns the switch to parent policy map configuration mode.
- **abort** discards pending class map changes, then returns the switch to global configuration mode.

Related Commands

- **class (policy-map (tapagg))** places the switch in policy-map (tapagg) configuration mode.
- **match (policy-map (tapagg))** assigns a match rule to a TAP aggregation policy map.

Example

These commands place the switch in policy-map-class and add the **t-class_1** class map to the **tpolicy_1** policy map. Packets filtered by the class map are identity tagged with **VLAN 444**.

```
switch(config)#policy-map type tapagg t-policy_1
switch(config-pmap-t-policy_1)#class t-class_1
switch(config-pmap-c-t-policy_1-t-class_1)#set id-tag 444
switch(config-pmap-c-t-policy_1-t-class_1)#exit
switch(config-pmap-t-policy_1)#exit
switch(config)#policy-map type tapagg t-policy_1
switch(config-pmap-t-policy_1)#show active
policy-map type tapagg t-policy_1
10 class t-class_1
set id-tag 444
switch(config-pmap-t-policy_1)#
```

These commands place the switch in policy-map-class to add the t-class_1 class map to the t-policy_1 policy map. The first, second, or both of the 2 outer-most VLAN tags are stripped.

```
switch(config)#policy-map type tapagg t-policy_1
switch(config-pmap-t-policy_1)#class t-class_1
switch(config-pmap-t-policy_1-t-class_1)#set aggregation-group t-group
remove dot1q outer 1-2
switch(config-pmap-c-t-policy_1-t-class_1)#set aggregation-group t-group
id-tag 10
switch(config-pmap-c-t-policy_1-t-class_1)#set id-tag 10 remove dot1q
outer 1
switch(config-pmap-c-t-policy_1-t-class_1)#set aggregation-group t-group
switch(config-pmap-c-t-policy_1-t-class_1)#set id-tag 10
switch(config-pmap-c-t-policy_1-t-class_1)#set aggregation-group t-group
id-tag 10 remove dot1q outer 1-2
```

19.1.10.2 class-map type tapagg

The **class-map type tapagg** command places the switch in class-map (tapagg) configuration mode, which is a group change mode that modifies a tapagg class map. A tapagg class map is a data structure that uses access control lists (ACLs) to define a data stream by specifying characteristics of data packets that comprise the stream. Tapagg policy maps use class maps to specify traffic that is managed by policy map criteria.

The **exit** command saves pending class map changes to **running-config**, then returns the switch to global configuration mode. Class map changes are also saved by entering a different configuration mode. The **abort** command discards pending changes and returns the switch to global configuration mode.

The **no class-map type tapagg** and **default class-map type tapagg** commands delete the specified class map by removing the corresponding class-map type qos command and its associated configuration.

Command Mode

Global Configuration

Command Syntax

```
class-map type tapagg match-any class_name
```

```
no class-map type tapagg match-any class_name
```

```
default class-map type tapagg match-any class_name
```

Parameters

class_name name of class map.

Commands Available in Class-Map (tapagg) Configuration Mode

- [match \(class-map \(tapagg\)\)](#)
- [resequence \(class-map \(tapagg\)\)](#)

Related Commands

[class \(policy-map \(tapagg\)\)](#)

Example

This command creates a TAP aggregation class map named **t-class_1** and places the switch in class-map configuration mode.

```
switch(config)#class-map type tapagg match-any t-class_1
switch(config-cmap-t-class_1)#
```

19.1.10.3 mac timestamp

The **mac timestamp** command enables timestamping on the configuration mode interface.

When timestamping is enabled on an egress interface, packets leave the interface with timestamps that were applied in hardware upon arriving at the switch. This is facilitated by applying a hardware timestamp to all frames arriving on all interfaces when timestamping is enabled on any interface, then removing timestamps on packets egressing interfaces where timestamping is not enabled.

The switch supports two timestamp modes, which differ in managing the egress frame's 32-bit frame check sequence (FCS):

- **before-fcs**: the switch discards the original FCS, appends the ingress timestamp at the end of the frame data, recalculates a new FCS based on the appended timestamp, then appends the new FCS to the end of the frame. This creates a valid Ethernet frame but does not update headers of any nested protocols.
- **replace-fcs**: the switch replaces the original FCS with the timestamp. This mode maintains the size of the original frame without any latency impact, but the FCS is not valid.

The **no mac timestamp** and **default mac timestamp** commands restore the default behavior of disabling timestamping on the configuration mode interface by removing the corresponding **mac timestamp** command from *running-config*.

Command Mode

Interface-Ethernet Configuration

Command Syntax

```
mac timestamp TS_PROPERTY
```

Parameters

- **TS_PROPERTY** specifies the timestamp insertion mode. Options include:
 - **before-fcs** the ingress timestamp is appended to the frame and the FCS is recalculated.
 - **replace-fcs** the ingress timestamp replaces the original FCS.

Examples

- These commands enable timestamping in before-fcs mode on Ethernet interface 44.

```
switch(config)#interface ethernet 44
switch(config-if-Et44)#mac timestamp before-fcs
switch(config-if-Et44)#show active
interface Ethernet44
    mac timestamp before-fcs
switch(config-if-Et44)#
```

- These commands disable timestamping on Ethernet interface 44.

```
switch(config-if-Et44)#no mac timestamp
switch(config-if-Et44)#show active
interface Ethernet44
switch(config-if-Et44)#
```

19.1.10.4 match (class-map (tapagg))

The **match** command adds an ACL to the configuration-mode class map and associates a sequence number to the ACL. A class map is an ordered list of ACLs that define a data stream; the sequence number specifies an ACL's priority within the list. A class map is used by policy maps to filter data packets. Tapagg class maps utilize ACL permit rules to pass packets and deny rules to drop packets.

Class map (tapagg) configuration mode is a group change mode. **Match** statements are not saved to **running-config** until the edit session is completed by exiting the mode.

The **no match** and **default match** commands remove the specified **match** statement from the configuration-mode class map by deleting the corresponding **match** command from **running-config**.

Command Mode

Class-map (tagagg) Configuration accessed through [class-map type tapagg](#) command.

Command Syntax

```
[SEQ_NUM] match ip access-group list_name
no SEQ_NUM] match ip access-group list_name
default SEQ_NUM] match ip access-group list_name
```

Parameters

- SEQ_NUM sequence number assigned to the ACL. Options include:
 - <no parameter> number is derived by adding 10 to the number of the map's last ACL.
 - **1 to 4294967295** number assigned to ACL.
- list_name name of ACL assigned to class map.

Guidelines

match statements accept IPv4 ACLs.

Related Commands

- [class-map type tapagg](#) places the switch in Class-Map configuration mode.
- **exit** saves pending class map changes, then returns the switch to global configuration mode.
- **abort** discards pending class map changes, then returns the switch to global configuration mode.
- [class \(policy-map \(tapagg\)\)](#) assigns a class map to a policy map.

Example

These commands add two IPv4 ACLs ("tacl-1" and "tacl-2") to the "t-class_1" class map, save the command by exiting class-map mode, and re-enter the mode to display the added ACLs.

```
switch(config)#class-map type tapagg match-any t-class_1
switch(config-cmap-t-class_1)#match ip access-group tacl-1
switch(config-cmap-t-class_1)#match ip access-group tacl-2
switch(config-cmap-t-class_1)#exit
switch(config)#class-map type tapagg match-any t-class_1
switch(config-cmap-t-class_1)#show active
  class-map type tapagg match-any t-class_1
    10 match ip access-group tacl-1
    20 match ip access-group tacl-2
switch(config-cmap-t-class_1)#
```

19.1.10.5 match (policy-map (tapagg))

The **match** command adds a rule to the configuration-mode TAP aggregation policy map. A policy map is an ordered list of classes and rules. Each rule contains a filter list, an action, and a sequence number:

- The filter list identifies a data stream through a set of packet field values.
- The action, (**SET_VALUE** parameter) specifies the replication method of filtered data packets, either through an associated aggregation group or identity VLAN tagging.
- The sequence number specifies the rule's priority within the policy map.

The **no match** and **default match** commands remove the **match** rule from the configuration-mode policy by deleting the corresponding statement from **running-config**.

Command Mode

Policy-Map (tapagg) Configuration accessed through [class \(policy-map \(tapagg\)\)](#).

Command Syntax

```
[SEQ_NUM] match [VLAN_TAG] SOURCE_ADDR [SOURCE_PORT] DEST_ADDR [DEST_PORT]
[PROTOCOL] [FLAGS] [MESSAGE] [fragments] [tracked] [DSCP_FILTER] [TTL_FILTER] [log]
SET_VALUE
```

```
no match [VLAN_TAG] SOURCE_ADDR [SOURCE_PORT] DEST_ADDR [DEST_PORT]
[PROTOCOL] [FLAGS] [MESSAGE] [fragments] [tracked] [DSCP_FILTER] [TTL_FILTER] [log]
SET_VALUE
```

```
default match [VLAN_TAG] SOURCE_ADDR [SOURCE_PORT] DEST_ADDR [DEST_PORT]
[PROTOCOL] [FLAGS] [MESSAGE] [fragments] [tracked] [DSCP_FILTER] [TTL_FILTER] [log]
SET_VALUE
```



Note: Commands use a subset of the listed fields. Available parameters depend on specified protocol. Use CLI syntax assistance to view options for specific protocols when creating a permit rule.

Parameters

- SEQ_NUM priority of the rule within the policy map. Lower numbers denote higher priority.
 - <no parameter> number derived by adding 10 to number of the map's last class or rule.
 - <1 to 4294967295> number assigned to class.
- VLAN_TAG VLAN field filter. Options include:
 - <no parameter> packets are not filtered by VLAN field.
 - vlan <1 to 4094> <0 to 4095> VLAN ID and mask.
 - vlan inner <1 to 4094> <0 to 4095> VLAN ID and mask.
 - vlan <1 to 4094> <0 to 4095> inner <1 to 4094> <0 to 4095> VLAN ID and mask.
- PROTOCOL protocol field filter. Values include:
 - <no parameter> packets are not filtered by host name.
 - ahp authentication header protocol (51).
 - icmp internet control message protocol (1).
 - igmp internet group management protocol (2).
 - ip internet protocol IPv4 (4).
 - ospf open shortest path first (89).
 - pim protocol independent multicast (103).
 - tcp transmission control protocol (6).
 - udp user datagram protocol (17).
 - vrrp virtual router redundancy protocol (112).
 - *protocol_num* integer corresponding to an IP protocol. Values range from 0 to 255.

- SOURCE_ADDR and DEST_ADDR source and destination address filters. Options include:
 - *network_addr* subnet address (CIDR or address-mask).
 - any packets from all addresses are filtered.
 - host *ip_addr* IP address (dotted decimal notation).

Source and destination subnet addresses support discontinuous masks.
- SOURCE_PORT and DEST_PORT source and destination port filters. Options include:
 - any all ports.
 - *eq port-1 port-2 ... port-n* a list of ports. Maximum list size is 10 ports.
 - *neq port-1 port-2 ... port-n* the set of all ports not listed. Maximum list size is 10 ports.
 - *gt port* the set of ports with larger numbers than the listed port.
 - *lt port* the set of ports with smaller numbers than the listed port.
 - *range port_1 port_2* the set of ports whose numbers are between the range.
- fragments filters packets with FO bit set (indicates a non-initial fragment packet).
- FLAGS flag bit filters (TCP packets). Use CLI syntax assistance (?) to display options.
- MESSAGE message type filters (ICMP packets). Use CLI syntax assistance (?) to display options.
- tracked rule filters packets in existing ICMP, UDP, or TCP connections.
 - Valid in ACLs applied to the control plane.
 - Validity in ACLs applied to data plane varies by switch platform.
- DSCP_FILTER rule filters packet by its DSCP value. Values include:
 - *<no parameter>* rule does not use DSCP to filter packets.
 - *dscp dscp_value* packets match if DSCP field in packet is equal to *dscp_value*.
- TTL_FILTER rule filters packet by its TTL (time-to-live) value. Values include:
 - *<no parameter>* rule does not use TTL field to filter packets.
 - *ttl eq ttl_value* packets match if ttl in packet is equal to *ttl_value*.
 - *ttl gt ttl_value* packets match if ttl in packet is greater than *ttl_value*.
 - *ttl lt ttl_value* packets match if ttl in packet is less than *ttl_value*.
 - *ttl neq ttl_value* packets match if ttl in packet is not equal to *ttl_value*.
- log triggers an informational log message to the console about the matching packet.
 - Valid in ACLs applied to the control plane.
 - Validity in ACLs applied to data plane varies by switch platform.
- SET_VALUE specifies the replication method for filtered packets.
 - *set aggregation group agg_group* replication specified by aggregation group.
 - *set id-tag <1 to 4094>* packet is identity tagged with specified VLAN number.
 - *set aggregation group agg_group id-tag <1 to 4094>* assigns agg group and identity tag.

Related Commands

- [policy-map type tapagg](#) places the switch in policy-map (tapagg) configuration mode.
- [class \(policy-map \(tapagg\)\)](#) assigns a class to the configuration-mode policy map.

Example

This command creates a match rule for the “t-policy_1” policy map that filters OSPF packets and replicates them as specified by the “t-group” tap aggregation group.

```
switch(config)#policy-map type tapagg t-policy_1
switch(config-pmap-t-policy_1)#match ip ospf any any set aggregation-g
roup t-group
switch(config-pmap-t-policy_1)#exit
switch(config)#policy-map type tapagg t-policy_1
switch(config-pmap-t-policy_1)#show active
```

```
policy-map type tapagg t-policy_1
  10 match ip ospf any any set aggregation-group t-group
switch(config-pmap-t-policy_1)#
```

19.1.10.6 mode (tap-agg configuration mode)

The **mode** command configures the switch's TAP aggregation mode. The **mode exclusive** command enables TAP aggregation. When TAP aggregation is enabled, TAP and tool ports are enabled, switching mode is disabled, and switching ports are errdisabled. TAP aggregation is disabled by default.

The **no mode** and **default mode** commands disable TAP aggregation mode and enable switching mode by removing the **mode** command from *running-config*.

Command Mode

TAP Aggregation Configuration

Command Syntax

```
mode exclusive
```

```
no mode exclusive
```

```
default mode exclusive
```

Parameters

exclusive TAP aggregation is enabled.

Related Command

[tap aggregation](#) places the switch in TAP-aggregation configuration mode.

Examples

- These commands place the switch in TAP-aggregation configuration mode, enable TAP aggregation mode, and display the results.

```
switch(config)#tap aggregation
switch(config-tap-agg)#mode exclusive
switch(config-tap-agg)#show active
tap aggregation
  mode exclusive
switch(config-tap-agg)#
```

- These commands disable TAP-aggregation mode by removing the **mode** command from *running-config*, then display the results.

```
switch(config)#tap aggregation
switch(config-tap-agg)#no mode
switch(config-tap-agg)#show active
switch(config-tap-agg)#
```

19.1.10.7 mode exclusive no-errdisable (tap-agg configuration mode)

The **mode exclusive no-errdisable** command configures the specified interface to remain enabled, regardless of its switchport mode, when TAP aggregation is enabled. This command is used primarily to configure a port to support PTP functions while the switch operates as a TAP aggregator.

Each command configures one Ethernet or port-channel interface. Subsequent **mode exclusive no-errdisable** commands add to the list of ports that remain enabled when TAP aggregation is enabled.

The **no mode exclusive no-errdisable** and **default mode exclusive no-errdisable** commands configure the specified interface to be error-disabled when programmed in access, trunk, or dot1q-tunnel switching mode (when TAP aggregation is enabled) by removing the corresponding **mode exclusive no-errdisable** command from *running-config*.

Command Mode

TAP Aggregation Configuration

Command Syntax

```
mode exclusive no-errdisable INT_NAME
```

Parameters

- INT_NAME interface type and number. Options include:
 - ethernet *e_num* Ethernet interface specified by *e_num*.
 - port-channel *p_num* port-channel interface specified by *p_num*.

Related Commands

- [tap aggregation](#) places the switch in TAP-aggregation configuration mode.
- [mode \(tap-agg configuration mode\)](#) configures the switch's TAP-aggregation mode.

Guidelines

In order for a TAP-aggregation switch to receive PTP traffic, the upstream device to which it is connected should be set to statically send PTP multicast traffic to the connected port on the switch.

Since IGMP snooping is disabled on TAP-aggregation switches and with no configuration to support sending upstream join messages in such a state, the messages are transmitted statically from the upstream device. Once the upstream messages are received, the port will move to the slave state and follow the standard PTP mechanism.

Example

These commands place the switch in TAP-aggregation configuration mode and place Ethernet interface 21/3 in no-errdisable mode.

```
switch(config)#tap aggregation
switch(config-tap-agg)#mode exclusive
switch(config-tap-agg)#mode exclusive no-errdisable ethernet 21/4
switch(config-tap-agg)#
```

19.1.10.8 platform fm6000 keyframe device

The **platform fm6000 keyframe device** command configures the 16-bit number that the specified keyframe lists as the device ID in its payload. By default, the device value placed in the specified keyframes is 0.

The **no platform fm6000 keyframe device** and **default platform fm6000 keyframe device** commands restore the default device ID insertion value of 0 for the specified keyframe by removing the corresponding **platform fm6000 keyframe device** command from **running-config**. The **no platform fm6000 keyframe** and **default platform fm6000 keyframe** command also removes the corresponding **platform fm6000 keyframe device** command from **running-config**.

Command Mode

Global Configuration

Command Syntax

```
platform fm6000 keyframe kf_name device device_id
no platform fm6000 keyframe kf_name device
default platform fm6000 keyframe kf_name device
```

Parameters

- *kf_name* keyframe name.
- *device_id* value inserted in keyframe's device ID field. Values range from 0 to 65535. Default is 0.

Example

These commands enable the generation of a keyframe named "key-1," then configure 100 as the value that is placed in the keyframe's device ID field.

```
switch(config)#platform fm6000 keyframe key-1 interface ethernet 11-15
10.21.1.4 10.4E21.9F11
switch(config)#platform fm6000 keyframe key-1 device 100
switch(config)#
```

19.1.10.9 platform fm6000 keyframe fields skew

Keyframes may optionally include skew numerator and skew denominator fields. These skew fields form a ratio indicating the ASIC clock skew. If the ratio is greater than 1, the clock is skewed fast; if the ratio is less than 1, the clock is skewed slow. Clock skew fields are omitted by default.

The **platform fm6000 keyframe fields skew** command enables the inclusion of clock skew fields in the keyframe.

The **no platform fm6000 keyframe fields skew** and **default platform fm6000 keyframe fields skew** commands remove the clock skew fields from the keyframe.

Command Mode

Global Configuration

Command Syntax

```
platform fm6000 keyframe kf_name fields skew
```

Parameters

kf_name keyframe name.

Example

This command enables the inclusion of clock skew fields in the keyframe named “key-1.”

```
switch(config)#platform fm6000 keyframe key-1 fields skew
switch(config)#
```

19.1.10.10 platform fm6000 keyframe rate

The **platform fm6000 keyframe rate** command specifies the transmission rate for the specified keyframe from each interface from which it is configured to egress. By default, one keyframe is sent per second.

The **no platform fm6000 keyframe rate** and **default platform fm6000 keyframe rate** commands restore the default transmission rate for the specified keyframe of one per second by removing the corresponding **platform fm6000 keyframe rate** command from **running-config**. The **no platform fm6000 keyframe** and **default platform fm6000 keyframe** command also removes the corresponding **platform fm6000 keyframe rate** command from **running-config**.

Command Mode

Global Configuration

Command Syntax

```
platform fm6000 keyframe kf_name rate tx_rate
```

Parameters

- *kf_name* the keyframe's name.
- *tx_rate* keyframe transmission rate (frames per second). Values range from 1 to 100. Default value is 1.

Example

These commands enable the generation of a keyframe named "key-1," then configure the generation rate for the keyframe of 10 frames per second on each of the five interfaces that it is configured to egress.

```
switch(config)#platform fm6000 keyframe key-1 interface ethernet 11-15
10.21.1.4
10.4E21.9F11
switch(config)#platform fm6000 keyframe key-1 rate 10
switch(config)#
```

19.1.10.11 platform fm6000 keyframe source

The **platform fm6000 keyframe source** command configures the source IP address that the specified keyframe lists in its IP header. By default, keyframes use the IP address of the management interface as their source address.

The **no platform fm6000 keyframe source** and **default platform fm6000 keyframe source** commands restore the management interface IP address as the specified keyframe's source IP address by removing the corresponding **platform fm6000 keyframe source** command from **running-config**. The **no platform fm6000 keyframe** and **default platform fm6000 keyframe** command also removes the corresponding **platform fm6000 keyframe source** command from **running-config**.

Command Mode

Global Configuration

Command Syntax

```
platform fm6000 keyframe kf_name source ip ipv4_addr  
no platform fm6000 keyframe  
kf_name source ip  
default platform fm6000 keyframe kf_name source ip
```

Parameters

- *kf_name* keyframe's name.
- *ipv4_addr* keyframe's source IPv4 address (dotted decimal notation).

Example

These commands enable the generation of a keyframe named "key-1," then sets the keyframe source IP address to 10.1.1.101.

```
switch(config)#platform fm6000 keyframe key-1 interface ethernet 11-15  
10.21.1.4 10.4E21.9F11  
switch(config)#platform fm6000 keyframe key-1 source 10.1.1.101  
switch(config)#
```

19.1.10.12 platform fm6000 keyframe

The **platform fm6000 keyframe** command enables keyframe generation for data streams transmitted from specified ethernet interfaces. Keyframes are routable IP packets that the switch inserts into a data stream to provide contextual information that correlate timestamps inserted into data packets with absolute UTC time and the switch's complete ASIC time counter.

The switch supports a maximum of ten keyframes. The keyframe name is the label that distinguishes different keyframes. Each keyframe can egress from every ethernet port. Command options specify the destination MAC address and IP address in the keyframe's header. Other keyframe commands specify the transmission rate and the frame's source.

The **no platform fm6000 keyframe** and **default platform fm6000 keyframe** commands disable generation of the specified keyframe by deleting the corresponding platform fm6000 keyframe command from **running-config**. These command also remove all supporting **platform fm6000 keyframe** commands for the specified keyframe.

Command Mode

Global Configuration

Command Syntax

```
platform fm6000 keyframe kf_name interface ethernet e_range ipv4_addr mac_addr
no platform fm6000 keyframe kf_name
default platform fm6000 keyframe kf_name
```

Parameters

- *kf_name* the keyframe's name.
- *e_range* Ethernet interface range over which the keyframe egresses. Valid formats include number, range, or comma-delimited list of numbers and ranges.
- *ipv4_addr* destination IPv4 address inserted into keyframes (dotted decimal notation).
- *mac_addr* destination MAC address inserted into keyframes (48-bit dotted hex notation).

Guidelines

Subsequent issuance of this command for a specified keyframe replaces the existing command in **running-config**. Ethernet interfaces are inserted into an existing keyframe only by issuing the complete command that identifies all interfaces through which the keyframe is transmitted.

Example

This command enables the generation of a keyframe named "key-1." This keyframe egresses from Ethernet interfaces 11 through 15 and specifies a source IP address of 10.21.1.4 and a MAC address of 10.4E21.9F11.

```
switch(config) #platform fm6000 keyframe key-1 interface ethernet 11-15
10.21.1.4 10.4E21.9F11
switch(config) #
```

19.1.10.13 platform sand multicast replication default

The **platform sand multicast replication default** command configures the default replication mode on Sand platform switches. The factory default replication mode differs in various scenarios as follows:

- The default replication mode on switches with fabric is **fabric-egress** mode.
- The default replication mode on switches with single Fabric Access Processor (FAP) systems is **ingress** mode.
- The default replication mode on switches without fabric barring single FAP systems is **ingress-egress** mode.
- If a tool group with less than 60 LAGs has at least one hardware LAG, then the default replication mode of the tool group is **ingress-only** mode. Else the default replication mode of the tool group is the one configured across all LAGs in the tool group.

The **default platform sand multicast replication default** and **no platform sand multicast replication default** commands revert the current state to the factory default behavior.

Command Mode

Global Configuration

Command Syntax

```
platform sand multicast replication default {fabric-egress | ingress}
no platform sand multicast replication default
default platform sand multicast replication default
```

Parameters

- fabric-egress configures the replication mode to use fabric-egress VoQ buffers.
- ingress configures the replication mode to use ingress VoQ buffers.

Guidelines

This command is supported on Sand platforms only.

Related Commands

- [platform sand multicast replication ingress maximum](#)
- [show platform sand mcast capacity](#)

Example

This command configures the default replication mode to ingress.

```
switch(config)#platform sand multicast replication default ingress
switch(config)#
```

19.1.10.14 platform sand multicast replication ingress maximum

The `platform sand multicast replication ingress maximum` command configures maximum members for ingress-only replication.

The `default platform sand multicast replication ingress maximum` command reverts the maximum members for ingress-only replication to the default value.

The `no platform sand multicast replication ingress maximum` command deletes the maximum member value for ingress-only replication.

Command Mode

Global Configuration

Command Syntax

```
platform sand multicast replication ingress maximum max_value
```

```
no platform sand multicast replication ingress maximum
```

```
default platform sand multicast replication ingress maximum
```

Parameters

max_value specifies the maximum number of members for ingress-only replication. Values range from 1 to 64. The default value is 64.

 **Note:** *max_value* for a single FAP Jericho system ranges from 1 to 4096.

Guidelines

This command is supported on Sand platforms only.

Related Commands

- `platform sand multicast replication default`
- `show platform sand mcast capacity`

Example

This command specifies a maximum of sixty-three members for ingress-only replication.

```
switch(config)#platform sand multicast replication ingress maximum 63
switch(config)#
```

19.1.10.15 policy-map type tapagg

The **policy-map type tapagg** command places the switch in policy-map (tapagg) configuration mode, which is a group-change mode that modifies a TAP-aggregation policy map. A TAP-aggregation policy map is a data structure that consists of class maps and match statements that filter a specific data stream. Packets in that data stream are either managed as specified by a TAP aggregation group or modified to add a VLAN identity tag. Policy maps manage traffic when applied to an Ethernet or port-channel interface.

The **exit** command saves pending policy map changes to **running-config** and returns the switch to global configuration mode. Policy map changes are also saved by entering a different configuration mode. The **abort** command discards pending changes, returning the switch to global configuration mode.

The **no policy-map type tapagg** and **default policy-map type tapagg** commands delete the specified policy map by removing the corresponding **policy-map type tapagg** command and the associated policy map statements from **running-config**.

Command Mode

Global Configuration

Command Syntax

```
policy-map type tapagg map_name
no policy-map type tapagg map_name
default policy-map type tapagg map_name
```

Parameters

map_name name of policy map.

Commands Available in Policy-Map Configuration Mode

- [class \(policy-map \(tapagg\)\)](#)
- [match \(policy-map \(tapagg\)\)](#)

Related Commands

- [class-map type tapagg](#)
- [service-policy type tapagg \(Interface mode\)](#)

Example

This command creates the TAP-aggregation policy map named “t-policy_1” and places the switch in policy-map configuration mode.

```
switch(config)#policy-map type tapagg t-policy_1
switch(config-pmap-t-policy_1)#
```

19.1.10.16 resequence (class-map (tapagg))

The **resequence** command assigns sequence numbers to access control lists (ACLs) in the configuration mode TAP-aggregation class map. Sequence numbers denote an ACL's priority within the class map. Command parameters specify the number of the first ACL and the numeric interval between consecutive ACLs.

Maximum rule sequence number is 4294967295.

Command Mode

Class-map (tapagg) Configuration

accessed with the [class-map type tapagg](#) command

Command Syntax

```
resequence [start_num [inc_num]]
```

Parameters

- **start_num** sequence number assigned to the first rule. Default is 10.
- **inc_num** numeric interval between consecutive rules. Default is 10.

Example

These commands display a policy map whose entities were entered with default sequence numbers, then renumber the contents.

```
switch(config-pmap-t-policy_1)#show active
policy-map type tapagg t-policy_1
  10 match ip ospf any any set aggregation-group t-group
  20 class fred
    set aggregation-group t-group id-tag 444
  30 class t-class_2
    set id-tag 500
  40 class t-class_3
    set id-tag 600
  50 class t-class_4
    set id-tag 700
switch(config-pmap-t-policy_1)#resequence 100 20
switch(config-pmap-t-policy_1)#exit
switch(config)#policy-map type tapagg t-policy_1
switch(config-pmap-t-policy_1)#show active
policy-map type tapagg t-policy_1
  100 match ip ospf any any set aggregation-group t-group
  120 class fred
    set aggregation-group t-group id-tag 444
  140 class t-class_2
    set id-tag 500
  160 class t-class_3
    set id-tag 600
  180 class t-class_4
    set id-tag 700
switch(config-pmap-t-policy_1)#
```

19.1.10.17 resequence (policy-map (tapagg))

The **resequence** command assigns sequence numbers to classes and rules in the configuration mode TAP-aggregation policy map. Sequence numbers denote the priority of a class or rule within the policy map. Command parameters specify the number of the first policy map entity and the numeric interval between consecutive entities.

Maximum rule sequence number is 4294967295.

Command Mode

Policy-Map (tapagg) Configuration

accessed with the [class \(policy-map \(tapagg\)\)](#) command

Command Syntax

```
resequence [start_num [inc_num]]
```

Parameters

- **start_num** sequence number assigned to the first rule. Default is 10.
- **inc_num** numeric interval between consecutive rules. Default is 10.

Example

These commands display a policy map whose entities were entered with default sequence numbers, then use the **resequence** command to renumber the contents.

```
switch(config-pmap-t-policy_1)#show active
policy-map type tapagg t-policy_1
  10 match ip ospf any any set aggregation-group t-group
  20 class fred
    set aggregation-group t-group id-tag 444
  30 class t-class_2
    set id-tag 500
  40 class t-class_3
    set id-tag 600
  50 class t-class_4
    set id-tag 700
switch(config-pmap-t-policy_1)#resequence 100 20
switch(config-pmap-t-policy_1)#exit
switch(config)#policy-map type tapagg t-policy_1
switch(config-pmap-t-policy_1)#show active
policy-map type tapagg t-policy_1
  100 match ip ospf any any set aggregation-group t-group
  120 class fred
    set aggregation-group t-group id-tag 444
  140 class t-class_2
    set id-tag 500
  160 class t-class_3
    set id-tag 600
  180 class t-class_4
    set id-tag 700
switch(config-pmap-t-policy_1)#
```

19.1.10.18 service-policy type tapagg (Interface mode)

The **service-policy type tapagg** command applies a specified TAP-aggregation policy map to the configuration-mode interface. A policy map is a data structure that identifies data traffic through class maps and match rules, then specifies the method of replicating the traffic. This command is active only when TAP aggregation mode is enabled on the switch.

The **no service-policy type tapagg** and **default service-policy type tapagg** commands remove the policy map assignment from the configuration mode interface by deleting the corresponding **service-policy tapagg** command from *running-config*.

Command Mode

Interface-Ethernet Configuration

Interface-Port-Channel Configuration

Command Syntax

```
service-policy type tapagg input polycymap_name
```

Parameters

- input policy map applies to inbound packet streams. This is the only option.
- **map_name** name of policy map.

Guidelines

A policy map that is attached to a port-channel interface takes precedence for member interfaces of the port channel over their individual Ethernet interface configuration. Members that are removed from a port channel revert to the policy-map implementation specified by its Ethernet interface configuration.

Related Commands

[class \(policy-map \(tapagg\)\)](#) places the switch in policy-map configuration mode to create a policy map.

Example

These commands apply the “t-policy_1” policy map to Ethernet interface 17.

```
switch(config)#interface ethernet 17  
switch(config-if-Et17)#service-policy type tapagg input t-policy_1  
switch(config-if-Et17)#
```

19.1.10.19 set (policy-map-class (tapagg))

The **set** command specifies the data replication method for traffic filtered by the associated class map in the configuration-mode policy map. The **set** command specifies one of these replication actions for filtered data packets:

- specifies an aggregation group.
- specifies a VLAN identity tag for replicated packets.
- specifies an aggregation group and a VLAN identity tag.

The **no set** and **default set** commands remove the specified set command data action from the configuration-mode class by deleting the associated **set** command from *running-config*.

Command Mode

Policy-map-class (tapagg) Configuration

accessed using the [class \(policy-map \(tapagg\)\)](#) command

Command Syntax

```
set SET_VALUE
```

```
no set SET_VALUE
```

```
default set SET_VALUE
```

Parameters

- SET_VALUE specifies the replication method for filtered packets. Options include:
 - aggregation group *agg_group* replication specified by aggregation group.
 - id-tag *VLAN_number* packet is identity tagged with specified VLAN number. VLAN numbers range from 1 to 4094.
 - aggregation group *agg_group* id-tag *VLAN_number* assigns aggregation group and identity tag (VLAN number). VLAN numbers range from 1 to 4094.

Related Commands

- [policy-map type tapagg](#) places the switch in policy-map (tapagg) configuration mode.
- [class \(policy-map \(tapagg\)\)](#) assigns a class to the policy-map configuration mode.
- [match \(policy-map \(tapagg\)\)](#) assigns a rule to the policy-map configuration mode.

Guidelines

When a class is not associated with a **set** command, the filtered traffic is managed as specified by the TAP port's default aggregation group.

Example

These commands place the switch in policy-map-class to add the "t-class_1" class map to the "t-policy_1" policy map. Packets filtered by the class map are identity tagged with VLAN 444 and replicated as specified through the "t-group" aggregation group.

```
switch(config)#policy-map type tapagg t-policy_1
switch(config-pmap-t-policy_1)#class t-class_1
switch(config-pmap-c-t-policy_1-t-class_1)#set aggregation-group t-group
id-tag
444
switch(config-pmap-c-t-policy_1-t-class_1)#exit
switch(config-pmap-t-policy_1)#exit
switch(config)#policy-map type tapagg t-policy_1
switch(config-pmap-t-policy_1)#show active
policy-map type tapagg t-policy_1
  10 class t-class_1
    set aggregation-group t-group id-tag 444
```



```
switch(config-pmap-t-policy_1) #
```

19.1.10.20 show hardware tcam profile

Use the `show hardware tcam profile` command to display The TCAM profile by configuration and status.

Command Mode

EXEC

Command Syntax

```
show hardware tcam profile detail
```

Parameters

detail Displays TCAM profile details.

Example

```
(config-tap-agg) #show hardware tcam profile
                        Configuration      Status
FixedSystem            foo*              foo
* configuration overridden by TapAgg
```

19.1.10.21 show interfaces tap

The **show interfaces tap** command displays TAP-port configuration information for the specified interfaces.

Command Mode

EXEC

Command Syntax

```
show interfaces [INTERFACE] tap [INFO_LEVEL]
```

Parameters

- **INTERFACE** interface type and numbers. Options include:
 - <no parameter> all interfaces.
 - ethernet *e_range* Ethernet interface range specified by *e_range*.
 - management *m_range* management interface range specified by *m_range*.
 - port-channel *p_range* port-channel interface range specified by *p_range*.

Valid *e_range*, *m_range*, and *p_range* formats include number, number range, or comma-delimited list of numbers and ranges.
- **INFO_LEVEL** amount of information that is displayed. Options include:
 - <no parameter> command displays table that summarizes TAP data.
 - detail command displays TAP data summary table and a list of ACLs applied to TAP ports.

Examples

- This command displays TAP-port configuration information for Ethernet interfaces 36 through 40.

```
switch#show interface ethernet 31-35 tap
Port      Configured  Status      Native  Id  Truncation
Default
Mode                               Vlan    Vlan    Group
-----
Et31      tap         tap         301     31   0       tag_1
Et32      tap         tap         1       132  0       tag_1
Et33      tap         tap         303     233  0       tag_1
Et34      tap         tap         1       334  0       tag_3
Et35      tap         tap         1       345  0       tag_3
switch#
```

- This command displays detailed TAP-port configuration information for Ethernet interface 31.

```
switch#show interface ethernet 31 tap detail
Port      Configured  Status      Native  Id  Truncation
Default
Mode                               Vlan    Vlan    Group
-----
Et31      tap         tap         301     31   0       tag_1

Port      ACLs Applied
-----
switch#
```

19.1.10.22 show interfaces tool

The `show interfaces tool` command displays tool port configuration information for the specified interfaces.

Command Mode

EXEC

Command Syntax

```
show interfaces [INTERFACE] tool
```

Parameters

- INTERFACE interface type and numbers. Options include:
 - <no parameter> all interfaces.
 - ethernet *e_range* Ethernet interface range specified by *e_range*.
 - management *m_range* management interface range specified by *m_range*.
 - port-channel *p_range* port-channel interface range specified by *p_range*.

Valid *e_range*, *m_range*, and *p_range* formats include number, number range, or comma-delimited list of numbers and ranges.

Example

This command displays tool port configuration information for Ethernet interfaces 36 through 40.

```
switch#show interface ethernet 36-40 tool
Port      Configured   Status      Allowed      Id
Timestamp Mode
-----
Et36      tool         tool        201-205      Off  None
Et37      tool         tool        201-205      Off  None
Et38      tool         tool        201-205      Off  None
Et39      access      errdisabled All           Off  None
Et40      tool         tool        All           On   None

switch#
```

19.1.10.23 show platform fm6000 keyframe

The **show platform fm6000 keyframe** command displays configured information for the specified keyframes. Keyframes are routable IP packets that the switch inserts into a data stream to provide contextual information that correlate timestamps inserted into data packets with the absolute UTC time and the switch's complete ASIC time counter.

Command Mode

Privileged EXEC

Command Syntax

```
show platform fm6000 keyframe [KEYFRAME_ID]
```

Parameters

- **KEYFRAME_ID** specifies keyframes that the command displays. Options include:
 - <no parameter> command displays all configured keyframes.
 - **kf_name** specifies a single keyframe to display information for.

Example

This command displays information concerning the three keyframes that the switch sends.

```
switch#show platform fm6000 keyframe
Keyframe key-2
-----
Egress Interface(s): Ethernet17, Ethernet18, Ethernet19, Ethernet20,
Ethernet21
Source IP: 10.22.30.144
Destination IP: 10.21.1.14
Destination MAC: 00:09:00:09:00:09
Device ID: 0
Rate: 5 packet(s) per second

Keyframe key-1
-----
Egress Interface(s): Ethernet11, Ethernet12, Ethernet13, Ethernet14,
Ethernet15
Source IP: 10.22.30.146
Destination IP: 10.21.1.4
Destination MAC: 00:10:4e:21:9f:11
Device ID: 0
Rate: 2 packet(s) per second

switch#
```

19.1.10.24 show platform sand mcast capacity

The **show platform sand mcast capacity** command displays the usage details of hardware resources on Sand platform switches.

Command Mode

EXEC

Command Syntax

```
show platform sand mcast capacity [threshold threshold_value]
```

Parameters

threshold *threshold_value* displays the list of resources whose usage percentage is greater than or equal to the specified threshold value. Values range from 0 to 100. The default value is 100.

Guidelines

This command is supported on Sand platforms only.

Examples

This command displays the usage details of hardware resources on a Sand platform switch.

```
switch#show platform sand mcast capacity

Multicast Resources
-----
'*' - Applies to all Modules
'-' - Not applicable

-----
TCAM Resources
-----
Resource                Module                Total    Used    Used%
-----
v4 MC TCAM              Linecard3-Jericho3/0  4096     2      0.0
v4 MC TCAM              Linecard5-Jericho5/0  4096    506    12.4

-----
Replication Table Resources
-----
Resource                Module                Total    Used    Used%
-----
Multicast Table Row
Linecard3-Jericho3/0.0  262143    10586    4.0
Linecard3-Jericho3/1.0  262143    10576    4.0
Linecard3-Jericho3/0.1  262143    10586    4.0
Linecard3-Jericho3/1.1  262143    10576    4.0
Linecard6-Jericho6/2.0  262143    10576    4.0

switch#
```

19.1.10.25 show tap aggregation groups

The **show tap aggregation groups** command displays the TAP and tool port members of the specified TAP aggregation groups.

Command Mode

EXEC

Command Syntax

```
show tap aggregation groups [INFO_LEVEL] [GROUP_NAMES]
```

Parameters

- INFO_LEVEL port information to display. Options include:
 - <no parameter> displays active TAP and tool ports.
 - detail displays all configured TAP and tool ports, including inactive ports.
- GROUP_NAMES TAP aggregation groups. Options include:
 - <no parameter> displays information for all TAP aggregation groups.
 - *group_list* displays information for the specified TAP aggregation group list.

Valid *group_list* format is a space-delimited list of one or more TAP aggregation group names.

Example

This command displays the contents of all configured TAP aggregation groups.

```
switch#show tap aggregation groups
Group Name                               Tool Members
-----
analyze2                                  Po101, Po102
analyze3                                  Po101, Po103

Group Name                               Tap Members
-----
analyze2                                  Et41, Et42
analyze3                                  Et43
switch#
```

19.1.10.26 switchport tap allowed vlan

The **switchport tap allowed vlan** command creates or modifies the list of VLANs for which the configuration mode interface, in TAP mode, handles tagged traffic. By default, interfaces handle tagged traffic for all VLANs. Command settings persist in **running-config** without taking effect when the switch is not in TAP aggregation mode or the interface is not in TAP aggregation mode.

The **no switchport tap allowed vlan** and **default switchport tap allowed vlan** commands restore the TAP mode default allowed VLAN setting of all by removing the corresponding **switchport tap allowed vlan** statement from **running-config**.

Command Mode

Interface-Ethernet Configuration

Interface-Port Channel Configuration

Command Syntax

```
switchport tap allowed vlan EDIT_ACTION
```

Parameters

- EDIT_ACTION modifications to the VLAN list. Options include:
 - *v_range* creates VLAN list from range of VLANs specified by *v_range*.
 - **add** *v_range* adds specified VLANs to current list.
 - **all** VLAN list contains all VLANs.
 - **except** *v_range* VLAN list contains all VLANs except those specified by *v_range*.
 - **none** VLAN list is empty (no VLANs).
 - **remove** *v_range* removes VLANs specified by *v_range* from current list.

Valid *v_range* formats include number (1 to 4094), range, or comma-delimited list of numbers and ranges.

Example

These commands create the TAP mode allowed VLAN list of 26-30 for Ethernet interface 20.

```
switch(config)#interface ethernet 20
switch(config-if-Et20)#switchport tap allowed vlan 26-30
eswitch(config-if-Et20)#show active
interface Ethernet20
    switchport mode tap
    switchport tap allowed vlan 26-30
switch(config-if-Et20)#
```

19.1.10.27 switchport tap default group

The **switchport tap default group** command assigns the configuration-mode interface to the specified tool group as a TAP port member. TAP aggregation groups associate a set of TAP ports with a set of tool ports. Both TAP ports and tool ports may belong to multiple TAP aggregation groups.

The **no switchport tap default group** and **default switchport tap default group** commands remove the configuration-mode interface from the TAP aggregation group to which it is assigned by deleting the corresponding **switchport tap default group** statement from **running-config**.

Command Mode

Interface-Ethernet Configuration

Interface-port Channel Configuration

Command Syntax

```
switchport tap default group group_name
```

```
no switchport tap default group
```

```
default switchport tap default group
```

Parameters

group_name tool group name.

Restriction

This command is only available on FM6000 platform switches.

Example

These commands assign port channel 101 to TAPs aggregation group "tag-1."

```
switch(config)#interface port-channel 101
switch(config-if-Po101)#switchport tap default group tag-1
switch(config-if-Po101)#show interfaces port-channel 101 tap
Port          Configured   Status      Native   Id   Truncation  Default
              Mode                               Vlan    Vlan
-----
Po101        access      notconnect   1        1    0           tag-1
switch(config)#
```

19.1.10.28 switchport tap identity

The **switchport tap identity** command associates a VLAN number to the configuration mode TAP interface. Tool ports that are configured to encapsulate packets with an dot1q-style tag enter the number specified by this command as the s-VLAN (tier 1) for packets received from this TAPs port. The default identity value is 1.

The **no switchport tap identity** and **default switchport tap identity** commands restore VLAN 1 as the configuration-mode ports's identity VLAN by removing the corresponding **switchport tap identity** command from *running-config*.

Command Mode

Interface-Ethernet Configuration

Interface-Port Channel Configuration

Command Syntax

```
switchport tap identity port_id
no switchport tap identity
default switchport tap identity
```

Parameters

port_id port's identity VLAN. Values range from 1 to 4094. Default is 1.

Related Commands

[switchport tool identity](#) configures a tool port to encapsulate packets received from TAP ports.

Restriction

This command is available only on FM6000 platform switches.

Example

These commands 171 as the identity value for Ethernet interface 17.

```
switch(config)#interface ethernet 17
switch(config-if-Et17)#switchport tap identity 171
switch(config-if-Et17)#show active
interface Ethernet17
  switchport tap identity 171
switch(config-if-Et17)#show interfaces ethernet 17 tap
```

Port	Configured Mode	Status	Native Vlan	Id Vlan	Truncation	Default Group
Et17	access	connected	1	171	0	

```
switch(config-if-Et17)#
```

19.1.10.29 switchport tap native vlan

The **switchport tap native vlan** command specifies the TAP-mode native VLAN for the configuration-mode interface. Interfaces in TAP mode associate untagged frames with the native VLAN. The default native VLAN for all interfaces is VLAN 1. Command settings persist in **running-config** without taking effect when the switch is not in TAP aggregation mode or the interface is not in TAP mode.

The **no switchport tap native vlan** and **default switchport tap native vlan** commands restore VLAN 1 as the TAP-mode native VLAN to the configuration-mode interface by removing the corresponding **switchport tap native vlan** command from **running-config**.

Command Mode

Interface-Ethernet Configuration

Interface-Port Channel Configuration

Command Syntax

```
switchport tap native vlan v_num
no switchport tap native vlan
default switchport tap native vlan
```

Parameters

v_num TAP-mode native VLAN ID. Values range from 1 to 4094. Default is 1.

Restriction

This command is available only on FM6000 platform switches.

Example

These commands assign VLAN 25 as the TAP-mode native VLAN for Ethernet interface 7.

```
switch(config)#interface ethernet 7
switch(config-if-Et7)#switchport tap native vlan 25
switch(config-if-Et7)#show interface ethernet 7 tap
```

Port	Configured Mode	Status	Native Vlan	Id Vlan	Truncation	Default Group
Et7	tool	connected	25	1	0	---

```
switch(config-if-Et7)#
```

19.1.10.30 switchport tap truncation

The **switchport tap truncation** command configures the configuration-mode interface, as a TAP port, to truncate inbound packets to the specified packet size. This command is in effect when the port is in TAP mode and the switch is in TAP aggregation mode. Command settings persist in **running-config** without taking effect when the switch is not in TAP aggregation mode or the interface is not in TAP mode. By default, TAP ports do not truncate inbound packets.

The **no switchport tap truncation** and **default switchport tap truncation** commands restore the default behavior of not truncating packets received by the configuration-mode interface by removing the corresponding **switchport tap truncation** command from **running-config**.

Command Mode

Interface-Ethernet Configuration

Interface-Port Channel Configuration

Command Syntax

```
switchport tap truncation packet_size
```

```
no switchport tap truncation
```

```
default switchport tap truncation
```

Parameters

packet_size size of truncated packets (bytes). Values range from 100 to 9236. Default value of 0 corresponds to not truncating packets.

Restriction

This command is available only on FM6000 platform switches.

Examples

- These commands configure Ethernet interface 38 to truncate packets to 150 bytes.

```
switch(config)#interface ethernet 38
switch(config-if-Et38)#switchport tap truncation 150
switch(config-if-Et38)#show interface ethernet 38 tap
Port      Configured      Status      Native  Id  Truncation
  Default
          Mode
-----
Et38      access          notconnect  1       1   150      ---
switch(config-if-Et38)#
```

- These commands configure Ethernet interface 38 to send complete packets to tool ports in its TAP aggregation group.

```
switch(config-if-Et38)#no switchport tap truncation
switch(config-if-Et38)#show interface ethernet 38 tap
Port      Configured      Status      Native  Id  Truncation
  Default
          Mode
-----
Et38      access          notconnect  1       1    0       ---
switch(config-if-Et38)#
```

19.1.10.31 switchport tool allowed vlan

The `switchport tool allowed vlan` command creates or modifies the list of VLANs for which the configuration-mode interface, in tool mode, handles tagged traffic. By default, interfaces handle tagged traffic for all VLANs. Command settings persist in *running-config* without taking effect when the switch is not in TAP aggregation mode or the interface is not in TAP aggregation mode.

The `no switchport tool allowed vlan` and `default switchport tool allowed vlan` commands restore the tool mode default allowed VLAN setting of all by removing the corresponding `switchport tool allowed vlan` statement from *running-config*.

Command Mode

Interface-Ethernet Configuration

Interface-Port Channel Configuration

Command Syntax

```
switchport tool allowed vlan EDIT_ACTION
```

Parameters

- EDIT_ACTION modifications to the VLAN list. Options include:
 - `v_range` creates VLAN list from `v_range`.
 - `add v_range` adds specified VLANs to current list.
 - `all` VLAN list contains all VLANs.
 - `except v_range` VLAN list contains all VLANs except those specified.
 - `none` VLAN list is empty (no VLANs).
 - `remove v_range` removes specified VLANs from current list.

Valid `v_range` formats include number, range, or comma-delimited list of numbers and ranges.

Example

These commands create the tool mode allowed VLAN list of 16-20 for Ethernet interface 38.

```
switch(config)#interface ethernet 38
switch(config-if-Et38)#switchport tool allowed vlan 16-20
switch(config-if-Et38)#show interfaces ethernet 38 tool
```

Port	Configured	Status	Allowed	Id		
Timestamp	Mode		Vlans	Tag	Mode	
Et38	access	notconnect	16-20	Off	None	

```
switch(config-if-Et38)#
```

19.1.10.32 switchport tool group

The **switchport tool group** command modifies the configuration-mode interface's tool port membership in the specified TAP aggregation groups. Tool ports may belong to multiple TAP aggregation groups. Command options for configuring a port's TAP aggregation group membership include:

- specifying the groups to which the port belongs (supersedes the port's previous group memberships).
- adding to the list of groups to which the port belongs.
- deleting from the list of groups to which the port belongs.

TAP aggregation groups associate a set of TAP ports with a set of tool ports. A TAP port can belong to a maximum of one default TAP aggregation group.

The **no switchport tool default group** and **default switchport tool default group** commands remove the configuration-mode interface from all TAP aggregation groups to which it is assigned as a tool port by modifying the corresponding statements in *running-config*.

Command Mode

Interface-Ethernet Configuration

Interface-Port Channel Configuration

Command Syntax

```
switchport tool group EDIT_ACTION
```

Parameters

- EDIT_ACTION specifies changes to the list of groups to which the port belongs
 - add *group_list* specifies additional groups to which the port belongs.
 - remove *group_list* removes interface as a tool port member from specified groups.
 - set *group_list* specifies groups to which interface belongs as a tool port.

Valid *group_list* format is a space-delimited list of one or more TAP aggregation group names.

Restriction

This command is available only on FM6000 platform switches.

Examples

- These commands associate interface Ethernet 40 with three TAP aggregation groups.

```
switch(config)#interface ethernet 40
switch(config-if-Et40)#switchport tool group set tag-1 tag-2 tag-3
switch(config-if-Et40)#show active
interface Ethernet40
    switchport tool group set tag-3 tag-2 tag-1
switch(config-if-Et40)#
```

- These commands add tag-7 to the tap aggregation groups to which Ethernet interface 40 belongs.

```
switch(config-if-Et40)#switchport tool group add tag-7
switch(config-if-Et40)#show active
interface Ethernet40
    switchport tool group set tag-3 tag-7 tag-2 tag-1
switch(config-if-Et40)#
```

- These commands specify "tag-9" as the only group to which Ethernet interface 40 belongs.

```
switch(config-if-Et40)#switchport tool group set tag-9
switch(config-if-Et40)#show active
```

```
interface Ethernet40
  switchport tool group set tag-9
switch(config-if-Et40)#
```

19.1.10.33 switchport tool identity

The **switchport tool identity** command configures the configuration-mode interface to add a tier-1 VLAN tag (dot1q) to packets it receives from TAP ports. The VLAN number on the dot1q tag is specified by the **switchport tap identity** command configured for the TAP port that supplies the packets. By default, tool ports do not encapsulate packets with the tier-1 VLAN tag.

The **no switchport tool identity** and **default switchport tool identity** commands restore the default VLAN handling method for the configuration-mode interface by removing the corresponding **switchport tool identity** statement from *running-config*.

Command Mode

Interface-Ethernet Configuration

Interface-Port Channel Configuration

Command Syntax

```
switchport tool identity dot1q
no switchport tool identity dot1q
default switchport tool identity dot1q
```

Restriction

This command is available only on FM6000 platform switches.

Example

These commands configure Ethernet interface 40 to include a dot1q tag on egress packets.

```
switch(config)#interface ethernet 40
switch(config-if-Et40)#switchport tool identity dot1q
switch(config-if-Et40)#show active
interface Ethernet40
  switchport mode tool
  switchport tool identity dot1q
  switchport tool group set tag-9
switch(config-if-Et40)#
```

19.1.10.34 switchport tool truncation

The **switchport tool truncation** command configures the configuration-mode interface, as a tool port, to truncate outbound packets to 160 bytes. This command is in effect when the port is in tool mode and the switch is in TAP aggregation mode. Command settings persist in **running-config** without taking effect when the switch is not in TAP aggregation mode or the interface is not in tool mode. By default, tool ports do not truncate outbound packets.

The **no switchport tool truncation** and **default switchport tool truncation** commands restore the default behavior (not truncating packets that exit the configuration mode interface) by removing the corresponding **switchport tool truncation** command from **running-config**.

Command Mode

Interface-Ethernet Configuration

Interface-Port Channel Configuration

Command Syntax

```
switchport tool truncation packet_size
```

```
no switchport tool truncation
```

```
default switchport tool truncation
```

Parameters

- *packet_size* size of truncated packets in bytes. The only permitted value is 160.

Examples

- These commands configure Ethernet interface 38, as a tool port, to truncate packets on egress to 160 bytes.

```
switch(config)#interface ethernet 38  
switch(config-if-Et38)#switchport mode tool  
switch(config-if-Et38)#switchport tool truncation 160  
switch(config-if-Et38)#
```

- These commands configure Ethernet interface 38 to send complete packets.

```
switch(config)#interface ethernet 38  
switch(config-if-Et38)#no switchport tool truncation  
switch(config-if-Et38)#
```

19.1.10.35 tap aggregation

The **tap aggregation** command places the switch in TAP-aggregation configuration mode. The switch's TAP aggregation mode is enabled or disabled by the **mode** command in TAP-aggregation configuration mode.

When TAP aggregation mode is enabled, normal switching and routing operations are disabled. A port's switchport status depends on the switch's TAP aggregation mode and the port's switchport mode:

- **TAP aggregation mode enabled:** TAP and tool ports are enabled. Switching ports are errdisabled.
- **TAP aggregation mode disabled:** TAP and tool ports are errdisabled. Switching ports are enabled.

The **no tap aggregation** and **default tap aggregation** commands disable tap aggregation mode on the switch by removing all TAP-aggregation configuration mode commands from **running-config**.

TAP-aggregation configuration mode is not a group-change mode; **running-config** is changed immediately upon entering commands. Exiting TAP-aggregation configuration mode does not affect **running-config**. The **exit** command returns the switch to global configuration mode.

Command Mode

Global Configuration

Command Syntax

```
tap aggregation
```

```
no tap aggregation
```

```
default tap aggregation
```

Commands Available in TAP-aggregation Configuration Mode

- **mode** (tap-agg configuration mode)

Related Commands

- **switchport mode**

Example

- These commands place the switch in TAP-aggregation configuration mode and enable TAP aggregation.

```
switch(config)#tap aggregation
switch(config-tap-agg)#mode exclusive
switch(config-tap-agg)#show active
tap aggregation
mode exclusive
switch(config-tap-agg)#
```

- This command disables TAP aggregation and removes all TAP-aggregation configuration mode commands from **running-config**.

```
switch(config)#no tap aggregation
switch(config)#
```

19.2 Latency Analyzer (LANZ)

Arista Networks' Latency Analyzer (LANZ) is a family of EOS features that provide enhanced visibility into network dynamics, particularly in areas related to the delay packets experience through the

network. The LANZ feature is available on the FM6000, Arad, Trident II, Trident 3, Jericho, Tomahawk and XP80 switch platforms.

This section describes the purpose, behavior, and configuration of LANZ features. Topics covered by this section include:

- [Introduction to LANZ](#)
- [LANZ Overview](#)
- [Configuring LANZ](#)
- [LANZ Commands](#)

19.2.1 Introduction to LANZ

LANZ tracks interface congestion and queuing latency with real-time reporting. With LANZ application layer event export, external applications can predict impending congestion and latency. This enables the application layer to make traffic routing decisions with visibility into the network layer.

With LANZ, network operations teams and administrators have near real-time visibility into the network, enabling early detection of microbursts. LANZ continually monitors congestion, allowing for rapid detection of congestion and sending of application layer messages.

19.2.2 LANZ Overview

LANZ monitors output queue lengths to provide congestion information for individual interfaces. This allows for more detailed analysis of congestion events, and allows identification of potential latency problems before they arise. On some platforms, LANZ also monitors global buffer usage.

Output queues for each port are monitored, and information about queue congestion events can be accessed in the form of system log messages, reports, or streaming.

19.2.2.1 LANZ Monitoring Mechanism

LANZ provides congestion data by continuously monitoring each port's output queue lengths. When the length of an output queue exceeds the upper threshold for that port, LANZ generates an over-threshold event.

19.2.2.1.1 Notifying and Polling Modes

Notifying Mode

In Notifying Mode (available on all platforms), LANZ monitors congestions on all queues and generates Start, Update, and End events every five seconds or at user-configured intervals.

- **Start** event is generated when any queue on an interface exceeds the upper threshold.
- **Update** events are generated periodically while the congested queue remains above the lower threshold. The interval at which Update events are generated is configured using the [queue-monitor length update-interval](#) command.
- **End** event is generated when the congested queue drops below the lower threshold.

Polling Mode

Polling Mode is available only on Arad and Jericho switches. On these switches, LANZ can be configured to use Notifying Mode, but it operates in Polling Mode by default. In Polling Mode, LANZ polls the most congested queue in each ASIC and continues to report an over-threshold state every 800 microseconds until all queue lengths for the port pass below the lower threshold.

19.2.2.2 LANZ Logging

Over-threshold events generated by LANZ can be logged as system log messages. Log messages are generated for events on all ports, at a maximum rate of one message per second per interface. The interval between messages can be configured globally.

Log messages indicate the time of the event, the interface affected, the threshold set for that interface, and the actual number of entries in the port's queue.

19.2.2.3 LANZ Reporting

Detailed LANZ data can be viewed through the CLI or exported as a CSV-formatted report.

A circular FIFO event buffer is dynamically shared by all interfaces. When an interface begins generating LANZ over-threshold events it can fill all available buffer space. However, each interface is guaranteed sufficient resources for a minimum of 500 entries.

19.2.2.4 LANZ Streaming

On some platforms, external client applications can also receive congestion event information as a data stream. The switch can stream LANZ data to up to 100 clients via TCP through port 50001.

Streamed data is in Google protocol buffer format, and includes both over-threshold events and LANZ configuration information.

19.2.2.5 Platforms

The LANZ feature is available on the FM6000, Arad, Trident II, Trident 3, Jericho and Tomahawk switch platforms. To determine the switch platform from the CLI, enter `show platform ?` at the prompt.

Settings and capabilities differ slightly between the platforms:

- Arad chips measure threshold values in bytes; all others measure threshold values in segments:
 - **FM6000** 480-byte segments
 - **Trident II** and **Tomahawk** 208-byte segments
 - **Trident 3** 256-byte segments
- FM6000, Trident II, Trident 3, and Tomahawk chips allow configuration of both upper and lower threshold values.
- FM6000, Arad, Jericho, Trident II, Trident 3, and Tomahawk chips support LANZ data streaming.
- Only FM6000 chips support global buffer monitoring.
- While the FM6000, Trident II, Trident 3, Jericho and Tomahawk chips can monitor congestion events for all queues, the Arad chips only monitor the most congested queues.
- Polling Mode is available on Arad and Jericho platforms.
- LANZ is available on CPU ports on Arad, Jericho, Trident II and Tomahawk platforms.
- LANZ is available on fabric ports on Trident, Trident II, Trident 3, and Tomahawk platforms.

19.2.3 Configuring LANZ

LANZ is disabled by default and must be enabled to function. Upper and lower queue-length thresholds can be defined for individual interfaces.

These sections describe the basic LANZ configuration steps:

- [Enabling and Disabling LANZ](#)
- [Specifying the LANZ Mode on Jericho and Arad Switches](#)
- [Configuring LANZ Congestion Thresholds](#)
- [Setting LANZ Traffic Sampling](#)

- [Logging LANZ Congestion Events](#)
- [Viewing LANZ Data](#)
- [Streaming LANZ Data](#)

19.2.3.1 Enabling and Disabling LANZ

LANZ is enabled by default on Sand platform switches (those with Arad, Jericho, or Qumran chipsets), allowing the switch to collect and display latency information. LANZ is disabled by default on all other switches. If LANZ is disabled, the [queue-monitor length \(global configuration mode\)](#) command enables LANZ with the current settings, or with the default settings if none have been configured.

When LANZ is enabled, the switch monitors queue lengths on all front-panel ports, and on CPU and fabric ports on selected platforms. Queue length data is available in the following forms:

- syslog data (see [queue-monitor length log](#))
- CLI display or CSV-format output (see [show queue-monitor length](#))
- data stream (see [queue-monitor streaming](#))

To disable LANZ globally, enter the `no queue-monitor length` command in global configuration mode. Disabling LANZ globally also discards LANZ log data, but retains settings. To disable LANZ on an individual interface, enter the `no queue-monitor length` command in interface Ethernet configuration mode.

Examples

- This command enables LANZ on the switch.

```
switch(config)#queue-monitor length
switch(config)#
```

- This command disables LANZ on the switch.

```
switch(config)#no queue-monitor length
switch(config)#
```

- These commands disable LANZ on Ethernet interface 7.

```
switch(config)#interface ethernet 7
switch(config-if-Et7)#no queue-monitor length
switch(config-if-Et7)#
```

19.2.3.2 Specifying the LANZ Mode on Jericho and Arad Switches

On Jericho and Arad switches, LANZ operates by default in Polling Mode, which provides congestion data for the most congested queue per ASIC. They also support Notifying Mode (the LANZ mode used on all other switches), which generates Start, Update, and End events for all queues.

Notifying Mode is enabled using the [queue-monitor length notifying](#) command.

Examples

- This command enables Notifying Mode on a Jericho or Arad switch.

```
switch(config)#queue-monitor length notifying
```

- This command disables Notifying Mode on a Jericho or Arad switch, returning LANZ to the default Polling Mode.

```
switch(config)#no queue-monitor length notifying
```

19.2.3.3 Configuring LANZ Congestion Thresholds

When LANZ is enabled on the switch, it generates over-threshold events when queue lengths on any monitored interface exceed the upper threshold value and continues generating them until all the queue lengths on that interface drop back below the lower threshold.

19.2.3.3.1 Setting the Congestion Update Interval

The `queue-monitor length update-interval` command specifies the frequency with which congestion information is updated in microseconds.

- This command sets the time between congestion updates to 10 seconds.

```
switch(config)# queue-monitor length update-interval 10000000
switch(config)#
```

- This command resets the time between congestion updates to its default value of 5 seconds.

```
switch(config)# default queue-monitor length update-interval
switch(config)#
```

19.2.3.3.2 Congestion Thresholds on FM6000, Trident II, Trident 3, and Tomahawk Switches

Queue lengths are measured in 480-byte segments on FM6000 switches, in 208-byte segments on Trident II and Tomahawk switches, and in 256-byte segments on Trident 3 switches. The default threshold values are 512 segments and 256 segments. To change the threshold values for a specific interface, use the `queue-monitor length thresholds` command.

FM6000 switches can also monitor global buffer usage. Global buffers are measured in 160-byte segments; the default threshold values are 10940 segments and 4376 segments. To enable global buffer monitoring, use the `queue-monitor length global-buffer` command. To change the threshold values for global buffer usage monitoring on the switch, use the `queue-monitor length global-buffer thresholds` command.

Examples

- These commands set the upper and lower queue-length thresholds on Ethernet interface 5 to 300 segments and 200 segments.

```
switch(config)# interface ethernet 5
switch(config-if-Et5)# queue-monitor length thresholds 300 200
switch(config-if-Et5)#
```

- These commands enable global buffer monitoring on the switch and set the upper and lower thresholds to 9000 segments and 4000 segments.

```
switch(config)# queue-monitor length global-buffer
switch(config)# queue-monitor length global-buffer thresholds 9000 4000
switch(config)#
```

19.2.3.3.3 Congestion Thresholds on Arad Switches

Queue lengths are measured in bytes. The top threshold value can be between 2 and 52428800 bytes (the default value is 52428800 bytes). To change the upper threshold value for a specific interface, use the `queue-monitor length threshold (Arad/Jericho)` command.

Example

These commands set the upper queue-length threshold on Ethernet interface 5 to 2614400 bytes.

```
switch(config)#interface ethernet 5
switch(config-if-Et5)#queue-monitor length thresholds 2614400
switch(config-if-Et5)#
```

19.2.3.3.4 CPU Port Congestion Thresholds

CPU port queue lengths are also monitored on selected platforms. All CPU ports share common threshold values, which are configured using the [queue-monitor length cpu thresholds](#) command. Individual CPU port congestion thresholds cannot be separately configured.

Examples

- This command sets the upper queue-length threshold for congestion monitoring on all CPU ports to 1000 segments and the lower limit to 300 segments.

```
switch(config)# queue-monitor length cpu thresholds 1000 300
switch(config)#
```

- This command resets the queue-length thresholds for CPU port congestion to the default values of 512 and 256.

```
switch(config)# default queue-monitor length cpu thresholds
switch(config)#
```

19.2.3.3.5 Fabric Port Congestion Thresholds

Fabric port queue lengths are also monitored on selected platforms. All fabric ports share common threshold values, which are configured using the [queue-monitor length fabric thresholds](#) command. Individual fabric port congestion thresholds cannot be separately configured.

Examples

- This command sets the upper queue-length threshold for congestion monitoring on all fabric ports to 1000 segments and the lower limit to 300 segments.

```
switch(config)# queue-monitor length fabric thresholds 1000 300
switch(config)#
```

- This command resets the queue-length thresholds for fabric port congestion to the default values of 512 and 256.

```
switch(config)# default queue-monitor length fabric thresholds
switch(config)#
```

19.2.3.4 Setting LANZ Traffic Sampling

The switch can be configured to automatically send congested traffic to either the CPU or an Ethernet egress interface destination when a queue threshold is crossed by enabling LANZ mirroring through the command [queue-monitor length mirror](#). The CPU or an egress interface mirror destination is then configured through the command [queue-monitor length mirror destination](#). LANZ traffic sampling includes exporting congested traffic to a packet capture device or another tool for analysis, or directly to the switch CPU for inspection through the command [tcpdump queue-monitor](#).

Examples

- This command enables LANZ traffic sampling.

```
switch(config)#queue-monitor length mirror
switch(config)#
```

- This command disables LANZ traffic sampling.

```
switch(config)#no queue-monitor length mirror
switch(config)#
```

- This command configures LANZ traffic sampling for a CPU interface mirror destination.

```
switch(config)#queue-monitor length mirror destination cpu
switch(config)#
```

- This command configures LANZ traffic sampling for an Ethernet interface mirror destination for ports 1 through 5.

```
switch(config)#queue-monitor length mirror destination Ethernet 1-5
switch(config)#
```

- This command configures LANZ traffic sampling for an Ethernet interface mirror destination for ports 6, 10, and 12 through 14.

```
switch(config)#queue-monitor length mirror destination Ethernet
6,10,12-14
switch(config)#
```

- This command inspects traffic on the switch.

```
switch(config)#tcpdump queue-monitor
tcpdump: WARNING: lanz: no IPv4 address assigned
tcpdump: verbose output suppressed, use -v or -vv for full protocol
decode
listening on lanz, link-type EN10MB (Ethernet), capture size 65535
bytes
...
0 packets captured
0 packets received by filter
0 packets dropped by kernel
switch(config)#
```

19.2.3.5 Logging LANZ Congestion Events

To generate syslog messages when queue lengths on an interface exceed its upper threshold, enable logging with the [queue-monitor length log](#) command. When logging is enabled, a log message is generated each time one or more queues on an interface exceed the upper threshold value for that interface (see [queue-monitor length threshold \(Arad/Jericho\)](#) or [queue-monitor length thresholds](#)). Once an interface is over threshold, additional messages are generated at a maximum rate of one per interval as long as the queue length remains above the lower threshold for that interface. No syslog message is generated when queue length drops back under threshold.

Queue length information is not included in log messages, but can be accessed by displaying LANZ data or exporting reports.

On FM6000 platforms, log messages can also be created whenever global buffer usage exceeds its upper threshold value (see [queue-monitor length global-buffer thresholds](#)). To enable global buffer monitoring, use the [queue-monitor length global-buffer](#) command. To log over-threshold events for the global buffer, use the [queue-monitor length global-buffer log](#) command.

Examples:

- This command enables queue-length over-threshold logging with a minimum interval of 10 seconds between messages for a given interface.

```
switch(config)#queue-monitor length log 10
```

- This command disables queue-length over-threshold logging on the switch.

```
switch(config)#queue-monitor length log 0
```

- This is an example of a queue-length log message.

```
Oct 27 12:48:22 switch QUEUE_MONITOR-6-LENGTH_OVER_THRESHOLD:
Interface
Ethernet6 queue length is over threshold of 512, current
length is 1024.
```

- This command enables global buffer over-threshold logging on the switch with a minimum interval of 60 seconds between messages.

```
witch(config)#queue-monitor length global-buffer log 60
```

19.2.3.6 Viewing LANZ Data

LANZ status, and the data stored in the LANZ data buffer, can be viewed using the CLI. Output varies by switch platform, and can be limited to a specified number of records.

19.2.3.6.1 Viewing LANZ Data on Arad Platform Switches

When LANZ is enabled on an Arad platform switch, the `show queue-monitor length` command displays a report of recent over-threshold events for a range of interfaces or for all interfaces. By default, the command displays data for all interfaces, limited to the last 1000 records, with the most recent events listed first. To view a subset of the LANZ data, limited to a specified number of records, use the `show queue-monitor length limit` command.

Example

This command displays the last 100 records for Ethernet interfaces 6 through 8.

```
switch#show queue-monitor length ethernet 6-8 limit 100
Report generated at 2010-01-01 12:56:13

Time                               Interface  Queue length (segments, 1 to 512 bytes)
-----
0:00:07.43393 ago                  Et6        1049
0:00:39.22856 ago                  Et7        2039
1 day, 4:33:23.12345 ago           Et6        1077
```

To view the current LANZ configuration for the switch and for each interface, use the `show queue-monitor length status` command.

Example

This command displays LANZ configuration and status information.

```
switch(config)#show queue-monitor length status
Per-Interface Queue Length Monitoring
-----
Queue length monitoring is enabled
```

```

Maximum queue length in bytes : 5242880
Port threshold in bytes:
Port      High threshold
Et3/1     5242880
Et3/2     5242880
Et3/3     5242880
Et3/4     5242880
Et3/5     5242880

```

19.2.3.6.2 Viewing LANZ Data on FM6000, Trident II, Trident 3, and Tomahawk Platform Switches

When LANZ is enabled on an FM6000, Trident II, Trident 3, or Tomahawk platform switch, the [show queue-monitor length](#) command displays a report of recent over-threshold events for a range of interfaces or for all interfaces. By default, the command displays data for all interfaces, limited to the last 1000 records, with the most recent events listed first. To view a subset of the LANZ data, limited to a specified number of records, use the [show queue-monitor length limit](#) command.

Example

This command displays the last 100 records for Ethernet interfaces 6 through 8.

```

switch#show queue-monitor length ethernet 6-8 limit 100
Report generated at 2010-01-01 12:56:13

Time                               Interface  Queue length (segments, 1 to 512 bytes)
-----
0:00:07.43393 ago                  Et6        1049
0:00:39.22856 ago                  Et7        2039
1 day, 4:33:23.12345 ago           Et6        1077

```

To view the current LANZ configuration for the switch and for each interface, use the [show queue-monitor length status](#) command.

Example

This command displays LANZ configuration and status information.

```

switch(config)# show queue-monitor length status
queue-monitor length enabled
Global Buffer Monitoring
-----
Global buffer monitoring is enabled
Segment size in bytes : 160
Total buffers in segments : 36864
High threshold : 10940
Low threshold : 4376

Per-Interface Queue Length Monitoring
-----
Queue length monitoring is enabled
Segment size in bytes : 480
Maximum queue length in segments : 3647
Port thresholds in segments:
Port      High threshold  Low threshold
Et1       512                256
Et2       512                256
Et3       512                256
Et4       512                256
Et5       512                256

```

To view all available LANZ records, use the [show queue-monitor length all](#) command.

Example

This command displays all available LANZ records.

```

switch> show queue-monitor length all

```

```

Report generated at 2013-04-01 13:23:13
E-End, U-Update, S-Start, TC-Traffic Class
GH-High, GU-Update, GL-Low
Segment size for E, U and S congestion records is 480 bytes
Segment size for GL, GU and GH congestion records is 160 bytes
* Max queue length during period of congestion
+ Period of congestion exceeded counter
-----
-
Type      Time                Intf      Congestion   Queue      Time of Max
          (TC)              duration  length      Queue length
          (TC)              (usecs)   (segments) relative to
                                     congestion
                                     start
                                     (usecs)
-----
-
E 0:00:00.07567 ago    Et22(7)   >=71 mins  20*         30us
GU 0:00:00.15325 ago  N/A       N/A        5695        N/A
U 0:00:00.19859 ago   Et4(1)    N/A        5693        N/A
GU 0:00:00.95330 ago  N/A       N/A        5696        N/A
U 0:00:00.99859 ago   Et4(1)    N/A        5695        N/A
E 0:00:01.28821 ago   Et44(1)   9672us     2502*       7294us
S 0:00:01.17591 ago   Et22(7)   N/A        26          N/A
U 0:00:03.08248 ago   Et44(1)   N/A        50          N/A
S 12days,8:56:44.07567 ago Et44(1)  N/A        20          N/A
switch>

```

On the FM6000, Trident II, Trident 3, and Tomahawk platforms, information is also available for the number of dropped packets (see [show queue-monitor length drops](#)) and transmission latency (see [show queue-monitor length tx-latency](#)); global buffer usage can also be viewed on FM6000 platforms (see [show queue-monitor length global-buffer](#)).

19.2.3.7 Streaming LANZ Data

To support analysis of latency conditions, the switch can be configured to stream LANZ congestion and configuration data. The switch streams LANZ data via TCP in Google protocol buffer format through port 50001 and through the management interface.

You must create a client application to receive the streaming data. By default, the switch will accept up to 10 client connections for streaming LANZ data. This limit can be configured up to a maximum of 100. Maximum connections can be configured when LANZ is disabled.

19.2.3.7.1 Enabling and Disabling LANZ Data Streaming

LANZ data streaming is disabled by default. To enable streaming, issue the **no show queue-monitor streaming clients** command in queue-monitor streaming configuration mode. To disable streaming, use the [show queue-monitor streaming clients](#) command.

When streaming is disabled, a message is sent to any connected clients and the connections are closed.

To ensure client access to LANZ data, add a rule to any relevant ACL permitting traffic destined for the LANZ port (50001) before initiating a client connection for streaming from a remote host. A static rule (sequence number 130) in the default control plane ACL permits LANZ traffic, but a similar rule must be added to any user-created ACL.

Examples

- These commands enable the streaming of LANZ data from the switch.

```

switch(config)#queue-monitor streaming
switch(config-qm-streaming)#no shutdown
switch(config-qm-streaming)#

```

- These commands disable LANZ data streaming.

```
switch(config)#queue-monitor streaming  
switch(config-qm-streaming)#shutdown  
switch(config-qm-streaming)#
```

19.2.3.7.2 Configuring Maximum Connections

By default, the switch will accept a maximum of 10 client connections for LANZ data streaming. This maximum can be configured using the [max-connections](#) command. If a client connects to the switch after the limit has been reached, an error message is sent and the connection is closed.

Example

This command sets the maximum number of client connections for LANZ data streaming to 50.

```
switch(config-qm-streaming)#max-connections 50
```

19.2.3.7.3 LANZ Streaming Messages

When streaming is enabled, LANZ sends a message whenever a congestion event or a configuration event occurs. The messages are streamed in Google protocol buffer format.

Configuration Messages

A configuration message is sent whenever a change is made to the LANZ configuration settings on the switch. The switch also sends a configuration message when a new client connection is established.

The configuration message includes the following information:

- **timestamp** time of change in configuration in tens of microseconds (UTC).
- **lanzVersion** LANZ feature version.
- **numOfPorts** number of ports in the switch.
- **segmentSize** segment size.
- **maxQueueSize** maximum queue size in segments.
- **qLenInterval** frequency of updates.
- **intfName** name of the port.
- **switchId** ID of the chip on a multi-chip system.
- **portId** ID of the port.
- **internalPort** “true” if it is an internal port.
- **highThreshold** higher threshold value.
- **lowThreshold** lower threshold value.

Congestion Messages

A congestion message is sent whenever LANZ generates an over-threshold event.

The congestion message includes the following information:

- **timestamp** time of congestion in micro-seconds (UTC).
- **intfName** name of the port.
- **switchId** ID of the chip on a multi-chip system.
- **portId** ID of the port.
- **queueSize** queue size in segments at time of congestion.

19.2.3.7.4 Creating the LANZ Client

For a client device to receive streaming data from the LANZ server, it must be running a client application designed to receive LANZ data. Client programs must be based on the Google protocol buffer schema file describing the structure of the congestion and configuration messages which LANZ streams.

Google Protocol Buffers

Google protocol buffers provide an efficient mechanism for serializing LANZ data for streaming. A protocol buffer package is needed in order to run a LANZ client.

The latest version of the Google protocol buffer source code is available at this address: <http://code.google.com/p/protobuf/downloads/list>

LANZ Message Schema

LANZ client applications must be designed based on the LANZ protocol buffer schema, which defines the format and contents of the streamed messages. The schema file is shown below, and is also available in the Extensions/LANZ directory on this page: <https://www.arista.com/en/support/software-download>

```
package LanzProtobuf;

message ConfigRecord {
  required uint64 timestamp = 1; // Time of change in configuration in
  micro-seconds (UTC)
  required uint32 lanzVersion = 2; // LANZ feature version
  required uint32 numOfPorts = 3; // Num of ports in the switch
  required uint32 segmentSize = 4; // Segment size
  required uint32 maxQueueSize = 5; // Maximum queue size in segments
  optional uint32 qLenInterval = 10; // Frequency of update
  message PortConfigRecord {
    required string intfName = 1; // Name of the port
    required uint32 switchId = 2; // Id of the chip on a multi-chip system
    required uint32 portId = 3; // Id of the port
    required bool internalPort = 4; // 'True' if it's an internal port
    required uint32 highThreshold = 5; // Higher threshold
    required uint32 lowThreshold = 6; // Lower threshold
  }

  repeated PortConfigRecord portConfigRecord = 6; // Lanz config details of
  each
  port
}

message CongestionRecord {
  required uint64 timestamp = 1; // Time of congestion in micro-seconds
  (UTC)
  required string intfName = 2; // Name of the port
  required uint32 switchId = 3; // Id of the chip on a multi-chip system
  required uint32 portId = 4; // Id of the port
  required uint32 queueSize = 5; // Queue size in segments at time of
  congestion
}

message ErrorRecord {
  required uint64 timestamp = 1; // Time of event in micro-seconds (UTC)
  required string errorMessage = 2; // Text message
}

message LanzRecord {
  optional ConfigRecord configRecord = 1;
  optional CongestionRecord congestionRecord = 2;
```

```
optional ErrorRecord errorRecord = 3;
}
```

Implementation Procedure

The following steps create and install a functional client to receive streamed LANZ data. This procedure assumes a functional Python programming environment.

1. Download the example client (lanz_client.py) from the Arista website. It is available in the Extensions/LANZ directory on this page: <https://www.arista.com/en/support/software-download>
2. Decompress the GPB archive to a directory.
3. Run the GPB C++ compilation and install. With default flags using GCC on *nix platforms, this will produce a binary called "protoc" in your /usr/local/bin directory.
4. From the archive root, **cd** to python, and run the following commands:

```
python setup.py build
```

```
python setup.py test
```

5. Next, use the protoc compiler to convert the Lanz.proto file into a Python program called Lanz_pb2.py, used by the client. The command to do so is:

```
protoc --python_out=. Lanz.proto
```

The **--python_out=.** flag drops the compiled Python program in the directory where you ran the command.

6. Run **lanz_client.py -h** to activate the LANZ client.

19.2.4 LANZ Commands

LANZ Commands: Global Configuration

- `clear queue-monitor length statistics`
- `queue-monitor length (global configuration mode)`
- `queue-monitor length cpu thresholds`
- `queue-monitor length fabric thresholds`
- `queue-monitor length global-buffer`
- `queue-monitor length global-buffer log`
- `queue-monitor length global-buffer thresholds`
- `queue-monitor length log`
- `queue-monitor length mirror`
- `queue-monitor length mirror destination`
- `queue-monitor length notifying`
- `queue-monitor length update-interval`
- `queue-monitor streaming`
- `tcpdump queue-monitor`

LANZ Commands: Interface Ethernet Configuration Mode

- `queue-monitor length threshold (Arad/Jericho)`
- `queue-monitor length thresholds`

LANZ Commands: Queue-Monitor Streaming Configuration Mode

- `max-connections`

LANZ Display Commands

- `show queue-monitor length`
- `show queue-monitor length all`
- `show queue-monitor length cpu`
- `show queue-monitor length csv`
- `show queue-monitor length drops`
- `show queue-monitor length ethernet`
- `show queue-monitor length global-buffer`
- `show queue-monitor length limit`
- `show queue-monitor length drops`
- `show queue-monitor length statistics`
- `show queue-monitor length status`
- `show queue-monitor length tx-latency`
- `show queue-monitor streaming clients`

19.2.4.1 clear queue-monitor length statistics

The `clear queue-monitor length statistics` command resets the occurrences of all over-threshold events on the switch including global buffer information (if supported).

Command Mode

Privileged EXEC

Command Syntax

```
clear queue-monitor length statistics
```

Example

This command resets all over-threshold events and global buffer information on an FM6000 switch.

```
switch#clear queue-monitor length statistics  
switch#
```

19.2.4.2 max-connections

The `max-connections` command sets the maximum number of client connections the switch accepts for streaming LANZ data. The default maximum is 10 connections. To stream LANZ data, you must use the [queue-monitor streaming](#) command to enable LANZ data streaming.

Command Mode

Queue-Monitor-Streaming Configuration

Command Syntax

```
max-connections connections
```

Parameters

connections maximum number of simultaneous LANZ streaming client connections the switch will accept. Values range from 1 through 100.

Related Commands

[queue-monitor streaming](#) places the switch in queue-monitor-streaming configuration mode.

Example

This command sets the maximum number of client connections the switch accepts for LANZ data streaming to 50.

```
switch(config-qm-streaming) #max-connections 50  
switch(config-qm-streaming) #
```

19.2.4.3 queue-monitor length (global configuration mode)

The **queue-monitor length (global configuration mode)** command enables LANZ with the current settings, or with the default settings if LANZ has not yet been configured. LANZ is enabled by default on Sand platform switches (those with Arad, Jericho, or Qumran chipsets), and disabled by default on all other switches.

When LANZ is enabled, the switch monitors queue lengths on all ports and generates over-threshold events when an output queue becomes congested. Over-threshold event data is available in the following forms:

- syslog data (see [queue-monitor length log](#))
- CLI display or CSV-format output (see [show queue-monitor length](#))
- data stream (see [queue-monitor streaming](#))

The **no queue-monitor length** command entered in global configuration mode disables LANZ and discards LANZ log data, but retains settings. LANZ settings include:

- logging settings (see [queue-monitor length log](#))
- queue length thresholds (see [queue-monitor length threshold \(Arad/Jericho/Qumran\)](#) or [queue-monitor length thresholds](#)).
- data streaming settings (see [queue-monitor streaming](#)).

To disable LANZ on an interface, use the **no queue-monitor length** command in interface configuration mode.

Command Mode

Global Configuration

Command Syntax

```
queue-monitor length
no queue-monitor length
default queue-monitor length
```

Examples

- This command enables LANZ on the switch.

```
switch(config)#queue-monitor length
switch(config)#
```

- This command disables LANZ on the switch and discards LANZ data but maintains configurations.

```
switch(config)#no queue-monitor length
switch(config)#
```

- This command disables LANZ on Ethernet interface 3/30.

```
switch(config)#interface ethernet 3/30
switch(config-if-Et3/30)#no queue-monitor length
switch(config-if-Et3/30)#
```

19.2.4.4 queue-monitor length cpu thresholds

The **queue-monitor length cpu thresholds** command sets the queue length threshold to define “congested” on all CPU ports for purposes of LANZ reporting. If LANZ is enabled (see [queue-monitor length \(global configuration mode\)](#)), an over-threshold event is generated when one or more queues on a CPU interface exceed the upper threshold, and over-threshold events continue to be generated until all queue lengths on the interface drop below the lower threshold. (To log these events, use the [queue-monitor length log](#) command.) Different monitoring thresholds cannot be set for individual CPU ports.

The **no queue-monitor length cpu thresholds** and **default queue-monitor length cpu thresholds** commands reset thresholds to the default values (high: 512 segments; low: 256 segments).

Command Mode

Global Configuration

Command Syntax

```
queue-monitor length cpu thresholds upper_limit lower_limit
```

```
no queue-monitor length cpu thresholds
```

```
default queue-monitor length cpu thresholds
```

Parameters

- *upper_limit* is the queue length in segments that triggers an over-threshold event. Values range from 8 to 16382. Default setting is 512. Segment size varies by platform.
- *lower_limit* When logging is enabled, an over-threshold interface continues generating over-threshold events until all its queues drop back below this length. Must be lower than *upper_limit*. Values range from 1 to 16382. Default setting is 256.

Examples

- This command sets the upper queue-length threshold for congestion monitoring on all CPU ports to 1000 segments and the lower limit to 300 segments.

```
switch(config)#queue-monitor length cpu thresholds 1000 300
switch(config)#
```

- This command resets the queue-length thresholds for CPU port congestion to the default values of 512 and 256.

```
switch(config)#default queue-monitor length cpu thresholds
switch(config)#
```

19.2.4.5 queue-monitor length fabric thresholds

The **queue-monitor length fabric thresholds** command sets the [queue length threshold](#) to define “congested” on all fabric ports for purposes of LANZ reporting. If LANZ is enabled (see [queue-monitor length](#) (global configuration mode)), an over-threshold event is generated when one or more queues on a fabric interface exceed the upper threshold, and over-threshold events continue to be generated until all queue lengths on the interface drop below the lower threshold. (To log these events, use the [queue-monitor length log](#) command.) Different monitoring thresholds cannot be set for individual fabric ports.

The **no queue-monitor length fabric thresholds** and **default queue-monitor length fabric thresholds** commands reset thresholds to the default values (high: 512 segments; low: 256 segments).

Command Mode

Global Configuration

Command Syntax

```
queue-monitor length fabric thresholds upper_limit lower_limit  
no queue-monitor length fabric thresholds  
default queue-monitor length fabric thresholds
```

Parameters

- *upper_limit* is the queue length in segments that triggers an over-threshold event. Values range from 8 to 16382. Default setting is 512. Segment size varies by platform.
- *lower_limit* When logging is enabled, an over-threshold interface continues generating over-threshold events until all its queues drop back below this length. Must be lower than *upper_limit*. Values range from 1 to 16382. Default setting is 256.

Examples

- This command sets the upper queue-length threshold for congestion monitoring on all fabric ports to 1000 segments and the lower limit to 300 segments.

```
switch(config)#queue-monitor length fabric thresholds 1000 300  
switch(config)#
```

- This command resets the queue-length thresholds for fabric port congestion to the default values of 512 and 256.

```
switch(config)#default queue-monitor length fabric thresholds  
switch(config)#
```

19.2.4.6 queue-monitor length global-buffer log

The `queue-monitor length global-buffer log` command enables logging of global buffer over-threshold events. When logging is enabled, a log message is generated each time the contents of the global buffer exceed the upper threshold value set for the switch (see [queue-monitor length global-buffer thresholds](#)). Once the global buffer is over the threshold, additional messages are generated at a maximum rate of one per interval as long as the buffer value remains above the lower threshold for the switch.

Global buffer logging is disabled by default.

Log messages do not include buffer usage or congestion information. To view this information, use the [show queue-monitor length global-buffer](#) command.

The `no queue-monitor length global-buffer log` and `default queue-monitor length global-buffer log` commands disable global buffer logging by removing the corresponding `queue-monitor length global-buffer log` command from *running-config*. The `queue-monitor length global-buffer log` command with an interval value of 0 also disables global buffer logging.

Command Mode

Global Configuration

Command Syntax

```
queue-monitor length global-buffer log interval
no queue-monitor length global-buffer log
default queue-monitor length global-buffer log
```

Parameters

- *interval* minimum interval in seconds between logged messages.
 - 0 global buffer logging is disabled on the switch (the default setting).
 - 1 to 65535 minimum logging interval (in seconds).

Guidelines

This command is available on FM6000 platform switches.

Examples

- This command enables global buffer logging with a minimum interval of 10 seconds between messages.

```
switch(config)#queue-monitor length global-buffer log 10
```

- This command disables global buffer logging on the switch.

```
switch(config)#no queue-monitor length global-buffer log
```

19.2.4.7 queue-monitor length global-buffer thresholds

The queue-monitor length global-buffer thresholds command sets global buffer thresholds for the switch. An over-threshold event is generated when usage of the global buffer exceeds the upper threshold, and over-threshold events continue to be generated until usage drops below the lower threshold. (To log these events, use the [queue-monitor length global-buffer log](#) command.)

The no queue-monitor length global-buffer and default queue-monitor length global-buffer commands disable global buffer reporting.

The **no queue-monitor length global-buffer thresholds** and **default queue-monitor length global-buffer thresholds** commands erase custom global buffer threshold settings.

Command Mode

Global Configuration

Command Syntax

```
queue-monitor length global-buffer thresholds max_segments min_segments
```

```
no queue-monitor length global-buffer log
```

```
default queue-monitor length global-buffer log
```

Parameters

- *max_segments* upper threshold in 160-byte segments. Value ranges from 2 to 36864. Default is 10940.
- *min_segments* lower threshold in 160-byte segments. Value ranges from 1 to 36864. Default is 4376.

Examples

- This command sets the upper and lower global buffer thresholds to *9000* segments and *3000* segments.

```
switch(config)#queue-monitor length global-buffer thresholds 9000  
3000  
switch(config)#
```

- This command resets the upper and lower global buffer thresholds to their default values.

```
switch(config)#no queue-monitor length global-buffer thresholds 9000  
3000  
switch(config)#
```

19.2.4.8 queue-monitor length global-buffer

The `queue-monitor length global-buffer` command includes global buffer usage in LANZ reporting.

When global buffer reporting is enabled, over-threshold events are generated when global buffer usage exceeds the upper threshold. To set the threshold value, use the [queue-monitor length global-buffer thresholds](#) command. Usage data may be viewed using the [show queue-monitor length global-buffer](#) command. To view status and threshold information, use the [show queue-monitor length status](#) command.

Global buffer usage is measured in segments of 160 bytes.

The `no queue-monitor length global-buffer` and `default queue-monitor length global-buffer` commands disable global buffer usage reporting by removing the corresponding `queue-monitor length global-buffer` command from *running-config*.

Command Mode

Global Configuration

Command Syntax

```
queue-monitor length global-buffer
no queue-monitor length global-buffer
default queue-monitor length global-buffer
```

Guidelines

This command is available on FM6000 platform switches.

Examples

- This command enables global buffer monitoring on the switch.

```
switch(config)#queue-monitor length global-buffer
switch(config)#
```

- This command disables global buffer monitoring on the switch.

```
switch(config)#no queue-monitor length global-buffer
switch(config)#
```

19.2.4.9 queue-monitor length log

The `queue-monitor length log` command enables logging of queue-length over-threshold events when LANS is enabled on the switch (see [queue-monitor length \(global configuration mode\)](#)). When logging is enabled, a log message is generated each time one or more queues on an interface exceed the upper threshold value for that interface (see [queue-monitor length threshold \(Arad/Jericho\)](#)). Once an interface is over threshold, additional messages are generated at a maximum rate of one per interval as long as the queue length remains above the lower threshold for that interface. No syslog message is generated when queue length drops back under threshold.

Logging is disabled by default.

Log messages do not include queue length information. To view queue length information, use the [show queue-monitor length](#) command.

The `queue-monitor length log` command with an interval value of 0 disables event logging.

Command Mode

Global Configuration

Command Syntax

```
queue-monitor length log interval
```

Parameters

- *interval* minimum interval in seconds between logged messages from a single interface.
 - 0 queue-length logging is disabled on the switch (the default setting).
 - 1 to 65535 minimum logging interval (in seconds).
 - 1 to 65535 minimum logging interval (in seconds).

Examples

- This command enables over-threshold logging with a minimum interval of 10 seconds between messages for a given interface.

```
switch(config)#queue-monitor length log 10
```

- This command disables queue-length over-threshold logging on the switch.

```
switch(config)#queue-monitor length log 0
```

- This is an example of a queue-length log message.

```
Oct 27 12:48:22 switch QUEUE_MONITOR-6-LENGTH_OVER_THRESHOLD: Interface  
Ethernet6 queue length is over threshold of 512, current length is  
1024.
```

19.2.4.10 queue-monitor length mirror destination

The **queue-monitor length mirror destination** command results in automatically sending traffic experiencing congestion to either the CPU or an Ethernet egress interface destination, once a queue threshold is crossed. Before using this command, first enable LANZ mirroring through the command [queue-monitor length mirror](#).

Command Mode

Global Configuration

Command Syntax

```
queue-monitor length mirror destination cpu | Ethernet <ports 1-24>
```

Parameters

ports any combination of Ethernet ports 1 through 24.

Examples

- This command configures LANZ traffic sampling for a CPU interface mirror destination.

```
switch(config)#queue-monitor length mirror destination cpu  
switch(config)#
```

- This command configures LANZ traffic sampling for an Ethernet interface mirror destination for ports 3, 11, and 15 through 20.

```
switch(config)#queue-monitor length mirror destination Ethernet  
3,11,15-20  
switch(config)#
```

19.2.4.11 queue-monitor length mirror

The **queue-monitor length mirror** command enables LANZ mirroring. As a result, the switch is configured to automatically send congested traffic to either the CPU or an Ethernet egress interface destination, once a queue threshold is crossed. To set the destination for the mirrored traffic, use the [queue-monitor length mirror destination](#) command.

Command Mode

Global Configuration

Command Syntax

```
queue-monitor length mirror
```

Examples

- This command enables LANZ traffic sampling.

```
switch(config)#queue-monitor length mirror  
switch(config)#
```

- This command disables LANZ traffic sampling.

```
switch(config)#no queue-monitor length mirror  
switch(config)#
```

19.2.4.12 queue-monitor length notifying

The **queue-monitor length notifying** command enables Notifying Mode on Arad and Jericho switches. By default, LANZ operates in Polling Mode on Arad and Jericho switches. On all other switches, LANZ operates only in Notifying Mode.

When Notifying Mode is enabled, the switch provides detailed congestion information including Start, Update, and End events, rather than only polling the most congested queue in each ASIC. Notifying Mode uses both upper and lower threshold values. Both can be set with the [queue-monitor length thresholds](#) command. While a queue is congested, the maximum queue size is updated every five seconds by default; this interval can be configured using the [queue-monitor length update-interval](#) command.

The **no queue-monitor length notifying** and **default queue-monitor length notifying** commands reset LANZ to the default Polling Mode.

Command Mode

Global Configuration

Command Syntax

```
queue-monitor length notifying
no queue-monitor length notifying
default queue-monitor length notifying
```

Guidelines

- Polling mode is available only on Arad and Jericho platform switches.
- On Jericho platforms, LANZ will revert to Polling Mode if there are not enough counter resources to operate in Notifying Mode.
- On Arad platforms, Notifying Mode is incompatible with SSO. Enabling SSO while Notifying Mode is enabled will cause LANZ to revert to Polling Mode.
- On Arad platforms, Notifying Mode is not available for CPU queues. Use Polling Mode when monitoring congestion on CPU queues on Arad switches.
- If the switch is rebooted while Notifying Mode is enabled, queue threshold values may be lost.

Examples

- This command enables Notifying Mode on an Arad or Jericho switch.

```
switch(config)#queue-monitor length notifying
switch(config)#
```

- This command disables Notifying Mode on an Arad or Jericho switch, returning LANZ to the default Polling Mode.

```
switch(config)#no queue-monitor length notifying
switch(config)#
```

19.2.4.13 queue-monitor length threshold (Arad/Jericho/Qumran)

The **queue-monitor length threshold** command sets the upper queue-length threshold on Arad, Jericho, and Qumran platforms to define “congested” on the command-mode interface for purposes of LANZ reporting. If LANZ is enabled (see [queue-monitor length \(global configuration mode\)](#)), an over-threshold event is generated when one or more queues on the interface exceed the upper threshold, and over-threshold events continue to be generated until all queue lengths on the interface drop below the lower threshold. (To log these events, use the [queue-monitor length log](#) command.)

Entering the **no queue-monitor length** command in interface configuration mode disables LANZ on the interface. Entering either the **queue-monitor length threshold** command or the **default queue-monitor length threshold** command enables LANZ on the interface by removing the **no queue-monitor length** command from the configuration.

The **no queue-monitor length threshold** and **default queue-monitor length threshold** commands erase custom queue length threshold settings for the interface.

Command Mode

Interface-Ethernet Configuration

Command Syntax

```
queue-monitor length threshold upper_limit
no queue-monitor length
default queue-monitor length
```

Parameters

upper_limit is the queue length in bytes that triggers an over-threshold event. Values range from 40962 to 52428800 bytes. Default setting is 52428800.

Guidelines

On Arad, Jericho, and Qumran platforms, the queue length is measured in bytes. Only the upper threshold is configurable using this command, and it is set at a default value of 52428800 bytes. Both upper and lower thresholds can be set using the [queue-monitor length thresholds](#) command.

Examples

- These commands set the upper queue-length threshold on *Ethernet interface 3/30* to 40000000 bytes.

```
switch(config)#interface ethernet 3/30
switch(config-if-Et3/30)#queue-monitor length threshold 40000000
switch(config-if-Et3/30)#
```

- These commands reset the upper queue-length threshold on *Ethernet interface 3/30* to its default value of 52428800 bytes.

```
switch(config)#interface ethernet 3/30
switch(config-if-Et3/30)#default queue-monitor length threshold
switch(config-if-Et3/30)#
```

19.2.4.14 queue-monitor length thresholds

The **queue-monitor length thresholds** command sets both upper and lower queue length thresholds to define “congested” on the command-mode interface for purposes of LANZ reporting. If LANZ is enabled (see [queue-monitor length \(global configuration mode\)](#)), an over-threshold event is generated when one or more queues on the interface exceed the upper threshold, and over-threshold events continue to be generated until all queue lengths on the interface drop below the lower threshold. (To log these events, use the [queue-monitor length log](#) command.)

Entering the **no queue-monitor length** command in interface configuration mode disables LANZ on the interface. Entering either the **queue-monitor length** command or the **default queue-monitor length** command in interface configuration mode enables LANZ on the interface by removing the **no queue-monitor length** command from the configuration.

The **no queue-monitor length thresholds** and **default queue-monitor length thresholds** commands in interface configuration mode both erase custom queue length threshold settings for the interface.

Command Mode

Interface-Ethernet Configuration

Command Syntax

```
queue-monitor length thresholds upper_limit lower_limit
no queue-monitor length
default queue-monitor length
```

Parameters

- *upper_limit* queue length in segments that triggers an over-threshold event. Must be higher than *lower_limit*. The minimum value is 2. The maximum is the largest number of segments which can be queued before packets are dropped, and varies based on factors including flow control state and private buffer settings. Default setting is 512.
- *lower_limit* lower queue length threshold in segments. When logging is enabled, an over-threshold interface continues generating over-threshold events until all its queues drop back below this length. Must be lower than *upper_limit*. Values range from 1 to 4806. Default setting is 256.

Guidelines

Queue lengths are measured in 480-byte segments on FM6000 switches, in 208-byte segments on Trident II and Tomahawk switches, in 256-byte segments on Trident 3 switches, and in bytes on Arad and Jericho switches. Default thresholds vary by platform. Both upper and lower thresholds are configurable.

Examples

- These commands set the upper and lower queue-length thresholds on *Ethernet interface 5* to 300 segments and 200 segments.

```
switch(config)#interface ethernet 5
switch(config-if-Et5)#queue-monitor length thresholds 300 200
switch(config-if-Et5)#
```

- These commands reset the upper and lower queue-length thresholds on *Ethernet interface 5* to their default values.

```
switch(config)#interface ethernet 5
switch(config-if-Et5)#default queue-monitor length thresholds
switch(config-if-Et5)#
```

19.2.4.15 queue-monitor length update-interval

The **queue-monitor length update-interval** command sets the interval between congestion updates when LANZ is in Notifying Mode.

The **no queue-monitor length update-interval** and **default queue-monitor length update-interval** commands reset the update interval to its default value of 5000000 (5 seconds).

Command Mode

Global Configuration

Command Syntax

```
queue-monitor length update-interval interval
```

```
no queue-monitor length
```

```
default queue-monitor length
```

Parameters

interval is the time in microseconds between congestion updates. Values range from 80-10000000; default setting is 5000000 (5 seconds).

Examples

- This command sets the time between congestion updates to 10 seconds.

```
switch(config)#queue-monitor length update-interval 10000000  
switch(config)#
```

- This command resets the time between congestion updates to its default value of 5 seconds.

```
switch(config)#default queue-monitor length update-interval  
switch(config)#
```

19.2.4.16 queue-monitor streaming

The **queue-monitor streaming** command places the switch in queue-monitor-streaming configuration mode. Queue-monitor-streaming configuration mode is not a group change mode; **running-config** is changed immediately upon command entry. The exit command does not affect **running-config**.

To enable LANZ data streaming on the switch, use the **no show queue-monitor streaming clients** command.

The **exit** command returns the switch to global configuration mode.

Command Mode

Global Configuration

Command Syntax

```
queue-monitor streaming
```

Commands Available in queue-monitor streaming Configuration Mode

- [max-connections](#)
- [show queue-monitor streaming clients](#)

Example

This command places the switch in queue-monitor streaming configuration mode.

```
switch(config)#queue-monitor streaming  
switch(config-qm-streaming)#
```

19.2.4.17 show queue-monitor length all

The **show queue-monitor length all** command displays all available over-threshold event records on the switch including global buffer information, with the most recent events listed first.

LANZ must be enabled to use this command (see [queue-monitor length \(global configuration mode\)](#)). If LANZ is disabled, the command displays “queue-monitor is disabled.”

Command Mode

EXEC

Command Syntax

```
show queue-monitor length all
```

Guidelines

This command is available on FM6000 platform switches.

Example

This command displays all available LANZ records from the switch.

```
switch>show queue-monitor length all

Report generated at 2013-04-01 13:23:13
E-End, U-Update, S-Start, TC-Traffic Class
GH-High, GU-Update, GL-Low
Segment size for E, U and S congestion records is 480 bytes
Segment size for GL, GU and GH congestion records is 160 bytes
* Max queue length during period of congestion
+ Period of congestion exceeded counter
-----
Type      Time                Intf      Congestion   Queue      Time of Max
          (ago)              (TC)      duration    length     Queue length
          (ago)              (TC)      (usecs)     (segments) relative to
          (ago)              (TC)      (usecs)     (segments) congestion
          (ago)              (TC)      (usecs)     (segments) start
          (ago)              (TC)      (usecs)     (segments) (usecs)
-----
E 0:00:00.07567 ago   Et22(7)   >=71 mins   20*        30us
GU 0:00:00.15325 ago N/A       N/A         5695       N/A
U 0:00:00.19859 ago   Et4(1)    N/A         5693       N/A
GU 0:00:00.95330 ago  N/A       N/A         5696       N/A
U 0:00:00.99859 ago   Et4(1)    N/A         5695       N/A
E 0:00:01.28821 ago   Et44(1)   9672us     2502*      7294us
S 0:00:01.17591 ago   Et22(7)   N/A         26         N/A
U 0:00:03.08248 ago   Et44(1)   N/A         50         N/A
S 12days,8:56:44.07567 ago Et44(1)   N/A         20         N/A
switch>
```

19.2.4.18 show queue-monitor length cpu

The **show queue-monitor length cpu** command displays LANZ data for CPU ports on the switch. On Trident II and Tomahawk platforms, the “Interface” column identifies the CPU port by its card slot and chip index.

LANZ must be enabled to use this command (see [queue-monitor length \(global configuration mode\)](#)). If LANZ is disabled, the command displays “queue-monitor is disabled.”

Command Mode

EXEC

Command Syntax

```
show queue-monitor length cpu
```

Examples

- This command displays LANZ data for CPU ports on a Trident II or Tomahawk switch.

```
switch>show queue-monitor length cpu
Report generated at 2017-03-10 15:24:11
E-End, U-Update, S-Start, TC-Traffic Class
Segment size for E, U and S congestion records is 208 bytes
* Max queue length during period of congestion
+ Period of congestion exceeded counter
```

Type	Time	Interface (TC)	Congestion duration (usecs)	Queue length (segments)	Time of Max Queue length relative to congestion start (usecs)	Fabric Peer
E	0:02:24.19153 ago	Cpu0/0 (39)	16669811	271*	0	
U	0:02:25.81126 ago	Cpu0/0 (39)	N/A	270	N/A	
U	0:02:30.81126 ago	Cpu0/0 (39)	N/A	270	N/A	
U	0:02:35.81128 ago	Cpu0/0 (39)	N/A	270	N/A	
U	0:02:40.81129 ago	Cpu0/0 (39)	N/A	270	N/A	
U	0:02:40.81630 ago	Cpu0/0 (39)	N/A	270	N/A	
U	0:02:40.82130 ago	Cpu0/0 (39)	N/A	270	N/A	
U	0:02:40.82631 ago	Cpu0/0 (39)	N/A	270	N/A	
U	0:02:40.83132 ago	Cpu0/0 (39)	N/A	270	N/A	
U	0:02:40.83632 ago	Cpu0/0 (39)	N/A	270	N/A	
U	0:02:40.84132 ago	Cpu0/0 (39)	N/A	270	N/A	
U	0:02:40.84633 ago	Cpu0/0 (39)	N/A	270	N/A	
U	0:02:40.85133 ago	Cpu0/0 (39)	N/A	270	N/A	
U	0:02:40.85634 ago	Cpu0/0 (39)	N/A	270	N/A	
S	0:02:40.86134 ago	Cpu0/0 (39)	N/A	271	N/A	

- This command displays LANZ data for CPU ports on an FM6000 switch.

```
switch>show queue-monitor length cpu
Report generated at 2017-03-10 15:17:57
E-End, U-Update, S-Start, TC-Traffic Class
GH-High, GU-Update, GL-Low
Segment size for E, U and S congestion records is 480 bytes
Segment size for GL, GU and GH congestion records is 160 bytes
* Max queue length during period of congestion
+ Period of congestion exceeded counter
```

Type	Time	Intf (TC)	Congestion duration (usecs)	Queue length (segments)	Time of Max Queue length relative to congestion start (usecs)
E	0:04:41.17456 ago	Cpu(11)	29	1024*	0
S	0:04:41.17459 ago	Cpu(11)	N/A	1024	N/A
E	0:04:41.17463 ago	Cpu(11)	15926108	206*	33872
U	0:04:42.09651 ago	Cpu(11)	N/A	205	N/A
U	0:04:47.09710 ago	Cpu(11)	N/A	205	N/A
U	0:04:52.09769 ago	Cpu(11)	N/A	205	N/A

U	0:04:57.09826 ago	Cpu(11)	N/A	205	N/A
---	-------------------	---------	-----	-----	-----

- This command displays LANZ data for CPU ports on an Arad or Jericho switch in Polling Mode.

```
switch>show queue-monitor length cpu
Report generated at 2017-03-10 16:04:28
E-End, S-Start, P-Polling, TC-Traffic Class
* Max queue length during period of congestion
Type  Time                Intf(TC)                Queue Length          Duration  Ingress
                               (bytes)                (usecs)                Port-set
-----
P     0:00:31.48474 ago  CoppSystemL2Ucast(5)   10486080             20184965             Et1-24
```

- This command displays LANZ data for CPU ports on an Arad or Jericho switch in Notifying Mode.

```
switch>show queue-monitor length cpu
Report generated at 2017-03-10 16:08:58
E-End, S-Start, P-Polling, TC-Traffic Class
* Max queue length during period of congestion
Type  Time                Intf(TC)                Queue Length          Duration  Ingress
                               (bytes)                (usecs)                Port-set
-----
E     0:00:03.11739 ago  CoppSystemL2Ucast(5)   10485760*            20700629             Et1-24
U     0:00:04.01513 ago  CoppSystemL2Ucast(5)   10485760              N/A                 Et1-24
U     0:00:08.94918 ago  CoppSystemL2Ucast(5)   10485760              N/A                 Et1-24
U     0:00:13.88323 ago  CoppSystemL2Ucast(5)   10485760              N/A                 Et1-24
U     0:00:18.81728 ago  CoppSystemL2Ucast(5)   10485760              N/A                 Et1-24
U     0:00:23.74758 ago  CoppSystemL2Ucast(5)   10485760              N/A                 Et1-24
S     0:00:23.81802 ago  CoppSystemL2Ucast(5)   10485760              N/A                 Et1-24
```

19.2.4.19 show queue-monitor length csv

The **show queue-monitor length csv** command displays LANZ records in comma-separated value (CSV) format with the oldest samples displayed first.

LANZ must be enabled to use this command (see [queue-monitor length \(global configuration mode\)](#)). If LANZ is disabled, the command displays “queue-monitor is disabled.”

Command Mode

EXEC

Command Syntax

```
show queue-monitor length csv
```

Example

This command displays LANZ records in CSV format.

```
switch>show queue-monitor length csv

Report generated at 2016-02-09 22:57:50
Type,Time,Interface,Duration(usecs),Queue-Length,Time-Of-Max-Queue(us
ecs),Iaten
cy(usecs),Tx-Drops
  S,2016-02-09 22:53:05.70596,Et29(11),N/A,2590,N/A,60.088,0
  U,2016-02-09 22:53:05.71098,Et29(11),N/A,2590,N/A,60.088,216555
  U,2016-02-09 22:53:05.71600,Et29(11),N/A,2590,N/A,60.088,215546
switch>
```

19.2.4.20 show queue-monitor length drops

The **show queue-monitor length drops** command displays a report of cumulative transmission drop totals for a range of interfaces or for all interfaces. Output can be limited to a specified number of seconds or records. The most recent events are listed first. By default, the command displays data for all interfaces, limited to the last 1000 records. Newest events are listed first.

LANZ must be enabled to use this command (see [queue-monitor length \(global configuration mode\)](#)). If LANZ is disabled, the command displays “queue-monitor is disabled.”

Command Mode

EXEC

Command Syntax

```
show queue-monitor length [INTERFACES][FACTOR] drops
```

Parameters

- **INTERFACES** interface type and number for report. Values include:
 - *<no parameter>* displays information for all interfaces.
 - **ethernet e-range** e-range formats include a number, number range, or comma-delimited list of numbers and ranges.
- **FACTOR** limiting parameter for report. Values include:
 - *<no parameter>* displays the last 1000 records.
 - **limit number samples** displays the last *number* records.
 - **limit number seconds** displays all records generated during the last *number* seconds.

Value of number ranges from 1 to 1000000.

Guidelines

This command is available on FM6000, Trident II, Trident 3, and Tomahawk platform switches.

Example

- This command displays the last 10 records of transmission drop data on an FM6000 switch.

```
switch>show queue-monitor length limit 10 samples drops
Report generated at 2017-03-10 15:25:29
Time                Interface      TX Drops
-----
0:12:13.34425 ago   Cpu           419
0:12:13.34428 ago   Cpu           371
0:12:13.34433 ago   Cpu          9913826
0:12:14.26621 ago   Cpu          53775812
0:12:19.26680 ago   Cpu          53775740
0:12:24.26738 ago   Cpu          53775714
0:12:29.26796 ago   Cpu           1073
0:12:29.26806 ago   Cpu           1068
0:12:29.26816 ago   Cpu           1074
0:12:29.26825 ago   Cpu           1071
```

- This command displays the last 10 records of transmission drop data on a Trident II or Tomahawk switch.

```
switch>show queue-monitor length limit 10 samples drops
Report generated at 2017-03-10 15:25:34
Time                Interface (TC)  TX Drops
-----
0:03:47.06553 ago   Cpu0/0 (39)   17419818
0:03:48.68527 ago   Cpu0/0 (39)   53773707
0:03:53.68527 ago   Cpu0/0 (39)   53773770
0:03:58.68528 ago   Cpu0/0 (39)   53773763
0:04:03.68529 ago   Cpu0/0 (39)   53878
0:04:03.69030 ago   Cpu0/0 (39)   53777
```

```
0:04:03.69530 ago      Cpu0/0 (39)      53917
0:04:03.70031 ago      Cpu0/0 (39)      53880
0:04:03.70532 ago      Cpu0/0 (39)      53786
0:04:03.71032 ago      Cpu0/0 (39)      53782
switch>
```

19.2.4.21 show queue-monitor length ethernet

The **show queue-monitor length ethernet** command displays a report of recent over-threshold events for a range of interfaces, with the newest events listed first.

LANZ must be enabled to use this command (see [queue-monitor length \(global configuration mode\)](#)). If LANZ is disabled, the command displays “queue-monitor is disabled.”

Command Mode

EXEC

Command Syntax

```
show queue-monitor length ethernet e-range
```

Parameters

e-range the range of interfaces to be included in the report; formats include a number, number range, or comma-delimited list of numbers and ranges

Examples

- This command displays the last 1000 records for Ethernet interface 9 on an FM6000 platform switch.

```
switch>show queue-monitor length ethernet 9
Report generated at 2017-03-10 15:33:35
E-End, U-Update, S-Start, TC-Traffic Class
GH-High, GU-Update, GL-Low
Segment size for E, U and S congestion records is 480 bytes
Segment size for GL, GU and GH congestion records is 160 bytes
* Max queue length during period of congestion
+ Period of congestion exceeded counter
-----
Type      Time                Intf      Congestion   Queue      Time of Max
          ago                (TC)      duration    length     Queue length
          (usecs)                (segments) relative to
          (usecs)                congestion
          start
          (usecs)
-----
E 0:00:24.82515 ago    Et9(1)    22737967    5623*     26651
U 0:00:27.55841 ago    Et9(1)    N/A         5620      N/A
U 0:00:32.55899 ago    Et9(1)    N/A         5620      N/A
U 0:00:37.55957 ago    Et9(1)    N/A         5621      N/A
U 0:00:42.56015 ago    Et9(1)    N/A         5621      N/A
U 0:00:47.56073 ago    Et9(1)    N/A         5621      N/A
U 0:00:47.56083 ago    Et9(1)    N/A         5620      N/A
U 0:00:47.56093 ago    Et9(1)    N/A         5620      N/A
U 0:00:47.56103 ago    Et9(1)    N/A         5620      N/A
U 0:00:47.56113 ago    Et9(1)    N/A         5620      N/A
switch>
```

- This command displays the last 1000 records for Ethernet interface 23/3 on a Trident II or Tomahawk platform switch.

```
switch>show queue-monitor length Ethernet 23/3
Report generated at 2017-03-10 15:38:01
E-End, U-Update, S-Start, TC-Traffic Class
Segment size for E, U and S congestion records is 208 bytes
* Max queue length during period of congestion
+ Period of congestion exceeded counter
-----
Type      Time                Interface  Congestion   Queue      Time of Max
          ago                (TC)      duration    length     Queue length
          (usecs)                (segments) relative to
          (usecs)                congestion
          start
          (usecs)
-----
Type      Time                Interface  Congestion   Queue      Time of Max
Fabric   ago                (TC)      duration    length     Queue length
Peer                                           (usecs)    (segments) relative to
                                           (usecs)                congestion
                                           (usecs)                start
                                           (usecs)
-----
```

```

-----
E 0:00:29.49376 ago      Et23/3 (1)      22388908      7879*      365268
U 0:00:31.83332 ago      Et23/3 (1)      N/A           7877       N/A
U 0:00:36.83288 ago      Et23/3 (1)      N/A           7877       N/A
U 0:00:41.83289 ago      Et23/3 (1)      N/A           7877       N/A
U 0:00:46.83289 ago      Et23/3 (1)      N/A           7877       N/A
U 0:00:51.83260 ago      Et23/3 (1)      N/A           7877       N/A
U 0:00:51.83760 ago      Et23/3 (1)      N/A           7877       N/A
U 0:00:51.84261 ago      Et23/3 (1)      N/A           7878       N/A
U 0:00:51.84762 ago      Et23/3 (1)      N/A           7877       N/A
U 0:00:51.85263 ago      Et23/3 (1)      N/A           7877       N/A
U 0:00:51.85763 ago      Et23/3 (1)      N/A           7877       N/A
U 0:00:51.86264 ago      Et23/3 (1)      N/A           7877       N/A
U 0:00:51.86765 ago      Et23/3 (1)      N/A           7878       N/A
U 0:00:51.87265 ago      Et23/3 (1)      N/A           7877       N/A
U 0:00:51.87766 ago      Et23/3 (1)      N/A           7877       N/A
S 0:00:51.88267 ago      Et23/3 (1)      N/A           1710       N/A
switch>

```

- This command displays the last 1000 records for Ethernet interface 24 on an Arad or Jericho platform switch in Polling Mode.

```

switch> show queue-monitor length Ethernet 24
Report generated at 2017-03-10 16:04:28
E-End, S-Start, P-Polling, TC-Traffic Class
* Max queue length during period of congestion
Type      Time              Intf(TC)      Queue
Length
(bytes)   Duration         Ingress
(µsecs)   Port-set
-----
P         0:00:04.81587 ago  Et24 (3)      36126720     4030092     Et1-24
switch>

```

- This command displays the last 1000 records for Ethernet interface 24 on an Arad or Jericho platform switch in Notifying Mode.

```

switch> show queue-monitor length Ethernet 24
Report generated at 2017-03-10 16:08:58
E-End, S-Start, P-Polling, TC-Traffic Class
* Max queue length during period of congestion
Type      Time              Intf(TC)      Queue
Length
(bytes)   Duration         Ingress
(µsecs)   Port-set
-----
E         0:00:03.11739 ago  Et24 (2)      36126720*    20700629     Et9-20,54/1-4
U         0:00:04.01513 ago  Et24 (2)      36126720     N/A          Et9-20,54/1-4
U         0:00:08.94918 ago  Et24 (2)      36126720     N/A          Et9-20,54/1-4
U         0:00:13.88323 ago  Et24 (2)      36126720     N/A          Et9-20,54/1-4
U         0:00:18.81728 ago  Et24 (2)      36126720     N/A          Et9-20,54/1-4
U         0:00:23.74758 ago  Et24 (2)      36126720     N/A          Et9-20,54/1-4
S         0:00:23.81802 ago  Et24 (2)      36126720     N/A          Et9-20,54/1-4
switch>

```

 **Note:** The non-sequential listing of ingress ports shown here is specific to Jericho switches; interfaces on Arad switches are always displayed sequentially.

19.2.4.22 show queue-monitor length global-buffer

The **show queue-monitor length global-buffer** command displays a report of recent high usage, low usage and update events for the global buffer. Newest events are listed first.

LANZ must be enabled to use this command (see [queue-monitor length \(global configuration mode\)](#)). If LANZ is disabled, the command displays “queue-monitor is disabled.”

Command Mode

EXEC

Command Syntax

```
show queue-monitor length global-buffer
```

Guidelines

This command is available on FM6000 platform switches.

Example

- This command displays the global buffer event records for the switch.

```
switch>show queue-monitor length global buffer
Report generated at 2013-04-01 14:30:07
GH-High, GU-Update, GL-Low
Segment size = 160 bytes
* Max buffer usage during period of congestion
-----
-
Type           Time                               Buffer      Congestion   Time of Max
                                              usage      duration     buffer usage
                                              (segments) (usecs)      relative to
                                              (segments) (usecs)      GH (usecs)
-----
-
GE 0:04:04.49547 ago          3121*      20786516     3418
GU 0:04:05.27967 ago          3120       N/A          N/A
GU 0:04:10.27968 ago          3120       N/A          N/A
GU 0:04:25.28163 ago          3118       N/A          N/A
GU 0:04:25.28173 ago          3118       N/A          N/A
GU 0:04:25.28182 ago          2963       N/A          N/A
GU 0:04:25.28192 ago          1916       N/A          N/A
GS 0:04:25.28201 ago          913        N/A          N/A
switch>
```

19.2.4.23 show queue-monitor length limit

The **show queue-monitor length limit** command displays a report of recent over-threshold events for a range of interfaces or for all interfaces, limited by a specified number of records.

LANZ must be enabled to use this command (see [queue-monitor length \(global configuration mode\)](#)). If LANZ is disabled, the command displays “queue-monitor is disabled.”

Command Mode

EXEC

Command Syntax

```
show queue-monitor length limit [INTERFACES] number
```

Parameters

- **INTERFACES** interface type and number for report. Values include:
 - *<no parameter>* displays information for all interfaces.
 - *ethernet e-range* e-range formats include a number, number range, or comma-delimited list of numbers and ranges
- *number* number of records to display. Values range from 1 to 1000000.

Example

This command displays the last 100 records for Ethernet interfaces 6 through 8.

```
switch>#show queue-monitor length ethernet 6-8 limit 100 samples
Report generated at 2010-01-01 12:56:13
Time                Interface      Queue length (segments, 1 to 512 bytes)
-----
0:00:07.43393 ago   Et6           1049
0:00:39.22856 ago   Et7           2039
1 day, 4:33:23.12345 ago Et6           1077
switch>
```

19.2.4.24 show queue-monitor length statistics

The **show queue-monitor length statistics** command displays LANZ statistics for all interfaces, showing the traffic class and number of recorded congestion events for each interface.

LANZ must be enabled to use this command (see [queue-monitor length \(global configuration mode\)](#)). If LANZ is disabled, the command displays “queue-monitor is disabled.”

Command Mode

EXEC

Command Syntax

show queue-monitor length statistics

Example

This command displays LANZ statistics for all interfaces on the switch.

```
switch> show queue-monitor length statistics

Report generated at 2016-02-09 22:59:56
Interface          Traffic Class  Count
-----
Et29                11             1
```

19.2.4.25 show queue-monitor length status

The **show queue-monitor length status** command displays the current LANZ configuration for the switch and for each interface. On certain platforms, the status of global buffer monitoring and per-linecard LANZ mode are displayed.

Command Mode

EXEC Global Configuration

Command Syntax

```
show queue-monitor length status
```

Guidelines

On FM6000 platform switches, this command includes status information about global buffer monitoring.

On Arad and Jericho based linecards, if LANZ is globally enabled (using the [queue-monitor length](#) command), the command displays the monitoring mode per-linecard.

On Arad and Jericho switches, even when all linecards are configured in Notifying Mode (using the [queue-monitor length notifying](#) command), some linecards may still run LANZ in Polling Mode under the following circumstances:

- On Arad-based linecards, LANZ falls back to Polling Mode when SSO redundancy mode is configured on the card (here, the mode is shown as “polling due to SSO configured”).
- On Jericho-based linecards, LANZ may run in Polling Mode when many features that use the switch’s statistic capabilities have been configured (here, the mode is shown as “polling due to counters exhausted”).

Examples

- This command displays the current LANZ configuration on an FM6000 device.

```
switch#show queue-monitor length status
queue-monitor length enabled
queue-monitor length packet sampling is disabled
queue-monitor length update interval in micro seconds: 5000000
Global Buffer Monitoring
-----
Global buffer monitoring is enabled
Segment size in bytes : 160
Total buffers in segments : 49152
High threshold : 16862
Low threshold : 6745

Per-Interface Queue Length Monitoring
-----
Queue length monitoring is enabled
Segment size in bytes : 480
Maximum queue length in segments : 5621
Port thresholds in segments:
Port      High threshold  Low threshold  Mirroring Enabled
Cpu              512            256             True
Et1              512            256             True
Et2              512            256             True
Et3              512            256             True
Et4              512            256             True
Et5              512            256             True
Et6              512            256             True
Et7              512            256             True

switch#
```

- This command displays the current LANZ configuration on a Trident II or Tomahawk device.

```
switch#show queue-monitor length status
queue-monitor length enabled
queue-monitor length packet sampling is disabled
queue-monitor length update interval in micro seconds: 5000000
Per-Interface Queue Length Monitoring
-----
Queue length monitoring is enabled
Segment size in bytes : 208
Maximum queue length in segments : 16382
Port thresholds in segments:
Port      High threshold  Low threshold
Cpu              512             256
Et1/1            512             256
Et1/2            512             256
Et1/3            512             256
Et1/4            512             256
Et2/1            512             256
Et2/2            512             256
Et2/3            512             256

switch#
```

- This command displays the current LANZ configuration on an Arad or Jericho device.

```
switch#show queue-monitor length status
queue-monitor length enabled
queue-monitor length packet sampling is disabled
queue-monitor length update interval in micro seconds: 5000000
Per-Interface Queue Length Monitoring
-----
Queue length monitoring is enabled
Queue length monitoring mode is notifying
Queue length monitoring status is:
Linecard3 polling due to SSO configured
Linecard4 polling due to SSO configured
Linecard5 polling due to SSO configured
Linecard6 polling due to SSO configured
Maximum queue length in bytes : 524288000
Port thresholds in bytes:
Port      High threshold  Low threshold  Warnings
Cpu              65536          32768
Et3/1/1          5242880        2621440
Et3/1/2          5242880        2621440
Et3/1/3          5242880        2621440
Et3/1/4          5242880        2621440
Et3/1/5          5242880        2621440
Et3/1/6          5242880        2621440
Et3/1/7          5242880        2621440
Et3/1/8          5242880        2621440
```

- This command displays the current LANZ configuration on an Arad or Jericho device with LANZ disabled globally. Per-linecard LANZ mode status is not displayed.

```
switch(config)#show queue-monitor length status
queue-monitor length disabled
queue-monitor length packet sampling is disabled
queue-monitor length update interval in micro seconds: 5000000
Per-Interface Queue Length Monitoring
-----
Queue length monitoring is disabled
Queue length monitoring mode is notifying
Maximum queue length in bytes : 524288000
Port thresholds in bytes:
Port      High threshold  Low threshold  Warnings
Cpu              65536          32768
Et3/1/1          5242880        2621440
Et3/1/2          5242880        2621440
Et3/1/3          5242880        2621440
Et3/1/4          5242880        2621440
Et3/1/5          5242880        2621440
Et3/1/6          5242880        2621440
Et3/1/7          5242880        2621440
Et3/1/8          5242880        2621440
```

19.2.4.26 show queue-monitor length tx-latency

The **show queue-monitor length tx-latency** command displays the latency data of recent LANZ events for a range of interfaces or for all interfaces. Output can be limited to a specified number of seconds or records. The most recent events are listed first. By default, the command displays data for all interfaces, limited to the last 1000 records. Newest events are listed first.

LANZ must be enabled to use this command (see [queue-monitor length \(global configuration mode\)](#)). If LANZ is disabled, the command displays “queue-monitor is disabled.”

Command Mode

EXEC

Command Syntax

```
show queue-monitor length [INTERFACES][FACTOR] tx-latency
```

Parameters

- **INTERFACES** interface type and number for report. Values include:
 - *<no parameter>* displays information for all interfaces.
 - **ethernet e-range** e-range formats include a number, number range, or comma-delimited list of numbers and ranges.
- **FACTOR** limiting parameter for report. Values include:
 - *<no parameter>* displays the last 1000 records.
 - **limit number samples** displays the last *number* records.
 - **limit number seconds** displays all records generated during the last *number* seconds.

Value of number ranges from 1 to 1000000.

Guidelines

This command is available on FM6000, Trident II, Trident 3, and Tomahawk platform switches.

Example

This command displays transmission latency data for the last 1000 LANZ events on the switch.

```
switch>show queue-monitor length tx-latency

Report generated at 2017-03-10 15:40:02
Time                Interface(TC)      Tx-Latency (usecs)
-----
0:02:29.99222 ago   Et23/3 (1)        724.868
0:02:32.33178 ago   Et23/3 (1)        724.684
0:02:37.33134 ago   Et23/3 (1)        724.684
0:02:42.33135 ago   Et23/3 (1)        724.684
0:02:47.33135 ago   Et23/3 (1)        724.684
0:02:52.33106 ago   Et23/3 (1)        730.985
switch>
```

19.2.4.27 show queue-monitor length

The **show queue-monitor length** command displays a report of recent over-threshold events for all interfaces, limited to the last 1000 records, with the newest events listed first.

LANZ must be enabled to use this command (see [queue-monitor length \(global configuration mode\)](#)). If LANZ is disabled, the command displays “queue-monitor is disabled.”

To limit the output to a specified number of seconds and/or records, use the [show queue-monitor length limit](#) command.

Command Mode

EXEC

Command Syntax

```
show queue-monitor length
```

Examples

- This command displays the last 1000 LANZ records on an Arad or Jericho platform switch in Polling Mode.

```
switch>show queue-monitor length
Report generated at 2017-03-10 16:04:28
E-End, S-Start, P-Polling, TC-Traffic Class
* Max queue length during period of congestion
Type          Time                Intf(TC)          Queue
Length        Duration          Ingress
(bytes)       (usecs)          Port-set
-----
P              0:00:04.81587 ago   Et15 (3)          36126720      4030092      Et1-24
switch>
```

- This command displays the last 1000 LANZ records on an Arad or Jericho platform switch in Notifying Mode.

```
switch>show queue-monitor length
Report generated at 2017-03-10 16:08:58
E-End, S-Start, P-Polling, TC-Traffic Class
* Max queue length during period of congestion
Type          Time                Intf(TC)          Queue
Length        Duration          Ingress
(bytes)       (usecs)          Port-set
-----
E              0:00:03.11739 ago   Et24 (2)          36126720*     20700629      Et9-20,54/1-4
U              0:00:04.01513 ago   Et24 (2)          36126720      N/A           Et9-20,54/1-4
U              0:00:08.94918 ago   Et24 (2)          36126720      N/A           Et9-20,54/1-4
U              0:00:13.88323 ago   Et24 (2)          36126720      N/A           Et9-20,54/1-4
U              0:00:18.81728 ago   Et24 (2)          36126720      N/A           Et9-20,54/1-4
U              0:00:23.74758 ago   Et24 (2)          36126720      N/A           Et9-20,54/1-4
S              0:00:23.81802 ago   Et24 (2)          36126720      N/A           Et9-20,54/1-4
switch>
```

- This command displays the last 1000 LANZ records on an FM6000, Trident II, Trident 3, or Tomahawk platform switch.

```
switch>show queue-monitor length
Report generated at 2017-03-10 14:57:12
E-End, U-Update, S-Start, TC-Traffic Class
Segment size for E, U and S congestion records is 208 bytes
* Max queue length during period of congestion
+ Period of congestion exceeded counter
Type          Time                Interface
(TC)          Congestion
duration     Queue
(usecs)      length
              (segments)
Time of Max   Fabric
Queue length  Peer
relative to   Peer
congestion   Peer
start        Peer
(uscs)       Peer
-----
E              0:08:04.45352 ago   Et23/3 (13)      22704753      5743*         0
```

```

U 0:08:07.10807 ago Et23/3 (13) N/A 5742 N/A
U 0:08:12.10808 ago Et23/3 (13) N/A 5742 N/A
U 0:08:17.10809 ago Et23/3 (13) N/A 5742 N/A
U 0:08:22.10810 ago Et23/3 (13) N/A 5742 N/A
U 0:08:27.10810 ago Et23/3 (13) N/A 5742 N/A
U 0:08:27.11311 ago Et23/3 (13) N/A 5741 N/A
U 0:08:27.11811 ago Et23/3 (13) N/A 5742 N/A
U 0:08:27.12312 ago Et23/3 (13) N/A 5742 N/A
U 0:08:27.12812 ago Et23/3 (13) N/A 5743 N/A
U 0:08:27.13315 ago Et23/3 (13) N/A 5743 N/A
U 0:08:27.13816 ago Et23/3 (13) N/A 5743 N/A
U 0:08:27.14319 ago Et23/3 (13) N/A 5742 N/A
U 0:08:27.14822 ago Et23/3 (13) N/A 5743 N/A
U 0:08:27.15322 ago Et23/3 (13) N/A 5742 N/A
S 0:08:27.15828 ago Et23/3 (13) N/A 2064 N/A
switch>

```

19.2.4.28 show queue-monitor streaming clients

The **show queue-monitor streaming clients** command displays the number of presently connected clients through LANZ streaming, and also displays their host-names. Ensure that both LANZ and LANZ streaming are enabled in order to use this command.

Command Mode

EXEC

Command Syntax

```
show queue-monitor streaming clients
```

Example

This command displays the number of clients connected to LANZ streaming.

```
switch#show queue-monitor streaming clients
Number of clients connected: 3
-----
172.20.63.161:6565
172.24.17.58:42
172.38.54.142:333
```

19.2.4.29 shutdown (queue-monitor-streaming configuration)

The **shutdown** command disables the streaming of LANZ data to external clients. The **no shutdown** command enables LANZ data streaming. Streaming is disabled by default.

Command Mode

Queue-Monitor-Streaming Configuration

Command Syntax

shutdown

no shutdown

Example

These commands enable the streaming of LANZ data on the switch.

```
switch(config)#queue-monitor streaming  
switch(config-qm-streaming)#no shutdown  
switch(config-qm-streaming)#
```

19.2.4.30 tcpdump queue-monitor

The `tcpdump queue-monitor` command exports congested traffic to a packet capture device or another tool for analysis, or directly to the switch CPU for inspection.

Command Mode

Global Configuration

Command Syntax

```
tcpdump queue-monitor
```

```
tcpdump queue-monitor [file | filecount | filter | lookup-names | max-file-size | packet-count | size | verbose]
```

Parameters

- *file* output file.
 - *certificate*: certificate file.
 - *file*: standard file.
 - *flash*: flash file.
 - *sslkey*: sslkey file.
 - *usb1*: usb1 file.
- *filecount* specify the number of output files: 1 to 100.
- *filter* set the filtering expression to select which packets will be dumped.
- *lookup-names* enable reverse DNS lookups.
- *max-file-size* specify the maximum file size by entering 1 to 100 million bytes.
- *packet-count* specify 1 to 10000 packets to capture.
- *size* specify the maximum number of bytes to dump per packet with a size of 1 to 65536 bytes.
- *verbose* enable verbose mode.

Example

This command inspects traffic on the switch.

```
switch(config)#tcpdump queue-monitor
tcpdump: WARNING: lanz: no IPv4 address assigned
tcpdump: verbose output suppressed, use -v or -vv for full protocol
decode
listening on lanz, link-type EN10MB (Ethernet), capture size 65535 bytes
...
0 packets captured
0 packets received by filter
0 packets dropped by kernel
switch(config)#
```

19.3 Sampled Flow Tracking

This chapter describes Arista's implementation of sampled flow tracking, including configuration instructions and command descriptions. Topics covered by this chapter include:

- [Sampled Flow Tracking Overview](#)
- [Configuring Sampled Flow Tracking](#)
- [Hardware Flow Tracking with IPFIX Export](#)
- [Sampled Flow Tracking Configuration Examples](#)
- [Sampled Flow Tracking Commands](#)

19.3.1 Sampled Flow Tracking Overview

Network administrators require access to flow information that passes through various network elements to analyze and monitor networks. Sampled flow tracking provides access to IP flow information by sampling traffic flows in ingress direction on the interfaces on which it is configured. The samples are then used to create flow records that are exported to the configured collectors in the Internet Protocol Flow Information Export (IPFIX) format.

Sampled flow tracking terminology:

- Flow tracker: It is a collection of interfaces that collect samples and create flow records. The flow tracker has one or more exporters.
- Exporter: It sends flow records to one or more collectors.
- Collector: It receives flow records from one or more exporters.
- Data record: It contains values of the parameters corresponding to a template record.
- Template record: It defines the structure and interpretation of fields in a data record. It is an ordered sequence of type and length pairs.
- Options template record: It is a type of template record that defines the structure and interpretation of fields in a data record, including how to scope the applicability of the data record.

Data records are created based on the following flow key fields: source IP address, destination IP address, IP protocol, source port, destination port, VRF, and VLAN. These records support IPv4 flow data record and IPv6 flow data record.

Sampled flow tracking supports the following options data records:

- VRF record: mapping of VRF ID to VRF name.
- Interface record: mapping of interface ID to interface name.
- Flow key indicator record: mapping of template ID to flow key indicator.
- Flow tracker record: contains information about configured flow tracker.

19.3.1.1 Sampled Flow Tracking Limitations

The limitations of Sampled flow tracking are:

- Sampled flow tracking is active only when sFlow is disabled on the device.
- Sampled flow tracking does not support export of IPFIX messages over ECMP paths.
- Sampled flow tracking route simulation is not supported for ECMP paths.

19.3.2 Configuring Sampled Flow Tracking

These sections describe sampled flow tracking configurations.

Configuring Sampled Flow Tracking

Use the `flow tracker sampled` command to enable sampled flow tracking on a tracker. Each tracker should have a minimum of one exporter configured.

Example

This command enables sampled flow tracking on an interface Eth1 and the flow tracker ftr1.

```
switch(config)# interface Eth1
switch(config-if-Et1)# flow tracker sampled ftr1
```

Use the `sample` command to enable the sample rate for a specific sampled flow tracker. The default sample rate is 1048576.

Example

These commands configure a sample rate of 1024 for the sampled flow tracker.

```
switch(config)#flow tracking sampled
switch(config-flow-tracking-sampled)#sample 1024
```

19.3.2.1 Configuring the Sampled Flow Tracker

Use the `tracker` command to configure a sampled flow tracker for a device.

Example

This command configures a sampled flow tracker named `ftr1`.

```
switch(config)#flow tracking sampled
switch(config-flow-tracking-sampled)# tracker ftr1
```

Use the `record export on interval` command to configure the interval at which active flow records are exported. The default interval is 300000 milliseconds.

Example

These commands configure an active record interval of 7000 for the exporter `exp1`.

```
switch(config)#flow tracking sampled
switch(config-flow-tracking-sampled)#tracker ftr1
switch(config-ftr-sampled-tr-ftr1)#exporter exp1
switch(config-ftr-sampled-tr-ftr1-exp-exp1)#record export on interval
7000
```

Use the `record export on inactive timeout` command to configure the interval at which timed-out inactive flow records are exported. The default interval is 15000 milliseconds.

These commands configure an inactive record interval of 4000 for the exporter `exp1`.

```
switch(config)#flow tracking sampled
switch(config-flow-tracking-sampled)#tracker ftr1
switch(config-ftr-sampled-tr-ftr1)#exporter exp1
switch(config-ftr-sampled-tr-ftr1-exp-exp1)#record export on inactive
timeout
4000
```

19.3.2.2 Configuring Exporter for Sampled Flow Tracker

Use the `exporter` command to configure or unconfigure an exporter for a specific tracker.

Example

This command configures exporter `exp1` for the specific tracker `ftr1`.

```
switch(config)#flow tracking sampled
switch(config-flow-tracking-sampled)# tracker ftr1
switch(config-ftr-sampled-tr-ftr1)# exporter exp1
```

Use the `collector` command to configure the collector for the specific exporter.

Example

These commands configure a collector for the IPv4 address 192.0.2.0 and collector port number 10.

```
switch(config)#flow tracking sampled
switch(config-flow-tracking-sampled)#tracker ftr1
switch(config-ftr-sampled-tr-ftr1)#exporter exp1
```

```
switch(config-ftr-sampled-tr-ftrl-exp-exp1)#collector 192.0.2.0 port 10
```

Use the `local interface` command to configure the local source interface for the specific exporter.

Example

These commands configure the local source interface Ethernet1 for the exporter exp1.

```
switch(config)#flow tracking sampled
switch(config-flow-tracking-sampled)#tracker ftrl
switch(config-ftr-sampled-tr-ftrl)#exporter exp1
switch(config-ftr-sampled-tr-ftrl-exp-exp1)#local interface Ethernet1
```

Use the `dscp` command to configure the DSCP value for the specific exporter. The default DSCP value is 0.

Example

These commands configure a DSCP value of 10 for the exporter exp1.

```
switch(config)#flow tracking sampled
switch(config-flow-tracking-sampled)#tracker ftrl
switch(config-ftr-sampled-tr-ftrl)#exporter exp1
switch(config-ftr-sampled-tr-ftrl-exp-exp1)#dscp 10
```

Use the `format ipfix version` command to configure the IPFIX version and maximum packet size for the specific exporter. The default IPFIX version is 10 and the default maximum packet size is 9152.

Example

These commands configure an IPFIX version of 10 and a maximum packet size of 854 for the exporter exp1.

```
switch(config)#flow tracking sampled
switch(config-flow-tracking-sampled)#tracker ftrl
switch(config-ftr-sampled-tr-ftrl)#exporter exp1
switch(config-ftr-sampled-tr-ftrl-exp-exp1)#format ipfix version 10
max-packet-size 854
```

Use the `template interval` command to configure the interval at which templates are exported for the specific exporter. The default template interval is 3600000 milliseconds.

Example

This command configures the interval of 3400000 milliseconds for the exporter exp1.

```
switch(config-ftr-sampled-tr-exp-ftrl-exp1)# template interval 3400000
```

19.3.3 Hardware Flow Tracking with IPFIX Export

Hardware flow tracking uses match criteria to collect data from packets based on defined flow profiles. The data collected is sent to an external node called Collector using IPFIX flow export protocol. The flow tracking engine tracks up to 32K flows going through a given set of ports in a switch with IPFIX-capability. Flow tracking is configured on physical interfaces or LAG interfaces. The matching fields in the packet header are:

- IP source
- IP destination
- IP protocol

- IP protocol's source port
- IP protocol's destination port

The information collected is:

- Byte count (4 bytes)
- Packet count (4 bytes)
- New-learn timestamp
- Flow start timestamp
- Flow end timestamp

Platform Compatibility:

Hardware flow-tracking is currently supported on CCS-720XP.

Configuring Hardware Flow-tracking

This file extract show a hardware flow-tracking configuration.

```
! Define a loopback interface to act as the local source interface for
! IPFIX export
int Loopback0
 ip address 1.2.3.4/32

@ Enable IP routing for IPFIX packet to be routed to the collector
ip routing

! The flow tracker definition
flow tracking hardware
 tracker myFtr
   record export on inactive timeout 60000
   record export on interval 30000
   !
   exporter myExporter
     local interface Loopback0
     template interval 5000
     collector 172.28.130.153
 no shutdown

! Flow tracked interface/port
int Ethernet48
 flow tracker hardware myFtr
 no shutdown
```

This command shows general information about hardware flow tracking.

```
switch#show flow tracking hardware
Flow Tracking Status
Type: Hardware
Running: yes
Tracker: myFtr
  Active interval: 30000ms
  Inactive timeout: 60000ms
  Groups: IPv4, IPv6, VxlanIPv4, VxlanIPv6
  Exporter: myExpoter
    VRF: default
    Local interface: Loopback0 (1.2.3.4)
    Export format: IPFIX version 10, MTU 1500
    DSCP: 0
    Template interval: 5000ms
  Collectors:
```

```
172.28.130.153 port 4739
Active interfaces:
Et48
```

This command shows hardware flow tracking IPFIX template.

```
switch# show flow tracking hardware ipfix template
Tracker: myFtr
  Data Template, Group: IPv4, Fields: 16, Template ID: 263
    paddingOctets (210), 4 bytes
    aristaBscanExportReason[E] (1036), 2 bytes
    paddingOctets (210), 38 bytes
    destinationTransportPort (11), 2 bytes
    sourceTransportPort (7), 2 bytes
    protocolIdentifier (4), 1 bytes
    destinationIPv4Address (12), 4 bytes
    sourceIPv4Address (8), 4 bytes
    ingressVRFID (234), 2 bytes
    paddingOctets (210), 1 bytes
    aristaBscanTsNewLearn[E] (1040), 6 bytes
    aristaBscanTsFlowStart[E] (1038), 6 bytes
    aristaBscanTsFlowEnd[E] (1039), 6 bytes
    octetDeltaCount (1), 4 bytes
    packetDeltaCount (2), 4 bytes
    paddingOctets (210), 38 bytes

  Data Template, Group: IPv6, Fields: 17, Template ID: 264
    paddingOctets (210), 4 bytes
    aristaBscanExportReason[E] (1036), 2 bytes
    paddingOctets (210), 9 bytes
    sourceIPv6Address (27), 16 bytes
    paddingOctets (210), 5 bytes
    destinationTransportPort (11), 2 bytes
    sourceTransportPort (7), 2 bytes
    protocolIdentifier (4), 1 bytes
    ingressVRFID (234), 2 bytes
    destinationIPv6Address (28), 16 bytes
    paddingOctets (210), 1 bytes
    aristaBscanTsNewLearn[E] (1040), 6 bytes
    aristaBscanTsFlowStart[E] (1038), 6 bytes
    aristaBscanTsFlowEnd[E] (1039), 6 bytes
    octetDeltaCount (1), 4 bytes
    packetDeltaCount (2), 4 bytes
    paddingOctets (210), 38 bytes

  Data Template, Group: VxlanIPv4, Fields: 16, Template ID: 265
    paddingOctets (210), 4 bytes
    aristaBscanExportReason[E] (1036), 2 bytes
    paddingOctets (210), 38 bytes
    destinationTransportPort (11), 2 bytes
    sourceTransportPort (7), 2 bytes
    protocolIdentifier (4), 1 bytes
    destinationIPv4Address (12), 4 bytes
    sourceIPv4Address (8), 4 bytes
    ingressVRFID (234), 2 bytes
    paddingOctets (210), 1 bytes
    aristaBscanTsNewLearn[E] (1040), 6 bytes
    aristaBscanTsFlowStart[E] (1038), 6 bytes
    aristaBscanTsFlowEnd[E] (1039), 6 bytes
    octetDeltaCount (1), 4 bytes
```

```
packetDeltaCount (2), 4 bytes
paddingOctets (210), 38 bytes
```

Data Template, Group: VxlanIPv6, Fields: 17, Template ID: 266

```
paddingOctets (210), 4 bytes
aristaBscanExportReason[E] (1036), 2 bytes
paddingOctets (210), 9 bytes
sourceIPv6Address (27), 16 bytes
paddingOctets (210), 5 bytes
destinationTransportPort (11), 2 bytes
sourceTransportPort (7), 2 bytes
protocolIdentifier (4), 1 bytes
ingressVRFID (234), 2 bytes
destinationIPv6Address (28), 16 bytes
paddingOctets (210), 1 bytes
aristaBscanTsNewLearn[E] (1040), 6 bytes
aristaBscanTsFlowStart[E] (1038), 6 bytes
aristaBscanTsFlowEnd[E] (1039), 6 bytes
octetDeltaCount (1), 4 bytes
packetDeltaCount (2), 4 bytes
paddingOctets (210), 38 bytes
```

Options Template, VRF Mapping, Template ID: 256

```
ingressVRFID (234), 4 bytes
VRFname (236), variable length
```

Options Template, Interface Mapping, Template ID: 257

```
ingressInterface (10), 4 bytes
interfaceName (82), variable length
```

Options Template, Flow Key, Template ID: 258

```
templateId (145), 2 bytes
flowKeyIndicator (173), 8 bytes
```

Options Template, Tracker, Template ID: 259

```
observationDomainId (149), 4 bytes
observationDomainName (300), variable length
flowActiveTimeout (36), 2 bytes
flowIdleTimeout (37), 2 bytes
selectorAlgorithm (304), 2 bytes
samplingSize (309), 4 bytes
samplingPopulation (310), 4 bytes
flowTrackingType (1001), 2 bytes
```

This command shows hardware flow tracking IPFIX template option-table.

```
switch# show flow tracking hardware ipfix options-table
```

```
Tracker: myFtr
  Observation domain: myFtr, ID: 1
  Active interval: 5sec
  Inactive timeout: 60sec
  Selector algorithm: random(3)
  Sampling: 1/1
  Flow tracking type: hardware(2)
```

VRF Table, Template ID: 256, Scope: ingressVRFID

VRF ID	VRF Name
0	default
1	vrf1

```

2          vrf2
3          fake-management
4          vrf500
16777215

```

Interface Table, Template ID: 257, Scope: ingressInterface

Interface ID	Interface Name
0	unknown
1	Ethernet1
2	Ethernet2
3	Ethernet3
4	Ethernet4
5	Ethernet5
6	Ethernet6
7	Ethernet7
8	Ethernet8
9	Ethernet9
10	Ethernet10
11	Ethernet11
12	Ethernet12
13	Ethernet13
14	Ethernet14
15	Ethernet15
16	Ethernet16
17	Ethernet17
18	Ethernet18
19	Ethernet19
20	Ethernet20
21	Ethernet21
22	Ethernet22
23	Ethernet23
24	Ethernet24
25	Ethernet25
26	Ethernet26
27	Ethernet27
28	Ethernet28
29	Ethernet29
30	Ethernet30
31	Ethernet31
32	Ethernet32
33	Ethernet33
34	Ethernet34
35	Ethernet35
36	Ethernet36
37	Ethernet37
38	Ethernet38
39	Ethernet39
40	Ethernet40
41	Ethernet41
42	Ethernet42
43	Ethernet43
44	Ethernet44
45	Ethernet45
46	Ethernet46
47	Ethernet47
48	Ethernet48
49	Ethernet49
50	Ethernet50
51	Ethernet51
52	Ethernet52
53001	Ethernet53/1
53002	Ethernet53/2
53003	Ethernet53/3

```

53004      Ethernet53/4
54001      Ethernet54/1
54002      Ethernet54/2
54003      Ethernet54/3
54004      Ethernet54/4
999001     Management1
2000002    Vlan2
2000048    Vlan48
2000049    Vlan49
2000100    Vlan100
7000000    Vxlan1
1073741823 CPU
1073741824 discard
2147483648 multicast

```

Flow Keys Table, Template ID: 258, Scope: templateId

Template ID	Flow Key Indicator
263	0x1f8
264	0x3e8
265	0x1f8
266	0x3e8

19.3.4 Sampled Flow Tracking Configuration Examples

This section describes the command configurations required to configure sampled flow tracking.

19.3.4.1 Sampled Flow Tracking Basic Configuration

The following commands enable a basic configuration.

1. Enable configuration mode for the sampled flow tracking on a device.

```
switch(config)#flow tracking sampled
```

2. Configure a sampled flow tracker for a device.

```
switch(config-flow-tracking-sampled)# tracker ftr1
```

3. Configure an exporter for the specific tracker.

```
switch(config-ftr-sampled-tr-ftr1)# exporter exp1
```

4. Configure the collector for the specific exporter.

```
switch(config-ftr-sampled-tr-ftr1-exp-exp1)#collector 172.31.22.131
```

5. Configure the local source interface Ethernet1 for the specific exporter.

```
switch(config-ftr-sampled-tr-ftr1-exp-exp1)#local interface Ethernet1
```

6. Enable sampled flow tracking.

```
switch(config-ftr-sampled-tr-ftr1-exp-exp1)#no shutdown
```

7. Configure the interface Ethernet2 for the specific exporter.

```
switch(config)#interface Ethernet2
```

8. Configure the sampled flow tracker on the interface Ethernet2.

```
switch(config)#interface Ethernet2  
switch(config-if-Et2)# flow tracker sampled ftr1
```

19.3.5 Sampled Flow Tracking Commands

This section contains descriptions of Sampled flow tracking commands.

Configuration Commands

- [collector](#)
- [dscp](#)
- [exporter](#)
- [flow tracking sampled](#)
- [format ipfix version](#)
- [local interface](#)
- [record export on inactive timeout](#)
- [record export on interval](#)
- [sample](#)
- [shutdown \(sampled flow tracking\)](#)
- [template interval](#)
- [tracker](#)

Interface Configuration Command

- [flow tracker sampled](#)

Privileged EXEC Command

- [clear flow tracking sampled counters](#)

Sampled Flow Tracking Display Commands

- [show flow tracking sampled](#)
- [show flow tracking sampled counters](#)
- [show flow tracking sampled flow-table](#)
- [show flow tracking sampled ipfix options-table](#)
- [show flow tracking sampled ipfix template](#)

19.3.5.1 clear flow tracking sampled counters

The **clear flow tracking sampled counters** command clears the flow tracking counters for all trackers, a specified tracker, or a specified tracker and exporter.

Command Mode

Privileged EXEC

Command Syntax

```
clear flow tracking sampled counters [ tracker tracker_name [ exporter exporter_name ]]
```

Parameters

- tracker *tracker_name* Specifies the flow tracker.
- exporter *exporter_name* Specifies the exporter.

Example

- This command clears the flow counters for the tracker *ft1* and exporter *exp1*.

```
switch#clear flow tracking sampled counters tracker ft1 exporter exp1  
switch#
```

19.3.5.2 collector

The **collector** command configures a collector to receive flow records from a specified exporter.

The **no collector** and **default collector** commands remove the configured collector from *running-config*.

Command Mode

Sampled Flow Tracking Exporter Configuration

Command Syntax

```
collector { ipv4_address | ipv6_address } [ port port_number ]
```

```
no collector { ipv4_address | ipv6_address } [ port port_number ]
```

```
default collector { ipv4_address | ipv6_address } [ port port_number ]
```

Parameters

- *ipv4_address* Specifies the IPv4 address of the collector.
- *ipv6_address* Specifies the IPv6 address of the collector.
- **port port_number** Specifies the port number for the collector. Values range from 1 to 65535. The default value is 4739.

Example

- These commands configure a collector for the IPv4 address 192.0.2.0 and collector port number 10.

```
switch(config)#flow tracking sampled
switch(config-flow-tracking-sampled)#tracker ftr1
switch(config-ftr-sampled-tr-ftr1)#exporter exp1
switch(config-ftr-sampled-tr-ftr1-exp-exp1)#collector 192.0.2.0 port 10
switch(config-ftr-sampled-tr-ftr1-exp-exp1)#exit
switch(config-ftr-sampled-tr-ftr1)#exit
switch(config-flow-tracking-sampled)#exit
switch(config)#
```

19.3.5.3 dscp

The **dscp** command configures the Differentiated Services Code Point (DSCP) value for a specific exporter.

The **no dscp** and **default dscp** commands reset the DSCP value to the default of 0.

Command Mode

Sampled Flow Tracking Exporter Configuration

Command Syntax

dscp *dscp_value*

no dscp *dscp_value*

default dscp *dscp_value*

Parameters

- *dscp_value* the DSCP value assigned to the exporter. Value ranges from 0 to 63. Default value is 0.

Example

- These commands configure a DSCP value of 10 for the exporter *exp1*.

```
switch(config)#flow tracking sampled
switch(config-flow-tracking-sampled)#tracker ftr1
switch(config-ftr-sampled-tr-ftr1)#exporter exp1
switch(config-ftr-sampled-tr-ftr1-exp-exp1)#dscp 10
switch(config-ftr-sampled-tr-ftr1-exp-exp1)#exit
switch(config-ftr-sampled-tr-ftr1)#exit
switch(config-flow-tracking-sampled)#exit
switch(config)#
```

19.3.5.4 exporter

The **exporter** command places the switch in sampled flow tracking exporter configuration mode for the specified exporter and creates the exporter if it does not yet exist.

The **no exporter** and **default exporter** commands remove the specific exporter from *running-config*.

Command Mode

Sampled Flow Tracking Tracker Configuration

Command Syntax

exporter *exporter_name*

no exporter *exporter_name*

default exporter *exporter_name*

Parameters

- *exporter_name* the name of the exporter.

Example

- These commands create exporter exp1 for the flow tracker ftr1 and place the switch in configuration mode for that exporter.

```
switch(config)#flow tracking sampled
switch(config-flow-tracking-sampled)#tracker ftr1
switch(config-ftr-sampled-tr-ftr1)#exporter exp1
switch(config-ftr-sampled-tr-ftr1-exp-exp1)#
```

19.3.5.5 flow tracker sampled

The **flow tracker sampled** command configures an interface to be part of a flow tracker. An interface can belong to only one flow tracker.

The **no flow tracker sampled** and **default flow tracker sampled** commands remove the specified interface from the specified tracker.

Command Mode

Interface-Ethernet Configuration

Command Syntax

```
flow tracker sampled tracker_name
```

```
no flow tracker sampled tracker_name
```

```
default flow tracker sampled tracker_name
```

Parameters

- *tracker_name* the name of the flow tracker to which the interface is to be added.

Example

- This command configures Ethernet interface 1 to participate in the flow tracker *ftr1*.

```
switch(config)# interface ethernet 1
switch(config-if-Et1)# flow tracker sampled ftr1
switch(config-if-Et1)#
```

19.3.5.6 flow tracking sampled

The **flow tracking sampled** command places the switch in sampled flow tracking configuration mode. Sampled flow tracking configuration mode is a group-change mode; changes made in a group-change mode are saved by exiting the mode.

The **no flow tracking sampled** and **default flow tracking sampled** commands remove all sampled flow tracking configuration from *running-config*.

Command Mode

Global Configuration

Command Syntax

```
flow tracking sampled
```

```
no flow tracking sampled
```

```
default flow tracking sampled
```

Commands Available in Sampled Flow Tracking Configuration Mode

- **abort** exits mode without saving changes
- **exit** exits mode and saved changes
- **sample** configures sample parameters
- **shutdown (sampled flow tracking)** enables or disables sampled flow tracking
- **tracker** configures a flow tracker

Example

- This command places the switch in sampled flow tracking configuration mode.

```
switch(config)# flow tracking sampled  
switch(config-flow-tracking-sampled)#
```

19.3.5.7 format ipfix version

The **format ipfix version** command configures the IPFIX version and maximum packet size for a specific exporter.

The **no format ipfix version** and **default format ipfix version** commands remove the previously configured IPFIX version and the maximum packet size value from **running-config**.

Command Mode

Sampled Flow Tracking Configuration

Command Syntax

```
format ipfix version ipfix_version [ max-packet-size max-packet-size value ]
```

```
no format ipfix version ipfix_version [ max-packet-size ]
```

```
default format ipfix version ipfix_version [ max-packet-size ]
```

Parameters

- *ipfix_version* the IPFIX version. Default value is 10.
- max-packet-size *max-packet-size value* the IPFIX maximum packet size. Value ranges from 512 to 65472. Default value is 9152.

Example

- These commands configure an IPFIX version of 10 and a maximum packet size of 854 for the exporter *exp1*.

```
switch(config)# flow tracking sampled
switch(config-flow-tracking-sampled)# tracker ftr1
switch(config-ftr-sampled-tr-ftr1)# exporter exp1
switch(config-ftr-sampled-tr-ftr1-exp-exp1)# format ipfix version 10
max-packet-size 854
```

19.3.5.8 local interface

The **local interface** command configures the local source interface for the specific exporter.

The **no local interface** and **default local interface** commands remove the local interface for the specific exporter from *running-config*.

Command Mode

Sampled Flow Tracking Configuration

Command Syntax

local interface *interface*

no local interface

default local interface

Parameters

- *interface* Interface type and numbers. Options include:
 - Ethernet *eth_num* displays the information of the specified Ethernet interface. The value ranges from 1 to 64.
 - Loopback *lb_num* displays the information of the specified loop back interface. The value ranges from 0 to 2100.
 - Management *m_num* displays the information of the specified Management interface. The management port number ranges from 1 to 2.
 - Port-Channel *pc_num* displays the interface or sub-interface information of the specified port channel. The interface and sub-interface values of port channel ranges from <1-1000>and <1-2000>.<1-4094> respectively.
 - Tunnel *t_num* displays the information of the specified tunnel. The value ranges from 0 to 255.
 - Vlan *vlan_num* displays the information of the specified VLAN interface. The value ranges from 1 to 4094.

Example

- These commands configure the local source interface Ethernet1 for the exporter *exp1*.

```
switch(config)# flow tracking sampled
switch(config-flow-tracking-sampled)# tracker ftr1
switch(config-ftr-sampled-tr-ftr1)# exporter exp1
switch(config-ftr-sampled-tr-ftr1-exp-exp1)# local interface Ethernet1
```

19.3.5.9 record export on inactive timeout

The `record export on inactive timeout` command configures the interval at which inactive flow records time out and are exported for a flow tracker.

The `no record export on inactive timeout` and `default record export on inactive timeout` commands remove the timeout interval from *running-config*.

Command Mode

Sampled Flow Tracking Configuration

Command Syntax

```
record export on inactive timeout timeout_value
```

```
no record export on inactive timeout
```

```
default record export on inactive timeout
```

Parameters

- *timeout_value* the flow record inactive export timeout value in milliseconds. Value ranges from 3000 to 900000. The default value is 15000 milliseconds.

Example

- These commands configure an inactive record interval of 6000 for the exporter exp1.

```
switch(config)# flow tracking sampled
switch(config-flow-tracking-sampled)# tracker ftr1
switch(config-ftr-sampled-tr-ftr1)# exporter exp1
switch(config-ftr-sampled-tr-ftr1-exp-exp1)# record export on inactive
timeout
6000
```

19.3.5.10 record export on interval

The **record export on interval** command configures the interval at which active flow records are exported for a flow tracker.

The **no record export on interval** and **default record export on interval** commands remove the interval from *running-config*.

Command Mode

Sampled Flow Tracking Configuration

Command Syntax

```
record export on interval interval_value
```

```
no record export on interval
```

```
default record export on interval
```

Parameters

- *interval_value* the flow record export interval in milliseconds. Value ranges from 5000 to 36000000. The default value is 300000 milliseconds.

Example

- These commands configure an active record interval of 9000 for the exporter *exp1*.

```
switch(config)# flow tracking sampled
switch(config-flow-tracking-sampled)# tracker ftr1
switch(config-ftr-sampled-tr-ftr1)# exporter exp1
switch(config-ftr-sampled-tr-ftr1-exp-exp1)# record export on interval
9000
```

19.3.5.11 sample

The **sample** command enables the sample rate for a specific sampled flow tracker.

The **no sample** and **default sample** commands remove the sample rate configured for a specific sampled flow tracker from *running-config*.

Command Mode

Sampled Flow Configuration

Command Syntax

```
sample sample_rate
```

```
no sample
```

```
default sample
```

Parameters

- *sample_rate* the sample flow tracking rate to be assigned for a sampled flow tracker. Value ranges from 1024 to 16777216. Default value is 1048576.

Example

- These commands configure a sample rate of 2056 for the sampled flow tracker.

```
switch(config)# flow tracking sampled  
switch(config-flow-tracking-sampled)# sample 2056
```

19.3.5.12 show flow tracking sampled counters

The **show flow tracking sampled counters** command displays information about the flow tracking counters of a specific tracker and the counters of a specified exporter within that tracker.

Command Mode

EXEC

Command Syntax

```
show flow tracking sampled counters [ tracker tracker_name [ exporter exporter_name ]]
```

Parameters

- tracker *tracker_name* the specific flow tracker.
- exporter *exporter_name* the specific exporter within the tracker.

Examples

- This command displays the flow tracking counter information of the tracker ftr1 and the exporter exp1.

```
switch# show flow tracking sampled counters tracker ftr1 exporter exp1

Tracker: ftr1
  1 flows, 22 RX packets
  Flows created: 1, expired: 0
  Group: IPv4
  1 flows, 22 RX packets
  Group: IPv6
  0 flows, 0 RX packets
  Exporter: exp1 (IPFIX)
  Collector: 172.31.24.133 port 4739
  52 messages, last sent 0:00:27 ago
  0 flow records
  2350 options data records, last sent 0:00:27 ago
  6 templates, last sent 0:12:27 ago
  Collector: 172.31.22.131 port 4739
  52 messages, last sent 0:00:27 ago
  0 flow records
  2350 options data records, last sent 0:00:27 ago
  6 templates, last sent 0:12:27 ago
```

19.3.5.13 show flow tracking sampled flow-table

The **show flow tracking sampled flow-table** command displays information about the active flows maintained in the EOS.

Command Mode

EXEC

Command Syntax

```
show flow tracking sampled flow-table [ detail | dst-ip | dst-port | group | interface | protocol
| src-ip | src-port | tracker | vlan | vrf ]
```

Parameters

- detail displays detailed flow records.
- dst-ip displays flow records based on destination IPv4 or IPv6 address.
- dst-port displays flow records based on a specified destination port.
- group displays flow records based on IPv4 or IPv6 flow groups.
- interface displays flow records based on ingress interface.
- protocol displays flow records based on the flow IP protocol.
- src-ip displays flow records based on source IPv4 or IPv6 address.
- src-port displays flow records based on a specified source port.
- tracker displays flow records based on flow tracker.
- vlan displays flow records based on a specified flow VLAN ID.
- vrf displays flow records based on flow VRF.

Examples

- This command displays information about the active flows on the device.

```
switch# show flow tracking sampled flow-table
Tracker: ftr1, Flows: 1
Group: IPv4, Flows: 1
VRF VLAN Source Destination Protocol Start Time Pkts Bytes
-----
red 42 10.10.1.1:0 10.20.1.2:0 UDP 2019-04-18 15:06:50 7 700
```

- This command displays detailed information about the active flows on the device.

```
switch# show flow tracking sampled flow-table detail
Tracker: ftr1, Flows: 1
Group: IPv4, Flows: 1
Flow: UDP 10.10.1.1:0 - 10.20.1.2:0, VRF: red, VLAN: 42
Start time: 2019-04-18 15:06:50.268734, Last packet time: 2019-04-18
15:07:03.607900
Packets: 15, Bytes: 1500, TOS: 0, TCP flags: none
Source MAC: 001c.73ee.bfe4, Destination MAC: 001c.7374.3b85
Ingress Interface: 'Ethernet1', Egress VLAN: routed, Egress
Interface: CPU
Next hop: unknown, BGP next hop: unknown (AS unknown), Source AS:
unknown
Source prefix length: 24, Destination prefix length: 32
```

19.3.5.14 show flow tracking sampled ipfix options-table

The **show flow tracking sampled ipfix options-table** command displays information about the sampled IPFIX options table available.

Command Mode

EXEC

Command Syntax

```
show flow tracking sampled ipfix options-table tracker [ flow-key | flow-tracker | interface | vrf ]
```

Parameters

- tracker displays the output for a specific flow tracker.
- flow-key displays the flow keys options table.
- flow-tracker displays the flow tracker options table.
- interface displays the interface options table.
- vrf displays the VRF options table.

Examples

- This command displays the sampled IPFIX options table for the tracker *ftr1*.

```
switch# show flow tracking sampled ipfix options-table
Tracker: ftr1
  Observation domain: ftr1, ID: 1
  Active interval: 30sec
  Inactive timeout: 120sec
  Selector algorithm: random(3)
  Sampling: 1/1024
  Flow tracking type: sampled(1)
  VRF Table, Template ID: 256, Scope: ingressVRFID
  VRF ID VRF Name
  -----
  0 default
  1 red
  16777215
  Interface Table, Template ID: 257, Scope: ingressInterface
  Interface ID Interface Name
  -----
  0 unknown
  3013 Ethernet1
  3014 Ethernet2

  1073741823 CPU
  1073741824 discard
  1074029945 Ethernet3/36/1.1
  1074292089 Ethernet3/36/1.2
  2147483648 multicast
  Flow Keys Table, Template ID: 258, Scope: templateId
  Template ID Flow Key Indicator
  -----
  261 0x7f
  262 0x7f
```

19.3.5.15 show flow tracking sampled ipfix template

The **show flow tracking sampled ipfix template** command displays information about the exported IPFIX data templates and options templates.

Command Mode

EXEC

Command Syntax

```
show flow tracking sampled ipfix template [ data | options | tracker ]
```

Parameters

- data displays the data templates.
- options displays the flow options template.
- tracker displays the flow tracker template.

Example

- This command displays the sampled IPFIX options table for the tracker *ftr1*.

```
switch# show flow tracking sampled ipfix template
Tracker: ftr1
  Data Template, Group: IPv4, Fields: 26, Template ID: 261
    ingressVRFID (234), 4 bytes
    vlanId (58), 2 bytes
    sourceIPv4Address (8), 4 bytes
    destinationIPv4Address (12), 4 bytes
    protocolIdentifier (4), 1 bytes
    sourceTransportPort (7), 2 bytes
    destinationTransportPort (11), 2 bytes
    sourceMacAddress (56), 6 bytes
    postDestinationMacAddress (57), 6 bytes
    octetDeltaCount (1), 8 bytes
    packetDeltaCount (2), 8 bytes
    flowStartMilliseconds (152), 8 bytes
    flowEndMilliseconds (153), 8 bytes
    flowEndReason (136), 1 bytes
    tcpControlBits (6), 2 bytes
    ingressInterfaceType (368), 4 bytes
    ingressInterface (10), 4 bytes
    postVlanId (59), 2 bytes
    egressInterface (14), 4 bytes
    ipClassOfService (5), 1 bytes
    bgpSourceAsNumber (16), 4 bytes
    bgpDestinationAsNumber (17), 4 bytes
    bgpNextHopIPv4Address (18), 4 bytes
    ipNextHopIPv4Address (15), 4 bytes
    sourceIPv4PrefixLength (9), 1 bytes
    destinationIPv4PrefixLength (13), 1 bytes

<-----OUTPUT OMITTED FROM EXAMPLE----->
```

19.3.5.16 show flow tracking sampled

The **show flow tracking sampled tracker** command displays information about the status of a specific tracker and the status of a specified exporter within that tracker. If no tracker is specified in the command, then all information about all trackers is displayed.

Command Mode

EXEC

Command Syntax

```
show flow tracking sampled [ tracker tracker_name [ exporter exporter_name ]]
```

Parameters

- tracker *tracker_name* the specific flow tracker.
- exporter *exporter_name* the specific exporter within the tracker.

Examples

- This command displays the status information of the tracker ftr1 and the exporter exp1.

```
switch# show flow tracking sampled tracker ftr1 exporter exp1
Flow tracking status
Type: Sampled
Running: yes
Sample rate: 1024
Tracker: ftr1
Active interval: 30000ms
Inactive timeout: 120000ms
Groups: IPv4, IPv6
Exporter: exp1
VRF: default
Local interface: Management1 (172.30.150.179)
Export format: IPFIX version 10, MTU 1500
DSCP: 48
Template interval: 3600000ms
Collectors:
172.31.22.131 port 4739
Active interfaces:
Et1
```

19.3.5.17 shutdown (sampled flow tracking)

The **shutdown** command disables sampled flow tracking for the specific exporter.

The **no shutdown** command enables sampled flow tracking for the specific exporter.

Command Mode

Sampled Flow Tracking Configuration

Command Syntax

shutdown

no shutdown

default shutdown

Example

- These commands enable sampled flow tracking for the specific exporter *exp1*.

```
switch(config)# flow tracking sampled
switch(config-flow-tracking-sampled)# tracker ftr1
switch(config-flow-tracking-sampled)# tracker ftr1
switch(config-ftr-sampled-tr-ftr1)# exporter exp1
switch(config-ftr-sampled-tr-ftr1-exp-exp1)# local interface Ethernet1
switch(config-ftr-sampled-tr-ftr1-exp-exp1)# no shutdown
```

19.3.5.18 `template interval`

The `template interval` command configures the interval at which templates are exported for a specific exporter. The default template interval is 3600000 milliseconds.

The `no template interval` and `default template interval` commands reset the interval rate to the default.

Command Mode

Sampled Flow Tracking Configuration

Command Syntax

```
template interval interval
```

```
no template interval
```

```
default template interval
```

Parameters

- *interval* the interval rate in milliseconds. The value ranges between 5000 and 3600000 milliseconds. The default rate is 3600000 milliseconds.

Example

- This command configures the interval of 3400000 milliseconds for the exporter *exp1*.

```
switch(config)# flow tracking sampled
switch(config-flow-tracking-sampled)# tracker ftr1
switch(config-ftr-sampled-tr-ftr1)# exporter exp1
switch(config-ftr-sampled-tr-exp-ftr1-exp1)# template interval 3400000
```

19.3.5.19 tracker

The **tracker** command configures a sampled flow tracker for a device.

The **no tracker** and **default tracker** commands remove the sampled flow tracker from the *running config*.

Command Mode

Sampled Flow Configuration

Command Syntax

```
tracker tracker_name
```

```
no tracker tracker_name
```

```
default tracker tracker_name
```

Parameters

- *tracker_name* the flow tracker name.

Example

- These commands configure the sampled flow tracker *ftr1*.

```
switch(config)# flow tracking sampled
switch(config-flow-tracking-sampled)# tracker ftr1
```

19.4 sFlow

This chapter describes Arista's implementation of sFlow, including configuration instructions and command descriptions. Topics covered by this chapter include:

- [sFlow Conceptual Overview](#)
- [sFlow Configuration Procedures](#)
- [sFlow Subinterfaces](#)
- [sFlow Configuration Commands](#)

19.4.1 sFlow Conceptual Overview

19.4.1.1 sFlow Technology

sFlow is a multi-vendor sampling technology that continuously monitors application level traffic flow at wire speed simultaneously on all interfaces. sFlow provides gigabit speed quantitative traffic measurements without impacting network performance.

sFlow has the following network traffic monitoring characteristics:

- sFlow is a statistical sampling technology that is designed to be deployed on all ports within a network to provide end to end visibility.
- sFlow exports packet samples and topology meta data to a centralized collector application
- sFlow is scalable to operate on all switch ports simultaneously.
- sFlow is implemented on all devices, without requiring additional memory or CPU and does not impact dataplane forwarding
- sFlow is an industry standard (RFC 3176).

An sFlow configuration consists of:

- sFlow agents, embedded on network equipment, that monitor traffic and generate data.

-
- sFlow collectors that receive and analyze sFlow data.

Arista switches include an sFlow agent that monitors ingress data through all Ethernet interfaces.

19.4.1.1.1 sFlow Agents

The sFlow agent is a software process that runs as part of the network management software within an Arista switch. It combines interface counters and flow samples into sFlow datagrams that are sent to an sFlow collector. Packets typically include flow samples and state information of the forwarding/routing table entries associated with each sample. Additional data can be gathered for entries originated by BGP.

The sFlow Agent performs minimal processing when packaging data into datagrams. Immediate data forwarding minimizes agent memory and CPU requirements.

19.4.1.1.2 sFlow Collector

An sFlow collector is a server that runs software that analyzes and reports network traffic. Collectors receive flow samples and counter samples respectively as sFlow datagrams from sFlow agents.

Arista switches reference a collector's IP address and UDP port as a configurable setting through a CLI command. Arista switches do not include sFlow collector software.

19.4.1.1.3 sFlow Data

The sFlow Agent uses two forms of sampling: statistical packet-based sampling of switched flows and time-based sampling of network interface statistics.

- **Switched flow sampling:** A sample is taken by either copying the packet's header or extracting feature data from the packet.
- **Interface statistics sampling:** Counter sampling extracts statistics by periodically polling each data source on the device.

sFlow implements flow sampling and counter sampling as part of an integrated system. An sFlow datagram incorporates both sample types.

19.4.1.2 Arista sFlow Implementation

Arista switches provide a single sFlow agent instance that samples ingress traffic from all Ethernet and port channel interfaces. The switch provides two levels of settings for enabling sFlow:

- a global setting that enables packet sampling on the entire switch.
- interface settings that control sampling on individual interfaces when sFlow is globally enabled.

sFlow default settings include:

- global: sFlow and BGP sFlow export are globally disabled.
- Ethernet and port channel interfaces: sFlow is enabled on all interfaces when it is enabled globally. BGP sFlow export is likewise enabled on all interfaces when it is enabled globally.

The switch performs sFlow polling when sFlow is globally enabled. The CLI provides commands that globally disable sampling while counter polling remains enabled. Sample enabling is not controllable on individual interfaces.

The switch sends sFlow datagrams to the collector located at an IP address specified by a global configuration command. If the collector destination is not configured, the switch samples data without transmitting the resulting datagrams.

Although the CLI enforces the configured sampling rate limit, it may drop samples if it cannot handle the number of samples it receives over a specified period. Under normal operation, the maximum packet sample rate is one per 16384 packets. The CLI allows for higher sampling rates by using the dangerous keyword.

The switch can also be configured to allow the routing agent to export BGP information to the sFlow agent. When BGP sFlow export is enabled, sFlow will add BGP information to packets whose destination is a BGP route.

The following lists describe sFlows sampling behavior relative to different packet types:

- Packets that are sampled:
 - CPU
 - IP Options and MTU violations
 - Flooded packets
 - Multicast packets
- Packets that are not sampled:
 - LACP frames
 - LLDP frames
 - STP BPDUs
 - IGMP packets
 - PAUSE frames
 - PIM hello packets
 - CRC error frames
 - Packets dropped by ACLs or due to VLAN violations

19.4.1.3 sFlow and Mirroring

The sFlow and Mirroring is supported using the same interface for both a mirroring session and sFlow at the same time. But when sFlow and mirroring is configured on the same interface, the TAP Aggregation is not supported. And when TAP Aggregation mode is enabled, the interface configured as a source for both a mirroring session and sFlow will only mirror packets, and sFlow samples are not produced.

The sFlow and Mirroring are supported on the following switch series:

DCS-7280R, DCS-7280R2, DCS-7280E, DCS-7500R, DCS-7500R2, DCS-7500E, DCS-7050X, DCS-7060X, DCS-7250X, DCS-7260X, and DCS-7300X.

However, the following switches have a limitation:

DCS-7280R, DCS-7280R2, DCS-7280E, DCS-7500R, DCS-7500R2, and DCS-7500E.

When a mirroring session and sFlow is configured on a same interface for the above devices, the following packet types are not sampled though they are sampled with only sFlow.

- STP BPDUs
- LACP frames
- LLDP frames
- OSPF packets
- PIM HELLO packets
- Packets dropped due to VLAN violations

19.4.2 sFlow Configuration Procedures

Implementing sFlow on an Arista switch consists of configuring the following agent parameters:

1. Collector location address.
2. Agent source address.
3. Polling interval.
4. Sampling rate.

Optionally, sFlow can be configured to include output interface and traffic class information in samples using the [sflow sample](#) command, and to include BGP information in samples whose destination is a BGP route using the [sflow extension bgp](#) command.

After configuring the sFlow agent, sampling is initiated by globally enabling sFlow on the switch.

Platform-specific Considerations

When BGP sFlow export is enabled on Arad platform switches (DCS-7280E and DCS-7500E), BGP information can be added to some sFlow packets with ECMP destinations.

DCS-7500E switches use actual hardware egress port information in sFlow packets. All other platforms use software simulation to determine the egress port.

Configuring the Collector Location

The [sflow destination](#) command specifies the IP address and UDP port of an sFlow collector. The switch supports multiple collectors.

Example

- This command configures the switch to send sFlow data to collectors at 10.42.15.12, port 6100 and 10.52.12.2 port 6343 (the default sFlow port).

```
switch(config)#sflow destination 10.42.15.12 6100
switch(config)#sflow destination 10.52.12.2
switch(config)#
```

Configuring the Agent Source Address

The [sflow source](#) command specifies the source address that the switch places in all sFlow datagrams that it sends to the collector. This address is normally set to an IP address configured on the switch.

Example

- This command configures 10.2.9.21 as the sFlow source address.

```
switch(config)#sflow source 10.2.9.21
switch(config)#
```

The [sflow source-interface](#) command can be alternatively used to specify the interface from which an IP address is derived that the switch places in all sFlow datagrams that it sends to the collector. This address is normally set to an IP address configured on the switch.

Example

- This command configures VLAN interface 25 as the sFlow source interface. The switch enters the IP address for VLAN 25 in the source field of sFlow datagrams.

```
switch(config)#sflow source-interface vlan 25
switch(config)#
```

running-config cannot simultaneously contain [sflow source](#) and [sflow source-interface](#) commands.

Configuring the Polling Interval

The [sflow polling-interval](#) command specifies the interval for sending counter data to the sFlow collector. The default interval is two seconds.

Example

- This command configures the switch to send sFlow data every ten seconds.

```
switch(config)#sflow polling-interval 10
switch(config)#
```

Configuring the Sampling Rate and Sample Contents

The `sflow sample` command sets the packet sampling rate. Packets are sampled at random intervals to avoid inaccurate sampling of periodic events. A rate of 16384 corresponds to an average sample of one per 16,384 packets. The default rate is 1048576.

Example

- This command configures the sFlow sampling rate as 65536 (one per 65,536 packets).

```
switch(config)#sflow sample 65536
switch(config)#
```

The `sflow sample` command can also optionally configure sample packets to include information about the traffic class of the sample. Traffic class is communicated by rewriting the DSCP field in the sample packet.

By default, samples include information about the output interface. To remove this information, use the `[no] sflow sample output interface` command.

- These commands configure sFlow to include traffic class information in samples but to exclude output interface data.

```
switch(config)#no sflow sample output interface
switch(config)#sflow sample rewrite dscp
switch(config)#
```

Enabling BGP sFlow Export

The `sflow extension bgp` command enables BGP sFlow export. When it is enabled, the routing agent will export the BGP routing table and autonomous system path information to the sFlow agent. When sFlow receives a sampled packets whose destination is a BGP route, it will look up the following additional BGP routing information and include it in the sample:

- next hop IP
 - AS numbers
 - AS system path to the destination
 - communities
 - local pref

On Arad platform switches (DCS-7280E and DCS-7500E), BGP sFlow export will also add the above BGP information to sample packets with ECMP destination routes unless they exit the switch via a trunk port or subinterface. When egress port is a trunk port or subinterface, the sample packet will only include AS path information from the first path of the ECMP route and a BGP next hop of 0.

On all other switch platforms, ECMP destination routes will include AS path information from the first path, but will identify the BGP next hop as 0.



Note: A BGP instance must be configured on the switch for BGP sFlow export to operate. See the Border Gateway Protocol(BGP) chapter for details.

Example

- These commands configure a BGP instance in AS 50 and enable BGP sFlow export globally.

```
switch(config)#router bgp 50
switch(config-router-bgp)#exit
switch(config)#sflow extension bgp
switch(config)#
```

Extended Switch and Router Information

By default, extended switch and router information is added to sFlow sample packets.

Extended switch information includes the following:

- source and destination VLANs and priorities

Extended router information includes the following:

- IP version and address of next-hop router
 - source and destination mask lengths

The **no** form of [sflow extension switch](#) and **no** form of [sflow extension router](#) commands prevent the addition of extended switch and router information to sFlow sample packets.

Example

- These commands prevent extended switch and router information from being added to sFlow sample packets.

```
switch(config)#no sflow extension switch
switch(config)#no sflow extension router
switch(config)#
```

Enabling sFlow

The [sflow run](#) command globally enables sFlow on the switch. The [sflow enable](#) command controls sFlow operation on Ethernet and port channel interfaces when sFlow is globally enabled. The [sflow enable](#) command has no effect when sFlow is globally disabled.

Example

- These commands enable sFlow on the switch, then disables sFlow on Ethernet interface 10.

```
switch(config)#sflow run
switch(config)#interface ethernet 10
switch(config-if-Et10)#no sflow enable
switch(config)#
```

19.4.3 sFlow Subinterfaces

The `sflow sample [input | output] subinterface` command configures `ifIndex` values for subinterfaces on input and output ports to be included in the flow sample. These values are in place of the default parent port `ifIndex` value. Enabling this feature changes all sFlow samples generated by the switch from the compact to the expanded format.

Configuring sFlow Subinterface

The following configures subinterfaces on the switch for sampling.

```
switch (config)# sflow run
switch (config-if-Et1)# sflow sample input subinterface
switch (config)# sflow sample output subinterface
```

The following file extract displays the output from a `show sflow detail` command.

```
switch# show sflow detail
...
Status
-----
...
Sample Switch Extension: Yes
Sample Router Extension: Yes
Sample Tunnel IPv4 Egress Extension: No
Sample Input Subinterface: Yes
Sample Output Subinterface: Yes
Port Channel Output Interface Index: portchannel
Sample Encoding Format: expanded
...
```

Limitations

- The feature is supported only on some hardware platforms.
- Only L3 subinterfaces and QinQ L3 subinterfaces support the sFlow output subinterface.
- Tunneled packets such as GRE, MPLSoGRE, and IPinIP are not supported.

19.4.4 sFlow Configuration Commands

This section contains descriptions of sFlow commands.

Global Configuration Commands

- [sflow extension bgp](#)
- [sflow extension router](#)
- [sflow extension switch](#)
- [sflow destination](#)
- [sflow polling-interval](#)
- [sflow run](#)
- [sflow sample](#)
- [\[no\] sflow sample output interface](#)
- [sflow source](#)
- [sflow source-interface](#)

Interface Configuration Commands

- [sflow enable](#)

Privileged EXEC Command

- [clear sflow counters](#)

sFlow Display Commands

- [show sflow](#)
- [show sflow interfaces](#)

19.4.4.1 clear sflow counters

The **clear sflow counters** command resets the global sFlow statistics, which includes the number of samples and sample pool. The hardware trigger count is not reset.

The [show sflow](#) command displays global sFlow statistics.

Command Mode

Privileged EXEC

Command Syntax

```
clear sflow counters
```

Example

- This command resets the sFlow counters.

```
switch#clear sflow counters  
switch#
```

19.4.4.2 [no] sflow sample output interface

By default, sFlow samples include information about the output interface of the sampled packet. The **no sflow sample output interface** command prevents sFlow from including that information.

Command Mode

Global Configuration

Command Syntax

```
no sflow sample output interface
```

Examples

- This command configures sFlow to not include output interface information in samples.

```
switch(config)#no sflow sample output interface  
switch(config)#
```

19.4.4.3 sflow destination

The **sflow destination** command specifies an sFlow collector IP address and UDP port. The switch supports sFlow collector addresses through multiple sFlow destination commands in **running-config**.

The **no sflow destination** and **default sflow destination** commands remove the specified sFlow collector IP address by deleting the corresponding **sflow destination** command from **running-config**.

Command Mode

Global Configuration

Command Syntax

```
sflow destination dest_addr [UDP_PORT]
```

```
no sflow destination dest_addr [UDP_PORT]
```

```
default sflow destination dest_addr [UDP_PORT]
```

Parameters

- **dest_addr** sflow collectors IP address.
- **UDP_PORT** sFlow collectors data reception port. Options include:
 - **<No parameter>** port number 6343 (default).
 - **port_num** port number. Value ranges from 0 to 65535.

Example

- This command configures the switch to send sFlow data to the collector located at 10.42.15.12; the collector receives the data through UDP port 6100.

```
switch(config)#sflow destination 10.42.15.12 6100  
switch(config)#
```

19.4.4.4 sflow enable

The **sflow enable** command enables sFlow on the configuration mode interface when sFlow is globally enabled. By default, sFlow is enabled on all interfaces when sFlow is globally enabled (**sflow run**). The **sflow enable** command is required only when **running-config** contains a **no sflow enable** statement for the specified interface.

The **no sflow enable** command disables sFlow on the configuration mode interface. When sFlow is globally disabled, this command persists in **running-config** but has no effect on switch operation.

The **default sflow enable** command removes the corresponding **no sflow enable** command from **running-config** enabling sFlow capability on the interface.

Command Mode

Interface-Ethernet Configuration

Interface-Port-Channel Configuration

Command Syntax

```
sflow enable
```

```
no sflow enable
```

```
default sflow enable
```

Examples

- These commands enable sFlow on the switch and disable sFlow on Ethernet interface 12.

```
switch(config)#sflow run
switch(config)#interface ethernet 12
switch(config-if-Et12)#no sflow enable
switch(config-if-Et12)#
```

- This command removes the **no sflow enable** command for Ethernet interface 12 from **running-config**, enabling sFlow on the interface whenever sFlow is globally enabled.

```
switch(config-if-Et12)#sflow enable
switch(config-if-Et12)#
```

19.4.4.5 sflow extension bgp

The **sflow extension bgp** command enables BGP export to sFlow. When enabled, this feature the routing agent will export the BGP routing table and autonomous system path information to the sFlow agent. When sFlow receives a sampled packets whose destination is a BGP route, it will look up the following additional BGP routing information and include it in the sample:

- next hop IP
 - AS numbers
 - AS system path to the destination
 - communities
 - local pref

The **no sflow extension bgp** and **default sflow extension bgp** commands disable BGP export to sFlow by deleting the corresponding **sflow extension bgp** command from **running-config**.



Note: A BGP instance must be configured on the switch for BGP sFlow export to operate. See the Border Gateway Protocol chapter for details.

Command Mode

Global Configuration

Command Syntax

```
sflow extension bgp
no sflow extension bgp
default sflow extension bgp
```

Guidelines

BGP sFlow export behaves differently on different switch platforms as follows:

- DCS-7500E switches use actual hardware egress port information in sFlow packets. All other platforms use software simulation to determine the egress port.
- On Arad platform switches (DCS-7280E and DCS-7500E), BGP sFlow export works for sample packets with ECMP destination routes unless they exit the switch via a trunk port or subinterface. When egress port is a trunk port or subinterface, the sample packet will only include AS path information from the first path of the ECMP route and a BGP next hop of 0.
- On all other switch platforms, ECMP destination routes will include AS path information from the first path, but will identify the BGP next hop as 0.
- DCS-7500E switches use actual hardware egress port information in sFlow packets. All other platforms use software simulation to determine the egress port.

Example

- These commands configure a BGP instance in AS 50 and enable BGP sFlow export globally.

```
switch(config)#router bgp 50
switch(config-router-bgp)#exit
switch(config)#sflow extension bgp
switch(config)#
```

19.4.4.6 sflow extension router

By default, the switch provides extended router information in sFlow packets, including the IP version and address of the next-hop router and source and destination mask lengths.

The **no** version of the **sflow extension router** command prevents this information from being included in sFlow packets.

The **sflow extension router** and **default sflow extension router** commands restore the default behavior by deleting the corresponding **no sflow extension router** command from *running-config*.

Command Mode

Global Configuration

Command Syntax

```
sflow extension router
no sflow extension router
default sflow extension router
```

Example

- This command prevents the switch from including extended router information in sFlow packets.

```
switch(config)#no sflow extension router
switch(config)#
```

19.4.4.7 sflow extension switch

By default, the switch provides extended switch information in sFlow packets, including source and destination VLANs and priorities.

The **no** version of the **sflow extension switch** command prevents this information from being included in sFlow packets.

The **sflow extension switch** and **default sflow extension switch** commands restore the default behavior by deleting the corresponding **no sflow extension switch** command from *running-config*.

Command Mode

Global Configuration

Command Syntax

```
sflow extension switch
no sflow extension switch
default sflow extension switch
```

Example

- This command prevents the switch from including extended switch information in sFlow packets.

```
switch(config)#no sflow extension switch
switch(config)#
```

19.4.4.8 sflow polling-interval

The **sflow polling-interval** command specifies the counters polling interval. The switch uses this interval to schedule a ports counter data transmissions to the sFlow collector.

The default interval is two seconds.

The **no sflow polling-interval** and **default sflow polling-interval** commands revert the polling interval to the default of two seconds by removing the **sflow polling-interval** command from *running-config*.

Command Mode

Global Configuration

Command Syntax

```
sflow polling-interval interval_period
```

```
no sflow polling-interval
```

```
default sflow polling-interval
```

Parameters

- ***interval_period*** polling interval (seconds). Value ranges from 0 to 3600 (60 minutes). Default is 2.

Example

- This command configures the switch to send sFlow counter data every ten seconds.

```
switch(config)#sflow polling-interval 10
switch(config)#
```

19.4.4.9 sflow run

The **sflow run** command globally enables sFlow on the switch. The default sFlow global setting is **disabled**. sFlow cannot be enabled on individual interfaces when it is globally disabled.

The **sflow enable** interface configuration command controls sFlow operation on individual Ethernet and port channel interfaces when sFlow is globally enabled. When sFlow is enabled globally, sFlow is also enabled on all interfaces by default.

The **no sflow run** and **default sflow run** commands globally disable sFlow on the switch.

Command Mode

Global Configuration

Command Syntax

```
sflow run
```

```
no sflow run
```

```
default sflow run
```

Examples

- This command enables sFlow on the switch.

```
switch(config)#sflow run  
switch(config)#
```

- This command globally disables sFlow.

```
switch(config)#no sflow run  
switch(config)#
```

19.4.4.10 sflow sample

The **sflow sample** command sets the packet sampling rate. Packets are sampled at random intervals to avoid inaccurate sampling of periodic events; the packet sampling rate defines the average number of ingress packets that pass through an interface for every packet that is sampled. A rate of 16384 corresponds to an average sample of one per 16,384 packets. The switch may drop samples if it cannot handle the configured sample rate. Under normal operation, the maximum packet sample rate is one per 16384 packets. Higher sampling rates can be specified with the **dangerous** option.

By default, samples include information about the output interface. To remove this information, use the [\[no\] sflow sample output interface](#) command.

The **sflow sample** command can also optionally configure sample packets to include information about the traffic class of the sample. Traffic class is communicated by rewriting the DSCP field in the sample packet.

The **no sflow sample** and **default sflow sample** commands reset the packet sampling rate to the default of 1,048,576 and remove output interface and traffic class information from samples by removing the **sflow sample** command from the configuration.

Command Mode

Global Configuration

Command Syntax

```
sflow sample TRUNCATE SAMPLE_RATE [rewrite dscp]
no sflow sample
default sflow sample
```

Parameters

- **SAMPLE_RATE** size of the packet sample from which one packet is selected. Default sample size is 1048576 packets. Options include:
 - **recommended_rate** Integer between 16384 to 16777215.
 - **dangerous any_rate** permits overriding the recommended range of sampling rates. The *any_rate* value range varies by platform:
 - fm6000** 1 to 65535
 - trident** 1 to 16777216
- **rewrite dscp** configures sFlow to rewrite the DSCP field of sample packets to indicate the traffic class of the original packet.
- **TRUNCATE** sFlow sample truncation size between the range of 128 to 512. By default, the sFlow sample truncate size is set to 128. Note, this option is hidden.

Examples

- This command configures the sFlow sampling rate as 65536 (one per 65,536 packets).

```
switch(config)#sflow sample 65536
switch(config)#
```

- This command configures the sFlow sampling rate as 256 (one per 256 packets).

```
switch(config)#sflow sample dangerous 25
switch(config)#
```

- This command configures sFlow to include traffic class information in samples.

```
switch(config)#sflow sample rewrite dscp
```



```
switch(config)#
```

19.4.4.11 sflow source

The `sflow source` command specifies the IP address used in the **Agent** address field of the IPv4 sFlow datagram that the switch sends to the collector. This command cannot be used if *running-config* contains an `sflow source-interface` command.

The `no sflow source` and `default sflow source` commands remove the `sflow source` command from *running-config*.

Command Mode

Global Configuration

Command Syntax

```
sflow source source_addr
```

```
no sflow source
```

```
default sflow source
```

Parameters

- ***source_addr*** source IP address (dotted decimal notation).

Example

- This command configures 10.2.9.21 as the sFlow source address.

```
switch(config)#sflow source 10.2.9.21  
switch(config)#
```

19.4.4.12 sflow source-interface

The `sflow source-interface` command specifies the source IP address that is set to the IP's of the specified interfaces that the switch sends to the collector. Both, the Agent address in the IPv4 sFlow datagram as well as the source IP address sent to the collector are specified in sFlow packet. This command cannot be used if *running-config* contains an `sflow source` command.

The `no sflow source-interface` and `default sflow source-interface` commands remove the `sflow source-interface` command from *running-config*.

Command Mode

Global Configuration

Command Syntax

```
sflow source-interface INT_NAME
```

```
no sflow source-interface
```

```
default sflow source-interface
```

Parameters

- **INT_NAME** Interface type and number. Options include:
 - **interface ethernet** *e_num* Ethernet interface specified by *e_num*.
 - **interface loopback** *l_num* Loopback interface specified by *l_num*.
 - **interface management** *m_num* Management interface specified by *m_num*.
 - **interface port-channel** *p_num* Port-Channel Interface specified by *p_num*.
 - **interface vlan** *v_num* VLAN interface specified by *v_num*.

Example

- This command configures the sFlow source address as the IP address assigned to the loopback 0 interface.

```
switch(config)#sflow source-interface loopback 0  
switch(config)#
```

19.4.4.13 show sflow interfaces

The **show sflow interfaces** command displays the interfaces where sFlow is enabled.

The **show sflow** command displays configured sFlow parameters, operational status, and statistics.

Command Mode

EXEC

Command Syntax

```
show sflow interfaces
```

Examples

- This command displays the show sflow interface message when sFlow is globally disabled.

```
switch#show sflow interfaces
sFlow Interface (s):
-----
sFlow is not running
```

- This command displays the show sflow interface message when sFlow is globally enabled and enabled on all interfaces.

```
switch(config)#sflow run
switch(config)#show sflow interfaces
Default sFlow configuration for an interface: Disable
sFlow Interface (s):
-----
Ethernet1  running(Counter)
Ethernet2  running(Counter)
Ethernet3  running(Flow,Counter)
Ethernet4  running(Flow,Counter)
Ethernet5  running(Flow,Counter)
```

19.4.4.14 show sflow

The **show sflow** command displays configured sFlow parameters, operational status, and statistics.

The [show sflow interfaces](#) command displays the interfaces where sFlow is enabled.

Command Mode

EXEC

Command Syntax

```
show sflow [detail]
```

Parameters

- **detail** adds hardware sampling status and number of discarded samples to the information displayed.

Example

- This command displays the base sFlow information.

```
switch#show sflow
! Displaying counters that may be stale
sFlow Configuration
-----
Destinations: None (default)
Source(s):
  0.0.0.0 ( default ) ( VRF: default )
  :: ( default ) ( VRF: default )
Sample Rate: 1048576 ( default )
Polling Interval (sec): 2.0 ( default )
Rewrite DSCP value: No
Status
-----
Running: No
Polling On: No
Sampling On: No
Send Datagrams:
  No ( Sflow not running ) ( VRF: default )
BGP Export:
  No ( VRF: default )
Hardware Sample Rate: 1044480
Statistics
--More--
! Displaying counters that may be stale
sFlow Configuration
-----
Destinations: None (default)
Source(s):
  0.0.0.0 ( default ) ( VRF: default )
  :: ( default ) ( VRF: default )
Sample Rate: 1048576 ( default )
Polling Interval (sec): 2.0 ( default )
  Rewrite DSCP value: No
Status
-----
Running: No
Polling On: No
Sampling On:
  No Send Datagrams:
    No ( Sflow not running ) ( VRF: default )
BGP Export:
  No ( VRF: default )
Hardware Sample Rate: 1044480
```

```
Statistics
-----
Total Packets: 0
Number of Samples: 0
Sample Pool: 0
Hardware Trigger: 0
Number of Datagrams: 0
```

- This command displays the expanded sFlow information.

```
switch#show sflow detail
! Displaying counters that may be stale
sFlow Configuration
-----
Destinations: None (default)
Source(s):
  0.0.0.0 ( default ) ( VRF: default )
  :: ( default ) ( VRF: default )
Sample Rate: 1048576 ( default )
Polling Interval (sec): 2.0 ( default )
Rewrite DSCP value: No

Status
-----
Running: No
Polling On: No
Sampling On: No
Send Datagrams:
  No ( Sflow not running ) ( VRF: default )
BGP Export:
  No ( VRF: default )
Hardware Sample Rate: 1044480
Hardware Sampling On: No
Sample Output Interface: Yes
Sample Switch Extension: Yes
Sample Router Extension: Yes

Statistics
-----
Total Packets: 0
Number of Samples: 0
Sample Pool: 0
Hardware Trigger: 0
Number of Datagrams: 0
Number of Samples Discarded: 0
```

19.5 SNMP

This chapter describes the Arista switch SNMP agent and contains these sections:

- [SNMP Introduction](#)
- [SNMP Conceptual Overview](#)
- [Configuring SNMP](#)
- [SNMP Commands](#)

19.5.1 SNMP Introduction

Arista Networks switches support many standard SNMP MIBs, making it easier to integrate these platforms into existing network management infrastructures.

With only a few configurations, many public domain and commercially available network management tools can quickly manage Arista switches out of the box. Support of SNMP V2 groups and views and V3 security allow network managers to tune switch monitoring to match the administration policy of the IT organization.

19.5.2 SNMP Conceptual Overview

Simple Network Management Protocol (SNMP) is a protocol that provides a standardized framework and a common language to monitor and manage network devices.

19.5.2.1 SNMP Structure

The SNMP framework has three parts:

- **SNMP manager:** The SNMP manager controls and monitors network host activities and is typically part of a Network Management System (NMS).
- **SNMP agent:** The SNMP agent is the managed device component that manages and reports device information to the manager.
- **Management Information Base (MIB):** The MIB stores network management information.

The agent and MIB reside on the switch. Enabling the SNMP agent requires the definition of the manager-agent relationship. The agent contains MIB variables whose values the manager can request or change. The agent gathers data from the MIB and responds to requests for information. For a list of supported MIBs, refer to the release notes for the specific EOS version.

This chapter discusses enabling the SNMP agent on an Arista switch and controlling notification transmissions from the agent. Information on using SNMP management systems is available in the appropriate documentation for the corresponding NMS application.

19.5.2.2 SNMP Notifications

SNMP notifications are messages, sent by the agent, informing of an event or a network condition. A **trap** is an unsolicited notification. An **inform** (or inform request) is a trap that includes a request for a confirmation that the message is received. Events that a notification can indicate include improper user authentication, restart, and connection losses.

For a list of supported traps, refer to the release notes for the specific EOS version.

19.5.2.3 SNMP Versions

Arista switches support the following SNMP versions:

- **SNMPv1:** The Simple Network Management Protocol, defined in RFC 1157. Security is based on community strings.
- **SNMPv2c:** Community-string based Administrative Framework for SNMPv2, defined in RFC 1901, RFC 1905, and RFC 1906. Security is based on SNMPv1.
- **SNMPv3:** Version 3, as defined in RFCs 2273 to 2275.

19.5.2.4 SNMP Authentication and Encryption Methods

The following are the SNMP stronger Authentication and Encryption methods:

- **Authentication**

- MD5
- SHA-1
- SHA-224
- SHA-256
- SHA-384
- SHA-512

- **Encryption**

- AES
- DES
- AES-192
- AES-256



Note: Use the following minimums when using the stronger SNMPv3 encryption algorithm to avoid any interoperability issues.

- When using AES-192 for encryption/privacy, use a minimum of SHA-224 for authentication.
- When using AES-256 for encryption/privacy, use a minimum of SHA-256 for authentication.

19.5.3 Configuring SNMP

This section describes the steps that configure the switch SNMP agent to communicate with an SNMP manager, including the following:

- [Enabling and Disabling SNMP](#)
- [Enabling SNMP in a VRF](#)
- [Configuring Community Access Control](#)
- [Configuring SNMP Parameters](#)
- [Configuring the Agent to Send Notifications](#)
- [Extending the SNMP Agent Through Runtime Scripts](#)
- [SNMP Traps for MAC Move, Learn, and Age Events](#)
- [SNMP IP Address ACL Support](#)

19.5.3.1 Enabling and Disabling SNMP

SNMP is enabled globally by issuing any [snmp-server community](#) or [snmp-server user](#) command. The [no snmp-server](#) command disables SNMP agent operation by removing all non-default `snmp-server` commands from *running-config*.

19.5.3.2 Enabling SNMP in a VRF

By default, SNMP is enabled only in the **default** VRF. The switch can only send SNMP traps and informs if the host that has been configured to receive them is accessible through an interface in a VRF in which SNMP has been enabled.

To enable or disable SNMP in a VRF, use the [snmp-server vrf](#) command.

19.5.3.3 Configuring Community Access Control

SNMP community strings serve as passwords that permit an SNMP manager to access the agent on the switch. A Network Management System (NMS) can access the switch only if its community string matches at least one of the switch's community strings.

The [snmp-server community](#) command configures the community string.

Example

This command adds the community string *ab_1* to provide read-only access to the switch agent.

```
switch(config) #snmp-server community ab_1 ro
switch(config) #
```

Community statements can reference views to limit MIB objects that are available to a manager. A view is a community string object that specifies a subset of MIB objects. The [snmp-server view](#) command configures the community string.

Examples

- These commands create a view that includes all objects in the *system* group except for those in *system.2*.

```
switch(config) #snmp-server view sys-view system include
switch(config) #snmp-server view sys-view system.2 exclude
switch(config) #
```

- This command adds the community string *lab_1* to provide read-only access to the switch agent for the previously defined view.

```
switch(config) #snmp-server community lab_1 view sys-view
switch(config) #
```

19.5.3.4 Configuring SNMP Parameters

This section describes these SNMP parameter configuration tasks:

- [Configuring the Engine ID](#)
- [Configuring the Group](#)
- [Configuring the User](#)
- [Configuring the Host](#)
- [Enabling Link Trap Generation](#)
- [Specifying the Source Interface](#)
- [Configuring the Chassis-id String](#)
- [Configuring the Contact String](#)
- [Configuring the Location String](#)

19.5.3.4.1 Configuring the Engine ID

The `snmp-server engineID remote` command configures the name of a Simple Network Management Protocol (SNMP) engine located on a remote device. Use the `snmp-server engineID local` command for the local engine.

A remote agent's engine ID must be configured before remote users for that agent are configured. User authentication and privacy digests are derived from the engine ID and user passwords. The configuration command fails if the remote engine ID is not configured first.

 **Note:** When the remote engine ID is changed, all user passwords associated with the engine must be reconfigured.

Example

This command configures DC945798CAB4 as the name of the remote SNMP engine located at 12.23.104.25, UDP port 162

```
switch(config) #snmp-server engineID remote 10.23.104.25 udp-port
DC945798CA
switch(config) #
```

19.5.3.4.2 Configuring the Group

An SNMP group grants specific levels of SNMP access to group users. The `snmp-server group` command configures a new SNMP group.

This command configures *normal_one* as an SNMPv3 group (authentication and encryption) that provides access to the *all-items* read view.

```
switch(config) #snmp-server group normal_one v3 priv read all-items
switch(config) #
```

19.5.3.4.3 Configuring the User

Members of SNMP groups are called *users*. The `snmp-server user` command allows a new user to be added an SNMP group and configures that user's parameters. Remote users are configured by specifying the IP address or port number that accesses the user's SNMP agent.

Example

- This command configures the local SNMPv3 user *tech-1* as a member of the SNMP group *tech-sup*.

```
switch(config) #snmp-server user tech-1 tech-sup v3
switch(config) #
```

- This command configures the remote SNMPv3 user *tech-2* as a member of the SNMP group *tech-sup*. The remote user is on the agent located at *13.1.1.4*.

```
switch(config) #snmp-server user tech-2 tech-sup remote 13.1.1.4 v3
switch(config) #
```

19.5.3.4.4 Configuring the Host

The `snmp-server host` command configures an SNMP host (to which SNMP traps will be sent). The `snmp-server host` command sets the community string if it was not previously configured.

Example

This command adds a v2c inform notification recipient at *12.15.2.3* using the community string *comm-1*.

```
switch(config) #snmp-server host 12.15.2.3 informs version 2c comm-1
switch(config) #
```

19.5.3.4.5 Enabling Link Trap Generation

The `snmp trap link-change` command enables SNMP link trap generation on the configuration mode interface. SNMP link trap generation is enabled by default. If SNMP link trap generation was previously disabled, this command removes the corresponding `no snmp link-status` statement from the configuration. The `show snmp notification` command displays the SNMP link trap generation information.

Example

This command disables SNMP link trap generation on the *Ethernet 5* interface.

```
switch(config-if-Et5) #no snmp trap link-change
switch(config-if-Et5) #
```

19.5.3.4.6 Specifying the Source Interface

The `snmp-server local-interface` command specifies the interface from where an SNMP trap originates. The `show snmp local-interface` command displays the interface of the IP address for SNMP traps.

Example

This command configures the *Ethernet 1* interface as the source of SNMP traps and informs.

```
switch(config) #snmp-server local-interface ethernet 1
switch(config) #
```

19.5.3.4.7 Configuring the Chassis-id String

The chassis ID string is typically set to the serial number of the switch. The SNMP manager uses this string to associate all data retrieved from the switch with a unique identifying label. Under normal operating conditions, editing the chassis ID string contents is unnecessary.

The `snmp-server chassis-id` command configures the chassis ID string. The default chassis ID string is the serial number of the switch. The `show snmp` command displays the chassis ID.

Example

This command configures *xyz-1234* as the chassis-ID string, then displays the result.

```
switch(config) #snmp-server chassis-id xyz-1234
switch(config) #show snmp
Chassis: xyz-1234 <---chassis ID
8 SNMP packets input
  0 Bad SNMP version errors
  0 Unknown community name
  0 Illegal operation for community name supplied
  0 Encoding errors
  8 Number of requested variables
  0 Number of altered variables
  4 Get-request PDUs
  4 Get-next PDUs
  0 Set-request PDUs
21 SNMP packets output
  0 Too big errors
  0 No such name errors
  0 Bad value errors
  0 General errors
  8 Response PDUs
  0 Trap PDUs
SNMP logging: enabled
  Logging to taccon.162
SNMP agent enabled
switch(config) #
```

19.5.3.4.8 Configuring the Contact String

The SNMP contact string is information text that typically displays the name of a person or organization associated with the SNMP agent.

The [snmp-server contact](#) command configures the system contact string. The contact string is displayed by the [show snmp](#) and [show snmp v2-mib contact](#) commands.

Example

These commands configure *Bonnie H at 3-1470* as the contact string.

```
switch(config)#snmp-server contact Bonnie H at 3-1470
switch(config)#
```

19.5.3.4.9 Configuring the Location String

The location string typically provides information about the physical location of the SNMP agent. The [snmp-server location](#) command configures the system location string. By default, the system location string is not set.

Example

These commands configure *lab-25* as the location string.

```
switch(config)#snmp-server location lab_25
switch(config)#show snmp v2-mib location
Location: lab_25
switch(config)#
```

19.5.3.5 Configuring the Agent to Send Notifications

The following steps are mandatory when setting up the SNMP agent to send notifications:

1. Configure the remote engine ID.
2. Configure the group.
3. Configure the user.
4. Configure the host.
5. Enable link trap generation on the interfaces.

[Configuring SNMP Parameters](#) describes each of these tasks.

19.5.3.6 Extending the SNMP Agent Through Runtime Scripts

The switch supports the execution of user supplied scripts to service portions of the OID space.

Scripts run under one of two operational modes:

- **Normal mode** scripts run over an indefinite period to process subsequent objects after the initial request. Maintaining an executing script avoids startup and connection delay each time an object requires processing.
- **One-shot mode** scripts process a single object, then terminate execution; requires the one-shot keyword.

Startup and data collection overhead is required for each request. In both modes, the SNMP server is blocked from serving other requests when waiting for script responses.

The [snmp-server extension](#) command configures the execution of user-supplied scripts to service portions of the OID space. Use the one-shot keyword to specify one-shot execution.

Examples

- This command specifies the file *normal-example.sh*, located in flash as the script file that services the specified OID space in normal mode.

```
switch(config)#snmp-server extension .1.3.6.1.4.1.8072.2 flash:normal-
example.sh
switch(config)#
```

- Contents of the script file:

```
#!/bin/bash
while read cmd; do
  case $cmd in
    PING)
      printf "PONG\n"      ;;
    get)
      read oid
      printf "$oid\n"
      printf "integer\n"
      printf "42\n"      ;;      *)
      printf "NONE\n"
    ;;      esac
done
```

- Testing the script:

```
switch(config)#show snmp mib get .1.3.6.1.4.1.8072.2
NET-SNMP-EXAMPLES-MIB::netSnmpExamples = INTEGER: 42
switch(config)#
```

- This command specifies the file *one-shot-example.sh*, located in flash as the script file that services the specified OID space in one-shot mode, executing once and then exiting.

```
switch(config)#snmp-server extension .1.3.6.1.4.1.8072.2
flash:one-shot-example.sh one-shot
switch(config)#
```

- Contents of the script file:

```
#!/bin/bash
oid="$2"
printf "$oid\n"
printf "integer\n"
printf "42\n"
```

- Testing the script:

```
switch(config)#show snmp mib get .1.3.6.1.4.1.8072.2
NET-SNMP-EXAMPLES-MIB::netSnmpExamples = INTEGER: 42
```

19.5.3.6.1 Normal Script Behavior

The first time the SNMP server requires a script result, it launches it with no arguments. The server communicates with the script through **stdin/stdout**. Before each request, the script is sent the string *PING\n* on **stdin**. The expected response from the script is printing *PONG\n* to **stdout**.

GET and GETNEXT Requests

For **GET** and **GETNEXT** requests, the script is passed two lines on **stdin**, the command (**get** or **getnext**) and the requested OID. The expected response from the script is the printing of three lines to **stdout**: the OID for the result varbind, the **TYPE**, and the **VALUE** itself.

[Table 77: Extension Script Type and Encoding](#) lists legal **TYPE** values and resulting **VALUE** encodings. If the command does not return an appropriate varbind, it should print *NONE* to **stdout** and continue running; this results in an SNMP *noSuchName* error or a *noSuchInstance* exception.

Table 77: Extension Script Type and Encoding

Type string	SNMP type	Encoding for script
integer	Integer32	integer
unsigned	Unsigned32	integer
gauge	Gauge32	integer
counter	Counter32	integer
counter64	Counter64	integer
timetick	TimeTicks	integer
ipaddress	IpAddress	a.b.c.d
objectid	ObjectID	1.3.6.1.42.99.2468
octet	OctetString	hexadecimal string
opaque	Opaque	hexadecimal string
string	OctetString	ascii string

SET Requests

For **SET** requests, script is passed three lines on **stdin**: the command (**set**), and the requested OID, and the **TYPE** and **VALUE**, both on the same line. If the assignment is successful, the expected script response is to print *DONE* to **stdout**. Indicated errors by writing one of the error strings described in **Set Request Error Strings**. In each case, the command should continue running.

Table 78: Set Request Error Strings

authorization-error	no-access	too-big
bad-value	no-creation	undo-failed
commit-failed	no-such-name	wrong-type
gen-error	not-writable	wrong-length
inconsistent-name	read-only	wrong-encoding
inconsistent-value	resource-unavailable	wrong-value

19.5.3.6.2 One-Shot Script Behavior

The command should exit after it finishes processing a single object.

GET and GETNEXT

For each GET or GETNEXT request, the script is invoked once for each OID in the space that it serves. It receives two arguments: -g for GET or -n for GETNEXT, and the requested OID.

The expected script response is the response varbind as three separate lines printed to stdout: the result OID, the type, and the value.

If the command does not return an appropriate varbind, then the script should exit without producing any output. This results in an SNMP **noSuchName** error, or a **noSuchInstance** exception.

Possible reasons that a command would not return an appropriate varbind includes:

- The specified OID didn't correspond to a valid instance for a GET request.
- There were no following instances for a GETNEXT.

SET

A SET request results in the command being called with the arguments: -s, OID, TYPE and VALUE, where TYPE is a listed token. [Normal Script Behavior](#) indicates the type of the value passed as the third parameter.

When the assignment is successful, the script exits without producing any output. Errors are indicated by writing just the error name ([Normal Script Behavior](#)); the agent generates the appropriate error response.

19.5.3.7 SNMP Traps for MAC Move, Learn, and Age Events

This feature adds three new SNMP traps for MAC move, learn, and age events: `aristaMacMove`, `aristaMacLearn`, and `aristaMacAge`, respectively. These are defined in the ARISTA-BRIDGE-EXT-MIB.

19.5.3.7.1 Platform Compatibility

SNMP traps for MAC move, learn, and age events are supported on all platforms.

19.5.3.7.2 Configuration

The `aristaMacMove`, `aristaMacLearn`, and `aristaMacAge` traps are disabled, by default. They may be enabled, like all traps, with the `snmp-server enable traps` command. They are grouped under the “bridge” category, so all can be enabled at once using the `snmp-server enable traps bridge` command, or each be enabled or disabled individually, as shown below:

```
switch(config)#snmp-server enable traps bridge ?
  arista-mac-age      Enable aristaMacAge trap
  arista-mac-learn    Enable aristaMacLearn trap
  arista-mac-move     Enable aristaMacMove trap
switch(config)#snmp-server enable traps bridge arista-mac-age
switch(config)#no snmp-server enable traps bridge arista-mac-le
arn
```

In the above example, `aristaMacAge` traps are enabled, `aristaMacLearn` traps are disabled, and `aristaMacMove` traps have their default value, which is disabled.

19.5.3.7.3 Show Commands

You can display the enabled/disabled status of each trap type using the `show snmp notification` command. Continuing with the example from above:

```
switch(config)#show snmp notification | grep bridge
bridge          arista-mac-age          Yes
bridge          arista-mac-learn        No
bridge          arista-mac-move         No
(aristaMacMove default disabled)
```

19.5.3.8 SNMP IP Address ACL Support

SNMP IP address ACL support provides the ability to add access-lists to limit the source addresses that can be used to query the SNMP server. The access-lists are reachable on the switch through the access SNMP data (port 161). The access-lists contain standard `permit` and `deny` commands.

19.5.3.8.1 Platform Compatibility

SNMP IP address ACL support is platform independent.

19.5.3.8.2 Configuration

Use the following command to add SNMP IP address ACL support:

```
[no | default] snmp-server [[ ipv4 access-list IP4_ACL] | [ ipv6 access-list IP6_ACL ]][ vrf VRF]
```

When the *VRF* is not specified, `default` is assumed.

19.5.3.8.3 Show Commands

Use the `show snmp ipv4 access-list summary` command to display an abbreviated output of an IPv4 access-list.

Example

```
switch#show snmp ipv4 access-list summary
IPv4 ACL Permit169
Total rules configured: 2
Configured on VRFs: red VRF

IPv4 ACL Permit168
Total rules configured: 2
Configured on VRFs: default VRF
Active on VRFs: default VRF
```

Use the `show snmp ipv4 access-list detail` command to display a detailed output of an IPv4 access-list.

Example

```
switch#show snmp ipv4 access-list detail
```



```

IP Access List Permit169
10 permit ip 192.169.199.0/24 any [match 7 packets, 0:19:56 ago]
20 deny ip any any [match 13 packets, 0:03:56 ago]
Total rules configured: 2
Configured on VRFs: red VRF

IP Access List Permit168
10 permit ip 192.168.199.0/24 any [match 7 packets, 0:27:00 ago]
20 deny ip any any [match 13 packets, 0:04:30 ago]
Total rules configured: 2
Configured on VRFs: default VRF
Active on VRFs: default VRF

```

Use the **show snmp ipv4 access-list IPv4ACL** command to display a configured access-list. In this example, the configured access-list is **Permit169**.

Example

```

switch#show snmp ipv4 access-list Permit169
IP Access List Permit169
10 permit ip 192.169.199.0/24 any [match 7 packets, 0:20:12 ago]
20 deny ip any any [match 13 packets, 0:04:12 ago]
Total rules configured: 2
Configured on VRFs: red VRF

```

Use the **show snmp ipv4 access-list summary** command to display a summary of an active access-list.

Example

```

switch#show snmp ipv4 access-list summary
! Same ACL configured in multiple VRFs. Both VRFs are listed in
  both the configured
! and the active sessions
IPv4 ACL Permit169
Total rules configured: 2
Configured on VRFs: default VRF
                  red VRF
Active on VRFs: default VRF
                  red VRF

```

Use the **show snmp ip access-list summary** command to display a short output of the active access-lists.

Example

```

switch#show snmp ip access-list summary
IPv4 ACL Permit169
Total rules configured: 2
Configured on VRFs: default VRF
                  red VRF

```

Active on VRFs: default VRF

19.5.4 SNMP Commands

Global Configuration Commands

- `no snmp-server`
- `snmp-server chassis-id`
- `snmp-server community`
- `snmp-server contact`
- `snmp-server enable traps`
- `snmp-server enable traps bridge`
- `snmp-server engineID local`
- `snmp-server engineID remote`
- `snmp-server extension`
- `snmp-server group`
- `snmp-server host`
- `snmp-server local-interface`
- `snmp-server location`
- `snmp-server qosmib counter-interval`
- `snmp-server user`
- `snmp-server view`
- `snmp-server vrf`

Interface Configuration Commands

- `snmp trap link-change`

Display Commands

- `show snmp`
- `show snmp community`
- `show snmp engineID`
- `show snmp group`
- `show snmp local-interface`
- `show snmp mib`
- `show snmp notification host`
- `show snmp notification`
- `show snmp notification | grep bridge`
- `show snmp user`
- `show snmp v2-mib chassis`
- `show snmp v2-mib contact`
- `show snmp v2-mib location`
- `show snmp view`

19.5.4.1 no snmp-server

The `no snmp-server` and `default snmp-server` commands disable Simple Network Management Protocol (SNMP) agent operation by removing all **snmp-server** commands from *running-config*.

SNMP is enabled with any [snmp-server community](#) or [snmp-server user](#) command.

Command Mode

Global Configuration

Command Syntax

```
no snmp-server
```

```
default snmp-server
```

Example

- This command disables SNMP agent operation on the switch.

```
switch(config)#no snmp-server
switch(config)#
```

19.5.4.2 show snmp community

The `show snmp community` command displays the Simple Network Management Protocol (SNMP) community access strings configured by the [snmp-server community](#) command.

Command Mode

EXEC

Command Syntax

```
show snmp community
```

Example

- This command displays the list of community access strings configured on the switch.

```
switch>show snmp community  
Community name: public  
switch>
```

19.5.4.3 show snmp engineID

The **show snmp engineID** command displays the local SNMP engine information configured on the switch.

Command Mode

EXEC

Command Syntax

```
show snmp engineID
```

Example

- This command displays the ID of the local SNMP engine.

```
switch>show snmp engineid  
Local SNMP EngineID: f5717f001c730436d700  
switch>
```

19.5.4.4 show snmp group

The **show snmp group** command shows the names of configured SNMP groups along with the security model, and view status of each group.

Command Mode

EXEC

Command Syntax

```
show snmp group [GROUP_LIST]
```

Parameters

- GROUP_LIST the name of the group.
 - *<no parameter>* displays information about all groups.
 - *group_name* the name of the group.

Field Descriptions

- groupname name of the SNMP group.
- security model security model used by the group: **v1**, **v2c**, **orv3**.
- readview string identifying the group's read view. Refer to the [show snmp view](#) command.
- writeview string identifying the group's write view.
- notifyview string identifying the group's notify view. This command displays the groups configured on the switch.

Example

```
switch>show snmp group
groupname : normal          security model:v3 priv
readview  : all             writeview: <no writeview
  specified>
notifyview: <no notifyview specified>
switch>
```

19.5.4.5 show snmp local-interface

The `show snmp local-interface` command displays the interface whose IP address is the source address for SNMP traps.

Command Mode

EXEC

Command Syntax

```
show snmp local-interface
```

Example

This command displays the source interface for the SNMP notifications.

```
switch>show snmp local-interface  
SNMP source interface: Ethernet1  
switch>
```

19.5.4.6 show snmp mib

The **show snmp mib** command displays values associated with specified MIB object identifiers (OIDs) that are registered on the switch.

Command Mode

EXEC

Command Syntax

```
show snmp mib OBJECTS
```

Parameters

- OBJECTS object identifiers for which the command returns data. Options include:
 - `get oid_1 [oid_2 ... oid_x]` values associated with each listed OID.
 - `get-next oid_1 [oid_2 ... oid_x]` values associated with subsequent OIDs relative to listed OIDs.
 - `table oid` table associated with specified OID.
 - `translate oid` object name associated with specified OID.
 - `walk oid` objects below the specified subtree.

Example

- This command uses the `get` option to retrieve information about the `sysORID.1` OID.

```
switch#show snmp mib get sysORID.1
SNMPv2-MIB::sysORID[1] = OID: TCP-MIB::tcpMIB
```

- This command uses the `get-next` option to retrieve information about the OID that is after `sysORID.8`.

```
switch#show snmp mib get-next sysORID.8
SNMPv2-MIB::sysORDescr[1] = STRING: The MIB module for managing TCP
implementations
```

19.5.4.7 show snmp notification host

The **show snmp notification host** command displays information for Simple Network Management Protocol notification. Details include IP address and port number of the Network Management System, notification type, and SNMP version.

Command Mode

EXEC

Command Syntax

```
show snmp notification host
```

Field Descriptions

- Notification host IP address of the host.
- udp-port port number.
- type notification type.
- user access type of the user.
- security model SNMP version used.
- traps details of the notification.

Example

- This command displays the hosts configured on the switch.

```
switch>show snmp notification host
Notification host: 172.22.22.20      udp-port: 162   type: trap
user: public                          security model: v2c
switch>
```

19.5.4.8 show snmp notification

The **show snmp notification** command displays the SNMP trap generation information.

Command Mode

EXEC

Command Syntax

```
show snmp notification
```

Example

This command displays the SNMP traps configured on the switch.

```
switch>show snmp notification
-----
Type                               Name                               Enabled
-----
entity                             entConfigChange                   Yes (default)
entity                             entStateOperDisabled              Yes (default)
entity                             entStateOperEnabled               Yes (default)
lldp                                lldpRemTablesChange               Yes (default)
msdpBackwardTransition              msdpBackwardTransition            Yes
msdpEstablished                    msdpEstablished                   Yes
snmp                                linkDown                           Yes
snmp                                linkUp                             Yes
snmpConfigManEvent                 aristaConfigManEvent              Yes (default)
switchover                         aristaRedundancySwitchOverNotif   Yes
test                                aristaTestNotification            Yes
switch>
```

19.5.4.9 show snmp notification | grep bridge

Use the `show snmp notification | grep bridge` command to display the enabled or disabled status of each trap type.

Command Mode

EXEC

Command Syntax

```
show snmp notification | grep bridge
```

Example

```
switch(config)#show snmp notification | grep bridge
bridge      arista-mac-age          Yes
bridge      arista-mac-learn     No
bridge      arista-mac-move    No (aristaMacMove default disabled)
```

19.5.4.10 show snmp user

The **show snmp user** command shows information about Simple Network Management Protocol (SNMP) users. Information that the command displays about each user includes their SNMP version, the engine ID of the host where they reside, and security information

Command Mode

EXEC

Command Syntax

```
show snmp user [USER_LIST]
```

Parameters

- **USER_LIST** the name of the group.
 - *<no parameter>* displays information about all users.
 - *user_name* specifies name of displayed user.

Example

This command displays information about the users configured on the switch.

```
switch>show snmp user  
User name: test  
Security model: v3  
Engine ID: f5717f001c73010e0900  
Authentication protocol: SHA  
Privacy protocol: AES-128  
Group name: normal  
switch>
```

19.5.4.11 show snmp v2-mib chassis

The **show snmp v2-mib chassis** command displays the Simple Network Management Protocol (SNMP) server serial number or the chassis ID string configured by the [snmp-server chassis-id](#) command.

Command Mode

EXEC

Command Syntax

```
show snmp v2-mib chassis
```

Example

This command displays the chassis ID string.

```
switch>show snmp v2-mib chassis  
Chassis: JFL08320162  
switch>
```

19.5.4.12 show snmp v2-mib contact

The `show snmp v2-mib contact` command displays the Simple Network Management Protocol (SNMP) system contact string configured by the [snmp-server contact](#) command. The command has no effect if a contact string was not previously configured.

Command Mode

EXEC

Command Syntax

```
show snmp v2-mib contact
```

Example

This command displays the contact string contents.

```
switch>show snmp v2-mib contact
Contact: John Smith
switch>
```

19.5.4.13 show snmp v2-mib location

The `show snmp v2-mib location` command displays the Simple Network Management Protocol (SNMP) system location string. The [snmp-server location](#) command configures system location details. The command has no effect if a location string was not previously configured.

Command Mode

EXEC

Command Syntax

```
show snmp v2-mib location
```

Example

This command displays the location string contents.

```
switch>show snmp v2-mib location
Location: santa clara
switch>
```

19.5.4.14 show snmp view

The **show snmp view** command displays the information of a Simple Network Management Protocol configuration and the associated MIB. SNMP views are configured with the [snmp-server view](#) command.

Command Mode

EXEC

Command Syntax

```
show snmp view [VIEW_LIST]
```

Parameters

- VIEW_LIST the name of the view.
 - *<no parameter>* displays information about all views.
 - *view_name* the name of the view.
 -

Field Descriptions

- **First column** view name.
- **Second column** name of the MIB object or family.
- **Third column** inclusion level of the specified family within the view.

Example

These commands configure an SNMP view, then displays that view.

```
switch(config)#snmp-server view sys-view system include
switch(config)#snmp-server view sys-view system.2 exclude
switch(config)#show snmp view
sys-view system - included
sys-view system.2 - excluded
```

19.5.4.15 show snmp

The `show snmp` command displays SNMP information including the SNMP counter status and the chassis ID string.

Command Mode

EXEC

Command Syntax

```
show snmp
```

Example

- This command displays SNMP counter status, the chassis ID, the previously configured location string, logging status and destination, and the VRFs in which the SNMP agent is operating.

```
switch>show snmp
Chassis: JFL08320162
Location: 5470ga.dc
2329135 SNMP packets input
  0 Bad SNMP version errors
  0 Unknown community name
  0 Illegal operation for community name supplied
  0 Encoding errors
  38132599 Number of requested variables
  0 Number of altered variables
  563934 Get-request PDUs
  148236 Get-next PDUs
  0 Set-request PDUs
2329437 SNMP packets output
  0 Too big errors
  0 No such name errors
  0 Bad value errors
  0 General errors
  2329135 Response PDUs
  0 Trap PDUs
SNMP logging: enabled
  Logging to 172.22.22.20.162
SNMP agent configured in VRFs: default
SNMP agent enabled in default VRF
switch>
```

19.5.4.16 snmp trap link-change

The **snmp trap link-change** command enables Simple Network Management Protocol (SNMP) link-status trap generation on the configuration mode interface. The generation of link-status traps is enabled by default. If SNMP link-trap generation was previously disabled, this command removes the corresponding **no snmp link-status** statement from the configuration to re-enable link-trap generation.

The **no snmp trap link-change** command disables SNMP link trap generation on the configuration mode interface.

The **snmp trap link-change** and **default snmp trap link-change** commands restore the default behavior by removing the **no snmp trap link-change** command from **running-config**.

Command Mode

Interface-Ethernet Configuration Interface-Loopback Configuration Interface-Management Configuration Interface-Port-channel Configuration Interface-VLAN Configuration Interface-VXLAN Configuration

Command Syntax

```
snmp trap link-change
no snmp trap link-change
default snmp trap link-change
```

Guidelines

The switch can only send SNMP traps and informs if the host that has been configured to receive them is accessible through an interface in a VRF in which SNMP has been enabled. SNMP is enabled by default only in the **default** VRF. Enable or disable SNMP in a VRF with the [snmp-server vrf](#) command.

Example

This command disables SNMP link trap generation on the Ethernet 5 interface.

```
switch(config-if-Et5)#no snmp trap link-change
switch(config-if-Et5)#
```

19.5.4.17 snmp-server chassis-id

The **snmp-server chassis-id** command configures the chassis ID string. The default chassis ID string is the serial number of the switch. The **show snmp** command displays the chassis ID.

The **no snmp-server chassis-id** and **default snmp-server chassis-id** commands restore the default chassis ID string by removing the **snmp-server chassis-id** command from the configuration.

Command Mode

Global Configuration

Command Syntax

```
snmp-server chassis-id id_text
no snmp-server chassis-id
default snmp-server chassis-id
```

Parameters

- *id_text* chassis ID string

Example

These commands configure *xyz-1234* as the chassis-id string, then display the result.

```
switch(config)#snmp-server chassis-id xyz-1234
switch(config)#show snmp
Chassis: xyz-1234<---chassis ID
8 SNMP packets input
  0 Bad SNMP version errors
  0 Unknown community name
  0 Illegal operation for community name supplied
  0 Encoding errors
  8 Number of requested variables
  0 Number of altered variables
  4 Get-request PDUs
  4 Get-next PDUs
  0 Set-request PDUs
21 SNMP packets output
  0 Too big errors
  0 No such name errors
  0 Bad value errors
  0 General errors
  8 Response PDUs
  0 Trap PDUs
SNMP logging: enabled
  Logging to taccon.162
SNMP agent enabled
switch(config)#
```

19.5.4.18 snmp-server community

The **snmp-server community** command configures the community string. SNMP community strings serve as passwords that permit an SNMP manager to access the agent on the switch. The Network Management System (NMS) must define a community string that matches at least one of the switch community strings to access the switch.

The **no snmp-server community** and **default snmp-server community** commands remove the community access string from the configuration.

Command Mode

Global Configuration

Command Syntax

```
snmp-server community string_text [MIB_VIEW][ACCESS][ACL_NAMES]
```

```
no snmp-server community string_text
```

```
default snmp-server community string_text
```

Parameters

- *string_text* community access string.
- MIB_VIEW community access availability. Options include:
 - *<no parameter>* community string allows access to all objects.
 - *view view_name* community string allows access only to objects in the *view_name* view.
- ACCESS community access availability. Options include:
 - *<no parameter>* read-only access (default setting).
 - *ro* read-only access.
 - *rw* read-write access.
- ACL_NAMES community access availability. Options include:
 - *<no parameter>* community string allows access to all objects.
 - *list_v4* IPv4 ACL list.
 - *ipv6 list_v6* IPv6 ACL list.
 - *ipv6 list_v6 list_v4* IPv4 and IPv6 ACL list.

Example

This command adds the community string *lab_1* to provide read-only access to the switch agent.

```
switch(config)#snmp-server community lab_1 ro
switch(config)#
```

19.5.4.19 snmp-server contact

The `snmp-server contact` command configures the system contact string. The contact is displayed by the `show snmp` and `show snmp v2-mib contact` commands.

The `no snmp-server contact` and `default snmp-server contact` commands remove the `snmp-server contact` command from the *running-config*.

Command Mode

Global Configuration

Command Syntax

```
snmp-server contact contact_string
```

```
no snmp-server contact
```

```
default snmp-server contact
```

Parameters

- *contact_string* system contact string.

Example

These commands configure *Bonnie H* as the contact string, then display the result.

```
switch(config)#snmp-server contact Bonnie H
switch(config)#show snmp
Chassis: xyz-1234
Contact: Bonnie H.
8 SNMP packets input
  0 Bad SNMP version errors
  0 Unknown community name
  0 Illegal operation for community name supplied
  0 Encoding errors
  8 Number of requested variables
  0 Number of altered variables
  4 Get-request PDUs
  4 Get-next PDUs
  0 Set-request PDUs
24 SNMP packets output
  0 Too big errors
  0 No such name errors
  0 Bad value errors
  0 General errors
  8 Response PDUs
  0 Trap PDUs
SNMP logging: enabled
  Logging to taccon.162
SNMP agent enabled
switch(config)#
```

19.5.4.20 snmp-server enable traps

The **snmp-server enable traps** command enables both Simple Network Management Protocol (SNMP) traps and SNMP inform requests; use the **snmp-server host** command to specify which will receive SNMP notifications. Sending notifications requires at least one **snmp-server host** command.

The **snmp-server enable traps** and **no snmp-server enable traps** commands, without a MIB parameter, specify the default notification trap generation setting for all MIBs. These commands, when specifying a MIB, control notification generation for the specified MIB. The **default snmp-server enable traps** command resets notification generation to the default setting for the specified MIB.

Command Mode

Global Configuration

Command Syntax

```
snmp-server enable traps [trap_type]
no snmp-server enable traps [trap_type]
default snmp-server enable trap [trap_type]
```

Parameters

- *trap_type* controls the generation of informs or traps for the specified MIB:
 - *<no parameter>* controls notifications for MIBs not covered by specific commands.
 - *entity* controls entity-MIB modification notifications.
 - *lldp* controls LLDP notifications.
 - *msdpBackwardTransition* controls msdpBackwardTransition notifications.
 - *msdpEstablished* controls msdpEstablished notifications.
 - *snmp* controls SNMP-v2 notifications.
 - *switchover* controls switchover notifications.
 - *snmpConfigManEvent* controls snmpConfigManEvent notifications.
 - *test* controls test traps.

Examples

- These commands enables notification generation for all MIBs except spanning tree.

```
switch(config)#snmp-server enable traps
switch(config)#no snmp-server enable traps spanning-tree
switch(config)#
```

- This command enables spanning-tree MIB notification generation, regardless of the default setting.

```
switch(config)#snmp-server enable traps spanning-tree
switch(config)#
```

- This command resets the spanning-tree MIB notification generation to follow the default setting.

```
switch(config)#default snmp-server enable traps spanning-tree
switch(config)#
```

- This command enables switchover MIB notification generation, regardless of the default setting.

```
switch(config)#snmp-server enable traps switchover
switch(config)#
```

- This command resets the switchover MIB notification generation to follow the default setting.

```
switch(config)# default snmp-server enable traps switchover  
switch(config)#
```

19.5.4.21 snmp-server enable traps bridge

The aristaMacMove, aristaMacLearn, and aristaMacAge traps are disabled by default. You can enable them, like all traps, using the **snmp-server enable traps** command. They are grouped under the **bridge** category, so you enable all of them at once using the `snmp-server enable traps bridge` command.

Command Mode

Configuration mode

Command Syntax

```
snmp-server enable traps bridge [arista-mac-age | arista-mac-learn | arista-mac-move]
no snmp-server enable traps bridge [arista-mac-age | arista-mac-learn | arista-mac-move]
```

Parameters

- **arista-mac-age** Enables aristaMacAge trap.
- **arista-mac-learn** Enables aristaMacLearn trap.
- **arista-mac-move** Enables aristaMacMove trap.

Examples

In the following example, aristaMacAge traps are enabled, aristaMacLearn traps are disabled, and aristaMacMove traps have their default value, which is disabled.

```
switch(config)#snmp-server enable traps bridge ?
  arista-mac-age    Enable aristaMacAge trap
  arista-mac-learn  Enable aristaMacLearn trap
  arista-mac-move   Enable aristaMacMove trap
switch(config)#snmp-server enable traps bridge arista-mac-age
switch(config)#no snmp-server enable traps bridge arista-mac-learn
```

19.5.4.22 snmp-server engineID local

The `snmp-server engineID local` command configures the name for the local Simple Network Management Protocol (SNMP) engine. The default SNMP engineID is generated by the switch and is used when an engineID is not configured with this command. The `show snmp engineID` command displays the default or configured engine ID.

SNMPv3 authenticates users through security digests (MD5 or SHA) that are based on user passwords and the local engine ID. Passwords entered on the CLI are similarly converted, then compared to the user's security digest to authenticate the user.

 **Note:** Changing the local engineID value invalidates SNMPv3 security digests, requiring the reconfiguration of all user passwords.

The `no snmp-server engineID` and `default snmp-server engineID` commands restore the default engineID by removing the `snmp-server engineID` command from the *running-config*

Command Mode

Global Configuration

Command Syntax

```
snmp-server engineID local engine_hex
no snmp-server engineID local
default snmp-server engineID
```

Parameters

- *engine_hex* the switch name for the local SNMP engine (hex string).

The string must consist of at least ten characters with a maximum of 64 characters.

Example

- This command configures DC945798CAB4 as the name of the local SNMP engine.

```
switch(config)#snmp-server engineID local DC945798CAB4
switch(config)#
```

19.5.4.23 snmp-server engineID remote

The **snmp-server engineID remote** command configures the name of a Simple Network Management Protocol (SNMP) engine located on a remote device. The switch generates a default engineID; use the [show snmp engineID](#) command to view the configured or default engineID.

An SNMPv3 inform requires a remote engine ID to compute the security digest that authenticates and encrypts data transmitted to remote users. SNMPv3 authenticates users with MD5 or SHA through the engine ID and user passwords. CLI passwords are similarly authenticated.

 **Note:** Changing the engineID value invalidates SNMPv3 security digests, requiring the reconfiguration of all user passwords.

The **no snmp-server engineID remote** and **default snmp-server engineID remote** commands remove the **snmp-server engineID remote** command from the configuration.

Command Mode

Global Configuration

Command Syntax

```
snmp-server engineID remote engine_addr [PORT] engine_hex
no snmp-server engineID remote engine_addr [PORT]
default snmp-server engineID remote engine_addr [PORT]
```

Parameters

- *engine_addr* location of remote engine (IP address or host name).
- PORT udp port location of the remote engine. Options include:
 - *<No parameter>* port number 161 (default).
 - udp-port *port_num* port number. Ranges from 0 to 65535.
- *engine_hex* the switch's name for the remote SNMP engine (hex string).

The string must have at least ten characters and can contain a maximum of 64 characters.

Example

This command configures DC945798CA as the engineID of the remote SNMP engine located at 10.23.10.25, UDP port 162.

```
switch(config)#snmp-server engineID remote 10.23.10.25 udp-port 162
DC945798CA
switch(config)#
```

19.5.4.24 snmp-server extension

The `snmp-server extension` command configures the execution of user supplied scripts to service portions of the OID space.

The `no snmp-server extension` and `default snmp-server extension` commands deletes the `snmp-server extension` command from the *running-config*.

Command Mode

Global Configuration

Command Syntax

```
snmp-server extension OID_space FILE_PATH [DURATION]
```

Parameters

- *OID_space* OID branch serviced by the script, in numerical format.
- FILE_PATH path and name of the script file. Options include:
 - file: file is located in the switch file directory.
 - flash: file is located in flash memory.
- DURATION the execution scope of the script.
 - *<no parameter>* script runs after initial request to process subsequent requests.
 - one-shot script processes a single object (runs once), then terminates.

Examples

This command specifies the file `example.sh`, located in flash, as the script file that services the listed OID space.

```
switch(config)#snmp-server extension .1.3.6.1.4.1.8072.2 flash:example
.sh
```

19.5.4.25 snmp-server group

The **snmp-server group** command configures a new Simple Network Management Protocol (SNMP) group or modifies an existing group. An SNMP group is a data structure that user statements reference to map SNMP users to SNMP contexts and views, providing a common access policy to the specified users.

An SNMP context is a collection of management information items accessible by an SNMP entity. Each item may exist in multiple contexts. Each SNMP entity can access multiple contexts. A context is identified by the EngineID of the hosting device and a context name.

The **no snmp-server group** and **default snmp-server group** commands delete the specified group by removing the corresponding **snmp-server group** command from the configuration.

Command Mode

Global Configuration

Command Syntax

```
snmp-server group group_name VERSION [CNTX][READ][WRITE][NOTIFY]
```

```
no snmp-server group group_name VERSION
```

```
default snmp-server group group_name VERSION
```

Parameters

- *group_name* the name of the group.
- VERSION the security model utilized by the group.
 - v1 SNMPv1. Uses a community string match for authentication.
 - v2c SNMPv2c. Uses a community string match for authentication.
 - v3 no auth SNMPv3. Uses a username match for authentication.
 - v3 auth SNMPv3. HMAC-MD5 or HMAC-SHA authentication.
 - v3 priv SNMPv3. HMAC-MD5 or HMAC-SHA authentication. AES or DES encryption.
- CNTX associates the SNMP group to an SNMP context.
 - *<no parameter>* command does not associate group with an SNMP context.
 - context *context_name* associates group with context specified by *context_name*.
- READ specifies read view for SNMP group.
 - *<no parameter>* command does not specify read view.
 - read *read_name* read view specified by *read_name* (string maximum 64 characters).
- WRITE specifies write view for SNMP group.
 - *<no parameter>* command does not specify write view.
 - write *write_name* write view specified by *write_name* (string maximum 64 characters).
- NOTIFY specifies notify view for SNMP group.
 - *<no parameter>* command does not specify notify view.
 - notify *notify_name* notify view specified by *notify_name* (string maximum 64 characters).

Example

This command configures normal_one as SNMP version 3 group (authentication and encryption) that provides access to the **all-items read view**.

```
switch(config) #snmp-server group normal_one v3 priv read all-items
switch(config) #
```

19.5.4.26 snmp-server host

The `snmp-server host` command configures an SNMP host (to which SNMP traps will be sent) and sets the community string if it was not previously configured. The host is denoted by host location and community string. The command also specifies the type of SNMP notifications that are sent: a trap is an unsolicited notification; an inform is a trap that includes a request for a confirmation that the message is received

The configuration can contain multiple statements to the same host location with different community strings. For instance, a configuration can simultaneously contain all of the following:

- `snmp-server host host-1 version 2c comm-1`
- `snmp-server host host-1 informs version 2c comm-2`
- `snmp-server host host-1 version 2c comm-3 udp-port 666`
- `snmp-server host host-1 version 3 auth comm-3`

The `no snmp-server host` and `default snmp-server host` commands remove the specified host by deleting the corresponding `snmp-server host` statement from the configuration. When removing a statement, the host (address and port) and community string must be specified.

Command Mode

Global Configuration

Command Syntax

```
snmp-server host host_id [VRF_INST][MESSAGE][VERSION] comm_str [PORT]
no snmp-server host host_id [VRF_INST][MESSAGE][VERSION] comm_str [PORT]
default snmp-server host host_id [VRF_INST][MESSAGE][VERSION] comm_str [PORT]
```

Parameters

- *host_id* hostname or IP address of the SNMP host.
- VRF_INST specifies the VRF instance being modified.
 - *<no parameter>* changes are made to the default VRF.
 - *vrf vrf_name* changes are made to the specified user-defined VRF.
- MESSAGE message type that is sent to the host.
 - *<no parameter>* sends SNMP traps to host (default).
 - informs sends SNMP informs to host.
 - traps sends SNMP traps to host.
- VERSION SNMP version. Options include:
 - *<no parameter>* SNMPv2c (default).
 - version 1 SNMPv1; option not available with informs.
 - version 2c SNMPv2c.
 - version 3 noauth SNMPv3; enables user-name match authentication.
 - version 3 auth SNMPv3; enables MD5 and SHA packet authentication.
 - version 3 priv SNMPv3. HMAC-MD5 or HMAC-SHA authentication. AES or DES encryption.
- *comm_str* community string to be sent with the notification as a password.

Arista recommends setting this string separately before issuing the `snmp-server host` command. To set the community string separately, use the [snmp-server community](#) command.

- PORT port number of the host.
 - *<no parameter>* socket number set to 162 (default)
 - `udp-port p-name` socket number specified by *p-name*.

Guidelines

The switch can only send SNMP traps and informs if the host that has been configured to receive them is accessible through an interface in a VRF in which SNMP has been enabled. SNMP is enabled by default only in the **default** VRF. Enable or disable SNMP in a VRF with the [snmp-server vrf](#) command.

Example

This command adds a version 2c inform notification recipient.

```
switch(config)#snmp-server host 10.15.2.3 informs version 2c comm-1
switch(config)#
```

19.5.4.27 snmp-server local-interface

The **snmp-server local-interface** command specifies the interface where SNMP originates informs and traps.

The **no snmp-server local-interface** and **default snmp-server local-interface** commands remove the inform or trap source assignment by removing the **snmp-server local-interface** command from *running-config*.

Command Mode

Global Configuration

Command Syntax

```
snmp-server local-interface INTERFACE
no snmp-server local-interface
default snmp-server local-interface
```

Parameters

- **INTERFACE** Interface type and number. Values include:
 - **ethernet** *e_num* Ethernet interface specified by *e_num*.
 - **loopback** *l_num* Loopback interface specified by *l_num*.
 - **management** *m_num* Management interface specified by *m_num*.
 - **port-channel** *p_num* Port-Channel Interface specified by *p_num*
 - **vlan** *v_num* VLAN interface specified by *v_num*.
 - **vrf** *vrf_name* The VRF in which SNMP is enabled. The keyword **default** specifies the default VRF.

Example

This command configures the Ethernet 1 interface as the source of SNMP traps and informs.

```
switch(config)#snmp-server local-interface ethernet 1
switch(config)#
```

19.5.4.28 snmp-server location

The **snmp-server location** command configures the system location string. By default, no system location string is set.

The **no snmp-server location** and **default snmp-server location** commands delete the location string by removing the **snmp-server location** command from the configuration.

Command Mode

Global Configuration

Command Syntax

```
snmp-server location node_locate
```

```
no snmp-server location
```

```
default snmp-server location
```

Parameters

- *node_locate* system location information (string).

Example

These commands configure *lab-east* as the location string.

```
switch(config)#snmp-server location lab_east  
switch(config)#
```

19.5.4.29 snmp-server qosmib counter-interval

The `snmp-server qosmib counter-interval` command configures the interval (in seconds) after which the QoS counters are updated periodically. By default the counter updates are disabled.

Command Mode

Global Configuration

Command Syntax

```
snmp-server qosmib counter-interval timer_interval
```

```
no snmp-server qosmib counter-interval
```

```
default snmp-server qosmib counter-interval
```

Parameter

- *timer_interval* Update interval for refreshing QoS counters (in seconds) between (10-600).

Example

- The following command configures a interval of 50 seconds after which the QoS counters are updated periodically.

```
switch(config)#snmp-server qosmib counter-interval 50
```

19.5.4.30 snmp-server user

The `snmp-server user` command adds a user to a Simple Network Management Protocol (SNMP) group or modifies an existing user's parameters.

To configure a user, the IP address or port number of the device where the user's remote SNMP agent resides must be specified. A user's authentication come from the engine ID and the user's password. Remote user configuration commands fail if the remote engine ID is not configured first.

The `no snmp-server user` and `default snmp-server user` commands remove the user from an SNMP group by removing the user command from *running-config*.



Note: Use the following minimums when using the stronger SNMPv3 encryption algorithm to avoid any interoperability issues.

- When using AES-192 for encryption/privacy, use a minimum of SHA-224 for authentication.
- When using AES-256 for encryption/privacy, use a minimum of SHA-256 for authentication.

Command Mode

Global Configuration

Command Syntax

```
snmp-server user user_name group_name [AGENT] VERSION [ENGINE][SECURITY]
```

```
no snmp-server user user_name group_name [AGENT] VERSION
```

```
default snmp-server user user_name group_name [AGENT] VERSION
```

Parameters

- *user_name* name of user.
 - *group_name* name of group to which user is being added.
 - AGENT Options include:
 - *<no parameter>* local SNMP agent.
 - remote *addr* [udp-port *p_num*] remote SNMP agent location.
- addr* denotes the IP address; *p_num* denotes the udp port socket (default port is 162).
- VERSION SNMP version; options include:
 - v1 SNMPv1.
 - v2c SNMPv2c.
 - v3 SNMPv3 .
 - ENGINE engine ID used to localize passwords. Available only if VERSION is v3.
 - *<no parameter>* Passwords localized by SNMP copy specified by *agent*.
 - localized *engineID* octet string of engineID.
 - SECURITY Specifies authentication and encryption levels. Available only if VERSION is v3. Encryption is available only when authentication is configured.
 - *<no parameter>* no authentication or encryption.
 - auth *a_meth a_pass* [priv *e_meth e_pass*] authentication parameters.
 - *a_meth* authentication method: options are md5 (HMAC-MD5-96) and sha (HMAC-SHA-96).
 - *a-pass* authentication string for users receiving packets.
 - *e-meth* encryption method: Options are aes (AES-128) and des (CBC-DES).
 - *e-pass* encryption string for the users sending packets.

Example

This command configures the remote SNMP user *tech-1* to the *tech-sup* SNMP group.

```
switch(config)#snmp-server user tech-1 tech-sup remote 10.1.1.2 v3
```

19.5.4.31 snmp-server view

The **snmp-server view** command defines a view.

An SNMP view defines a subset of objects from an MIB. Every SNMP access group specifies views, each associated with read or write access rights, to allow or limit the group's access to MIB objects.

The **no snmp-server view** command deletes a view entry by removing the corresponding **snmp-server view** command from the *running-config*.

Command Mode

Global Configuration

Command Syntax

```
snmp-server view view_name family_name INCLUSION
```

```
no snmp-server view view_name [family_name]
```

```
default snmp-server view view_name [family_name]
```

Parameters

- *view_name* Label for the view record that the command updates. Other commands reference the view with this label.
- *family_name* name of the MIB object or family.

MIB objects and MIB subtrees can be identified by name or by the numbers representing the position of the object or subtree in the MIB hierarchy.

- INCLUSION inclusion level of the specified family within the view. Options include:
 - include view includes the specified subtree.
 - exclude view excludes the specified subtree.

Example

- These commands create a view named sys-view that includes all objects in the system subtree except for those in *system.2*.

```
switch(config)#snmp-server view sys-view system include  
switch(config)#snmp-server view sys-view system.2 exclude
```

19.5.4.32 snmp-server vrf

The `snmp-server vrf` command enables SNMP in the specified VRF. By default, SNMP is enabled only in `default` VRF.

- User-defined VRFs: The `no snmp-server vrf` command disables SNMP in the specified VRF by removing the corresponding `snmp-server vrf` command from the *running-config*.
- Default VRF: The `no snmp-server vrf` command disables SNMP in the VRF by adding a `no snmp-server vrf default` statement to running-config

Command Mode

Global Configuration

Command Syntax

```
snmp-server vrf vrf_name
no snmp-server vrf vrf_name
default snmp-server vrf vrf_name
```

Parameters

- `vrf_name` The VRF in which SNMP is enabled. The keyword `default` specifies the default VRF.

Guidelines

The switch can only send SNMP traps and informs if the host that has been configured to receive them is accessible through an interface in a VRF in which SNMP has been enabled. SNMP is enabled by default only in the `default` VRF. Enable or disable SNMP in a VRF with the `snmp-server vrf` command.

Example

These commands disable SNMP in the default VRF, then enable it in the user-defined VRFs named *magenta* and *columbia*.

```
switch(config)#no snmp-server vrf default
switch(config)#snmp-server vrf magenta
switch(config)#snmp-server vrf columbia
switch(config)#
```

19.6 VM Tracer

This chapter describes VM Tracer configuration and usage and contains these sections:

- [VM Tracer Introduction](#)
- [VM Tracer Description](#)
- [VM Tracer Configuration Procedures](#)
- [VM Tracer Commands](#)

19.6.1 VM Tracer Introduction

VM Tracer is a switch feature that determines the network configuration and requirements of connected VMware hypervisors. The switch uses VMware's SOAP XML API to discover VMware host server components, including:

- instantiated VMs with their network configuration (VLANs and distributed/virtual Switches).
- server hardware IPMI data which can be shown to the network manager.

VM Tracer also supports adaptive auto-segmentation, which automatically provisions and prunes VLANs from server-switched ports as VMs are instantiated and moved within the data center.

19.6.2 VM Tracer Description

Cloud operating systems manage large virtualized computing infrastructures, including software and hardware. Cloud operating systems consist of virtual machines and hypervisors:

- A virtual machine (VM) is a software implementation of a computer that operates as running on dedicated physical hardware. Multiple VMs share physical machine resources from a single physical device. Each VM is controlled by its operating system.
- A hypervisor, also called a virtual Machine Manager (VMM), is software that manages multiple operating systems running concurrently on a physical device.

VM Tracer tracks activity of VMs that are controlled by hypervisors connected to the switch's Ethernet or LAG ports. VM Tracer supports vSphere versions 6.0– 7.0. The vSphere features include distributed virtual switches (DVS) and VM movement among VMware servers (VMotion).

vSphere components include:

- ESX and ESXi: hypervisors that run on VMware host server hardware.
- vCenter: centralized tool that manages multiple servers running VMware hypervisors.
- NSX for vSphere® (NSX-V): network virtualization platform delivering networking and security.

Monitoring VLAN based configurations requires vCenter access. Monitoring VXLAN based configurations requires access to vCenter and NSX-V. The following sections describe topologies that monitor these networks:

- [Monitoring VLAN Based Configurations](#)
- [Monitoring VXLAN Based Configurations](#)

19.6.2.1 Monitoring VLAN Based Configurations

vCenter manages ESX hosts and VMs through a central database. VM Tracer identifies interfaces connected to a specified ESX host and sends discovery packets (CDP or LLDP) on interfaces where VM Tracer is enabled. The ESX host updates the vCenter when it receives a discovery packet. VM Tracer reads this data from the vCenter through a SOAP XML API to associate the ESX host to the connected switch ports. The network topology of this configuration is displayed below.

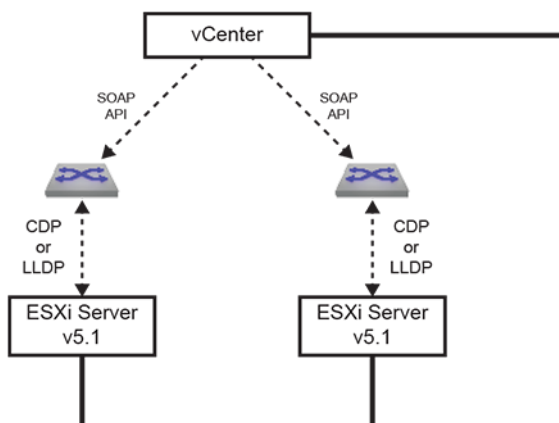

Figure 140: VM Tracer Topology – Monitoring VLAN Based Configurations

VM Tracer connects to a maximum of four vCenters through a SOAP (Simple Object Access Protocol) API to discover VMs in the data centers that the vCenters manage. VM Tracer maintains a list of VMs in the data center and gathers network related information about each VM, including the number of Vnics (virtual network interface card), the MAC address of each Vnic, the switch to which it connects,

and the host on which it resides. VM Tracer also identifies the host NICs connected to the switch through the bridge MAC address and the interface port name. VM Tracer then searches for VMs on this host and connected to the vswitch or dvswitch whose uplink is mapped to the connected NIC.

For each connected interface, VM Tracer creates a VM Table that lists its active VMs, sorted by Vnic MAC address. Each VM entry includes its name, Vnic name, VLAN, switch name, datacenter name, and portgroup. An entry is deleted when the corresponding VM is removed, moved to a different host, or its Vnic is no longer part of the vswitch or dvswitch. An entry is added when a VM is created or moved to a host connected to the interface. VM Tracer monitors vCenter for VM management updates. If an interface goes down, all VM entries for that interface are removed from the VM Table.

19.6.2.2 Monitoring VXLAN Based Configurations

Monitoring VXLAN based configurations require access to the NSX for vSphere® (NSX-V), in addition to the configuration described in [Monitoring VLAN Based Configurations](#). Each VM Tracer session can communicate with one NSX-V through a REST interface over XML and gathers VXLAN information by polling it on a 30 second polling cycle. VXLAN data that the switch receives from the NSX-V includes:

- VNI range.
- VXLAN segment.
- Multicast address range.
- network scope.

The network scope specifies the virtual address space the VXLAN segments span and is defined by the server group (cluster) collections within the segments, which in turn contain a collection of distributed virtual switches (DVS) from ESX hosts within the clusters.

VM Tracer uses this information to build a network model. Communications with NSX-V requires a single polling thread that detects network connectivity and constantly updates the local data model.

The network topology of this configuration is displayed below.

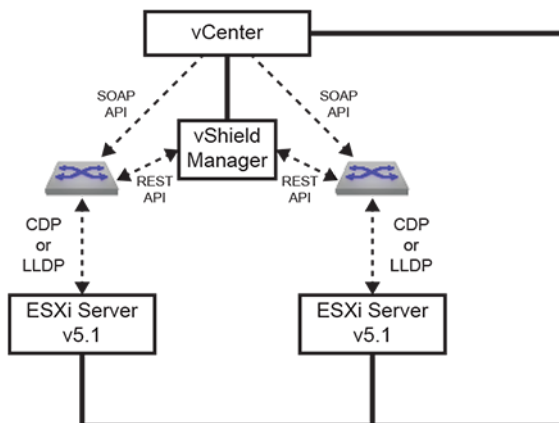

Figure 141: VM Tracer Topology – Monitoring VXLAN Based Configurations

19.6.3 VM Tracer Configuration Procedures

The following sections describe the session configuration process, configuring the NSX-V connection for VXLAN based configurations, and the procedure for enabling VM Tracer on individual interfaces. The switch defines vmtracer configuration mode and VMtracer mode:

- vmtracer configuration mode is a command mode for configuring VM Tracer monitoring sessions.
- VMtracer mode is defines an interface state where discovery packets are sent to attached vSwitches.

19.6.3.1 Configuring vCenter Monitoring Sessions

A VM Tracer session connects the switch to a vCenter server for downloading data about VMs and vSwitches managed by ESX hosts connected to the switch's ports. The switch supports four VM Tracer sessions.

The switch is placed in `vmtracer` configuration mode to edit session parameters, including the vCenter location and dynamic VLAN usage. Changes take effect by exiting `vmtracer` mode.

The `vmtracer session` command places the switch in `vmtracer` configuration mode for a specified session. The command either creates a new session or loads an existing session for editing.

- This command enters `vmtracer` configuration mode for the `system_1` session.

```
switch(config)#vmtracer session system_1
switch(vmtracer-system_1)#
```

In `vmtracer` configuration mode, the `url (vmtracer mode)`, `username (vmtracer mode)`, and `password (vmtracer mode)` commands specify the location and the account information that authenticates the switch. The URL parameter must reference a fully formed secure URL.

- These commands specify the IANA url along with the username and password that allow the switch to access the location.

```
switch(vmtracer-system_1)#url https://example.com/sdk
switch(vmtracer-system_1)#username a-switch_01
switch(vmtracer-system_1)#password abcde
switch(vmtracer-system_1)#
```

Default session settings allow auto-segmentation, or the dynamic allocation and pruning of VLANs when a VM managed by the ESX host connected to the switch is created, deleted, or moved to a different host. The `autovlan disable` command prevents auto-segmentation, regardless of VM activity. The `allowed-vlan` command specifies the VLANs that may be added when a VM is added or moved. By default, all VLANs are allowed.

- This command disables auto-segmentation.

```
switch(vmtracer-system_1)#autovlan disable
switch(vmtracer-system_1)#
```

- These commands enable auto-segmentation and limit the list of allowed VLANs to VLAN 1-2000.

```
switch(vmtracer-system_1)#no autovlan disable
switch(vmtracer-system_1)#allow-vlan 1-2000
switch(vmtracer-system_1)#
```

The `exit` command returns the switch to Global configuration mode and enables the VM Tracer session. `vmtracer` configuration mode can be re-entered for this session to edit session parameters.

- This command exits `vmtracer` configuration mode.

```
switch(vmtracer-system_1)#exit
switch(config)#
```

The `no vmtracer session` command disables the session and removes it from *running-config*.

- This command disables and deletes the `system_1` VM Tracer session.

```
switch(config)#no vmtracer session system_1
switch(config)#
```

19.6.3.2 Configuring vShield Monitoring Sessions

To monitor VXLAN based VMware configurations, the switch must communicate with a NSX for vSphere® (NSX-V). Vmtracer-vxlan configuration mode specifies the location and user account data that allows the switch to access a NSX-V within the configuration mode vmtracer session.

The switch is placed in vmtracer configuration mode to edit session parameters, including the vCenter location and dynamic VLAN usage. Changes take effect by exiting vmtracer mode.

The `vxlan (vmtracer mode)` command is executed from vmtracer mode for a specified session and places the switch in vmtracer-vxlan configuration mode for that session. Each VM Tracer session can be associated with one vShield instance.

- These commands create the vShield instance for the VMTracer session named vnet-1.

```
switch(config)#vmtracer session vnet-1
switch(config-vmtracer-vnet-1)#vxlan
switch(config-vmtracer-vnet-1-vxlan)#
```

In vmtracer-vxlan configuration mode, the `url (vmtracer-vxlan mode)`, `username (vmtracer-vxlan mode)`, and `password (vmtracer-vxlan mode)` commands specify the vShield server's location and the account information that authenticates the switch to the vShield server. The url parameter must reference a fully formed secure url, such as **https://vcshield.democorp.com/sdk**.

- These commands specify the vShield's URL along with the username and password that allow the switch to access the vShield server.

```
switch(config-vmtracer-vnet-1-vxlan)#url https://vshieldserver.com
any1.org/sdk
switch(config-vmtracer-vnet-1-vxlan)#username a-shield_01
switch(config-vmtracer-vnet-1-vxlan)#password home
switch(config-vmtracer-vnet-1-vxlan)#
```

19.6.3.3 Enabling VMtracer Mode

VMtracer mode is an interface setting that enables interfaces to send discovery packets to the connected vSwitch. The `vmtracer` command enables VMtracer mode on the configuration mode interface.

- These commands enable VMtracer mode on the Ethernet 3 interface.

```
switch(config)#interface Ethernet3
switch(config-if-Et3)#vmtracer vmware-esx
switch(config-if-Et3)#
```

The `no vmtracer` command disables vmtracer mode on the configuration mode interface.

- This command disables vmtracer mode on the Ethernet 3 interface.

```
switch(config-if-Et3)#no vmtracer vmware-esx
switch(config-if-Et3)#
```

19.6.3.4 Displaying VM Tracer Data

19.6.3.4.1 Displaying Session Status

The `show vmtracer session` command displays information about the specified session.

Without the detail parameter, the command displays connection parameters and status for the vCenter associated to the specified session.

- This command displays connection parameters for the vCenter associated with the system_1 session.

```
switch#show vmtracer session system_1
vCenter URL https://vmware-vcenter1/sdk
username arista
password arista
Session Status Disconnected
```

With the detail parameter, the command displays connection status and data concerning messages the vCenter previously received from ESX hosts connected to the switch.

- This command displays connection parameters and message details for the vCenter associated with the system_1 session.

```
switch#show vmtracer session system_1 detail
vCenter URL https://vmware-vcenter1/sdk
username arista
sessionState Connected
lastStateChange 19 days, 23:03:59 ago
lastMsgSent CheckForUpdatesMsg
timeOfLastMsg 19 days, 23:14:09 ago
resonseTimeForLastMsg 0.0
numSuccessfulMsg 43183
lastSuccessfulMsg CheckForUpdatesMsg
lastSuccessfulMsgTime 19 days, 23:14:19 ago
numFailedMsg 1076
lastFailedMsg CheckForUpdatesMsg
lastFailedMsgTime 19 days, 23:14:09 ago
lastErrorCode Error -1 fault: SOAP-ENV:Client [no subcode]
"End of file or no input: Operation interrupted or timed out after
600s send
or 600s receive delay"
Detail: [no detail]
CheckForUpdates:
```

19.6.3.4.2 Displaying VM Interfaces

The `show vmtracer interface` command displays the VM interfaces (Vnics) that are active on switch interfaces where vmtracer mode is enabled. For each Vnic, the command displays the name of the attached VM, the adapter name, its VLAN, the VM power state, and the presence status of its MAC address in the switch's MAC table.

This command displays the Vnics connected to all VM Tracer-enabled interfaces.

```
switch#show vmtracer interface

Ethernet8 : example.com
  VM Name VM Adapter VLAN Status
  esx3.aristanetworks.com vmk0 0 Up/Down
  vspheremanagement Network adapter 1 0 Up/Down

Ethernet15 : example.om
  VM Name VM Adapter VLAN Status
  Openview Network adapter 1 123 Up/Down
  VmTracerVm Network adapter 1 123 Down/Down

Ethernet23 : example.com
  VM Name VM Adapter VLAN Status
```

```
Ethernet24 : example.com
  VM Name VM Adapter VLAN Status
```

19.6.3.4.3 Displaying VMs

The `show vmtracer vm` command displays VM interfaces (Vnics) accessible to the VM Tracer-enabled interfaces. For each active listed VM, the command displays its name, adapter, and the connected hypervisor.

- This command displays the VMs connected to all VM Tracer-enabled interfaces.

```
switch#show vmtracer vm
  VM Name VM Adapter Interface VLAN
  Openview Network adapter 1 Et15 123
  vspheremangement Network adapter 1 Et8 0
  VmTracerVm Network adapter 1 Et15 123
  example.com vmk0 Et8 0
```

- This command displays connection data for the VMs connected to all VM Tracer-enabled interfaces.

```
switch#show vmtracer vm detail
VM Name Openview
  intf : Et15
  vnic : Network adapter 1
  mac : 00:0c:29:ae:7e:90
  portgroup : dvPortGroup
  vlan : 123
  switch : vds
  host : example.com
```

19.6.4 VM Tracer Commands

Global Configuration Commands

- [vmtracer session](#)

Interface Configuration (Ethernet and Port Channel) Commands

- [vmtracer](#)

VMTracer Configuration Commands

- [allowed-vlan](#)
- [autovlan disable](#)
- [password \(vmtracer mode\)](#)
- [source-interface](#)
- [url \(vmtracer mode\)](#)
- [username \(vmtracer mode\)](#)
- [vrf \(vmtracer mode\)](#)
- [vxlan \(vmtracer mode\)](#)

VMTracer-VXLAN Configuration Commands

- [password \(vmtracer-vxlan mode\)](#)
- [url \(vmtracer-vxlan mode\)](#)
- [username \(vmtracer-vxlan mode\)](#)

VM Tracer Display Commands

- [show vmtracer all](#)
- [show vmtracer interface](#)
- [show vmtracer session](#)
- [show vmtracer session vcenter](#)
- [show vmtracer session vsm](#)
- [show vmtracer vm](#)
- [show vmtracer vm detail](#)
- [show vmtracer vnic counters](#)
- [show vmtracer vxlan segment](#)
- [show vmtracer vxlan vm](#)

19.6.4.1 allowed-vlan

The **allowed-vlan** command specifies the VLANs that may be added when a VM is added or moved from the hypervisor connected to the session specified by the vmtracer mode. By default, all VLANs are allowed.

Command Mode

Vmtracer Configuration

Command Syntax

```
allowed-vlan [VLAN_LIST]
no allowed-vlan
default allowed-vlan vlan
```

Parameters

- **VLAN_LIST** The VLAN list or the edit actions to the current VLAN list. Valid *v_range* formats include number, or number range.
 - *v_range* The list consists of the *v_range* VLANs.
 - **add** *v_range* The *v_range* VLANs are added to the current VLAN list.
 - **all** The list consists of all VLANs (1-4094).
 - **except** *v_range* The list consists of all VLANs except for those specified by *v_range*.
 - **none** The list of VLANs is empty.
 - **remove** *v_range* The *v_range* VLANs are removed from the current VLAN list.

Related Commands

- [vmtracer session](#) places the switch in vmtracer configuration mode.

Examples

- This command sets the list of allowed VLANs to 1 through 2000.

```
switch(vmtracer-system_1)#allow-vlan 1-2000
switch(vmtracer-system_1)#
```

- This command adds VLANs to 2501 through 3000.

```
switch(vmtracer-system_1)#allow-vlan add 2051-3000
switch(vmtracer-system_1)#
```

19.6.4.2 autovlan disable

Default VM Tracer session settings enable auto provisioning, which allows the dynamic assignment and pruning of VLANs when a VM attached to the ESX connected to the switch is created, deleted, or moved to a different ESX host. The autovlan setting controls auto provisioning.

The **autovlan disable** command disables auto provisioning, which prevents the creation or deletion of VLANs regardless of VM activity. The [allowed-vlan](#) command specifies the VLANs that may be added when a VM is added or moved. By default, all VLANs are allowed.

The **no autovlan disable** command enables the creation and deletion of VLANs caused by VM activity. This is the default setting.

Command Mode

Vmtracer Configuration

Command Syntax

```
autovlan disable
```

```
no autovlan disable
```

```
default autovlan disable
```

Related Commands

- [vmtracer session](#) places the switch in vmtracer configuration mode.

Example

- This command disables dynamic VLAN creation or pruning within the configuration mode VM Tracer session.

```
switch(vmtracer-system_1)#autovlan disable
switch(vmtracer-system_1)#
```

19.6.4.3 password (vmtracer mode)

The **password** command specifies the token that authorizes the username to the vCenter associated with the VM Tracer mode session.

Command Mode

Vmtracer Configuration

Command Syntax

```
password [ENCRYPTION] [password]
```

Parameters

- **ENCRYPTION** encryption level of the password.
 - <no parameter> *password* is a clear-text string.
 - **0** the *password* is a clear-text string. Equivalent to <no parameter>.
 - **7** the *password* is an encrypted string.
- *password* text that authenticates the username.
 - *password* is a clear-text string if ENCRYPTION specifies clear text.
 - *password* is an encrypted string if ENCRYPTION specifies an encrypted string.

Related Commands

- [vmtracer session](#) places the switch in vmtracer configuration mode.

Example

- This command configures *abode* as the clear-text string that authorizes the username *a-switch_01* located at *example.com/sdk*.

```
switch(vmtracer-system_1)#url https://example.com/sdk
switch(vmtracer-system_1)#username a-switch_01
switch(vmtracer-system_1)#password abcde
switch(vmtracer-system_1)#
```

19.6.4.4 password (vmtracer-vxlan mode)

The **password** command specifies the token that authorizes the username on the NSX for vSphere® (NSX-V) server located at the URL configured for the configuration mode VM Tracer. The switch uses this account to access NSX-V information.

The **password** statement is replaced in **running-config** for the configuration mode interface by a subsequent **password** command. The statement is removed by deleting the NSX-V instance through a **no vxlan (vmtracer mode)** command in vmtracer configuration mode.

Command Mode

Vmtracer-vxlan Configuration

Command Syntax

```
password [ENCRYPTION] password
```

Parameters

- ENCRYPTION encryption level of the password.
 - <no parameter> *password* is a clear-text string.
 - **0** the *password* is a clear-text string. Equivalent to <no parameter>.
 - **7** the *password* is an encrypted string.
- *password* text that authorizes the username.
 - *password* is a clear-text string if ENCRYPTION specifies clear text.
 - *password* is an encrypted string if ENCRYPTION specifies an encrypted string.

Related Commands

- **vxlan (vmtracer mode)** places the switch in vmtracer-vxlan configuration mode.

Example

- This command configures 5678 as the clear-text string that authorizes the username admin to the NSX-V located at <https://example.com/sdk>.

```
switch(config)#vmtracer session vnet-1
switch(config-vmtracer-vnet-1)#vxlan
switch(config-vmtracer-vnet-1-vxlan)#url https://example.com/sdk
switch(config-vmtracer-vnet-1-vxlan)#username admin
switch(config-vmtracer-vnet-1-vxlan)#password 5678
switch(config-vmtracer-vnet-1-vxlan)#exit
switch(config-vmtracer-vnet-1)#show active
vmtracer session vnet-1
  allowed-vlan 1-4094
  vxlan
    url https://example.com/sdk
    username admin
    password 7 s2Xq4GSB1YU=
switch(config-vmtracer-vnet-1)#
```

19.6.4.5 show vmtracer all

The `show vmtracer all` command displays VM Tracer data for all switches with the vSphere scope.

Command Mode

EXEC

Command Syntax

```
show vmtracer all
```

Example

- This command displays data for both switches in the vSphere scope.

```
switch>show vmtracer all
Switch : a109(10.10.30.109)
Ethernet49      : 10.102.28.3/10G
  VM Name      VM Adapter      VLAN      Status      State
  ABCD         Network adapter 2  native   Up/--       --

Switch : a164(10.10.30.(172.22.30.164)
Ethernet49      : 10.102.28.3/10G Storage Network/dvUplink1
  VM Name      VM Adapter      VLAN      Status      State
  WXYZ         Network adapter 2  native   Up/--       --
switch>
```

19.6.4.6 show vmtracer interface

The **show vmtracer interface** command displays the VM interfaces (Vnics) that are active on the VM Tracer enabled interface. For each Vnic, the command displays the name of the attached VM, the adapter name, its VLAN, the VM power state, and the presence status of its MAC address in the switch's MAC table.

Command Mode

EXEC

Command Syntax

```
show vmtracer interface [INT_NAME][INFO_LEVEL]
```

Parameters

- **INT_NAME** the interfaces to be configured. Values include:
 - <no parameter> command returns information for all interfaces.
 - **ethernet** *e_range* Ethernet interface range.
 - **port-channel** *p_range* Port Channel interface range.

Valid *e_range* and *p_range* formats include number, number range, or comma-delimited list of numbers and ranges.

- **INFO_LEVEL** specifies information that the command returns.
 - <no parameter> connection parameters and status for VM associated to specified sessions.
 - **detail** connection status and data concerning messages the VM.
 - **host** name of the connected host.

Examples

- This command displays the Vnics connected to all VM Tracer enabled interfaces.

```
switch>show vmtracer interface

Ethernet8 : example.com
  VM Name          VM Adapter      VLAN      Status
  esx3.aristanetworks.com  vmk0           0         Up/Down
  vspheremanagement  Network adapter 1  0         Up/Down

Ethernet15 : example.com
  VM Name          VM Adapter      VLAN      Status
  Openview         Network adapter 1  123      Up/Down
  VmTracerVm       Network adapter 1  123      Down/Down

Ethernet23 : example.com
  VM Name          VM Adapter      VLAN      Status
switch>
```

- This command displays the Vnics connected to the Ethernet 8 interface.

```
switch>show vmtracer interface Ethernet8

Ethernet8 : example.com
  VM Name          VM Adapter      VLAN      Status
  example.com      vmk0           0         Up/Down
  vspheremanagement  Network adapter 1  0         Up/Down
switch>
```

19.6.4.7 show vmtracer session vcenter

The `show vmtracer session vcenter` command displays vCenter information for a specified VM Tracer session.

Command Mode

EXEC

Command Syntax

```
show vmtracer session session_name vcenter [INFO_LEVEL]
```

Parameters

- *session_name* VM Tracer sessions for which the command returns information.
- *INFO_LEVEL* specifies information that the command returns.
 - `<no parameter>` displays connection and status information for the specified vCenter.
 - `detail` displays connection, status, and history information for the specified vCenter.

Examples

- This command displays connection parameters for the vCenter associated to the abcde session.

```
switch>show vmtracer session abcde vcenter

Session          abcde
vCenter URL      https://vmware-vcenter5.1/sdk
username         Administrator
autovlan         enabled
allowed-vlans   1-4094
sessionState     Connected
switch>
```

- This command displays connection parameters and history details from the vCenter associated to the abcde session.

```
switch>show vmtracer session abcde vcenter detail

Session          abcde
vCenter URL      https://vmware-vcenter5.1/sdk
username         Administrator
autovlan         enabled
allowed-vlans   1-4094
SessionState     Connected
lastStateChange  2:46:50 ago
lastMsgSent      Query network hint message
timeOfLastMsg    0:00:20 ago
responseTimeForLastMsg 0.000102301000479
numSuccessfulMsg 998
lastSuccessfulMsg Query network hint message
lastSuccessfulMsgTime 0:00:20 ago
numFailedMsg     0
lastFailedMsg    --
lastFailedMsgTime never
lastErrorCode    --
switch>
```

19.6.4.8 show vmtracer session vsm

The `show vmtracer session vsm` command displays NSX-V information for a specified VM Tracer session.

Command Mode

EXEC

Command Syntax

```
show vmtracer session session_name vsm [INFO_LEVEL]
```

Parameters

- *session_name* VM Tracer sessions for which the command returns information.
- INFO_LEVEL specifies information that the command returns.
 - <no parameter> connection and status information for the specified NSX-V.
 - **detail** connection, status, and history information for the specified NSX-V.

Examples

- This command displays connection parameters for the NSX-V associated to the abcde session.

```
switch>show vmtracer session abcde vsm
```

```
Session          abcde
VShield URL      https://example.com/sdk
username         admin
sessionState     Connected
switch>
```

- This command displays connection parameters and history details from the vShield Manager associated to the abcde session.

```
switch>show vmtracer session abcde vsm detail
```

```
Session          abcde
VShield URL      https://vmware-vshield5.1/
username         admin
SessionState     Connected
LaststateChange  19 days, 23:14:19 ago
LastMsgSent      /api/2.0/vdn/scopes
timeOfLastMsg    1 days, 13:22:09 ago
responseTimeForLastMsg 0.3 sec
numSuccessfulMsg 3649
lastSuccessfulMsg /api/2.0/vdn/scopes
lastSuccessfulMsgTime 0:00:00 ago
numFailedMsg     1
lastFailedMsg    /api/2.0/vdn/config/segments
lastFailedMsgTime 10 days, 1:15:29 ago
lastErrorCode    CURLIE_COULDNT_RESOLVE_HOST - Couldn't
  resolve host
switch>
The given remote host was not resolved.
```

19.6.4.9 show vmtracer session

The **show vmtracer session** command displays vCenter and vShield connection information for a specified VM Tracer session.

Command Mode

EXEC

Command Syntax

```
show vmtracer session [SESSION_LIST]
```

Parameters

- **SESSION_LIST** VM Tracer sessions for which the command returns information.
 - **<no parameter>** all configured VM Tracer sessions.
 - **session_name** name of one VM Tracer session.

Examples

- This command displays connection parameters associated to the abcde session.

```
switch>show vmtracer session abcde
Session abcde
vCenter URL      https://example.com/sdk
username         Administrator
autovlan         enabled
allowed-vlans    1-4094
sessionState     Connected
VShield URL      https://vmware-vshield5.1.xyz.abcde.com
username         admin
sessionState     Connected

switch>
```

19.6.4.10 show vmtracer vm detail

The **show vmtracer vm detail** command displays connection data for VMs interfaces (Vnics) that are accessible to VM Tracer enabled interfaces.

Command Mode

EXEC

Command Syntax

```
show vmtracer vm [VM_LIST] detail
```

Parameters

- **VM_LIST** The virtual machines for which the command displays information. Options include:
 - `<no parameter>` command returns information for all present VMs.
 - `vm_name` command returns information only for specified VM.

Examples

- This command displays connection data for the VMs connected to all VM Tracer enabled interfaces.

```
switch#show vmtracer vm vmcenter1
VM Name  vCenter1 Server App
Interface : Po45
vNIC     : Network adapter 1
MAC      : 00:31:22:8e:b8:41
Portgroup : VM Network
VLAN     : native
Switch   : Switch2
Status   : Down/Down
Host     : 10.22.18.28
Data Center : vcenter-5
switch>
```

- This command displays connection data for the VMs connected to all VM Tracer enabled interfaces.

```
switch>show vmtracer vm detail
VM Name  vCenter1 Server App
Interface : Po45
vNIC     : Network adapter 1
MAC      : 00:31:22:8e:b8:41
Portgroup : VM Network
VLAN     : native
Switch   : Switch2
Status   : Down/Down
Host     : 10.22.18.28
Data Center : vcenter-5

VM Name  vCenter2 Server App
Interface : Po45
vNIC     : vmk0
MAC      : 00:33:23:3c:e1:4e
Portgroup : Management Network
VLAN     : native

switch>
```

19.6.4.11 show vmtracer vm

The `show vmtracer vm` command displays VMs interfaces (Vnics) that are accessible to VM Tracer enabled interfaces. For each active VM, the command displays the name of the VM, its adapter, and the hypervisor to which it connects.

Command Mode

EXEC

Command Syntax

```
show vmtracer [INT_NAME] vm [VM_LIST]
```

Parameters

- `INT_NAME` the interfaces name Values include:
 - `<no parameter>` command returns information for all interfaces.
 - **interface ethernet** `e_range` Ethernet interface range.
 - **interface port-channel** `p_range` Port Channel interface range.

Valid `e_range` and `p_range` formats include a number, number range, or comma-delimited list of numbers and ranges.

- `VM_LIST` The virtual machines for which the command displays information. Options include:
 - `<no parameter>` command returns information for all present VMs.
 - `vm_name` command returns information only for specified VM.

Related Commands

- `show vmtracer vm detail` displays connection information for one or more specified VMs.

Examples

- This command displays the VMs connected to all VM Tracer enabled interfaces.

```
switch>show vmtracer vm
VM Name           Esx Host           Interface  VLAN    Status
vCenter1          172.22.28.8        Po45      native  Down/Down
vCenter2          172.22.28.8        Po45      native  Up/Up
vCenter3          172.22.28.8        Po45      11      Down/Down
vCenter4          172.22.28.8        Po45      native  Down/Down
VMKernel          Po43               native     Up/Up
demo vcenter 5 clone Po43               native     Up/Up
switch>
```

19.6.4.12 show vmtracer vnic counters

The **show vmtracer interface vnic counters** command displays input and output packet counts for VM interfaces (Vnics) that are active on the specified interface or VM.

Command Mode

EXEC

Command Syntax

```
show vmtracer [ENTITY] vnic counters
```

Parameters

- **ENTITY** the virtual machine or interface over which statistics are gathered and displayed.
 - **<no parameter>** command returns information for all active VMs.
 - **interface ethernet *e_range*** Ethernet interface range.
 - **interface port-channel *p_range*** Port Channel interface range.
 - **vm *vm_name*** command returns information for specified VM.

Valid *e_range* and *p_range* formats include a number, number range, or comma-delimited list of numbers and ranges.

Examples

- This command displays the Vnics connected to Ethernet interface 24.

```
switch>show vmtracer interface ethernet 24 vnic counters
Physical Intf: Ethernet24
Host: 10.17.28.8/site1/dvUplink1
VM Name      vNic      Input Pkt/Byte/%      Output Pkt/Byte/%
vCenter1    Network adapter 2    2550/ 187175/ 0.6      6/ 360/ 0.0
vCenter2    Network adapter 2    418615/ 30678024/ 99.4  1904439/ 1145654613/100.0
Summary
switch>
```

19.6.4.13 show vmtracer vxlan segment

The **show vmtracer vxlan segment** command displays information about the VXLAN segments that are managed by the connected NSX for vSphere® (NSX-V).

Command Mode

EXEC

Command Syntax

```
show vmtracer segment ENTITY
```

Parameters

- **ENTITY** specifies the information that the command displays. Options include:
 - **<no parameter>** displays information for VXLAN segments.
 - **pool** displays resource pools available to segments.
 - **pool pool_name** displays connection information about the specified pool.
 - **range** displays the VNI range of the managed segments.

Examples

- This command displays the VXLAN segments managed by the NSX-V.

```
switch>show vmtracer vxlan segment
Name                VNI      Multicast IP      Network Scope
-----
Eng Wire            5002     237.0.0.1         abcde
HR Wire             5000     237.0.0.2         abcde

switch>
```

- This command displays the resource pools available to the VXLANs.

```
switch>show vmtracer vxlan segment pool
Name                Description                Segments
-----
abcde Wire          Spans Cluster 1 and Cluster 2  Eng Wire, HR Wire

switch>
```

- This command displays connection and packet information for the abcde pool.

```
switch>show vmtracer vxlan segment pool abcde
Name:                abcde
Description:         Spans Cluster 1 and Cluster 2
Segments:            Eng Wire, HR Wire

Vxlan Segment  Cluster  Host                VTEP IP                DVS        VLAN  MTU
Eng Wire       Cluster2 test2.example.com      10.168.200.1/24        dvs-test2  200  1600
Eng Wire       Cluster1 test2.example.com      10.168.100.1/24        dvs-test1  100  1600
HR Wire        Cluster1 test2.example.com      10.168.100.1/24        dvs-test1  100  1600
HR Wire        Cluster2 test2.example.com      10.168.200.1/24        dvs-test2  200  1600

switch>
```

- This command displays the VNI range of the VXLAN segments.

```
switch>show vmtracer vxlan segment range

VNI Range                Multicast IP Range
-----
5000 - 5024              237.0.0.1 - 237.0.0.117
```

Name	VNI	Multicast IP	Network Scope
HR Wire	5002	237.0.0.1	abcde
Eng Wire switch>	5000	237.0.0.2	abcde

19.6.4.14 show vmtracer vxlan vm

The **show vmtracer vxlan vm** command displays the VXLAN segments, their VTEP IP numbers, and their VM endpoints that are managed by the connected NSX for vSphere® (NSX-V).

Command Mode

EXEC

Command Syntax

```
show vmtracer vxlan vm
```

Examples

- This command displays the VM endpoints of the VXLAN segments managed by the NSX-V.

```
switch>show vmtracer vxlan vm
Vxlan Segment      VTEP IP           VLAN  VMs
Eng Wire           192.168.200.1/24  200   Eng VM3, Eng VM2
Eng Wire           192.168.100.1/24  100   Eng VM1
HR Wire            192.168.100.1/24  100   HR VM2, HR VM1
HR Wire            192.168.200.1/24  200   --
switch>
```

19.6.4.15 source-interface

The **source-interface** command allows you to connect to a remote vCenter endpoint by using the primary address of the interface as the source IP address. If the interface is not specified, the source IP address is determined by the routing table.

The **no source-interface** and **default source-interface** commands restore default behavior by removing the **source-interface** command from the *running-config*.

Command Mode

Vmtracer Configuration

Command Syntax

```
source-interface [INTERFACE_NAME]
```

```
no source-interface
```

```
default source-interface
```

Parameters

- **INTERFACE_NAME** specifies the interface for which the information is displayed. Options include:
 - **Ethernet** *e_num* specifies the Ethernet interface number.
 - **Loopback** *l_num* specifies the loopback interface number. Value ranges from 0 to 2100.
 - **Management** *m_num* specifies the management interface number. The values are 1 or 2.
 - **Port-Channel** {*lag_num* | *lag_num.sub_num*} specifies the port-channel interface number. Value of interface ranges from 1 to 2000. Value of sub-interface ranges from 1 to 4094.
 - **Tunnel** *tunnel_num* specifies the tunnel interface number. Value ranges from 1 to 255.
 - **UnconnectedEthernet** *port_num* specifies the unconnected Ethernet port number. Value ranges from 1 to 8.
 - **VLAN** *vlan_num* specifies the VLAN interface number. Value ranges from 1 to 4094.

Related Commands

- [vmtracer session](#) places the switch in Vmtracer configuration mode.

Examples

- This command configures VM Tracer to use Ethernet interface 17 to derive the source address for session packets.

```
switch(config)#vmtracer session system_1
switch(config-vmtracer-session-system_1)#source-interface Ethernet 17
switch(config-vmtracer-session-system_1)#
```

- This command configures a loopback interface 0 for VM Tracer session.

```
switch(config)#vmtracer session system_1
switch(config-vmtracer-session-system_1)#source-interface Loopback 0
switch(config-vmtracer-session-system_1)#
```

- This command configures management interface 1 for VM Tracer session.

```
switch(config)#vmtracer session system_1
switch(config-vmtracer-session-system_1)#source-interface management 1
switch(config-vmtracer-session-system_1)#
```

- This command configures port-channel interface 10 for VM Tracer session.

```
switch(config)#vmtracer session system_1
```

```
switch(config-vmtracer-session-system_1)#source-interface port-channel 10
switch(config-vmtracer-session-system_1)#
```

- This command configures tunnel interface 25 for VM Tracer session.

```
switch(config)#vmtracer session system_1
switch(config-vmtracer-session-system_1)#source-interface tunnel 25
switch(config-vmtracer-session-system_1)#
```

- This command configures unconnected Ethernet interface 1 for VM Tracer session.

```
switch(config)#vmtracer session system_1
switch(config-vmtracer-session-system_1)#source-interface unconnected Ethernet 1
switch(config-vmtracer-session-system_1)#
```

- This command configures VLAN interface 25 for VM Tracer session.

```
switch(config)#vmtracer session system_1
switch(config-vmtracer-session-system_1)#source-interface vlan 25
switch(config-vmtracer-session-system_1)#
```

19.6.4.16 url (vmtracer mode)

The `url` command specifies the vCenter server location that is monitored by the session being edited by the current vmtracer mode. The command must reference a fully formed secure url.

Command Mode

Vmtracer Configuration

Command Syntax

```
url url_name
```

Parameters

- *url_name* location of the vCenter server. Valid formats include IP address (dotted decimal notation) and fully qualified domain name.

Related Commands

- `vmtracer session` places the switch in vmtracer configuration mode.

Example

- This command specifies the location of the vCenter monitored by the system_1 VM Tracer session.

```
switch(vmtracer-system_1) #url https://example.com/sdk
switch(vmtracer-system_1) #
```

19.6.4.17 url (vmtracer-vxlan mode)

The `url` command specifies the NSX for vSphere® (NSX-V) server location that is monitored for VXLAN information by the configuration mode VM Tracer session. The command must reference a fully formed secure URL.

The `url` statement is replaced in running-config for the configuration mode session by a subsequent `url` command. The statement is removed by deleting the NSX-V instance through a `no vxlan (vmtracer mode)` command in vmtracer configuration mode.

Command Mode

Vmtracer-vxlan Configuration

Command Syntax

```
url url_name
```

Parameters

- *url_name* location of the NSX-V server. Valid formats include IP address (dotted decimal notation) and fully qualified domain name.

Related Commands

- `vxlan (vmtracer mode)` places the switch in vmtracer-vxlan configuration mode.

Example

- This command configures the location of the NSX-V monitored by the vnet-1 VM Tracer session.

```
switch(config)#vmtracer session vnet-1
switch(config-vmtracer-vnet-1)#vxlan
switch(config-vmtracer-vnet-1-vxlan)#url https://example.com/sdk
switch(config-vmtracer-vnet-1-vxlan)#exit
switch(config-vmtracer-vnet-1)#show active
vmtracer session vnet-1
    allowed-vlan 1-4094
    vxlan
        url https://example.com/sdk
switch(config-vmtracer-vnet-1)#
```

19.6.4.18 username (vmtracer mode)

The **username** command identifies the switch's account name on the vCenter server. The switch uses this user name to access vCenter information.

Command Mode

Vmtracer Configuration

Command Syntax

```
username name_string
```

Parameters

- *name_string* vCenter account user name. Parameter must match the user name configured on the vCenter.

Related Commands

- [vmtracer session](#) places the switch in vmtracer configuration mode.

Example

- This command configures the user name for the vCenter associated with the system_1 session. The session uses this user name to log into the vCenter server.

```
switch(vmtracer-system_1)#username a-switch_01  
switch(vmtracer-system_1)#
```

19.6.4.19 username (vmtracer-vxlan mode)

The **username** command identifies the switch's account name on the NSX for vSphere® (NSX-V) server located at the URL configured for the configuration mode VM Tracer. The switch uses this user name to access NSX-V information.

The **username** statement is replaced in **running-config** for the configuration mode interface by a subsequent **username** command. The statement is removed by deleting the NSX-V instance through a **no vxlan (vmtracer mode)** command in vmtracer configuration mode.

Command Mode

Vmtracer-vxlan Configuration

Command Syntax

```
username name_string
```

Parameters

- *name_string* NSX-V account user name. Parameter must match a user name configured on the NSX-V.

Related Commands

- **vxlan (vmtracer mode)** places the switch in vmtracer-vxlan configuration mode.

Example

- This command configures the user name of admin for the NSX-V located at the URL specified by the URL command.

```
switch(config)#vmtracer session vnet-1
switch(config-vmtracer-vnet-1)#vxlan
switch(config-vmtracer-vnet-1-vxlan)#url https://example.com/sdk
switch(config-vmtracer-vnet-1-vxlan)#username admin
switch(config-vmtracer-vnet-1-vxlan)#exit
switch(config-vmtracer-vnet-1)#show active
vmtracer session vnet-1
  allowed-vlan 1-4094
  vxlan
    url https://example.com/sdk
    username admin
switch(config-vmtracer-vnet-1)#
```

19.6.4.20 vmtracer session

The **vmtracer session** command places the switch in vmtracer mode for the specified session. The command creates a new session or loads an existing session for editing.

A VM Tracer session connects the switch to a vCenter server at a specified location, then downloads data about VMs and vSwitches managed by ESX hosts connected to switch ports. The switch supports a maximum of four VM Tracer sessions.

VM Tracer session parameters are configured in vmtracer mode. Parameters configured in vmtracer mode include the vCenter location and dynamic VLAN usage.

The **no vmtracer session** and **default vmtracer session** commands disable the session and remove its configuration from *running-config*.

Command Mode

Global Configuration

Command Syntax

```
vmtracer session name
no vmtracer session name
default vmtracer session name
```

Parameters

- *name* The label assigned to the VM Tracer session.

Commands Available in vmtracer Configuration Mode

- [allowed-vlan](#)
- [autovlan disable](#)
- [password \(vmtracer mode\)](#)
- [url \(vmtracer mode\)](#)
- [username \(vmtracer mode\)](#)
- [vxlan \(vmtracer mode\)](#)

Examples

- This command enters vmtracer mode for the system_1 session.

```
switch(config)#vmtracer session system_1
switch(vmtracer-system_1)#
```

- This command disables the system_1 VM Tracer session. The system_1 session and all of its parameters are removed from *running-config*.

```
switch(config)#no vmtracer session system_1
switch(config)#
```

19.6.4.21 vmtracer

The **vmtracer** command enables vmtracer mode on the configuration mode interface. Interfaces with vmtracer mode enabled send discovery packets to the connected vSwitch.

The **no vmtracer** and **default vmtracer** commands disable vmtracer mode on the configuration mode interface by removing the corresponding **vmtracer** command from *running-config*.

Command Mode

Interface-Ethernet Configuration Interface-Port-channel Configuration

Command Syntax

```
vmtracer HOST_TYPE
no vmtracer HOST_TYPE
default vmtracer HOST_TYPE
```

Parameters

- **HOST_TYPE** the type of hypervisor that controls the vSwitch to which the interface connects.
 - **vmware-esx** ESX or ESXI hypervisor (VMware).

Examples

- These commands enable vmtracer mode on the Ethernet 3 interface.

```
switch(config)#interface Ethernet 3
switch(config-if-Et3)#vmtracer vmware-esx
switch(config-if-Et3)#
```

- This command disables vmtracer mode on the Ethernet 3 interface.

```
switch(config-if-Et3)#no vmtracer vmware-esx
switch(config-if-Et3)#
```

19.6.4.22 vrf (vmtracer mode)

The **vrf** command allows the switch to communicate with a vCenter server by enabling VmTracer configuration mode. By default, VmTracer is enabled only in the **default vrf** command.

Command Mode

Vmtracer Configuration

Command Syntax

```
vrf vrf_name
```

Parameters

- *vrf_name* specifies information of the corresponding VRF.

Example

- These commands place the VRF *vrf1* in the Vmtracer configuration mode.

```
switch(config)#vmtracer session system_1
switch(config-vmtracer-session-system_1)#vrf vrf1
switch(config-vmtracer-session-system_1)#
```

19.6.4.23 vxlan (vmtracer mode)

The **vxlan** command places the switch in vmtracer-vxlan configuration mode. To monitor VXLAN based VMware configurations, the switch must communicate with a NSX for vSphere® (NSX-V). Vmtracer-vxlan configuration mode specifies the location and user account data that allows the switch to access a NSX-V within the configuration mode vmtracer session. Each VM Tracer session can be associated with one NSX-V instance.

The **no vxlan** and **default interface vxlan** commands delete the NSX-V instance from the configuration mode vmtracer session by removing all vmtracer-vxlan mode commands from **running-config**.

Command Mode

Vmtracer Configuration

Command Syntax

```
vxlan
no vxlan
default vxlan
```

Related Commands

- [vmtracer session](#) places the switch in vmtracer configuration mode.

Commands Available in vmtracer-vxlan Configuration Mode

- [password \(vmtracer mode\)](#)
- [url \(vmtracer mode\)](#)
- [username \(vmtracer mode\)](#)

Example

- These commands create the vShield instance for the VMTracer session named vnet-1.

```
switch(config)#vmtracer session vnet-1
switch(config-vmtracer-vnet-1)#vxlan
switch(config-vmtracer-vnet-1-vxlan)#
```

19.7 MapReduce Tracer

This section describes Arista's implementation of MapReduce Tracer, including configuration instructions and command descriptions. Topics covered by this section include:

- [MapReduce Tracer Introduction](#)
- [MapReduce Tracer Configuration](#)
- [Displaying MapReduce Tracer Results](#)
- [MapReduce Tracer Command Descriptions](#)

19.7.1 MapReduce Tracer Introduction

MapReduce Tracer is a network tool that monitors Hadoop nodes that are directly connected to Arista switches. MapReduce Tracer requires the following:

- Hadoop clusters are deployed with a L3 design.
- The top of rack switch is the default gateway to all attached TaskTracker nodes.
- JobTracker RPC ports do not require authentication.
- Nodes cannot simultaneously belong to multiple Hadoop clusters.

-
- All TaskTrackers within a cluster are accessed through a common HTTP access port.
 - The switch's DNS or static host configuration facilitates TaskTracker name resolution.

Map Reduce Tracer supports these Hadoop releases:

- Apache 0.20.205
- Apache 1.2.1
- Cloudera 3u6
- Cloudera 4.1.3
- Cloudera 4.3.0
- HortonWorks 1.3
- Cloudera 4.5.0

These sections briefly describe Hadoop, Hadoop data structures, and MapReduce Tracer.

19.7.1.1 Hadoop Description

Apache Hadoop is an open-source, Java-based software framework that supports large dataset storage and processing in a distributed computational environment. Hadoop is licensed under Apache License 2.0 and developed through a global community.

Hadoop facilitates application execution on systems composed of thousands of nodes utilizing petabytes of data. Its distributed file system facilitates rapid data transfer among nodes and supports continued operations when individual nodes fail or become inaccessible.

Hadoop Distributed File System (HDFS) is a distributed file-system that stores data on the commodity machines to provide high aggregate bandwidth across the cluster.

19.7.1.2 Hadoop Cluster Structure

A cluster is a group of servers that function as a single system to provide high availability through load balancing and parallel processing. A Hadoop cluster is a type of computational cluster designed for storing and analyzing large amounts of unstructured data in a distributed computing environment.

Typical Hadoop clusters include one master and multiple worker nodes. The master node consists of a TaskTracker, JobTracker, NameNode and DataNode. Worker nodes include a TaskTracker and DataNode.

19.7.1.3 Map Reduce

MapReduce is an algorithm that Hadoop implements to process large datasets by distributing parallel tasks to nodes within a cluster. The MapReduce program includes a Map procedure that filters data and a Reduce procedure that processes the data.

MapReduce manages task and data distribution to cluster nodes such that tasks are executed in parallel, and data transfers between cluster components support redundancy and fault tolerance.

The MapReduce engine consists of one JobTracker and multiple TaskTrackers – all nodes within the Hadoop cluster. The JobTracker receives MapReduce jobs from a client application and manages the completion of these jobs by submitting tasks to available TaskTracker nodes. If a TaskTracker fails to perform the assigned task, the JobTracker reschedules that part of the job to another node.

19.7.1.4 MapReduce Tracer Function

MapReduce Tracer is a feature that tracks and interacts with Hadoop nodes directly connected to Arista switches in a cluster. It communicates with a JobTracker to obtain a list of all nodes in a cluster and then queries JobTracker and TaskTrackers on these nodes for information regarding the jobs they are running and progress of those jobs. This creates a map of TaskTrackers with kinds of jobs they are running. Commands are available to display this data in tables through the CLI and EAPI.

MapReduce Tracer monitors only nodes that connect directly to the switch in L3 networks. Directly connected nodes use the top-of-rack switch as their default gateway and the switch learns ARP entries for these nodes. The list of nodes provided by JobTracker is filtered by tracking ARP entries to remove nodes that are not directly accessible.

MapReduce Tracer creates a database of nodes from the filtered list. After the database is created, the switch queries the JobTracker and TaskTrackers to obtain the following:

- The number of monitored Hadoop nodes.
- The list of monitored nodes, including their IP addresses.
- Jobs that the TaskTrackers are running.
- JobTracker and TaskTracker statistics.

MapReduce Tracer can simultaneously monitor multiple clusters. This means the directly connected TaskTracker nodes can belong to different clusters. A maximum of five clusters are supported per switch.

19.7.2 MapReduce Tracer Configuration

MapReduce Tracer configuration commands are structured into two configuration levels:

- Monitor-hadoop configuration mode is a child of global configuration mode and controls global MapReduce Tracer settings.
- Monitor-hadoop-cluster configuration mode is a child of Monitor-hadoop configuration mode and defines polling configurations that monitor individual Hadoop clusters.

These sections describe MapReduce Tracer configuration processes:

- [MapReduce Tracer Global Configuration](#)
- [Hadoop Cluster Access Configuration](#)
- [MapReduce Tracer Example](#)

MapReduce Tracer functions after it is enabled globally. Each polling configuration can be individually enabled after the feature is enabled globally.

19.7.2.1 MapReduce Tracer Global Configuration

MapReduce Tracer global parameters are configured in Monitor-hadoop configuration mode. Tasks performed from this mode include specifying connection parameters to Hadoop clusters and globally enabling MapReduce Tracer.

Entering Monitor-Hadoop Configuration Mode

Monitor-hadoop configuration mode is entered by `monitor hadoop`. Monitor-hadoop configuration mode is not a group change mode; statements are stored in the *running-config* when they are entered through the CLI. The `exit` command returns the switch to global configuration mode.

Examples

- These commands place the switch in monitor-hadoop configuration mode.

```
switch(config)#monitor hadoop
switch(config-monitor-hadoop)#
```

- This command exits monitor-hadoop mode.

```
switch(config-monitor-hadoop)#exit
switch(config)#
```

- This command deletes all previously configured monitor-hadoop configuration mode commands.

```
switch(config)#no monitor hadoop
switch(config)#
```

Globally Enabling MapReduce Tracer

MapReduce Tracer is globally enabled by the **no** version of the [shutdown \(Monitor-Hadoop\)](#). MapReduce Tracer is globally disabled by default.

Example

These commands globally enable MapReduce Tracer.

```
switch(config)#monitor hadoop
switch(config-monitor-hadoop)#no shutdown
switch(config-monitor-hadoop)#show active
  monitor hadoop
    no shutdown
switch(config-monitor-hadoop)#
```

Creating a Cluster Monitor

A cluster monitor is created by entering monitor-hadoop-cluster mode with [cluster \(Monitor Hadoop\)](#). Each monitor is labeled with a cluster ID and probes one Hadoop cluster. When the command specifies a monitor with a previously defined cluster ID, subsequent commands edit that monitor's parameters. A monitor with a new cluster ID is created by a command that specifies a nonexistent cluster ID.

Example

These commands enter monitor-hadoop-cluster mode to edit a cluster monitor. The monitor's cluster-id is **CL2**.

```
switch(config-monitor-hadoop)#cluster CL2
switch(config-monitor-hadoop-CL2)#show active
monitor hadoop
  cluster CL2
switch(config-monitor-hadoop-CL2)#
```

19.7.2.2 Hadoop Cluster Access Configuration

Cluster monitors are configured in monitor-hadoop-cluster configuration mode. Each monitor corresponds to a hadoop cluster through these configurable parameters:

- JobTracker access parameters (address, port number, and username)
- TaskTracker access port
- Polling interval
- Cluster description
- Enabled setting

The minimum explicit configuration includes JobTracker address and username; default values are defined for all other parameters. By default, cluster monitors are disabled.

The `cluster (Monitor Hadoop)` command places the switch in monitor-hadoop-cluster mode for the specified monitor, where a cluster's connection parameters are specified. Monitor-hadoop-cluster mode is not a group change mode.

A cluster monitor is enabled by using the `no` version of the `shutdown (Monitor-Hadoop)` when MapReduce Tracer is globally enabled.

19.7.2.2.1 JobTracker Configuration

A cluster's JobTracker is located on the master node and schedules work to the cluster's TaskTracker nodes. The `jobtracker (Monitor Hadoop Cluster)` command specifies connection parameters to the monitored cluster.

JobTracker parameters include its node location (IPv4 address or hostname), RPC port, and username. The default RPC port is **8021**. Location and username parameters do not have default values and must be explicitly configured.

Example

For the **CL2** monitor, these commands configure connection parameters to a JobTracker node at **10.4.4.4** with the username **account1**. The default RPC port (8021) is implicitly specified.

```
switch(config)#monitor hadoop
switch(config-monitor-hadoop)#cluster CL2
switch(config-monitor-hadoop-CL2)#jobtracker host 10.4.4.4
username account1
switch(config-monitor-hadoop-CL2)#show active
monitor hadoop
  cluster CL2
    jobtracker host 10.4.4.4 user account1
switch(config-monitor-hadoop-CL2)#
```

19.7.2.2.2 TaskTracker Configuration

The `tasktracker (Monitor Hadoop Cluster)` command specifies the HTTP port that access TaskTrackers of the Hadoop cluster probed by the configuration mode monitor. The switch compiles a list of the cluster's TaskTracker addresses by periodically polling the cluster's JobTracker.

The default TaskTracker HTTP port is **5060**.

Examples

- For the **CL2** monitor, these commands configure a TaskTracker access port of **51000**.

```
switch(config)#monitor hadoop
switch(config-monitor-hadoop)#cluster CL2
switch(config-monitor-hadoop-CL2)#tasktracker http-port 51000
switch(config-monitor-hadoop-CL2)#show active
monitor hadoop
  cluster CL2
    tasktracker http-port 51000
switch(config-monitor-hadoop-CL2)#
```

- These commands restore the default TaskTracker HTTP access port address of **50060**.

```
switch(config-monitor-hadoop-CL2) #no tasktracker http-port
switch(config-monitor-hadoop-CL2) #show active
monitor hadoop
  cluster CL2
switch(config-monitor-hadoop-CL2) #show active all
monitor hadoop
  cluster CL2
  jobtracker rpc-port 8021
  tasktracker http-port 50060
  interval 10
  shutdown
switch(config-monitor-hadoop-CL2) #
```

19.7.2.2.3 Polling Interval Configuration

When the monitor configuration is complete, the switch polls the cluster's JobTracker to maintain the list of active TaskTracker nodes associated with the monitored cluster and compile Hadoop job statistics. The [interval \(Monitor Hadoop Cluster\)](#) command specifies the interval between polls to the JobTracker of the monitored cluster. The default interval is **10** seconds.

Example

This command sets the JobTracker polling interval to **25** seconds for the cluster monitored by the **CL2** MapReduce Tracer configuration.

```
switch(config) #monitor hadoop
switch(config-monitor-hadoop) #cluster CL2
switch(config-monitor-hadoop-CL2) #interval 25
switch(config-monitor-hadoop-CL2) #show active
monitor hadoop
  cluster CL2
  interval 25
switch(config-monitor-hadoop-CL2) #
```

19.7.2.3 MapReduce Tracer Example

The commands in this section create monitors that probe two Hadoop clusters, enables each monitor individually, then enables MapReduce Tracer globally. Monitor parameters for the clusters include:

- Cluster ID: **CL_1**
 - Jobtracker: IP address: **10.15.2.2**; RPC port: **8021**; username: **xyz1**
 - TaskTracker: HTTP address **54000**
 - JobTracker polling interval: **10** seconds (default)
- Cluster ID: **CL_2**
 - Jobtracker: IP address: **10.21.5.2**; RPC port: **9521**; username: **qrst4**
 - TaskTracker: HTTP address **50060** (default)
 - JobTracker polling interval: **5** seconds

Example

```
switch(config) #monitor hadoop
```

```

switch(config-monitor-hadoop)#cluster CL_1

switch(config-monitor-hadoop-CL_1)#jobtracker host 10.15.2.2
username xyz1
switch(config-monitor-hadoop-CL_1)#tasktracker http-port 54000
switch(config-monitor-hadoop-CL_1)#no shutdown
switch(config-monitor-hadoop-CL_1)#exit

switch(config-monitor-hadoop)#cluster CL_2
switch(config-monitor-hadoop-CL_2)#jobtracker host 10.21.5.2 rpc-
port 9521
switch(config-monitor-hadoop-CL_2)#interval 5
switch(config-monitor-hadoop-CL_2)#no shutdown
switch(config-monitor-hadoop-CL_2)#exit

switch(config-monitor-hadoop)#no shutdown
switch(config-monitor-hadoop)#show active
monitor hadoop
no shutdown
cluster CL_1
jobtracker host 10.15.2.2 user xyz1
tasktracker http-port 54000
no shutdown
!
cluster CL_2
jobtracker host 10.21.5.2 rpc-port 9521 user qrst4
interval 5
no shutdown

switch(config-monitor-hadoop)#show active all
monitor hadoop
no shutdown
cluster CL_1
jobtracker host 10.15.2.2 rpc-port 8021 user xyz1
tasktracker http-port 54000
interval 10
no shutdown
!
cluster CL_2
jobtracker host 10.21.5.2 rpc-port 9521 user qrst4
tasktracker http-port 50060
interval 5
no shutdown
switch(config-monitor-hadoop)#exit
switch(config)#

```

19.7.3 Displaying MapReduce Tracer Results

MapReduce Tracer display commands provide information about the configuration and activity on the monitored clusters.

This section contains the following topics:

- [MapReduce Tracer Status](#)
- [Cluster Configuration and Connections](#)
- [Job Lists](#)
- [Job Data](#)
- [TaskTracker Lists](#)
- [TaskTracker Connection and Activity](#)
- [Data Bursts](#)

- [Low-memory Mode](#)

19.7.3.1 MapReduce Tracer Status

MapReduce Tracer status is accessed through [show monitor hadoop status](#). Status information includes the enabled status and the number of monitored clusters, TaskTrackers, and locally running jobs.

Example

This command displays MapReduce Tracer status for all connected clusters and TaskTrackers.

```
switch>show monitor hadoop status

Last updated: 2013-10-06 18:14:23
Mapreduce Tracer status:
  Admin status                : Enabled
  Operational status          : Enabled
  Number of clusters configured : 3
  Number of local TaskTrackers : 4
  Number of jobs running locally : 4

switch>
```

19.7.3.2 Cluster Configuration and Connections

The following cluster configuration and connection information is available through these commands:

- Configuration and connection data for all monitored clusters –[show monitor hadoop cluster all](#).
- Configuration and connection data for a specified cluster –[show monitor hadoop cluster status](#).
- Connection and activity information for TaskTrackers in a specified cluster, on a specified node, or accessed through a specified interface –[show monitor hadoop tasktracker status](#).

Example

This command displays configuration and connection data for the **Cluster0** cluster.

```
switch>show monitor hadoop cluster Cluster0 status

Last updated: 2013-10-06 18:14:23
Cluster status for cluster: Cluster0
  Admin status                : Enabled
  JobTracker host              : host0
  JobTracker RPC port          : 9000
  JobTracker user              : user0
  JobTracker polling interval  : 100 seconds
  TaskTracker HTTP port        : 8800
  Operational status          : Enabled
  Active TaskTrackers          : 31
  Blacklisted TaskTrackers     : 1
  Decommissioned TaskTrackers : 1
  Tracker expiry interval      : 20.0
  Map slots (used/total)       : 10/100
  Reduce slots (used/total)    : 11/110
  JobTracker heap size         : 1.04GB (max: 2.08GB)
```

```
switch>
```

19.7.3.3 Job Lists

The following commands display rosters of currently running job or jobs that previously ran:

- Jobs running on all monitored Hadoop clusters –[show monitor hadoop](#).
- Jobs running on a specified cluster and byte counter data –[show monitor hadoop cluster counters](#).
- Jobs that previously ran on a specified cluster –[show monitor hadoop cluster history](#).
 - Includes jobs that ran since the monitor was enabled, the switch was reloaded, or the job history was cleared –[clear monitor hadoop job-history](#).
- Jobs running on a specified cluster –[show monitor hadoop cluster jobs](#).
- Jobs that ran on all configured clusters is accessed through–[show monitor hadoop history](#).
 - Includes jobs that ran since the monitor was enabled, the switch was reloaded, or the job history was cleared –[clear monitor hadoop job-history](#).
- Jobs running on a specified TaskTracker and byte counter data –[show monitor hadoop tasktracker counters](#)

Examples

- This command displays the jobs that are running on all monitored clusters.

```
switch>show monitor hadoop

Last updated: 2013-10-06 18:14:23
Currently running jobs: 4
JobId   Job Name           Cluster  Maps(#!/%)  Reduces(#!/%)  Start Time
-----
-----
1       ReallyAVeryLon\   Cluster0  2/12.34%    0/13.45%       2013-10-06
17:56:03
      gNameForAJob1

2       ShortName2        Cluster0  2/24.68%    0/26.90%       2013-10-06
17:37:43
510001  ReallyAVeryLon\   Cluster1  2/12.34%    0/13.45%       2013-10-06
17:56:03
      gNameForAJob11

510002  ShortName12       Cluster1  2/24.68%    0/26.90%       2013-10-06
17:37:43

switch>
```

- This command displays data the jobs that previously ran on connected Hadoop clusters.

```
switch>show monitor hadoop history

Job history for all clusters:
JobId  Job Name           Cluster  Start Time  End Time     Bytes In  Bytes
Out
-----
-----
2       AReallyBigHist\   Cluster0  2013-10-06  2013-10-09  26.08GB  13.04GB
      oricalJobName           17:41:03  06:47:43

442     AReallyBigHist\   Cluster1  2013-10-06  2013-10-09  26.08GB  13.04GB
      oricalJobName           17:41:03  06:47:43

442     AReallyBigHist\   Cluster1  2013-10-06  2013-10-09  26.08GB  13.04GB
      oricalJobName           17:41:03  06:47:43
```

```

2      AReallyBigHist\  Cluster0  2013-10-06  2013-10-09  26.08GB  13.04GB
      oricalJobName          17:41:03   06:47:43
441    HistoryJob1     Cluster1  2013-10-06  2013-10-08  26.08GB  13.04GB
          17:57:43   00:31:03
1      HistoryJob1     Cluster0  2013-10-06  2013-10-08  26.08GB  13.04GB
          17:57:43   00:31:03

switch>

```

- This command displays jobs running on cluster **Cluster0** and byte counters for each job.

```

switch>show monitor hadoop cluster Cluster0 counters

Last updated: 2013-10-06 18:14:23
Counters for currently running jobs on cluster: Cluster0
JobId  Job Name          User          Bytes In  Bytes Out  Start Time
-----
2      ShortName2        JobUser2      37.36GB  76.29MB   2013-10-06
17:37:43
1      ReallyAVeryLon\  JobUser1      37.36GB  76.29MB   2013-10-06
17:56:03
      gNameForAJob1

switch>

```

19.7.3.4 Job Data

The following commands display information about jobs that are running or previously ran on monitored clusters. Available data include job identifiers, JobTracker ID, start time, stop time, data consumption, and progress statistics.

- Data consumption, start and stop times, and JobTracker ID for a specific job –[show monitor hadoop cluster history jobs](#).
- Data consumption, start and stop times, priority, JobTracker ID, and progress statistics for a specified job –[show monitor hadoop cluster jobs <job number>](#).
- HDFS (Hadoop Distributed File System) data consumption and and shuffle byte counters for a specified job –[show monitor hadoop cluster jobs counter](#).
- Data through and start time for jobs running on all monitored clusters –[show monitor hadoop counters](#).
- Progress statistics and start times are available for jobs running on specified TaskTracker –[show monitor hadoop tasktracker jobs](#).
- Job progress and byte counts of jobs running on a specified Hadoop cluster –[show monitor hadoop tasktracker running-tasks](#).
- Progress statistics, HDFS data consumption, start time, and progress information for the specified task of a running job –[show monitor hadoop tasktracker running-tasks cluster job task](#).
- Data consumption and start times for jobs running on a specified TaskTracker –[show monitor hadoop tasktracker counters](#).

Examples

- This command displays information about **job 1** that ran on cluster **Cluster0**.

```

switch>show monitor hadoop cluster Cluster0 history job 1

```

```

Job history data for job: HistoryJob1
  Cluster          : Cluster0
  Job Id           : 1
  JT Id           : 201310110013
  User            : HistoryUser1
  Job start time  : 2013-10-06 17:57:43
  Job end time    : 2013-10-08 00:31:03

Per Interface job counters:
Interface          TaskTracker          Bytes In          Bytes Out
-----
Ethernet7         TaskTracker2          26.08GB          13.04GB

switch>

```

- This command displays information about job 1 that is running on cluster **Cluster0**.

```

switch>show monitor hadoop cluster Cluster0 jobs 1

Last updated: 2013-10-06 18:14:23
Information for job: ReallyAVeryLongNameForAJob1 running on
cluster: Cluster0
  Cluster          : Cluster0
  Id               : 1
  Name             : ReallyAVeryLongNameForAJob1
  User             : JobUser1
  Priority         : veryHigh
  Running state    : running
  Number of map tasks : 2
  Number of reduce tasks : 0
  Start time      : 2013-10-06 17:56:03
  Bytes In        : 37.36GB
  Bytes Out       : 76.29MB
  Map Progress    : 12.34%
  Reduce Progress : 13.45%
  Cleanup Progress : 14.56%
  Setup Progress  : 15.67%

switch>

```

- This command displays data for jobs running on **TaskTracker1**.

```

switch>show monitor hadoop tasktracker host TaskTracker1 jobs

Last updated: 2013-10-06 18:14:23
Running job for TaskTracker: TaskTracker1
JobId Job Name          Cluster  Maps(#!/%)  Reduces(#!/%)  Start Time
-----
1      ReallyAVeryLon\    Cluster0  2/12.34%    0/13.45%       2013-10-06
      17:56:03
      gNameForAJob1
2      ShortName2         Cluster0  2/24.68%    0/26.90%       2013-10-06
      17:37:43

switch>

```

19.7.3.5 TaskTracker Lists

These commands display lists of TaskTrackers that are active on monitored clusters:

- TaskTrackers on a specified cluster –[show monitor hadoop cluster tasktracker](#).

- TaskTrackers on all monitored clusters-[show monitor hadoop tasktracker all](#).

Example

This command displays the TaskTrackers on the *Cluster0* cluster.

```
switch>show monitor hadoop cluster Cluster0 tasktracker

Last updated: 2013-10-06 18:14:23
Total 2 TaskTrackers on cluster Cluster0:
Node          IP Address  Interface      Maps  Reduces
-----
TaskTracker1  10.100.0.1  Ethernet7      4     0
TaskTracker2  10.100.0.2  Port-Channel7  4     0

switch>
```

19.7.3.6 TaskTracker Connection and Activity

The following TaskTracker connection and activity data is available through these commands:

- Connection and activity information for TaskTrackers on a specified cluster or accessed through a specified interface –[show monitor hadoop tasktracker status](#).
- Data consumption for TaskTrackers connected to monitored clusters-[show monitor hadoop tasktracker all counters](#).

Example

This command displays connection and activity data for TaskTracker on the *TaskTracker1* node.

```
switch>show monitor hadoop tasktracker host TaskTracker1 status

Last updated: 2013-10-06 18:14:23
TaskTracker      : TaskTracker1
IP Address       : 10.100.0.1
Interface        : Ethernet7
State            : active
Running jobs     : 2
Running tasks    : 4
Map Tasks        : 4
Reduce Tasks     : 0
Total bytes read  : 2.08GB
Total bytes written : 4.24MB

switch>
```

19.7.3.7 Data Bursts

The [show monitor hadoop traffic burst](#) command displays the largest data bursts for jobs running on a specified cluster or accessed through a specified node or interface. A data burst is the data consumed during a polling interval.

Example

This command displays traffic burst data for all running jobs that are accessible through **port channel interface 7**.

```
switch>show monitor hadoop traffic burst interface Port-Channel 7
```

```
Last updated: 2013-10-06 18:14:23
```

```
Bursts on Interface: 'Port-Channel7' in cluster: Cluster0
```

```
Top 2 input bursts:
```

JobId	Job Name	Burst	Time
1	ShortName	3.07GB	2013-10-06 17:57:43
2	ReallyAVeryLon\ gNameForAJob	6.15GB	2013-10-06 17:41:03

```
Top 2 output bursts:
```

JobId	Job Name	Burst	Time
1	ShortName	4.10GB	2013-10-06 17:55:13
2	ReallyAVeryLon\ gNameForAJob	8.20GB	2013-10-06 17:36:03

19.7.3.8 Low-memory Mode

Switch behavior can be improved using the `memory exhaustion` command when the switch gets low on available memory. This low-memory or Out-of-Memory (OOM) state is caused by a number of individual or a combination of factors including the one listed below:

- Memory leaks in EOS or customer user processes.
- Process leaks to too many processes or scripts running at one time.
- Over configuration of the system requiring more memory than available.
- Large number of temporary (tmpfs) files such as logs.
- Large number of CLI sessions.
- Any event or agents that can consume more memory than available in the system.

Once the low-memory state is reached, the system uses the `oom_score`, which depends on the value of the `oom_score_adj` parameter to kill processes to free up available memory. The value for the parameter ranges from -1000 (will not be shut down) to 1000 (will be shut down first) during an OOM state. Non-essential agents are assigned `oom_score_adj` values of 900 or greater.

When enabled, the system implements the following:

- Non-essential agents shut down by Linux are not restarted.
- CLI is restarted, and a message: "Restarting CLI due to memory exhaustion on the system" is sent to all login sessions in the switch.
- CLI Scheduler is disabled.

The system requires manual intervention through `reset system memory exhaustion` command to exit the mode and restart the agents that were shut down.

Configuring Low-memory Mode

The following examples are applicable to all platforms.

Example

These commands configure the low-memory mode.

```
switch(config)#monitor system  
switch(config-monitor-system)#memory exhaustion  
switch(config-monitor-system-memory)#action agent non-critical  
hold-down
```

Example

The following command disables low-memory mode in config-monitor-system-memory.

```
switch(config-monitor-system-memory)#no action agent non-critical  
hold-down
```

The following command exits low-memory mode after an OOM event has occurred and agents have been shut down. The command restarts the agents being held down and reenables the CLI scheduler.

```
switch(config-monitor)#reset system memory exhaustion
```

The `show monitor system` command shows the state of the system with the following information:

- If the feature is enabled.
- If the system is in low-memory mode (featured enabled and system experiencing OOM).
- How many times the system entered low-memory mode.
- Last time the system entered low-memory mode (if applicable).
- Last time the system exited low-memory mode (if applicable).

Example

```
switch#show monitor system
```

The following output is for a system where the feature is disabled and the system has never entered the low-memory mode.

```
Memory Exhaustion Feature enabled: False  
System currently in Memory Exhaustion: False  
Number of times system entered Memory Exhaustion:
```

The following output is for a system where the feature is enabled and the system has never entered the low-memory mode.

```
Memory Exhaustion Feature enabled: True  
System currently in Memory Exhaustion: False  
Number of times system entered Memory Exhaustion: 0
```

The following output is for a system where the feature is enabled and the system enters the low-memory mode.

```
Memory Exhaustion Feature enabled: True  
System currently in Memory Exhaustion: True  
Number of times system entered Memory Exhaustion: 1  
Last time entered in Memory Exhaustion: 0:00:07 ago
```

The following output is for a system where the feature is enabled and the system enters the low-memory mode once, and has exited the low-memory mode.

```
Memory Exhaustion Feature enabled: True
System currently in Memory Exhaustion: False
Number of times system entered Memory Exhaustion: 1
Last time entered in Memory Exhaustion: 0:01:00 ago
Last time exited from Memory Exhaustion: 0:00:05 ago
```

Configuring `oom_score_adj` for a daemon agent

To configure the `oom_score_adj` of any configured daemon, use the following command:

```
switch(config-daemon-<daemon_name>)# oom score adjustment <score>
```



Note: Similar to change the daemon heartbeat value, the new `oom_score_adj` value for the daemon is in effect after restarting the daemon by using `shutdown` command followed by a `no shutdown` command.

```
switch(config)# daemon daemonName
switch(config-daemon-daemonName)# oom score adjustment -200
switch(config-daemon-daemonName)# shutdown
switch(config-daemon-daemonName)# no shutdown
```

19.7.4 MapReduce Tracer Command Descriptions

Global Configuration Commands

- [monitor hadoop](#)

Clear Hadoop Monitor Commands

- [clear monitor hadoop burst-counters](#)
- [clear monitor hadoop job-history](#)

Display Commands

- [show agent oom scores](#)
- [show monitor hadoop](#)
- [show monitor hadoop cluster all](#)
- [show monitor hadoop cluster counters](#)
- [show monitor hadoop cluster history](#)
- [show monitor hadoop cluster history jobs](#)
- [show monitor hadoop cluster jobs](#)
- [show monitor hadoop cluster jobs <job number>](#)
- [show monitor hadoop cluster jobs counter](#)
- [show monitor hadoop cluster status](#)
- [show monitor hadoop cluster tasktracker](#)
- [show monitor hadoop counters](#)
- [show monitor hadoop history](#)
- [show monitor hadoop status](#)
- [show monitor hadoop tasktracker all](#)
- [show monitor hadoop tasktracker all counters](#)
- [show monitor hadoop tasktracker counters](#)
- [show monitor hadoop tasktracker jobs](#)
- [show monitor hadoop tasktracker running-tasks](#)
- [show monitor hadoop tasktracker running-tasks cluster job task](#)
- [show monitor hadoop tasktracker status](#)
- [show monitor hadoop traffic burst](#)
- [show monitor system](#)

Hadoop Commands

- [cluster \(Monitor Hadoop\)](#)
- [shutdown \(Monitor-Hadoop\)](#)

Hadoop-Cluster Commands

- [description \(Monitor Hadoop Cluster\)](#)
- [interval \(Monitor Hadoop Cluster\)](#)
- [jobtracker \(Monitor Hadoop Cluster\)](#)
- [shutdown \(Monitor Hadoop Cluster\)](#)
- [tasktracker \(Monitor Hadoop Cluster\)](#)

19.7.4.1 clear monitor hadoop burst-counters

The `clear monitor hadoop burst-counters` command resets MapReduce Tracer burst counters for all jobs running on specified clusters.

Command Mode

Privileged EXEC

Command Syntax

```
clear monitor hadoop burst-counters [CLUSTERS]
```

Parameters

- **CLUSTERS** Hadoop clusters for which command displays data. Options include:
 - *no parameter* All clusters.
 - **cluster *c_name*** Cluster name.

Example

This command clears the burst counters for all jobs running on **CL2** cluster.

```
switch#clear monitor hadoop burst-counters cluster CL2
Cleared burst counters
switch#
```

19.7.4.2 clear monitor hadoop job-history

The `clear monitor hadoop job-history` command resets the job history database for all specified clusters.

Command Mode

Privileged EXEC

Command Syntax

```
clear monitor hadoop job-history [CLUSTERS]
```

Parameters

- **CLUSTERS** Hadoop clusters for which command displays data. Options include:
 - `<no parameter>` All clusters.
 - `cluster c_name` Cluster name.

Example

This command clears the job history on the **CL2** cluster.

```
switch#clear monitor hadoop job-history cluster CL2
Cleared job history
switch#
```

19.7.4.3 cluster (Monitor Hadoop)

The **cluster** command is a monitor-hadoop command that places the switch in monitor-hadoop-cluster mode for configuring and enabling a MapReduce Tracer monitor for a Hadoop cluster. The command either accesses an existing monitor configuration or creates a monitor.

Monitor-hadoop-cluster configuration mode is not a group change mode; **running-config** is changed immediately upon entering commands. Exiting monitor-hadoop-cluster mode does not affect **running-config**. The **exit** command returns the switch to monitor-hadoop configuration mode.

The configuration mode monitor is enabled by the **no** version of the [shutdown \(Monitor Hadoop Cluster\)](#). Enabling a monitor also requires that MapReduce Tracer is globally enabled ([shutdown \(Monitor Hadoop Cluster\)](#)).

The **no cluster** and **default cluster** commands remove the specified Hadoop cluster configuration from **running-config**.

Command Mode

Monitor-hadoop Configuration

Command Syntax

```
cluster cluster_name
```

```
no cluster cluster_name
```

```
default cluster cluster_name
```

Parameters

- **cluster_name** Hadoop cluster name.

Related Commands

- [monitor hadoop](#) places the switch in monitor-hadoop configuration mode.

Commands Available in Monitor-hadoop-cluster Configuration Mode

- [description \(Monitor Hadoop Cluster\)](#)
- [interval \(Monitor Hadoop Cluster\)](#)
- [jobtracker \(Monitor Hadoop Cluster\)](#)
- [shutdown \(Monitor Hadoop Cluster\)](#)
- [tasktracker \(Monitor Hadoop Cluster\)](#)

Examples

- These commands create the CL2 monitor and enters monitor-hadoop-cluster mode for the monitor.

```
switch(config)#monitor hadoop
switch(config-monitor-hadoop)#cluster CL2
switch(config-monitor-hadoop-CL2)#show active
monitor hadoop
  cluster CL2
switch(config-monitor-hadoop-CL2)#
```

- These commands exit monitor-hadoop-cluster mode.

```
switch(config-monitor-hadoop-CL2)#exit
switch(config-monitor-hadoop)#show active
monitor hadoop
  cluster CL2
switch(config-monitor-hadoop)#
```

-
- These commands remove the CL2 monitor.

```
switch(config-monitor-hadoop)#no cluster CL2  
switch(config-monitor-hadoop)#show active  
switch(config-monitor-hadoop)#
```

19.7.4.4 description (Monitor Hadoop Cluster)

The **description** command adds a text string to the configuration mode MapReduce Tracer cluster monitor. The string has no functional impact on the monitor.

The **no description** and **default description** commands remove the text string from the configuration mode monitor by removing the corresponding **description** command from **running-config**.

Command Mode

Monitor-hadoop-cluster Configuration

Command Syntax

```
description label_text
```

```
no description
```

```
default description
```

Parameters

- **label_text** Character string assigned to the monitor configuration.

Related Commands

- [cluster \(Monitor Hadoop\)](#) places the switch in monitor-hadoop-cluster configuration mode.

Example

These commands add description text to the **CL2** monitor.

```
switch(config)#monitor hadoop
switch(config-monitor-hadoop)#cluster CL2
switch(config-monitor-hadoop-CL2)#description First Cluster
monitor hadoop
  cluster CL2
    description First Cluster
    jobtracker host 10.3.3.3 user JANE
switch(config-monitor-hadoop-CL2)#
```

19.7.4.5 interval (Monitor Hadoop Cluster)

The **interval** command specifies the polling interval between queries to the Hadoop cluster JobTracker specified by configuration mode statements. The switch polls a cluster's JobTracker to update its list of active TaskTracker nodes and the statistics of jobs running in the cluster. This command controls the frequency of these polls. The default interval is 10 seconds.

The **no interval** and **default interval** commands restore the default interval of 10 seconds by removing the **interval** command from *running-config*.

Command Mode

Monitor-hadoop-cluster Configuration

Command Syntax

```
interval period
no interval
default interval
```

Parameters

- **period** Interval (seconds) between JobTracker polls. Value ranges from **1** to **600**. Default is **10**.

Related Commands

- [cluster \(Monitor Hadoop\)](#) places the switch in monitor-hadoop-cluster configuration mode.

Example

This command sets the JobTracker polling interval to **25** seconds for the CL2 cluster configuration.

```
switch(config)#monitor hadoop
switch(config-monitor-hadoop)#cluster CL2
switch(config-monitor-hadoop-CL2)#interval 25
switch(config-monitor-hadoop-CL2)#show active
monitor hadoop
  cluster CL2
    interval 25
switch(config-monitor-hadoop-CL2)#
```

19.7.4.6 jobtracker (Monitor Hadoop Cluster)

The `jobtracker` command specifies JobTracker access parameters for the cluster monitored by configuration mode monitor statements. A cluster's JobTracker is located on the master node and schedules work to the cluster's TaskTracker nodes.

Parameters required to communicate with a JobTracker include its node location (IPv4 address or hostname), RPC port, and username. The default RPC port is 8021. Location and username parameters do not have default values and must be explicitly configured. A JobTracker command that specifies a partial parameter list modifies the existing corresponding `jobtracker` statement in *running-config*.

The `no jobtracker` and `default jobtracker` commands perform the following:

- removes the `jobtracker` statement from *running config* when it lists all command parameters.
- modifies the existing `jobtracker` statement when it lists a subset of command parameters.

Command Mode

Monitor-hadoop-cluster Configuration

Command Syntax

```
jobtracker [LOCATION][PORT][USER]
no jobtracker [LOCATION][PORT][USER]
default jobtracker [LOCATION][USER]
```

All parameters may be placed in any order.

Parameters

- **LOCATION** Address or hostname of JobTracker node. Options include:
 - `<no parameter>` Location remains undefined or unchanged from a previous configuration.
 - `host ipv4_addr` IPv4 address of master (JobTracker) node.
 - `host hostname` Hostname of master (JobTracker) node.
- **PORT** JobTracker RPC port number. Default value is 8021. Options include:
 - `<no parameter>` Port number remains unchanged from previous configuration.
 - `rdp-port port_num` Port number of master (JobTracker) node. Value ranges from 1 to 65535.
- **USER** Username that accesses JobTracker node. Options include:
 - `<no parameter>` Username remains undefined or unchanged from previous configuration.
 - `username name_string` JobTracker username.

Related Commands

- [cluster \(Monitor Hadoop\)](#) places the switch in monitor-hadoop-cluster configuration mode.

Examples

- For the CL2 cluster configuration, these commands establish a connection to the JobTracker node at **10.4.4.4** with the username **account1**. The default RPC port (8021) is implicitly specified.

```
switch(config)#monitor hadoop
switch(config-monitor-hadoop)#cluster CL2
switch(config-monitor-hadoop-CL2)#jobtracker host 10.4.4.4 username
account1
switch(config-monitor-hadoop-CL2)#show active

monitor hadoop
  cluster CL2
    jobtracker host 10.4.4.4 user account1
```

```
switch(config-monitor-hadoop-CL2)#
```

- These commands modify the JobTracker configuration to specify an RPC port of **9000**.

```
switch(config-monitor-hadoop-CL2)#jobtracker rpc-port 9000  
switch(config-monitor-hadoop-CL2)#show active
```

```
monitor hadoop  
  cluster CL2  
    jobtracker host 10.4.4.4 rpc-port 9000 user account1  
switch(config-monitor-hadoop-CL2)#
```

19.7.4.7 monitor hadoop

The `monitor hadoop` command places the switch in monitor-hadoop configuration mode for configuring MapReduce Tracer monitors. A MapReduce Tracer monitor interacts with Hadoop cluster nodes that are directly attached to the switch. Tasks that the switch can perform through this interaction include:

- compile a list of nodes in the cluster.
- compile a list of jobs the nodes are running.
- download progress of the running jobs.

Monitor-hadoop configuration mode is not a group change mode; *running-config* is changed immediately upon entering commands. Exiting monitor-hadoop configuration mode does not affect *running-config*. The `exit` command returns the switch to global configuration mode. MapReduce Tracer is enabled in monitor-hadoop mode through the `no` version of the [shutdown \(Monitor Hadoop Cluster\)](#) command.

The `no monitor hadoop` and `default monitor hadoop` commands delete previously configured `monitor hadoop mode` configuration commands.

Command Mode

Global Configuration

Command Syntax

```
monitor hadoop
```

```
no monitor hadoop
```

```
default monitor hadoop
```

Commands Available in Monitor-hadoop Configuration Mode

- [cluster \(Monitor Hadoop\)](#)
- [shutdown \(Monitor Hadoop Cluster\)](#)

Examples

- These commands place the switch in monitor-hadoop configuration mode.

```
switch(config)#monitor hadoop
switch(config-monitor-hadoop)#
```

- This command exits monitor-hadoop mode.

```
switch(config-monitor-hadoop)#exit
switch(config)#
```

- This command deletes all previously configured monitor-hadoop configuration mode commands.

```
switch(config)#no monitor hadoop
switch(config)#
```

19.7.4.8 show agent oom scores

The `show agent [<agentName>] oom scores` command displays information for each agent if specified.

Command Mode

EXEC

Command Syntax

```
show agent [ agentName] oom scores
```

Parameters

- **Display Values**

- **Agent name** Name(s) of agent(s) - processes.
- **RssAnon** Size of the resident anonymous memory for the given process.
- **VmSize** Current total virtual memory size for the process.
- **Max VmSize** Peak value of total virtual memory for the process.
- **oom_score** Parameter used in determining which process to hold down.
- **oom_score_adj** Parameter used to adjust **oom_score**.

This command displays the information for SNMP and Sysdb.

```
switch#show agent Snmp Sysdb oom scores
Agent Name  RssAnon  VmSize  Max VmSize  oom_score  oom_score_adj
-----
Snmp        34.8MB   536.1MB  541.9MB     911         900
Sysdb       102.3MB  597.5MB  597.5MB     0           -500
```

19.7.4.9 show monitor hadoop cluster all

The **show monitor hadoop cluster all** command displays configuration and connection information for all monitored Hadoop clusters.

Command Mode

EXEC

Command Syntax

```
show monitor hadoop cluster all
```

Example

This command displays configuration and connection data for all connected Hadoop clusters.

```
switch>show monitor hadoop cluster all

Total number of clusters configured: 3
Cluster                : Cluster0
Admin status           : Enabled
JobTracker host        : host0
JobTracker RPC port    : 9000
JobTracker user        : user0
JobTracker polling interval : 100 seconds
TaskTracker HTTP port  : 8800
Operational status     : Enabled
Active TaskTrackers    : 31
Blacklisted TaskTrackers : 1
Decommissioned TaskTrackers : 1
Tracker expiry interval : 20.0
Map slots (used/total) : 10/100
Reduce slots (used/total) : 11/110
JobTracker heap size   : 1.04GB (max: 2.08GB)

Cluster                : Cluster1
Admin status           : Enabled
JobTracker host        : host1
JobTracker RPC port    : 9001
JobTracker user        : user1
JobTracker polling interval : 101 seconds
TaskTracker HTTP port  : 8801
Operational status     : Enabled
Active TaskTrackers    : 32
Blacklisted TaskTrackers : 0
Decommissioned TaskTrackers : 0
Tracker expiry interval : 40.0
Map slots (used/total) : 20/200
Reduce slots (used/total) : 22/220
JobTracker heap size   : 2.09GB (max: 4.15GB)

Cluster                : Cluster2
Admin status           : Disabled
JobTracker host        : host2
JobTracker RPC port    : 9002
JobTracker user        : user2
JobTracker polling interval : 102 seconds
TaskTracker HTTP port  : 8802
Operational status     : Disabled
```

19.7.4.10 show monitor hadoop cluster counters

The `show monitor hadoop cluster counters` command displays a list of jobs running on the specified Hadoop cluster and data consumption associated with these jobs.

Command Mode

EXEC

Command Syntax

```
show monitor hadoop cluster c_name counters
```

Parameters

- ***c_name*** Cluster name.

Example

This command displays jobs running on cluster ***Cluster0***.

```
switch>show monitor hadoop cluster Cluster0 counters

Last updated: 2013-10-06 18:14:23
Counters for currently running jobs on cluster: Cluster0
JobId   Job Name                User Bytes In Bytes   Out Start   Time
-----
2       ShortName2              JobUser2  37.36GB      76.29MB    2013-10-06 17:37:43
1       ReallyAVeryLon\        JobUser1  37.36GB      76.29MB    2013-10-06 17:56:03
        gNameForAJob1

switch>
```

19.7.4.11 show monitor hadoop cluster history jobs

The **show monitor hadoop cluster history jobs** command displays data about the specified job. Hadoop jobs are identified by job number and the cluster that ran the job.

Data that the command returns include job identifiers, JobTracker ID, start and stop times, and data consumption.

Command Mode

EXEC

Command Syntax

```
show monitor hadoop cluster c_name history jobs job_number
```

Parameters

- ***c_name*** Cluster name.
- ***job_number*** Job number. Value ranges from **0** to **2147483647**.

Example

This command displays information about **job 1** that ran on cluster **Cluster0**.

```
switch>show monitor hadoop cluster Cluster0 history job 1

Job history data for job: HistoryJob1
  Cluster           : Cluster0
  Job Id            : 1
  JT Id             : 201310110013
  User              : HistoryUser1
  Job start time    : 2013-10-06 17:57:43
  Job end time      : 2013-10-08 00:31:03

Per Interface job counters:
Interface      TaskTracker  Bytes In      Bytes Out
-----
Ethernet7      TaskTracker2  26.08GB       13.04GB

switch>
```

19.7.4.12 show monitor hadoop cluster history

The `show monitor hadoop cluster history` command displays all jobs that ran on the specified cluster. The list includes all jobs that ran since the switch was reloaded, the job history was cleared ([clear monitor hadoop job-history](#)), or MapReduce Tracer was enabled.

Command Mode

EXEC

Command Syntax

```
show monitor hadoop cluster c_name history
```

Parameters

- ***c_name*** Cluster name.

Example

This command displays the jobs that were ran on the cluster named ***Cluster0***.

```
switch>show monitor hadoop cluster Cluster0 history

Jobs history on cluster: Cluster0
JobId   Job Name                               Start Time   End Time     Bytes In     Bytes Out
-----
2       AReallyBigHist\
        oricalJobName                         2013-10-06  2013-10-09  26.08GB     13.04GB
        17:41:03                               06:47:43
2       AReallyBigHist\
        oricalJobName                         2013-10-06  2013-10-09  26.08GB     13.04GB
        17:41:03                               06:47:43
1       HistoryJob1                             2013-10-06  2013-10-08  26.08GB     13.04GB
        17:57:43                               00:31:03

switch>
```

19.7.4.13 show monitor hadoop cluster jobs counter

The `show monitor hadoop cluster jobs counter` command displays data consumption and progress statistics for the specified job.

Command Mode

EXEC

Command Syntax

```
show monitor hadoop cluster c_name [jobs job_number] counter
```

Parameters

- ***c_name*** Cluster name.
- ***job_number*** Job number. Value ranges from **0** to **2147483647**.

Example

This command displays byte counters for the job named **1** that is running on the cluster named **Cluster0**.

```
switch>show monitor hadoop cluster Cluster0 jobs 1 counters

Last updated: 2013-10-06 18:14:23
Cluster : Cluster0
Job Name : ReallyAVeryLongNameForAJob1
Job Id : 1
Interface          HDFS Bytes Read   HDFS Bytes Written   Reduce Shuffle Bytes
-----
Port-Channel8      4.14GB            8.48MB                12.72MB
Port-Channel9      6.21GB            12.72MB               19.07MB
Ethernet8          3.10GB            6.36MB                9.54MB
Ethernet9          5.17GB            10.60MB               15.89MB
Port-Channel7      2.07GB            4.24MB                6.36MB
Ethernet10         7.24GB            14.83MB               22.25MB
Port-Channel10     8.28GB            16.95MB               25.43MB
Ethernet7          1.03GB            2.12MB                3.18MB

switch>
```

19.7.4.14 show monitor hadoop cluster jobs <job number>

The **show monitor hadoop cluster jobs<job number>** command displays information about the specified job. Hadoop jobs are identified by job ID and the cluster that is running the job.

Data that the command returns include time of update, job identifiers, start times, data consumption, and completion progress.

Command Mode

EXEC

Command Syntax

```
show monitor hadoop cluster c_name [jobs job_number]
```

Parameters

- ***c_name*** Cluster name.
- ***job_number*** Job number. Value ranges from **0** to **2147483647**.

Example

This command displays information about **job 1** that is running on cluster **Cluster0**.

```
switch>show monitor hadoop cluster Cluster0 jobs 1

Last updated: 2013-10-06 18:14:23
Information for job: ReallyAVeryLongNameForAJob1 running on cluster:
Cluster0
Cluster : Cluster0
Id      : 1
Name    : ReallyAVeryLongNameForAJob1
User    : JobUser1
Priority : veryHigh
Running state : running
Number of map tasks : 2
Number of reduce tasks : 0
Start time : 2013-10-06 17:56:03
Bytes In  : 37.36GB
Bytes Out : 76.29MB
Map Progress : 12.34%
Reduce Progress : 13.45%
Cleanup Progress : 14.56%
Setup Progress : 15.67%

switch>
```

19.7.4.15 show monitor hadoop cluster jobs

The `show monitor hadoop cluster jobs` command displays a list of jobs that are running on the specified cluster.

Command Mode

EXEC

Command Syntax

```
show monitor hadoop cluster c_name jobs
```

Parameters

- ***c_name*** Cluster name.

Example

This command displays the list of jobs running on cluster ***Cluster0***.

```
switch>show monitor hadoop cluster Cluster0 jobs

Last updated: 2013-10-06 18:14:23
Currently running jobs on cluster: Cluster0
JobId      Job Name                User           Maps    Reduces    Start Time
-----
2          ShortName2              JobUser2       2       0          2013-10-06 17:37:43
1          ReallyAVeryLon\        JobUser1       2       0          2013-10-06 17:56:03
          gNameForAJob1

switch>
```

19.7.4.16 show monitor hadoop cluster status

The `show monitor hadoop cluster status` command displays configuration and connection information for the specified cluster.

Command Mode

EXEC

Command Syntax

```
show monitor hadoop cluster c_name status
```

Parameters

- ***c_name*** Cluster name.

Example

This command displays configuration and connection data for the **Cluster0** cluster.

```
switch>show monitor hadoop cluster Cluster0 status

Last updated: 2013-10-06 18:14:23
Cluster status for cluster: Cluster0
  Admin status                : Enabled
  JobTracker host             : host0
  JobTracker RPC port         : 9000
  JobTracker user             : user0
  JobTracker polling interval : 100 seconds
  TaskTracker HTTP port       : 8800
  Operational status          : Enabled
  Active TaskTrackers         : 31
  Blacklisted TaskTrackers    : 1
  Decommissioned TaskTrackers : 1
  Tracker expiry interval     : 20.0
  Map slots (used/total)      : 10/100
  Reduce slots (used/total)   : 11/110
  JobTracker heap size        : 1.04GB (max: 2.08GB)

switch>
```

19.7.4.17 show monitor hadoop cluster tasktracker

The `show monitor hadoop cluster tasktracker` command displays a list of TaskTrackers in the specified cluster. The IP address and access interface is included in the table.

Command Mode

EXEC

Command Syntax

```
show monitor hadoop cluster c_name tasktracker
```

Parameters

- ***c_name*** Cluster name.

Example

This command displays the TaskTrackers on the ***Cluster0*** cluster.

```
switch>show monitor hadoop cluster Cluster0 tasktracker

Last updated: 2013-10-06 18:14:23
Total 2 TaskTrackers on cluster Cluster0:
Node           IP Address      Interface        Maps   Reduces
-----
TaskTracker1   10.100.0.1      Ethernet7        4      0
TaskTracker2   10.100.0.2      Port-Channel7    4      0

switch>
```

19.7.4.18 show monitor hadoop counters

The **show monitor hadoop counters** command displays byte counter data for all jobs running on clusters for which MapReduce Tracer is configured.

Command Mode

EXEC

Command Syntax

```
show monitor hadoop counters
```

Example

This command displays byte counter data for all jobs running on clusters that the switch is accessing through MapReduce Tracer.

```
switch>show monitor hadoop counters

Last updated: 2013-10-06 18:14:23
Counters for running jobs:
JobId   Job Name                Cluster   Bytes In   Bytes Out   Start Time
-----
510002  ShortName12             Cluster1  37.36GB    76.29MB    2013-10-06 17:37:43
510001  ReallyAVeryLon\        Cluster1  37.36GB    76.29MB    2013-10-06 17:56:03
        gNameForAJob11
2       ShortName2              Cluster0  37.36GB    76.29MB    2013-10-06 17:37:43
1       ReallyAVeryLon\        Cluster0  37.36GB    76.29MB    2013-10-06 17:56:03
        gNameForAJob1

switch>
```

19.7.4.19 show monitor hadoop history

The `show monitor hadoop history` command displays jobs that ran on clusters for which MapReduce Tracer is configured. The list includes all jobs that ran since the switch was reloaded, MapReduce Tracer was enabled, or the job history was cleared ([clear monitor hadoop job-history](#)).

Command Mode

EXEC

Command Syntax

```
show monitor hadoop history
```

Example

This command displays data that jobs that previously ran on connected Hadoop clusters.

```
switch>show monitor hadoop history

Job history for all clusters:
JobId  Job Name                Cluster  Start Time  End Time  Bytes In  Bytes Out
-----
2      AReallyBigHist\       Cluster0  2013-10-06  2013-10-09  26.08GB  13.04GB
      oricalJobName         17:41:03  06:47:43
442    AReallyBigHist\       Cluster1  2013-10-06  2013-10-09  26.08GB  13.04GB
      oricalJobName         17:41:03  06:47:43
442    AReallyBigHist\       Cluster1  2013-10-06  2013-10-09  26.08GB  13.04GB
      oricalJobName         17:41:03  06:47:43
2      AReallyBigHist\       Cluster0  2013-10-06  2013-10-09  26.08GB  13.04GB
      oricalJobName         17:41:03  06:47:43
441    HistoryJob1           Cluster1  2013-10-06  2013-10-08  26.08GB  13.04GB
      17:57:43             00:31:03
1      HistoryJob1           Cluster0  2013-10-06  2013-10-08  26.08GB  13.04GB
      17:57:43             00:31:03

switch>
```

19.7.4.20 show monitor hadoop status

The `show monitor hadoop status` command displays system status for MapReduce Tracer.

Command Mode

EXEC

Command Syntax

```
show monitor hadoop status
```

Example

This command displays MapReduce Tracer status for all connected clusters and TaskTrackers.

```
switch>show monitor hadoop status
Last updated: 2013-10-06 18:14:23
Mapreduce Tracer status:
  Admin status           : Enabled
  Operational status     : Enabled
  Number of clusters configured : 3
  Number of local TaskTrackers : 4
  Number of jobs running locally : 4

switch>
```

19.7.4.21 show monitor hadoop tasktracker all counters

The **show monitor hadoop tasktracker all counters** command displays byte counters for the TaskTrackers of all monitored Hadoop clusters.

Command Mode

EXEC

Command Syntax

```
show monitor hadoop tasktracker all counters
```

Example

This command displays byte counter data for the TaskTrackers servicing all MapReduce Tracer Hadoop clusters.

```
switch>show monitor hadoop tasktracker all counters

Last updated: 2013-10-06 18:14:23
Counters for all TaskTrackers:
Node           IP Address      Interface        Bytes Read      Bytes Written
-----
TaskTracker1   10.100.0.1      Ethernet7        2.08GB          4.24MB
TaskTracker3   10.100.0.3      Ethernet8        6.23GB          12.72MB
TaskTracker2   10.100.0.2      Port-Channel7    4.15GB          8.48MB
TaskTracker4   10.100.0.4      Port-Channel8    8.30GB          16.95MB

switch>
```

19.7.4.22 show monitor hadoop tasktracker all

The `show monitor hadoop tasktracker all` command displays a list of TaskTrackers that are on all monitored Hadoop clusters.

Command Mode

EXEC

Command Syntax

```
show monitor hadoop tasktracker all
```

Examples

Example

This command displays the TaskTrackers of all monitored clusters that are connected to the switch.

```
switch>show monitor hadoop tasktracker all

Last updated: 2013-10-06 18:14:23
All local TaskTrackers:
Node          Cluster    IP Address  Interface  Maps  Reduces
-----
TaskTracker1  Cluster0   10.100.0.1  Ethernet7   4     0
TaskTracker3  Cluster1   10.100.0.3  Ethernet8   4     0
TaskTracker2  Cluster0   10.100.0.2  Port-Channel7 4     0
TaskTracker4  Cluster1   10.100.0.4  Port-Channel8 4     0

switch>
```

19.7.4.23 show monitor hadoop tasktracker counters

The `show monitor hadoop tasktracker counters` command displays a list of jobs running on the specified TaskTracker and output from byte counters associated with these jobs.

Command Mode

EXEC

Command Syntax

```
show monitor hadoop tasktracker NODES counters
```

Parameters

- **NODES** TaskTracker node access point. Options include:
 - **host *hostname*** Node name.
 - **interface ethernet *e_range*** Ethernet interfaces through which node connects.
 - **interface port-channel *p_range*** Port channel interfaces through which node connects.

Examples

- This command displays the jobs running on the TaskTracker on the **TaskTracker1** node.

```
switch>show monitor hadoop tasktracker host TaskTracker1 counters

Last updated: 2013-10-06 18:14:23
Running job for TaskTracker: TaskTracker1
JobId  Job Name          Cluster  Bytes In  Bytes Out  Start Time
-----
2      ShortName2         Cluster0  37.36GB  76.29MB   2013-10-06 17:37:43
1      ReallyAVeryLon\   Cluster0  37.36GB  76.29MB   2013-10-06 17:56:03
      gNameForAJob1

Note: these counters are derived from Hadoop counters and represent approximate
network bandwidth utilization

switch>
```

- This command displays jobs running on TaskTrackers accessed through Ethernet interfaces **7** and **8**.

```
switch>show monitor hadoop tasktracker interface Ethernet 7,8 counters

Last updated: 2013-10-06 18:14:23
Running job for TaskTracker: TaskTracker3
JobId  Job Name          Cluster  Bytes In  Bytes Out  Start Time
-----
510002 ShortName12       Cluster1  37.36GB  76.29MB   2013-10-06 17:37:43
510001 ReallyAVeryLon\   Cluster1  37.36GB  76.29MB   2013-10-06 17:56:03
      gNameForAJob11

Note: These counters are derived from Hadoop counters and represent approximate
network bandwidth utilization

Running job for TaskTracker: TaskTracker1
JobId  Job Name          Cluster  Bytes In  Bytes Out  Start Time
-----
2      ShortName2         Cluster0  37.36GB  76.29MB   2013-10-06 17:37:43
1      ReallyAVeryLon\   Cluster0  37.36GB  76.29MB   2013-10-06 17:56:03
      gNameForAJob1

Note: these counters are derived from Hadoop counters and represent approximate
network bandwidth utilization

switch>
```

- This command displays jobs running on TaskTrackers accessed through **port channel interface 7**.

```
switch>show monitor hadoop tasktracker interface Port-Channel 7 counters

Last updated: 2013-10-06 18:14:23
```

Running job for TaskTracker: TaskTracker2

JobId	Job Name	Cluster	Bytes In	Bytes Out	Start Time
2	ShortName2	Cluster0	37.36GB	76.29MB	2013-10-06 17:37:43
1	ReallyAVeryLon\ gNameForAJob1	Cluster0	37.36GB	76.29MB	2013-10-06 17:56:03

Note: these counters are derived from Hadoop counters and represent approximate network bandwidth utilization

switch>

19.7.4.24 show monitor hadoop tasktracker jobs

The **show monitor hadoop tasktracker jobs** command displays data about the jobs that are running on TaskTrackers located on the specified node or accessed through the listed interfaces.

Including a cluster parameter filters results to include data only from the cluster polled by the specified monitor.

Command Mode

EXEC

Command Syntax

```
show monitor hadoop tasktracker NODES jobs [CLUSTERS]
```

Parameters

- **NODES** TaskTracker node access point. Options include:
 - **host *hostname*** Node name.
 - **interface ethernet *e_range*** Ethernet interfaces through which node connects.
 - **interface port-channel *p_range*** Port channel interfaces through which node connects.
- **CLUSTERS** Hadoop cluster for which command displays data. Options include:
 - **<no parameter>** TaskTracker on specified **NODE** can be in any cluster.
 - **cluster *c_name*** TaskCluster on specified **NODE** must be in named cluster.

Examples

- This command displays data for jobs running on **TaskTracker1**.

```
switch>show monitor hadoop tasktracker host TaskTracker1 jobs

Last updated: 2013-10-06 18:14:23
Running job for TaskTracker: TaskTracker1
JobId  Job Name                Cluster  Maps(#!/%)  Reduces(#!/%)  Start Time
-----
1      ReallyAVeryLon\         Cluster0  2/12.34%    0/13.45%       2013-10-06 17:56:03
      gNameForAJob1
2      ShortName2              Cluster0  2/24.68%    0/26.90%       2013-10-06 17:37:43

switch>
```

- This command displays data for jobs on TaskTrackers accessed through Ethernet interfaces **7** and **8**.

```
switch>show monitor hadoop tasktracker interface Ethernet 7,8 jobs

Last updated: 2013-10-06 18:14:23
Running job for TaskTracker: TaskTracker3
JobId  Job Name                Cluster  Maps(#!/%)  Reduces(#!/%)  Start Time
-----
510001 ReallyAVeryLon\         Cluster1  2/12.34%    0/13.45%       2013-10-06 17:56:03
      gNameForAJob11
510002 ShortName12              Cluster1  2/24.68%    0/26.90%       2013-10-06 17:37:43

Running job for TaskTracker: TaskTracker1
JobId  Job Name                Cluster  Maps(#!/%)  Reduces(#!/%)  Start Time
-----
1      ReallyAVeryLon\         Cluster0  2/12.34%    0/13.45%       2013-10-06 17:56:03
      gNameForAJob1
2      ShortName2              Cluster0  2/24.68%    0/26.90%       2013-10-06 17:37:43

switch>
```

- This command displays data for jobs on TaskTrackers accessed through **port channel interface 7**.

```
switch>show monitor hadoop tasktracker interface Port-Channel 7 jobs

Last updated: 2013-10-06 18:14:23
Running job for TaskTracker: TaskTracker2
```

```

JobId Job Name Cluster Maps(#!/%) Reduces(#!/%) Start Time
-----
1 ReallyAVeryLon\ Cluster0 2/12.34% 0/13.45% 2013-10-06 17:56:03
  gNameForAJob1
2 ShortName2 Cluster0 2/24.68% 0/26.90% 2013-10-06 17:37:43

switch>

```

- This command displays data for jobs on TaskTrackers on the **Cluster0** cluster that are accessed through Ethernet interfaces **7** and **8**.

```

switch>show monitor hadoop tasktracker interface Ethernet 7,8 jobs cluster Cluster0

Last updated: 2013-10-06 18:14:23
Running job for TaskTracker: TaskTracker1
JobId Job Name Cluster Maps(#!/%) Reduces(#!/%) Start Time
-----
1 ReallyAVeryLon\ Cluster0 2/12.34% 0/13.45% 2013-10-06 17:56:03
  gNameForAJob1
2 ShortName2 Cluster0 2/24.68% 0/26.90% 2013-10-06 17:37:43

switch>

```

- This command displays data for jobs on TaskTracker named **TaskTracker1** on the **Cluster0** cluster.

```

switch>show monitor hadoop tasktracker host TaskTracker1 jobs cluster Cluster0

Last updated: 2013-10-06 18:14:23
Running job for TaskTracker: TaskTracker1
JobId Job Name Cluster Maps(#!/%) Reduces(#!/%) Start Time
-----
1 ReallyAVeryLon\ Cluster0 2/12.34% 0/13.45% 2013-10-06 17:56:03
  gNameForAJob1
2 ShortName2 Cluster0 2/24.68% 0/26.90% 2013-10-06 17:37:43

switch>

```

- This command displays data for jobs on TaskTrackers on the **Cluster0** cluster that are accessed through **port channel interface 7**.

```

switch>show monitor hadoop tasktracker interface Port-Channel 7 jobs cluster Cluster0

Last updated: 2013-10-06 18:14:23
Running job for TaskTracker: TaskTracker2
JobId Job Name Cluster Maps(#!/%) Reduces(#!/%) Start Time
-----
1 ReallyAVeryLon\ Cluster0 2/12.34% 0/13.45% 2013-10-06 17:56:03
  gNameForAJob1
2 ShortName2 Cluster0 2/24.68% 0/26.90% 2013-10-06 17:37:43

switch>

```

19.7.4.25 show monitor hadoop tasktracker running-tasks cluster job task

The `show monitor hadoop tasktracker running-tasks cluster job task` command displays detailed data for the specified task.

Command Mode

EXEC

Command Syntax

```
show monitor hadoop tasktracker NODE [running-tasks cluster name][ job jnum ][task tnum]
```

Parameters

- **NODE** TaskTracker node access point. Options include:
 - **host *hostname*** Node name.
 - **interface ethernet *e_range*** Ethernet interfaces through which node connects.
 - **interface port-channel *p_range*** Port channel interfaces through which node connects.
- ***name*** Cluster name.
- ***jnum*** Job number. Value ranges from **0** to **2147483647**.
- ***tnum*** Task number. Value ranges from **0** to **2147483647**.

Examples

- This command displays data for task 1 of job 1 on **TaskTracker1** of **Cluster0**.

```
switch>show monitor hadoop tasktracker host TaskTracker1 running-tasks
cluster Cluster0 job 1 task 1
```

```
Last updated: 2013-10-06 18:14:23
Task details for one task as given below:
TaskTracker name      : TaskTracker1
Interface              : 'Ethernet7'
Cluster               : Cluster0
Job Id                : 1
Task Id               : 1
Attempt Id            : 0
Task type              : Map
Status                : running
State                 : running
Start time            : 2013-10-06 17:57:43
Progress               : 50.00%
HDFS bytes read       : 1.05MB
HDFS bytes written    : 1.07MB
Reduce shuffle bytes  : 1.48MB
```

```
switch>
```

- This command displays data for **task 1** of **job 1** on the **Cluster0** TaskTracker that is accessible through **Ethernet interface 7**.

```
switch>show monitor hadoop tasktracker interface Ethernet 7 running-
tasks cluster Cluster0 job 1 task 1
```

```
Last updated: 2013-10-06 18:14:23
Task details for one task as given below:
TaskTracker name      : TaskTracker1
Interface              : 'Ethernet7'
Cluster               : Cluster0
Job Id                : 1
Task Id               : 1
Attempt Id            : 0
```

```
Task type      : Map
Status         : running
State          : running
Start time    : 2013-10-06 17:57:43
Progress       : 50.00%
HDFS bytes read : 1.05MB
HDFS bytes written : 1.07MB
Reduce shuffle bytes : 1.48MB
```

```
switch>
```

- This command displays data for **task 111** of **job 510001** on the **Cluster0** TaskTracker that is accessible through **port channel interface 8**.

```
switch>show monitor hadoop tasktracker interface Port-Channel 8
running-tasks cluster Cluster1 job 510001 task 111
```

```
Last updated: 2013-10-06 18:14:23
Task details for one task as given below:
TaskTracker name : TaskTracker4
Interface        : 'Port-Channel8'
Cluster         : Cluster1
Job Id          : 510001
Task Id         : 111
Attempt Id      : 0
Task type       : Map
Status          : running
State           : running
Start time     : 2013-10-06 17:57:43
Progress        : 50.00%
HDFS bytes read : 1.05MB
HDFS bytes written : 1.07MB
Reduce shuffle bytes : 1.48MB
```

```
switch>
```

19.7.4.26 show monitor hadoop tasktracker running-tasks

The `show monitor hadoop tasktracker running-tasks` command displays progress and byte counts of tasks executed by TaskTrackers located on the specified node or accessed through the listed interfaces.

Including a cluster-ID parameter filters results to include data only from the specified cluster.

Command Mode

EXEC

Command Syntax

```
show monitor hadoop tasktracker NODES running-tasks [CLUSTERS][JOBS]
```

Parameters

- **NODES** TaskTracker node access point. Options include:
 - **host *hostname*** Node name.
 - **interface ethernet *e_range*** Ethernet interfaces through which node connects.
 - **interface port-channel *p_range*** Port channel interfaces through which node connects.
- **CLUSTERS** Hadoop cluster for which command displays data. Options include:
 - **<no parameter>** TaskTracker on specified **NODE** can be in any cluster.
 - **cluster *c_name*** TaskCluster on specified **NODE** must be in named cluster.
- **JOBS** Job list. Options include:
 - **<no parameter>** all jobs.
 - **job <0 to 2147483647>** Specifies number of single job.

Examples

- This command displays data for tasks running on TaskTracker named **TaskTracker1**.

```
switch>show monitor hadoop tasktracker host TaskTracker1 running-tasks

Last updated: 2013-10-06 18:14:23
Running tasks for TaskTracker: TaskTracker1 on interface Ethernet7
JobId TaskId Cluster Type Progress Status HDFS Read HDFS Write Shuffle
-----
1 2 Cluster0 Map 33.33% running 2.10MB 2.14MB 2.96MB
2 2 Cluster0 Map 33.33% running 2.10MB 2.14MB 2.96MB
1 1 Cluster0 Map 50.00% running 1.05MB 1.07MB 1.48MB
2 1 Cluster0 Map 50.00% running 1.05MB 1.07MB 1.48MB

switch>
```

- This command displays data for tasks running on the TaskTracker named **TaskTracker1** of the **Cluster0** cluster.

```
switch>show monitor hadoop tasktracker host TaskTracker1 running-tasks cluster
Cluster0

Last updated: 2013-10-06 18:14:23
Running tasks for TaskTracker: TaskTracker1 on interface Ethernet7
JobId TaskId Cluster Type Progress Status HDFS Read HDFS Write Shuffle
-----
1 2 Cluster0 Map 33.33% running 2.10MB 2.14MB 2.96MB
2 2 Cluster0 Map 33.33% running 2.10MB 2.14MB 2.96MB
1 1 Cluster0 Map 50.00% running 1.05MB 1.07MB 1.48MB
2 1 Cluster0 Map 50.00% running 1.05MB 1.07MB 1.48MB

switch>
```

- This command displays data for tasks running for job **1** on the TaskTracker named **TaskTracker1** of the **Cluster0** cluster.

```
switch>show monitor hadoop tasktracker host TaskTracker1 running-tasks cluster
```

Cluster0 job 1

```
Last updated: 2013-10-06 18:14:23
Running tasks for TaskTracker: TaskTracker1 on interface Ethernet7
JobId TaskId Cluster Type Progress Status HDFS Read HDFS Write Shuffle
-----
1 2 Cluster0 Map 33.33% running 2.10MB 2.14MB 2.96MB
1 1 Cluster0 Map 50.00% running 1.05MB 1.07MB 1.48MB

switch>
```

- This command displays data for tasks running on TaskTrackers accessed through Ethernet interfaces **7** and **8**.

```
switch>show monitor hadoop tasktracker interface Ethernet 7,8 running-tasks

Last updated: 2013-10-06 18:14:23
Running tasks for TaskTracker: TaskTracker1 on interface Ethernet7
JobId TaskId Cluster Type Progress Status HDFS Read HDFS Write Shuffle
-----
2 2 Cluster0 Map 33.33% running 2.10MB 2.14MB 2.96MB
1 1 Cluster0 Map 50.00% running 1.05MB 1.07MB 1.48MB
2 1 Cluster0 Map 50.00% running 1.05MB 1.07MB 1.48MB

Running tasks for TaskTracker: TaskTracker3 on interface Ethernet8
JobId TaskId Cluster Type Progress Status HDFS Read HDFS Write Shuffle
-----
510002 222 Cluster1 Map 33.33% running 2.10MB 2.14MB 2.96MB
510001 112 Cluster1 Map 33.33% running 2.10MB 2.14MB 2.96MB
510002 221 Cluster1 Map 50.00% running 1.05MB 1.07MB 1.48MB
510001 111 Cluster1 Map 50.00% running 1.05MB 1.07MB 1.48MB

switch>
```

- This command displays data for tasks running on TaskTrackers of **Cluster0** cluster that are accessed through Ethernet interfaces **7** and **8**.

```
switch>show monitor hadoop tasktracker interface Ethernet 7,8 running-tasks
cluster Cluster0

Last updated: 2013-10-06 18:14:23
Running tasks for TaskTracker: TaskTracker1 on interface Ethernet7
JobId TaskId Cluster Type Progress Status HDFS Read HDFS Write Shuffle
-----
1 2 Cluster0 Map 33.33% running 2.10MB 2.14MB 2.96MB
2 2 Cluster0 Map 33.33% running 2.10MB 2.14MB 2.96MB
1 1 Cluster0 Map 50.00% running 1.05MB 1.07MB 1.48MB
2 1 Cluster0 Map 50.00% running 1.05MB 1.07MB 1.48MB

switch>
```

- This command displays data for tasks running for **job 1** on the TaskTrackers of **Cluster0** cluster that are accessed through Ethernet interfaces **7** and **8**

```
switch>show monitor hadoop tasktracker interface Ethernet 7,8 running-tasks
cluster Cluster0 job 1

Last updated: 2013-10-06 18:14:23
Running tasks for TaskTracker: TaskTracker1 on interface Ethernet7
JobId TaskId Cluster Type Progress Status HDFS Read HDFS Write Shuffle
-----
1 2 Cluster0 Map 33.33% running 2.10MB 2.14MB 2.96MB
1 1 Cluster0 Map 50.00% running 1.05MB 1.07MB 1.48MB

switch>
```

- This command displays data for tasks running on TaskTrackers accessed through **port channel** interfaces **7** and **8**.

```
switch>show monitor hadoop tasktracker interface Port-Channel 7-8 running-tasks

Last updated: 2013-10-06 18:14:23
Running tasks for TaskTracker: TaskTracker2 on interface Port-Channel17
JobId TaskId Cluster Type Progress Status HDFS Read HDFS Write Shuffle
-----
```

```

1      2      Cluster0 Map 33.33% running 2.10MB 2.14MB 2.96MB
1      1      Cluster0 Map 50.00% running 1.05MB 1.07MB 1.48MB
2      1      Cluster0 Map 50.00% running 1.05MB 1.07MB 1.48MB

Running tasks for TaskTracker: TaskTracker4 on interface Port-Channel8
JobId  TaskId Cluster  Type  Progress  Status  HDFS Read  HDFS Write  Shuffle
-----
510002 222   Cluster1 Map 33.33% running 2.10MB 2.14MB 2.96MB
510001 112   Cluster1 Map 33.33% running 2.10MB 2.14MB 2.96MB
510001 111   Cluster1 Map 50.00% running 1.05MB 1.07MB 1.48MB

switch>

```

- This command displays data for tasks running on TaskTrackers of **Cluster0** cluster accessed through **port channel interface 7**.

```

switch>show monitor hadoop tasktracker interface Port-Channel 7 running-tasks
cluster Cluster0

Last updated: 2013-10-06 18:14:23
Running tasks for TaskTracker: TaskTracker2 on interface Port-Channel7
JobId  TaskId Cluster  Type  Progress  Status  HDFS Read  HDFS Write  Shuffle
-----
1      2      Cluster0 Map 33.33% running 2.10MB 2.14MB 2.96MB
1      1      Cluster0 Map 50.00% running 1.05MB 1.07MB 1.48MB
2      1      Cluster0 Map 50.00% running 1.05MB 1.07MB 1.48MB

switch>

```

- This command displays data for **job 510001** running on TaskTrackers of **Cluster1** cluster that are accessed through **port channel interface 8**.

```

switch>show monitor hadoop tasktracker interface Port-Channel 8 running-tasks
cluster Cluster1 job 510001

Last updated: 2013-10-06 18:14:23
Running tasks for TaskTracker: TaskTracker4 on interface Port-Channel8
JobId  TaskId Cluster  Type  Progress  Status  HDFS Read  HDFS Write  Shuffle
-----
510001 112   Cluster1 Map 33.33% running 2.10MB 2.14MB 2.96MB
510001 111   Cluster1 Map 50.00% running 1.05MB 1.07MB 1.48MB

switch>

```

19.7.4.27 show monitor hadoop tasktracker status

The **show monitor hadoop tasktracker status** command displays connection and activity information for the TaskTracker on the specified clusters or accessed through the specified interface. The following command formats display the listed TaskTracker information:

- **show monitor hadoop cluster *c_name* tasktracker status**: TaskTrackers on specified cluster.
- **show monitor hadoop tasktracker *node* status**: TaskTrackers on specified nodes or interfaces.
- **show monitor hadoop tasktracker all status**: all connected TaskTrackers.

Command Mode

EXEC

Command Syntax

```
show monitor hadoop cluster c_name tasktracker status
```

```
show monitor hadoop tasktracker NODES status
```

```
show monitor hadoop tasktracker all status
```

Parameters

- *c_name* Cluster name.
- **NODES** TaskTracker node access point. Options include:
 - **host *hostname*** Node name.
 - **interface ethernet *e_range*** Ethernet interfaces through which node connects.
 - **interface port-channel *p_range*** Port channel interfaces through which node connects.

Examples

- This command displays connection and activity information for all TaskTrackers connected through Ethernet interfaces 7 and 8.

```
switch>show monitor hadoop tasktracker interface Ethernet7,8 status
```

```
Last updated: 2013-10-06 18:14:23
TaskTracker      : TaskTracker1
IP Address       : 10.100.0.1
Interface        : Ethernet7
State            : active
Running jobs     : 2
Running tasks    : 4
Map Tasks        : 4
Reduce Tasks     : 0
Total bytes read : 2.08GB
Total bytes written : 4.24MB
TaskTracker      : TaskTracker3
IP Address       : 10.100.0.3
Interface        : Ethernet8
State            : active
Running jobs     : 2
Running tasks    : 4
Map Tasks        : 4
Reduce Tasks     : 0
Total bytes read : 6.23GB
Total bytes written : 12.72MB
```

```
switch>
```

- This command displays connection and activity information for all connected TaskTrackers.

```
switch>show monitor hadoop tasktracker all status
```

```
Last updated: 2013-10-06 18:14:23
```

```
All local TaskTrackers:
```

```
TaskTracker      : TaskTracker4
IP Address       : 10.100.0.4
Interface        : Port-Channel8
State            : active
Running jobs     : 2
Running tasks    : 4
Map Tasks        : 4
Reduce Tasks     : 0
Total bytes read : 8.30GB
Total bytes written : 16.95MB
```

```
TaskTracker      : TaskTracker3
IP Address       : 10.100.0.3
Interface        : Ethernet8
State            : active
Running jobs     : 2
Running tasks    : 4
Map Tasks        : 4
Reduce Tasks     : 0
Total bytes read : 6.23GB
Total bytes written : 12.72MB
```

```
TaskTracker      : TaskTracker2
IP Address       : 10.100.0.2
Interface        : Port-Channel7
State            : active
Running jobs     : 2
Running tasks    : 4
Map Tasks        : 4
Reduce Tasks     : 0
Total bytes read : 4.15GB
Total bytes written : 8.48MB
```

```
TaskTracker      : TaskTracker1
IP Address       : 10.100.0.1
Interface        : Ethernet7
State            : active
Running jobs     : 2
Running tasks    : 4
Map Tasks        : 4
Reduce Tasks     : 0
Total bytes read : 2.08GB
Total bytes written : 4.24MB
```

```
switch>
```

- This command displays connection and activity data for TaskTracker on the **TaskTracker1** node.

```
switch>show monitor hadoop tasktracker host TaskTracker1 status
```

```
Last updated: 2013-10-06 18:14:23
```

```
TaskTracker      : TaskTracker1
IP Address       : 10.100.0.1
Interface        : Ethernet7
State            : active
Running jobs     : 2
Running tasks    : 4
```

```
Map Tasks           : 4
Reduce Tasks        : 0
Total bytes read    : 2.08GB
Total bytes written : 4.24MB
```

```
switch>
```

- This command displays connection and activity data for all TaskTracker connected through **Port Channel 7**.

```
switch>show monitor hadoop tasktracker interface Port-Channel 7 status
```

```
Last updated: 2013-10-06 18:14:23
TaskTracker      : TaskTracker2
IP Address       : 10.100.0.2
Interface        : Port-Channel17
State            : active
Running jobs     : 2
Running tasks    : 4
Map Tasks        : 4
Reduce Tasks     : 0
Total bytes read : 4.15GB
Total bytes written : 8.48MB
```

```
switch>
```

19.7.4.28 show monitor hadoop traffic burst

The **show monitor hadoop traffic burst** command displays the largest data bursts for specified Hadoop cluster jobs. A data burst is the data consumed during a polling interval. The command displays input and output burst:

- Input bursts include bytes written to the host.
- Output bursts include bytes written by the host.

Command Mode

EXEC

Command Syntax

```
show monitor hadoop [CLUSTERS] traffic burst [NODE]
```

Parameters

- **CLUSTERS** Hadoop clusters for which command displays data. Options include:
 - **<no parameter>** All clusters.
 - **cluster c_name** Cluster name.
- **NODES** TaskTracker node access point. Options include:
 - **host hostname** Node name.
 - **interface ethernet e_range** Ethernet interfaces through which node connects.
 - **interface port-channel p_range** Port channel interfaces through which node connects.

Examples

- This command displays traffic burst data for all running jobs.

```
switch>show monitor hadoop traffic burst
Last updated: 2013-10-06 18:14:23
Bursts on Interface: 'Ethernet7' in cluster: Cluster0
Top 2 input bursts:
JobId  Job Name                Burst      Time
-----
1      ShortName                3.07GB    2013-10-06 17:57:43
2      ReallyAVeryLon\         6.15GB    2013-10-06 17:41:03
      gNameForAJob
Top 2 output bursts:
JobId  Job Name                Burst      Time
-----
1      ShortName                4.10GB    2013-10-06 17:55:13
2      ReallyAVeryLon\         8.20GB    2013-10-06 17:36:03
      gNameForAJob
Bursts on Interface: 'Port-Channel7' in cluster: Cluster0
Top 2 input bursts:
JobId  Job Name                Burst      Time
-----
1      ShortName                3.07GB    2013-10-06 17:57:43
2      ReallyAVeryLon\         6.15GB    2013-10-06 17:41:03
      gNameForAJob
Top 2 output bursts:
JobId  Job Name                Burst      Time
-----
1      ShortName                4.10GB    2013-10-06 17:55:13
2      ReallyAVeryLon\         8.20GB    2013-10-06 17:36:03
      gNameForAJob
Bursts on Interface: 'Ethernet8' in cluster: Cluster1
Top 4 input bursts:
JobId  Job Name                Burst      Time
-----
```

```

510001 ShortName 3.07GB 2013-10-06 17:57:43
510002 ReallyAVeryLon\ 6.15GB 2013-10-06 17:41:03
      gNameForAJob
510003 ShortName 9.22GB 2013-10-06 17:24:23
510004 ReallyAVeryLon\ 12.29GB 2013-10-06 17:07:43
      gNameForAJob
Top 4 output bursts:
JobId Job Name Burst Time
-----
510001 ShortName 4.10GB 2013-10-06 17:55:13
510002 ReallyAVeryLon\ 8.20GB 2013-10-06 17:36:03
      gNameForAJob
510003 ShortName 12.29GB 2013-10-06 17:16:53
510004 ReallyAVeryLon\ 16.39GB 2013-10-06 16:57:43
      gNameForAJob
Bursts on Interface: 'Port-Channel8' in cluster: Cluster1
Top 4 input bursts:
JobId Job Name Burst Time
-----
3101
510001 ShortName 3.07GB 2013-10-06 17:57:43
510002 ReallyAVeryLon\ 6.15GB 2013-10-06 17:41:03
      gNameForAJob
510003 ShortName 9.22GB 2013-10-06 17:24:23
510004 ReallyAVeryLon\ 12.29GB 2013-10-06 17:07:43
      gNameForAJob
Top 4 output bursts:
JobId Job Name Burst Time
-----
510001 ShortName 4.10GB 2013-10-06 17:55:13
510002 ReallyAVeryLon\ 8.20GB 2013-10-06 17:36:03
      gNameForAJob
510003 ShortName 12.29GB 2013-10-06 17:16:53
510004 ReallyAVeryLon\ 16.39GB 2013-10-06 16:57:43
      gNameForAJob
switch>

```

- This command displays traffic burst for all jobs running on TaskTrackers that are accessible through Ethernet interfaces **7** and **8**.

```

switch>show monitor hadoop traffic burst interface Ethernet 7,8

Last updated: 2013-10-06 18:14:23
Bursts on Interface: 'Ethernet7' in cluster: Cluster0
Top 2 input bursts:
JobId Job Name Burst Time
-----
1 ShortName 3.07GB 2013-10-06 17:57:43
2 ReallyAVeryLon\ 6.15GB 2013-10-06 17:41:03
  gNameForAJob
Top 2 output bursts:
JobId Job Name Burst Time
-----
1 ShortName 4.10GB 2013-10-06 17:55:13
2 ReallyAVeryLon\ 8.20GB 2013-10-06 17:36:03
  gNameForAJob
Bursts on Interface: 'Ethernet8' in cluster: Cluster1
Top 4 input bursts:
JobId Job Name Burst Time
-----
510001 ShortName 3.07GB 2013-10-06 17:57:43
510002 ReallyAVeryLon\ 6.15GB 2013-10-06 17:41:03
      gNameForAJob

```

```

510003 ShortName          9.22GB  2013-10-06 17:24:23
510004 ReallyAVeryLon\   12.29GB 2013-10-06 17:07:43
      gNameForAJob
Top 4 output bursts:
JobId  Job Name                Burst    Time
-----
510001 ShortName                4.10GB  2013-10-06 17:55:13
510002 ReallyAVeryLon\    8.20GB  2013-10-06 17:36:03
      gNameForAJob
510003 ShortName                12.29GB 2013-10-06 17:16:53
510004 ReallyAVeryLon\  16.39GB 2013-10-06 16:57:43
      gNameForAJob
switch>

```

- This command displays traffic burst data for all running jobs that are accessible through **port channel interface 7**.

```

switch>show monitor hadoop traffic burst interface Port-Channel 7

Last updated: 2013-10-06 18:14:23
Bursts on Interface: 'Port-Channel7' in cluster: Cluster0
Top 2 input bursts:
JobId  Job Name                Burst    Time
-----
1      ShortName                3.07GB  2013-10-06 17:57:43
2      ReallyAVeryLon\        6.15GB  2013-10-06 17:41:03
      gNameForAJob
Top 2 output bursts:
JobId  Job Name                Burst    Time
-----
1      ShortName                4.10GB  2013-10-06 17:55:13
2      ReallyAVeryLon\        8.20GB  2013-10-06 17:36:03
      gNameForAJob

```

19.7.4.29 show monitor hadoop

The `show monitor hadoop` command displays a list of jobs that are running on all monitored Hadoop clusters.

Command Mode

EXEC

Command Syntax

```
show monitor hadoop
```

Example

This command displays the jobs that are running on all monitored clusters.

```
switch>show monitor hadoop

Last updated: 2013-10-06 18:14:23
Currently running jobs: 4
JobId  Job Name                Cluster  Maps (#/%)  Reduces (#/%)  Start Time
-----
1      ReallyAVeryLon\         Cluster0  2/12.34%    0/13.45%       2013-10-06 17:56:03
      gNameForAJob1
2      ShortName2              Cluster0  2/24.68%    0/26.90%       2013-10-06 17:37:43
510001 ReallyAVeryLon\         Cluster1  2/12.34%    0/13.45%       2013-10-06 17:56:03
      gNameForAJob11
510002 ShortName12             Cluster1  2/24.68%    0/26.90%       2013-10-06 17:37:43

switch>
```

19.7.4.30 show monitor system

The **show monitor system** command displays information about the memory usage status of the system including when low-memory situations have led to out-of-memory (OOM) events.

Command Mode

EXEC

Command Syntax

```
show monitor system
```

`show monitor system` command displays the information for the current state of the system.

Parameters

- <no parameter> state of the system.

The following output is for a system where the feature is disabled and the system has never entered the low-memory mode.

```
Memory Exhaustion Feature enabled: False
System currently in Memory Exhaustion: False
Number of times system entered Memory Exhaustion: 0
```

The following output is for a system where the feature is enabled and the system has never entered the low-memory mode.

```
Memory Exhaustion Feature enabled: True
System currently in Memory Exhaustion: False
Number of times system entered Memory Exhaustion: 0
```

The following output is for a system where the feature is enabled and the system enters the low-memory mode.

```
Memory Exhaustion Feature enabled: True
System currently in Memory Exhaustion: True
Number of times system entered Memory Exhaustion: 1
Last time entered in Memory Exhaustion: 0:00:07 ago
```

The following output is for a system where the feature is enabled and the system enters the low-memory mode once, and has exited the low-memory mode.

```
Memory Exhaustion Feature enabled: True
System currently in Memory Exhaustion: False
Last time entered in Memory Exhaustion: 0:01:00 ago
Last time exited from Memory Exhaustion: 0:00:05 ago
```

19.7.4.31 shutdown (Monitor Hadoop Cluster)

The **shutdown** command disables MapReduce Tracer for the configuration mode cluster. Globally disabling MapReduce Tracer ([show monitor hadoop](#)) also disables the function on the individual cluster. Enabling MapReduce Tracer for the cluster requires the function to be enabled globally and for the individual cluster.

The **no shutdown** command configures the MapReduce Tracer setting as **enabled** for the configuration mode cluster. The **shutdown** and **default shutdown** commands disable MapReduce Tracer for the cluster by removing the corresponding **no shutdown** command from *running-config*.

Command Mode

Monitor-hadoop-cluster Configuration

Command Syntax

```
shutdown
```

```
no shutdown
```

```
default shutdown
```

Related Commands

- [cluster \(Monitor Hadoop\)](#) places the switch in monitor-hadoop-cluster configuration mode.

Example

- These commands globally enable MapReduce Tracer, then enables it for the **CL2** cluster.

```
switch(config)#monitor hadoop
switch(config-monitor-hadoop)#no shutdown
switch(config-monitor-hadoop)#cluster CL2
switch(config-monitor-hadoop-CL2)#no shutdown
switch(config-monitor-hadoop-CL2)#show active
monitor hadoop
  cluster CL2
    no shutdown
switch(config-monitor-hadoop-CL2)#exit
switch(config-monitor-hadoop)#show active
monitor hadoop
  no shutdown
  cluster CL2
    no shutdown
switch(config-monitor-hadoop)#
```

- These commands disable MapReduce Tracer for the **CL2** cluster. MapReduce Tracer remains globally enabled.

```
switch(config-monitor-hadoop)#cluster CL2
switch(config-monitor-hadoop-CL2)#shutdown
switch(config-monitor-hadoop-CL2)#show active
monitor hadoop
  cluster CL2
switch(config-monitor-hadoop-CL2)#exit
switch(config-monitor-hadoop)#show active
monitor hadoop
  no shutdown
  cluster CL2
switch(config-monitor-hadoop)#
```

19.7.4.32 shutdown (Monitor-Hadoop)

The **shutdown** command globally disables MapReduce Tracer on the switch. Enabling MapReduce Tracer for an individual cluster requires the feature to be globally enabled through this command and enabled for the individual cluster through the [shutdown \(Monitor Hadoop Cluster\)](#) command. By default, MapReduce Tracer is globally disabled.

The **no shutdown** command globally enables MapReduce Tracer. The **shutdown** and **default shutdown** commands globally disable MapReduce Tracer by removing the corresponding **no shutdown** command from *running-config*.

Command Mode

Monitor-hadoop Configuration

Command Syntax

```
shutdown
```

```
no shutdown
```

```
default shutdown
```

Related Commands

- [monitor hadoop](#) places the switch in monitor-hadoop configuration mode.

Examples

- These commands globally enable MapReduce Tracer.

```
switch(config)#monitor hadoop
switch(config-monitor-hadoop)#no shutdown
switch(config-monitor-hadoop)#show active
monitor hadoop
no shutdown
switch(config-monitor-hadoop)#
```

- This command globally disables MapReduce Tracer.

```
switch(config-monitor-hadoop)#shutdown
switch(config-monitor-hadoop)#show active
switch(config-monitor-hadoop)#
```

19.7.4.33 tasktracker (Monitor Hadoop Cluster)

The **tasktracker** command specifies the HTTP port for accessing TaskTrackers of the Hadoop cluster monitored through configuration mode statements. The switch compiles a list of the cluster's TaskTracker addresses by periodically polling the cluster's JobTracker ([jobtracker \(Monitor Hadoop Cluster\)](#)). The default TaskTracker HTTP port is **50060**.

The **no tasktracker** and **default tasktracker** commands restore the configuration mode TaskTracker HTTP port to **50060** by removing the corresponding **tasktracker** command from **running-config**.

Command Mode

Monitor-hadoop-cluster Configuration

Command Syntax

```
tasktracker http-port port_number
```

```
no tasktracker http-port
```

```
default tasktracker http-port
```

Parameters

- **port_num** TaskTracker HTTP port number. Value ranges from **1** to **65535**. Default value is **50060**.

Related Commands

- [cluster \(Monitor Hadoop\)](#) places the switch in monitor-hadoop-cluster configuration mode.

Examples

- These commands specify a TaskTracker HTTP port address of **51000**.

```
switch(config)#monitor hadoop
switch(config-monitor-hadoop)#cluster CL2
switch(config-monitor-hadoop-CL2)#tasktracker http-port 51000
switch(config-monitor-hadoop-CL2)#show active
monitor hadoop
  cluster CL2
    tasktracker http-port 51000
switch(config-monitor-hadoop-CL2)#
```

- These commands restore the default TaskTracker HTTP port address of **50060**.

```
switch(config-monitor-hadoop-CL2)#no tasktracker http-port
switch(config-monitor-hadoop-CL2)#show active
monitor hadoop
  cluster CL2
switch(config-monitor-hadoop-CL2)#show active all
monitor hadoop
  cluster CL2
    jobtracker rpc-port 8021
    tasktracker http-port 50060
    interval 10
    shutdown
switch(config-monitor-hadoop-CL2)#
```